

Enabling the Next Generation of Automotive Head-Up Display Systems

ABSTRACT

Texas Instruments has developed automotive grade DLP® technology that enables highly-efficient, next-generation, full-color, true augmented reality (AR) automotive head-up display (HUD) systems. The uniqueness of DLP technology makes it possible to solve common design challenges of head-up display systems including managing environmental extremes and sunlight thermal loading, delivering high brightness and high resolution, and implementing dynamic dimming capabilities. Additionally, DLP projection-based architecture provides flexibility in the optical design needed to create very large field of view virtual displays over the road that augment and assist the driver. This paper includes a brief overview of DLP solid state illumination operation and how the implementation of DLP technology can solve the common HUD design challenges. DLP technology can be used to create advanced solutions for true automotive AR HUD applications.

Contents

1	Introduction	2
2	DLP® Electronics System Overview	2
3	High Dynamic Range LED Control System Concept	3
4	DLP HUD Optical System	5

List of Figures

1	Typical DLP Head-Up Display System Application.....	2
2	Continuous Mode Dimming.....	4
3	Discontinuous Mode Dimming	4
4	Measured White Light for TI Concept System	4
5	Measured White Point for TI Concept System.....	5
6	Measured White Point Over Dynamic Range	5
7	HUD Optical Design Concept	6
8	FFOV vs HUD Mirror Size	7
9	Resolution vs FOV.....	8

1 Introduction

Texas Instruments DLP® projection is a mature and widely used technology in numerous display applications including: hand-held projectors, conference rooms, and digital theaters. DLP technology is well suited to meet the needs of AR HUD systems. DLP electronics systems can enable video processing and formatting to meet needs for future HUD systems requiring both graphical and video images. The high-dynamic-range LED control system concept has been demonstrated to meet necessary conditions for day and night viewing. Additionally, optical design implementations based on DLP technology enable greater flexibility to solve optical design challenges, form factor constraints, and thermal load management of future automotive HUD systems.

2 DLP® Electronics System Overview

A concept system of DLP automotive HUD system is shown below. Video processing and formatting that utilizes the DLPC120-Q1 controller chip, which then synchronizes the Piccolo™ MCU (TMS320F28023) based LED color controller and driver. The DLP3030-Q1 then creates the final image from the formatted data provided from the controller the synchronized LED illumination. Figure 1 depicts a typical DLP HUD system application.

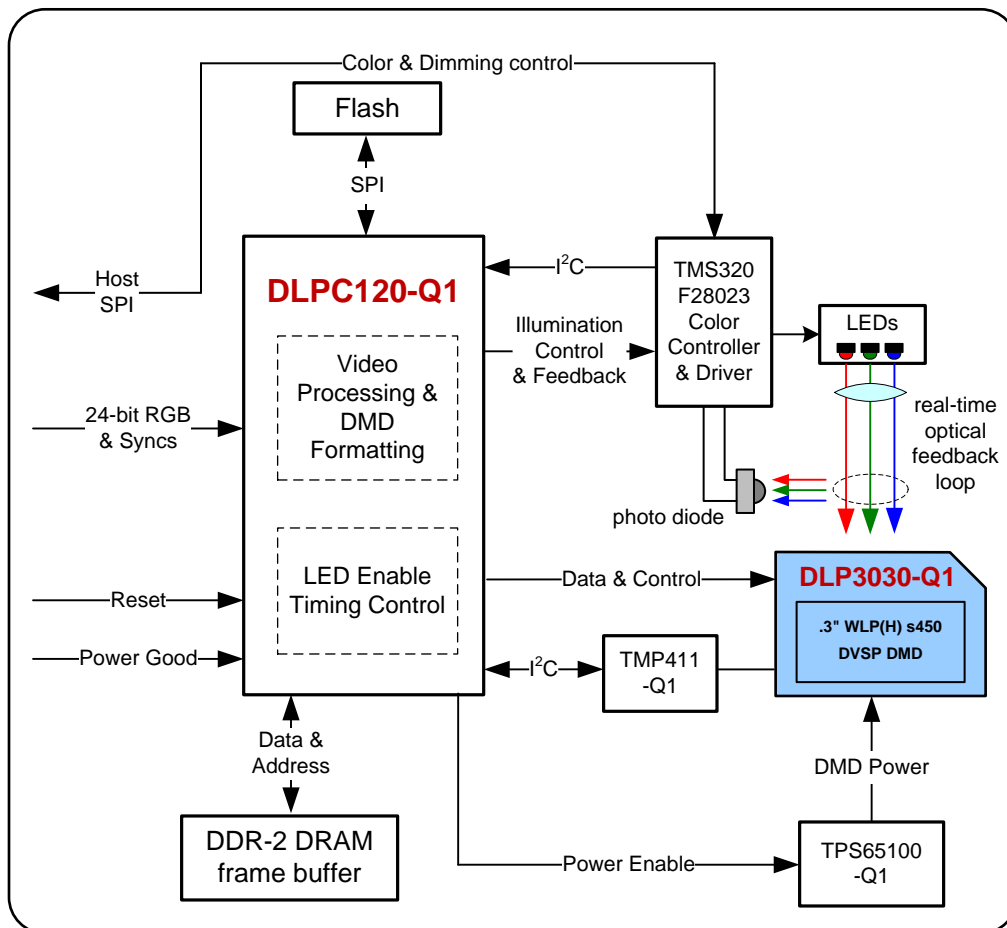

Copyright © 2017, Texas Instruments Incorporated

Figure 1. Typical DLP Head-Up Display System Application

The DLPC120-Q1 is responsible for receiving and processing video and commands received from an external display graphics processor. It is capable of receiving 24-bit parallel video data 60-Hz frame rate. The DLP controller has capability to scale the image to match the DMD aspect ratio, apply de-gamma correction, and perform bezel adjustment, and then format the data for the DMD PWM processing. The DLPC120-Q1 also provides strobe signals that enable red, green, and blue LEDs to synchronize to the data being displayed on the DMD device, resulting in a high-contrast image with high brightness, deeply saturated colors, and extremely fast display rates.

The Piccolo MCU-based LED control system is responsible for precise control of color and brightness across operating temperature and aging of the red, green, and blue LEDs. It also enables high dynamic brightness dimming, which is necessary for use under both bright sunlight and nighttime driving conditions in HUD applications.

The LED control system uses an optical flux feedback scheme based on a hysteretic PWM control method. The controller operates in two fundamental modes: continuous mode and discontinuous mode. In continuous mode, LED light is enabled for the entire output LED enable pulse time in a near DC fashion, continuously maintaining a fixed light level. In discontinuous mode, the magnitude of each pulse is controlled by the same hysteretic control loop, however, only triggered pulses of light are enabled. A specific number of pulses per LED are metered out by the DLP controller. DM enables the use of extremely low output flux levels without sacrificing precision of control.

Elevated LED temperature and LED aging will result in higher current levels to create the desired light flux levels. When the optical flux control loop reaches LED maximum current before reaching the desired optical flux level, the Piccolo MCU senses this condition and responds by proportionally reducing all three LED flux levels until all LEDs are back under optical flux feedback control. In this manner, the system seeks to produce the best picture possible as LEDs age and approach end-of-life brightness levels.

The LED control system receives brightness and dimming control commands from an up-stream control source via an SPI bus input. The Piccolo MCU interprets these commands, and modifies the RGB LED amplitude levels, continuous or discontinuous mode, and configures the DLP controller over a dedicated I²C bus.

The DLP electronics system is based on automotive-grade components that enable full capability necessary for HUD system operation. The electronics system includes video processing and an LED control system to enable high dynamic range dimming for day and nighttime driving conditions.

3 High Dynamic Range LED Control System Concept

The HUD application requires a very high dynamic range to support a brightness of over 15000 cd/m² during daytime operation, and also display an image at less than 3 cd/m² under very dark nighttime conditions. The HUD system must be capable of maintaining an image with full color depth at the desired white color point with a dynamic range of more than 5000:1. The LED driver control system developed specifically for the automotive HUD application has demonstrated this full range of capability.

The LED driver control system is implemented using the Piccolo MCU, which manages the LED amplitude modulation for red, green, and blue LEDs, maintains the proper white point, and synchronizes LED illumination with the DLP controller. The DLP controller provides high-speed data to the DMD and the associated RGB LED enable signals. Each of the devices selected for the LED driver control circuit can be based on TI Q1 components, designed to meet automotive standards.

DLP projection systems create full color depth images using pulse width modulation (PWM) of red, green, and blue light. The dimming function is integrated and synchronized within the standard PWM techniques used.

The system uses a hysteretic optical feedback based on the light output from the LEDs. For higher brightness levels, a continuous feedback mode is used to maintain steady state amplitude over the range of time within the bit segment. An example is shown in [Figure 2](#). Continuous mode feedback has been demonstrated to work at a dimming range of 100:1.

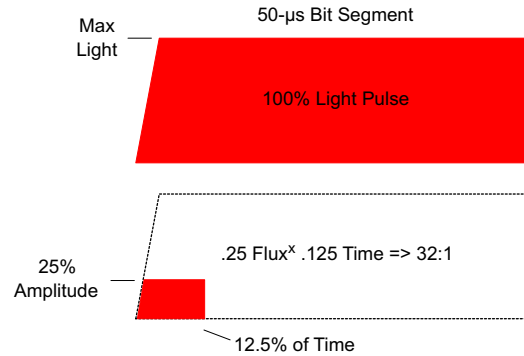

Figure 2. Continuous Mode Dimming

The system also employs a discontinuous mode feedback to generate very small pulses of light. This technique allows the dynamic range to be extended to well over 5000:1. An example, of discontinuous mode light pulse is shown in [Figure 3](#).

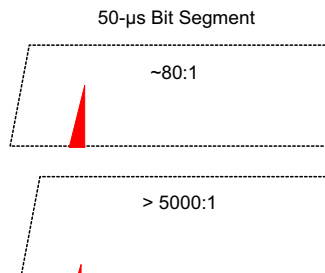

Figure 3. Discontinuous Mode Dimming

Implementing both the continuous and discontinuous modes of operation, the LED control system demonstrates a natural dimming range from 15000 cd/m² down to below 3 cd/m². [Figure 4](#) illustrates measured data from a TI concept system.

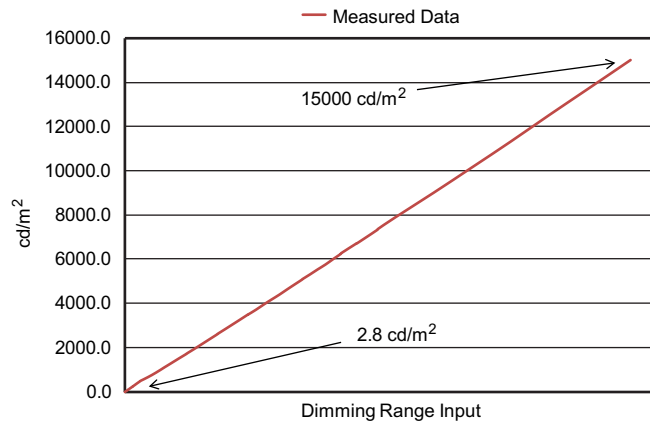

Figure 4. Measured White Light for TI Concept System

In addition to achieving a wide dynamic range, the white point must be maintained. For the implementation in the TI concept system, D65 was chosen for the targeted white point, which is a standard used in most High-Definition Televisions (HDTV). This white point has a target chromaticity value of $x = 0.313$ and $y = 0.329$. As shown in [Figure 5](#) and [Figure 6](#), the measured data across the dynamic range is tightly held near the targeted white point. The total amount of variation from the targeted chromaticity point is less than ± 0.01 .

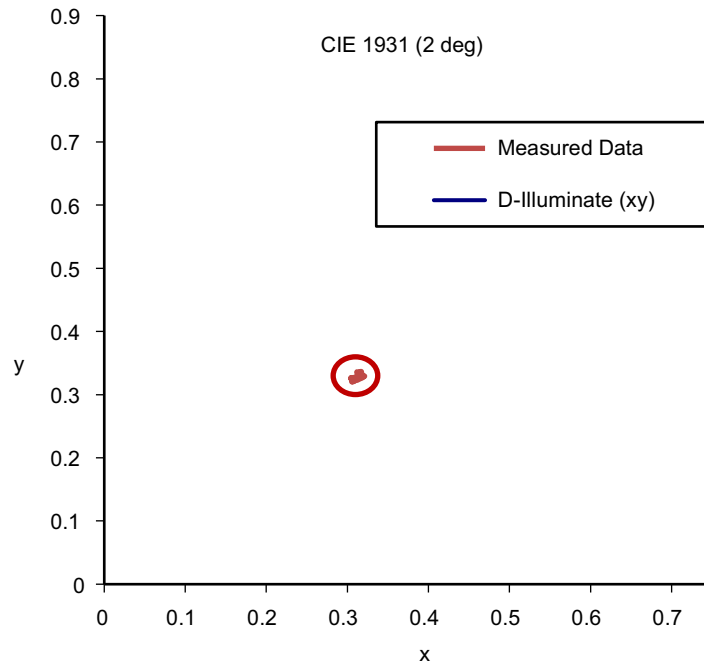

Figure 5. Measured White Point for TI Concept System

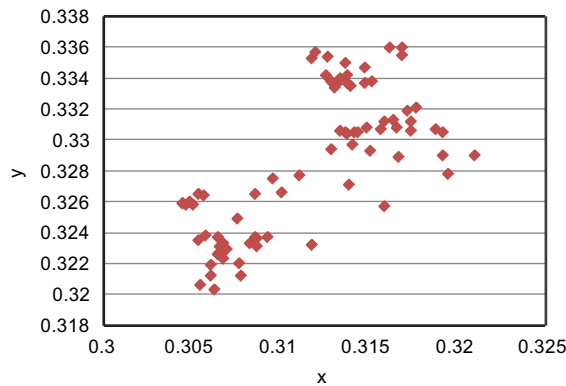

Figure 6. Measured White Point Over Dynamic Range

In summary, the LED driver control system implemented is based on automotive-grade components that have been demonstrated at a high dynamic range to meet day and nighttime viewing conditions, while maintaining accurate white point control.

4 DLP HUD Optical System

DLP automotive grade projection systems have characteristics that enable HUD systems with the Wide Field of View (WFOV) and long virtual image distances (VID) needed for next-generation augmented-reality displays. DLP has distinct advantages for design flexibility in the optics, mechanical volume management, and thermal management of sunlight.

The goal of a HUD optical system is to present the driver with a virtual display at a viewing distance that may vary from a few meters to far out over the road ahead. This virtual display may contain instrument cluster data such as speed, navigation data, or other real time information to assist the driver. The optics used to create this virtual display typically consist of one to three injection-molded aspheric mirrors depending on the level of optical correction required and the field of view (FOV) desired of the virtual image. An example of a HUD mirror optical design is shown in [Figure 7](#).

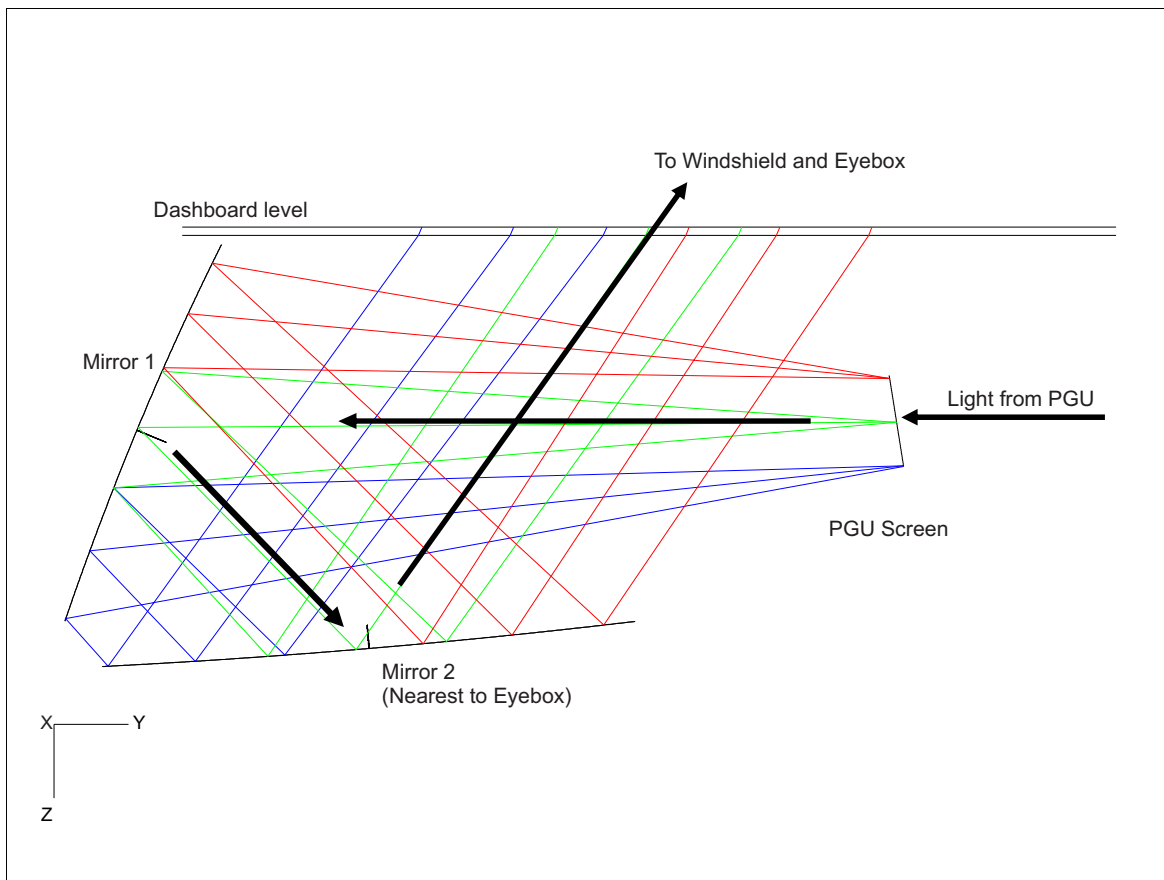

Figure 7. HUD Optical Design Concept

The image source for existing automotive HUDs is an LCD panel backlit by an LED array. There are significant limitations that may be difficult for LCD technology to address as the industry increasingly moves toward wide FOV HUDs. DLP projection technology offers a potential alternative HUD picture generation unit (PGU). The advantage of using DLP technology as an image source for a HUD becomes more significant as the HUD FOV increases. For very wide FOV; HUDs, such as those required for augmented reality displays, DLP may be the only reasonable solution to provide the required brightness and design flexibility for practical implementation into an automobile.

4.1 Optical Design Flexibility

DLP HUD systems use an intermediate image plane that can be optimized to allow the HUD mirror systems to mechanically fit into an automobile dash. The intermediate screen size is easily modified by adjusting the throw distance from projection lens and refocusing. The addition of extra distance between the intermediate image and the projection lens of the PGU can allow for a fold in the optical path which may improve the PGU mechanical layout compatibility with available under-dash volume.

HUD mirror optical designs are significantly constrained by various optical and mechanical requirements. The dominant constraints include FOV, image brightness, eyebox size and position, and mechanical envelope. The secondary optical constraints, such as image resolution, vergence, and distortion, are no less important, but only have a subtle affect on the optical prescription. Many of these desired constraints conflict with one another. An example of one of these conflicts is the mechanical compactness of the optical design versus the width of the FOV. The size of mirror closest to eyebox, as shown in [Figure 7](#) (Mirror 2), is completely determined by the size of the FOV, eyebox location relative to the last mirror surface, and the eyebox size. [Figure 8](#) shows an estimate of the size of the final HUD mirror, versus the full field of view. The dimensions shown in [Figure 8](#) would refer to the size of Mirror 2 in the HUD optical concept of [Figure 7](#).

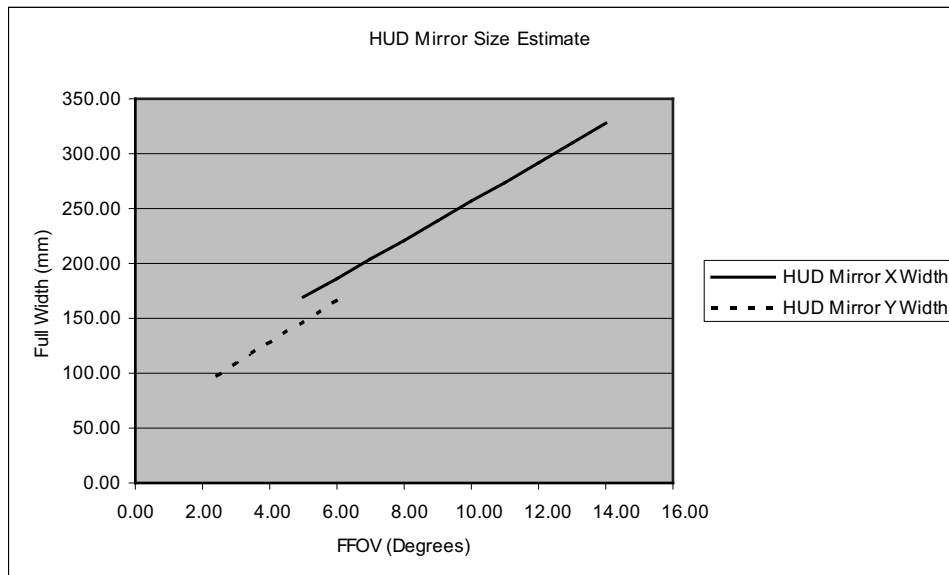

Figure 8. FFOV vs HUD Mirror Size

The remaining mirror dimensions and mechanical folding arrangement are significantly influenced by the size of the intermediate image screen for the HUD mirror optics. Allowing the intermediate image screen size to vary as a design constraint, adds the necessary flexibility to enable very wide FOV systems to be optimally folded into a small enough volume to fit into a dashboard. For example, a larger intermediate image or screen size will require a longer back working distance in the HUD mirror optics. This additional space between the mirrors and the screen may allow for a fold in the optical path which may be a benefit for both mechanical packaging and optical performance.

In the DLP HUD concept, a PGU creates a small magnified bright image of the DMD at an intermediate image screen. This projected screen image is then magnified by the HUD mirror optics to create a virtual display for the driver. The designer of the HUD mirror optics is not constrained by a fixed image size or image magnification as in LCD-based systems. The flexibility of choosing the best magnification or focal length can be of significant benefit to the designer for the reduction of optical aberration, and minimization of the size of the secondary and tertiary mirrors of the HUD design.

For a very wide field of view display, such as 15° or higher, an increase in the number of pixels is necessary to maintain eye-limited image resolution. A plot of the minimum resolvable resolution per FOV is shown in [Figure 9](#). DLP-based systems can easily achieve over 1000 pixels enabling over 15° wide FOV. Additionally, the size of the intermediate image is independent of the number of pixels, enabling the design flexibility described in this section.

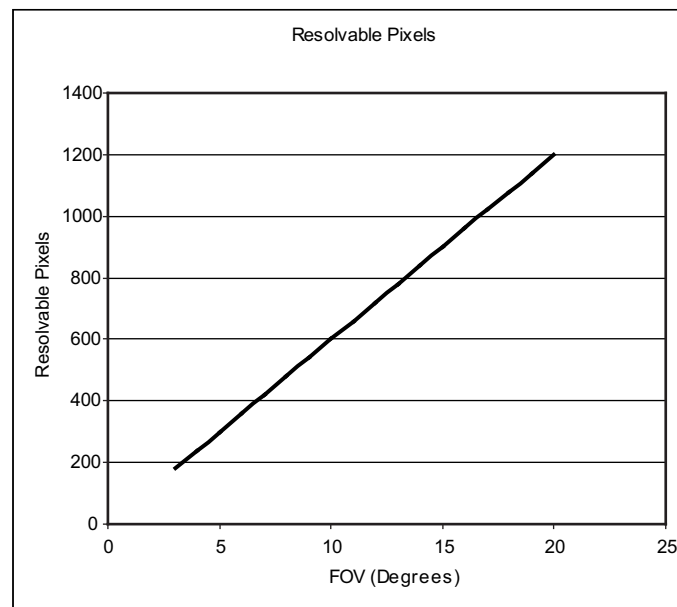

Figure 9. Resolution vs FOV

4.2 Thermal Load Considerations

The DLP PGU system is inherently robust in managing thermal loads. The DLP-based PGU has 3 individual RGB LED light sources that can be cooled independently in a remote location away from the intermediate screen and associated sunlight back reflections. The DMD itself is separated from the LEDs allowing the DMD to be independently thermally managed. This is a significant advantage for DLP-based HUD engines since the image generation device (DMD) is thermally isolated from both the HUD intermediate image screen and the source of light generation (LEDs).

Another source of heating in HUD systems is the radiation hitting the image generation device that comes directly from the sun. Sunlight can enter the HUD mirror optics and focus down onto the imager location creating significant localized heating. For today's LCD based systems, a cold mirror is typically used to help reduce the total amount of solar energy incident on the imager. If not managed properly, this focused solar energy on the imager may be a problem for LCD panels, potentially degrading the performance of the LCD imager. In contrast, the intermediate screen of the DLP-based PGU effectively decouples solar radiation from the imager and electronics. Very little solar radiation will be captured and sent back to the DMD due to the diffusing screen. The diffusing screen at the intermediate image is a passive optical element that can be designed to withstand a high level of solar radiation without loss of performance.

The DMD performance is very robust under extreme hot and cold thermal conditions. For example, the DMD switching speed, color, or contrast is not affected over the full operating temperature range of the DMD (–40°C to 105°C).

For HUD systems with large FOV, DLP technology offers clear and unique advantages in performance, thermal management, and optical design flexibility. The ability to create a HUD display source of any size using a DLP-based PGU offers the optical designer additional degrees of freedom to create a HUD optical design that both performs well and fits within the dashboard. Additionally, the isolation of the heat sources make the DMD PGU based HUD system more robust in environmentally challenged conditions. Wide FOV and augmented-reality HUD systems could benefit from the advantages offered by DLP projection.

IMPORTANT NOTICE FOR TI DESIGN INFORMATION AND RESOURCES

Texas Instruments Incorporated ("TI") technical, application or other design advice, services or information, including, but not limited to, reference designs and materials relating to evaluation modules, (collectively, "TI Resources") are intended to assist designers who are developing applications that incorporate TI products; by downloading, accessing or using any particular TI Resource in any way, you (individually or, if you are acting on behalf of a company, your company) agree to use it solely for this purpose and subject to the terms of this Notice.

TI's provision of TI Resources does not expand or otherwise alter TI's applicable published warranties or warranty disclaimers for TI products, and no additional obligations or liabilities arise from TI providing such TI Resources. TI reserves the right to make corrections, enhancements, improvements and other changes to its TI Resources.

You understand and agree that you remain responsible for using your independent analysis, evaluation and judgment in designing your applications and that you have full and exclusive responsibility to assure the safety of your applications and compliance of your applications (and of all TI products used in or for your applications) with all applicable regulations, laws and other applicable requirements. You represent that, with respect to your applications, you have all the necessary expertise to create and implement safeguards that (1) anticipate dangerous consequences of failures, (2) monitor failures and their consequences, and (3) lessen the likelihood of failures that might cause harm and take appropriate actions. You agree that prior to using or distributing any applications that include TI products, you will thoroughly test such applications and the functionality of such TI products as used in such applications. TI has not conducted any testing other than that specifically described in the published documentation for a particular TI Resource.

You are authorized to use, copy and modify any individual TI Resource only in connection with the development of applications that include the TI product(s) identified in such TI Resource. NO OTHER LICENSE, EXPRESS OR IMPLIED, BY ESTOPPEL OR OTHERWISE TO ANY OTHER TI INTELLECTUAL PROPERTY RIGHT, AND NO LICENSE TO ANY TECHNOLOGY OR INTELLECTUAL PROPERTY RIGHT OF TI OR ANY THIRD PARTY IS GRANTED HEREIN, including but not limited to any patent right, copyright, mask work right, or other intellectual property right relating to any combination, machine, or process in which TI products or services are used. Information regarding or referencing third-party products or services does not constitute a license to use such products or services, or a warranty or endorsement thereof. Use of TI Resources may require a license from a third party under the patents or other intellectual property of the third party, or a license from TI under the patents or other intellectual property of TI.

TI RESOURCES ARE PROVIDED "AS IS" AND WITH ALL FAULTS. TI DISCLAIMS ALL OTHER WARRANTIES OR REPRESENTATIONS, EXPRESS OR IMPLIED, REGARDING TI RESOURCES OR USE THEREOF, INCLUDING BUT NOT LIMITED TO ACCURACY OR COMPLETENESS, TITLE, ANY EPIDEMIC FAILURE WARRANTY AND ANY IMPLIED WARRANTIES OF MERCHANTABILITY, FITNESS FOR A PARTICULAR PURPOSE, AND NON-INFRINGEMENT OF ANY THIRD PARTY INTELLECTUAL PROPERTY RIGHTS.

TI SHALL NOT BE LIABLE FOR AND SHALL NOT DEFEND OR INDEMNIFY YOU AGAINST ANY CLAIM, INCLUDING BUT NOT LIMITED TO ANY INFRINGEMENT CLAIM THAT RELATES TO OR IS BASED ON ANY COMBINATION OF PRODUCTS EVEN IF DESCRIBED IN TI RESOURCES OR OTHERWISE. IN NO EVENT SHALL TI BE LIABLE FOR ANY ACTUAL, DIRECT, SPECIAL, COLLATERAL, INDIRECT, PUNITIVE, INCIDENTAL, CONSEQUENTIAL OR EXEMPLARY DAMAGES IN CONNECTION WITH OR ARISING OUT OF TI RESOURCES OR USE THEREOF, AND REGARDLESS OF WHETHER TI HAS BEEN ADVISED OF THE POSSIBILITY OF SUCH DAMAGES.

You agree to fully indemnify TI and its representatives against any damages, costs, losses, and/or liabilities arising out of your non-compliance with the terms and provisions of this Notice.

This Notice applies to TI Resources. Additional terms apply to the use and purchase of certain types of materials, TI products and services. These include; without limitation, TI's standard terms for semiconductor products (<http://www.ti.com/sc/docs/stdterms.htm>), [evaluation modules](#), and [samples](http://www.ti.com/sc/docs/sampterm.htm) (<http://www.ti.com/sc/docs/sampterm.htm>).

Mailing Address: Texas Instruments, Post Office Box 655303, Dallas, Texas 75265
Copyright © 2017, Texas Instruments Incorporated