

TPS62850x-Q1 2.7V to 6V, 1A, 2A, 3A, Automotive, Step-Down Converters in an SOT583 Package

1 Features

- AEC-Q100 qualified for automotive applications
 - Device temperature grade 1: -40°C to $+125^{\circ}\text{C}$ T_A
- **Functional Safety-Capable**
 - [Documentation available to aid functional safety system design](#)
- Optimized for low EMI requirements
 - Optional pseudo-random spread spectrum reduces peak emissions
- $T_J = -40^{\circ}\text{C}$ to $+150^{\circ}\text{C}$
- Family of 1A and 2A (continuous) and 3A (peak) converters
- Input voltage range: 2.7V to 6V
- Quiescent current: 17 μA typical
- Output voltage from 0.6V to 5.5V
- Output voltage accuracy $\pm 1\%$ (PWM operation)
- Forced PWM or PWM/PFM operation
- Adjustable switching frequency: 1.8MHz to 4MHz
- Precise ENABLE input allows:
 - User-defined undervoltage lockout
 - Exact sequencing
- 100% duty cycle mode
- Active output discharge
- Foldback overcurrent protection – optional
- Power-good output with window comparator

2 Applications

- [ADAS camera, ADAS sensor fusion](#)
- [Surround view ECU](#)
- [Hybrid and reconfigurable cluster](#)
- [Head unit, telematics control unit](#)
- [External amplifier](#)

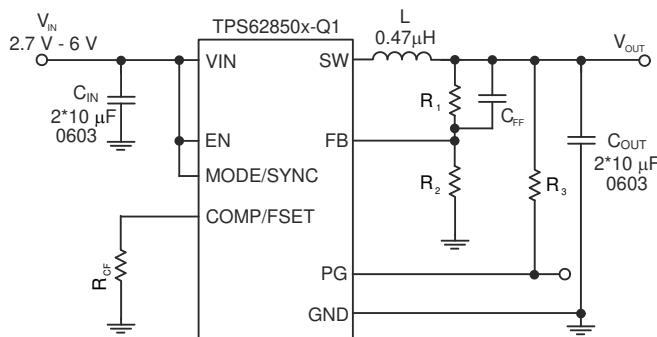

Simplified Schematic

3 Description

The TPS62850x-Q1 is a family of pin-to-pin 1A, 2A (continuous), and 3A (peak) high efficiency, easy-to-use synchronous step-down DC/DC converters. These devices are based on a peak current mode control topology. These devices are designed for automotive applications such as infotainment and advanced driver assistance systems. Low resistive switches allow up to 2A continuous output current and 3A peak current. In the TPS62850x-Q1, the switching frequency is externally adjustable from 1.8MHz to 4MHz. The devices can also be synchronized to an external clock in the same frequency range. In PWM/PFM mode, the devices automatically enter power save mode at light loads to maintain high efficiency across the whole load range. The family provides a 1% output voltage accuracy in PWM mode which helps design a power supply with high output voltage accuracy.

The TPS62850x-Q1 are available in an SOT583 package.

Device Information

PART NUMBER ⁽²⁾	PACKAGE ⁽¹⁾	BODY SIZE (NOM)
TPS628501Q1	DRL (SOT583, 8)	2.10mm × 1.60mm (incl pins)
TPS628502Q1		
TPS628503Q1		
TPS628501Q1	DYC (SOT583, 8)	2.10mm × 1.60mm (incl pins)

(1) For more information, see [Section 12](#).

(2) See the [Device Comparison Table](#).

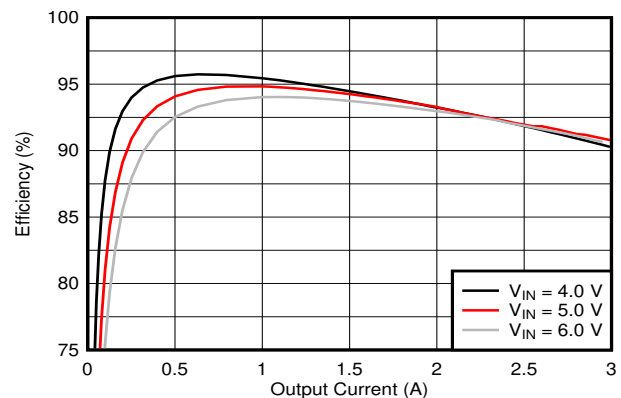

Efficiency vs I_{OUT} , $V_{OUT} = 3.3\text{V}$



Table of Contents

1 Features	1	8.4 Device Functional Modes.....	14
2 Applications	1	9 Application and Implementation	16
3 Description	1	9.1 Application Information.....	16
4 Device Comparison Table	3	9.2 Typical Application.....	18
5 Pin Configuration and Functions	4	9.3 System Examples.....	28
6 Specifications	5	9.4 Power Supply Recommendations.....	29
6.1 Absolute Maximum Ratings.....	5	9.5 Layout.....	29
6.2 ESD Ratings.....	5	10 Device and Documentation Support	31
6.3 Recommended Operating Conditions.....	5	10.1 Device Support.....	31
6.4 Thermal Information.....	6	10.2 Documentation Support.....	31
6.5 Electrical Characteristics.....	6	10.3 Receiving Notification of Documentation Updates..	31
6.6 Typical Characteristics.....	9	10.4 Support Resources.....	31
7 Parameter Measurement Information	10	10.5 Trademarks.....	31
7.1 Schematic.....	10	10.6 Electrostatic Discharge Caution.....	31
8 Detailed Description	11	10.7 Glossary.....	31
8.1 Overview.....	11	11 Revision History	32
8.2 Functional Block Diagram.....	11	12 Mechanical, Packaging, and Orderable Information	33
8.3 Feature Description.....	12		

4 Device Comparison Table

DEVICE NUMBER	OUTPUT CURRENT	V _{OUT} DISCHARGE	FOLDBACK CURRENT LIMIT	TYPICAL OUTPUT CAPACITOR	SOFT START	OUTPUT VOLTAGE	PACKAGE TYPE
TPS628501QDRLRQ1	1A	ON	OFF	2 × 10µF	Internal 1ms	Adjustable	DRL
TPS6285010MQDYCRQ1	1A	ON	OFF	2 × 10µF	Internal 1ms	Fixed 1.8V	DYC
TPS62850140QDYCRQ1	1A	ON	ON	2 × 10µF	Internal 1ms	Adjustable	DYC
TPS6285018AQDRLRQ1	1A	ON	OFF	10µF	Internal 1ms	Fixed 1.2V	DRL
TPS6285011HQDRLRQ1	1A	ON	OFF	2 × 10µF	Internal 1ms	Fixed 3.3V	DRL
TPS6285010MQDRLRQ1	1A	ON	OFF	2 × 10µF	Internal 1ms	Fixed 1.8V	DRL
TPS628501B0QDRLRQ1	1A	ON	OFF	2 × 10µF	Internal 150µs	Adjustable	DRL
TPS62850120QDRLRQ1	1A	OFF	OFF	2 × 10µF	Internal 1ms	Adjustable	DRL
TPS628501F0QDRLRQ1	1A	Disconnected	OFF	2 × 10µF	Internal 1ms	Adjustable	DRL
TPS628501H9QDRLRQ1	1A	Disconnected	ON	2 × 10µF	Internal 150µs	Fixed 1.15V	DRL
TPS628502QDRLRQ1	2A	ON	OFF	2 × 10µF	Internal 1ms	Adjustable	DRL
TPS62850208QDRLRQ1	2A	ON	OFF	2 × 10 µF	Internal 1 ms	Fixed 1.1V	DRL
TPS62850240QDYCRQ1	2A	ON	ON	2 × 10µF	Internal 1ms	Adjustable	DYC
TPS62850220QDRLRQ1	2A	OFF	OFF	2 × 10µF	Internal 1ms	Adjustable	DRL
TPS628502F0QDRLRQ1	2A	Disconnected	OFF	2 × 10µF	Internal 1ms	Adjustable	DRL
TPS62850240QDRLRQ1	2A	ON	ON	2 × 10µF	Internal 1ms	Adjustable	DRL
TPS6285020MQDRLRQ1	2A	ON	OFF	2 × 10µF	Internal 1ms	Fixed 1.8V	DRL
TPS6285021HQDRLRQ1	2A	ON	OFF	2 × 10µF	Internal 1ms	Fixed 3.3V	DRL
TPS6285020AQDRLRQ1	2A	ON	OFF	2 × 10µF	Internal 1ms	Fixed 1.2V	DRL
TPS628503QDRLRQ1	3A	ON	OFF	2 × 10µF	Internal 1ms	Adjustable	DRL

5 Pin Configuration and Functions

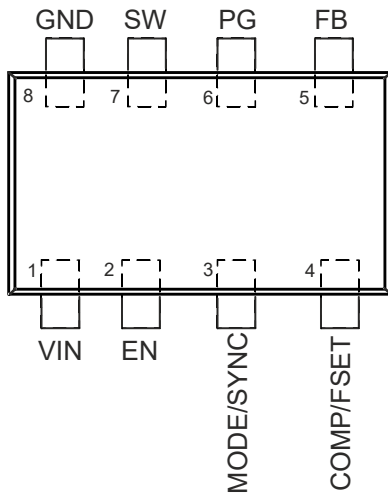

Figure 5-1. 8-Pin SOT583 DRL Package for TPS62850x-Q1 (Top View)

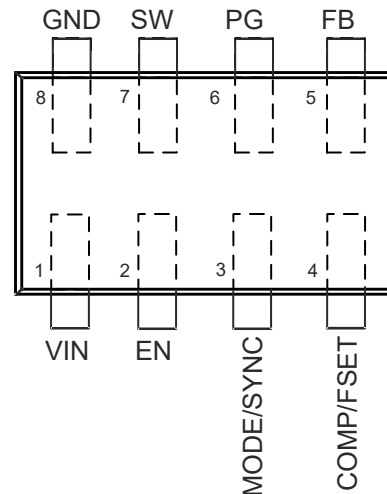

Figure 5-2. 8-Pin SOT583 DYC Package for TPS62850x-Q1 (Top View)

Table 5-1. Pin Functions

PIN		TYPE ⁽¹⁾	DESCRIPTION
NAME	NO.		
EN	2	I	This is the enable pin of the device. Connect to logic low to disable the device. Pull high to enable the device. Do not leave this pin unconnected.
FB	5	I	Voltage feedback input. Connect the resistive output voltage divider to this pin.
GND	8		Ground pin
MODE/SYNC	3	I	The device runs in PFM/PWM mode when this pin is pulled low. When the pin is pulled high, the device runs in forced PWM mode. Do not leave this pin unconnected. The mode pin can also be used to synchronize the device to an external frequency. See Section 6.5 for the detailed specification for the digital signal applied to this pin for external synchronization.
COMP/FSET	4	I	Device compensation and frequency set input. A resistor from this pin to GND defines the compensation of the control loop as well as the switching frequency if not externally synchronized.
PG	6	O	Open-drain power-good output
SW	7	—	This pin is the switch pin of the converter and is connected to the internal power MOSFETs.
VIN	1	—	Power supply input. Make sure the input capacitor is connected as close as possible between the VIN and GND pins.

(1) I = input, O = output

6 Specifications

6.1 Absolute Maximum Ratings

over operating temperature range (unless otherwise noted)⁽¹⁾

		MIN	MAX	UNIT
Pin voltage ⁽²⁾	VIN	-0.3	6.5	V
Pin voltage ⁽²⁾	SW (DC)	-0.3	V _{IN} + 0.3	V
Pin voltage ⁽²⁾	SW (AC, less than 10ns) ⁽³⁾	-3	10	V
Pin voltage ⁽²⁾	COMP/FSET, PG	-0.3	V _{IN} + 0.3	V
Pin voltage ⁽²⁾	EN, MODE/SYNC, FB	-0.3	6.5	V
T _{stg}	Storage temperature	-65	150	°C

- (1) Stresses beyond those listed under *Absolute Maximum Rating* may cause permanent damage to the device. These are stress ratings only, which do not imply functional operation of the device at these or any other conditions beyond those indicated under *Recommended Operating Condition*. Exposure to absolute-maximum-rated conditions for extended periods may affect device reliability.
- (2) All voltage values are with respect to the network ground terminal
- (3) While switching

6.2 ESD Ratings

			VALUE	UNIT
V _(ESD)	Electrostatic discharge	Human body model (HBM), per AEC Q100-002 ⁽¹⁾	±2000	V
		Charged device model (CDM), per AEC Q100-011	±750	

- (1) AEC Q100-002 indicates that HBM stressing must be in accordance with the ANSI/ESDA/JEDEC JS-001 specification.

6.3 Recommended Operating Conditions

Over operating temperature range (unless otherwise noted)

		MIN	NOM	MAX	UNIT
V _{IN}	Input voltage range	2.7		6	V
V _{OUT}	Output voltage range	0.6		5.5	V
L	Effective inductance	0.32	0.47	1.2	μH
C _{OUT}	Effective output capacitance ⁽¹⁾	8	10	200	μF
C _{IN}	Effective input capacitance ⁽¹⁾		10		μF
R _{CF}		4.5		100	kΩ
I _{SINK_PG}	Sink current at PG pin	0		2	mA
I _{OUT}	Output current, TPS628501	0		1	A
I _{OUT}	Output current, TPS628502	0		2	A
I _{OUT}	Output current, TPS628503 ⁽²⁾	0		3	A
T _J	Junction temperature	-40		150	°C

- (1) The values given for all the capacitors in the table are effective capacitance, which includes the DC bias effect. Due to the DC bias effect of ceramic capacitors, the effective capacitance is lower than the nominal value when a voltage is applied. Please check the manufacturer's DC bias curves for the effective capacitance vs DC voltage applied. Further restrictions may apply. Please see the feature description for COMP/FSET about the output capacitance vs compensation setting and output voltage.
- (2) This part is designed for a 2A continuous output current at a junction temperature of 125°C or 3A at a junction temperature of 85°C; exceeding the output current or the junction temperature can significantly reduce lifetime.

6.4 Thermal Information

THERMAL METRIC ⁽¹⁾		TPS62850x-Q1	TPS62850x-Q1	UNIT
		DRL (JEDEC) ⁽²⁾	DRL (EVM)	
		8 PINS	8 PINS	
R _{θJA}	Junction-to-ambient thermal resistance	110	60	°C/W
R _{θJC(top)}	Junction-to-case (top) thermal resistance	41.3	n/a	°C/W
R _{θJB}	Junction-to-board thermal resistance	20	n/a	°C/W
Ψ _{JT}	Junction-to-top characterization parameter	0.8	n/a	°C/W
Y _{JB}	Junction-to-board characterization parameter	20	n/a	°C/W
R _{θJC(bot)}	Junction-to-case (bottom) thermal resistance	n/a	n/a	°C/W

- (1) For more information about traditional and new thermal metrics, see the [Semiconductor and IC Package Thermal Metrics](#) application report.
 (2) JEDEC standard PCB with 4 layers, no thermal vias

6.5 Electrical Characteristics

Over operating junction temperature range (T_J = -40°C to +150°C) and V_{IN} = 2.7V to 6V. Typical values at V_{IN} = 5V and T_J = 25°C. (unless otherwise noted)

PARAMETER		TEST CONDITIONS	MIN	TYP	MAX	UNIT
SUPPLY						
I _Q	Quiescent current	EN = V _{IN} , no load, device not switching, MODE = GND, V _{OUT} = 0.6V		17	36	μA
I _{SD}	Shutdown current	EN = GND, Nominal value at T _J = 25°C, Max value at T _J = 150°C		1.5	48	μA
V _{UVLO}	Undervoltage lock out threshold	V _{IN} rising	2.45	2.6	2.7	V
		V _{IN} falling	2.1	2.5	2.6	V
T _{JSD}	Thermal shutdown threshold	T _J rising		170		°C
	Thermal shutdown hysteresis	T _J falling		15		°C
CONTROL and INTERFACE						
V _{EN,IH}	Input threshold voltage at EN, rising edge		1.05	1.1	1.15	V
V _{EN,IL}	Input threshold voltage at EN, falling edge		0.96	1.0	1.05	V
V _{IH}	High-level input-threshold voltage at MODE/SYNC		1.1			V
I _{EN,LKG}	Input leakage current into EN	V _{IH} = V _{IN} or V _{IL} = GND			125	nA
V _{IL}	Low-level input-threshold voltage at MODE/SYNC				0.3	V
I _{LKG}	Input leakage current into MODE/SYNC				100	nA
t _{Delay}	Enable delay time	Time from EN high to device starts switching; V _{IN} applied already	135	200	520	μs
t _{Delay}	Enable delay time	Time from EN high to device starts switching; V _{IN} applied already, V _{IN} ≥ 3.3V			480	μs
t _{Ramp}	Output voltage ramp time	Time from device starts switching to power good; device not in current limit	0.8	1.3	1.8	ms
t _{Ramp}	Output voltage ramp time	Time from device starts switching to power good; device not in current limit for TPS628501B0QDRLRQ1 and TPS628501H9QDRLRQ1	90	150	210	μs
f _{SYNC}	Frequency range on MODE/SYNC pin for synchronization		1.8		4	MHz
	Duty cycle of synchronization signal at MODE/SYNC		20		80	%

6.5 Electrical Characteristics (continued)

Over operating junction temperature range ($T_J = -40^\circ\text{C}$ to $+150^\circ\text{C}$) and $V_{IN} = 2.7\text{V}$ to 6V . Typical values at $V_{IN} = 5\text{V}$ and $T_J = 25^\circ\text{C}$. (unless otherwise noted)

PARAMETER		TEST CONDITIONS	MIN	TYP	MAX	UNIT
	Time to lock to external frequency			50		μs
	resistance from COMP/FSET to GND for logic low	internal frequency setting with $f = 2.25\text{MHz}$	0		2.5	$\text{k}\Omega$
	Voltage on COMP/FSET for logic high	internal frequency setting with $f = 2.25\text{MHz}$		V_{IN}		V
V_{TH_PG}	UVP power good threshold voltage; DC level	rising ($\%V_{FB}$)	92	95	98	%
V_{TH_PG}	UVP power good threshold voltage; DC level	falling ($\%V_{FB}$)	87	90	93	%
V_{TH_PG}	OVP power good threshold voltage; DC level	rising ($\%V_{FB}$)	107	110	113	%
		falling ($\%V_{FB}$)	104	107	111	%
V_{PG_OL}	Low-level output voltage at PG	$I_{SINK_PG} = 2\text{mA}$		0.07	0.3	V
I_{PG_LKG}	Input leakage current into PG	$V_{PG} = 5\text{V}$			100	nA
t_{PG}	PG deglitch time	for a high level to low level transition on the power good output		40		μs
OUTPUT						
V_{FB}	Feedback voltage, adjustable version			0.6		V
V_{FB}	Feedback voltage, fixed voltage versions	for TPS62850108		1.1		V
V_{FB}	Feedback voltage, fixed voltage versions	for TPS6285018A		1.2		V
V_{FB}	Feedback voltage, fixed voltage versions	for TPS6285010M, TPS6285020M		1.8		V
V_{FB}	Feedback voltage, fixed voltage versions	for TPS6285021H		3.3		V
I_{FB_LKG}	Input leakage current into FB, adjustable version	$V_{FB} = 0.6\text{V}$		1	70	nA
I_{FB_LKG}	Input leakage current into FB, fixed voltage versions			1		μA
V_{FB}	Feedback voltage accuracy	PWM, $V_{IN} \geq V_{OUT} + 1\text{V}$	-1		1	%
V_{FB}	Feedback voltage accuracy	PFM, $V_{IN} \geq V_{OUT} + 1\text{V}$, $V_{OUT} \geq 1.0\text{V}$, $C_{o,eff} \geq 10\mu\text{F}$, $L = 0.47\mu\text{H}$	-1		2	%
V_{FB}	Feedback voltage accuracy	PFM, $V_{IN} \geq V_{OUT} + 1\text{V}$, $V_{OUT} < 1.0\text{V}$, $C_{o,eff} \geq 15\mu\text{F}$, $L = 0.47\mu\text{H}$	-1		3	%
	Load regulation	PWM		0.05		%/A
	Line regulation	PWM, $I_{OUT} = 1\text{A}$, $V_{IN} \geq V_{OUT} + 1\text{V}$		0.02		%/V
R_{DIS}	Output discharge resistance				100	Ω
f_{SW}	PWM Switching frequency range	MODE = high, see the FSET pin functionality about setting the switching frequency	1.8	2.25	4	MHz
f_{SW}	PWM Switching frequency range	MODE = low, see the FSET pin functionality about setting the switching frequency	1.8		3.5	MHz
f_{SW}	PWM Switching frequency	with COMP/FSET tied to GND or V_{IN}	2.025	2.25	2.475	MHz
f_{SW}	PWM Switching frequency tolerance	using a resistor from COMP/FSET to GND	-12		12	%
$t_{on,min}$	Minimum on-time of high-side FET	$V_{IN} \geq 3.3\text{V}$, $T_J = -40^\circ\text{C}$ to 125°C		35	50	ns
$t_{on,min}$	Minimum on-time of low-side FET			10		ns

6.5 Electrical Characteristics (continued)

Over operating junction temperature range ($T_J = -40^{\circ}\text{C}$ to $+150^{\circ}\text{C}$) and $V_{IN} = 2.7\text{V}$ to 6V . Typical values at $V_{IN} = 5\text{V}$ and $T_J = 25^{\circ}\text{C}$. (unless otherwise noted)

PARAMETER		TEST CONDITIONS	MIN	TYP	MAX	UNIT
$R_{DS(ON)}$	High-side FET on-resistance	$V_{IN} \geq 5\text{V}$		65	120	m Ω
	Low-side FET on-resistance	$V_{IN} \geq 5\text{V}$		33	70	m Ω
	High-side MOSFET leakage current	$T_J = 85^{\circ}\text{C}$		2.5		μA
	High-side MOSFET leakage current			0.01	44	μA
	Low-side MOSFET leakage current	$T_J = 85^{\circ}\text{C}$		3.7		μA
	Low-side MOSFET leakage current			0.01	70	μA
	SW leakage	$V(\text{SW}) = 0.6\text{V}$, current into SW pin	-0.05		11	μA
I_{LIMH}	High-side FET switch current limit	DC value, for TPS628503; $V_{IN} = 3.3\text{V}$ to 6	3.45	4.5	5.1	A
I_{LIMH}	High-side FET switch current limit	DC value, for TPS628502; $V_{IN} = 3\text{V}$ to 6V	2.85	3.4	3.9	A
I_{LIMH}	High-side FET switch current limit	DC value, for TPS628501; $V_{IN} = 3\text{V}$ to 6V	2.1	2.6	3.0	A
I_{LIMNEG}	Low-side FET negative current limit	DC value		-1.8		A

6.6 Typical Characteristics

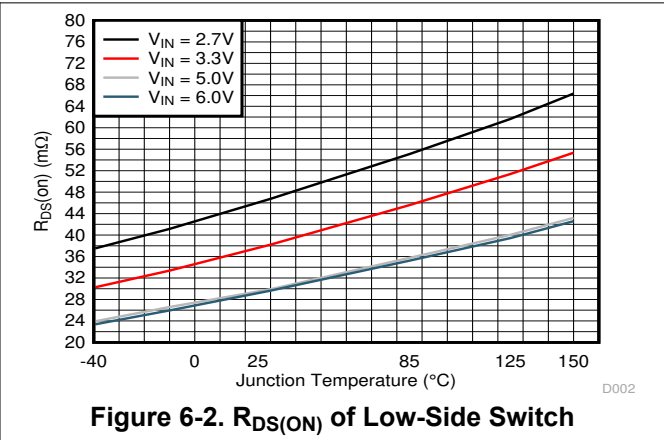
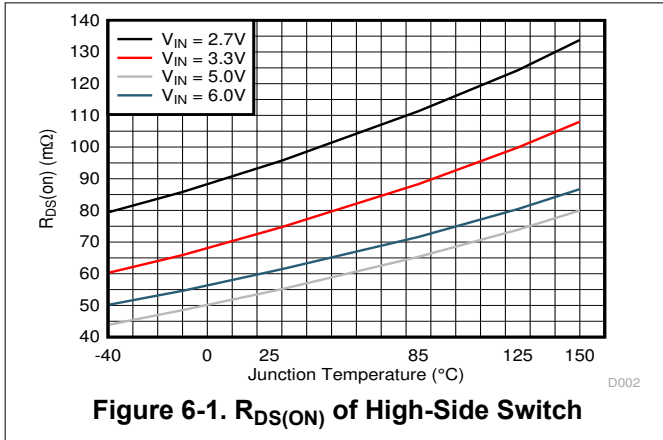

7 Parameter Measurement Information

7.1 Schematic

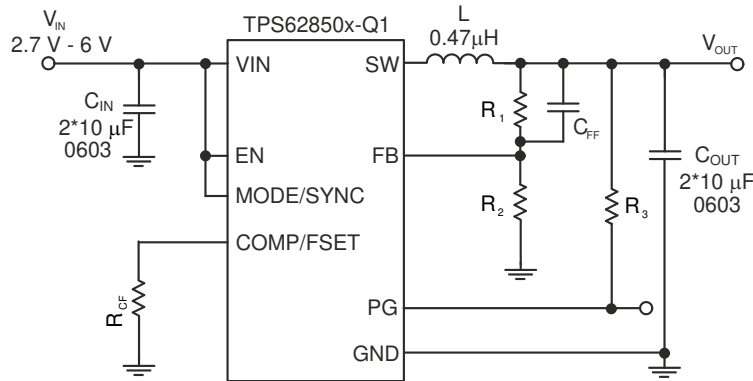

Figure 7-1. Measurement Setup (TPS62850x-Q1)

Table 7-1. List of Components

REFERENCE	DESCRIPTION	MANUFACTURER ⁽¹⁾
IC	TPS628502QDRLRQ1	Texas Instruments
L	0.47µH inductor DFE252012PD	Murata
C _{IN}	2 × 10µF / 6.3V GCM188D70J106M	Murata
C _{OUT}	2 × 10µF / 6.3V GCM188D70J106M for Vout ≥ 1V	Murata
C _{OUT}	3 × 10µF / 6.3V GCM188D70J106M for Vout < 1V	Murata
R _{CF}	8,06kΩ	Any
C _{FF}	10pF	Any
R ₁	Depending on VOUT	Any
R ₂	Depending on VOUT	Any
R ₃	100kΩ	Any

(1) See the [Third-party Products Disclaimer](#).

8 Detailed Description

8.1 Overview

The TPS62850x-Q1 synchronous switch mode power converters are based on a peak current mode control topology. The control loop is internally compensated.

To optimize the bandwidth of the control loop to the wide range of output capacitance that can be used with the TPS62850x-Q1, the internal compensation has two settings. See [Section 8.3.2](#). One out of the two compensation settings is chosen either by a resistor from COMP/FSET to GND, or by the logic state of this pin. The regulation network achieves fast and stable operation with small external components and low-ESR ceramic output capacitors. The devices can be operated without a feedforward capacitor on the output voltage divider, however, using a typically 10pF feedforward capacitor improves transient response.

The devices support forced fixed frequency PWM operation with the MODE pin tied to a logic high level. The frequency is defined as either 2.25MHz internally fixed for the TPS62850x-Q1 when COMP/FSET is tied to GND or VIN, or in a range of 1.8MHz to 4MHz defined by a resistor from COMP/FSET to GND. Alternatively, the devices can be synchronized to an external clock signal in a range from 1.8MHz to 4MHz, applied to the MODE pin with no need for additional passive components. An internal PLL allows you to change from internal clock to external clock during operation. The synchronization to the external clock is done on a falling edge of the clock applied at MODE to the rising edge on the SW pin. This action allows a roughly 180° phase shift when the SW pin is used to generate the synchronization signal for a second converter. When the MODE pin is set to a logic low level, the device operates in power save mode (PFM) at low output current and automatically transfers to fixed frequency PWM mode at higher output current. In PFM mode, the switching frequency decreases linearly based on the load to sustain high efficiency down to very low output current.

8.2 Functional Block Diagram

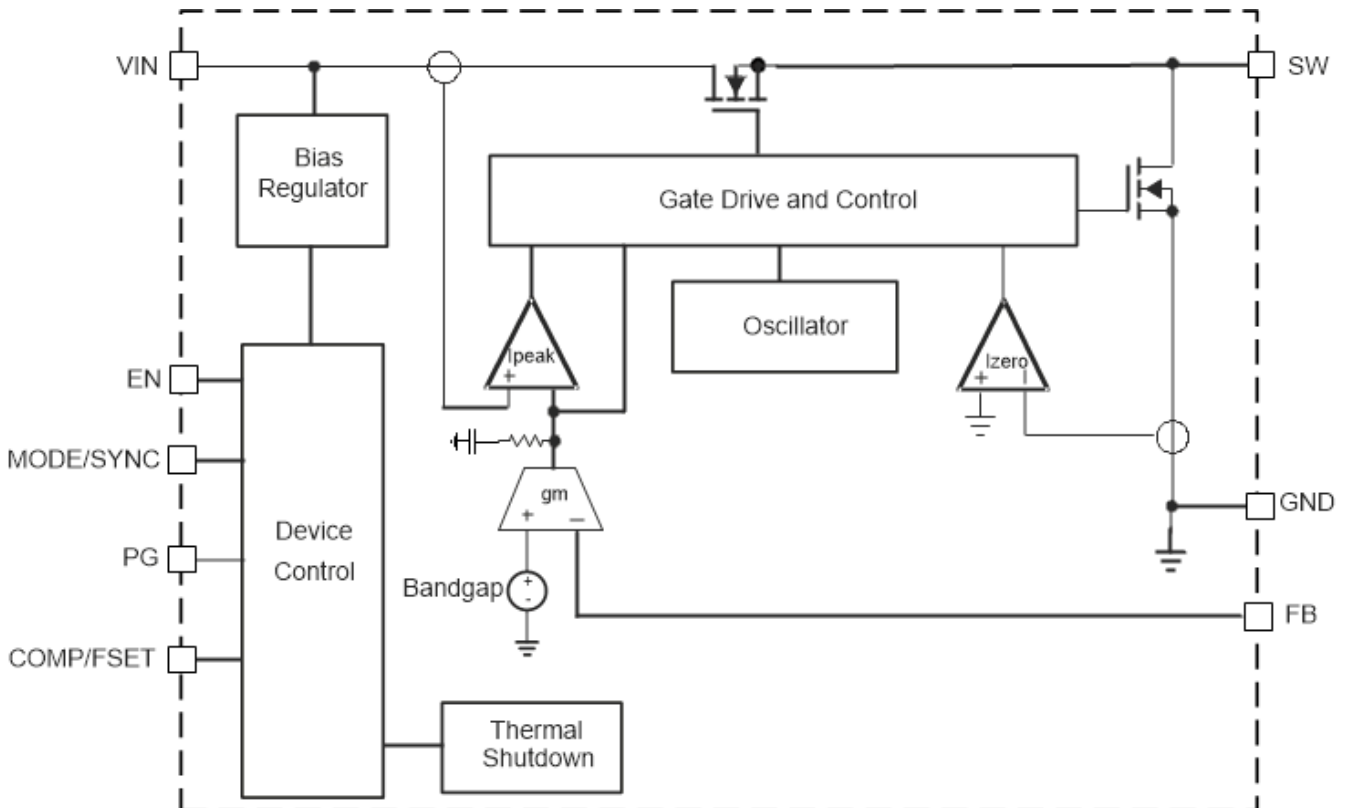

8.3 Feature Description

8.3.1 Precise Enable (EN)

The voltage applied at the enable pin of the TPS62850x-Q1 is compared to a fixed threshold of 1.1V for a rising voltage. This allows you to drive the pin by a slowly changing voltage and enables the use of an external RC network to achieve a power-up delay.

The Precise Enable input provides a user-programmable undervoltage lockout by adding a resistor divider to the input of the Enable pin.

The enable input threshold for a falling edge is typically 100mV lower than the rising edge threshold. The TPS62850x-Q1 starts operation when the rising threshold is exceeded. For proper operation, the enable (EN) pin must be terminated and must not be left floating. Pulling the enable pin low forces the device into shutdown, with a shutdown current of typically 1µA. In this mode, the internal high-side and low-side MOSFETs are turned off and the entire internal control circuitry is switched off.

8.3.2 COMP/FSET

This pin allows to set three different parameters:

- Internal compensation settings for the control loop (two settings available)
- The switching frequency in PWM mode from 1.8MHz to 4MHz
- Enable/disable spread spectrum clocking (SSC)

A resistor from COMP/FSET to GND changes the compensation as well as the switching frequency. The change in compensation allows you to adopt the device to different values of output capacitance. The resistor must be placed close to the pin to keep the parasitic capacitance on the pin to a minimum. The compensation setting is sampled at start up of the converter, so a change in the resistor during operation only has an effect on the switching frequency but not on the compensation.

To save external components, the pin can also be directly tied to VIN or GND to set a pre-defined setting. Do not leave the pin floating.

The switching frequency has to be selected based on the input voltage and the output voltage to meet the specifications for the minimum on-time and minimum off-time.

Example: $V_{IN} = 5V$, $V_{OUT} = 0.6V$ --> duty cycle = $0.6V / 5V = 0.12$

- --> $t_{on,min} = 1 / f_s \times 0.12$
- --> $f_{sw,max} = 1 / t_{on,min} \times 0.12 = 1 / 0.05\mu s \times 0.12 = 2.4MHz$

The compensation range has to be chosen based on the minimum capacitance used. The capacitance can be increased from the minimum value as given in [Table 8-1](#), up to the maximum of 200µF in both compensation ranges. If the capacitance of an output changes during operation, for example, when load switches are used to connect or disconnect parts of the circuitry, the compensation has to be chosen for the minimum capacitance on the output. With large output capacitance, the compensation must be done based on that large capacitance to get the best load transient response. Compensating for large output capacitance but placing less capacitance on the output can lead to instability.

Table 8-1. Switching Frequency, Compensation, and Spread Spectrum Clocking

R_{CF}	COMPENSATION	SWITCHING FREQUENCY	MINIMUM OUTPUT CAPACITANCE FOR $V_{OUT} < 1V$	MINIMUM OUTPUT CAPACITANCE FOR $1V \leq V_{OUT} < 3.3V$	MINIMUM OUTPUT CAPACITANCE FOR $V_{OUT} \geq 3.3V$
10kΩ .. 4.5kΩ	For smallest output capacitance (comp setting 1) SSC disabled	$R_{CF}(k\Omega) = \frac{18MHz \times k\Omega}{f_S(MHz)} \quad (1)$	15µF	10µF	8µF
33kΩ .. 15kΩ	For best transient response (larger output capacitance) (comp setting 2) SSC enabled	$R_{CF}(k\Omega) = \frac{60MHz \times k\Omega}{f_S(MHz)} \quad (2)$	30µF	18µF	15µF

Table 8-1. Switching Frequency, Compensation, and Spread Spectrum Clocking (continued)

R_{CF}	COMPENSATION	SWITCHING FREQUENCY	MINIMUM OUTPUT CAPACITANCE FOR $V_{OUT} < 1V$	MINIMUM OUTPUT CAPACITANCE FOR $1V \leq V_{OUT} < 3.3V$	MINIMUM OUTPUT CAPACITANCE FOR $V_{OUT} \geq 3.3V$
100k Ω .. 45k Ω	For best transient response (larger output capacitance) (comp setting 2) SSC disabled	$R_{CF}(k\Omega) = \frac{180MHz \times k\Omega}{f_S(MHz)} \quad (3)$	30 μ F	18 μ F	15 μ F
tied to GND	For smallest output capacitance (comp setting 1) SSC disabled	internally fixed 2.25MHz	15 μ F	10 μ F	8 μ F
tied to V_{IN}	For best transient response (larger output capacitance) (comp setting 2) SSC enabled	internally fixed 2.25MHz	30 μ F	18 μ F	15 μ F

Refer to [Section 9.1.3.2](#) for further details on the output capacitance required depending on the output voltage.

A resistor value that is too high for R_{CF} is decoded as "tied to V_{IN} ", a value below the lowest range is decoded as "tied to GND". The minimum output capacitance in [Table 8-1](#) is for capacitors close to the output of the device. If the capacitance is distributed, a lower compensation setting can be required.

8.3.3 MODE / SYNC

When MODE/SYNC is set low, the device operates in PWM or PFM mode, depending on the output current. The MODE/SYNC pin allows you to force PWM mode when set high. The pin also allows you to apply an external clock in a frequency range from 1.8MHz to 4MHz for external synchronization. The specifications for the minimum on-time and minimum off-time has to be observed when setting the external frequency. For use with external synchronization on the MODE/SYNC pin, the internal switching frequency must be set by R_{CF} to a similar value than the externally applied clock. This ensures that, if the external clock fails, the switching frequency stays in the same range and the compensation settings are still valid.

8.3.4 Spread Spectrum Clocking (SSC)

The device offers spread spectrum clocking as an option. When SSC is enabled, the switching frequency is randomly changed in PWM mode when the internal clock is used. The frequency variation is typically between the nominal switching frequency and up to 288kHz above the nominal switching frequency. When the device is externally synchronized by applying a clock signal to the MODE/SYNC pin, the TPS62850x-Q1 follows the external clock and the internal spread spectrum block is turned off. SSC is also disabled during soft start.

8.3.5 Undervoltage Lockout (UVLO)

If the input voltage drops, the undervoltage lockout prevents misoperation of the device by switching off both the power FETs. When enabled, the device is fully operational for input voltages above the rising UVLO threshold and turns off if the input voltage trips below the threshold for a falling supply voltage.

8.3.6 Power-Good Output (PG)

Power good is an open-drain output that requires a pullup resistor to any voltage up to the recommended input voltage level. Power good is driven by a window comparator. PG is held low when the device is disabled, in undervoltage lockout in thermal shutdown, and not in soft start. When the output voltage is in regulation hence, within the window defined in the electrical characteristics, the output is high impedance.

V_{IN} must remain present for the PG pin to stay low. If the power-good output is not used, TI recommends to tie to GND or leave open. The PG indicator features a deglitch, as specified in the electrical characteristics, for the transition from *high impedance* to *low* of the output.

Table 8-2. PG Status

EN	DEVICE STATUS	PG STATE
X	$V_{IN} < 2V$	undefined
low	$V_{IN} \geq 2V$	low
high	$2V \leq V_{IN} \leq UVLO$ OR in thermal shutdown OR V_{OUT} not in regulation OR device in soft start	low
high	V_{OUT} in regulation	high impedance

8.3.7 Thermal Shutdown

The junction temperature (T_J) of the device is monitored by an internal temperature sensor. If T_J exceeds 170°C (typ), the device goes into thermal shutdown. Both the high-side and low-side power FETs are turned off and PG goes low. When T_J decreases below the hysteresis amount of typically 15°C, the converter resumes normal operation, beginning with soft start. During a PFM pause, the thermal shutdown is not active. After a PFM pause, the device needs up to 9µs to detect a junction temperature that is too high. If the PFM burst is shorter than this delay, the device does not detect a junction temperature that is too high.

8.4 Device Functional Modes

8.4.1 Pulse Width Modulation (PWM) Operation

The TPS62850x-Q1 has two operating modes: forced PWM mode, which is discussed in this section, and PWM/PFM as discussed in [Section 8.4.2](#).

With the MODE/SYNC pin set to high, the TPS62850x-Q1 operates with pulse width modulation in continuous conduction mode (CCM). The switching frequency is defined by a resistor from the COMP pin to GND or by an external clock signal applied to the MODE/SYNC pin. With an external clock applied to MODE/SYNC, the TPS62850x-Q1 follow the frequency applied to the pin. In general, the frequency range in forced PWM mode is 1.8MHz to 4MHz. However, the frequency must be in a range the TPS62850x-Q1 can operate at, taking the minimum on-time into account.

8.4.2 Power Save Mode Operation (PWM/PFM)

When the MODE/SYNC pin is low, power save mode is allowed. The device operates in PWM mode as long as the peak inductor current is above the PFM threshold of about 0.8A. When the peak inductor current drops below the PFM threshold, the device starts to skip switching pulses. In power save mode, the switching frequency decreases with the load current maintaining high efficiency. In addition, the frequency set with the resistor on COMP/FSET must be in a range of 1.8MHz to 3.5MHz.

8.4.3 100% Duty-Cycle Operation

The duty cycle of a buck converter operated in PWM mode is given as $D = V_{OUT} / V_{IN}$. The duty cycle increases as the input voltage comes close to the output voltage and the off-time gets smaller. When the minimum off-time of typically 10ns is reached, the TPS62850x-Q1 skips switching cycles while approaching 100% mode. In 100% mode, the device keeps the high-side switch on continuously. The high-side switch stays turned on as long as the output voltage is below the target. In 100% mode, the low-side switch is turned off. The maximum dropout voltage in 100% mode is the product of the on-resistance of the high-side switch plus the series resistance of the inductor and the load current.

8.4.4 Current Limit and Short-Circuit Protection

The TPS62850x-Q1 is protected against overload and short circuit events. If the inductor current exceeds the current limit I_{LIMH} , the high-side switch is turned off and the low-side switch is turned on to ramp down the inductor current. The high-side switch turns on again only if the current in the low side-switch has decreased below the low side current limit. Due to internal propagation delay, the actual current can exceed the static current limit. The dynamic current limit is given as:

$$I_{peak(typ)} = I_{LIMH} + \frac{V_L}{L} \cdot t_{PD} \quad (4)$$

where

- I_{LIMH} is the static current limit as specified in the electrical characteristics
- L is the effective inductance at the peak current
- V_L is the voltage across the inductor ($V_{IN} - V_{OUT}$)
- t_{PD} is the internal propagation delay of typically 50ns

The current limit can exceed static values, especially if the input voltage is high and very small inductances are used. The dynamic high-side switch peak current can be calculated as follows:

$$I_{peak(typ)} = I_{LIMH} + \frac{V_{IN} - V_{OUT}}{L} \cdot 50ns \quad (5)$$

8.4.5 Foldback Current Limit and Short-Circuit Protection

This is valid for devices where foldback current limit is enabled. If interested in this option, please contact Texas Instruments.

When the device detects current limit for more than 1024 subsequent switching cycles, the device reduces the current limit from the nominal value to typically 1.3A. Foldback current limit is left when the current limit indication goes away. If device operation continues in current limit, the device can, after 3072 switching cycles, try for full current limit again for 1024 switching cycles.

8.4.6 Output Discharge

The purpose of the discharge function is to make sure of a defined down-ramp of the output voltage when the device is being disabled and to keep the output voltage close to 0V when the device is off. The output discharge feature is only active after the TPS62850x-Q1 have been enabled at least once since the supply voltage was applied. The discharge function is enabled as soon as the device is disabled, in thermal shutdown, or in undervoltage lockout. The minimum supply voltage required for the discharge function to remain active typically is 2V. Output discharge is not activated during a current limit or foldback current limit event. When supply voltage is applied but the device had not been enabled yet, the discharge function is undefined. For applications where the output voltage discharge has to be off after supply voltage is applied and the enable pin is still at low level, use the versions that are stated as *Output discharge disconnected* in the *Device Comparison* table.

8.4.7 Input Overvoltage Protection

When the input voltage exceeds the absolute maximum rating, the device is set to PFM mode so the device cannot transfer energy from the output to the input.

9 Application and Implementation

Note

Information in the following applications sections is not part of the TI component specification, and TI does not warrant its accuracy or completeness. TI's customers are responsible for determining suitability of components for their purposes, as well as validating and testing their design implementation to confirm system functionality.

9.1 Application Information

9.1.1 Programming the Output Voltage

The output voltage of the TPS62850x-Q1 is adjustable. The output voltage can be programmed for output voltages from 0.6V to 5.5V using a resistor divider from V_{OUT} to GND. The voltage at the FB pin is regulated to 600mV. The value of the output voltage is set by the selection of the resistor divider from [Equation 6](#). TI recommends to choose resistor values that allow a current of at least 2μA, meaning the value of R₂ must not exceed 400kΩ. TI recommends lower resistor values for highest accuracy and most robust design.

$$R_1 = R_2 \cdot \left(\frac{V_{OUT}}{V_{FB}} - 1 \right) \quad (6)$$

9.1.2 External Component Selection

9.1.2.1 Inductor Selection

The TPS62850x-Q1 is designed for a nominal 0.47μH inductor with a switching frequency of typically 2.25MHz. Larger values can be used to achieve a lower inductor current ripple but can have a negative impact on efficiency and transient response. Smaller values than 0.47μH cause a larger inductor current ripple which causes larger negative inductor current in forced PWM mode at low or no output current. For a higher or lower nominal switching frequency, the inductance must be changed accordingly. See [Recommended Operating Conditions](#) for details.

The inductor selection is affected by several effects like inductor ripple current, output ripple voltage, PWM-to-PFM transition point, and efficiency. In addition, the inductor selected has to be rated for appropriate saturation current and DC resistance (DCR). [Equation 7](#) calculates the maximum inductor current.

$$I_{L(max)} = I_{OUT(max)} + \frac{\Delta I_{L(max)}}{2} \quad (7)$$

$$\Delta I_{L(max)} = \frac{V_{OUT} \cdot \left(1 - \frac{V_{OUT}}{V_{IN}} \right)}{L \min} \cdot \frac{1}{f_{SW}} \quad (8)$$

where

- I_{L(max)} is the maximum inductor current
- ΔI_{L(max)} is the peak-to-peak inductor ripple current
- L_{min} is the minimum inductance at the operating point

Table 9-1. Typical Inductors

TYPE	INDUCTANCE	CURRENT (1)	FOR DEVICE	NOMINAL SWITCHING FREQUENCY	DIMENSIONS [LxWxH] mm	MANUFACTURER(2)
XFL4015-471ME	0.47μH, ±20%	3.5A	TPS628501 / 502	2.25 MHz	4 × 4 × 1.6	Coilcraft
XFL4015-701ME	0.70μH, ±20%	3.3A	TPS628501 / 502	2.25 MHz	4 × 4 × 1.6	Coilcraft
XEL3520-801ME	0.80μH, ±20%	2.0A	TPS628501 / 502	2.25 MHz	3.5 × 3.2 × 2.0	Coilcraft
XEL3515-561ME	0.56μH, ±20%	4.5A	TPS628501 / 502	2.25 MHz	3.5 × 3.2 × 1.5	Coilcraft
XFL3012-681ME	0.68μH, ±20%	2.1A	TPS628501 / 502	2.25 MHz	3.0 × 3.0 × 1.2	Coilcraft
XPL2010-681ML	0.68μH, ±20%	1.5A	TPS628501	2.25 MHz	2 × 1.9 × 1	Coilcraft
DFE252012PD-R68M	0.68μH, ±20%	See data sheet	TPS628501 / 502	2.25 MHz	2.5 × 2 × 1.2	Murata
DFE252012PD-R47M	0.47μH, ±20%	See data sheet	TPS628501 / 502	2.25 MHz	2.5 × 2 × 1.2	Murata
DFE201612PD-R68M	0.68μH, ±20%	See data sheet	TPS628501 / 502	2.25 MHz	2 × 1.6 × 1.2	Murata
DFE201612PD-R47M	0.47μH, ±20%	See data sheet	TPS628501 / 502	2.25 MHz	2 × 1.6 × 1.2	Murata

(1) Lower of I_{RMS} at 20°C rise or I_{SAT} at 20% drop.

(2) See the [Third-party Products Disclaimer](#).

Calculating the maximum inductor current using the actual operating conditions gives the minimum saturation current of the inductor needed. TI recommends a margin of about 20% to add. A larger inductor value is also useful to get lower ripple current, but increases the transient response time and size as well.

9.1.3 Capacitor Selection

9.1.3.1 Input Capacitor

For most applications, 10μF nominal is sufficient and recommended. The input capacitor buffers the input voltage for transient events and also decouples the converter from the supply. TI recommends a low-ESR multilayer ceramic capacitor (MLCC) for best filtering and must be placed between VIN and GND as close as possible to those pins.

9.1.3.2 Output Capacitor

The architecture of the TPS62850x-Q1 allows the use of tiny ceramic output capacitors with low equivalent series resistance (ESR). These capacitors provide low output voltage ripple and are recommended. To keep the low resistance up to high frequencies and to get narrow capacitance variation with temperature, TI recommends to use X7R or X5R dielectric. Using a higher value has advantages like smaller voltage ripple and a tighter DC output accuracy in power save mode.

The COMP/FSET pin allows you to select two different compensation settings based on the minimum capacitance used on the output. The maximum capacitance is 200μF in any of the compensation settings. The minimum capacitance required on the output depends on the compensation setting and output voltage.

For output voltages below 1V, the minimum increases linearly from 10μF at 1V to 15μF at 0.6V with the compensation setting for smallest output capacitance. Other compensation ranges are equivalent. See [Table 8-1](#) for details.

9.2 Typical Application

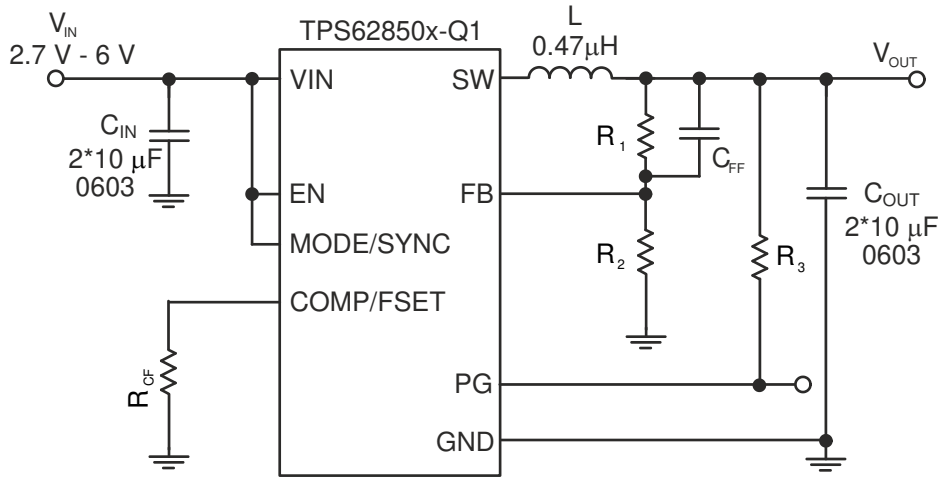

Figure 9-1. Typical Application

9.2.1 Design Requirements

The design guidelines provide a component selection to operate the device within the recommended operating conditions.

9.2.2 Detailed Design Procedure

$$R_1 = R_2 \cdot \left(\frac{V_{OUT}}{V_{FB}} - 1 \right) \quad (9)$$

With $V_{FB} = 0.6V$:

Table 9-2. Setting the Output Voltage

NOMINAL OUTPUT VOLTAGE V_{OUT}	R_1	R_2	C_{FF}	EXACT OUTPUT VOLTAGE
0.8V	16.9k Ω	51k Ω	10pF	0.7988V
1.0V	20k Ω	30k Ω	10pF	1.0V
1.1V	39.2k Ω	47k Ω	10pF	1.101V
1.2V	68k Ω	68k Ω	10pF	1.2V
1.5V	76.8k Ω	51k Ω	10pF	1.5V
1.8V	80.6k Ω	40.2k Ω	10pF	1.803V
2.5V	47.5k Ω	15k Ω	10pF	2.5V
3.3V	88.7k Ω	19.6k Ω	10pF	3.315V

9.2.3 Application Curves

All plots have been taken with a nominal switching frequency of 2.25 MHz when set to PWM mode, unless otherwise noted. The BOM is according to [Table 7-1](#).

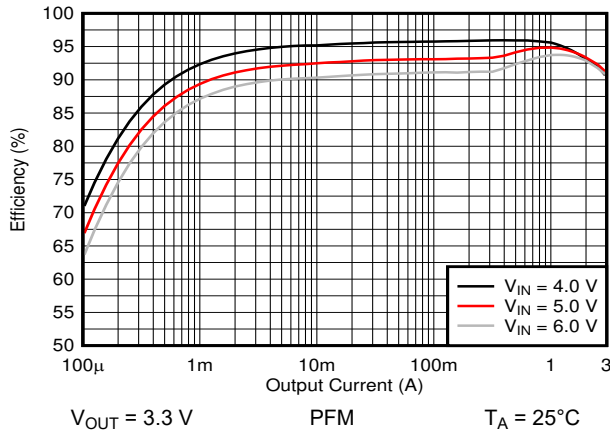

Figure 9-2. Efficiency vs Output Current

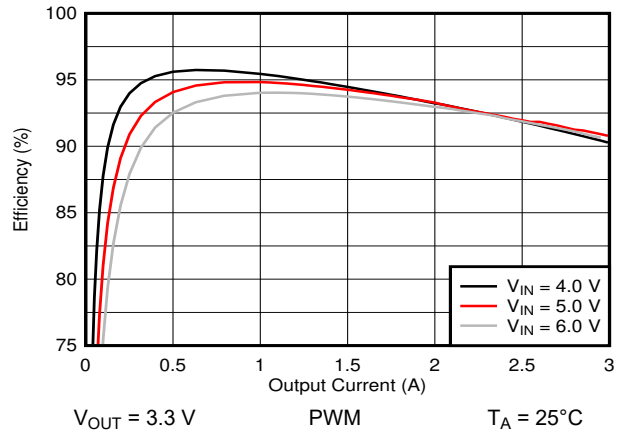

Figure 9-3. Efficiency vs Output Current

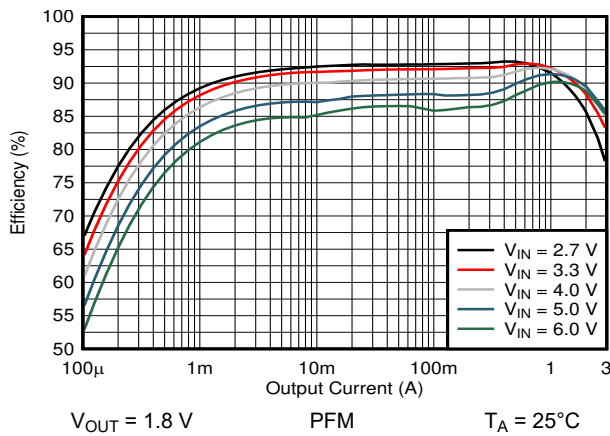

Figure 9-4. Efficiency vs Output Current

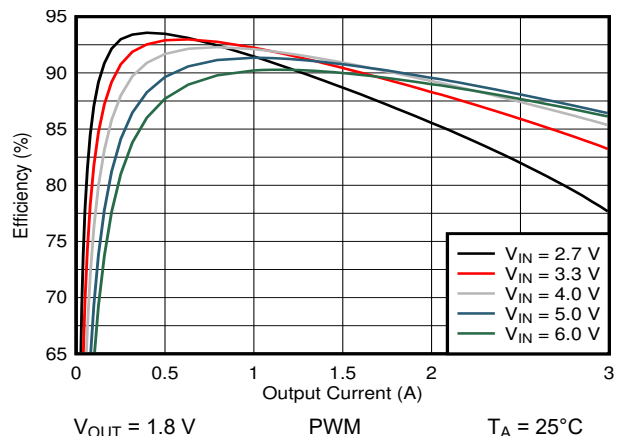

Figure 9-5. Efficiency vs Output Current

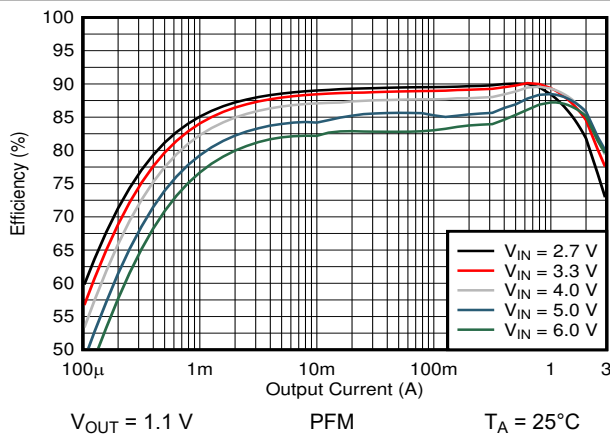

Figure 9-6. Efficiency vs Output Current

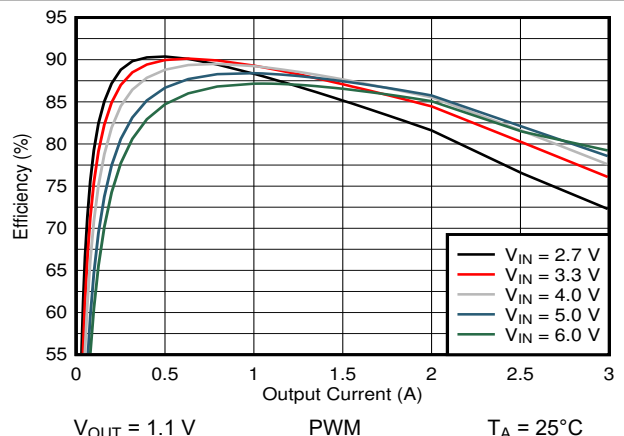

Figure 9-7. Efficiency vs Output Current

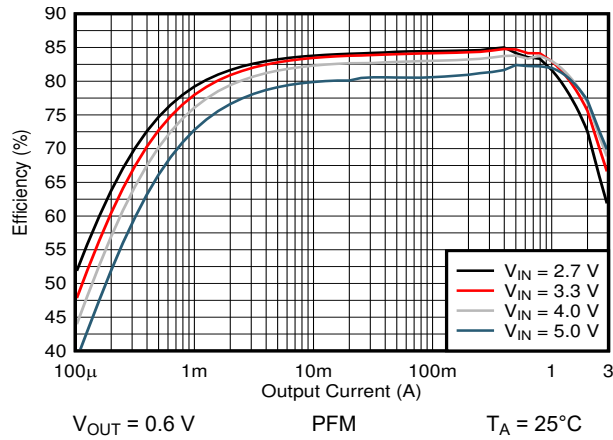

Figure 9-8. Efficiency vs Output Current

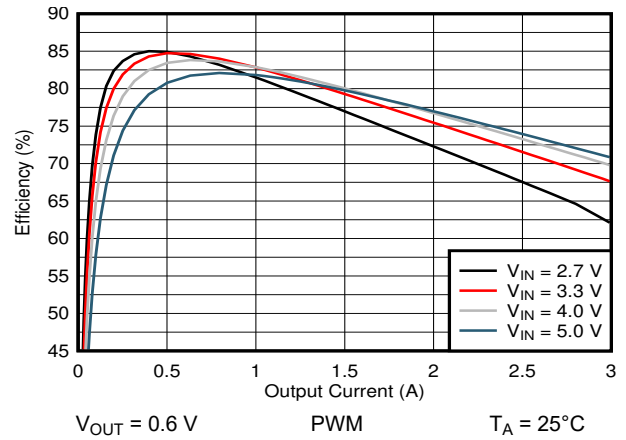

Figure 9-9. Efficiency vs Output Current

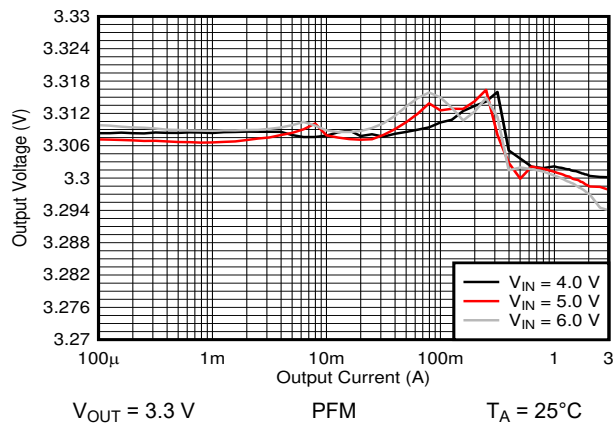

Figure 9-10. Output Voltage vs Output Current

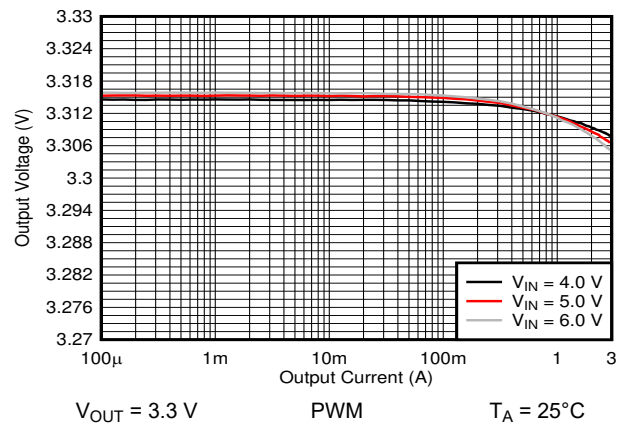

Figure 9-11. Output Voltage vs Output Current

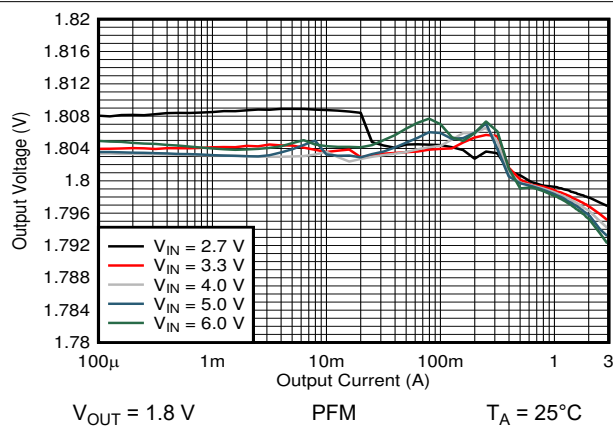

Figure 9-12. Output Voltage vs Output Current

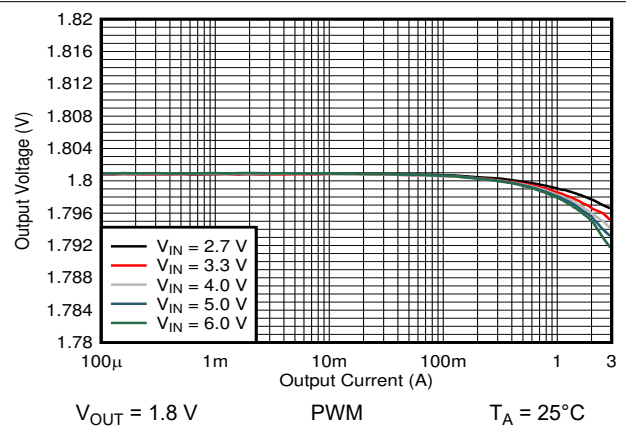

Figure 9-13. Output Voltage vs Output Current

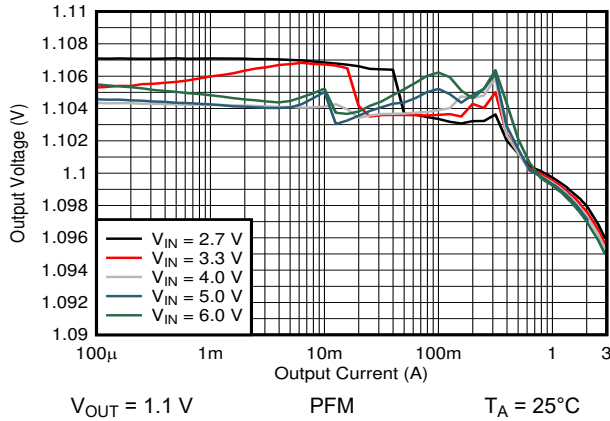

Figure 9-14. Output Voltage vs Output Current

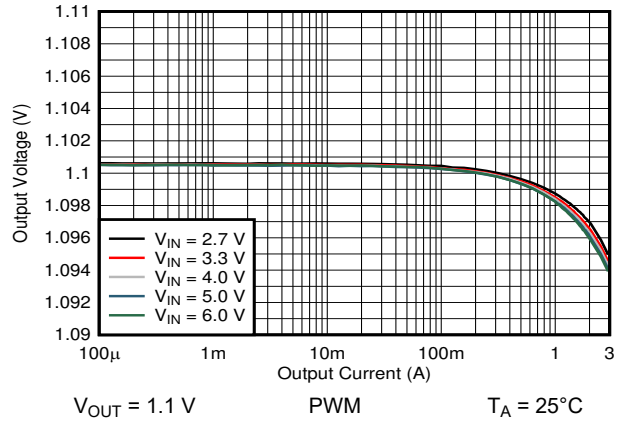

Figure 9-15. Output Voltage vs Output Current

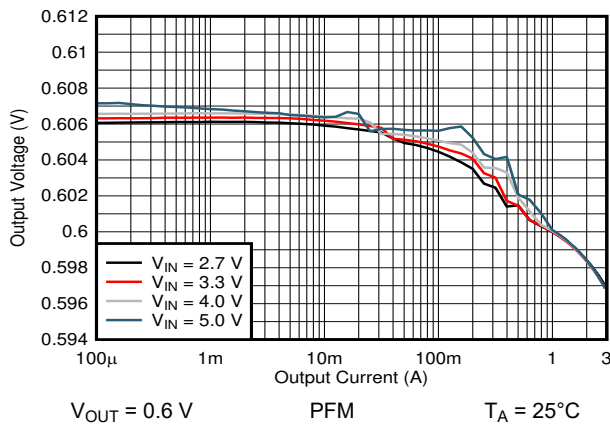

Figure 9-16. Output Voltage vs Output Current

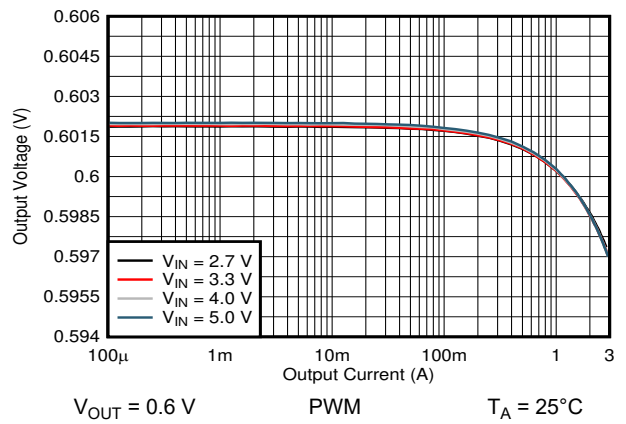

Figure 9-17. Output Voltage vs Output Current

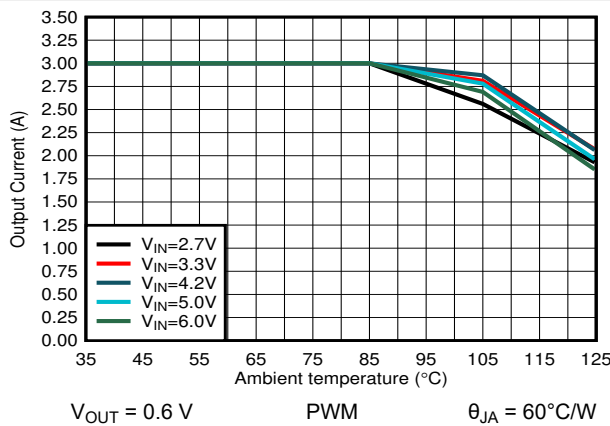

Figure 9-18. Output Current vs Ambient Temperature

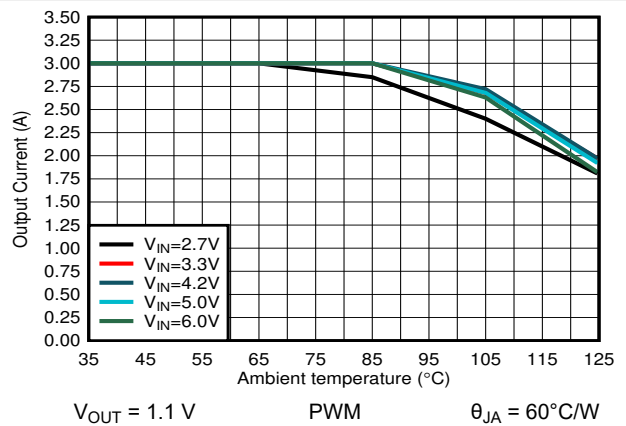

Figure 9-19. Output Current vs Ambient Temperature

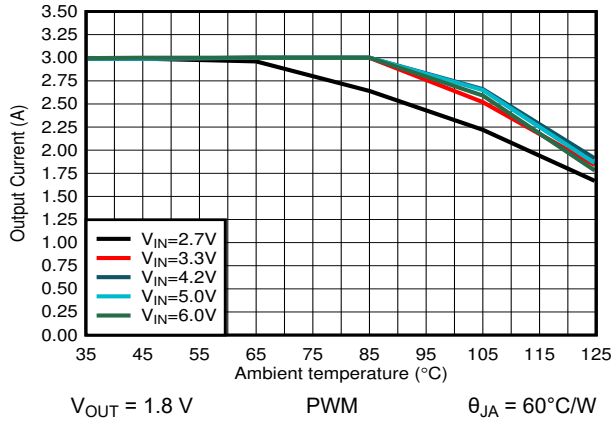

Figure 9-20. Output Current vs Ambient Temperature

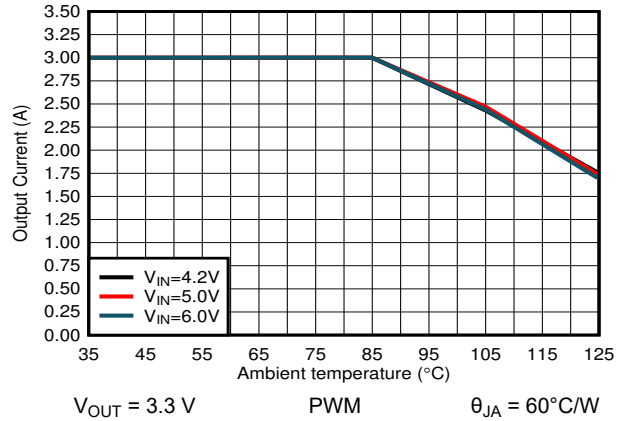
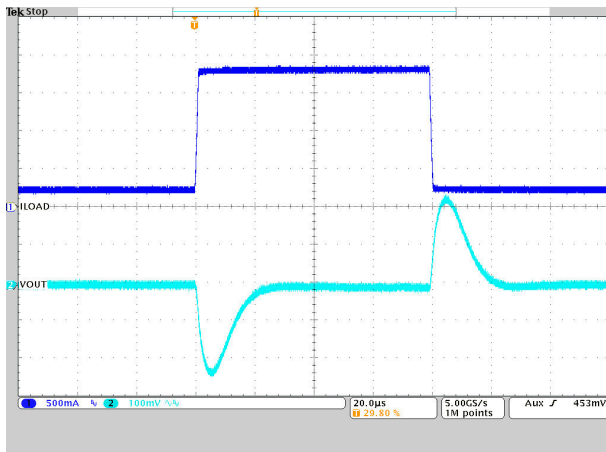
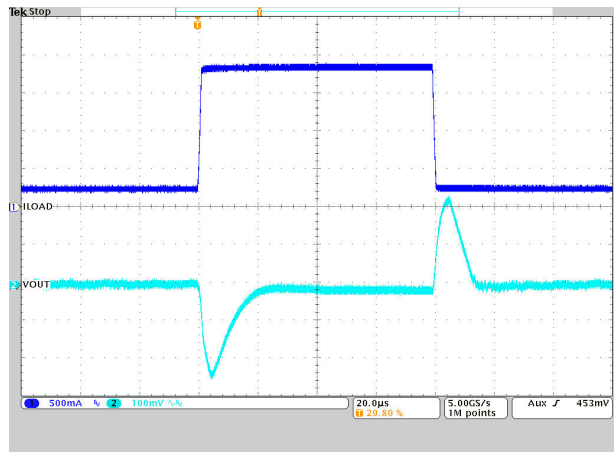

Figure 9-21. Output Current vs Ambient Temperature



$V_{OUT} = 3.3\text{ V}$ PFM $T_A = 25^\circ\text{C}$
 $V_{IN} = 5.0\text{ V}$ $I_{OUT} = 0.2\text{ A to } 1.8\text{ A to } 0.2\text{ A}$

Figure 9-22. Load Transient Response



$V_{OUT} = 3.3\text{ V}$ PWM $T_A = 25^\circ\text{C}$
 $V_{IN} = 5.0\text{ V}$ $I_{OUT} = 0.2\text{ A to } 1.8\text{ A to } 0.2\text{ A}$

Figure 9-23. Load Transient Response

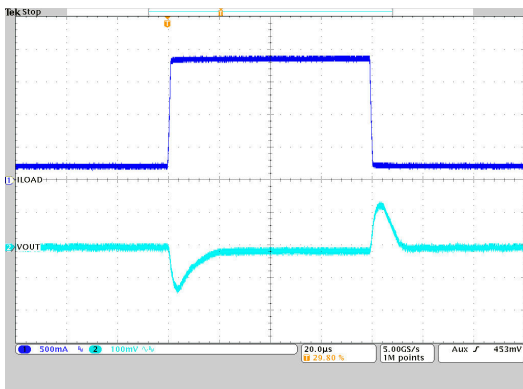

$V_{OUT} = 1.8\text{ V}$ PFM $T_A = 25^\circ\text{C}$
 $V_{IN} = 5.0\text{ V}$ $I_{OUT} = 0.2\text{ A to } 1.8\text{ A to } 0.2\text{ A}$

Figure 9-24. Load Transient Response

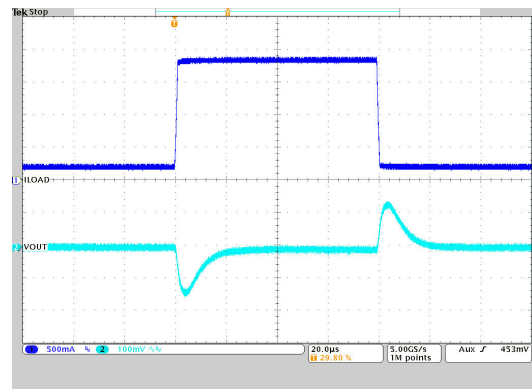

$V_{OUT} = 1.8\text{ V}$ PWM $T_A = 25^\circ\text{C}$
 $V_{IN} = 5.0\text{ V}$ $I_{OUT} = 0.2\text{ A to } 1.8\text{ A to } 0.2\text{ A}$

Figure 9-25. Load Transient Response

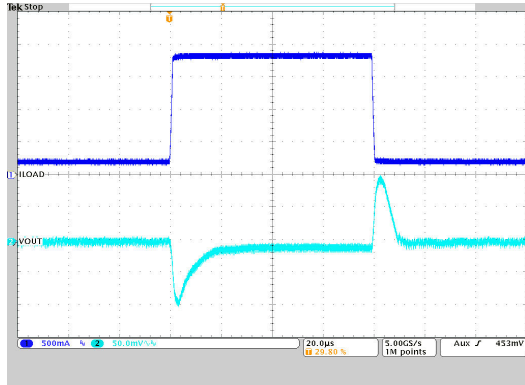

$V_{OUT} = 1.2\text{ V}$ PFM $T_A = 25^\circ\text{C}$
 $V_{IN} = 5.0\text{ V}$ $I_{OUT} = 0.2\text{ A to } 1.8\text{ A to } 0.2\text{ A}$

Figure 9-26. Load Transient Response

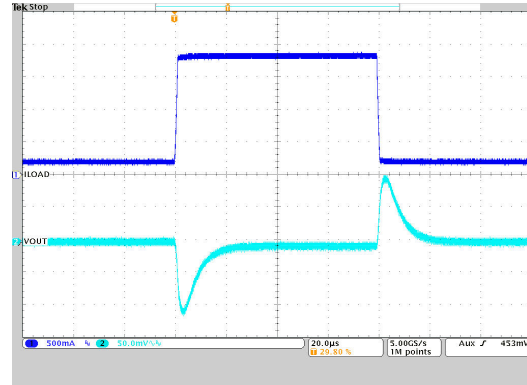

$V_{OUT} = 1.2\text{ V}$ PWM $T_A = 25^\circ\text{C}$
 $V_{IN} = 5.0\text{ V}$ $I_{OUT} = 0.2\text{ A to } 1.8\text{ A to } 0.2\text{ A}$

Figure 9-27. Load Transient Response

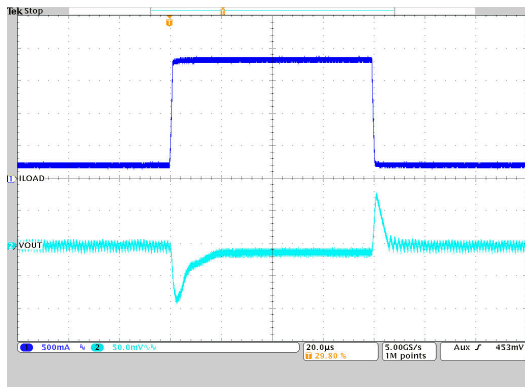

$V_{OUT} = 1.0\text{ V}$ PFM $T_A = 25^\circ\text{C}$
 $V_{IN} = 5.0\text{ V}$ $I_{OUT} = 0.2\text{ A to } 1.8\text{ A to } 0.2\text{ A}$

Figure 9-28. Load Transient Response

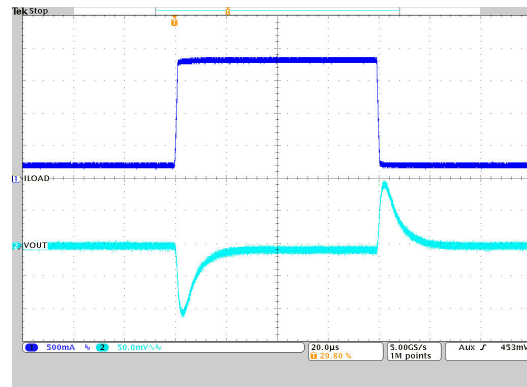

$V_{OUT} = 1.0\text{ V}$ PWM $T_A = 25^\circ\text{C}$
 $V_{IN} = 5.0\text{ V}$ $I_{OUT} = 0.2\text{ A to } 1.8\text{ A to } 0.2\text{ A}$

Figure 9-29. Load Transient Response

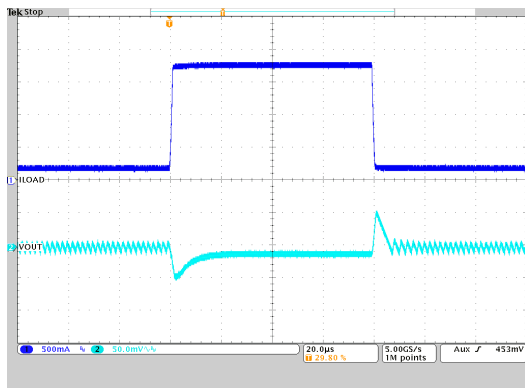

$V_{OUT} = 0.6\text{ V}$ PFM $T_A = 25^\circ\text{C}$
 $V_{IN} = 3.3\text{ V}$ $I_{OUT} = 0.2\text{ A to } 1.8\text{ A to } 0.2\text{ A}$

Figure 9-30. Load Transient Response

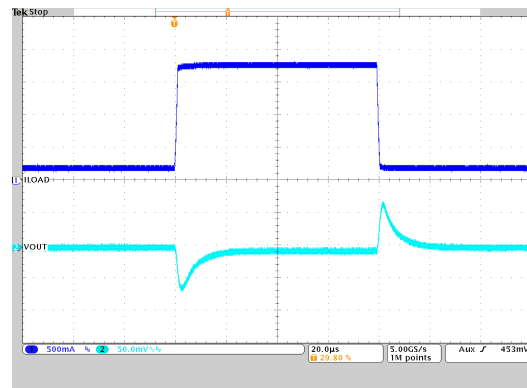

$V_{OUT} = 0.6\text{ V}$ PWM $T_A = 25^\circ\text{C}$
 $V_{IN} = 3.3\text{ V}$ $I_{OUT} = 0.2\text{ A to } 1.8\text{ A to } 0.2\text{ A}$

Figure 9-31. Load Transient Response

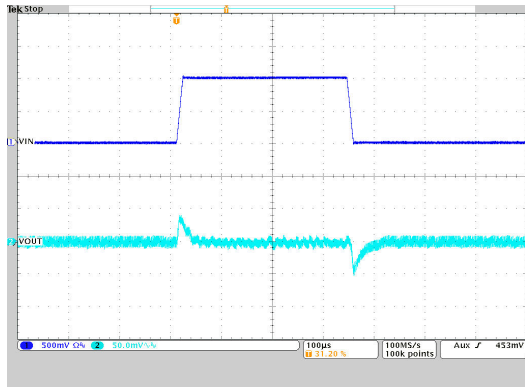

$V_{OUT} = 3.3\text{ V}$ PFM $T_A = 25^\circ\text{C}$
 $I_{OUT} = 0.2\text{ A}$ $V_{IN} = 4.5\text{ V to } 5.5\text{ V to } 4.5\text{ V}$

Figure 9-32. Line Transient Response

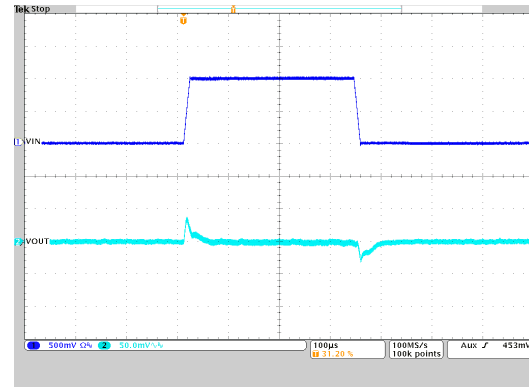

$V_{OUT} = 3.3\text{ V}$ PWM $T_A = 25^\circ\text{C}$
 $I_{OUT} = 2\text{ A}$ $V_{IN} = 4.5\text{ V to } 5.5\text{ V to } 4.5\text{ V}$

Figure 9-33. Line Transient Response

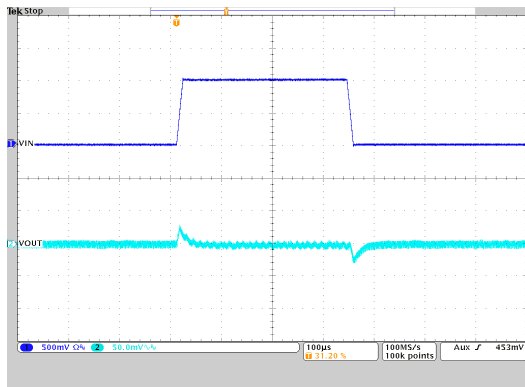

$V_{OUT} = 1.8\text{ V}$ PFM $T_A = 25^\circ\text{C}$
 $I_{OUT} = 0.2\text{ A}$ $V_{IN} = 4.5\text{ V to } 5.5\text{ V to } 4.5\text{ V}$

Figure 9-34. Line Transient Response

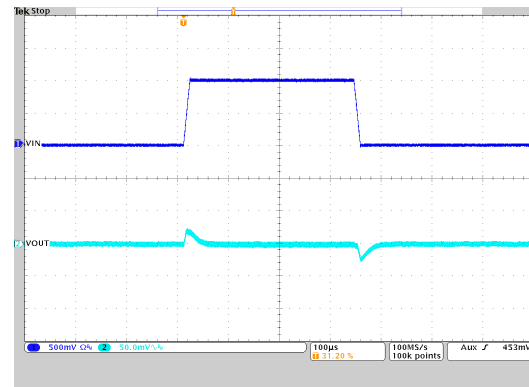

$V_{OUT} = 1.8\text{ V}$ PWM $T_A = 25^\circ\text{C}$
 $I_{OUT} = 2\text{ A}$ $V_{IN} = 4.5\text{ V to } 5.5\text{ V to } 4.5\text{ V}$

Figure 9-35. Line Transient Response

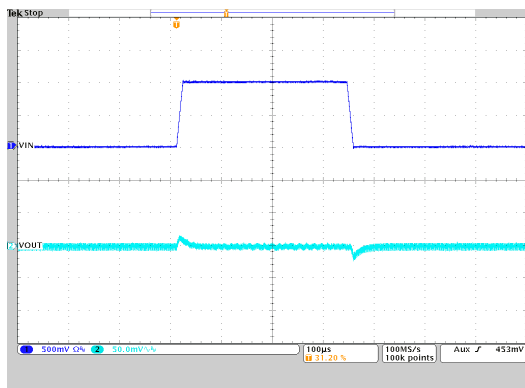

$V_{OUT} = 1.2\text{ V}$ PFM $T_A = 25^\circ\text{C}$
 $I_{OUT} = 0.2\text{ A}$ $V_{IN} = 4.5\text{ V to } 5.5\text{ V to } 4.5\text{ V}$

Figure 9-36. Line Transient Response

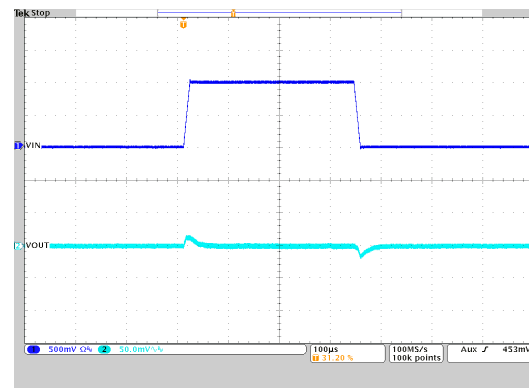

$V_{OUT} = 1.2\text{ V}$ PWM $T_A = 25^\circ\text{C}$
 $I_{OUT} = 2\text{ A}$ $V_{IN} = 4.5\text{ V to } 5.5\text{ V to } 4.5\text{ V}$

Figure 9-37. Line Transient Response

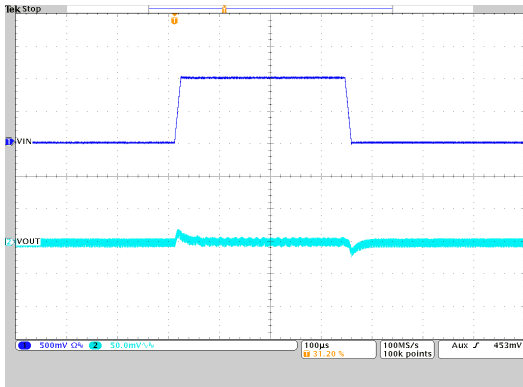

$V_{OUT} = 1.0\text{ V}$ PFM $T_A = 25^\circ\text{C}$
 $I_{OUT} = 0.2\text{ A}$ $V_{IN} = 4.5\text{ V to } 5.5\text{ V to } 4.5\text{ V}$

Figure 9-38. Line Transient Response

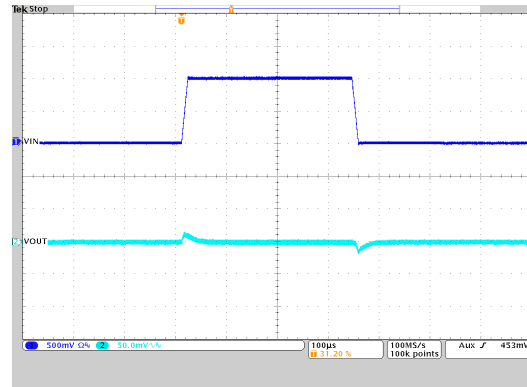

$V_{OUT} = 1.0\text{ V}$ PWM $T_A = 25^\circ\text{C}$
 $I_{OUT} = 2\text{ A}$ $V_{IN} = 4.5\text{ V to } 5.5\text{ V to } 4.5\text{ V}$

Figure 9-39. Line Transient Response

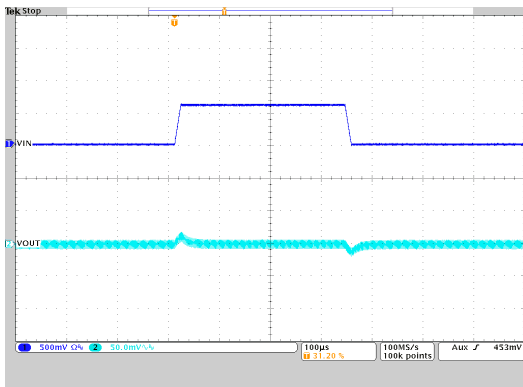

$V_{OUT} = 0.6\text{ V}$ PFM $T_A = 25^\circ\text{C}$
 $I_{OUT} = 0.2\text{ A}$ $V_{IN} = 3.0\text{ V to } 3.6\text{ V to } 3.0\text{ V}$

Figure 9-40. Line Transient Response

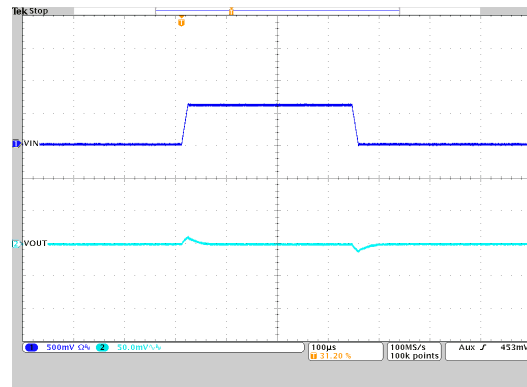

$V_{OUT} = 0.6\text{ V}$ PWM $T_A = 25^\circ\text{C}$
 $I_{OUT} = 2\text{ A}$ $V_{IN} = 3.0\text{ V to } 3.6\text{ V to } 3.0\text{ V}$

Figure 9-41. Line Transient Response

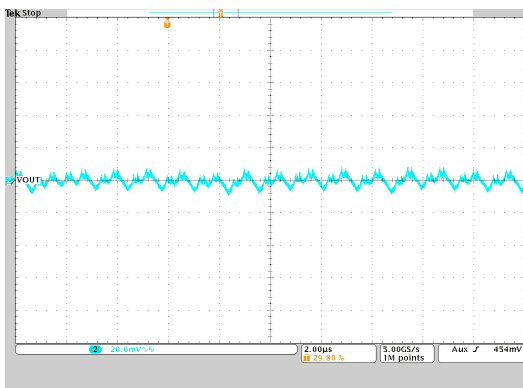

$V_{OUT} = 3.3\text{ V}$ PFM $T_A = 25^\circ\text{C}$
 $V_{IN} = 5\text{ V}$ $I_{OUT} = 0.2\text{ A}$

Figure 9-42. Output Voltage Ripple

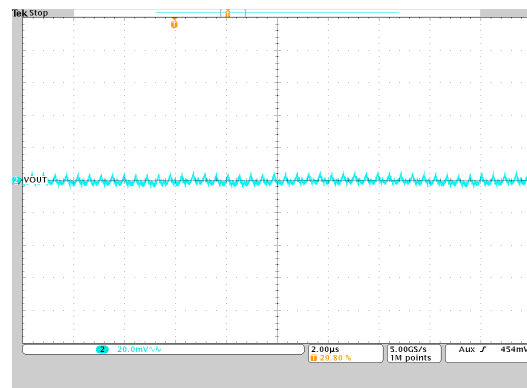

$V_{OUT} = 3.3\text{ V}$ PWM $T_A = 25^\circ\text{C}$
 $V_{IN} = 5\text{ V}$ $I_{OUT} = 2\text{ A}$

Figure 9-43. Output Voltage Ripple

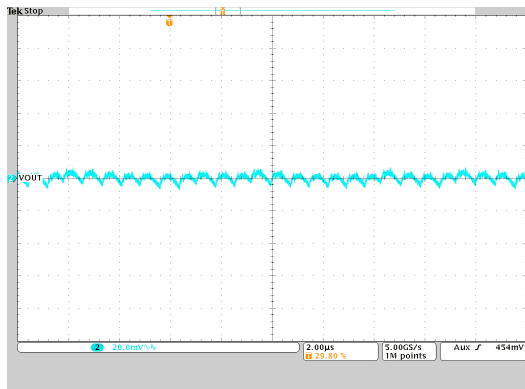

$V_{OUT} = 1.8\text{ V}$ PFM $T_A = 25^\circ\text{C}$
 $V_{IN} = 5\text{ V}$ $I_{OUT} = 0.2\text{ A}$

Figure 9-44. Output Voltage Ripple

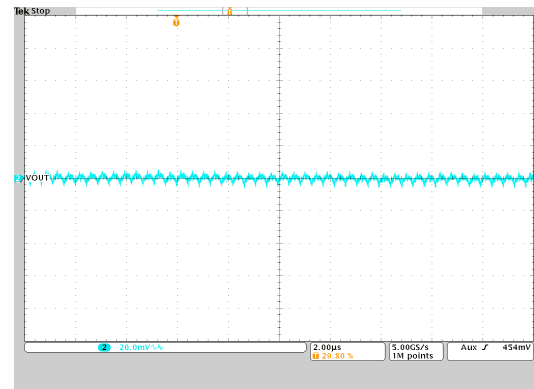

$V_{OUT} = 1.8\text{ V}$ PWM $T_A = 25^\circ\text{C}$
 $V_{IN} = 5\text{ V}$ $I_{OUT} = 2\text{ A}$

Figure 9-45. Output Voltage Ripple

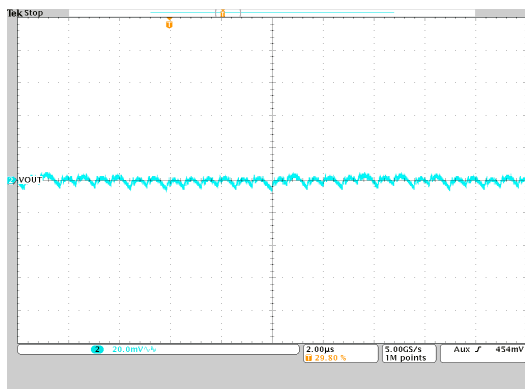

$V_{OUT} = 1.2\text{ V}$ PFM $T_A = 25^\circ\text{C}$
 $V_{IN} = 5\text{ V}$ $I_{OUT} = 0.2\text{ A}$

Figure 9-46. Output Voltage Ripple

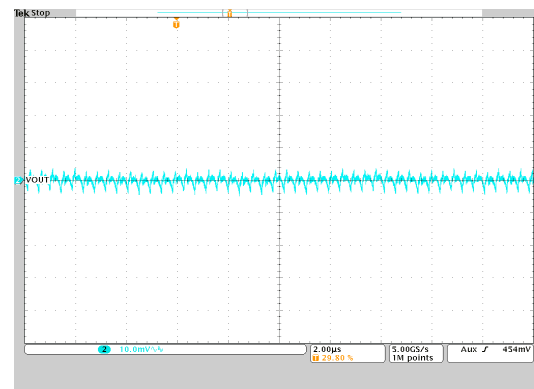

$V_{OUT} = 1.2\text{ V}$ PWM $T_A = 25^\circ\text{C}$
 $V_{IN} = 5\text{ V}$ $I_{OUT} = 2\text{ A}$

Figure 9-47. Output Voltage Ripple

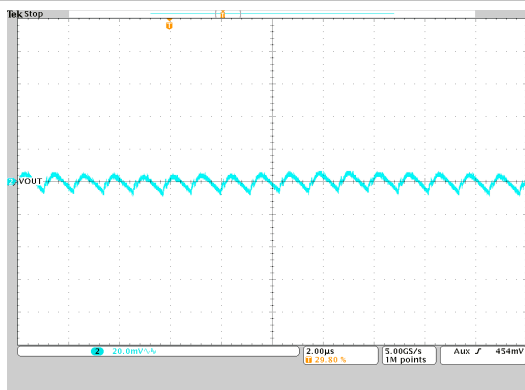

$V_{OUT} = 1.0\text{ V}$ PFM $T_A = 25^\circ\text{C}$
 $V_{IN} = 5\text{ V}$ $I_{OUT} = 0.2\text{ A}$

Figure 9-48. Output Voltage Ripple

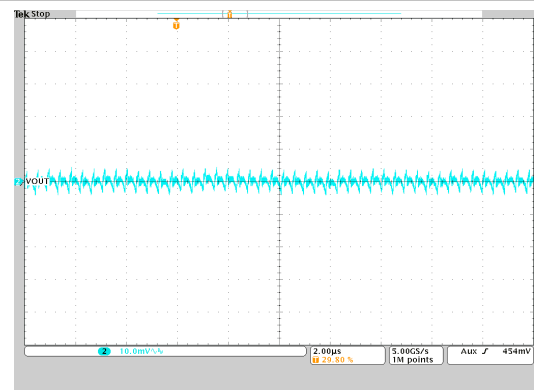

$V_{OUT} = 1.0\text{ V}$ PWM $T_A = 25^\circ\text{C}$
 $V_{IN} = 5\text{ V}$ $I_{OUT} = 2\text{ A}$

Figure 9-49. Output Voltage Ripple

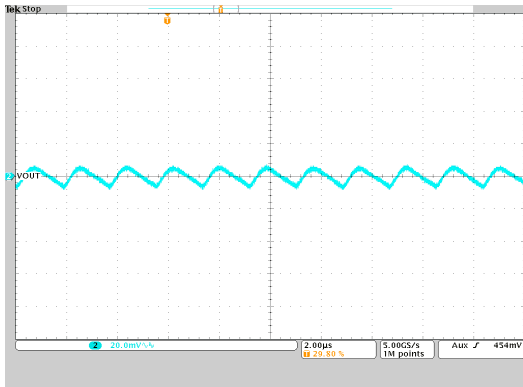

$V_{OUT} = 0.6\text{ V}$ PFM $T_A = 25^\circ\text{C}$
 $V_{IN} = 3.3\text{ V}$ $I_{OUT} = 0.2\text{ A}$

Figure 9-50. Output Voltage Ripple

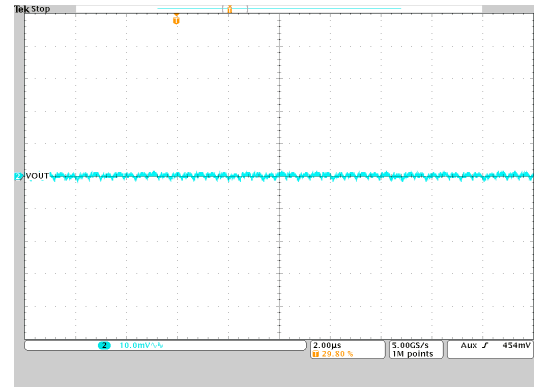

$V_{OUT} = 0.6\text{ V}$ PWM $T_A = 25^\circ\text{C}$
 $V_{IN} = 3.3\text{ V}$ $I_{OUT} = 2\text{ A}$

Figure 9-51. Output Voltage Ripple

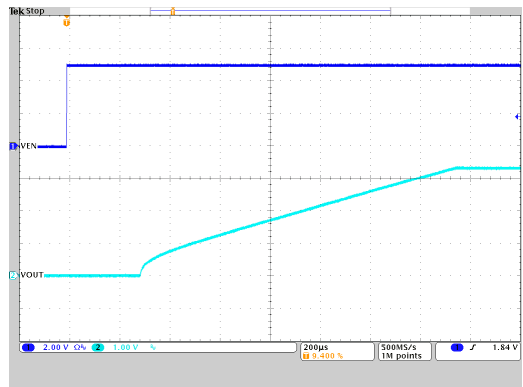

$V_{OUT} = 3.3\text{ V}$ PWM or PFM $T_A = 25^\circ\text{C}$
 $V_{IN} = 5\text{ V}$ $I_{OUT} = 2\text{ A}$

Figure 9-52. Start-Up Timing

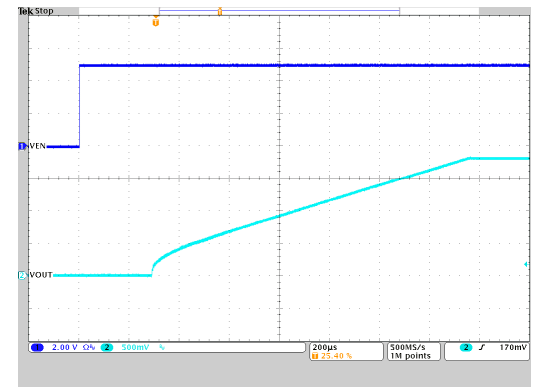

$V_{OUT} = 1.8\text{ V}$ PWM or PFM $T_A = 25^\circ\text{C}$
 $V_{IN} = 5\text{ V}$ $I_{OUT} = 2\text{ A}$

Figure 9-53. Start-Up Timing

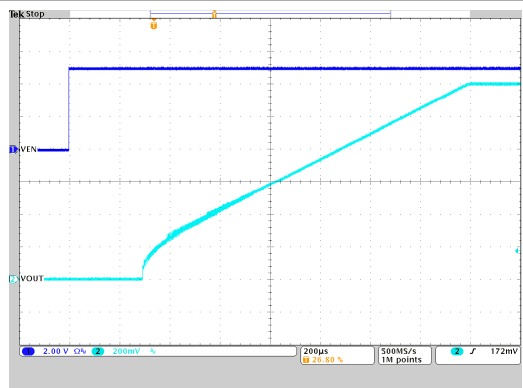

$V_{OUT} = 1.2\text{ V}$ PWM or PFM $T_A = 25^\circ\text{C}$
 $V_{IN} = 5\text{ V}$ $I_{OUT} = 2\text{ A}$

Figure 9-54. Start-Up Timing

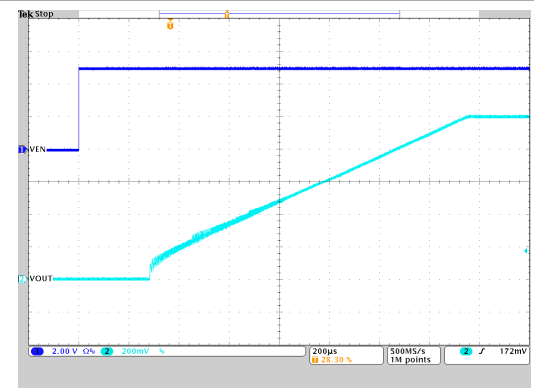

$V_{OUT} = 1.0\text{ V}$ PWM or PFM $T_A = 25^\circ\text{C}$
 $V_{IN} = 5\text{ V}$ $I_{OUT} = 2\text{ A}$

Figure 9-55. Start-Up Timing

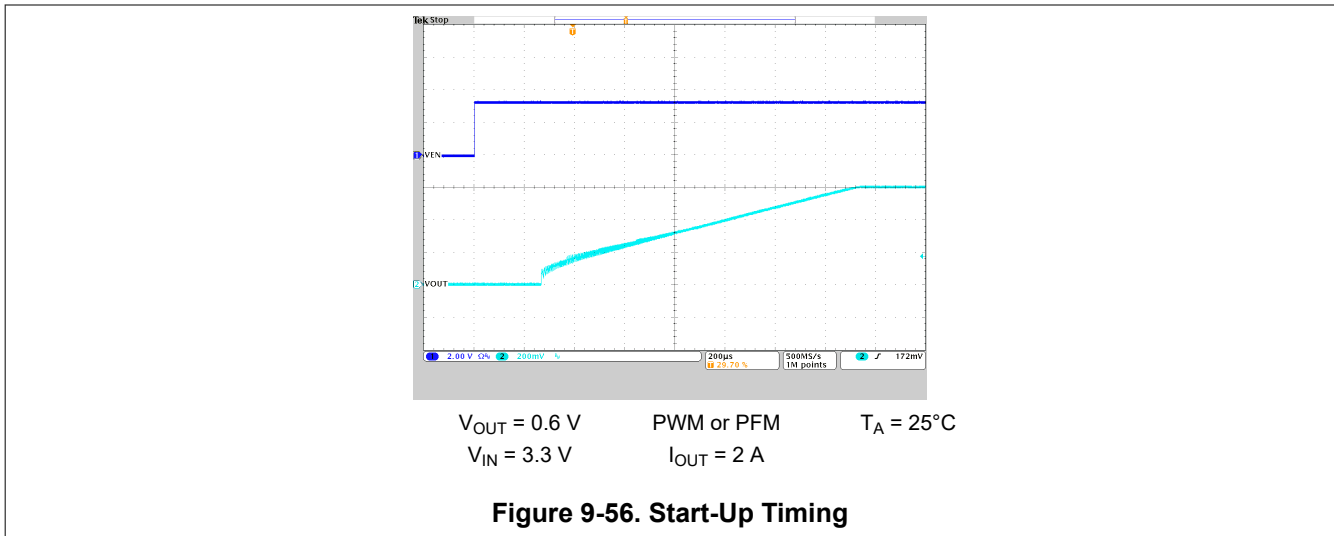

9.3 System Examples

9.3.1 Fixed Output Voltage Versions

Versions with an internally fixed output voltage allow you to remove the external feedback voltage divider. This action not only allows reduction of the total design size, but also provides higher accuracy as there is no additional error caused by the external resistor divider. The FB pin must be tied to the output voltage directly as shown in Figure 9-57. The application runs with an internally defined switching frequency of 2.25 MHz by connecting COMP/FSET to GND.

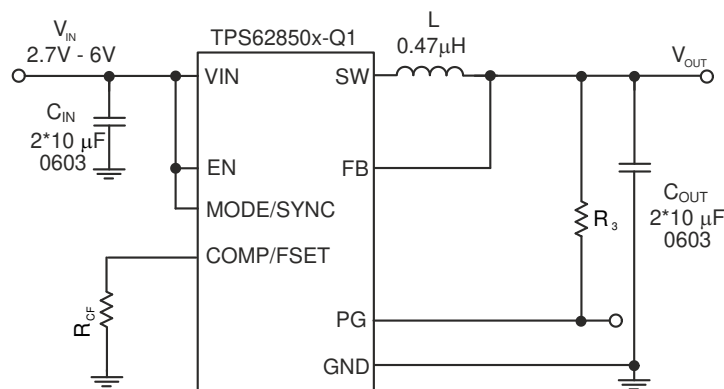

Figure 9-57. Schematic for Fixed Output Voltage Versions

9.3.2 Synchronizing to an External Clock

The TPS62850x-Q1 can be externally synchronized by applying an external clock on the MODE/SYNC pin. There is no need for any additional circuitry as long as the input signal meets the requirements given in the electrical specifications. The clock can be applied or removed during operation, allowing you to switch from an externally defined fixed frequency to power-save mode or to internal fixed frequency operation.

The value of the R_{CF} resistor must be chosen such that the internally defined frequency and the externally applied frequency are close to each other. This action makes sure of a smooth transition from internal to external frequency and vice versa.

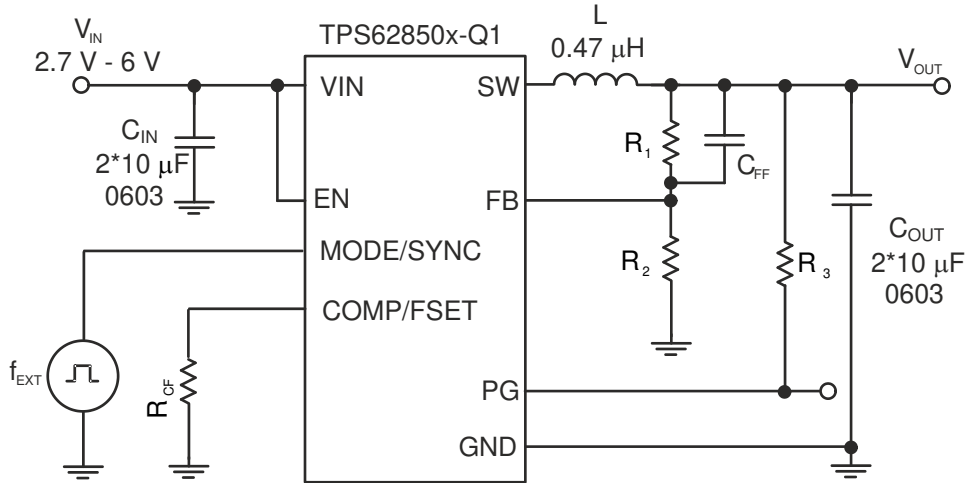

Figure 9-58. Schematic using External Synchronization

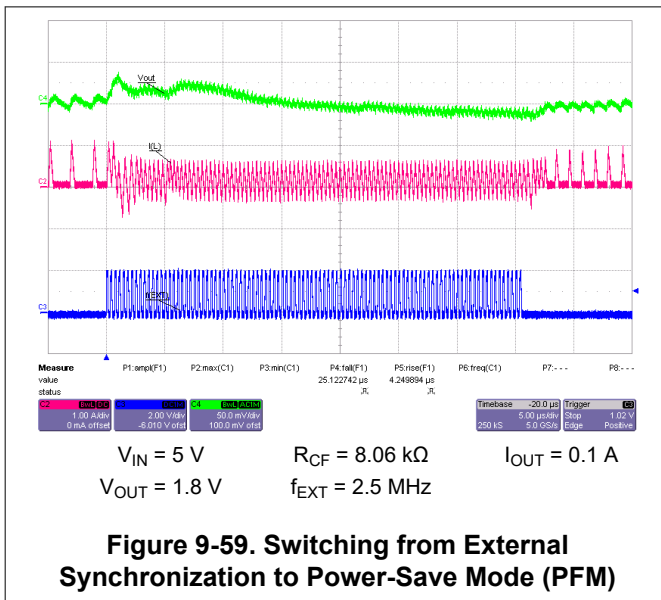

Figure 9-59. Switching from External Synchronization to Power-Save Mode (PFM)

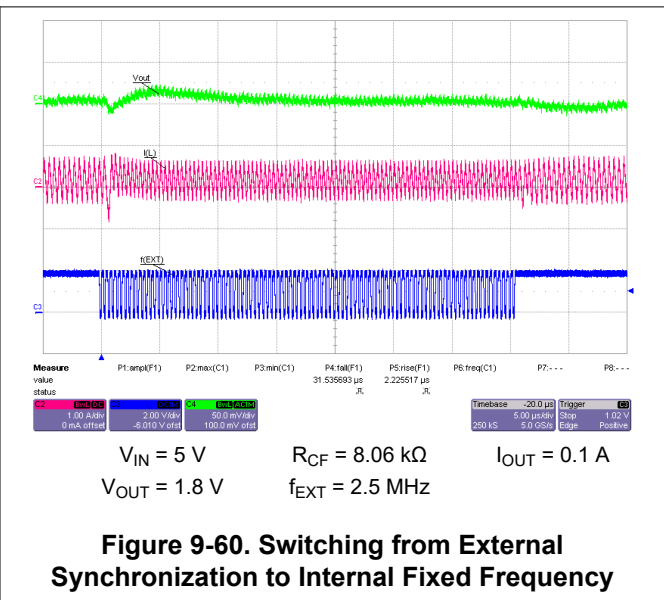

Figure 9-60. Switching from External Synchronization to Internal Fixed Frequency

9.4 Power Supply Recommendations

The TPS62850x-Q1 device family does not have special requirements for the input power supply. The output current of the input power supply must be rated according to the supply voltage, output voltage, and output current of the TPS62850x-Q1.

9.5 Layout

9.5.1 Layout Guidelines

A proper layout is critical for the operation of a switched mode power supply, even more at high switching frequencies. Therefore, the PCB layout of the TPS62850x-Q1 demands careful attention to make sure of operation and to get the performance specified. A poor layout can lead to issues like poor regulation (both in [Layout Example](#) and load), stability and accuracy weaknesses, increased EMI radiation, and noise sensitivity.

See for the recommended layout of the TPS62850x-Q1, which is designed for common external ground connections. The input capacitor must be placed as close as possible between the VIN and GND pin.

Provide low inductive and resistive paths for loops with high di/dt. Therefore, paths conducting the switched load current must be as short and wide as possible. Provide low capacitive paths (with respect to all other nodes)

for wires with high dv/dt . Therefore, the input and output capacitance must be placed as close as possible to the IC pins and parallel wiring over long distances and narrow traces must be avoided. Loops which conduct an alternating current must outline an area as small as possible, as this area is proportional to the energy radiated.

Sensitive nodes like FB must be connected with short wires and not nearby high dv/dt signals (for example, SW). As sensitive nodes carry information about the output voltage, sensitive nodes must be connected as close as possible to the actual output voltage (at the output capacitor). The FB resistors, R_1 and R_2 , must be kept close to the IC and be connected directly to the pin and the system ground plane.

The package uses the pins for power dissipation. Thermal vias on the VIN and GND pins help to spread the heat into the pcb.

The recommended layout is implemented on the EVM and shown in the [TPS628502EVM-092 Evaluation Module user's guide](#).

9.5.2 Layout Example

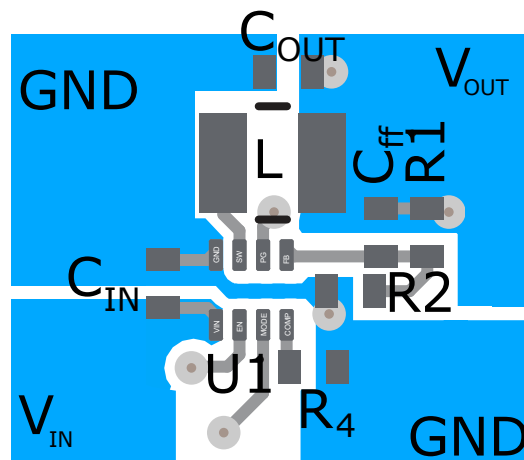

Figure 9-61. Example Layout

10 Device and Documentation Support

10.1 Device Support

10.1.1 Third-Party Products Disclaimer

TI'S PUBLICATION OF INFORMATION REGARDING THIRD-PARTY PRODUCTS OR SERVICES DOES NOT CONSTITUTE AN ENDORSEMENT REGARDING THE SUITABILITY OF SUCH PRODUCTS OR SERVICES OR A WARRANTY, REPRESENTATION OR ENDORSEMENT OF SUCH PRODUCTS OR SERVICES, EITHER ALONE OR IN COMBINATION WITH ANY TI PRODUCT OR SERVICE.

10.2 Documentation Support

10.2.1 Related Documentation

For related documentation, see the following:

Texas Instruments, [TPS628502EVM-092 Evaluation Module user's guide](#)

10.3 Receiving Notification of Documentation Updates

To receive notification of documentation updates, navigate to the device product folder on [ti.com](#). Click on *Notifications* to register and receive a weekly digest of any product information that has changed. For change details, review the revision history included in any revised document.

10.4 Support Resources

[TI E2E™ support forums](#) are an engineer's go-to source for fast, verified answers and design help — straight from the experts. Search existing answers or ask your own question to get the quick design help you need.

Linked content is provided "AS IS" by the respective contributors. They do not constitute TI specifications and do not necessarily reflect TI's views; see TI's [Terms of Use](#).

10.5 Trademarks

TI E2E™ is a trademark of Texas Instruments.

All trademarks are the property of their respective owners.

10.6 Electrostatic Discharge Caution



This integrated circuit can be damaged by ESD. Texas Instruments recommends that all integrated circuits be handled with appropriate precautions. Failure to observe proper handling and installation procedures can cause damage.

ESD damage can range from subtle performance degradation to complete device failure. Precision integrated circuits may be more susceptible to damage because very small parametric changes could cause the device not to meet its published specifications.

10.7 Glossary

[TI Glossary](#) This glossary lists and explains terms, acronyms, and definitions.

11 Revision History

NOTE: Page numbers for previous revisions may differ from page numbers in the current version.

Changes from Revision M (September 2025) to Revision N (January 2026) Page

- Deleted preview note from TPS62850208QDRLRQ1 and TPS628502F0QDRLRQ1.....3
-

Changes from Revision L (July 2025) to Revision M (September 2025) Page

- Added TPS62850208QDRLRQ1.....3
 - Deleted preview note from TPS628501H9QDRLRQ1.....3
-

12 Mechanical, Packaging, and Orderable Information

The following pages include mechanical, packaging, and orderable information. This information is the most current data available for the designated devices. This data is subject to change without notice and revision of this document. For browser-based versions of this data sheet, refer to the left-hand navigation.

PACKAGING INFORMATION

Orderable part number	Status (1)	Material type (2)	Package Pins	Package qty Carrier	RoHS (3)	Lead finish/ Ball material (4)	MSL rating/ Peak reflow (5)	Op temp (°C)	Part marking (6)
TPS6285010MQDRLRQ1	Active	Production	SOT-5X3 (DRL) 8	4000 LARGE T&R	Yes	Call TI Sn	Level-1-260C-UNLIM	-40 to 125	10MQ
TPS6285010MQDRLRQ1.A	Active	Production	SOT-5X3 (DRL) 8	4000 LARGE T&R	Yes	SN	Level-1-260C-UNLIM	-40 to 125	10MQ
TPS6285010MQDRLRQ1.B	Active	Production	SOT-5X3 (DRL) 8	4000 LARGE T&R	-	Call TI	Call TI	-40 to 125	
TPS6285010MQDYCRQ1	Active	Production	SOT-5X3 (DYC) 8	4000 LARGE T&R	Yes	Call TI Sn	Level-2-260C-1 YEAR	-40 to 125	10MQ
TPS6285010MQDYCRQ1.A	Active	Production	SOT-5X3 (DYC) 8	4000 LARGE T&R	Yes	SN	Level-2-260C-1 YEAR	-40 to 125	10MQ
TPS6285011HQDRLRQ1	Active	Production	SOT-5X3 (DRL) 8	4000 LARGE T&R	Yes	Call TI Sn	Level-2-260C-1 YEAR	-40 to 125	11HQ
TPS6285011HQDRLRQ1.A	Active	Production	SOT-5X3 (DRL) 8	4000 LARGE T&R	Yes	SN	Level-2-260C-1 YEAR	-40 to 125	11HQ
TPS6285011HQDRLRQ1.B	Active	Production	SOT-5X3 (DRL) 8	4000 LARGE T&R	-	Call TI	Call TI	-40 to 125	
TPS62850120QDRLRQ1	Active	Production	SOT-5X3 (DRL) 8	4000 LARGE T&R	Yes	Call TI Sn	Level-1-260C-UNLIM	-40 to 125	120Q
TPS62850120QDRLRQ1.A	Active	Production	SOT-5X3 (DRL) 8	4000 LARGE T&R	Yes	SN	Level-1-260C-UNLIM	-40 to 125	120Q
TPS62850140QDYCRQ1	Active	Production	SOT-5X3 (DYC) 8	4000 LARGE T&R	Yes	Call TI Sn	Level-2-260C-1 YEAR	-40 to 125	140Q
TPS62850140QDYCRQ1.A	Active	Production	SOT-5X3 (DYC) 8	4000 LARGE T&R	Yes	SN	Level-2-260C-1 YEAR	-40 to 125	140Q
TPS6285018AQDRLRQ1	Active	Production	SOT-5X3 (DRL) 8	4000 LARGE T&R	Yes	Call TI Sn	Level-1-260C-UNLIM	-40 to 125	18AQ
TPS6285018AQDRLRQ1.A	Active	Production	SOT-5X3 (DRL) 8	4000 LARGE T&R	Yes	SN	Level-1-260C-UNLIM	-40 to 125	18AQ
TPS6285018AQDRLRQ1.B	Active	Production	SOT-5X3 (DRL) 8	4000 LARGE T&R	-	Call TI	Call TI	-40 to 125	
TPS628501B0QDRLRQ1	Active	Production	SOT-5X3 (DRL) 8	4000 LARGE T&R	Yes	Call TI Sn	Level-1-260C-UNLIM	-40 to 125	10BQ
TPS628501B0QDRLRQ1.A	Active	Production	SOT-5X3 (DRL) 8	4000 LARGE T&R	Yes	SN	Level-1-260C-UNLIM	-40 to 125	10BQ
TPS628501B0QDRLRQ1.B	Active	Production	SOT-5X3 (DRL) 8	4000 LARGE T&R	-	Call TI	Call TI	-40 to 125	
TPS628501F0QDRLRQ1	Active	Production	SOT-5X3 (DRL) 8	4000 LARGE T&R	Yes	SN	Level-1-260C-UNLIM	-40 to 125	3R5F
TPS628501H9QDRLRQ1	Active	Production	SOT-5X3 (DRL) 8	4000 LARGE T&R	Yes	SN	Level-1-260C-UNLIM	-40 to 125	3S4F
TPS628501QDRLRQ1	Active	Production	SOT-5X3 (DRL) 8	4000 LARGE T&R	Yes	Call TI Sn	Level-1-260C-UNLIM	-40 to 125	100Q
TPS628501QDRLRQ1.A	Active	Production	SOT-5X3 (DRL) 8	4000 LARGE T&R	Yes	SN	Level-1-260C-UNLIM	-40 to 125	100Q
TPS62850208QDRLRQ1	Active	Production	SOT-5X3 (DRL) 8	4000 LARGE T&R	Yes	SN	Level-1-260C-UNLIM	-40 to 150	41RF
TPS6285020AQDRLRQ1	Active	Production	SOT-5X3 (DRL) 8	4000 LARGE T&R	Yes	Call TI Sn	Level-1-260C-UNLIM	-40 to 125	20AQ
TPS6285020AQDRLRQ1.A	Active	Production	SOT-5X3 (DRL) 8	4000 LARGE T&R	Yes	SN	Level-1-260C-UNLIM	-40 to 125	20AQ
TPS6285020AQDRLRQ1.B	Active	Production	SOT-5X3 (DRL) 8	4000 LARGE T&R	-	Call TI	Call TI	-40 to 150	
TPS6285020MQDRLRQ1	Active	Production	SOT-5X3 (DRL) 8	4000 LARGE T&R	Yes	Call TI Sn	Level-1-260C-UNLIM	-40 to 125	20MQ
TPS6285020MQDRLRQ1.A	Active	Production	SOT-5X3 (DRL) 8	4000 LARGE T&R	Yes	SN	Level-1-260C-UNLIM	-40 to 125	20MQ
TPS6285021HQDRLRQ1	Active	Production	SOT-5X3 (DRL) 8	4000 LARGE T&R	Yes	Call TI Sn	Level-1-260C-UNLIM	-40 to 150	21HQ

Orderable part number	Status (1)	Material type (2)	Package Pins	Package qty Carrier	RoHS (3)	Lead finish/ Ball material (4)	MSL rating/ Peak reflow (5)	Op temp (°C)	Part marking (6)
TPS6285021HQDRLRQ1.A	Active	Production	SOT-5X3 (DRL) 8	4000 LARGE T&R	Yes	SN	Level-1-260C-UNLIM	-40 to 150	21HQ
TPS6285021HQDRLRQ1.B	Active	Production	SOT-5X3 (DRL) 8	4000 LARGE T&R	-	Call TI	Call TI	-40 to 150	
TPS62850220QDRLRQ1	Active	Production	SOT-5X3 (DRL) 8	4000 LARGE T&R	Yes	Call TI Sn	Level-1-260C-UNLIM	-40 to 125	220Q
TPS62850220QDRLRQ1.A	Active	Production	SOT-5X3 (DRL) 8	4000 LARGE T&R	Yes	SN	Level-1-260C-UNLIM	-40 to 125	220Q
TPS62850220QDRLRQ1.B	Active	Production	SOT-5X3 (DRL) 8	4000 LARGE T&R	-	Call TI	Call TI	-40 to 150	
TPS62850240QDRLRQ1	Active	Production	SOT-5X3 (DRL) 8	4000 LARGE T&R	Yes	Call TI Sn	Level-1-260C-UNLIM	-40 to 150	240Q
TPS62850240QDRLRQ1.A	Active	Production	SOT-5X3 (DRL) 8	4000 LARGE T&R	Yes	SN	Level-1-260C-UNLIM	-40 to 150	240Q
TPS62850240QDYCRQ1	Active	Production	SOT-5X3 (DYC) 8	4000 LARGE T&R	Yes	Call TI Sn	Level-2-260C-1 YEAR	-40 to 125	240Q
TPS62850240QDYCRQ1.A	Active	Production	SOT-5X3 (DYC) 8	4000 LARGE T&R	Yes	SN	Level-2-260C-1 YEAR	-40 to 125	240Q
TPS628502F0QDRLRQ1	Active	Production	null (null)	4000 LARGE T&R	Yes	SN	Level-1-260C-UNLIM	-40 to 150	3S3F
TPS628502QDRLRQ1	Active	Production	SOT-5X3 (DRL) 8	4000 LARGE T&R	Yes	Call TI Sn	Level-1-260C-UNLIM	-40 to 125	200Q
TPS628502QDRLRQ1.A	Active	Production	SOT-5X3 (DRL) 8	4000 LARGE T&R	Yes	SN	Level-1-260C-UNLIM	-40 to 125	200Q
TPS628503QDRLRQ1	Active	Production	SOT-5X3 (DRL) 8	4000 LARGE T&R	Yes	Call TI Sn	Level-1-260C-UNLIM	-40 to 125	300Q
TPS628503QDRLRQ1.A	Active	Production	SOT-5X3 (DRL) 8	4000 LARGE T&R	Yes	SN	Level-1-260C-UNLIM	-40 to 125	300Q

(1) **Status:** For more details on status, see our [product life cycle](#).

(2) **Material type:** When designated, preproduction parts are prototypes/experimental devices, and are not yet approved or released for full production. Testing and final process, including without limitation quality assurance, reliability performance testing, and/or process qualification, may not yet be complete, and this item is subject to further changes or possible discontinuation. If available for ordering, purchases will be subject to an additional waiver at checkout, and are intended for early internal evaluation purposes only. These items are sold without warranties of any kind.

(3) **RoHS values:** Yes, No, RoHS Exempt. See the [TI RoHS Statement](#) for additional information and value definition.

(4) **Lead finish/Ball material:** Parts may have multiple material finish options. Finish options are separated by a vertical ruled line. Lead finish/Ball material values may wrap to two lines if the finish value exceeds the maximum column width.

(5) **MSL rating/Peak reflow:** The moisture sensitivity level ratings and peak solder (reflow) temperatures. In the event that a part has multiple moisture sensitivity ratings, only the lowest level per JEDEC standards is shown. Refer to the shipping label for the actual reflow temperature that will be used to mount the part to the printed circuit board.

(6) **Part marking:** There may be an additional marking, which relates to the logo, the lot trace code information, or the environmental category of the part.

Multiple part markings will be inside parentheses. Only one part marking contained in parentheses and separated by a "-" will appear on a part. If a line is indented then it is a continuation of the previous line and the two combined represent the entire part marking for that device.

Important Information and Disclaimer: The information provided on this page represents TI's knowledge and belief as of the date that it is provided. TI bases its knowledge and belief on information provided by third parties, and makes no representation or warranty as to the accuracy of such information. Efforts are underway to better integrate information from third parties. TI has taken and continues to take reasonable steps to provide representative and accurate information but may not have conducted destructive testing or chemical analysis on incoming materials and chemicals. TI and TI suppliers consider certain information to be proprietary, and thus CAS numbers and other limited information may not be available for release.

In no event shall TI's liability arising out of such information exceed the total purchase price of the TI part(s) at issue in this document sold by TI to Customer on an annual basis.

OTHER QUALIFIED VERSIONS OF TPS628501-Q1, TPS628502-Q1, TPS628503-Q1 :

- Catalog : [TPS628501](#), [TPS628502](#), [TPS628503](#)

NOTE: Qualified Version Definitions:

- Catalog - TI's standard catalog product

TAPE AND REEL INFORMATION

QUADRANT ASSIGNMENTS FOR PIN 1 ORIENTATION IN TAPE

*All dimensions are nominal

Device	Package Type	Package Drawing	Pins	SPQ	Reel Diameter (mm)	Reel Width W1 (mm)	A0 (mm)	B0 (mm)	K0 (mm)	P1 (mm)	W (mm)	Pin1 Quadrant
TPS6285010MQDRLRQ1	SOT-5X3	DRL	8	4000	180.0	8.4	2.75	1.9	0.8	4.0	8.0	Q3
TPS6285010MQDYCRQ1	SOT-5X3	DYC	8	4000	180.0	8.4	2.75	1.9	0.8	4.0	8.0	Q3
TPS6285011HQDRLRQ1	SOT-5X3	DRL	8	4000	180.0	8.4	2.75	1.9	0.8	4.0	8.0	Q3
TPS62850120QDRLRQ1	SOT-5X3	DRL	8	4000	180.0	8.4	2.75	1.9	0.8	4.0	8.0	Q3
TPS62850140QDYCRQ1	SOT-5X3	DYC	8	4000	180.0	8.4	2.75	1.9	0.8	4.0	8.0	Q3
TPS6285018AQDRLRQ1	SOT-5X3	DRL	8	4000	180.0	8.4	2.75	1.9	0.8	4.0	8.0	Q3
TPS628501B0QDRLRQ1	SOT-5X3	DRL	8	4000	180.0	8.4	2.75	1.9	0.8	4.0	8.0	Q3
TPS628501F0QDRLRQ1	SOT-5X3	DRL	8	4000	180.0	8.4	2.75	1.9	0.8	4.0	8.0	Q3
TPS628501H9QDRLRQ1	SOT-5X3	DRL	8	4000	180.0	8.4	2.75	1.9	0.8	4.0	8.0	Q3
TPS628501QDRLRQ1	SOT-5X3	DRL	8	4000	180.0	8.4	2.75	1.9	0.8	4.0	8.0	Q3
TPS62850208QDRLRQ1	SOT-5X3	DRL	8	4000	180.0	8.4	2.75	1.9	0.8	4.0	8.0	Q3
TPS6285020AQDRLRQ1	SOT-5X3	DRL	8	4000	180.0	8.4	2.75	1.9	0.8	4.0	8.0	Q3
TPS6285020MQDRLRQ1	SOT-5X3	DRL	8	4000	180.0	8.4	2.75	1.9	0.8	4.0	8.0	Q3
TPS6285021HQDRLRQ1	SOT-5X3	DRL	8	4000	180.0	8.4	2.75	1.9	0.8	4.0	8.0	Q3
TPS62850220QDRLRQ1	SOT-5X3	DRL	8	4000	180.0	8.4	2.75	1.9	0.8	4.0	8.0	Q3
TPS62850240QDRLRQ1	SOT-5X3	DRL	8	4000	180.0	8.4	2.75	1.9	0.8	4.0	8.0	Q3

Device	Package Type	Package Drawing	Pins	SPQ	Reel Diameter (mm)	Reel Width W1 (mm)	A0 (mm)	B0 (mm)	K0 (mm)	P1 (mm)	W (mm)	Pin1 Quadrant
TPS62850240QDYCRQ1	SOT-5X3	DYC	8	4000	180.0	8.4	2.75	1.9	0.8	4.0	8.0	Q3
TPS628502QDRLRQ1	SOT-5X3	DRL	8	4000	180.0	8.4	2.75	1.9	0.8	4.0	8.0	Q3
TPS628503QDRLRQ1	SOT-5X3	DRL	8	4000	180.0	8.4	2.75	1.9	0.8	4.0	8.0	Q3

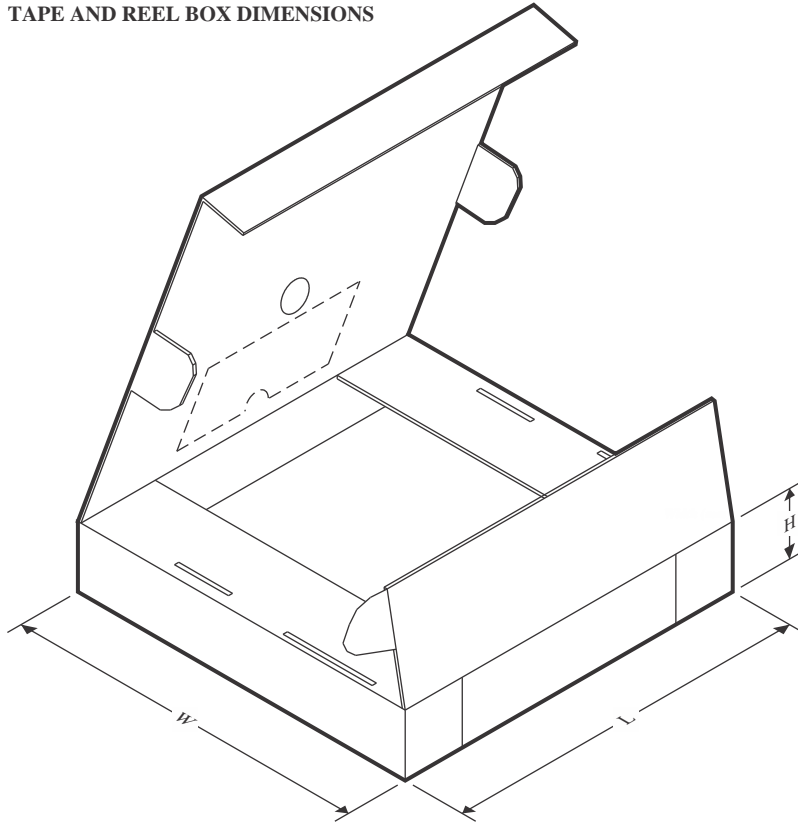
TAPE AND REEL BOX DIMENSIONS

*All dimensions are nominal

Device	Package Type	Package Drawing	Pins	SPQ	Length (mm)	Width (mm)	Height (mm)
TPS6285010MQDRLRQ1	SOT-5X3	DRL	8	4000	210.0	185.0	35.0
TPS6285010MQDYCRQ1	SOT-5X3	DYC	8	4000	210.0	185.0	35.0
TPS6285011HQDRLRQ1	SOT-5X3	DRL	8	4000	210.0	185.0	35.0
TPS62850120QDRLRQ1	SOT-5X3	DRL	8	4000	210.0	185.0	35.0
TPS62850140QDYCRQ1	SOT-5X3	DYC	8	4000	210.0	185.0	35.0
TPS6285018AQDRLRQ1	SOT-5X3	DRL	8	4000	210.0	185.0	35.0
TPS628501B0QDRLRQ1	SOT-5X3	DRL	8	4000	210.0	185.0	35.0
TPS628501F0QDRLRQ1	SOT-5X3	DRL	8	4000	210.0	185.0	35.0
TPS628501H9QDRLRQ1	SOT-5X3	DRL	8	4000	210.0	185.0	35.0
TPS628501QDRLRQ1	SOT-5X3	DRL	8	4000	210.0	185.0	35.0
TPS62850208QDRLRQ1	SOT-5X3	DRL	8	4000	210.0	185.0	35.0
TPS6285020AQDRLRQ1	SOT-5X3	DRL	8	4000	210.0	185.0	35.0
TPS6285020MQDRLRQ1	SOT-5X3	DRL	8	4000	210.0	185.0	35.0
TPS6285021HQDRLRQ1	SOT-5X3	DRL	8	4000	210.0	185.0	35.0
TPS62850220QDRLRQ1	SOT-5X3	DRL	8	4000	210.0	185.0	35.0
TPS62850240QDRLRQ1	SOT-5X3	DRL	8	4000	210.0	185.0	35.0
TPS62850240QDYCRQ1	SOT-5X3	DYC	8	4000	210.0	185.0	35.0
TPS628502QDRLRQ1	SOT-5X3	DRL	8	4000	210.0	185.0	35.0

Device	Package Type	Package Drawing	Pins	SPQ	Length (mm)	Width (mm)	Height (mm)
TPS628503QDRLRQ1	SOT-5X3	DRL	8	4000	210.0	185.0	35.0

DYC0008A



PACKAGE OUTLINE

SOT - 0.6 mm max height

PLASTIC SMALL OUTLINE

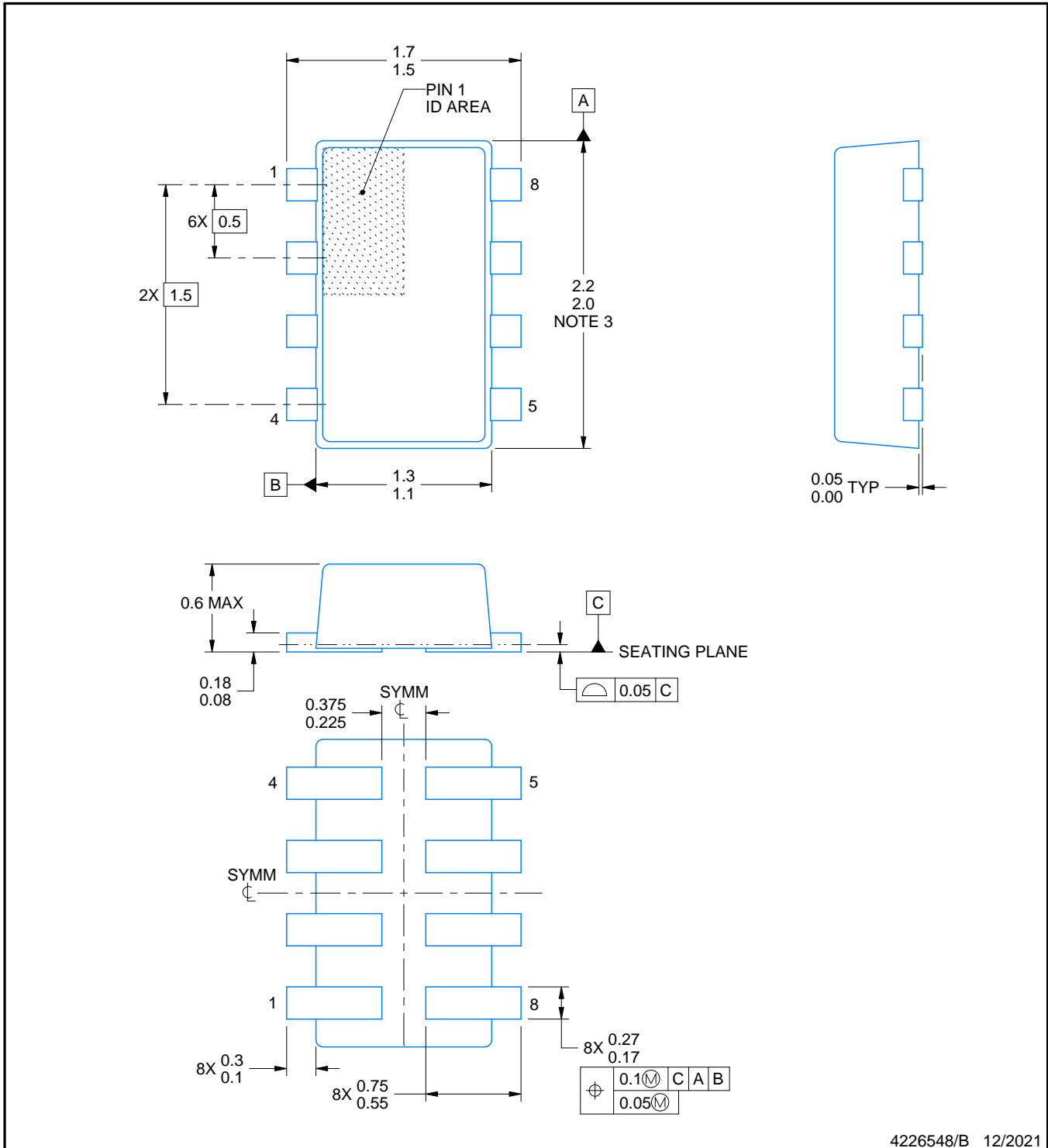

4226548/B 12/2021

NOTES:

1. All linear dimensions are in millimeters. Any dimensions in parenthesis are for reference only. Dimensioning and tolerancing per ASME Y14.5M.
2. This drawing is subject to change without notice.
3. This dimension does not include mold flash, protrusions, or gate burrs. Mold flash, protrusions, or gate burrs shall not exceed 0.15 mm per side.

EXAMPLE BOARD LAYOUT

DYC0008A

SOT - 0.6 mm max height

PLASTIC SMALL OUTLINE

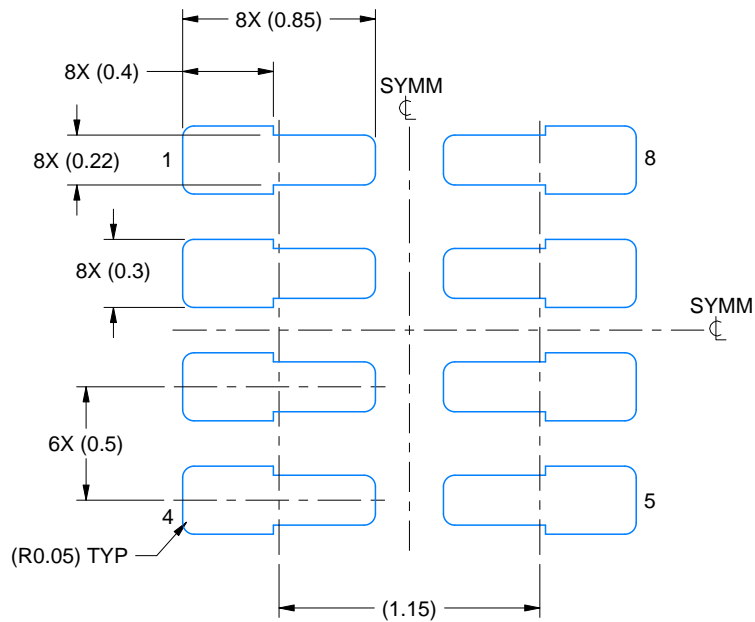

LAND PATTERN EXAMPLE
EXPOSED METAL SHOWN
SCALE:30X

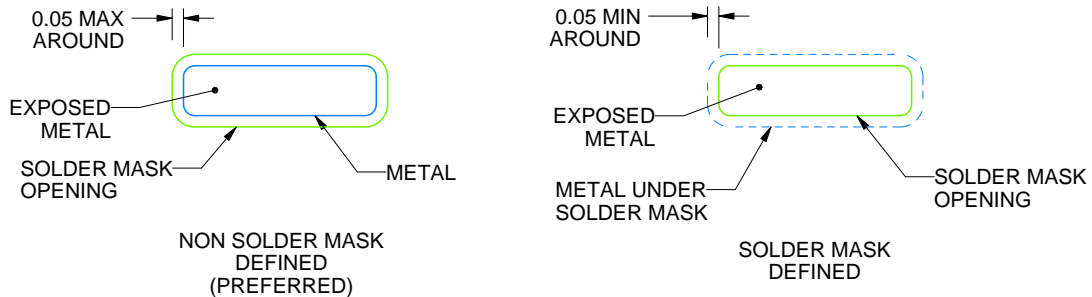

SOLDERMASK DETAILS

4226548/B 12/2021

NOTES: (continued)

- Publication IPC-7351 may have alternate designs.
- Solder mask tolerances between and around signal pads can vary based on board fabrication site.
- Land pattern design aligns to IPC-610, Bottom Termination Component (BTC) solder joint inspection criteria.

EXAMPLE STENCIL DESIGN

DYC0008A

SOT - 0.6 mm max height

PLASTIC SMALL OUTLINE

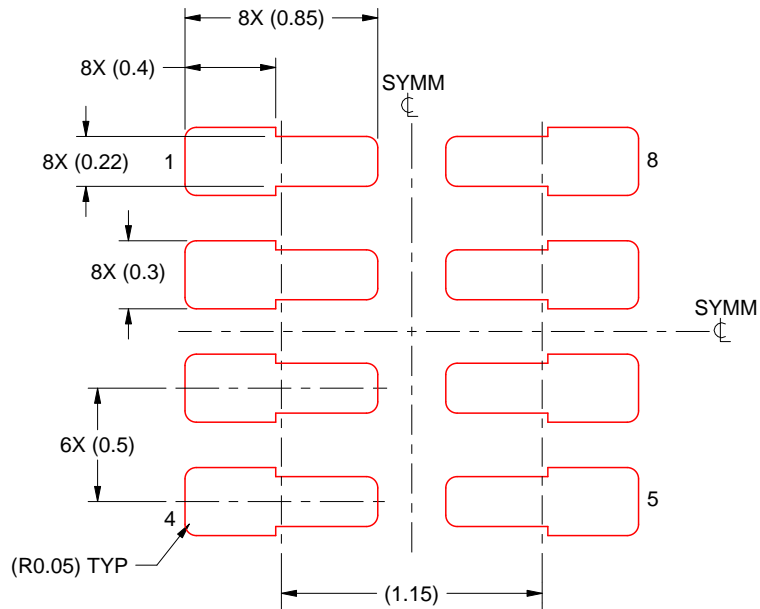

SOLDER PASTE EXAMPLE
BASED ON 0.1 mm THICK STENCIL
SCALE:30X

4226548/B 12/2021

NOTES: (continued)

7. Laser cutting apertures with trapezoidal walls and rounded corners may offer better paste release. IPC-7525 may have alternate design recommendations.
8. Board assembly site may have different recommendations for stencil design.

EXAMPLE BOARD LAYOUT

DRL0008A

SOT-5X3 - 0.6 mm max height

PLASTIC SMALL OUTLINE

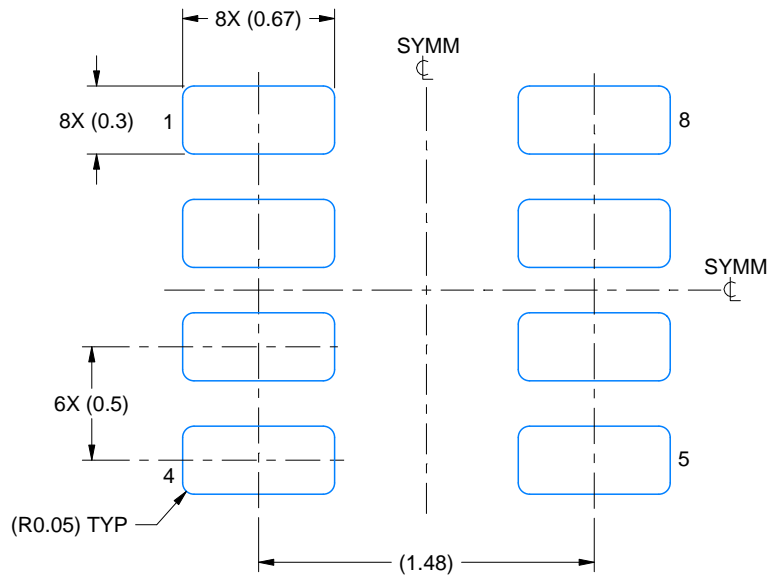

LAND PATTERN EXAMPLE
EXPOSED METAL SHOWN
SCALE:30X

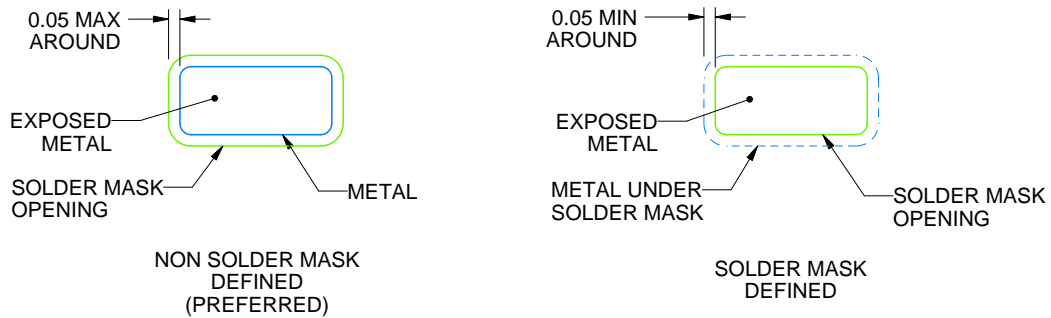

SOLDERMASK DETAILS

4224486/G 11/2024

NOTES: (continued)

5. Publication IPC-7351 may have alternate designs.
6. Solder mask tolerances between and around signal pads can vary based on board fabrication site.
7. Land pattern design aligns to IPC-610, Bottom Termination Component (BTC) solder joint inspection criteria.

EXAMPLE STENCIL DESIGN

DRL0008A

SOT-5X3 - 0.6 mm max height

PLASTIC SMALL OUTLINE

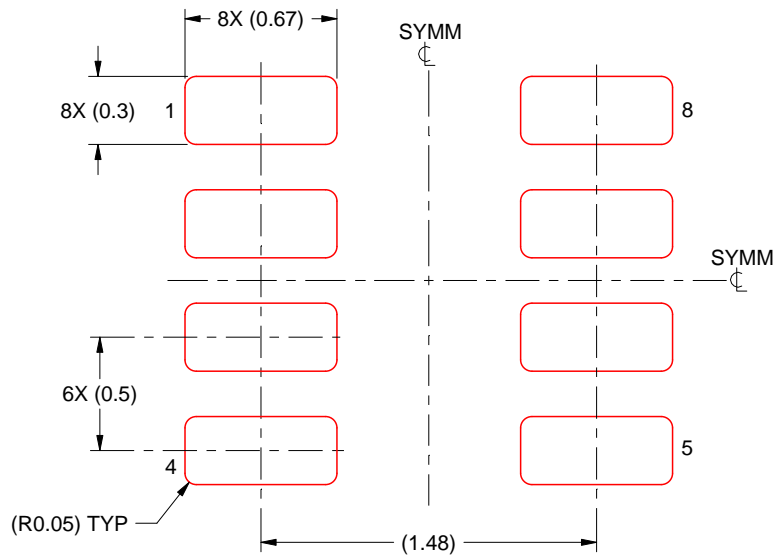

SOLDER PASTE EXAMPLE
BASED ON 0.1 mm THICK STENCIL
SCALE:30X

4224486/G 11/2024

NOTES: (continued)

8. Laser cutting apertures with trapezoidal walls and rounded corners may offer better paste release. IPC-7525 may have alternate design recommendations.
9. Board assembly site may have different recommendations for stencil design.

IMPORTANT NOTICE AND DISCLAIMER

TI PROVIDES TECHNICAL AND RELIABILITY DATA (INCLUDING DATASHEETS), DESIGN RESOURCES (INCLUDING REFERENCE DESIGNS), APPLICATION OR OTHER DESIGN ADVICE, WEB TOOLS, SAFETY INFORMATION, AND OTHER RESOURCES "AS IS" AND WITH ALL FAULTS, AND DISCLAIMS ALL WARRANTIES, EXPRESS AND IMPLIED, INCLUDING WITHOUT LIMITATION ANY IMPLIED WARRANTIES OF MERCHANTABILITY, FITNESS FOR A PARTICULAR PURPOSE OR NON-INFRINGEMENT OF THIRD PARTY INTELLECTUAL PROPERTY RIGHTS.

These resources are intended for skilled developers designing with TI products. You are solely responsible for (1) selecting the appropriate TI products for your application, (2) designing, validating and testing your application, and (3) ensuring your application meets applicable standards, and any other safety, security, regulatory or other requirements.

These resources are subject to change without notice. TI grants you permission to use these resources only for development of an application that uses the TI products described in the resource. Other reproduction and display of these resources is prohibited. No license is granted to any other TI intellectual property right or to any third party intellectual property right. TI disclaims responsibility for, and you fully indemnify TI and its representatives against any claims, damages, costs, losses, and liabilities arising out of your use of these resources.

TI's products are provided subject to [TI's Terms of Sale](#), [TI's General Quality Guidelines](#), or other applicable terms available either on ti.com or provided in conjunction with such TI products. TI's provision of these resources does not expand or otherwise alter TI's applicable warranties or warranty disclaimers for TI products. Unless TI explicitly designates a product as custom or customer-specified, TI products are standard, catalog, general purpose devices.

TI objects to and rejects any additional or different terms you may propose.

Copyright © 2026, Texas Instruments Incorporated

Last updated 10/2025