

# OPAx316 10-MHz, Low-Power, Low-Noise, RRIO, 1.8-V CMOS Operational Amplifier

## 1 Features

- Unity-Gain Bandwidth: 10 MHz
- Low I<sub>Q</sub>: 400 μA/ch
- Wide Supply Range: 1.8 V to 5.5 V
- Low Noise: 11 nV/√Hz at 1 kHz
- Low Input Bias Current: ±5 pA
- Offset Voltage: ±0.5 mV
- Unity-Gain Stable
- Internal RFI-EMI Filter
- Shutdown Version: OPA2316S
- Extended Temperature Range: –40°C to +125°C

## 2 Applications

- Battery-Powered Instruments:
  - Consumer, Industrial, Medical
  - Notebooks, Portable Media Players
- Sensor Signal Conditioning
- Automotive Applications
- Barcode Scanners
- Active Filters
- Audio

## 3 Description

The OPAx316 family of single, dual, and quad operational amplifiers represents a new generation of general-purpose, low-power operational amplifiers. Featuring rail-to-rail input and output swings, low quiescent current (400 μA/ch typical) combined with a wide bandwidth of 10 MHz and very-low noise (11 nV/√Hz at 1 kHz) makes this family attractive for a variety of applications that require a good balance between cost and performance. The low input bias current supports those operational amplifiers to be used in applications with MΩ source impedances.

The robust design of the OPAx316 provide ease-of-use to the circuit designer—a unity-gain stable, integrated RFI-EMI rejection filter, no phase reversal in overdrive condition, and high electrostatic discharge (ESD) protection (4-kV HBM).

These devices are optimized for low-voltage operation as low as 1.8 V (±0.9 V) and up to 5.5 V (±2.75 V). This latest addition of low-voltage CMOS operational amplifiers, in conjunction with the [OPAx313](#) and [OPAx314](#) provide a family of bandwidth, noise, and power options to meet the needs of a wide variety of applications.

### Device Information<sup>(1)</sup>

| PART NUMBER | PACKAGE          | BODY SIZE (NOM)   |
|-------------|------------------|-------------------|
| OPA316      | SC-70 (5)        | 1.25 mm × 2.00 mm |
|             | SOT-23 (5)       | 1.60 mm × 2.90 mm |
| OPA2316     | DFN (8)          | 3.00 mm × 3.00 mm |
|             | MSOP, VSSOP (8)  | 3.00 mm × 3.00 mm |
|             | SOIC (8)         | 3.91 mm × 4.90 mm |
| OPA2316S    | MSOP, VSSOP (10) | 3.00 mm × 3.00 mm |
|             | X2QFN (10)       | 1.50 mm × 2.00 mm |
| OPA4316     | TSSOP (14)       | 4.40 mm × 5.00 mm |
|             | SOIC (14)        | 8.65 mm × 3.91 mm |

(1) For all available packages, see the orderable addendum at the end of the data sheet.

Single-Pole, Low-Pass Filter

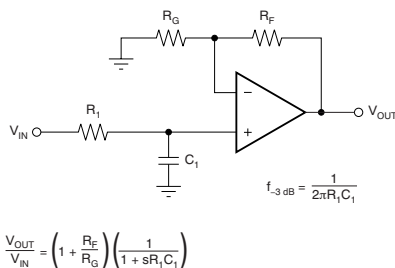

Low-Supply Current (400 μA/ch) for 10-MHz Bandwidth

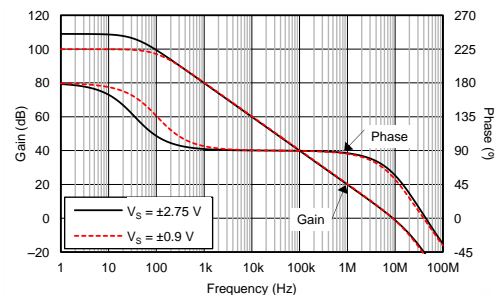

## Table of Contents

|  |           |  |           |
|--|-----------|--|-----------|
| <b>1 Features</b> .....                        | <b>1</b>  | 7.3 Feature Description .....                                    | 17        |
| <b>2 Applications</b> .....                    | <b>1</b>  | 7.4 Device Functional Modes .....                                | 20        |
| <b>3 Description</b> .....                     | <b>1</b>  | <b>8 Application and Implementation</b> .....                    | <b>21</b> |
| <b>4 Revision History</b> .....                | <b>2</b>  | 8.1 Application Information .....                                | 21        |
| <b>5 Pin Configuration and Functions</b> ..... | <b>4</b>  | 8.2 Typical Application .....                                    | 22        |
| <b>6 Specifications</b> .....                  | <b>6</b>  | <b>9 Power Supply Recommendations</b> .....                      | <b>25</b> |
| 6.1 Absolute Maximum Ratings .....             | 6         | <b>10 Layout</b> .....   | <b>26</b> |
| 6.2 ESD Ratings .....                          | 6         | 10.1 Layout Guidelines .....                                     | 26        |
| 6.3 Recommended Operating Conditions .....     | 6         | 10.2 Layout Example .....  | 26        |
| 6.4 Thermal Information: OPA316 .....          | 6         | <b>11 Device and Documentation Support</b> .....                 | <b>27</b> |
| 6.5 Thermal Information: OPA2316 .....         | 7         | 11.1 Documentation Support .....                                 | 27        |
| 6.6 Thermal Information: OPA2316S .....        | 7         | 11.2 Related Links .....   | 27        |
| 6.7 Thermal Information: OPA4316 .....         | 8         | 11.3 Receiving Notification of Documentation Updates .....       | 27        |
| 6.8 Electrical Characteristics .....           | 9         | 11.4 Community Resources .....                                   | 27        |
| 6.9 Typical Characteristics .....              | 11        | 11.5 Trademarks .....  | 27        |
| <b>7 Detailed Description</b> .....            | <b>17</b> | 11.6 Electrostatic Discharge Caution .....                       | 27        |
| 7.1 Overview .....                             | 17        | 11.7 Glossary .....  | 27        |
| 7.2 Functional Block Diagram .....             | 17        | <b>12 Mechanical, Packaging, and Orderable Information</b> ..... | <b>28</b> |

## 4 Revision History

NOTE: Page numbers for previous revisions may differ from page numbers in the current version.

| <b>Changes from Revision E (May 2016) to Revision F</b>                                    | <b>Page</b> |
|--|-------------|
| • Added SOIC (14) / OPA4316 body size information to <i>Device Information</i> table ..... | 1           |
| • Added D package to PW package pinout drawing .....                                       | 4           |
| • Added D (SOIC) thermal information to <i>Thermal Information: OPA4316</i> table .....    | 8           |

---

| <b>Changes from Revision D (December 2014) to Revision E</b> | <b>Page</b> |
|--|-------------|
| • Added new "RUG" package .....                              | 1           |

---

| <b>Changes from Revision C (October 2014) to Revision D</b>               | <b>Page</b> |
|---|-------------|
| • Added <i>Shutdown</i> section to Electrical Characteristics table ..... | 10          |
| • Added <i>Related Documentation</i> section .....                        | 27          |

---

| <b>Changes from Revision B (August 2014) to Revision C</b>              | <b>Page</b> |
|---|-------------|
| • Updated devices and packages in <i>Device Information</i> table ..... | 1           |
| • Added thermal information for OPA2316S and OPA4316 .....              | 7           |

---

| <b>Changes from Revision A (April 2014) to Revision B</b>                 | <b>Page</b> |
|---|-------------|
| • Added OPA2316 to the <i>Device Information</i> table .....              | 1           |
| • Added thermal information for OPA2316 .....                             | 7           |
| • Added channel separation to <i>Electrical Characteristics</i> .....     | 9           |
| • Added GBP instead of UGB in the <i>Electrical Characteristics</i> ..... | 9           |
| • Added Channel Separation vs Frequency plot .....                        | 16          |

**Changes from Original (April 2014) to Revision A****Page**

- 
- Changed status from preview to production ..... **1**
-

## 5 Pin Configuration and Functions

**DCK Package  
5-Pin SC70  
Top View**

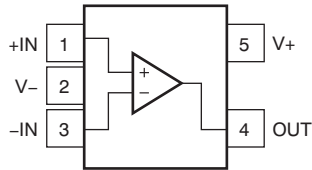

**DBV Package  
5-Pin SOT-23  
Top View**

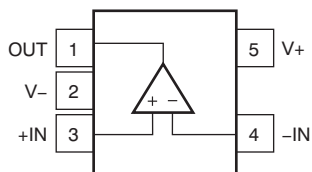

**DRG Package  
8-Pin DFN  
Top View**

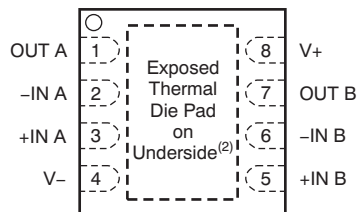

Pitch: 0.5 mm.

Connect thermal pad to V-. Pad size: 2.00 mm x 1.20 mm.

**D, DGK Packages  
8-Pin MSOP, SO  
Top View**

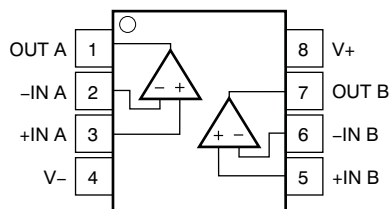

**DGS Package  
10-Pin MSOP  
Top View**

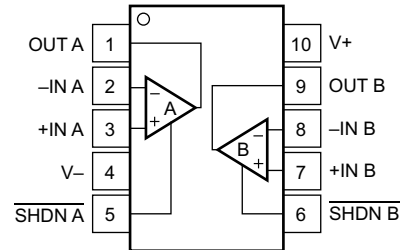

**RUG Package  
10-Pin QFN  
Top View**

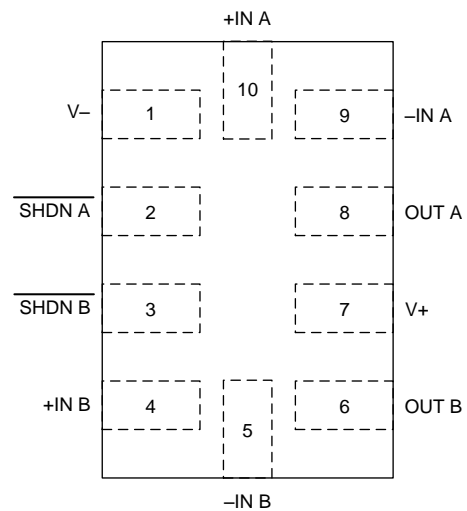

**D, PW Packages  
14-Pin SOIC, TSSOP  
Top View**

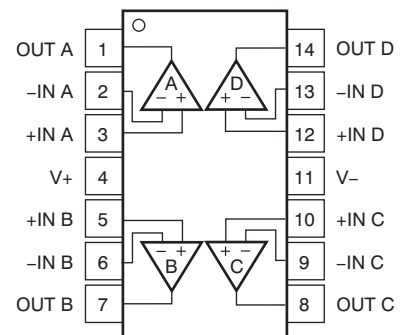

**Pin Functions**

| NAME   | PIN    |     |                |          |     |         |    | DESCRIPTION   |
|--------|--------|-----|----------------|----------|-----|---------|----|---|
|        | OPA316 |     | OPA2316        | OPA2316S |     | OPA4316 |    |   |
|        | DBV    | DCK | D, DGK,<br>DRG | DGS      | RUG | PW      | D  |   |
| +IN    | 3      | 1   | —              | —        | —   | —       | —  | Noninverting input                                      |
| +IN A  | —      | —   | 3              | 3        | 10  | 3       | 3  | Noninverting input                                      |
| +IN B  | —      | —   | 5              | 7        | 4   | 5       | 5  | Noninverting input                                      |
| +IN C  | —      | —   | —              | —        | —   | 10      | 10 | Noninverting input                                      |
| +IN D  | —      | —   | —              | —        | —   | 12      | 12 | Noninverting input                                      |
| –IN    | 4      | 3   | —              | —        | —   | —       | —  | Inverting input   |
| –IN A  | —      | —   | 2              | 2        | 9   | 2       | 2  | Inverting input   |
| –IN B  | —      | —   | 6              | 8        | 5   | 6       | 6  | Inverting input   |
| –IN C  | —      | —   | —              | —        | —   | 9       | 9  | Inverting input   |
| –IN D  | —      | —   | —              | —        | —   | 13      | 13 | Inverting input   |
| OUT    | 1      | 4   | —              | —        | —   | —       | —  | Output  |
| OUT A  | —      | —   | 1              | 1        | 8   | 1       | 1  | Output  |
| OUT B  | —      | —   | 7              | 9        | 6   | 7       | 7  | Output  |
| OUT C  | —      | —   | —              | —        | —   | 8       | 8  | Output  |
| OUT D  | —      | —   | —              | —        | —   | 14      | 14 | Output  |
| SHDN A | —      | —   | —              | 5        | 2   | —       | —  | Shutdown (logic low), enable (logic high)               |
| SHDN B | —      | —   | —              | 6        | 3   | —       | —  | Shutdown (logic low), enable (logic high)               |
| V+     | 5      | 5   | 8              | 10       | 7   | 4       | 4  | Positive supply   |
| V–     | 2      | 2   | 4              | 4        | 1   | 11      | 11 | Negative supply or ground (for single-supply operation) |

## 6 Specifications

### 6.1 Absolute Maximum Ratings

 over operating free-air temperature (unless otherwise noted)<sup>(1)</sup>

|                                     |                        |              | MIN   | MAX                     | UNIT |
|-------------------------------------|------------------------|--------------|---|-------------------------|------|
| Supply voltage                      |                        |              | 7   |                         | V    |
| Signal input pins                   | Voltage <sup>(2)</sup> | Common-mode  | (V <sub>-</sub> ) – 0.5                     | (V <sub>+</sub> ) + 0.5 | V    |
|                                     |                        | Differential | (V <sub>+</sub> ) – (V <sub>-</sub> ) + 0.2 |                         | V    |
|                                     | Current <sup>(2)</sup> | –10          | 10  | mA                      |      |
| Output short-circuit <sup>(3)</sup> |                        |              | Continuous                                  |                         |      |
| T <sub>A</sub>                      | Operating temperature  |              | –55   | 150                     | °C   |
| T <sub>J</sub>                      | Junction temperature   |              |   | 150                     | °C   |
| T <sub>stg</sub>                    | Storage temperature    |              | –65   | 150                     | °C   |

- (1) Stresses beyond those listed under *Absolute Maximum Ratings* may cause permanent damage to the device. These are stress ratings only, which do not imply functional operation of the device at these or any other conditions beyond those indicated under *Recommended Operating Conditions*. Exposure to absolute-maximum-rated conditions for extended periods may affect device reliability.
- (2) Input pins are diode-clamped to the power-supply rails. Current limit input signals that can swing more than 0.5 V beyond the supply rails to 10 mA or less.
- (3) Short-circuit to ground, one amplifier per package.

### 6.2 ESD Ratings

over operating free-air temperature range (unless otherwise noted).

|                    |                         |  | VALUE | UNIT |
|--------------------|-------------------------|--|-------|------|
| V <sub>(ESD)</sub> | Electrostatic discharge | Human body model (HBM), per ANSI/ESDA/JEDEC JS-001 <sup>(1)</sup>              | ±4000 | V    |
|                    |                         | Charged device model (CDM), per JEDEC specification JESD22-C101 <sup>(2)</sup> | ±1500 |      |

- (1) JEDEC document JEP155 states that 500-V HBM allows safe manufacturing with a standard ESD control process.
- (2) JEDEC document JEP157 states that 250-V CDM allows safe manufacturing with a standard ESD control process.

### 6.3 Recommended Operating Conditions

over operating free-air temperature range (unless otherwise noted).

|                |                       |  | MIN | MAX | UNIT |
|----------------|-----------------------|--|-----|-----|------|
| V <sub>S</sub> | Supply voltage        |  | 1.8 | 5.5 | V    |
|                | Specified temperature |  | –40 | 125 | °C   |

### 6.4 Thermal Information: OPA316

| THERMAL METRIC <sup>(1)</sup> |   | OPA316      |            | UNIT |
|-------------------------------|---|-------------|------------|------|
|                               |   | DBV (SOT23) | DCK (SC70) |      |
|                               |   | 5 PINS      | 5 PINS     |      |
| R <sub>θJA</sub>              | Junction-to-ambient thermal resistance <sup>(2)</sup>       | 221.7       | 263.3      | °C/W |
| R <sub>θJC(top)</sub>         | Junction-to-case(top) thermal resistance <sup>(3)</sup>     | 144.7       | 75.5       | °C/W |
| R <sub>θJB</sub>              | Junction-to-board thermal resistance <sup>(4)</sup>         | 49.7        | 51         | °C/W |
| ψ <sub>JT</sub>               | Junction-to-top characterization parameter <sup>(5)</sup>   | 26.1        | 1          | °C/W |
| ψ <sub>JB</sub>               | Junction-to-board characterization parameter <sup>(6)</sup> | 49          | 50.3       | °C/W |

- (1) For more information about traditional and new thermal metrics, see [Semiconductor and IC Package Thermal Metrics](#) (SPRA953).
- (2) The junction-to-ambient thermal resistance under natural convection is obtained in a simulation on a JEDEC-standard, high-K board, as specified in JESD51-7, in an environment described in JESD51-2a.
- (3) The junction-to-case (top) thermal resistance is obtained by simulating a cold plate test on the package top. No specific JEDEC-standard test exists, but a close description can be found in the ANSI SEMI standard G30-88.
- (4) The junction-to-board thermal resistance is obtained by simulating in an environment with a ring cold plate fixture to control the PCB temperature, as described in JESD51-8.
- (5) The junction-to-top characterization parameter, ψ<sub>JT</sub>, estimates the junction temperature of a device in a real system and is extracted from the simulation data for obtaining R<sub>θJA</sub>, using a procedure described in JESD51-2a (sections 6 and 7).
- (6) The junction-to-board characterization parameter, ψ<sub>JB</sub>, estimates the junction temperature of a device in a real system and is extracted from the simulation data for obtaining R<sub>θJA</sub>, using a procedure described in JESD51-2a (sections 6 and 7).

**Thermal Information: OPA316 (continued)**

| THERMAL METRIC <sup>(1)</sup>   | OPA316      |            | UNIT |
|---|-------------|------------|------|
|   | DBV (SOT23) | DCK (SC70) |      |
|   | 5 PINS      | 5 PINS     |      |
| $R_{\theta JC(bot)}$ Junction-to-case(bottom) thermal resistance <sup>(7)</sup> | N/A         | N/A        | °C/W |

(7) The junction-to-case (bottom) thermal resistance is obtained by simulating a cold plate test on the exposed (power) pad. No specific JEDEC standard test exists, but a close description can be found in the ANSI SEMI standard G30-88.

**6.5 Thermal Information: OPA2316**

| THERMAL METRIC <sup>(1)</sup>   | OPA2316 |            |           | UNIT |
|---|---------|------------|-----------|------|
|   | D (SO)  | DGK (MSOP) | DRG (DFN) |      |
|   | 8 PINS  | 8 PINS     | 8 PINS    |      |
| $R_{\theta JA}$ Junction-to-ambient thermal resistance <sup>(2)</sup>           | 127.2   | 186.6      | 56.3      | °C/W |
| $R_{\theta JC(top)}$ Junction-to-case(top) thermal resistance <sup>(3)</sup>    | 71.6    | 78.8       | 72.2      | °C/W |
| $R_{\theta JB}$ Junction-to-board thermal resistance <sup>(4)</sup>             | 68.2    | 107.9      | 31        | °C/W |
| $\Psi_{JT}$ Junction-to-top characterization parameter <sup>(5)</sup>           | 22      | 15.5       | 2.3       | °C/W |
| $\Psi_{JB}$ Junction-to-board characterization parameter <sup>(6)</sup>         | 67.6    | 106.3      | 21.2      | °C/W |
| $R_{\theta JC(bot)}$ Junction-to-case(bottom) thermal resistance <sup>(7)</sup> | N/A     | N/A        | 10.9      | °C/W |

- For more information about traditional and new thermal metrics, see [Semiconductor and IC Package Thermal Metrics](#) (SPRA953).
- The junction-to-ambient thermal resistance under natural convection is obtained in a simulation on a JEDEC-standard, high-K board, as specified in JESD51-7, in an environment described in JESD51-2a.
- The junction-to-case (top) thermal resistance is obtained by simulating a cold plate test on the package top. No specific JEDEC-standard test exists, but a close description can be found in the ANSI SEMI standard G30-88.
- The junction-to-board thermal resistance is obtained by simulating in an environment with a ring cold plate fixture to control the PCB temperature, as described in JESD51-8.
- The junction-to-top characterization parameter,  $\Psi_{JT}$ , estimates the junction temperature of a device in a real system and is extracted from the simulation data for obtaining  $R_{\theta JA}$ , using a procedure described in JESD51-2a (sections 6 and 7).
- The junction-to-board characterization parameter,  $\Psi_{JB}$ , estimates the junction temperature of a device in a real system and is extracted from the simulation data for obtaining  $R_{\theta JA}$ , using a procedure described in JESD51-2a (sections 6 and 7).
- The junction-to-case (bottom) thermal resistance is obtained by simulating a cold plate test on the exposed (power) pad. No specific JEDEC standard test exists, but a close description can be found in the ANSI SEMI standard G30-88.

**6.6 Thermal Information: OPA2316S**

| THERMAL METRIC <sup>(1)</sup>   | OPA2316S   |           | UNIT |
|---|------------|-----------|------|
|   | DGS (MSOP) | QFN (RUG) |      |
|   | 10 PINS    | 10 PINS   |      |
| $R_{\theta JA}$ Junction-to-ambient thermal resistance <sup>(2)</sup>           | 189.6      | 158       | °C/W |
| $R_{\theta JC(top)}$ Junction-to-case(top) thermal resistance <sup>(3)</sup>    | 73.9       | 52        | °C/W |
| $R_{\theta JB}$ Junction-to-board thermal resistance <sup>(4)</sup>             | 110.7      | 88        | °C/W |
| $\Psi_{JT}$ Junction-to-top characterization parameter <sup>(5)</sup>           | 13.4       | 1         | °C/W |
| $\Psi_{JB}$ Junction-to-board characterization parameter <sup>(6)</sup>         | 109.1      | 87        | °C/W |
| $R_{\theta JC(bot)}$ Junction-to-case(bottom) thermal resistance <sup>(7)</sup> | N/A        | N/A       | °C/W |

- For more information about traditional and new thermal metrics, see [Semiconductor and IC Package Thermal Metrics](#) (SPRA953).
- The junction-to-ambient thermal resistance under natural convection is obtained in a simulation on a JEDEC-standard, high-K board, as specified in JESD51-7, in an environment described in JESD51-2a.
- The junction-to-case (top) thermal resistance is obtained by simulating a cold plate test on the package top. No specific JEDEC-standard test exists, but a close description can be found in the ANSI SEMI standard G30-88.
- The junction-to-board thermal resistance is obtained by simulating in an environment with a ring cold plate fixture to control the PCB temperature, as described in JESD51-8.
- The junction-to-top characterization parameter,  $\Psi_{JT}$ , estimates the junction temperature of a device in a real system and is extracted from the simulation data for obtaining  $R_{\theta JA}$ , using a procedure described in JESD51-2a (sections 6 and 7).
- The junction-to-board characterization parameter,  $\Psi_{JB}$ , estimates the junction temperature of a device in a real system and is extracted from the simulation data for obtaining  $R_{\theta JA}$ , using a procedure described in JESD51-2a (sections 6 and 7).
- The junction-to-case (bottom) thermal resistance is obtained by simulating a cold plate test on the exposed (power) pad. No specific JEDEC standard test exists, but a close description can be found in the ANSI SEMI standard G30-88.

## 6.7 Thermal Information: OPA4316

| THERMAL METRIC <sup>(1)</sup>   | OPA4316    |          | UNIT |
|---|------------|----------|------|
|   | PW (TSSOP) | D (SOIC) |      |
|   | 14 PINS    | 14 PINS  |      |
| $R_{\theta JA}$ Junction-to-ambient thermal resistance <sup>(2)</sup>           | 117.2      | 87.0     | °C/W |
| $R_{\theta JC(top)}$ Junction-to-case(top) thermal resistance <sup>(3)</sup>    | 46.2       | 44.4     | °C/W |
| $R_{\theta JB}$ Junction-to-board thermal resistance <sup>(4)</sup>             | 58.9       | 41.7     | °C/W |
| $\Psi_{JT}$ Junction-to-top characterization parameter <sup>(5)</sup>           | 4.9        | 11.6     | °C/W |
| $\Psi_{JB}$ Junction-to-board characterization parameter <sup>(6)</sup>         | 58.3       | 41.4     | °C/W |
| $R_{\theta JC(bot)}$ Junction-to-case(bottom) thermal resistance <sup>(7)</sup> | N/A        | N/A      | °C/W |

- (1) For more information about traditional and new thermal metrics, see [Semiconductor and IC Package Thermal Metrics](#) (SPRA953).
- (2) The junction-to-ambient thermal resistance under natural convection is obtained in a simulation on a JEDEC-standard, high-K board, as specified in JESD51-7, in an environment described in JESD51-2a.
- (3) The junction-to-case (top) thermal resistance is obtained by simulating a cold plate test on the package top. No specific JEDEC-standard test exists, but a close description can be found in the ANSI SEMI standard G30-88.
- (4) The junction-to-board thermal resistance is obtained by simulating in an environment with a ring cold plate fixture to control the PCB temperature, as described in JESD51-8.
- (5) The junction-to-top characterization parameter,  $\Psi_{JT}$ , estimates the junction temperature of a device in a real system and is extracted from the simulation data for obtaining  $R_{\theta JA}$ , using a procedure described in JESD51-2a (sections 6 and 7).
- (6) The junction-to-board characterization parameter,  $\Psi_{JB}$ , estimates the junction temperature of a device in a real system and is extracted from the simulation data for obtaining  $R_{\theta JA}$ , using a procedure described in JESD51-2a (sections 6 and 7).
- (7) The junction-to-case (bottom) thermal resistance is obtained by simulating a cold plate test on the exposed (power) pad. No specific JEDEC standard test exists, but a close description can be found in the ANSI SEMI standard G30-88.

## 6.8 Electrical Characteristics

 $V_S$  (total supply voltage) = (V+) – (V–) = 1.8 V to 5.5 V.

 at  $T_A = 25^\circ\text{C}$ ,  $R_L = 10\text{ k}\Omega$  connected to  $V_S / 2$ ,  $V_{CM} = V_S / 2$ , and  $V_{OUT} = V_S / 2$ , unless otherwise noted.

| PARAMETER                  |  | TEST CONDITIONS   | MIN          | TYP             | MAX          | UNIT                                |
|----------------------------|--|---|--------------|-----------------|--------------|-------------------------------------|
| <b>OFFSET VOLTAGE</b>      |  |   |              |                 |              |                                     |
| $V_{OS}$                   | Input offset voltage                             | $V_S = 5\text{ V}$  |              | $\pm 0.5$       | $\pm 2.5$    | mV                                  |
|                            |  | $V_S = 5\text{ V}$ , $T_A = -40^\circ\text{C}$ to $125^\circ\text{C}$   |              |                 | $\pm 3.5$    | mV                                  |
| $dV_{OS}/dT$               | Drift  | $V_S = 5\text{ V}$ , $T_A = -40^\circ\text{C}$ to $125^\circ\text{C}$   |              | $\pm 2$         | $\pm 10$     | $\mu\text{V}/^\circ\text{C}$        |
| PSRR                       | vs power supply                                  | $V_S = 1.8\text{ V} - 5.5\text{ V}$ , $V_{CM} = (V-)$   |              | $\pm 30$        | $\pm 150$    | $\mu\text{V}/\text{V}$              |
|                            |  | $V_S = 1.8\text{ V} - 5.5\text{ V}$ , $V_{CM} = (V-)$ , $T_A = -40^\circ\text{C}$ to $125^\circ\text{C}$  |              |                 | $\pm 250$    | $\mu\text{V}/\text{V}$              |
|                            | Channel separation, dc                           | At dc   |              | 10              |              | $\mu\text{V}/\text{V}$              |
| <b>INPUT VOLTAGE RANGE</b> |  |   |              |                 |              |                                     |
| $V_{CM}$                   | Common-mode voltage                              | $V_S = 1.8\text{ V}$ to $2.5\text{ V}$  | $(V-) - 0.2$ |                 | $(V+)$       | V                                   |
|                            |  | $V_S = 2.5\text{ V}$ to $5.5\text{ V}$  | $(V-) - 0.2$ |                 | $(V+) + 0.2$ | V                                   |
| CMRR                       | Common-mode rejection ratio                      | $V_S = 1.8\text{ V}$ , $(V-) - 0.2\text{ V} < V_{CM} < (V+) - 1.4\text{ V}$ , $T_A = -40^\circ\text{C}$ to $125^\circ\text{C}$                            | 70           | 86              |              | dB                                  |
|                            |  | $V_S = 5.5\text{ V}$ , $(V-) - 0.2\text{ V} < V_{CM} < (V+) - 1.4\text{ V}$ , $T_A = -40^\circ\text{C}$ to $125^\circ\text{C}$                            | 76           | 90              |              | dB                                  |
|                            |  | $V_S = 1.8\text{ V}$ , $V_{CM} = -0.2\text{ V}$ to $1.8\text{ V}$ , $T_A = -40^\circ\text{C}$ to $125^\circ\text{C}$                                      | 57           | 72              |              | dB                                  |
|                            |  | $V_S = 5.5\text{ V}$ , $V_{CM} = -0.2\text{ V}$ to $5.7\text{ V}$ , $T_A = -40^\circ\text{C}$ to $125^\circ\text{C}$                                      | 65           | 80              |              | dB                                  |
| <b>INPUT BIAS CURRENT</b>  |  |   |              |                 |              |                                     |
| $I_B$                      | Input bias current                               |   |              | $\pm 5$         | $\pm 15$     | pA                                  |
|                            |  | $T_A = -40^\circ\text{C}$ to $125^\circ\text{C}$  |              |                 | $\pm 15$     | nA                                  |
| $I_{OS}$                   | Input offset current                             |   |              | $\pm 2$         | $\pm 15$     | pA                                  |
|                            |  | $T_A = -40^\circ\text{C}$ to $125^\circ\text{C}$  |              |                 | $\pm 8$      | nA                                  |
| <b>NOISE</b>               |  |   |              |                 |              |                                     |
| $E_n$                      | Input voltage noise (peak-to-peak)               | $V_S = 5\text{ V}$ , $f = 0.1\text{ Hz}$ to $10\text{ Hz}$  |              | 3               |              | $\mu\text{V}_{PP}$                  |
| $e_n$                      | Input voltage noise density                      | $V_S = 5\text{ V}$ , $f = 1\text{ kHz}$   |              | 11              |              | $\text{nV}/\sqrt{\text{Hz}}$        |
| $i_n$                      | Input current noise density                      | $f = 1\text{ kHz}$  |              | 1.3             |              | $\text{fA}/\sqrt{\text{Hz}}$        |
| <b>INPUT IMPEDANCE</b>     |  |   |              |                 |              |                                     |
| $Z_{ID}$                   | Differential                                     |   |              | $2 \parallel 2$ |              | $10^{16}\Omega \parallel \text{pF}$ |
| $Z_{IC}$                   | Common-mode                                      |   |              | $2 \parallel 4$ |              | $10^{11}\Omega \parallel \text{pF}$ |
| <b>OPEN-LOOP GAIN</b>      |  |   |              |                 |              |                                     |
| $A_{OL}$                   | Open-loop voltage gain                           | $V_S = 1.8\text{ V}$ , $(V-) + 0.04\text{ V} < V_O < (V+) - 0.04\text{ V}$ , $R_L = 10\text{ k}\Omega$  | 94           | 100             |              | dB                                  |
|                            |  | $V_S = 5.5\text{ V}$ , $(V-) + 0.05\text{ V} < V_O < (V+) - 0.05\text{ V}$ , $R_L = 10\text{ k}\Omega$  | 104          | 110             |              | dB                                  |
|                            |  | $V_S = 1.8\text{ V}$ , $(V-) + 0.1\text{ V} < V_O < (V+) - 0.1\text{ V}$ , $R_L = 2\text{ k}\Omega$   | 90           | 96              |              | dB                                  |
|                            |  | $V_S = 5.5\text{ V}$ , $(V-) + 0.15\text{ V} < V_O < (V+) - 0.15\text{ V}$ , $R_L = 2\text{ k}\Omega$   | 100          | 106             |              | dB                                  |
|                            |  | $V_S = 5.5\text{ V}$ , $(V-) + 0.05\text{ V} < V_O < (V+) - 0.05\text{ V}$ , $R_L = 10\text{ k}\Omega$ , $T_A = -40^\circ\text{C}$ to $125^\circ\text{C}$ | 86           |                 |              | dB                                  |
|                            |  | $V_S = 5.5\text{ V}$ , $(V-) + 0.15\text{ V} < V_O < (V+) - 0.15\text{ V}$ , $R_L = 2\text{ k}\Omega$ , $T_A = -40^\circ\text{C}$ to $125^\circ\text{C}$  | 84           |                 |              | dB                                  |
| <b>FREQUENCY RESPONSE</b>  |  |   |              |                 |              |                                     |
| GBP                        | Gain bandwidth product                           | $V_S = 5\text{ V}$ , $G = +1$   |              | 10              |              | MHz                                 |
| $\phi_m$                   | Phase margin                                     | $V_S = 5\text{ V}$ , $G = +1$   |              | 60              |              | Degrees                             |
| SR                         | Slew rate  | $V_S = 5\text{ V}$ , $G = +1$   |              | 6               |              | $\text{V}/\mu\text{s}$              |
| $t_s$                      | Settling time                                    | To 0.1%, $V_S = 5\text{ V}$ , 2-V step, $G = +1$ , $C_L = 100\text{ pF}$  |              | 1               |              | $\mu\text{s}$                       |
|                            |  | To 0.01%, $V_S = 5\text{ V}$ , 2-V step, $G = +1$ , $C_L = 100\text{ pF}$   |              | 1.66            |              | $\mu\text{s}$                       |
| $t_{OR}$                   | Overload recovery time                           | $V_S = 5\text{ V}$ , $V_{IN} \times \text{gain} = V_S$  |              | 0.3             |              | $\mu\text{s}$                       |
| THD + N                    | Total harmonic distortion + noise <sup>(1)</sup> | $V_S = 5\text{ V}$ , $V_O = 0.5 V_{RMS}$ , $G = +1$ , $f = 1\text{ kHz}$  |              | 0.0008%         |              |                                     |

(1) Third-order filter; bandwidth = 80 kHz at –3 dB.

## Electrical Characteristics (continued)

 $V_S$  (total supply voltage) = (V+) – (V–) = 1.8 V to 5.5 V.

 at  $T_A = 25^\circ\text{C}$ ,  $R_L = 10\text{ k}\Omega$  connected to  $V_S / 2$ ,  $V_{CM} = V_S / 2$ , and  $V_{OUT} = V_S / 2$ , unless otherwise noted.

| PARAMETER  | TEST CONDITIONS   | MIN   | TYP | MAX          | UNIT             |
|--|---|---|-----|--------------|------------------|
| <b>OUTPUT</b>  |   |   |     |              |                  |
| $V_O$  | Voltage output swing from supply rails                    | $V_S = 1.8\text{ V}$ , $R_L = 10\text{ k}\Omega$ , $T_A = -40^\circ\text{C}$ to $125^\circ\text{C}$ |     | 15           | mV               |
|  |   | $V_S = 5.5\text{ V}$ , $R_L = 10\text{ k}\Omega$ , $T_A = -40^\circ\text{C}$ to $125^\circ\text{C}$ |     | 30           | mV               |
|  |   | $V_S = 1.8\text{ V}$ , $R_L = 2\text{ k}\Omega$ , $T_A = -40^\circ\text{C}$ to $125^\circ\text{C}$  |     | 60           | mV               |
|  |   | $V_S = 5.5\text{ V}$ , $R_L = 2\text{ k}\Omega$ , $T_A = -40^\circ\text{C}$ to $125^\circ\text{C}$  |     | 120          | mV               |
| $I_{SC}$   | Short-circuit current                                     | $V_S = 5\text{ V}$  |     | $\pm 50$     | mA               |
| $Z_O$  | Open-loop output impedance                                | $V_S = 5\text{ V}$ , $f = 10\text{ MHz}$  |     | 250          | $\Omega$         |
| <b>POWER SUPPLY</b>  |   |   |     |              |                  |
| $V_S$  | Specified voltage   | 1.8   |     | 5.5          | V                |
| $I_Q$  | Quiescent current per amplifier                           | $V_S = 5\text{ V}$ , $I_O = 0\text{ mA}$ , $T_A = -40^\circ\text{C}$ to $125^\circ\text{C}$         |     | 400          | $\mu\text{A}$    |
|  | Power-on time   | $V_S = 0\text{ V}$ to $5.5\text{ V}$  |     | 200          | $\mu\text{s}$    |
| <b>SHUTDOWN (<math>V_S = 1.8\text{ V}</math> to <math>5.5\text{ V}</math>)<sup>(2)</sup></b> |   |   |     |              |                  |
| $I_{QSD}$  | Quiescent current, per device                             | All amplifiers disabled, $\overline{\text{SHDN}} = V_{S-}$  |     | 0.01         | $\mu\text{A}$    |
|  |   | One amplifier disabled (OPA2316S)   |     | 345          | $\mu\text{A}$    |
| $V_{IH}$   | High voltage (enabled)                                    | Amplifier enabled   |     | $(V+) - 0.5$ | V                |
| $V_{IL}$   | Low voltage (disabled)                                    | Amplifier disabled  |     | $(V-) + 0.2$ | V                |
| $t_{ON}$   | Amplifier enable time <sup>(3)</sup>                      | Full shutdown, $G = 1$ , $V_{OUT} = 0.9 \times V_S / 2$ <sup>(4)</sup>                              |     | 13           | $\mu\text{s}$    |
|  |   | Partial shutdown, $G = 1$ , $V_{OUT} = 0.9 \times V_S / 2$ <sup>(4)</sup>                           |     | 10           | $\mu\text{s}$    |
| $t_{OFF}$  | Amplifier disable time <sup>(3)</sup>                     | $G = 1$ , $V_{OUT} = 0.1 \times V_S / 2$  |     | 5            | $\mu\text{s}$    |
|  | $\overline{\text{SHDN}}$ pin input bias current (per pin) | $V_{IH} = 5\text{ V}$   |     | 3.5          | $\mu\text{A}$    |
|  |   | $V_{IL} = 0\text{ V}$   |     | 2.5          | $\mu\text{A}$    |
| <b>TEMPERATURE</b>   |   |   |     |              |                  |
|  | Specified temperature                                     | -40   |     | 125          | $^\circ\text{C}$ |
| $T_A$  | Operating temperature                                     | -55   |     | 150          | $^\circ\text{C}$ |
| $T_{stg}$  | Storage temperature                                       | -65   |     | 150          | $^\circ\text{C}$ |

(2) Ensured by design and characterization; not production tested.

(3) Enable time ( $t_{ON}$ ) and disable time ( $t_{OFF}$ ) are defined as the time interval between the 50% point of the signal applied to the  $\overline{\text{SHDN}}$  pin and the point at which the output voltage reaches the 10% (disable) or 90% (enable) level.

(4) Full shutdown refers to the dual OPA2316S having both channels A and B disabled ( $\overline{\text{SHDN}}_A = \overline{\text{SHDN}}_B = V_{S-}$ ). For partial shutdown, only one  $\overline{\text{SHDN}}$  pin is exercised; in partial mode, the internal biasing and oscillator remain operational and the enable time is shorter.

## 6.9 Typical Characteristics

at  $T_A = 25^\circ\text{C}$ ,  $V_S = 5.5\text{ V}$ ,  $R_L = 10\text{ k}\Omega$  connected to  $V_S / 2$ ,  $V_{CM} = V_S / 2$ , and  $V_{OUT} = V_S / 2$ , unless otherwise noted.

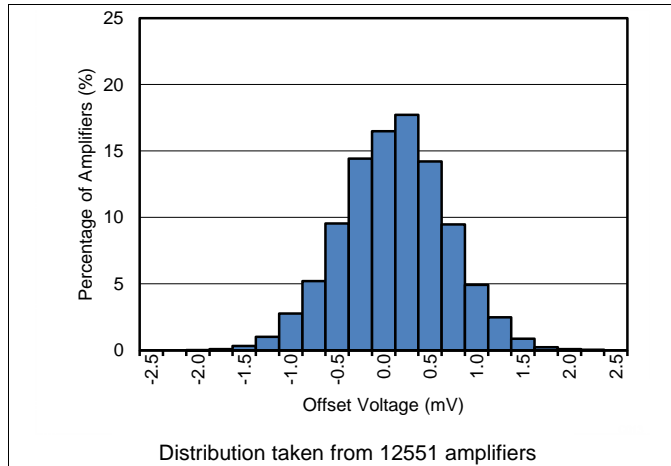

Figure 1. Offset Voltage Production Distribution

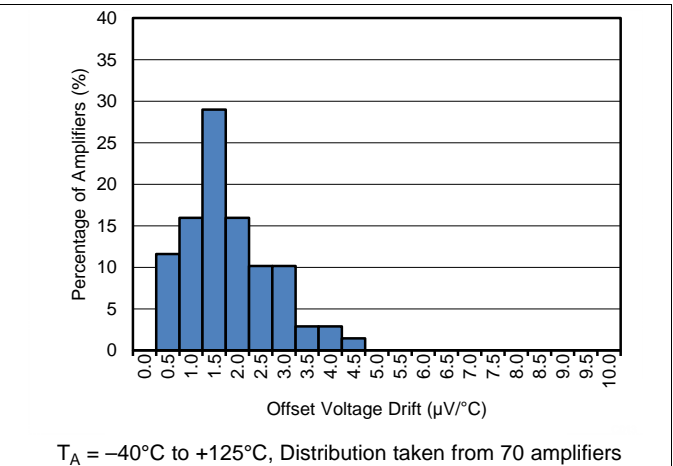

Figure 2. Offset Voltage Drift Distribution

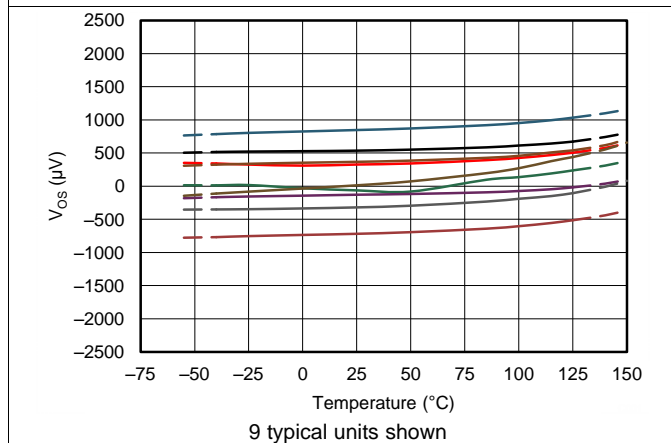

Figure 3. Offset Voltage vs Temperature

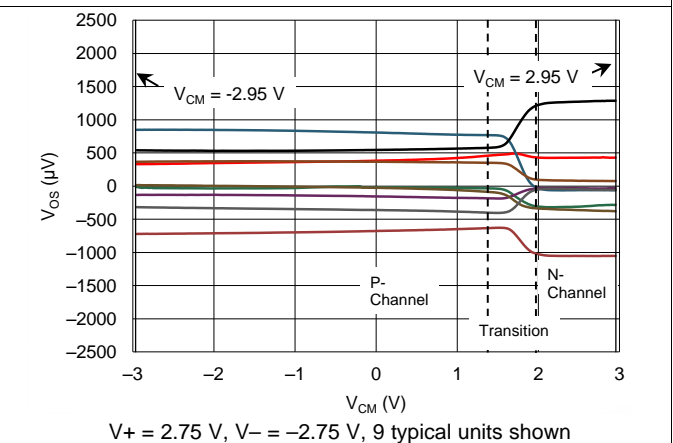

Figure 4. Offset Voltage vs Common-Mode Voltage

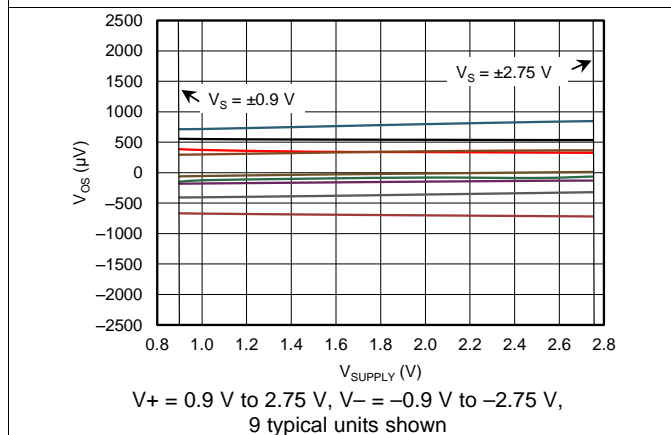

Figure 5. Offset Voltage vs Power Supply

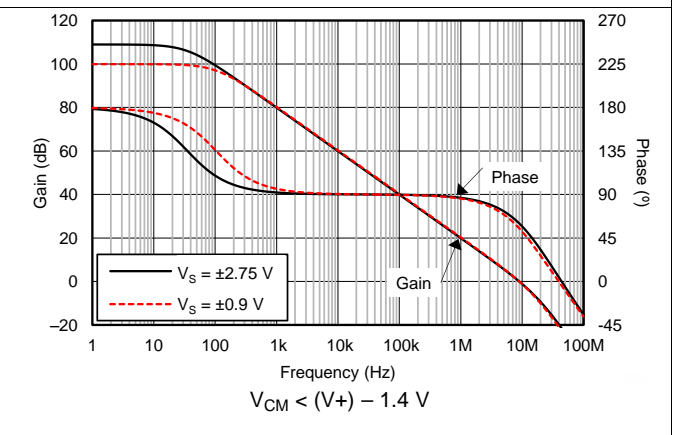

Figure 6. Open-Loop Gain and Phase vs Frequency

### Typical Characteristics (continued)

at  $T_A = 25^\circ\text{C}$ ,  $V_S = 5.5\text{ V}$ ,  $R_L = 10\text{ k}\Omega$  connected to  $V_S / 2$ ,  $V_{CM} = V_S / 2$ , and  $V_{OUT} = V_S / 2$ , unless otherwise noted.

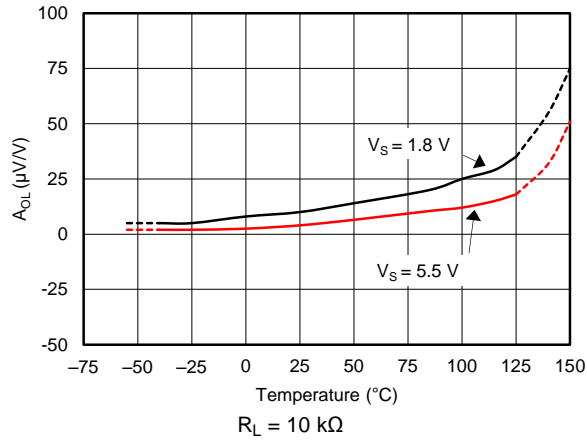

Figure 7. Open-Loop Gain vs Temperature

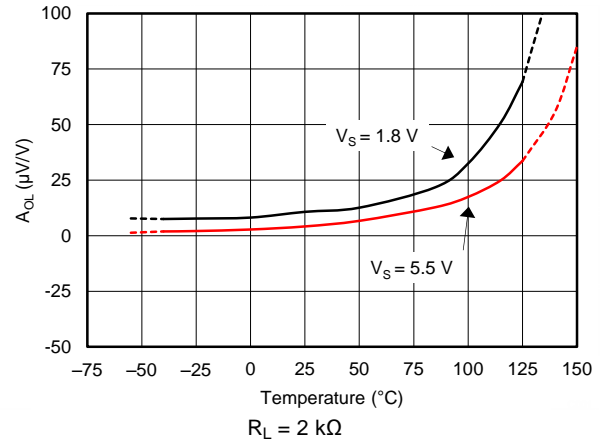

Figure 8. Open-Loop Gain vs Temperature

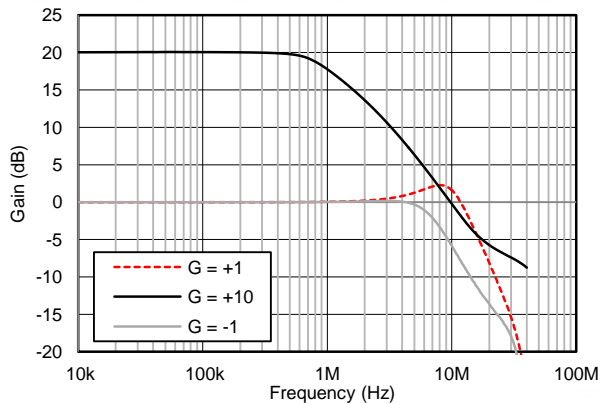

Figure 9. Closed-Loop Gain vs Frequency

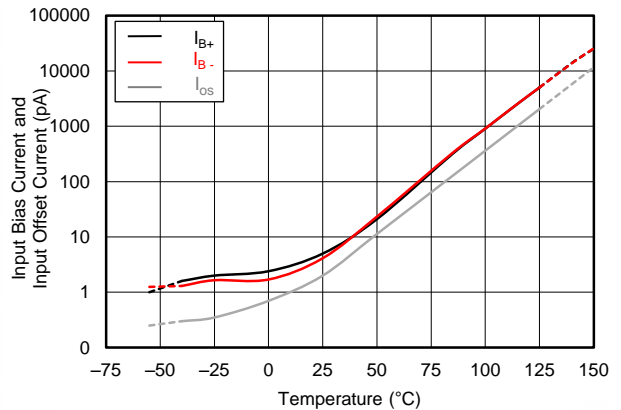

Figure 10. Input Bias and Offset Current vs Temperature

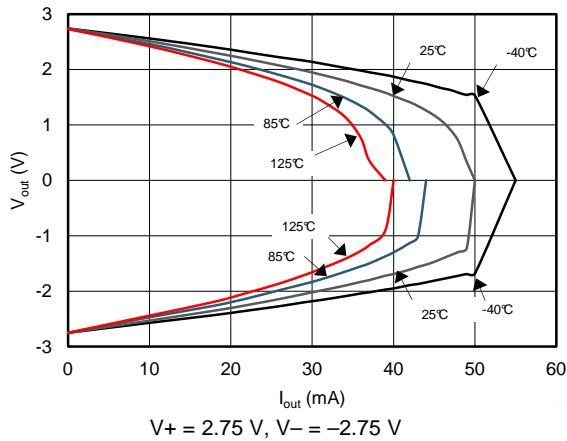

Figure 11. Output Voltage Swing vs Output Current

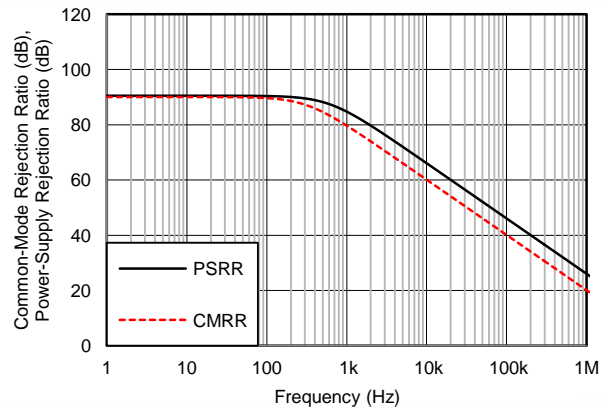

Figure 12. CMRR and PSRR vs Frequency (Referred to Input)

Typical Characteristics (continued)

at  $T_A = 25^\circ\text{C}$ ,  $V_S = 5.5\text{ V}$ ,  $R_L = 10\text{ k}\Omega$  connected to  $V_S / 2$ ,  $V_{CM} = V_S / 2$ , and  $V_{OUT} = V_S / 2$ , unless otherwise noted.

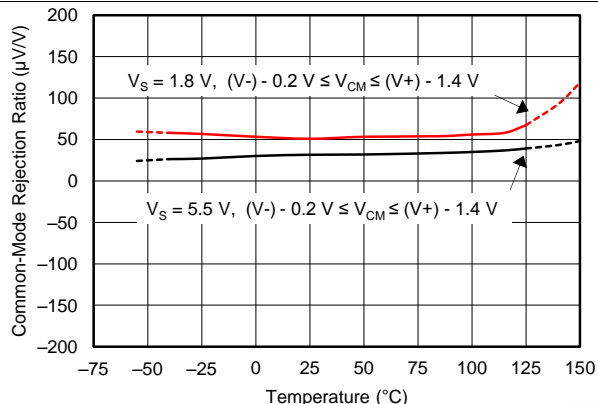

Figure 13. CMRR vs Temperature (Narrow Range)

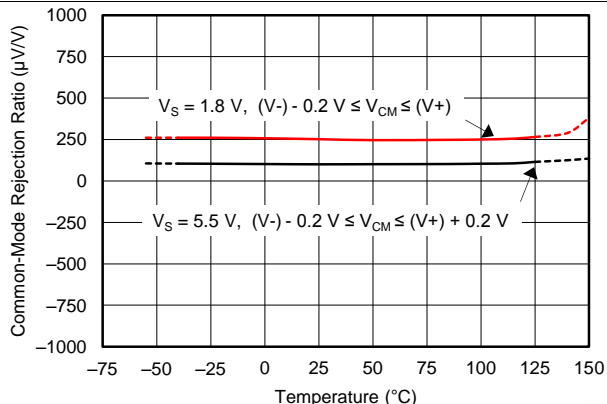

Figure 14. CMRR vs Temperature (Wide Range)

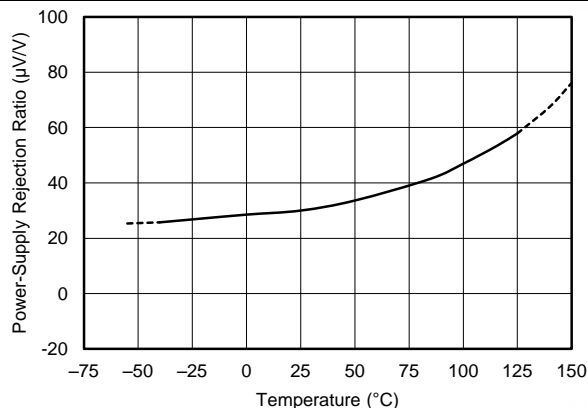

Figure 15. PSRR vs Temperature

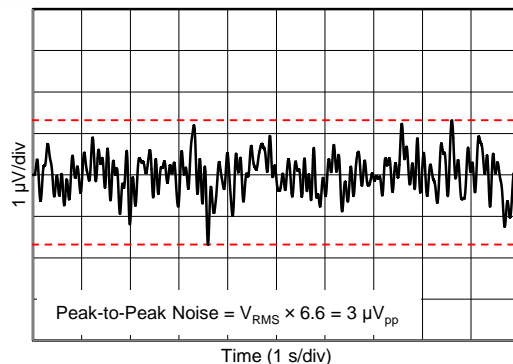

Figure 16. 0.1-Hz to 10-Hz Input Voltage Noise

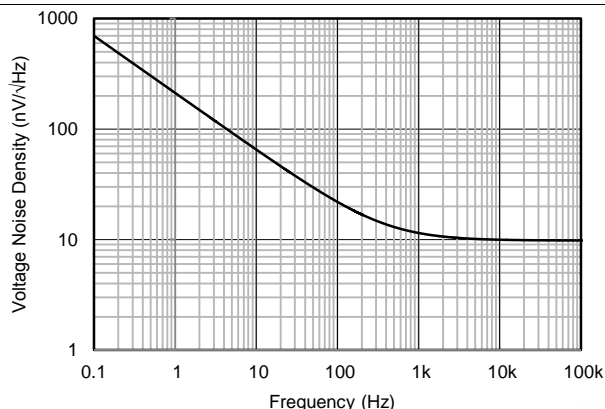

Figure 17. Input Voltage Noise Spectral Density vs Frequency

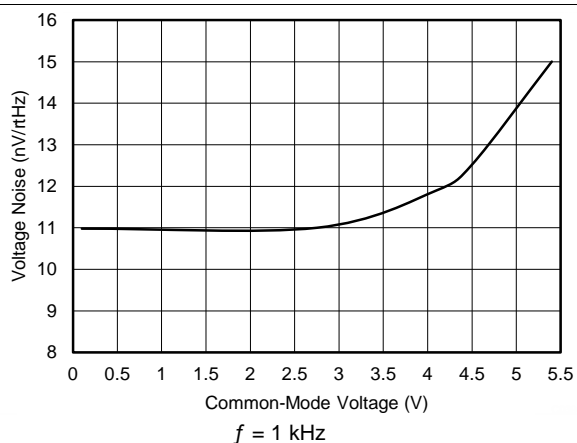
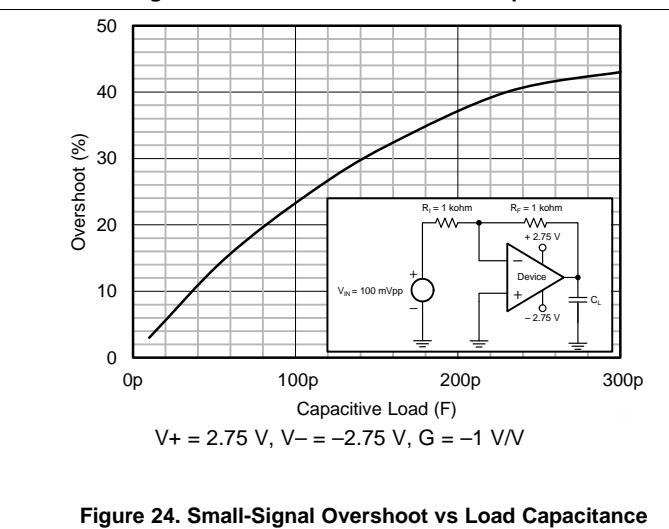
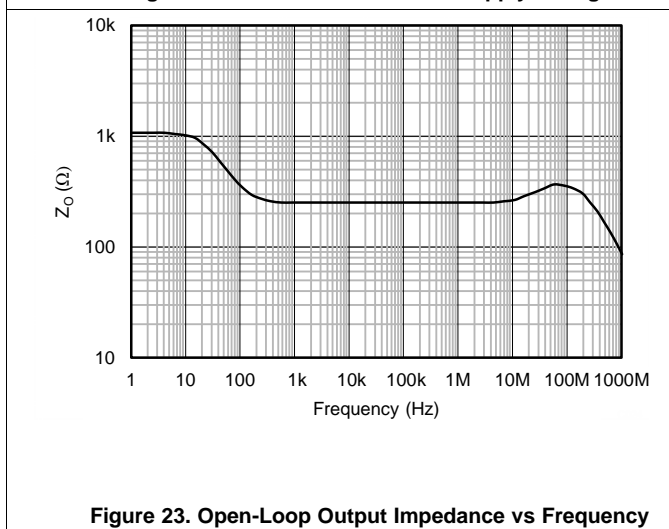
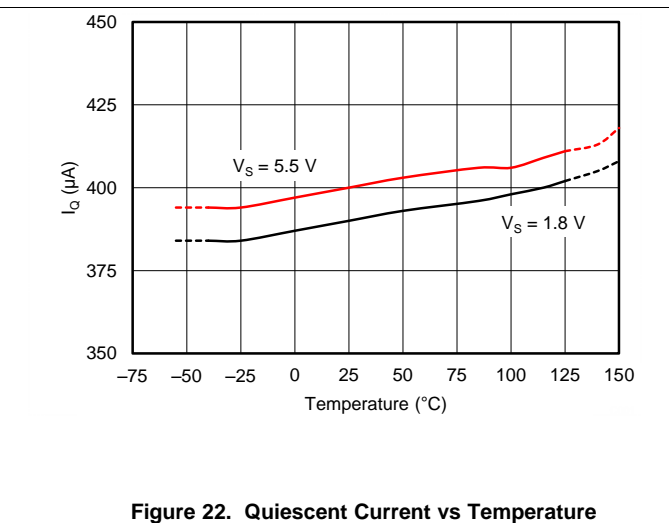
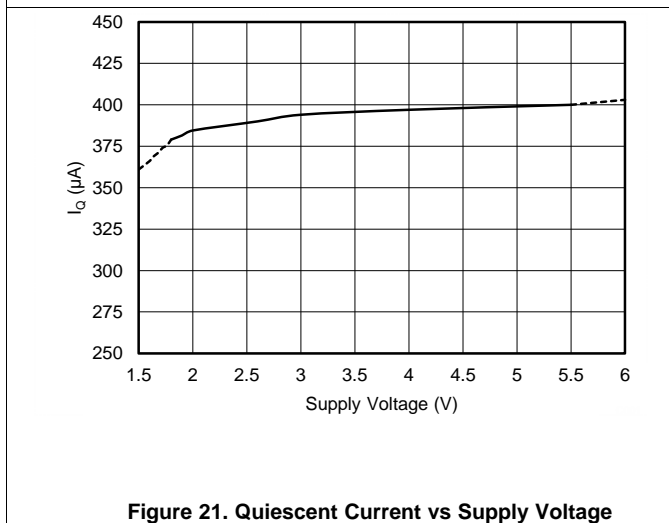
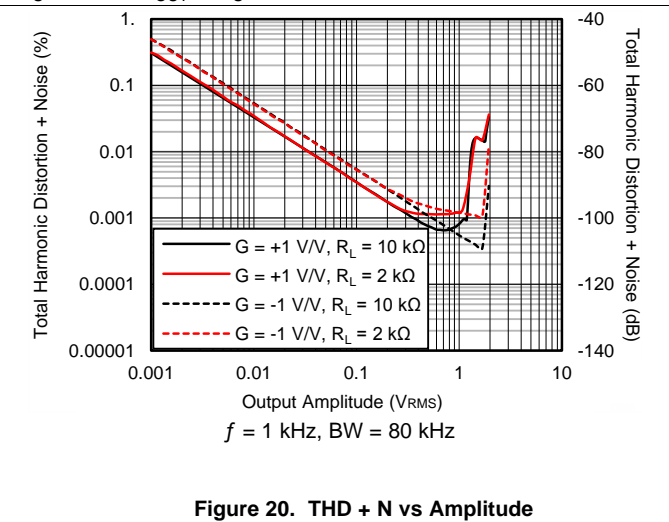
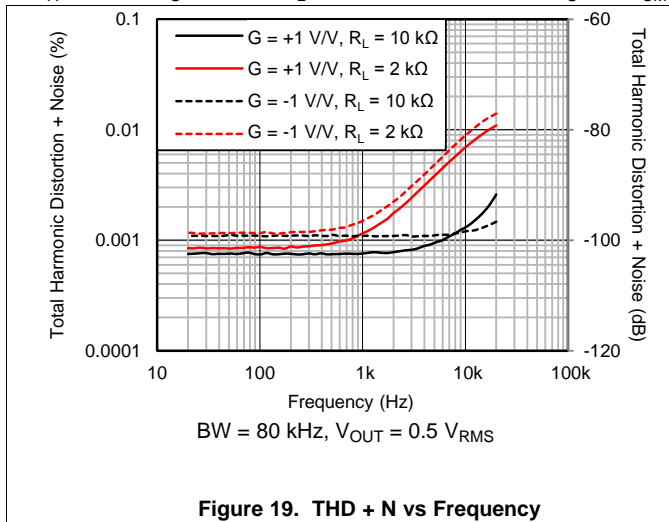

Figure 18. Input Voltage Noise vs Common-Mode Voltage

Typical Characteristics (continued)

at  $T_A = 25^\circ\text{C}$ ,  $V_S = 5.5\text{ V}$ ,  $R_L = 10\text{ k}\Omega$  connected to  $V_S / 2$ ,  $V_{CM} = V_S / 2$ , and  $V_{OUT} = V_S / 2$ , unless otherwise noted.



Typical Characteristics (continued)

at  $T_A = 25^\circ\text{C}$ ,  $V_S = 5.5\text{ V}$ ,  $R_L = 10\text{ k}\Omega$  connected to  $V_S / 2$ ,  $V_{CM} = V_S / 2$ , and  $V_{OUT} = V_S / 2$ , unless otherwise noted.

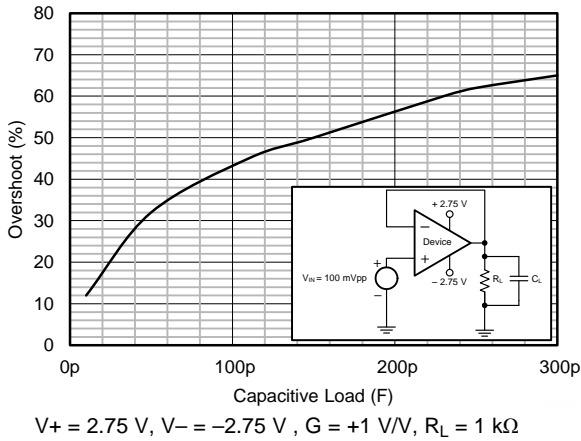

Figure 25. Small-Signal Overshoot vs Load Capacitance

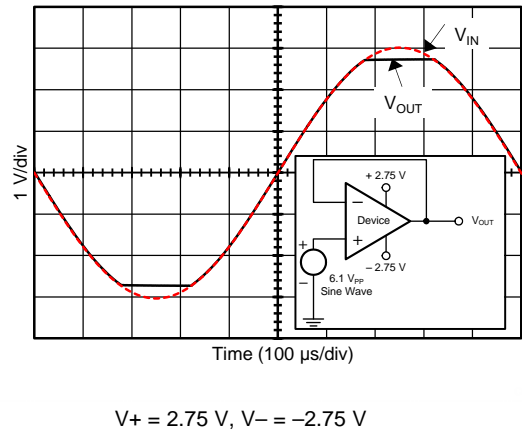

Figure 26. No Phase Reversal

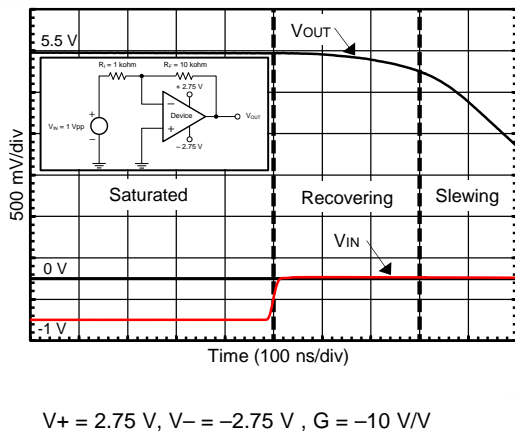

Figure 27. Positive Overload Recovery

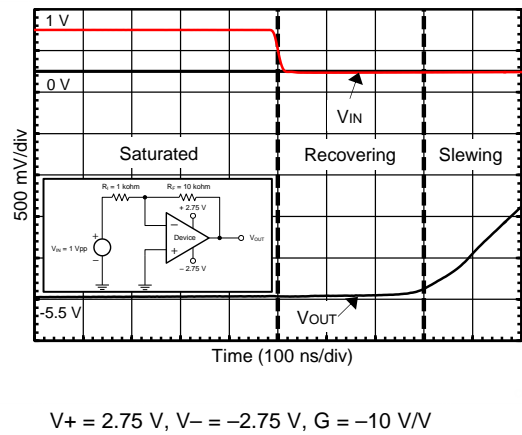

Figure 28. Negative Overload Recovery

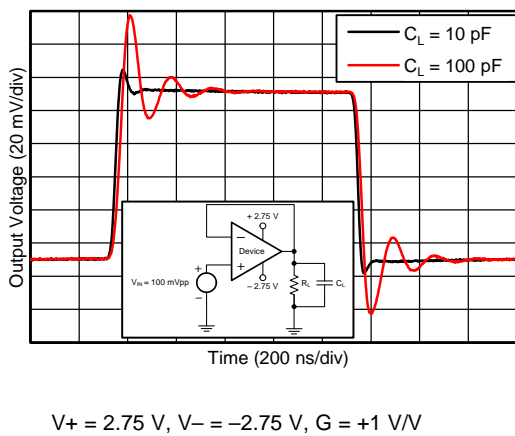

Figure 29. Small-Signal Step Response

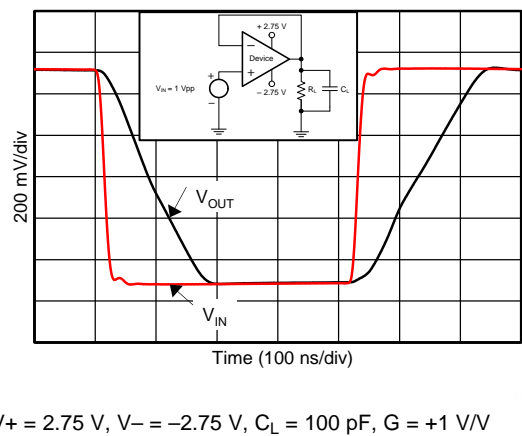

Figure 30. Large-Signal Step Response

### Typical Characteristics (continued)

at  $T_A = 25^\circ\text{C}$ ,  $V_S = 5.5\text{ V}$ ,  $R_L = 10\text{ k}\Omega$  connected to  $V_S / 2$ ,  $V_{CM} = V_S / 2$ , and  $V_{OUT} = V_S / 2$ , unless otherwise noted.

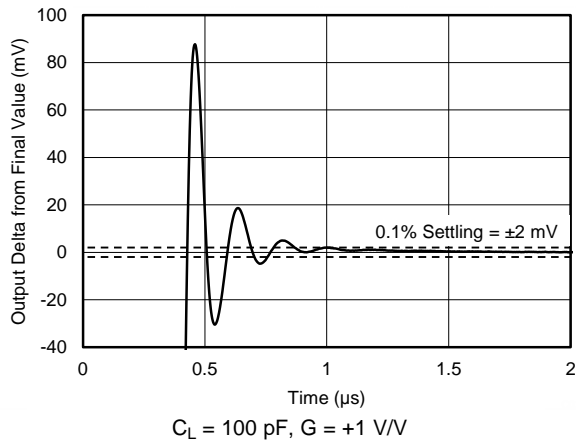

Figure 31. Positive Large-Signal Settling Time

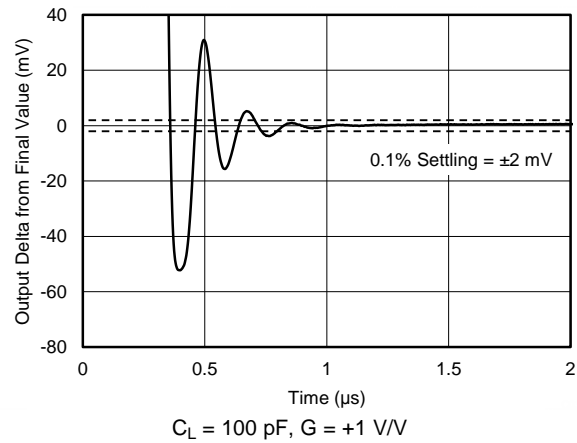

Figure 32. Negative Large-Signal Settling Time

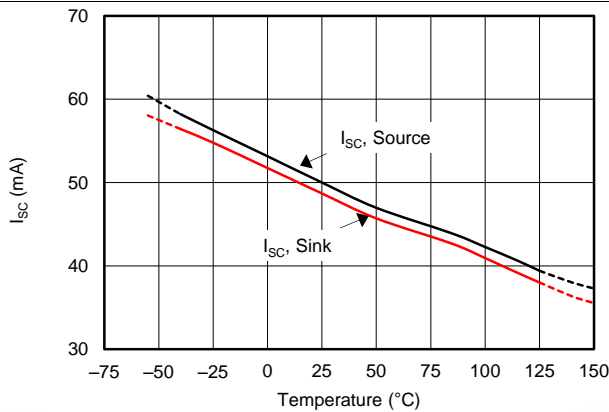

Figure 33. Short-Circuit Current vs Temperature

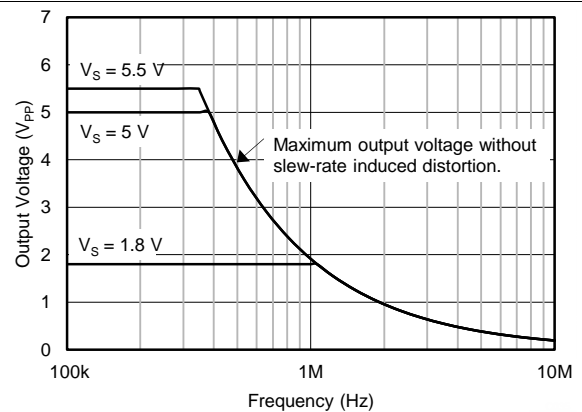

Figure 34. Maximum Output Voltage vs Frequency and Supply Voltage

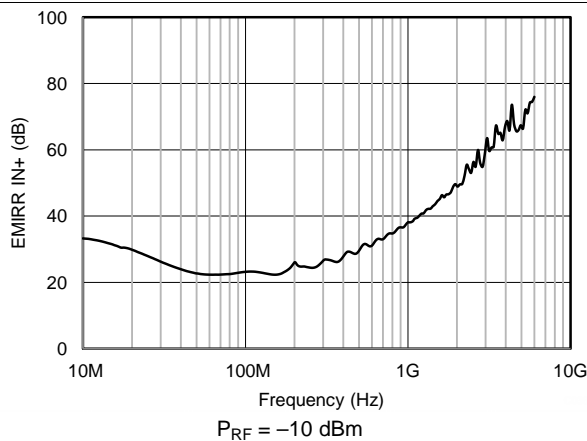

Figure 35. Electromagnetic Interference Rejection Ratio Referred to Noninverting Input (EMIRR IN+) vs Frequency

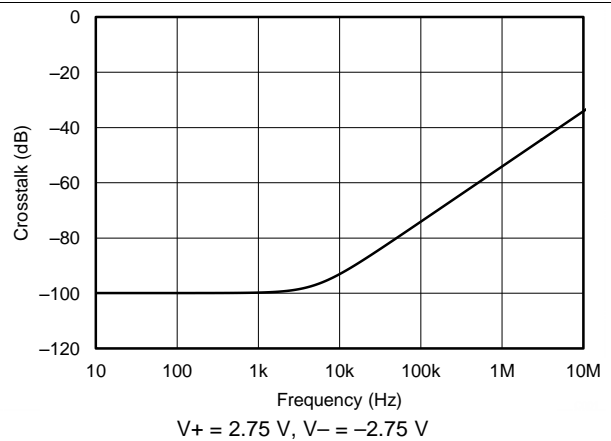

Figure 36. Channel Separation vs Frequency

## 7 Detailed Description

### 7.1 Overview

The OPA316 is a family of low-power, rail-to-rail input and output operational amplifiers. These devices operate from 1.8 V to 5.5 V, are unity-gain stable, and are suitable for a wide range of general-purpose applications. The class AB output stage is capable of driving less than or equal to 10-k $\Omega$  loads connected to any point between V+ and ground. The input common-mode voltage range includes both rails and allows the OPA316 series to be used in virtually any single-supply application. Rail-to-rail input and output swing significantly increases dynamic range, especially in low-supply applications, and makes them ideal for driving sampling analog-to-digital converters (ADCs).

The OPA316 family features 10-MHz bandwidth and 6-V/ $\mu$ s slew rate with only 400- $\mu$ A supply current per channel, providing good ac performance at very-low power consumption. DC applications are well served with a very-low input noise voltage of 11 nV/ $\sqrt{\text{Hz}}$  at 1 kHz, low input bias current (5 pA), and an input offset voltage of 0.5 mV (typical).

### 7.2 Functional Block Diagram

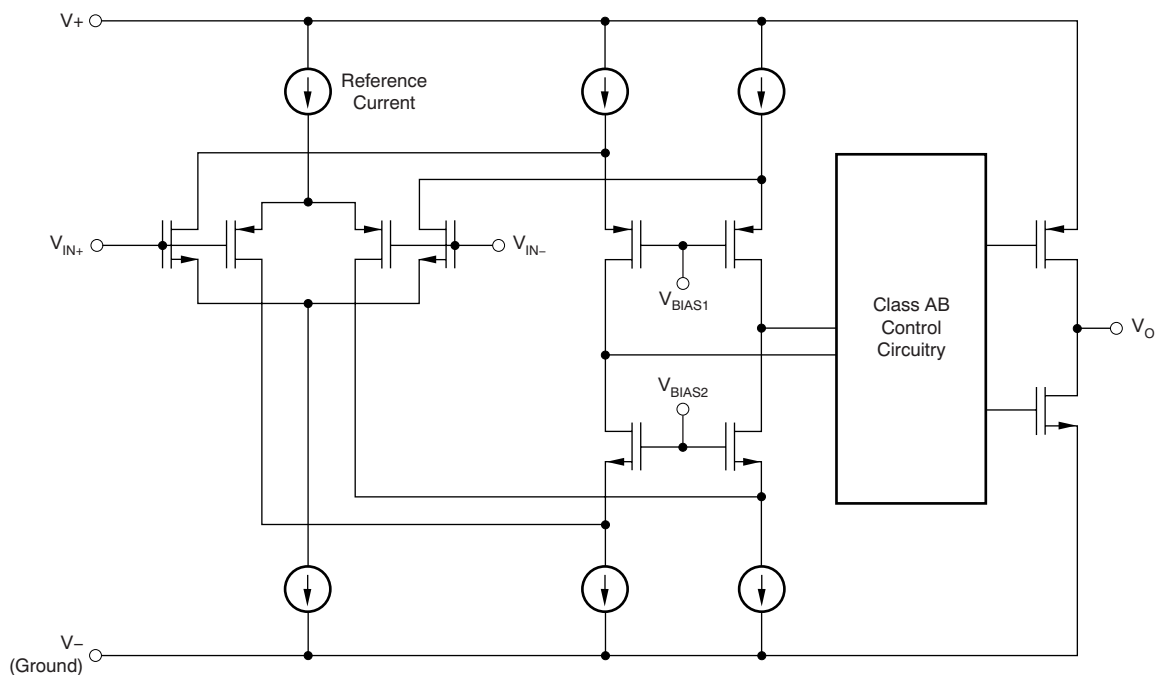

### 7.3 Feature Description

#### 7.3.1 Operating Voltage

The OPAx316 operational amplifiers are fully specified and ensured for operation from 1.8 V to 5.5 V. In addition, many specifications apply from  $-40^{\circ}\text{C}$  to  $+125^{\circ}\text{C}$ . Parameters that vary significantly with operating voltages or temperature are illustrated in the [Typical Characteristics](#) graphs.

#### 7.3.2 Rail-to-Rail Input

The input common-mode voltage range of the OPAx316 series extends 200 mV beyond the supply rails for supply voltages greater than 2.5 V. This performance is achieved with a complementary input stage: an N-channel input differential pair in parallel with a P-channel differential pair, as shown in the [Functional Block Diagram](#). The N-channel pair is active for input voltages close to the positive rail, typically  $(V+) - 1.4\text{ V}$  to 200 mV above the positive supply, whereas the P-channel pair is active for inputs from 200 mV below the negative

## Feature Description (continued)

supply to approximately  $(V+) - 1.4$  V. There is a small transition region, typically  $(V+) - 1.2$  V to  $(V+) - 1$  V, in which both pairs are on. This 200-mV transition region can vary up to 200 mV with process variation. Thus, the transition region (both stages on) can range from  $(V+) - 1.4$  V to  $(V+) - 1.2$  V on the low end, up to  $(V+) - 1$  V to  $(V+) - 0.8$  V on the high end. Within this transition region, PSRR, CMRR, offset voltage, offset drift, and THD can be degraded compared to device operation outside this region.

### 7.3.3 Input and ESD Protection

The OPAx316 incorporates internal ESD protection circuits on all pins. In the case of input and output pins, this protection primarily consists of current-steering diodes connected between the input and power-supply pins. These ESD protection diodes provide in-circuit, input overdrive protection, as long as the current is limited to 10 mA as stated in [Absolute Maximum Ratings](#). [Figure 37](#) shows how a series input resistor can be added to the driven input to limit the input current. The added resistor contributes thermal noise at the amplifier input and the value must be kept to a minimum in noise-sensitive applications.

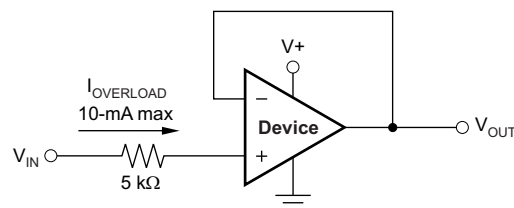

**Figure 37. Input Current Protection**

### 7.3.4 Common-Mode Rejection Ratio (CMRR)

CMRR for the OPAx316 is specified in several ways so the user can select the best match for a given application, as shown in [Electrical Characteristics](#). First, the data sheet gives the CMRR of the device in the common-mode range below the transition region [ $V_{CM} < (V+) - 1.4$  V]. This specification is the best indicator of device capability when the application requires use of one of the differential input pairs. Second, the CMRR over the entire common-mode range is specified at  $V_{CM} = -0.2$  V to 5.7 V for  $V_S = 5.5$  V. This last value includes the variations shown in [Figure 4](#) through the transition region.

### 7.3.5 EMI Susceptibility and Input Filtering

Operational amplifiers vary with regard to the susceptibility of the device to electromagnetic interference (EMI). If conducted EMI enters the operational amplifier, the dc offset observed at the amplifier output can shift from its nominal value when EMI is present. This shift is a result of signal rectification associated with the internal semiconductor junctions. Although all operational amplifier pin functions can be affected by EMI, the signal input pins are likely to be the most susceptible. The OPA316 operational amplifier family incorporates an internal input low-pass filter that reduces the amplifier response to EMI. This filter provides both common-mode and differential-mode filtering. The filter is designed for a cutoff frequency of approximately 80 MHz ( $-3$  dB), with a roll-off of 20 dB per decade.

TI developed the ability to accurately measure and quantify the immunity of an operational amplifier over a broad frequency spectrum extending from 10 MHz to 6 GHz. The EMI rejection ratio (EMIRR) metric allows operational amplifiers to be directly compared by the EMI immunity. [Figure 35](#) illustrates the results of this testing on the OPA316 series. For more information, see [EMI Rejection Ratio of Operational Amplifiers](#) (SBOA128).

### 7.3.6 Rail-to-Rail Output

Designed as a low-power, low-noise operational amplifier, the OPAx316 delivers a robust output drive capability. A class AB output stage with common-source transistors is used to achieve full rail-to-rail output swing capability. For resistive loads of 10-kΩ, the output swings typically to within 30 mV of either supply rail regardless of the power-supply voltage applied. Different load conditions change the ability of the amplifier to swing close to the rails; see the typical characteristic graph *Output Voltage Swing vs Output Current* ([Figure 11](#)).

## Feature Description (continued)

### 7.3.7 Capacitive Load and Stability

The OPAx316 is designed to be used in applications where driving a capacitive load is required. As with all operational amplifiers, there may be specific instances where the OPAx316 can become unstable. The particular operational amplifier circuit configuration, layout, gain, and output loading are some of the factors to consider when establishing whether or not an amplifier is stable in operation. An operational amplifier in the unity-gain (+1 V/V) buffer configuration that drives a capacitive load exhibits a greater tendency to be unstable than an amplifier operated at a higher noise gain. The capacitive load, in conjunction with the operational amplifier output resistance, creates a pole within the feedback loop that degrades the phase margin. The degradation of the phase margin increases as the capacitive loading increases. As a conservative best practice, designing for 25% overshoot (40° phase margin) provides improved stability over process variations. The equivalent series resistance (ESR) of some very-large capacitors ( $C_L$  greater than 1  $\mu\text{F}$ ) is sufficient to alter the phase characteristics in the feedback loop such that the amplifier remains stable. Increasing the amplifier closed-loop gain allows the amplifier to drive increasingly larger capacitance. This increased capability is evident when observing the overshoot response of the amplifier at higher voltage gains. See the typical characteristic graphs, *Small-Signal Overshoot vs Capacitive Load* (Figure 24,  $G = -1$  V/V) and *Small-Signal Overshoot vs Capacitive Load* (Figure 25,  $G = +1$  V/V).

One technique for increasing the capacitive load drive capability of the amplifier operating in a unity-gain configuration is to insert a small resistor (typically 10  $\Omega$  to 20  $\Omega$ ) in series with the output, as shown in Figure 38. This resistor significantly reduces the overshoot and ringing associated with large capacitive loads. One possible problem with this technique, however, is that a voltage divider is created with the added series resistor and any resistor connected in parallel with the capacitive load. The voltage divider introduces a gain error at the output that reduces the output swing.

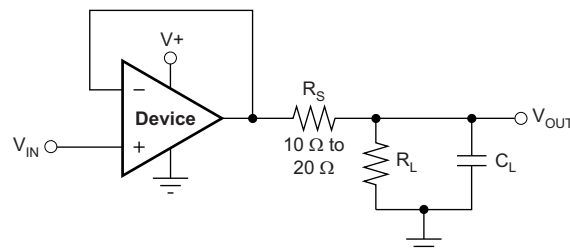

**Figure 38. Improving Capacitive Load Drive**

### 7.3.8 Overload Recovery

Overload recovery is defined as the time required for the operational amplifier output to recover from a saturated state to a linear state. The output devices of the operational amplifier enter a saturation region when the output voltage exceeds the rated operating voltage, either because of the high input voltage or the high gain. After the device enters the saturation region, the charge carriers in the output devices require time to return back to the linear state. After the charge carriers return back to the linear state, the device begins to slew at the specified slew rate. Thus, the propagation delay in case of an overload condition is the sum of the overload recovery time and the slew time. The overload recovery time for the OPAx316 is approximately 300 ns.

### 7.3.9 DFN Package

The OPA2316 (dual version) device uses the DFN style package (also known as SON); this package is a QFN with contacts on only two sides of the package bottom. This leadless package maximizes printed circuit board (PCB) space and offers enhanced thermal and electrical characteristics through an exposed pad. One of the primary advantages of the DFN package is the low, 0.9-mm height. DFN packages are physically small, have a smaller routing area, improved thermal performance, reduced electrical parasitics, and use a pinout scheme that is consistent with other commonly-used packages, such as SOIC and MSOP). Additionally, the absence of external leads eliminates bent-lead issues.

The DFN package can be simply mounted using standard PCB assembly techniques. See [QFN/Son PCB Attachment](#) (SLUA271), and [Quad Flatpack No-Lead Logic Packages](#) (SCBA017).

## Feature Description (continued)

---

### NOTE

Connect the exposed lead frame die pad on the bottom of the DFN package to the most negative potential ( $V^-$ ).

---

## 7.4 Device Functional Modes

The OPA316, OPA2316, and OPA4316 devices are powered on when the supply is connected. The devices can be operated as a single-supply operational amplifier or a dual-supply amplifier, depending on the application.

The OPA2316S device has a SHDN (enable) pin function referenced to the negative supply voltage of the operational amplifier. A logic level high enables the operational amplifier. A valid logic high is defined as voltage  $[(V^+) - 0.1 \text{ V}]$ , up to  $(V^+)$ , applied to the SHDN pin. A valid logic low is defined as  $[(V^-) + 0.1 \text{ V}]$ , down to  $(V^-)$ , applied to the enable pin. The maximum allowed voltage applied to SHDN is 5.5 V with respect to the negative supply, independent of the positive supply voltage. Connect this pin to a valid high or a low voltage or driven, but not left as an open circuit.

The logic input is a high-impedance CMOS input. Both inputs are independently controlled. For battery-operated applications, this feature can be used to greatly reduce the average current and extend battery life.

## 8 Application and Implementation

### NOTE

Information in the following applications sections is not part of the TI component specification, and TI does not warrant its accuracy or completeness. TI's customers are responsible for determining suitability of components for their purposes. Customers should validate and test their design implementation to confirm system functionality.

### 8.1 Application Information

#### 8.1.1 General Configurations

When receiving low-level signals, the device often requires limiting the bandwidth of the incoming signals into the system. The simplest way to establish this limited bandwidth is to place an RC filter at the noninverting pin of the amplifier, as Figure 39 shows.

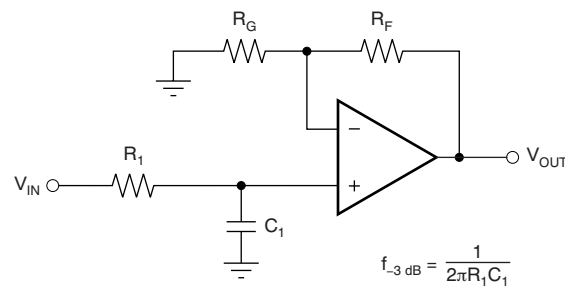

$$\frac{V_{OUT}}{V_{IN}} = \left(1 + \frac{R_F}{R_G}\right) \left(\frac{1}{1 + sR_1C_1}\right)$$

Figure 39. Single-Pole Low-Pass Filter

If even more attenuation is needed, the device requires a multiple-pole filter. The Sallen-Key filter can be used for this task, as Figure 40 shows. For best results, the amplifier must have a bandwidth that is 8 to 10 times the filter frequency bandwidth. Failure to follow this guideline can result in phase shift of the amplifier.

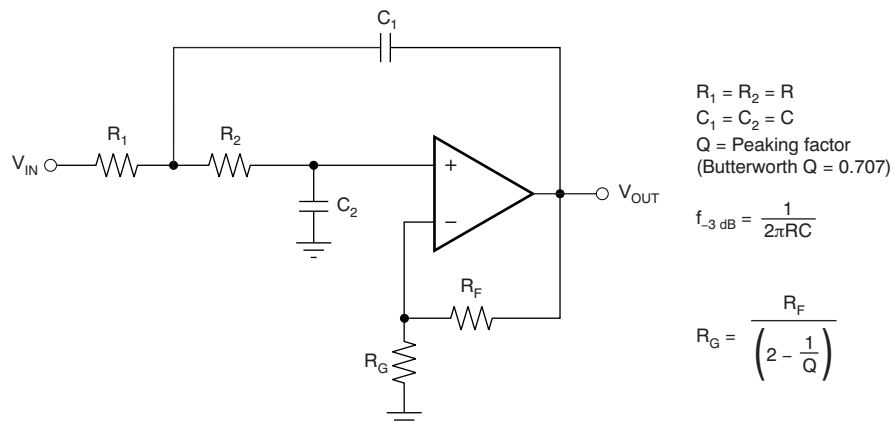
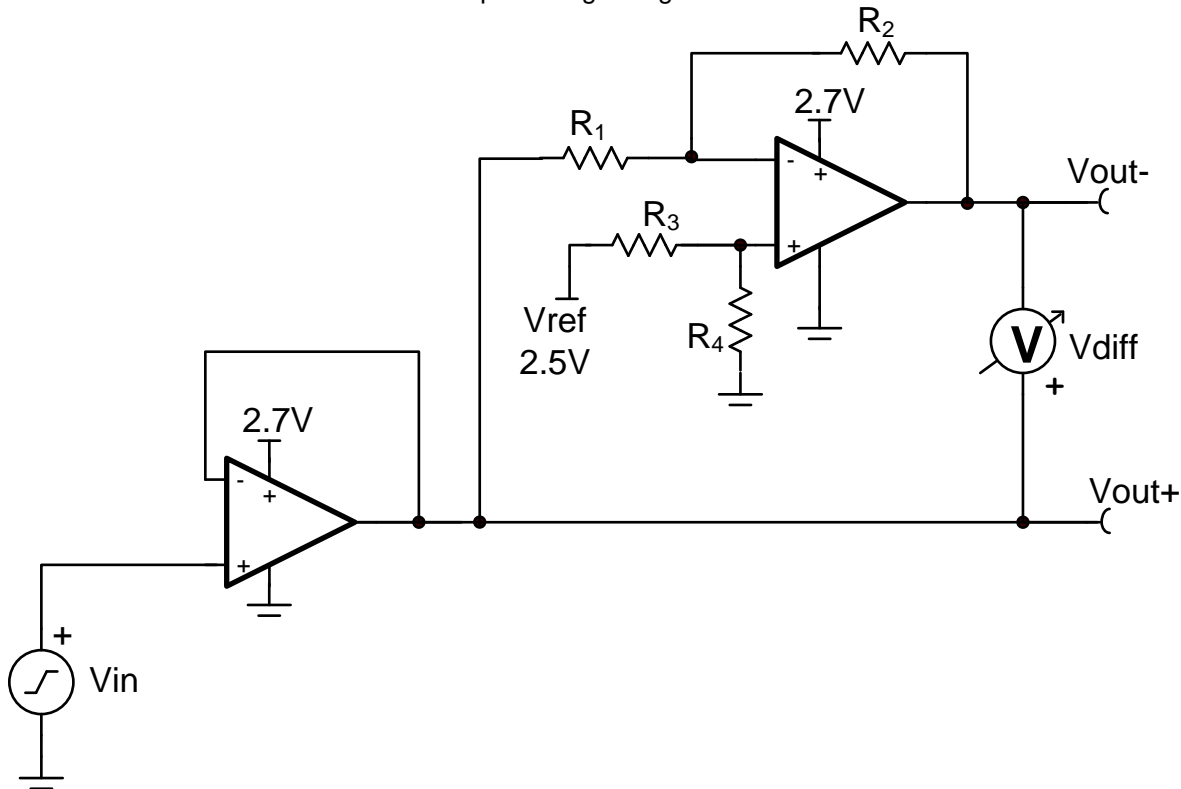

Figure 40. Two-Pole, Low-Pass, Sallen-Key Filter

## 8.2 Typical Application

Some applications require differential signals. [Figure 41](#) shows a simple circuit to convert a single-ended input of 0.1 V to 2.4 V into a differential output of  $\pm 2.3$  V on a single 2.7-V supply. The output range is intentionally limited to maximize linearity. The circuit is composed of two amplifiers. One amplifier functions as a buffer and creates a voltage,  $V_{OUT+}$ . The second amplifier inverts the input and adds a reference voltage to generate  $V_{OUT-}$ .  $V_{OUT+}$  and  $V_{OUT-}$  range from 0.1 V to 2.4 V. The difference,  $V_{DIFF}$ , is the difference between  $V_{OUT+}$  and  $V_{OUT-}$  which makes the differential output voltage range 2.3 V.



**Figure 41. Schematic for a Single-Ended Input to Differential Output Conversion**

### 8.2.1 Design Requirements

[Table 1](#) lists the design requirements:

**Table 1. Design Parameters**

| DESIGN PARAMETER            | VALUE          |
|-----------------------------|----------------|
| Supply voltage              | 2.7 V          |
| Reference voltage           | 2.5 V          |
| Input voltage               | 0.1 V to 2.4 V |
| Output differential voltage | $\pm 2.3$ V    |
| Output common-mode voltage  | 1.25 V         |
| Small-signal bandwidth      | 5 MHz          |

### 8.2.2 Detailed Design Procedure

The circuit in [Figure 41](#) takes a single-ended input signal,  $V_{IN}$ , and generates two output signals,  $V_{OUT+}$  and  $V_{OUT-}$  using two amplifiers and a reference voltage,  $V_{REF}$ .  $V_{OUT+}$  is the output of the first amplifier and is a buffered version of the input signal,  $V_{IN}$  (as shown in [Equation 1](#)).  $V_{OUT-}$  is the output of the second amplifier which uses  $V_{REF}$  to add an offset voltage to  $V_{IN}$  and feedback to add inverting gain. The transfer function for  $V_{OUT-}$  is given in [Equation 2](#).

$$V_{out+} = V_{in} \quad (1)$$

$$V_{out-} = V_{ref} \times \left( \frac{R_4}{R_3 + R_4} \right) \times \left( 1 + \frac{R_2}{R_1} \right) - V_{in} \times \frac{R_2}{R_1} \quad (2)$$

The differential output signal, VDIFF, is the difference between the two single-ended output signals, VOUT+ and VOUT-. Equation 3 shows the transfer function for VDIFF. Using conditions in Equation 4 and Equation 5 and applying the conditions that  $R_1 = R_2$  and  $R_3 = R_4$ , the transfer function is simplified into Equation 6. Using this configuration, the maximum input signal is equal to the reference voltage, and the maximum output of each amplifier is equal to VREF. The differential output range is  $2 \times VREF$ . Furthermore, the common-mode voltage is one half of VREF, as shown in Equation 7.

$$V_{diff} = V_{out+} - V_{out-} = V_{in} \times \left( 1 + \frac{R_2}{R_1} \right) - V_{ref} \times \left( \frac{R_4}{R_3 + R_4} \right) \times \left( 1 + \frac{R_2}{R_1} \right) \quad (3)$$

$$V_{out+} = V_{in} \quad (4)$$

$$V_{out-} = V_{ref} - V_{in} \quad (5)$$

$$V_{diff} = 2 \times V_{in} - V_{ref} \quad (6)$$

$$V_{cm} = \left( \frac{V_{out+} + V_{out-}}{2} \right) = \frac{1}{2} V_{ref} \quad (7)$$

### 8.2.2.1 Amplifier Selection

Linearity over the input range is key for good dc accuracy. The common-mode input range and output swing limitations determine the linearity. In general, an amplifier with rail-to-rail input and output swing is required. Bandwidth is a key concern for this design, so the OPAX316 is selected because the bandwidth is greater than the target of 5 MHz. The bandwidth and power ratio makes this device power efficient and the low offset and drift ensure good accuracy for moderate precision applications.

### 8.2.2.2 Passive Component Selection

Because the transfer function of VOUT- is heavily reliant on resistors ( $R_1$ ,  $R_2$ ,  $R_3$ , and  $R_4$ ), use resistors with low tolerances to maximize performance and minimize error. This design uses resistors with resistance values of 49.9 k $\Omega$  and tolerances of 0.1%. However, if the noise of the system is a key parameter, smaller resistance values (6 k $\Omega$  or lower) can be selected to keep the overall system noise low. This ensures that the noise from the resistors is lower than the amplifier noise.

### 8.2.3 Application Curves

The measured transfer functions in [Figure 42](#), [Figure 43](#), and [Figure 44](#) are generated by sweeping the input voltage from 0.1 V to 2.4 V. The full input range is actually 0 V to 2.5 V, but is restricted by 0.1 V to maintain optimal linearity. For more details on this design and other alternative devices that can be used in place of the OPAx316, see ([Single-Ended Input to Differential Output Conversion Circuit Reference Design](#) (TIPD131)).

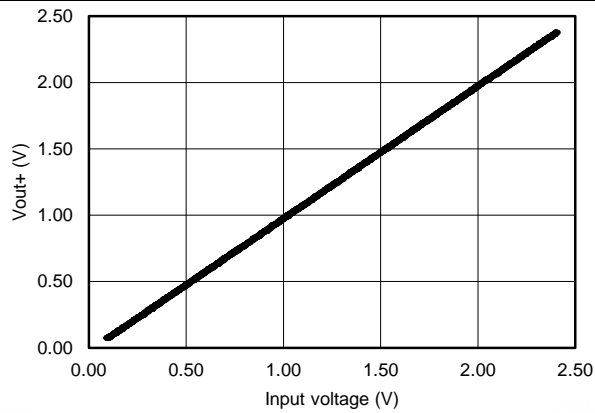

Figure 42. VOUT+ vs Input Voltage

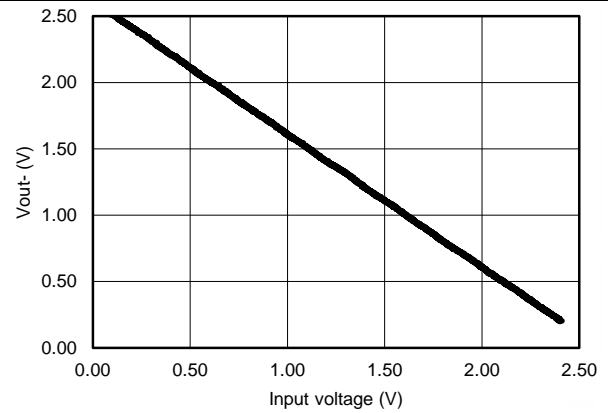

Figure 43. VOUT- vs Input Voltage

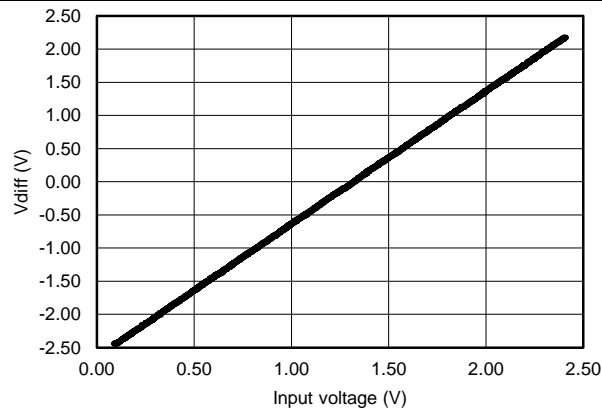

Figure 44. VDIFF vs Input Voltage

## 9 Power Supply Recommendations

The OPAx316 is specified for operation from 1.8 V to 5.5 V ( $\pm 0.9$  V to  $\pm 2.75$  V); many specifications apply from  $-40^{\circ}\text{C}$  to  $+125^{\circ}\text{C}$ . [Typical Characteristics](#) presents parameters that can exhibit significant variance with regard to operating voltage or temperature.

### CAUTION

Supply voltages larger than 7 V can permanently damage the device (see the [Absolute Maximum Ratings](#)) table.

Place 0.1- $\mu\text{F}$  bypass capacitors close to the power-supply pins to reduce errors coupling in from noisy or high-impedance power supplies. For more information on bypass capacitor placement, see [Layout Guidelines](#).

## 10 Layout

### 10.1 Layout Guidelines

For best operational performance of the device, use good PCB layout practices, including:

- Noise can propagate into analog circuitry through the power pins of the circuit as a whole and the operational amplifier. Bypass capacitors reduce the coupled noise by providing low-impedance power sources local to the analog circuitry.
  - Connect low-ESR, 0.1- $\mu$ F ceramic bypass capacitors between each supply pin and ground, placed as close to the device as possible. A single bypass capacitor from V+ to ground is applicable for single-supply applications.
- Separate grounding for analog and digital portions of the circuitry is one of the simplest and most effective methods of noise suppression. One or more layers on multilayer PCBs are typically devoted to ground planes. A ground plane helps distribute heat and reduces EMI noise pickup. Take care to physically separate digital and analog grounds, paying attention to the flow of the ground current. For more detailed information, see [Circuit Board Layout Techniques](#) (SLOA089).
- To reduce parasitic coupling, run the input traces as far away from the supply or output traces as possible. If these traces cannot be kept separate, crossing the sensitive trace perpendicularly is much better than crossing in parallel with the noisy trace.
- Place the external components as close to the device as possible. Keeping RF and RG close to the inverting input minimizes parasitic capacitance, as shown in [Layout Example](#).
- Keep the length of input traces as short as possible. Remember that the input traces are the most sensitive part of the circuit.
- Consider a driven, low-impedance guard ring around the critical traces. A guard ring can significantly reduce leakage currents from nearby traces that are at different potentials.

### 10.2 Layout Example

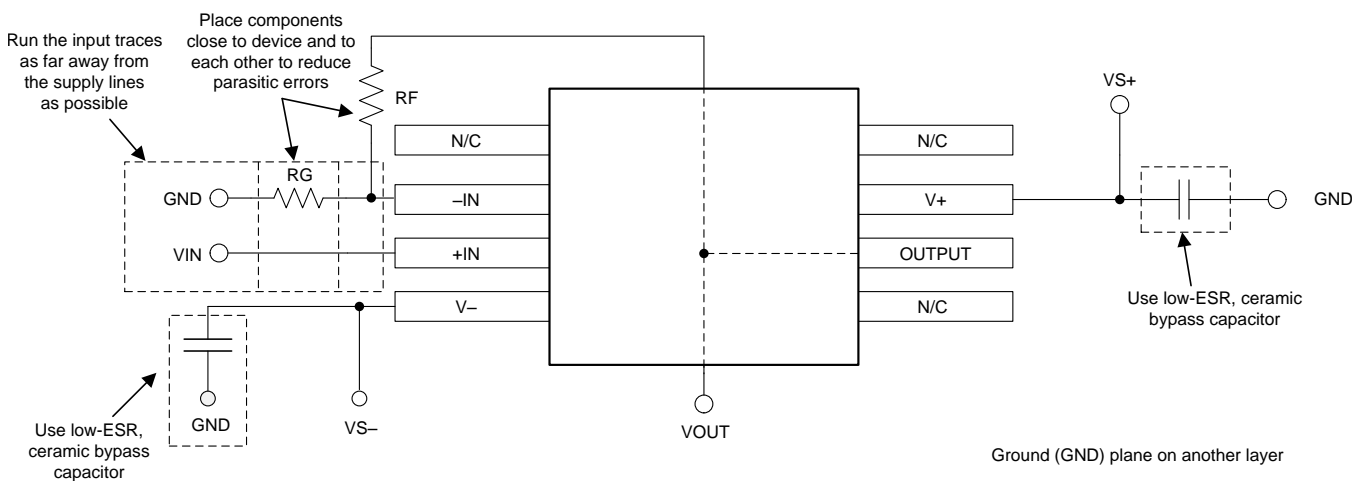

Figure 45. Operational Amplifier Board Layout for Noninverting Configuration

## 11 Device and Documentation Support

### 11.1 Documentation Support

#### 11.1.1 Related Documentation

For related documentation see the following:

- [EMI Rejection Ratio of Operational Amplifiers](#) (SBOA128).
- [QFN/SON PCB Attachment](#) (SLUA271).
- [Quad Flatpack No-Lead Logic Packages](#) (SCBA017).
- [Single-Ended Input to Differential Output Conversion Circuit Reference Design](#) (TIPD131).
- [Circuit Board Layout Techniques](#) (SLOA089).

#### 11.2 Related Links

The following table lists quick access links. Categories include technical documents, support and community resources, tools and software, and quick access to sample or buy.

**Table 2. Related Links**

| PARTS    | PRODUCT FOLDER             | SAMPLE & BUY               | TECHNICAL DOCUMENTS        | TOOLS & SOFTWARE           | SUPPORT & COMMUNITY        |
|----------|----------------------------|----------------------------|----------------------------|----------------------------|----------------------------|
| OPA316   | <a href="#">Click here</a> | <a href="#">Click here</a> | <a href="#">Click here</a> | <a href="#">Click here</a> | <a href="#">Click here</a> |
| OPA2316  | <a href="#">Click here</a> | <a href="#">Click here</a> | <a href="#">Click here</a> | <a href="#">Click here</a> | <a href="#">Click here</a> |
| OPA2316S | <a href="#">Click here</a> | <a href="#">Click here</a> | <a href="#">Click here</a> | <a href="#">Click here</a> | <a href="#">Click here</a> |
| OPA4316  | <a href="#">Click here</a> | <a href="#">Click here</a> | <a href="#">Click here</a> | <a href="#">Click here</a> | <a href="#">Click here</a> |

#### 11.3 Receiving Notification of Documentation Updates

To receive notification of documentation updates, navigate to the device product folder on ti.com. In the upper right corner, click on *Alert me* to register and receive a weekly digest of any product information that has changed. For change details, review the revision history included in any revised document.

#### 11.4 Community Resources

The following links connect to TI community resources. Linked contents are provided "AS IS" by the respective contributors. They do not constitute TI specifications and do not necessarily reflect TI's views; see TI's [Terms of Use](#).

**TI E2E™ Online Community** *TI's Engineer-to-Engineer (E2E) Community*. Created to foster collaboration among engineers. At [e2e.ti.com](http://e2e.ti.com), you can ask questions, share knowledge, explore ideas and help solve problems with fellow engineers.

**Design Support** *TI's Design Support* Quickly find helpful E2E forums along with design support tools and contact information for technical support.

#### 11.5 Trademarks

E2E is a trademark of Texas Instruments.  
All other trademarks are the property of their respective owners.

#### 11.6 Electrostatic Discharge Caution



These devices have limited built-in ESD protection. The leads should be shorted together or the device placed in conductive foam during storage or handling to prevent electrostatic damage to the MOS gates.

#### 11.7 Glossary

**SLYZ022** — *TI Glossary*.

This glossary lists and explains terms, acronyms, and definitions.

## 12 Mechanical, Packaging, and Orderable Information

The following pages include mechanical, packaging, and orderable information. This information is the most current data available for the designated devices. This data is subject to change without notice and revision of this document. For browser-based versions of this data sheet, refer to the left-hand navigation.

**PACKAGING INFORMATION**

| Orderable part number         | Status<br>(1) | Material type<br>(2) | Package   Pins   | Package qty   Carrier | RoHS<br>(3) | Lead finish/<br>Ball material<br>(4) | MSL rating/<br>Peak reflow<br>(5) | Op temp (°C) | Part marking<br>(6) |
|-------------------------------|---------------|----------------------|------------------|-----------------------|-------------|--------------------------------------|-----------------------------------|--------------|---------------------|
| <a href="#">OPA2316ID</a>     | Active        | Production           | SOIC (D)   8     | 75   TUBE             | Yes         | NIPDAU                               | Level-2-260C-1 YEAR               | -40 to 125   | O2316               |
| OPA2316ID.B                   | Active        | Production           | SOIC (D)   8     | 75   TUBE             | Yes         | NIPDAU                               | Level-2-260C-1 YEAR               | -40 to 125   | O2316               |
| <a href="#">OPA2316IDGK</a>   | Active        | Production           | VSSOP (DGK)   8  | 80   TUBE             | Yes         | NIPDAUAG                             | Level-2-260C-1 YEAR               | -40 to 125   | OVMQ                |
| OPA2316IDGK.B                 | Active        | Production           | VSSOP (DGK)   8  | 80   TUBE             | Yes         | NIPDAUAG                             | Level-2-260C-1 YEAR               | -40 to 125   | OVMQ                |
| <a href="#">OPA2316IDGKR</a>  | Active        | Production           | VSSOP (DGK)   8  | 2500   LARGE T&R      | Yes         | NIPDAU   SN                          | Level-2-260C-1 YEAR               | -40 to 125   | OVMQ                |
| OPA2316IDGKR.B                | Active        | Production           | VSSOP (DGK)   8  | 2500   LARGE T&R      | Yes         | NIPDAU                               | Level-2-260C-1 YEAR               | -40 to 125   | OVMQ                |
| <a href="#">OPA2316IDR</a>    | Active        | Production           | SOIC (D)   8     | 2500   LARGE T&R      | Yes         | NIPDAU                               | Level-2-260C-1 YEAR               | -40 to 125   | O2316               |
| OPA2316IDR.B                  | Active        | Production           | SOIC (D)   8     | 2500   LARGE T&R      | Yes         | NIPDAU                               | Level-2-260C-1 YEAR               | -40 to 125   | O2316               |
| <a href="#">OPA2316IDRGR</a>  | Active        | Production           | SON (DRG)   8    | 3000   LARGE T&R      | Yes         | NIPDAU                               | Level-1-260C-UNLIM                | -40 to 125   | SMD                 |
| OPA2316IDRGR.B                | Active        | Production           | SON (DRG)   8    | 3000   LARGE T&R      | Yes         | NIPDAU                               | Level-1-260C-UNLIM                | -40 to 125   | SMD                 |
| OPA2316IDRGRG4                | Active        | Production           | SON (DRG)   8    | 3000   LARGE T&R      | Yes         | NIPDAU                               | Level-1-260C-UNLIM                | -40 to 125   | SMD                 |
| OPA2316IDRGRG4.B              | Active        | Production           | SON (DRG)   8    | 3000   LARGE T&R      | Yes         | NIPDAU                               | Level-1-260C-UNLIM                | -40 to 125   | SMD                 |
| <a href="#">OPA2316IDRGT</a>  | Active        | Production           | SON (DRG)   8    | 250   SMALL T&R       | Yes         | NIPDAU                               | Level-1-260C-UNLIM                | -40 to 125   | SMD                 |
| OPA2316IDRGT.B                | Active        | Production           | SON (DRG)   8    | 250   SMALL T&R       | Yes         | NIPDAU                               | Level-1-260C-UNLIM                | -40 to 125   | SMD                 |
| <a href="#">OPA2316SIDGS</a>  | Active        | Production           | VSSOP (DGS)   10 | 80   TUBE             | Yes         | NIPDAUAG                             | Level-2-260C-1 YEAR               | -40 to 125   | SMG                 |
| OPA2316SIDGS.B                | Active        | Production           | VSSOP (DGS)   10 | 80   TUBE             | Yes         | NIPDAUAG                             | Level-2-260C-1 YEAR               | -40 to 125   | SMG                 |
| <a href="#">OPA2316SIDGSR</a> | Active        | Production           | VSSOP (DGS)   10 | 2500   LARGE T&R      | Yes         | NIPDAUAG   SN                        | Level-2-260C-1 YEAR               | -40 to 125   | SMG                 |
| OPA2316SIDGSR.B               | Active        | Production           | VSSOP (DGS)   10 | 2500   LARGE T&R      | Yes         | SN                                   | Level-2-260C-1 YEAR               | -40 to 125   | SMG                 |
| <a href="#">OPA2316SIRUGR</a> | Active        | Production           | X2QFN (RUG)   10 | 3000   LARGE T&R      | Yes         | NIPDAU                               | Level-1-260C-UNLIM                | -40 to 125   | 1QU                 |
| OPA2316SIRUGR.B               | Active        | Production           | X2QFN (RUG)   10 | 3000   LARGE T&R      | Yes         | NIPDAU                               | Level-1-260C-UNLIM                | -40 to 125   | 1QU                 |
| OPA2316SIRUGRG4               | Active        | Production           | X2QFN (RUG)   10 | 3000   LARGE T&R      | Yes         | NIPDAU                               | Level-1-260C-UNLIM                | -40 to 125   | 1QU                 |
| OPA2316SIRUGRG4.B             | Active        | Production           | X2QFN (RUG)   10 | 3000   LARGE T&R      | Yes         | NIPDAU                               | Level-1-260C-UNLIM                | -40 to 125   | 1QU                 |
| <a href="#">OPA2316SIRUGT</a> | Active        | Production           | X2QFN (RUG)   10 | 250   SMALL T&R       | Yes         | NIPDAU                               | Level-1-260C-UNLIM                | -40 to 125   | 1QU                 |
| OPA2316SIRUGT.B               | Active        | Production           | X2QFN (RUG)   10 | 250   SMALL T&R       | Yes         | NIPDAU                               | Level-1-260C-UNLIM                | -40 to 125   | 1QU                 |
| <a href="#">OPA316IDBVR</a>   | Active        | Production           | SOT-23 (DBV)   5 | 3000   LARGE T&R      | Yes         | NIPDAU                               | Level-2-260C-1 YEAR               | -40 to 125   | SLE                 |
| OPA316IDBVR.B                 | Active        | Production           | SOT-23 (DBV)   5 | 3000   LARGE T&R      | Yes         | NIPDAU                               | Level-2-260C-1 YEAR               | -40 to 125   | SLE                 |
| <a href="#">OPA316IDBVT</a>   | Active        | Production           | SOT-23 (DBV)   5 | 250   SMALL T&R       | Yes         | NIPDAU                               | Level-2-260C-1 YEAR               | -40 to 125   | SLE                 |
| OPA316IDBVT.B                 | Active        | Production           | SOT-23 (DBV)   5 | 250   SMALL T&R       | Yes         | NIPDAU                               | Level-2-260C-1 YEAR               | -40 to 125   | SLE                 |
| OPA316IDBVTG4                 | Active        | Production           | SOT-23 (DBV)   5 | 250   SMALL T&R       | Yes         | NIPDAU                               | Level-2-260C-1 YEAR               | -40 to 125   | SLE                 |

| Orderable part number       | Status<br>(1) | Material type<br>(2) | Package   Pins   | Package qty   Carrier | RoHS<br>(3) | Lead finish/<br>Ball material<br>(4) | MSL rating/<br>Peak reflow<br>(5) | Op temp (°C) | Part marking<br>(6) |
|-----------------------------|---------------|----------------------|------------------|-----------------------|-------------|--------------------------------------|-----------------------------------|--------------|---------------------|
| OPA316IDBVTG4.B             | Active        | Production           | SOT-23 (DBV)   5 | 250   SMALL T&R       | Yes         | NIPDAU                               | Level-2-260C-1 YEAR               | -40 to 125   | SLE                 |
| <a href="#">OPA316IDCKR</a> | Active        | Production           | SC70 (DCK)   5   | 3000   LARGE T&R      | Yes         | NIPDAU   SN                          | Level-1-260C-UNLIM                | -40 to 125   | SLD                 |
| OPA316IDCKR.B               | Active        | Production           | SC70 (DCK)   5   | 3000   LARGE T&R      | Yes         | SN                                   | Level-1-260C-UNLIM                | -40 to 125   | SLD                 |
| <a href="#">OPA316IDCKT</a> | Active        | Production           | SC70 (DCK)   5   | 250   SMALL T&R       | Yes         | NIPDAU   SN                          | Level-1-260C-UNLIM                | -40 to 125   | SLD                 |
| OPA316IDCKT.B               | Active        | Production           | SC70 (DCK)   5   | 250   SMALL T&R       | Yes         | SN                                   | Level-1-260C-UNLIM                | -40 to 125   | SLD                 |
| OPA316IDCKTG4               | Active        | Production           | SC70 (DCK)   5   | 250   SMALL T&R       | Yes         | NIPDAU                               | Level-1-260C-UNLIM                | -40 to 125   | SLD                 |
| OPA316IDCKTG4.B             | Active        | Production           | SC70 (DCK)   5   | 250   SMALL T&R       | Yes         | NIPDAU                               | Level-1-260C-UNLIM                | -40 to 125   | SLD                 |
| <a href="#">OPA4316ID</a>   | Active        | Production           | SOIC (D)   14    | 50   TUBE             | Yes         | NIPDAU                               | Level-2-260C-1 YEAR               | -40 to 125   | O4316D              |
| OPA4316ID.B                 | Active        | Production           | SOIC (D)   14    | 50   TUBE             | Yes         | NIPDAU                               | Level-2-260C-1 YEAR               | -40 to 125   | O4316D              |
| <a href="#">OPA4316IDR</a>  | Active        | Production           | SOIC (D)   14    | 2500   LARGE T&R      | Yes         | NIPDAU                               | Level-2-260C-1 YEAR               | -40 to 125   | O4316D              |
| OPA4316IDR.B                | Active        | Production           | SOIC (D)   14    | 2500   LARGE T&R      | Yes         | NIPDAU                               | Level-2-260C-1 YEAR               | -40 to 125   | O4316D              |
| OPA4316IDRG4                | Active        | Production           | SOIC (D)   14    | 2500   LARGE T&R      | Yes         | NIPDAU                               | Level-2-260C-1 YEAR               | -40 to 125   | O4316D              |
| OPA4316IDRG4.B              | Active        | Production           | SOIC (D)   14    | 2500   LARGE T&R      | Yes         | NIPDAU                               | Level-2-260C-1 YEAR               | -40 to 125   | O4316D              |
| <a href="#">OPA4316IPW</a>  | Active        | Production           | TSSOP (PW)   14  | 90   TUBE             | Yes         | NIPDAU                               | Level-2-260C-1 YEAR               | -40 to 125   | OPA4316             |
| OPA4316IPW.B                | Active        | Production           | TSSOP (PW)   14  | 90   TUBE             | Yes         | NIPDAU                               | Level-2-260C-1 YEAR               | -40 to 125   | OPA4316             |
| <a href="#">OPA4316IPWR</a> | Active        | Production           | TSSOP (PW)   14  | 2000   LARGE T&R      | Yes         | NIPDAU                               | Level-2-260C-1 YEAR               | -40 to 125   | OPA4316             |
| OPA4316IPWR.B               | Active        | Production           | TSSOP (PW)   14  | 2000   LARGE T&R      | Yes         | NIPDAU                               | Level-2-260C-1 YEAR               | -40 to 125   | OPA4316             |
| OPA4316IPWRG4               | Active        | Production           | TSSOP (PW)   14  | 2000   LARGE T&R      | Yes         | NIPDAU                               | Level-2-260C-1 YEAR               | -40 to 125   | OPA4316             |
| OPA4316IPWRG4.B             | Active        | Production           | TSSOP (PW)   14  | 2000   LARGE T&R      | Yes         | NIPDAU                               | Level-2-260C-1 YEAR               | -40 to 125   | OPA4316             |

(1) **Status:** For more details on status, see our [product life cycle](#).

(2) **Material type:** When designated, preproduction parts are prototypes/experimental devices, and are not yet approved or released for full production. Testing and final process, including without limitation quality assurance, reliability performance testing, and/or process qualification, may not yet be complete, and this item is subject to further changes or possible discontinuation. If available for ordering, purchases will be subject to an additional waiver at checkout, and are intended for early internal evaluation purposes only. These items are sold without warranties of any kind.

(3) **RoHS values:** Yes, No, RoHS Exempt. See the [TI RoHS Statement](#) for additional information and value definition.

(4) **Lead finish/Ball material:** Parts may have multiple material finish options. Finish options are separated by a vertical ruled line. Lead finish/Ball material values may wrap to two lines if the finish value exceeds the maximum column width.

(5) **MSL rating/Peak reflow:** The moisture sensitivity level ratings and peak solder (reflow) temperatures. In the event that a part has multiple moisture sensitivity ratings, only the lowest level per JEDEC standards is shown. Refer to the shipping label for the actual reflow temperature that will be used to mount the part to the printed circuit board.

(6) **Part marking:** There may be an additional marking, which relates to the logo, the lot trace code information, or the environmental category of the part.

Multiple part markings will be inside parentheses. Only one part marking contained in parentheses and separated by a "~" will appear on a part. If a line is indented then it is a continuation of the previous line and the two combined represent the entire part marking for that device.

**Important Information and Disclaimer:**The information provided on this page represents TI's knowledge and belief as of the date that it is provided. TI bases its knowledge and belief on information provided by third parties, and makes no representation or warranty as to the accuracy of such information. Efforts are underway to better integrate information from third parties. TI has taken and continues to take reasonable steps to provide representative and accurate information but may not have conducted destructive testing or chemical analysis on incoming materials and chemicals. TI and TI suppliers consider certain information to be proprietary, and thus CAS numbers and other limited information may not be available for release.

In no event shall TI's liability arising out of such information exceed the total purchase price of the TI part(s) at issue in this document sold by TI to Customer on an annual basis.

**OTHER QUALIFIED VERSIONS OF OPA2316, OPA316, OPA4316 :**

- Automotive : [OPA2316-Q1](#), [OPA316-Q1](#), [OPA4316-Q1](#)

NOTE: Qualified Version Definitions:

- Automotive - Q100 devices qualified for high-reliability automotive applications targeting zero defects

**TAPE AND REEL INFORMATION**

**QUADRANT ASSIGNMENTS FOR PIN 1 ORIENTATION IN TAPE**

\*All dimensions are nominal

| Device          | Package Type | Package Drawing | Pins | SPQ  | Reel Diameter (mm) | Reel Width W1 (mm) | A0 (mm) | B0 (mm) | K0 (mm) | P1 (mm) | W (mm) | Pin1 Quadrant |
|-----------------|--------------|-----------------|------|------|--------------------|--------------------|---------|---------|---------|---------|--------|---------------|
| OPA2316IDGKR    | VSSOP        | DGK             | 8    | 2500 | 330.0              | 12.4               | 5.25    | 3.35    | 1.25    | 8.0     | 12.0   | Q1            |
| OPA2316IDGKR    | VSSOP        | DGK             | 8    | 2500 | 330.0              | 12.4               | 5.3     | 3.4     | 1.4     | 8.0     | 12.0   | Q1            |
| OPA2316IDR      | SOIC         | D               | 8    | 2500 | 330.0              | 12.4               | 6.4     | 5.2     | 2.1     | 8.0     | 12.0   | Q1            |
| OPA2316IDRGR    | SON          | DRG             | 8    | 3000 | 330.0              | 12.4               | 3.3     | 3.3     | 1.1     | 8.0     | 12.0   | Q2            |
| OPA2316IDRGRG4  | SON          | DRG             | 8    | 3000 | 330.0              | 12.4               | 3.3     | 3.3     | 1.1     | 8.0     | 12.0   | Q2            |
| OPA2316IDRGT    | SON          | DRG             | 8    | 250  | 180.0              | 12.4               | 3.3     | 3.3     | 1.1     | 8.0     | 12.0   | Q2            |
| OPA2316SIDGSR   | VSSOP        | DGS             | 10   | 2500 | 330.0              | 12.4               | 5.25    | 3.35    | 1.25    | 8.0     | 12.0   | Q1            |
| OPA2316SIRUGR   | X2QFN        | RUG             | 10   | 3000 | 180.0              | 8.4                | 1.75    | 2.25    | 0.55    | 4.0     | 8.0    | Q1            |
| OPA2316SIRUGRG4 | X2QFN        | RUG             | 10   | 3000 | 180.0              | 8.4                | 1.75    | 2.25    | 0.55    | 4.0     | 8.0    | Q1            |
| OPA2316SIRUGT   | X2QFN        | RUG             | 10   | 250  | 180.0              | 8.4                | 1.75    | 2.25    | 0.55    | 4.0     | 8.0    | Q1            |
| OPA316IDBVR     | SOT-23       | DBV             | 5    | 3000 | 178.0              | 9.0                | 3.3     | 3.2     | 1.4     | 4.0     | 8.0    | Q3            |
| OPA316IDBVT     | SOT-23       | DBV             | 5    | 250  | 178.0              | 9.0                | 3.23    | 3.17    | 1.37    | 4.0     | 8.0    | Q3            |
| OPA316IDBVTG4   | SOT-23       | DBV             | 5    | 250  | 178.0              | 9.0                | 3.23    | 3.17    | 1.37    | 4.0     | 8.0    | Q3            |
| OPA316IDCKR     | SC70         | DCK             | 5    | 3000 | 180.0              | 8.4                | 2.3     | 2.5     | 1.2     | 4.0     | 8.0    | Q3            |
| OPA316IDCKT     | SC70         | DCK             | 5    | 250  | 180.0              | 8.4                | 2.3     | 2.5     | 1.2     | 4.0     | 8.0    | Q3            |
| OPA316IDCKTG4   | SC70         | DCK             | 5    | 250  | 178.0              | 9.0                | 2.4     | 2.5     | 1.2     | 4.0     | 8.0    | Q3            |

| Device        | Package Type | Package Drawing | Pins | SPQ  | Reel Diameter (mm) | Reel Width W1 (mm) | A0 (mm) | B0 (mm) | K0 (mm) | P1 (mm) | W (mm) | Pin1 Quadrant |
|---------------|--------------|-----------------|------|------|--------------------|--------------------|---------|---------|---------|---------|--------|---------------|
| OPA4316IDR    | SOIC         | D               | 14   | 2500 | 330.0              | 16.4               | 6.5     | 9.0     | 2.1     | 8.0     | 16.0   | Q1            |
| OPA4316IDRG4  | SOIC         | D               | 14   | 2500 | 330.0              | 16.4               | 6.5     | 9.0     | 2.1     | 8.0     | 16.0   | Q1            |
| OPA4316IPWR   | TSSOP        | PW              | 14   | 2000 | 330.0              | 12.4               | 6.9     | 5.6     | 1.6     | 8.0     | 12.0   | Q1            |
| OPA4316IPWRG4 | TSSOP        | PW              | 14   | 2000 | 330.0              | 12.4               | 6.9     | 5.6     | 1.6     | 8.0     | 12.0   | Q1            |

## TAPE AND REEL BOX DIMENSIONS



\*All dimensions are nominal

| Device          | Package Type | Package Drawing | Pins | SPQ  | Length (mm) | Width (mm) | Height (mm) |
|-----------------|--------------|-----------------|------|------|-------------|------------|-------------|
| OPA2316IDGKR    | VSSOP        | DGK             | 8    | 2500 | 366.0       | 364.0      | 50.0        |
| OPA2316IDGKR    | VSSOP        | DGK             | 8    | 2500 | 353.0       | 353.0      | 32.0        |
| OPA2316IDR      | SOIC         | D               | 8    | 2500 | 353.0       | 353.0      | 32.0        |
| OPA2316IDRGR    | SON          | DRG             | 8    | 3000 | 346.0       | 346.0      | 33.0        |
| OPA2316IDRGRG4  | SON          | DRG             | 8    | 3000 | 346.0       | 346.0      | 33.0        |
| OPA2316IDRGT    | SON          | DRG             | 8    | 250  | 182.0       | 182.0      | 20.0        |
| OPA2316SIDGSR   | VSSOP        | DGS             | 10   | 2500 | 366.0       | 364.0      | 50.0        |
| OPA2316SIRUGR   | X2QFN        | RUG             | 10   | 3000 | 210.0       | 185.0      | 35.0        |
| OPA2316SIRUGRG4 | X2QFN        | RUG             | 10   | 3000 | 210.0       | 185.0      | 35.0        |
| OPA2316SIRUGT   | X2QFN        | RUG             | 10   | 250  | 210.0       | 185.0      | 35.0        |
| OPA316IDBVR     | SOT-23       | DBV             | 5    | 3000 | 180.0       | 180.0      | 18.0        |
| OPA316IDBVT     | SOT-23       | DBV             | 5    | 250  | 180.0       | 180.0      | 18.0        |
| OPA316IDBVTG4   | SOT-23       | DBV             | 5    | 250  | 180.0       | 180.0      | 18.0        |
| OPA316IDCKR     | SC70         | DCK             | 5    | 3000 | 210.0       | 185.0      | 35.0        |
| OPA316IDCKT     | SC70         | DCK             | 5    | 250  | 210.0       | 185.0      | 35.0        |
| OPA316IDCKTG4   | SC70         | DCK             | 5    | 250  | 180.0       | 180.0      | 18.0        |
| OPA4316IDR      | SOIC         | D               | 14   | 2500 | 353.0       | 353.0      | 32.0        |
| OPA4316IDRG4    | SOIC         | D               | 14   | 2500 | 353.0       | 353.0      | 32.0        |

---

| Device        | Package Type | Package Drawing | Pins | SPQ  | Length (mm) | Width (mm) | Height (mm) |
|---------------|--------------|-----------------|------|------|-------------|------------|-------------|
| OPA4316IPWR   | TSSOP        | PW              | 14   | 2000 | 353.0       | 353.0      | 32.0        |
| OPA4316IPWRG4 | TSSOP        | PW              | 14   | 2000 | 353.0       | 353.0      | 32.0        |

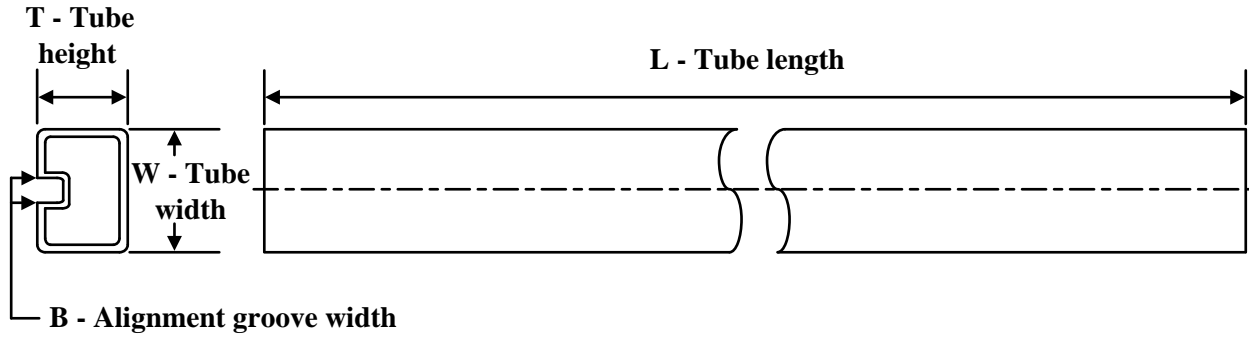
**TUBE**

\*All dimensions are nominal

| Device         | Package Name | Package Type | Pins | SPQ | L (mm) | W (mm) | T (μm) | B (mm) |
|----------------|--------------|--------------|------|-----|--------|--------|--------|--------|
| OPA2316ID      | D            | SOIC         | 8    | 75  | 506.6  | 8      | 3940   | 4.32   |
| OPA2316ID.B    | D            | SOIC         | 8    | 75  | 506.6  | 8      | 3940   | 4.32   |
| OPA2316IDGK    | DGK          | VSSOP        | 8    | 80  | 330    | 6.55   | 500    | 2.88   |
| OPA2316IDGK.B  | DGK          | VSSOP        | 8    | 80  | 330    | 6.55   | 500    | 2.88   |
| OPA2316SIDGS   | DGS          | VSSOP        | 10   | 80  | 330    | 6.55   | 500    | 2.88   |
| OPA2316SIDGS.B | DGS          | VSSOP        | 10   | 80  | 330    | 6.55   | 500    | 2.88   |
| OPA4316ID      | D            | SOIC         | 14   | 50  | 507    | 8      | 3940   | 4.32   |
| OPA4316ID.B    | D            | SOIC         | 14   | 50  | 507    | 8      | 3940   | 4.32   |
| OPA4316IPW     | PW           | TSSOP        | 14   | 90  | 530    | 10.2   | 3600   | 3.5    |
| OPA4316IPW.B   | PW           | TSSOP        | 14   | 90  | 530    | 10.2   | 3600   | 3.5    |

# DBV0005A



# PACKAGE OUTLINE

SOT-23 - 1.45 mm max height

SMALL OUTLINE TRANSISTOR



4214839/K 08/2024

## NOTES:

1. All linear dimensions are in millimeters. Any dimensions in parenthesis are for reference only. Dimensioning and tolerancing per ASME Y14.5M.
2. This drawing is subject to change without notice.
3. Reference JEDEC MO-178.
4. Body dimensions do not include mold flash, protrusions, or gate burrs. Mold flash, protrusions, or gate burrs shall not exceed 0.25 mm per side.
5. Support pin may differ or may not be present.

# EXAMPLE BOARD LAYOUT

DBV0005A

SOT-23 - 1.45 mm max height

SMALL OUTLINE TRANSISTOR



LAND PATTERN EXAMPLE  
EXPOSED METAL SHOWN  
SCALE:15X



SOLDER MASK DETAILS

4214839/K 08/2024

NOTES: (continued)

- 6. Publication IPC-7351 may have alternate designs.
- 7. Solder mask tolerances between and around signal pads can vary based on board fabrication site.

# EXAMPLE STENCIL DESIGN

DBV0005A

SOT-23 - 1.45 mm max height

SMALL OUTLINE TRANSISTOR



SOLDER PASTE EXAMPLE  
BASED ON 0.125 mm THICK STENCIL  
SCALE:15X

4214839/K 08/2024

NOTES: (continued)

8. Laser cutting apertures with trapezoidal walls and rounded corners may offer better paste release. IPC-7525 may have alternate design recommendations.
9. Board assembly site may have different recommendations for stencil design.

DGK0008A

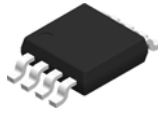

# PACKAGE OUTLINE

VSSOP - 1.1 mm max height

SMALL OUTLINE PACKAGE



NOTES:

PowerPAD is a trademark of Texas Instruments.

1. All linear dimensions are in millimeters. Any dimensions in parenthesis are for reference only. Dimensioning and tolerancing per ASME Y14.5M.
2. This drawing is subject to change without notice.
3. This dimension does not include mold flash, protrusions, or gate burrs. Mold flash, protrusions, or gate burrs shall not exceed 0.15 mm per side.
4. This dimension does not include interlead flash. Interlead flash shall not exceed 0.25 mm per side.
5. Reference JEDEC registration MO-187.

# EXAMPLE BOARD LAYOUT

DGK0008A

™ VSSOP - 1.1 mm max height

SMALL OUTLINE PACKAGE



LAND PATTERN EXAMPLE  
EXPOSED METAL SHOWN  
SCALE: 15X



SOLDER MASK DETAILS

4214862/A 04/2023

NOTES: (continued)

6. Publication IPC-7351 may have alternate designs.
7. Solder mask tolerances between and around signal pads can vary based on board fabrication site.
8. Vias are optional depending on application, refer to device data sheet. If any vias are implemented, refer to their locations shown on this view. It is recommended that vias under paste be filled, plugged or tented.
9. Size of metal pad may vary due to creepage requirement.

# EXAMPLE STENCIL DESIGN

DGK0008A

<sup>TM</sup> VSSOP - 1.1 mm max height

SMALL OUTLINE PACKAGE



SOLDER PASTE EXAMPLE  
SCALE: 15X

4214862/A 04/2023

NOTES: (continued)

11. Laser cutting apertures with trapezoidal walls and rounded corners may offer better paste release. IPC-7525 may have alternate design recommendations.
12. Board assembly site may have different recommendations for stencil design.

## GENERIC PACKAGE VIEW

**DRG 8**

**WSO - 0.8 mm max height**

3 x 3, 0.5 mm pitch

PLASTIC SMALL OUTLINE - NO LEAD

This image is a representation of the package family, actual package may vary.  
Refer to the product data sheet for package details.

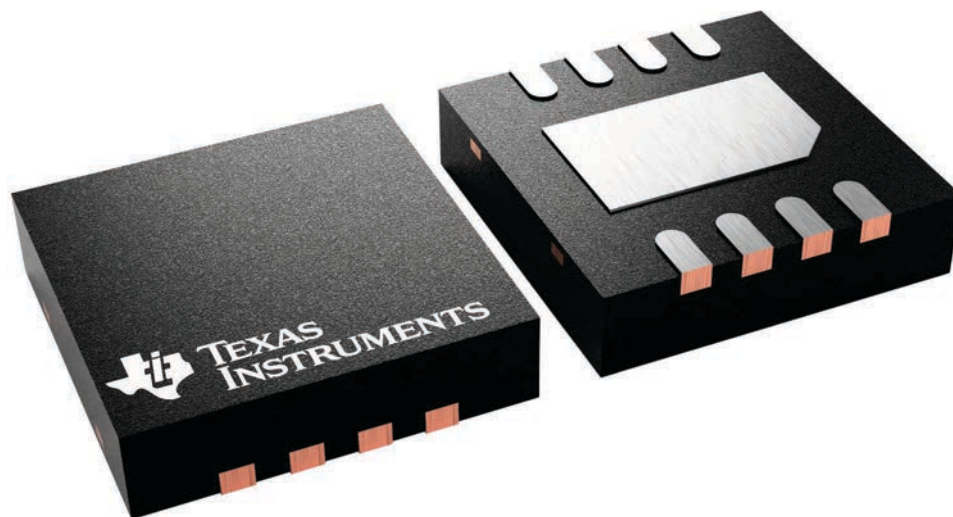

4225794/A



# EXAMPLE BOARD LAYOUT

DRG0008A

WSON - 0.8 mm max height

PLASTIC SMALL OUTLINE - NO LEAD

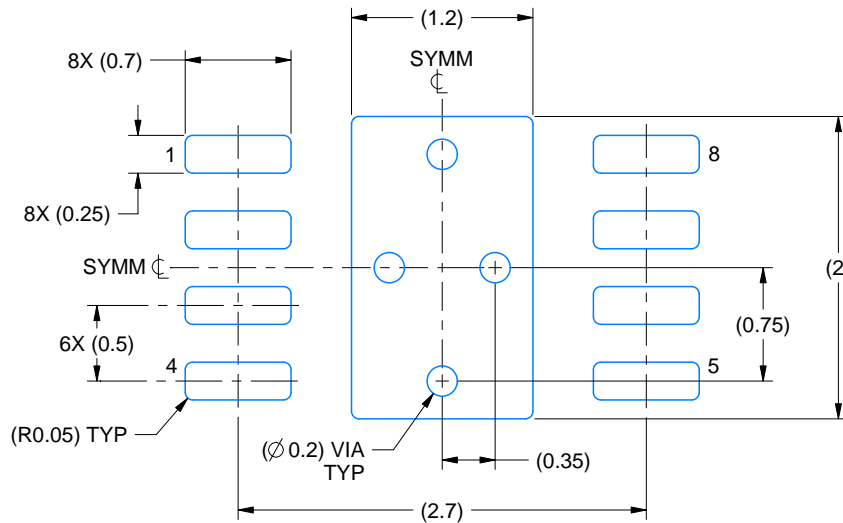

LAND PATTERN EXAMPLE  
EXPOSED METAL SHOWN  
SCALE:20X

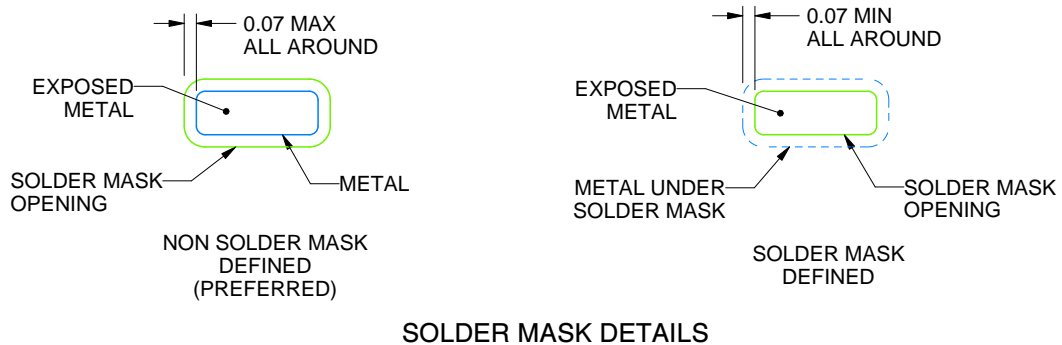

SOLDER MASK DETAILS

4218885/A 03/2020

NOTES: (continued)

- This package is designed to be soldered to a thermal pad on the board. For more information, see Texas Instruments literature number SLUA271 ([www.ti.com/lit/slua271](http://www.ti.com/lit/slua271)).
- Vias are optional depending on application, refer to device data sheet. If any vias are implemented, refer to their locations shown on this view. It is recommended that vias under paste be filled, plugged or tented.

# EXAMPLE STENCIL DESIGN

DRG0008A

WSON - 0.8 mm max height

PLASTIC SMALL OUTLINE - NO LEAD

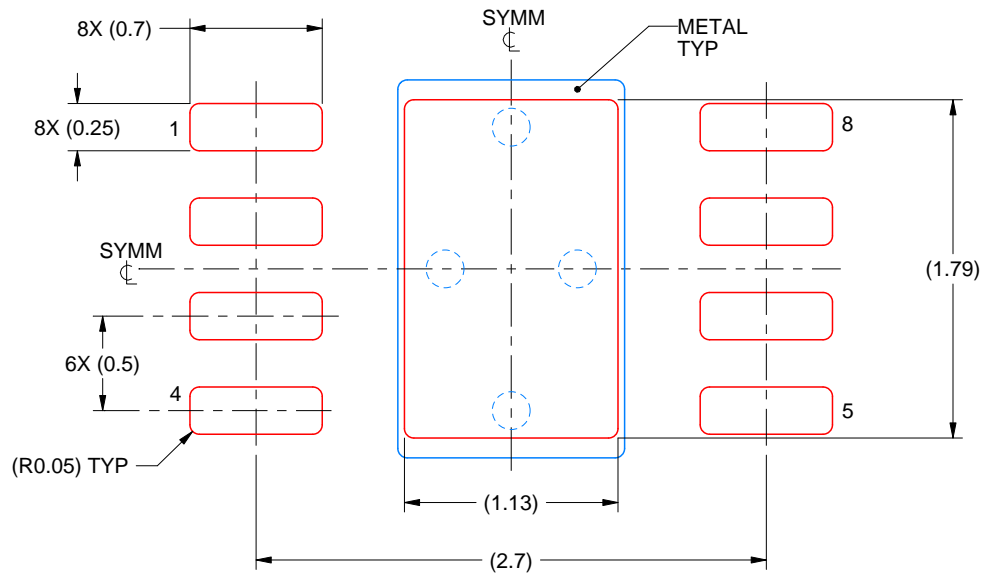

SOLDER PASTE EXAMPLE  
BASED ON 0.125 mm THICK STENCIL

EXPOSED PAD  
84% PRINTED SOLDER COVERAGE BY AREA  
SCALE:25X

4218885/A 03/2020

NOTES: (continued)

6. Laser cutting apertures with trapezoidal walls and rounded corners may offer better paste release. IPC-7525 may have alternate design recommendations.



# D0014A

# PACKAGE OUTLINE

## SOIC - 1.75 mm max height

SMALL OUTLINE INTEGRATED CIRCUIT



4220718/A 09/2016

### NOTES:

1. All linear dimensions are in millimeters. Dimensions in parenthesis are for reference only. Dimensioning and tolerancing per ASME Y14.5M.
2. This drawing is subject to change without notice.
3. This dimension does not include mold flash, protrusions, or gate burrs. Mold flash, protrusions, or gate burrs shall not exceed 0.15 mm, per side.
4. This dimension does not include interlead flash. Interlead flash shall not exceed 0.43 mm, per side.
5. Reference JEDEC registration MS-012, variation AB.

# EXAMPLE BOARD LAYOUT

D0014A

SOIC - 1.75 mm max height

SMALL OUTLINE INTEGRATED CIRCUIT



LAND PATTERN EXAMPLE  
SCALE:8X



SOLDER MASK DETAILS

4220718/A 09/2016

NOTES: (continued)

- 6. Publication IPC-7351 may have alternate designs.
- 7. Solder mask tolerances between and around signal pads can vary based on board fabrication site.

# EXAMPLE STENCIL DESIGN

D0014A

SOIC - 1.75 mm max height

SMALL OUTLINE INTEGRATED CIRCUIT



SOLDER PASTE EXAMPLE  
BASED ON 0.125 mm THICK STENCIL  
SCALE:8X

4220718/A 09/2016

NOTES: (continued)

8. Laser cutting apertures with trapezoidal walls and rounded corners may offer better paste release. IPC-7525 may have alternate design recommendations.
9. Board assembly site may have different recommendations for stencil design.

## GENERIC PACKAGE VIEW

**RUG 10**

**X2QFN - 0.4 mm max height**

1.5 x 2, 0.5 mm pitch

PLASTIC QUAD FLATPACK - NO LEAD

This image is a representation of the package family, actual package may vary.  
Refer to the product data sheet for package details.



4231768/A

# RUG0010A



# PACKAGE OUTLINE

## X2QFN - 0.4 mm max height

PLASTIC QUAD FLATPACK - NO LEAD

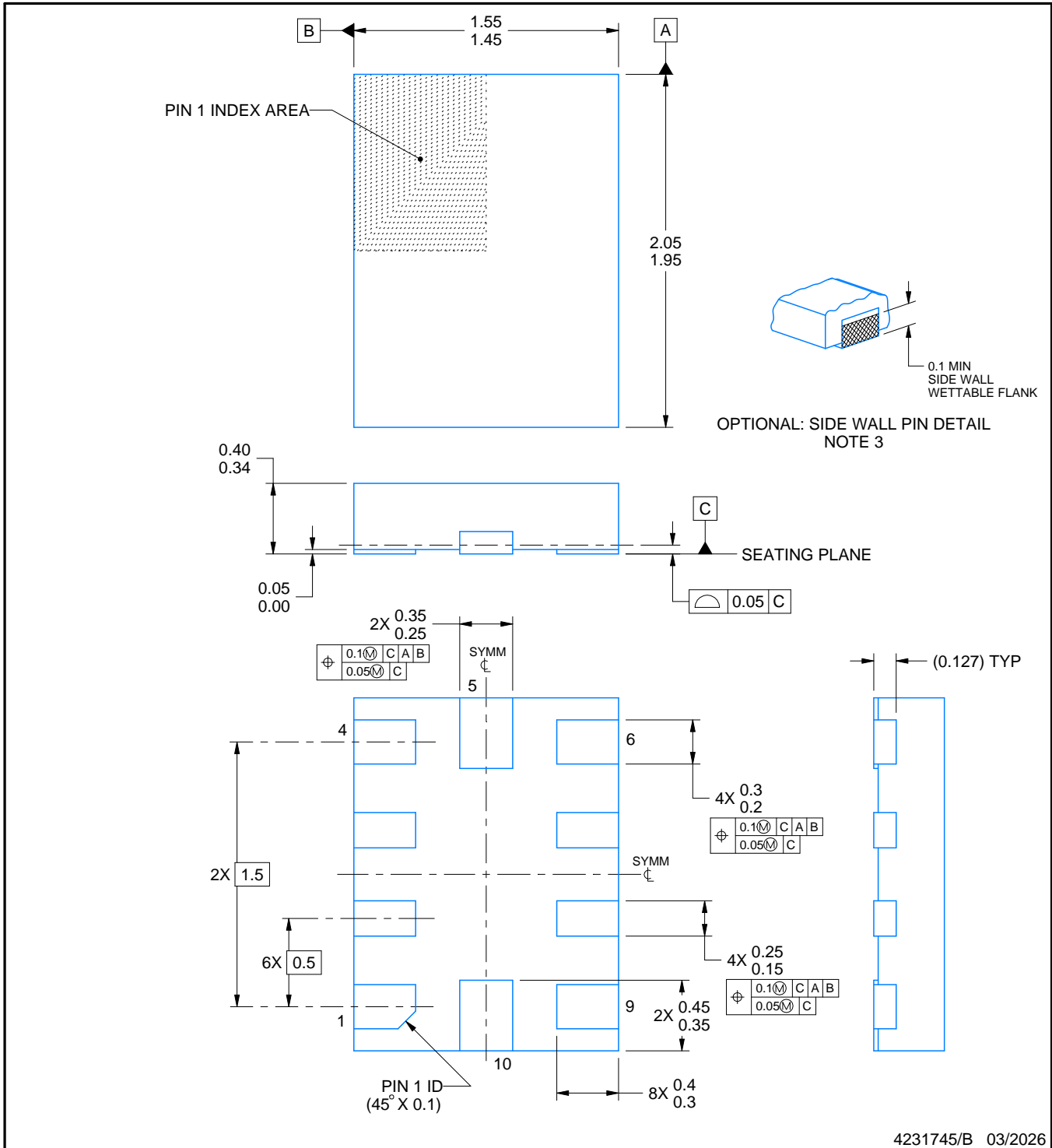

4231745/B 03/2026

### NOTES:

1. All linear dimensions are in millimeters. Any dimensions in parenthesis are for reference only. Dimensioning and tolerancing per ASME Y14.5M.
2. This drawing is subject to change without notice.
3. Minimum 0.1 mm solder wetting on pin side wall. Available for wettable flank version only.

# EXAMPLE BOARD LAYOUT

RUG0010A

X2QFN - 0.4 mm max height

PLASTIC QUAD FLATPACK - NO LEAD

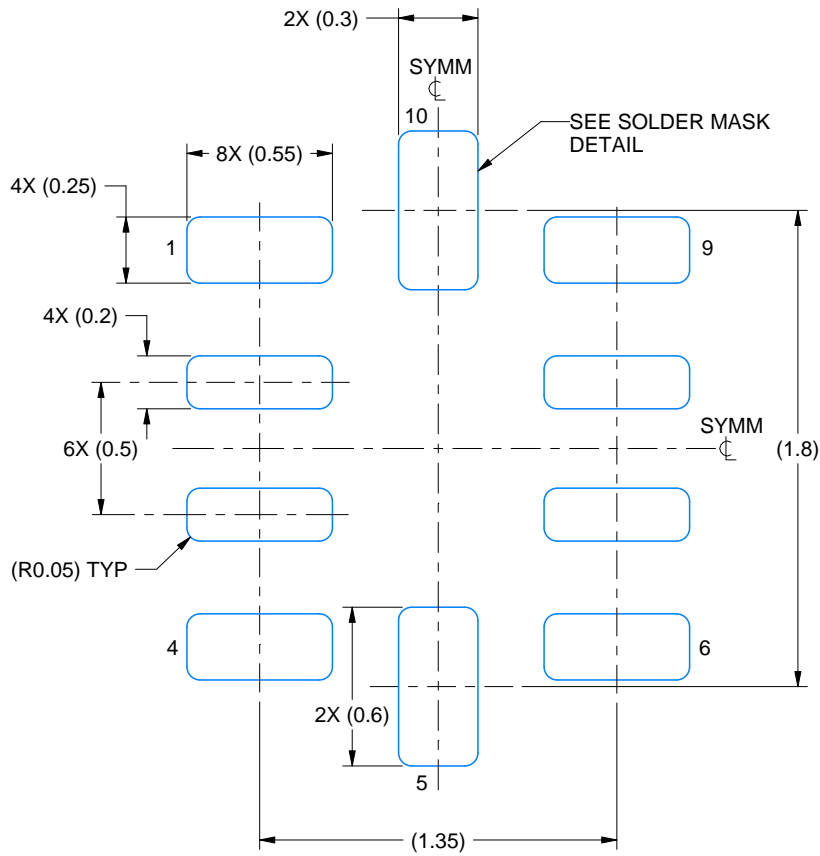

LAND PATTERN EXAMPLE  
EXPOSED METAL SHOWN  
SCALE: 35X

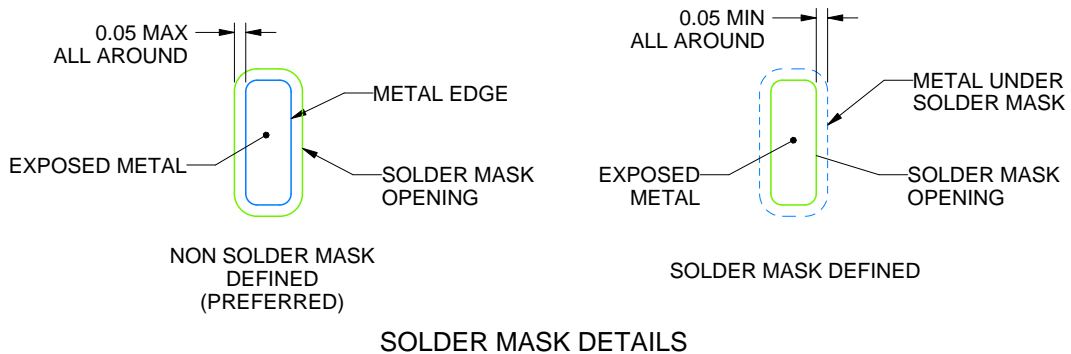

4231745/B 03/2026

NOTES: (continued)

3. For more information, see Texas Instruments literature number SLUA271 ([www.ti.com/lit/slua271](http://www.ti.com/lit/slua271)).

# EXAMPLE STENCIL DESIGN

RUG0010A

X2QFN - 0.4 mm max height

PLASTIC QUAD FLATPACK - NO LEAD

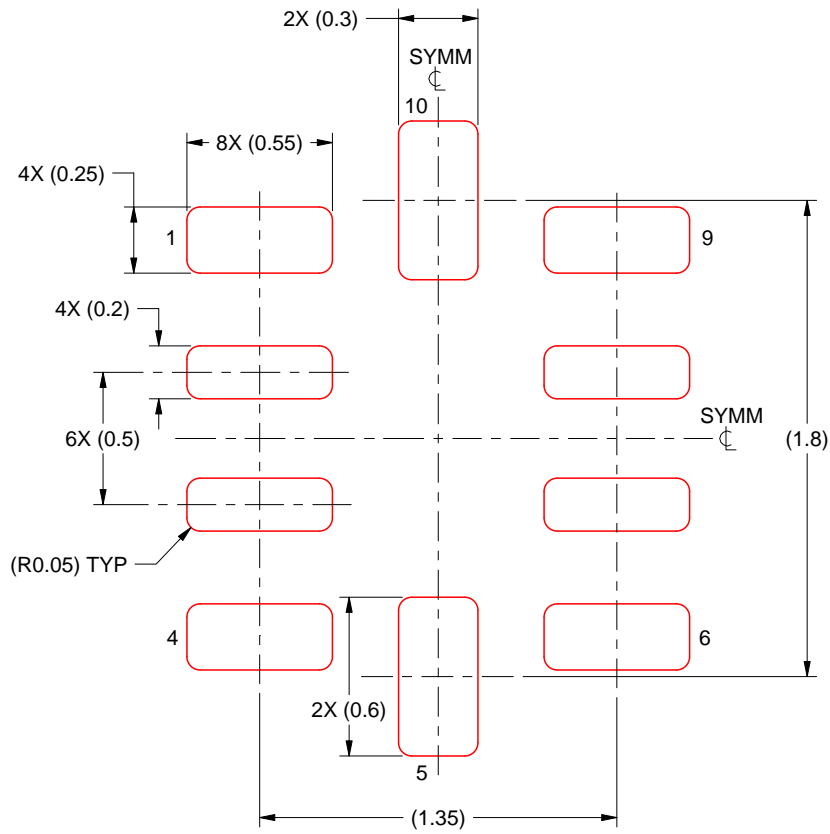

SOLDER PASTE EXAMPLE  
BASED ON 0.125 MM THICK STENCIL  
SCALE: 35X

4231745/B 03/2026

NOTES: (continued)

4. Laser cutting apertures with trapezoidal walls and rounded corners may offer better paste release. IPC-7525 may have alternate design recommendations.

# DGS0010A

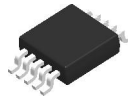

# PACKAGE OUTLINE

## VSSOP - 1.1 mm max height

SMALL OUTLINE PACKAGE

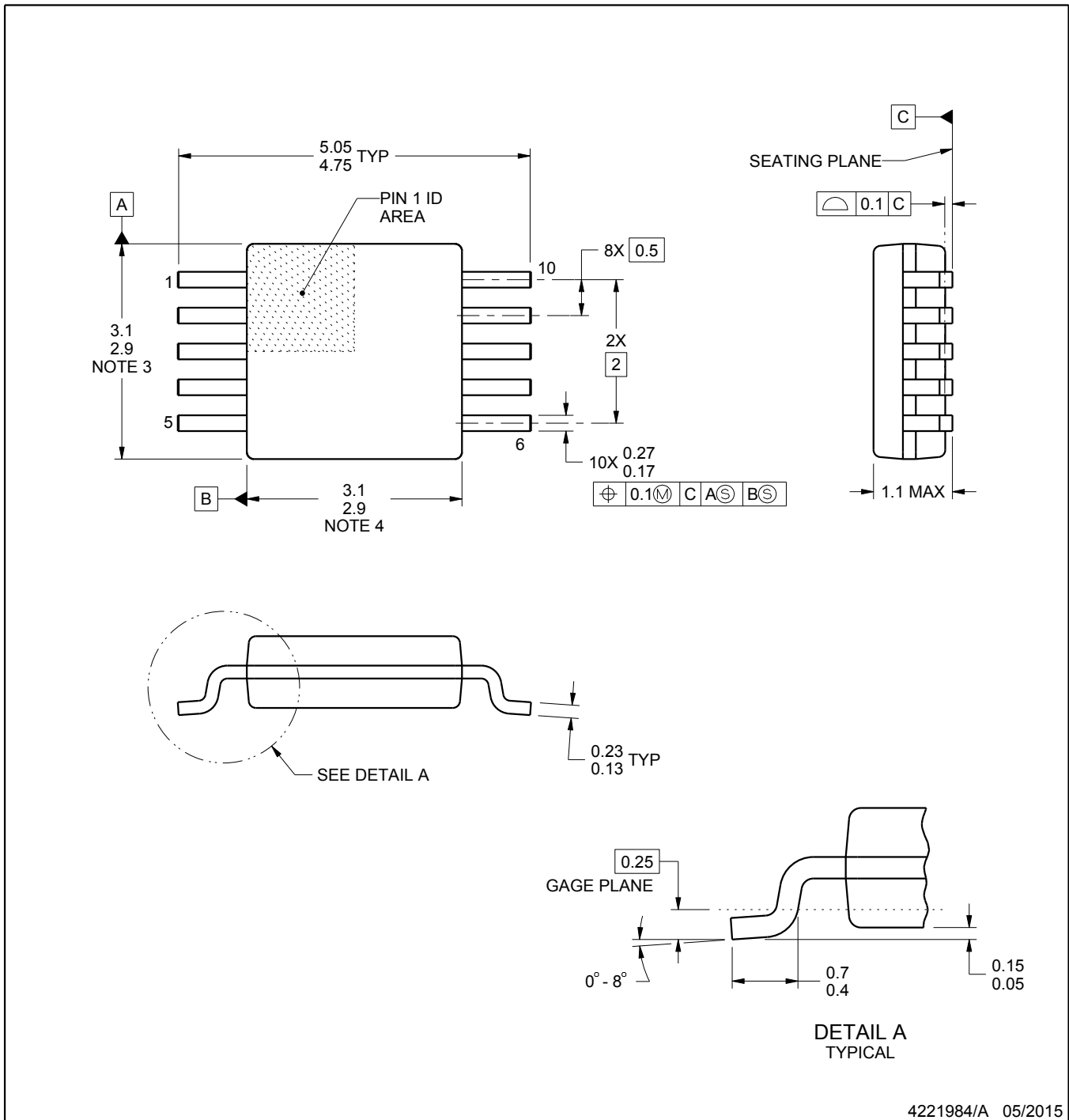

4221984/A 05/2015

### NOTES:

1. All linear dimensions are in millimeters. Any dimensions in parenthesis are for reference only. Dimensioning and tolerancing per ASME Y14.5M.
2. This drawing is subject to change without notice.
3. This dimension does not include mold flash, protrusions, or gate burrs. Mold flash, protrusions, or gate burrs shall not exceed 0.15 mm per side.
4. This dimension does not include interlead flash. Interlead flash shall not exceed 0.25 mm per side.
5. Reference JEDEC registration MO-187, variation BA.

# EXAMPLE BOARD LAYOUT

DGS0010A

VSSOP - 1.1 mm max height

SMALL OUTLINE PACKAGE



LAND PATTERN EXAMPLE  
SCALE:10X

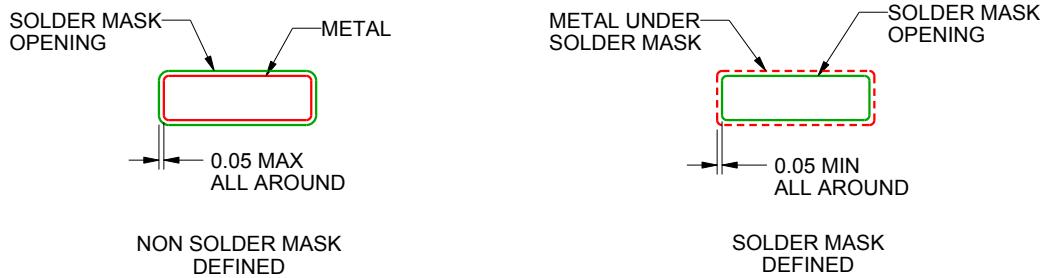

SOLDER MASK DETAILS  
NOT TO SCALE

4221984/A 05/2015

NOTES: (continued)

- 6. Publication IPC-7351 may have alternate designs.
- 7. Solder mask tolerances between and around signal pads can vary based on board fabrication site.

# EXAMPLE STENCIL DESIGN

DGS0010A

VSSOP - 1.1 mm max height

SMALL OUTLINE PACKAGE



SOLDER PASTE EXAMPLE  
BASED ON 0.125 mm THICK STENCIL  
SCALE:10X

4221984/A 05/2015

NOTES: (continued)

8. Laser cutting apertures with trapezoidal walls and rounded corners may offer better paste release. IPC-7525 may have alternate design recommendations.
9. Board assembly site may have different recommendations for stencil design.

# DCK0005A



# PACKAGE OUTLINE

SOT - 1.1 max height

SMALL OUTLINE TRANSISTOR

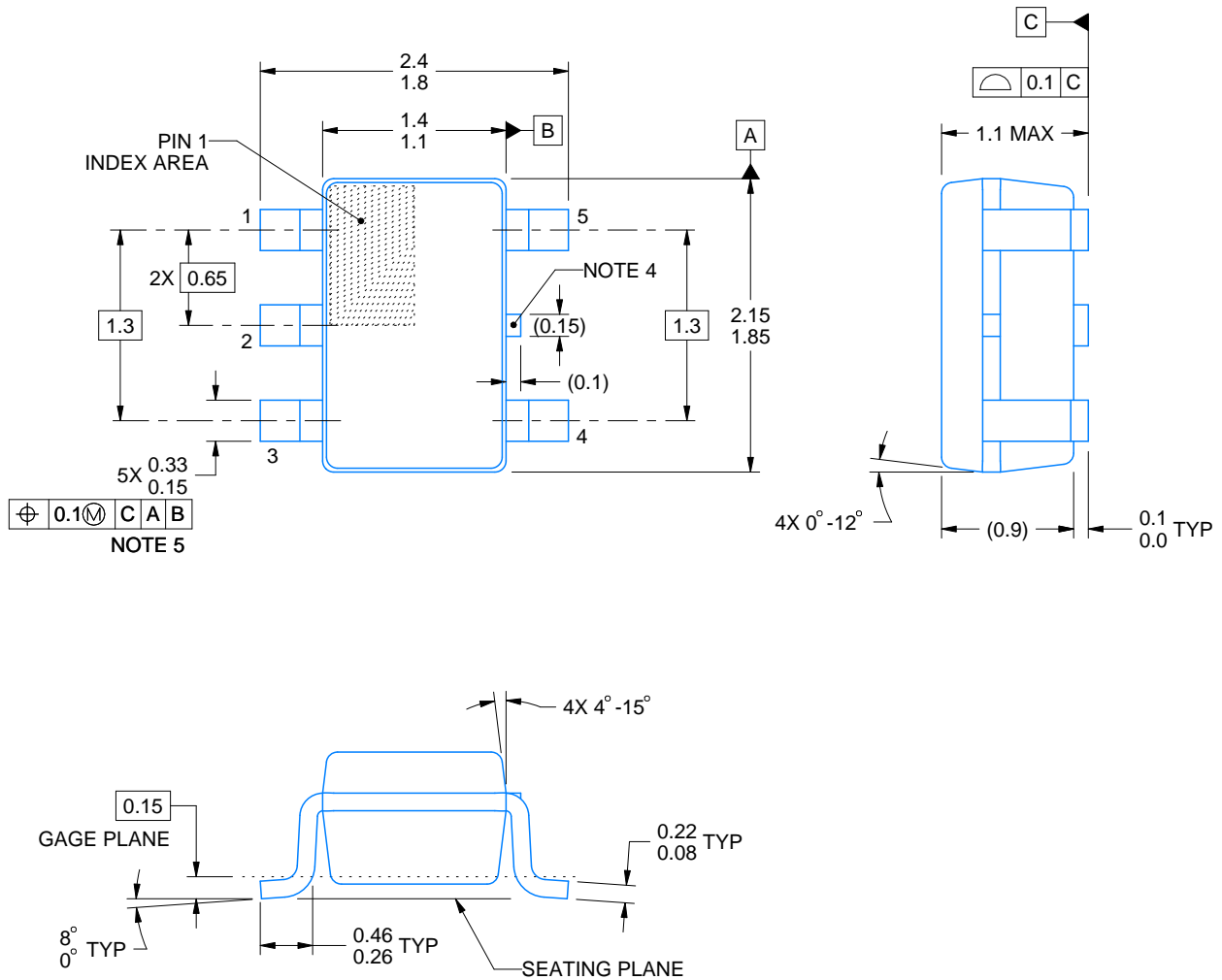

4214834/G 11/2024

**NOTES:**

1. All linear dimensions are in millimeters. Any dimensions in parenthesis are for reference only. Dimensioning and tolerancing per ASME Y14.5M.
2. This drawing is subject to change without notice.
3. Reference JEDEC MO-203.
4. Support pin may differ or may not be present.
5. Lead width does not comply with JEDEC.
6. Body dimensions do not include mold flash, protrusions, or gate burrs. Mold flash, protrusions, or gate burrs shall not exceed 0.25mm per side

# EXAMPLE BOARD LAYOUT

DCK0005A

SOT - 1.1 max height

SMALL OUTLINE TRANSISTOR

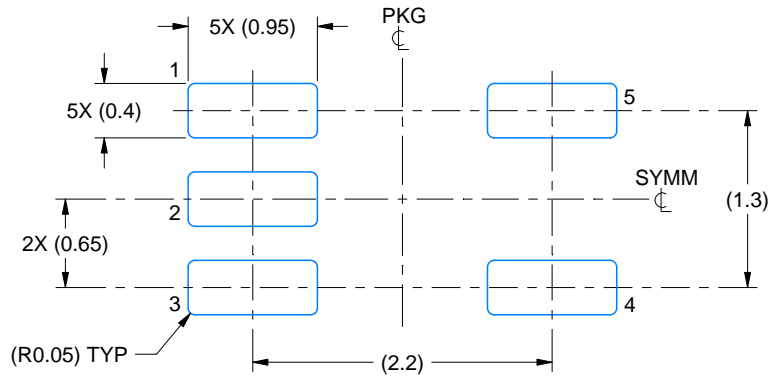

LAND PATTERN EXAMPLE  
EXPOSED METAL SHOWN  
SCALE:18X

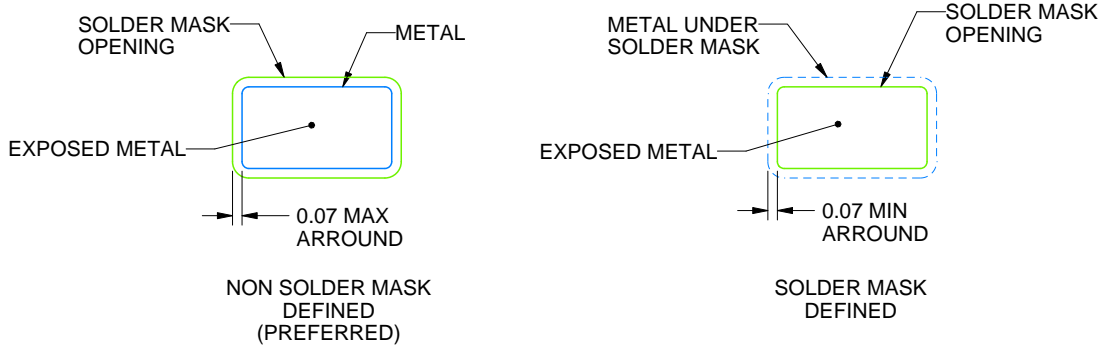

SOLDER MASK DETAILS

4214834/G 11/2024

NOTES: (continued)

- 7. Publication IPC-7351 may have alternate designs.
- 8. Solder mask tolerances between and around signal pads can vary based on board fabrication site.

# EXAMPLE STENCIL DESIGN

DCK0005A

SOT - 1.1 max height

SMALL OUTLINE TRANSISTOR

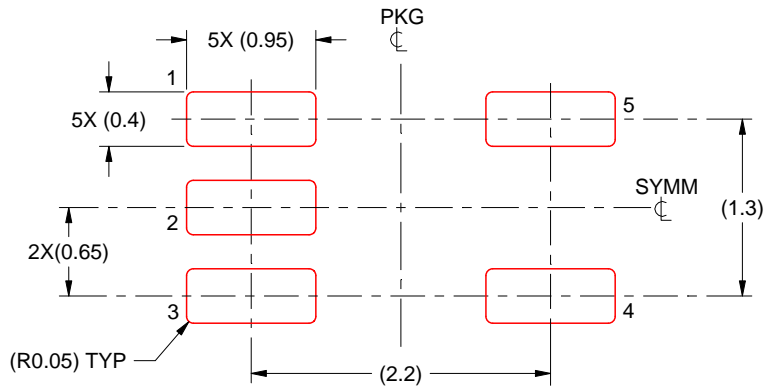

SOLDER PASTE EXAMPLE  
BASED ON 0.125 THICK STENCIL  
SCALE:18X

4214834/G 11/2024

NOTES: (continued)

9. Laser cutting apertures with trapezoidal walls and rounded corners may offer better paste release. IPC-7525 may have alternate design recommendations.
10. Board assembly site may have different recommendations for stencil design.



D0008A

# PACKAGE OUTLINE

SOIC - 1.75 mm max height

SMALL OUTLINE INTEGRATED CIRCUIT



4214825/C 02/2019

### NOTES:

- Linear dimensions are in inches [millimeters]. Dimensions in parenthesis are for reference only. Controlling dimensions are in inches. Dimensioning and tolerancing per ASME Y14.5M.
- This drawing is subject to change without notice.
- This dimension does not include mold flash, protrusions, or gate burrs. Mold flash, protrusions, or gate burrs shall not exceed  $.006$  [0.15] per side.
- This dimension does not include interlead flash.
- Reference JEDEC registration MS-012, variation AA.

# EXAMPLE BOARD LAYOUT

D0008A

SOIC - 1.75 mm max height

SMALL OUTLINE INTEGRATED CIRCUIT



LAND PATTERN EXAMPLE  
 EXPOSED METAL SHOWN  
 SCALE:8X



SOLDER MASK DETAILS

4214825/C 02/2019

NOTES: (continued)

- 6. Publication IPC-7351 may have alternate designs.
- 7. Solder mask tolerances between and around signal pads can vary based on board fabrication site.

# EXAMPLE STENCIL DESIGN

D0008A

SOIC - 1.75 mm max height

SMALL OUTLINE INTEGRATED CIRCUIT



SOLDER PASTE EXAMPLE  
BASED ON .005 INCH [0.125 MM] THICK STENCIL  
SCALE:8X

4214825/C 02/2019

NOTES: (continued)

8. Laser cutting apertures with trapezoidal walls and rounded corners may offer better paste release. IPC-7525 may have alternate design recommendations.
9. Board assembly site may have different recommendations for stencil design.

PW0014A

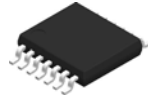

**PACKAGE OUTLINE**  
**TSSOP - 1.2 mm max height**

SMALL OUTLINE PACKAGE

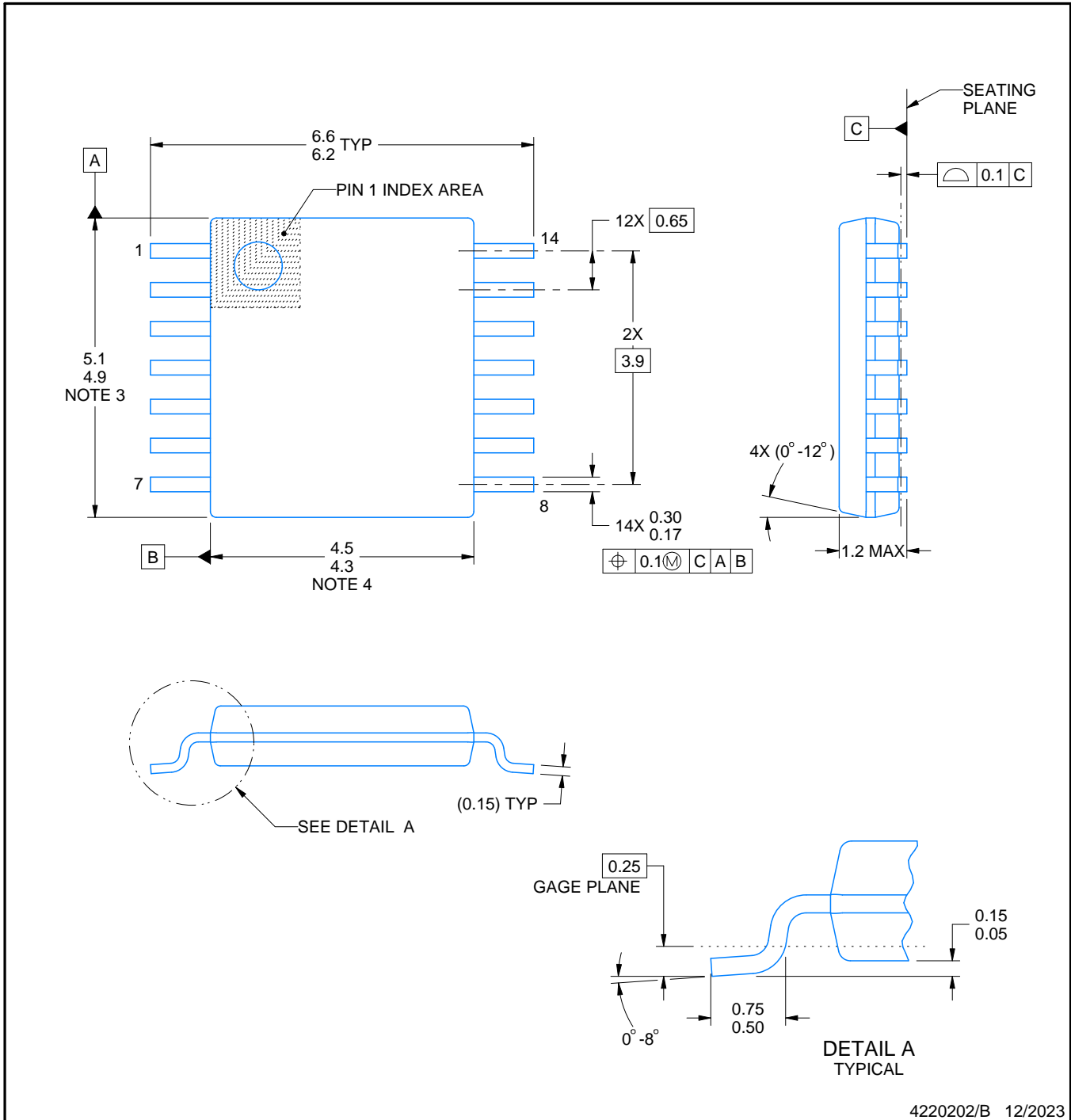

4220202/B 12/2023

NOTES:

1. All linear dimensions are in millimeters. Any dimensions in parenthesis are for reference only. Dimensioning and tolerancing per ASME Y14.5M.
2. This drawing is subject to change without notice.
3. This dimension does not include mold flash, protrusions, or gate burrs. Mold flash, protrusions, or gate burrs shall not exceed 0.15 mm per side.
4. This dimension does not include interlead flash. Interlead flash shall not exceed 0.25 mm per side.
5. Reference JEDEC registration MO-153.

# EXAMPLE BOARD LAYOUT

PW0014A

TSSOP - 1.2 mm max height

SMALL OUTLINE PACKAGE

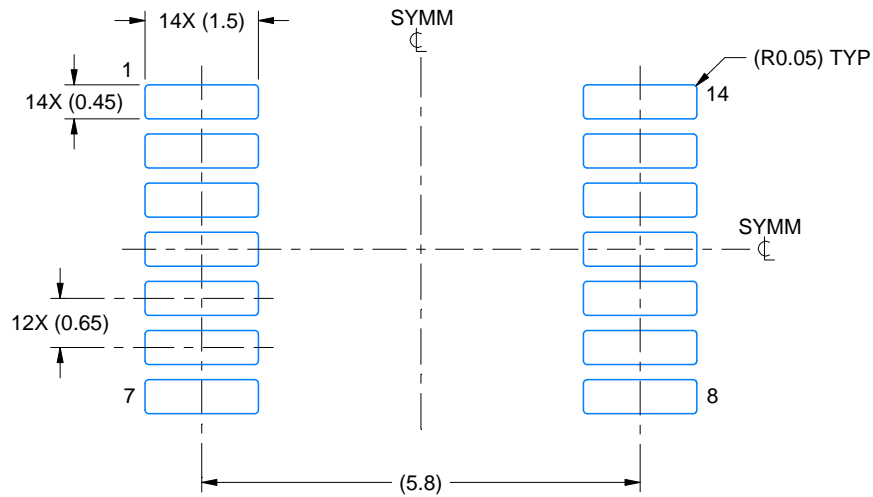

LAND PATTERN EXAMPLE  
EXPOSED METAL SHOWN  
SCALE: 10X



4220202/B 12/2023

NOTES: (continued)

- 6. Publication IPC-7351 may have alternate designs.
- 7. Solder mask tolerances between and around signal pads can vary based on board fabrication site.

# EXAMPLE STENCIL DESIGN

PW0014A

TSSOP - 1.2 mm max height

SMALL OUTLINE PACKAGE



SOLDER PASTE EXAMPLE  
BASED ON 0.125 mm THICK STENCIL  
SCALE: 10X

4220202/B 12/2023

NOTES: (continued)

8. Laser cutting apertures with trapezoidal walls and rounded corners may offer better paste release. IPC-7525 may have alternate design recommendations.
9. Board assembly site may have different recommendations for stencil design.

## IMPORTANT NOTICE AND DISCLAIMER

TI PROVIDES TECHNICAL AND RELIABILITY DATA (INCLUDING DATASHEETS), DESIGN RESOURCES (INCLUDING REFERENCE DESIGNS), APPLICATION OR OTHER DESIGN ADVICE, WEB TOOLS, SAFETY INFORMATION, AND OTHER RESOURCES "AS IS" AND WITH ALL FAULTS, AND DISCLAIMS ALL WARRANTIES, EXPRESS AND IMPLIED, INCLUDING WITHOUT LIMITATION ANY IMPLIED WARRANTIES OF MERCHANTABILITY, FITNESS FOR A PARTICULAR PURPOSE OR NON-INFRINGEMENT OF THIRD PARTY INTELLECTUAL PROPERTY RIGHTS.

These resources are intended for skilled developers designing with TI products. You are solely responsible for (1) selecting the appropriate TI products for your application, (2) designing, validating and testing your application, and (3) ensuring your application meets applicable standards, and any other safety, security, regulatory or other requirements.

These resources are subject to change without notice. TI grants you permission to use these resources only for development of an application that uses the TI products described in the resource. Other reproduction and display of these resources is prohibited. No license is granted to any other TI intellectual property right or to any third party intellectual property right. TI disclaims responsibility for, and you fully indemnify TI and its representatives against any claims, damages, costs, losses, and liabilities arising out of your use of these resources.

TI's products are provided subject to [TI's Terms of Sale](#), [TI's General Quality Guidelines](#), or other applicable terms available either on [ti.com](#) or provided in conjunction with such TI products. TI's provision of these resources does not expand or otherwise alter TI's applicable warranties or warranty disclaimers for TI products. Unless TI explicitly designates a product as custom or customer-specified, TI products are standard, catalog, general purpose devices.

TI objects to and rejects any additional or different terms you may propose.

Copyright © 2026, Texas Instruments Incorporated

Last updated 10/2025