

LPV801/LPV802 320 nA Nanopower Operational Amplifiers

1 Features

- Nanopower Supply Current: 320 nA/channel
- Offset Voltage: 3.5 mV (max)
- $T_C V_{OS}$: 1 $\mu\text{V}/^\circ\text{C}$
- Unity Gain-Bandwidth: 8 kHz
- Wide Supply Range: 1.6 V to 5.5 V
- Low Input Bias Current : 0.1 pA
- Unity-Gain Stable
- Rail-to-Rail Output
- No Output Reversals
- EMI Protection
- Temperature Range: -40°C to 125°C
- Industry Standard Packages:
 - Single in 5-pin SOT-23
 - Dual in 8-pin VSSOP

2 Applications

- CO and O₂ Gas Detectors ([TIDA-00854](#))
- PIR Motion Detectors ([TIDA-00489](#))
- Ionization Smoke Alarms
- Thermostats
- IoT Remote Sensors
- Active RFID Readers and Tags
- Portable Medical Equipment

3 Description

The LPV801 (single) and LPV802 (dual) comprise a family of ultra-low-power operational amplifiers for sensing applications in battery powered wireless and low power wired equipment. With 8kHz of bandwidth from 320nA of quiescent current, the LPV80x amplifiers minimize power consumption in equipment such as CO detectors, smoke detectors and PIR motion detectors where operational battery-life is critical.

In addition to being ultra-low-power, the LPV80x amplifiers have CMOS input stages with typically femto-amp bias currents. The LPV80x amplifiers also feature a negative-rail sensing input stage and a rail-to-rail output stage that is capable of swinging within millivolts of the rails, maintaining the widest dynamic range possible. EMI protection is designed into the LPV80x in order to reduce system sensitivity to unwanted RF signals from mobile phones, WiFi, radio transmitters and tag readers.

Device Information⁽¹⁾

PART NUMBER	PACKAGE	BODY SIZE
LPV801	SOT-23 (5)	2.90 mm x 1.60 mm
LPV802	VSSOP (8)	3.00 mm x 3.00 mm

LPV8xx Family of Nanopower Amplifiers

PART NUMBER	CHANNELS	SUPPLY CURRENT (Typ/Ch)	OFFSET VOLTAGE (Max)
LPV801	1	450 nA	3.5 mV
LPV802	2	320 nA	3.5 mV
LPV811	1	450 nA	370 μV
LPV812	2	425 nA	300 μV

(1) For all available packages, see the orderable addendum at the end of the data sheet.

Nanopower Amplifier in Electrochemical Sensor

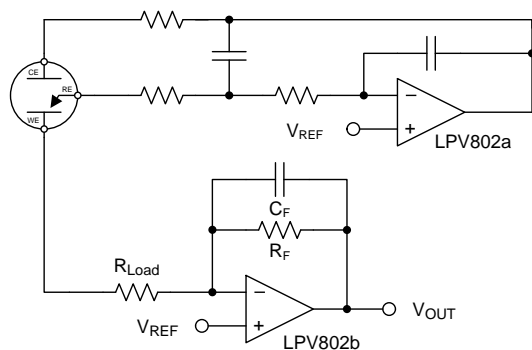

Nanopower Amplifier in PIR Motion Detector

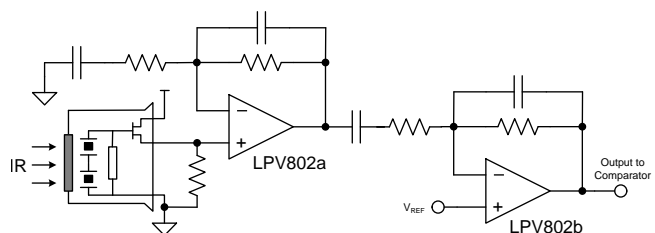

Table of Contents

1 Features	1	8.1 Application Information.....	14
2 Applications	1	8.2 Typical Application: Three Terminal CO Gas Sensor Amplifier	14
3 Description	1	8.3 Do's and Don'ts	17
4 Revision History	2	9 Power Supply Recommendations	17
5 Pin Configuration and Functions	3	10 Layout	17
6 Specifications	4	10.1 Layout Guidelines	17
6.1 Absolute Maximum Ratings	4	10.2 Layout Example	17
6.2 ESD Ratings.....	4	11 Device and Documentation Support	18
6.3 Recommended Operating Conditions.....	4	11.1 Device Support	18
6.4 Thermal Information	4	11.2 Receiving Notification of Documentation Updates	18
6.5 Electrical Characteristics.....	5	11.3 Community Resources.....	18
6.6 Typical Characteristics.....	6	11.4 Related Links	18
7 Detailed Description	12	11.5 Trademarks	18
7.1 Overview	12	11.6 Electrostatic Discharge Caution.....	18
7.2 Functional Block Diagram	12	11.7 Glossary	18
7.3 Feature Description.....	12	12 Mechanical, Packaging, and Orderable Information	19
7.4 Device Functional Modes.....	12		
8 Application and Implementation	14		

4 Revision History

Changes from Revision A (August 2016) to Revision B	Page
• Changed LPV811 Typ Offset Voltage and LPV812 Typ Supply Current in LPV8xx Family table	1
• Deleted LPV801 "Specs Prelim until Release" footnote	5
• Added separate CMRR line for LPV801	5
• Changed LPV801 Typical and Maximum Supply Current	5

Changes from Original (August 2016) to Revision A	Page
• Changed Product Preview to Production Data.....	1

5 Pin Configuration and Functions

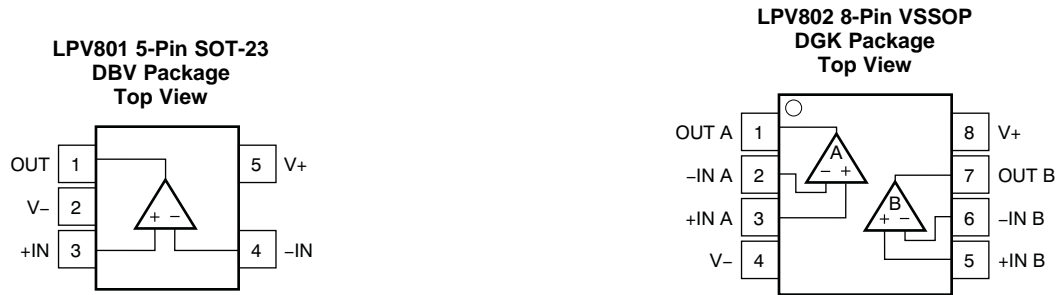

Pin Functions: LPV801 DBV

PIN		I/O	DESCRIPTION
NAME	NUMBER		
OUT	1	O	Output
-IN	4	I	Inverting Input
+IN	3	I	Non-Inverting Input
V-	2	P	Negative (lowest) power supply
V+	5	P	Positive (highest) power supply

Pin Functions: LPV802 DGK

PIN		I/O	DESCRIPTION
NAME	NUMBER		
OUT A	1	O	Channel A Output
-IN A	2	I	Channel A Inverting Input
+IN A	3	I	Channel A Non-Inverting Input
V-	4	P	Negative (lowest) power supply
+IN B	5	I	Channel B Non-Inverting Input
-IN B	6	I	Channel B Inverting Input
OUT B	7	O	Channel B Output
V+	8	P	Positive (highest) power supply

6 Specifications

6.1 Absolute Maximum Ratings

Over operating free-air temperature range (unless otherwise noted) ⁽¹⁾

		MIN	MAX	UNIT
Supply voltage, $V_s = (V+) - (V-)$		-0.3	6	V
Input pins	Voltage ^{(2) (3)}	Common mode		(V-) - 0.3 (V+) + 0.3
		Differential		(V-) - 0.3 (V+) + 0.3
Input pins	Current	-10	10	mA
Output short current ⁽⁴⁾		Continuous	Continuous	
Operating temperature		-40	125	°C
Storage temperature, T_{stg}		-65	150	°C
Junction temperature			150	°C

- (1) Stresses beyond those listed under *Absolute Maximum Ratings* may cause permanent damage to the device. These are stress ratings only, which do not imply functional operation of the device at these or any other conditions beyond those indicated under *Recommended Operating Conditions*. Exposure to absolute-maximum-rated conditions for extended periods may affect device reliability.
- (2) Not to exceed -0.3V or +6.0V on ANY pin, referred to V-
- (3) Input terminals are diode-clamped to the power-supply rails. Input signals that can swing more than 0.3 V beyond the supply rails should be current-limited to 10 mA or less.
- (4) Short-circuit to $V_s/2$, one amplifier per package. Continuous short circuit operation at elevated ambient temperature can result in exceeding the maximum allowed junction temperature of 150°C.

6.2 ESD Ratings

		VALUE	UNIT
$V_{(ESD)}$ Electrostatic discharge	Human-body model (HBM), per ANSI/ESDA/JEDEC JS-001 ⁽¹⁾	±1000	V
	Charged-device model (CDM), per JEDEC specification JESD22-C101 ⁽²⁾	±250	

- (1) JEDEC document JEP155 states that 500-V HBM allows safe manufacturing with a standard ESD control process. Manufacturing with less than 500-V HBM is possible with the necessary precautions. Pins listed as ±2000 V may actually have higher performance.
- (2) JEDEC document JEP157 states that 250-V CDM allows safe manufacturing with a standard ESD control process. Manufacturing with less than 250-V CDM is possible with the necessary precautions. Pins listed as ±750 V may actually have higher performance.

6.3 Recommended Operating Conditions

over operating free-air temperature range (unless otherwise noted)

	MIN	NOM	MAX	UNIT
Supply voltage (V+ – V-)	1.6		5.5	V
Specified temperature	-40		125	°C

6.4 Thermal Information

THERMAL METRIC ⁽¹⁾		LPV801 DBV (SOT-23) 5 PINS	LPV802 DGK (VSSOP) 8 PINS	UNIT
θ_{JA}	Junction-to-ambient thermal resistance	177.4	184.2	°C/W
θ_{JcTop}	Junction-to-case (top) thermal resistance	133.9	75.3	
θ_{JB}	Junction-to-board thermal resistance	36.3	105.5	
Ψ_{JT}	Junction-to-top characterization parameter	23.6	13.5	
Ψ_{JB}	Junction-to-board characterization parameter	35.7	103.9	

- (1) For more information about traditional and new thermal metrics, see the [Semiconductor and IC Package Thermal Metrics](#) application report.

6.5 Electrical Characteristics

$T_A = 25^\circ\text{C}$, $V_S = 1.8\text{V to } 5\text{V}$, $V_{CM} = V_{OUT} = V_S/2$, and $R_L \geq 10\text{ M}\Omega$ to $V_S/2$, unless otherwise noted.

PARAMETER		TEST CONDITIONS	MIN	TYP	MAX	UNIT
OFFSET VOLTAGE						
V_{OS}	Input offset voltage	$V_S = 1.8\text{V, } 3.3\text{V, and } 5\text{V,}$ $V_{CM} = V^-$		0.55	± 3.5	mV
		$V_S = 1.8\text{V, } 3.3\text{V, and } 5\text{V,}$ $V_{CM} = (V^+) - 0.9\text{V}$		0.55	± 3.5	
$\Delta V_{OS}/\Delta T$	Input offset drift	$V_{CM} = V^-$	$T_A = -40^\circ\text{C to } 125^\circ\text{C}$		1	$\mu\text{V}/^\circ\text{C}$
PSRR	Power-supply rejection ratio	$V_S = 1.8\text{V to } 5\text{V,}$ $V_{CM} = V^-$		1.6	60	$\mu\text{V}/\text{V}$
INPUT VOLTAGE RANGE						
V_{CM}	Common-mode voltage range	$V_S = 5\text{V}$	0		4.1	V
CMRR	Common-mode rejection ratio, LPV801	$(V^-) \leq V_{CM} \leq (V^+) - 0.9\text{V, } V_S = 5\text{V}$	77	95		dB
	Common-mode rejection ratio, LPV802	$(V^-) \leq V_{CM} \leq (V^+) - 0.9\text{V, } V_S = 5\text{V}$	80	98		dB
INPUT BIAS CURRENT						
I_B	Input bias current	$V_S = 1.8\text{V}$		± 100		fA
I_{OS}	Input offset current	$V_S = 1.8\text{V}$		± 100		
INPUT IMPEDANCE						
	Differential			7		pF
	Common mode			3		
NOISE						
E_n	Input voltage noise	$f = 0.1\text{ Hz to } 10\text{ Hz}$		6.5		$\mu\text{Vp-p}$
e_n	Input voltage noise density	$f = 100\text{ Hz}$		340		$\text{nV}/\sqrt{\text{Hz}}$
		$f = 1\text{ kHz}$		420		
OPEN-LOOP GAIN						
A_{OL}	Open-loop voltage gain	$(V^-) + 0.3\text{V} \leq V_O \leq (V^+) - 0.3\text{V, } R_L = 100\text{ k}\Omega$		120		dB
OUTPUT						
V_{OH}	Voltage output swing from positive rail	$V_S = 1.8\text{V, } R_L = 100\text{ k}\Omega$ to $V^+/2$	10	3.5		mV
V_{OL}	Voltage output swing from negative rail	$V_S = 1.8\text{V, } R_L = 100\text{ k}\Omega$ to $V^+/2$		2.5	10	
I_{SC}	Short-circuit current	$V_S = 3.3\text{V, Short to } V_S/2$		4.7		mA
Z_O	Open loop output impedance	$f = 1\text{ KHz, } I_O = 0\text{ A}$		90		k Ω
FREQUENCY RESPONSE						
GBP	Gain-bandwidth product	$C_L = 20\text{ pF, } R_L = 10\text{ M}\Omega, V_S = 5\text{V}$		8		kHz
SR	Slew rate (10% to 90%)	$G = 1, \text{ Rising Edge, } C_L = 20\text{ pF, } V_S = 5\text{V}$		2		V/ms
		$G = 1, \text{ Falling Edge, } C_L = 20\text{ pF, } V_S = 5\text{V}$		2.1		
POWER SUPPLY						
$I_{Q-LPV801}$	Quiescent Current	$V_{CM} = V^-, I_O = 0, V_S = 3.3\text{V}$		450	540	nA
$I_{Q-LPV802}$	Quiescent Current, Per Channel	$V_{CM} = V^-, I_O = 0, V_S = 3.3\text{V}$		320	415	nA

LPV801, LPV802

SNOSCZ3B – AUGUST 2016 – REVISED NOVEMBER 2016

www.ti.com

6.6 Typical Characteristics

at $T_A = 25^\circ\text{C}$, $R_L = 10\text{M}\Omega$ to $V_S/2$, $C_L = 20\text{pF}$, $V_{CM} = V_S / 2\text{V}$ unless otherwise specified.

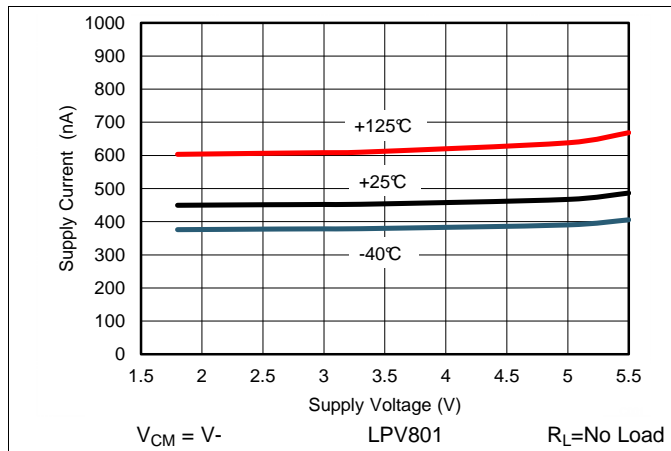

Figure 1. Supply Current vs. Supply Voltage, LPV801

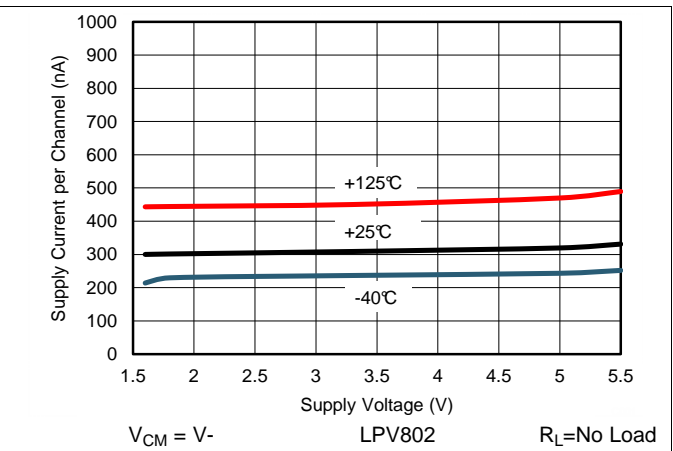

Figure 2. Supply Current vs. Supply Voltage, LPV802

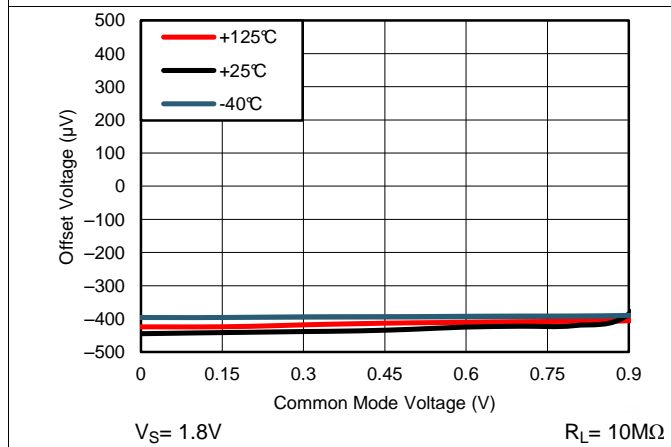

Figure 3. Typical Offset Voltage vs. Common Mode Voltage

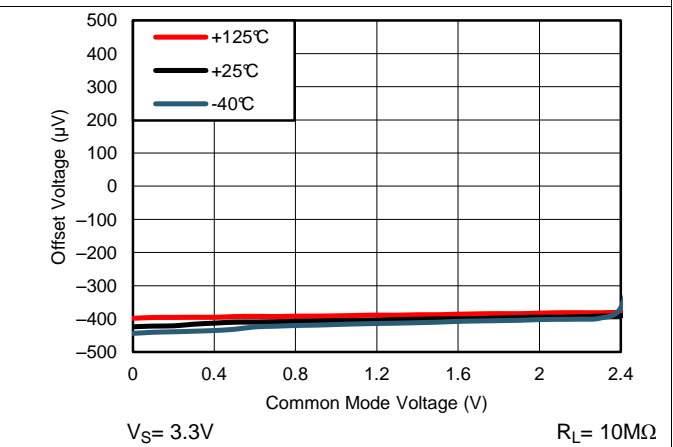

Figure 4. Typical Offset Voltage vs. Common Mode Voltage

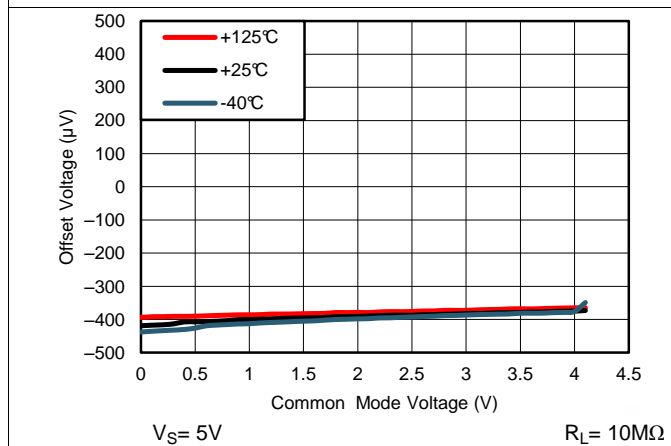

Figure 5. Typical Offset Voltage vs. Common Mode Voltage



Figure 6. Input Bias Current vs. Temperature

Typical Characteristics (continued)

at $T_A = 25^\circ\text{C}$, $R_L = 10\text{M}\Omega$ to $V_S/2$, $C_L = 20\text{pF}$, $V_{CM} = V_S / 2\text{V}$ unless otherwise specified.

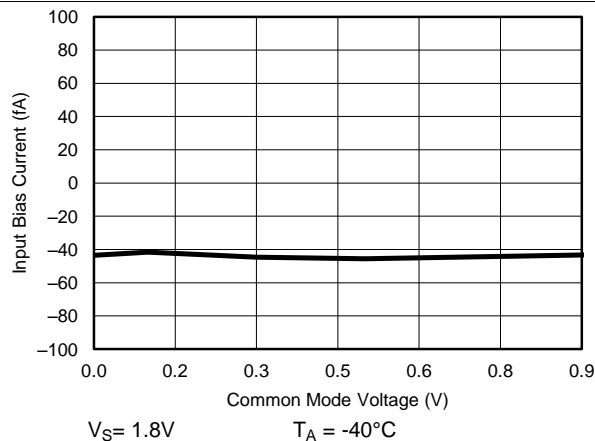

Figure 7. Input Bias Current vs. Common Mode Voltage

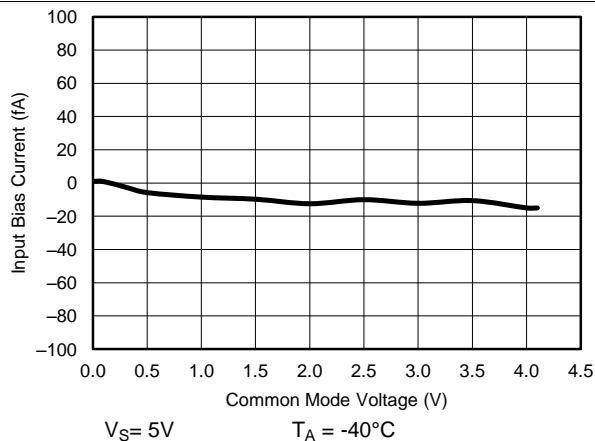

Figure 8. Input Bias Current vs. Common Mode Voltage

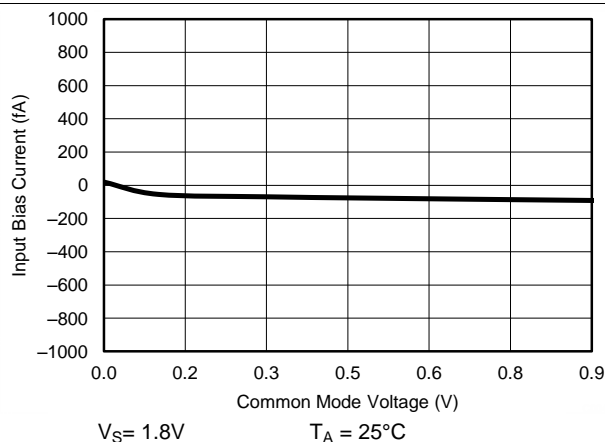

Figure 9. Input Bias Current vs. Common Mode Voltage

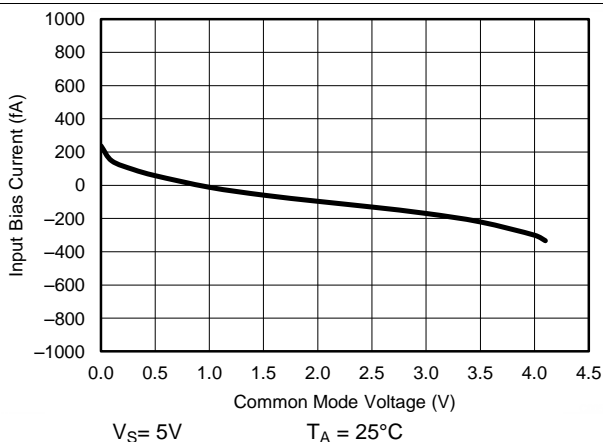

Figure 10. Input Bias Current vs. Common Mode Voltage

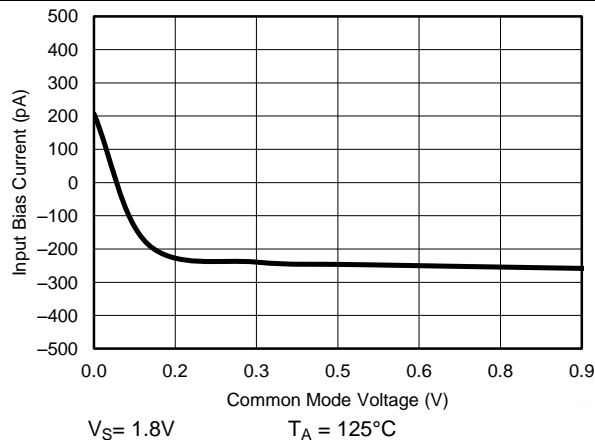

Figure 11. Input Bias Current vs. Common Mode Voltage

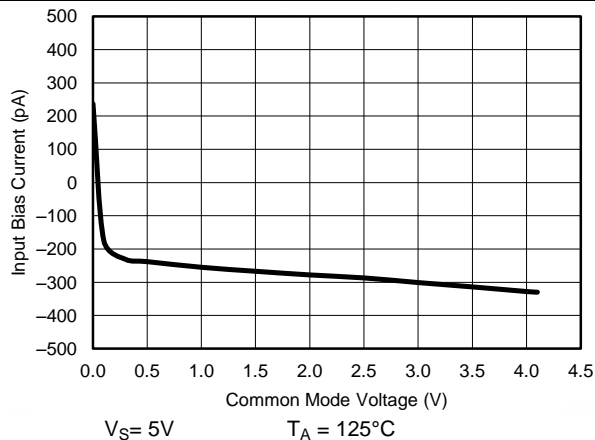
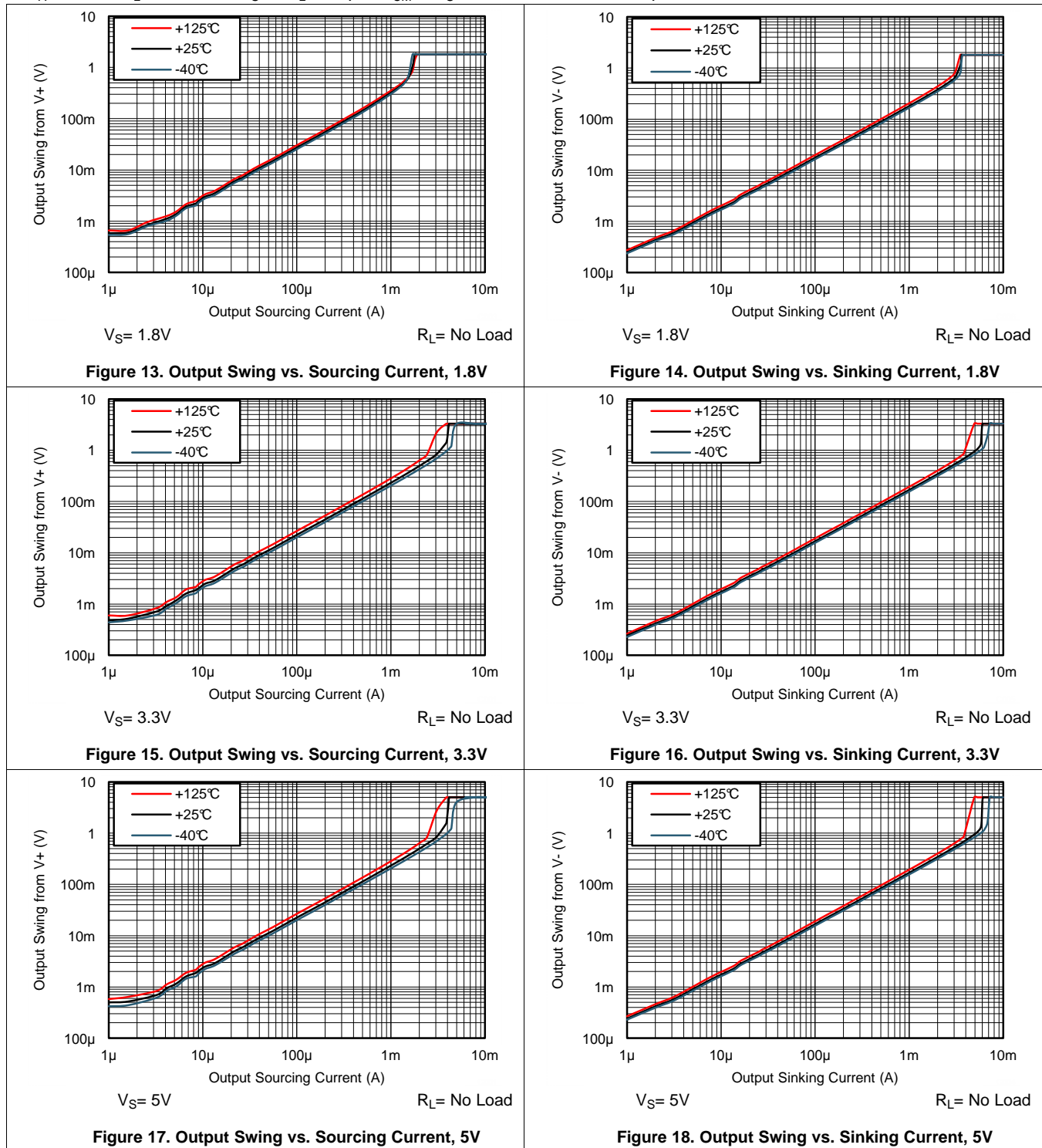

Figure 12. Input Bias Current vs. Common Mode Voltage

Typical Characteristics (continued)

at $T_A = 25^\circ\text{C}$, $R_L = 10\text{M}\Omega$ to $V_S/2$, $C_L = 20\text{pF}$, $V_{CM} = V_S / 2\text{V}$ unless otherwise specified.



Typical Characteristics (continued)

at $T_A = 25^\circ\text{C}$, $R_L = 10\text{M}\Omega$ to $V_S/2$, $C_L = 20\text{pF}$, $V_{CM} = V_S / 2\text{V}$ unless otherwise specified.

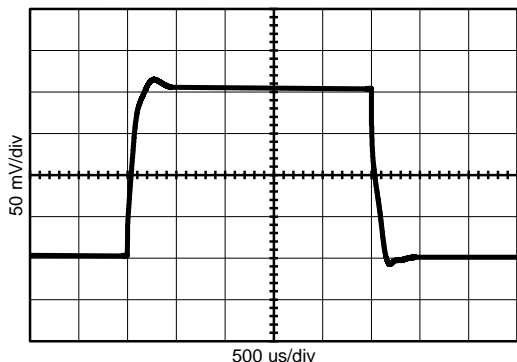

$T_A = 25$ $R_L = 10\text{M}\Omega$ $V_{out} = 200\text{mVpp}$
 $V_S = \pm 0.9\text{V}$ $C_L = 20\text{pF}$ $A_V = +1$

Figure 19. Small Signal Pulse Response, 1.8V

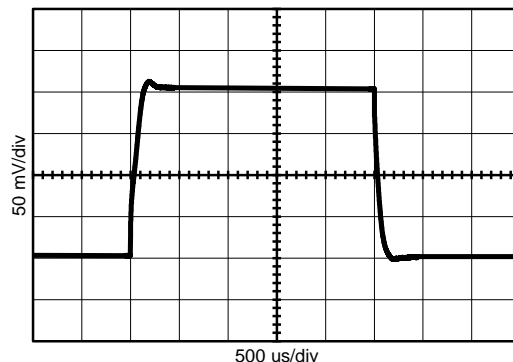

$T_A = 25$ $R_L = 10\text{M}\Omega$ $V_{out} = 200\text{mVpp}$
 $V_S = \pm 2.5\text{V}$ $C_L = 20\text{pF}$ $A_V = +1$

Figure 20. Small Signal Pulse Response, 5V

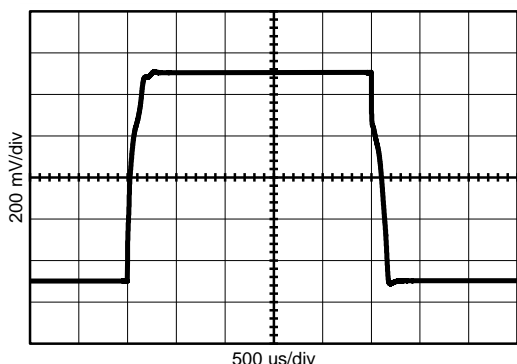

$T_A = 25$ $R_L = 10\text{M}\Omega$ $V_{out} = 1\text{Vpp}$
 $V_S = \pm 0.9\text{V}$ $C_L = 20\text{pF}$ $A_V = +1$

Figure 21. Large Signal Pulse Response, 1.8V

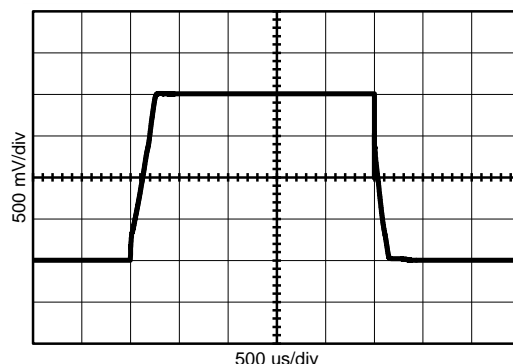

$T_A = 25$ $R_L = 10\text{M}\Omega$ $V_{out} = 2\text{Vpp}$
 $V_S = \pm 2.5\text{V}$ $C_L = 20\text{pF}$ $A_V = +1$

Figure 22. Large Signal Pulse Response, 5V

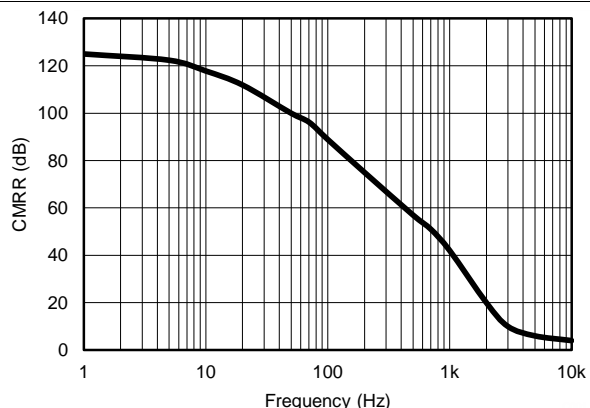

$T_A = 25$ $R_L = 10\text{M}\Omega$ $\Delta V_{CM} = 0.5\text{Vpp}$
 $V_S = 5\text{V}$ $C_L = 20\text{p}$
 $V_{CM} = V_S/2$ $A_V = +1$

Figure 23. CMRR vs Frequency

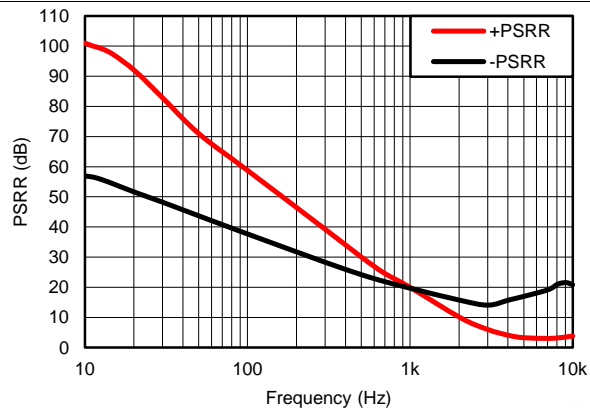

$T_A = 25$ $R_L = 10\text{M}\Omega$ $\Delta V_S = 0.5\text{Vpp}$
 $V_S = 3.3\text{V}$ $C_L = 20\text{p}$
 $V_{CM} = V_S/2$ $A_V = +1$

Figure 24. \pm PSRR vs Frequency

Typical Characteristics (continued)

at $T_A = 25^\circ\text{C}$, $R_L = 10\text{M}\Omega$ to $V_S/2$, $C_L = 20\text{pF}$, $V_{CM} = V_S / 2\text{V}$ unless otherwise specified.

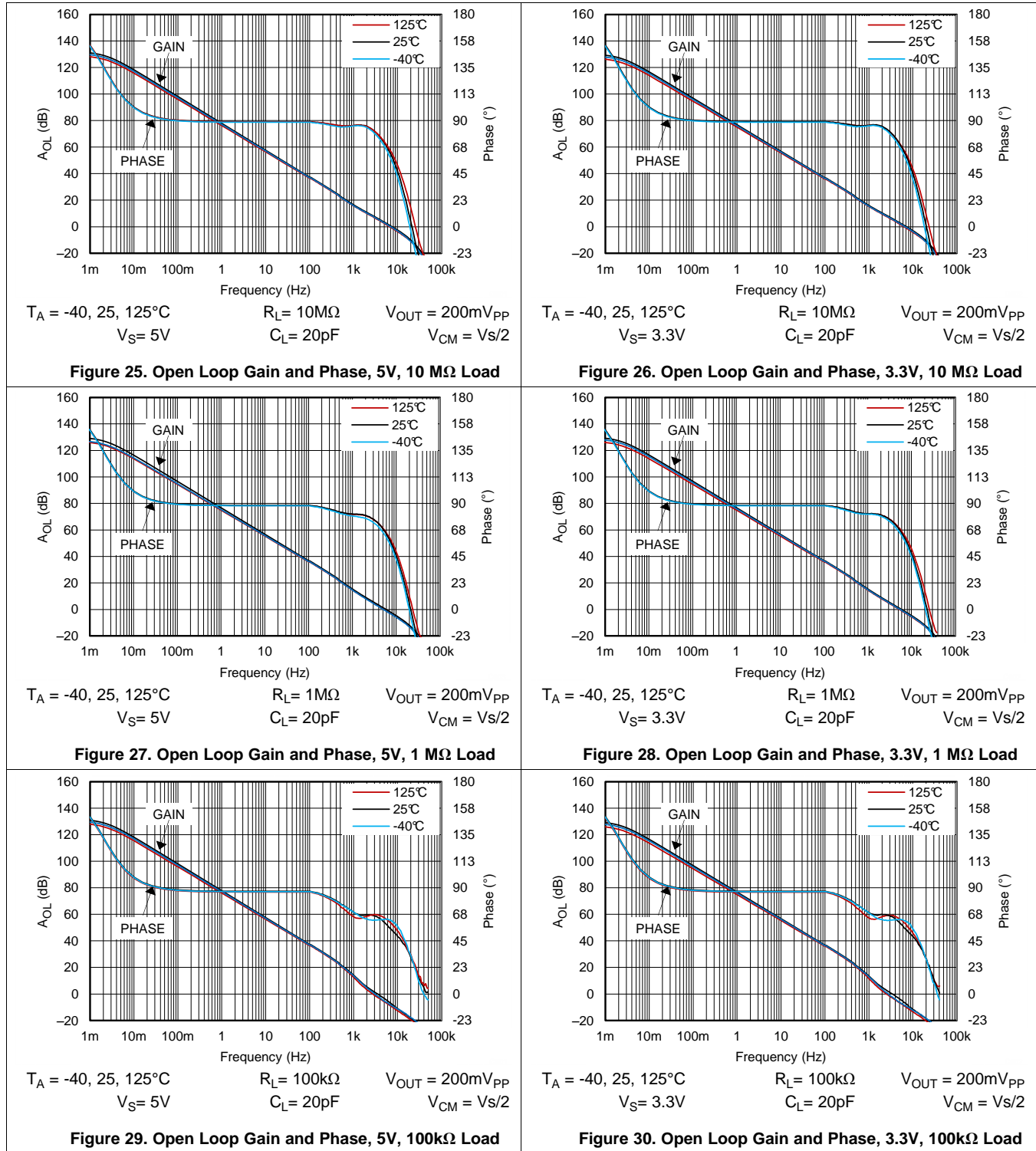

Typical Characteristics (continued)

at $T_A = 25^\circ\text{C}$, $R_L = 10\text{M}\Omega$ to $V_S/2$, $C_L = 20\text{pF}$, $V_{CM} = V_S / 2\text{V}$ unless otherwise specified.

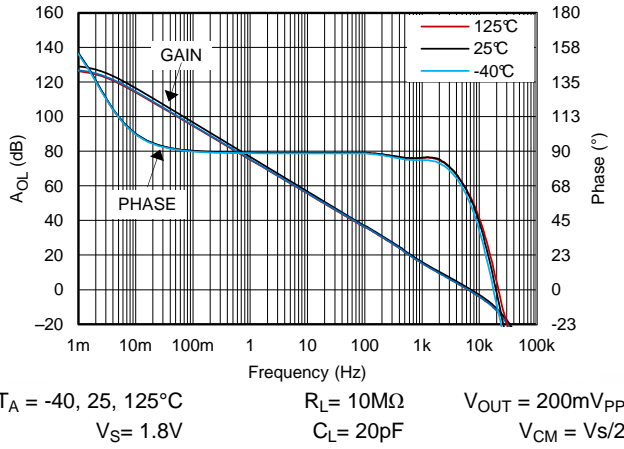

Figure 31. Open Loop Gain and Phase, 1.8V, 10 MΩ Load

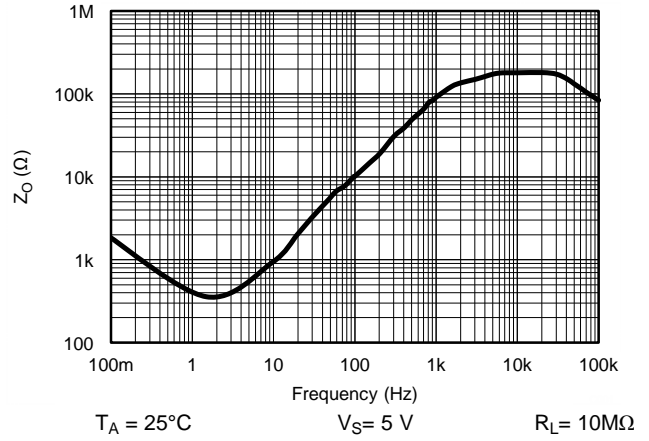

Figure 32. Open Loop Output Impedance

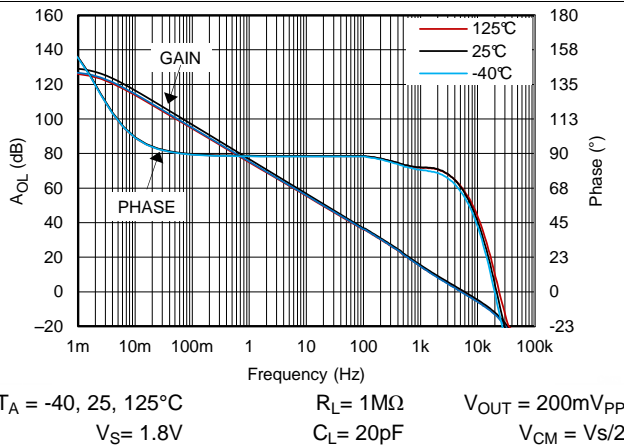

Figure 33. Open Loop Gain and Phase, 1.8V, 1 MΩ Load

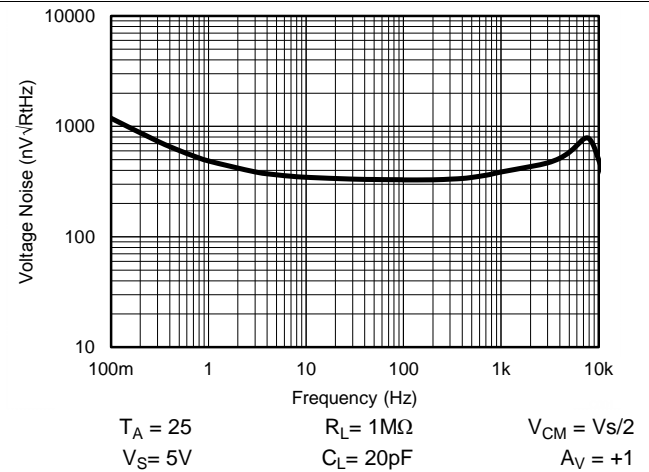

Figure 34. Input Voltage Noise vs Frequency

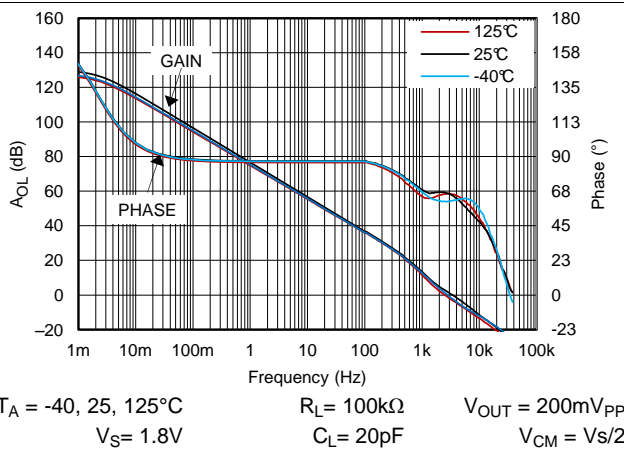

Figure 35. Open Loop Gain and Phase, 1.8V, 100kΩ Load

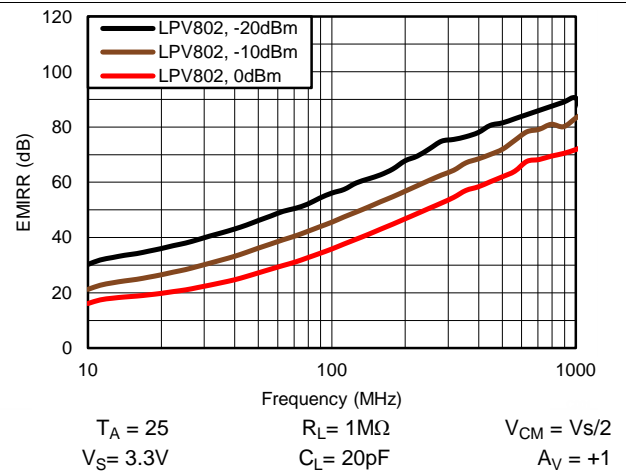

Figure 36. EMIRR Performance

7 Detailed Description

7.1 Overview

The LPV801 (single) and LPV802 (dual) series nanoPower CMOS operational amplifiers are designed for long-life battery-powered and energy harvested applications. They operate on a single supply with operation as low as 1.6V. The output is rail-to-rail and swings to within 3.5mV of the supplies with a 100kΩ load. The common-mode range extends to the negative supply making it ideal for single-supply applications. EMI protection has been employed internally to reduce the effects of EMI.

Parameters that vary significantly with operating voltages or temperature are shown in the [Typical Characteristics](#) curves.

7.2 Functional Block Diagram

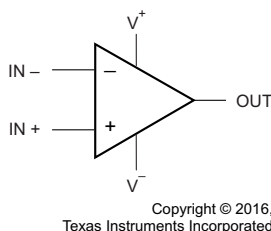

7.3 Feature Description

The amplifier's differential inputs consist of a non-inverting input (+IN) and an inverting input (–IN). The amplifier amplifies only the difference in voltage between the two inputs, which is called the differential input voltage. The output voltage of the op-amp V_{OUT} is given by [Equation 1](#):

$$V_{OUT} = A_{OL} (IN^+ - IN^-)$$

where

- A_{OL} is the open-loop gain of the amplifier, typically around 120 dB (1,000,000x, or 1,000,000 Volts per microvolt).

(1)

7.4 Device Functional Modes

7.4.1 Negative-Rail Sensing Input

The input common-mode voltage range of the LPV80x extends from (V-) to (V+) – 0.9 V. In this range, low offset can be expected with a minimum of 80dB CMRR. The LPV80x is protected from output "inversions" or "reversals".

7.4.2 Rail to Rail Output Stage

The LPV80x output voltage swings 3.5 mV from rails at 1.8 V supply, which provides the maximum possible dynamic range at the output. This is particularly important when operating on low supply voltages.

The LPV80x Maximum Output Voltage Swing graph defines the maximum swing possible under a particular output load.

7.4.3 Design Optimization for Nanopower Operation

When designing for ultralow power, choose system feedback components carefully. To minimize quiescent current consumption, select large-value feedback resistors. Any large resistors will react with stray capacitance in the circuit and the input capacitance of the operational amplifier. These parasitic RC combinations can affect the stability of the overall system. A feedback capacitor may be required to assure stability and limit overshoot or gain peaking.

When possible, use AC coupling and AC feedback to reduce static current draw through the feedback elements. Use film or ceramic capacitors since large electrolytics may have large static leakage currents in the nanoamps.

Device Functional Modes (continued)

7.4.4 Driving Capacitive Load

The LPV80x is internally compensated for stable unity gain operation, with a 8 kHz typical gain bandwidth. However, the unity gain follower is the most sensitive configuration to capacitive load. The combination of a capacitive load placed directly on the output of an amplifier along with the amplifier's output impedance creates a phase lag, which reduces the phase margin of the amplifier. If the phase margin is significantly reduced, the response will be under damped which causes peaking in the transfer and, when there is too much peaking, the op amp might start oscillating.

In order to drive heavy ($>50\text{pF}$) capacitive loads, an isolation resistor, R_{ISO} , should be used, as shown in [Figure 37](#). By using this isolation resistor, the capacitive load is isolated from the amplifier's output. The larger the value of R_{ISO} , the more stable the amplifier will be. If the value of R_{ISO} is sufficiently large, the feedback loop will be stable, independent of the value of C_L . However, larger values of R_{ISO} result in reduced output swing and reduced output current drive. The recommended value for R_{ISO} is 30-50k Ω .



Figure 37. Resistive Isolation Of Capacitive Load

8 Application and Implementation

NOTE

Information in the following applications sections is not part of the TI component specification, and TI does not warrant its accuracy or completeness. TI's customers are responsible for determining suitability of components for their purposes. Customers should validate and test their design implementation to confirm system functionality.

8.1 Application Information

The LPV80x is a ultra-low power operational amplifier that provides 8 kHz bandwidth with only 320nA typical quiescent current, and near precision drift specifications. These rail-to-rail output amplifiers are specifically designed for battery-powered applications. The input common-mode voltage range extends to the negative supply rail and the output swings to within millivolts of the rails, maintaining a wide dynamic range.

8.2 Typical Application: Three Terminal CO Gas Sensor Amplifier

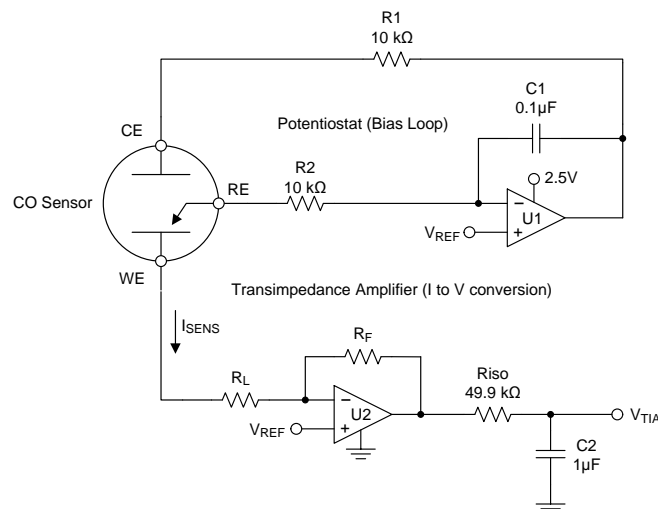

Figure 38. Three Terminal Gas Sensor Amplifier Schematic

8.2.1 Design Requirements

Figure 38 shows a simple micropower potentiostat circuit for use with three terminal unbiased CO sensors, though it is applicable to many other type of three terminal gas sensors or electrochemical cells.

The basic sensor has three electrodes; The Sense or Working Electrode (“WE”), Counter Electrode (“CE”) and Reference Electrode (“RE”). A current flows between the CE and WE proportional to the detected concentration.

The RE monitors the potential of the internal reference point. For an unbiased sensor, the WE and RE electrodes must be maintained at the same potential by adjusting the bias on CE. Through the Potentiostat circuit formed by U1, the servo feedback action will maintain the RE pin at a potential set by V_{REF} .

R1 is to maintain stability due to the large capacitance of the sensor. C1 and R2 form the Potentiostat integrator and set the feedback time constant.

U2 forms a transimpedance amplifier (“TIA”) to convert the resulting sensor current into a proportional voltage. The transimpedance gain, and resulting sensitivity, is set by R_F according to [Equation 2](#).

$$V_{TIA} = (-I * R_F) + V_{REF} \quad (2)$$

R_L is a load resistor of which the value is normally specified by the sensor manufacturer (typically 10 ohms). The potential at WE is set by the applied V_{REF} . Riso provides capacitive isolation and, combined with C2, form the output filter and ADC reservoir capacitor to drive the ADC.

Typical Application: Three Terminal CO Gas Sensor Amplifier (continued)

8.2.2 Detailed Design Procedure

For this example, we will be using a CO sensor with a sensitivity of 69nA/ppm. The supply voltage and maximum ADC input voltage is 2.5V, and the maximum concentration is 300ppm.

First the V_{REF} voltage must be determined. This voltage is a compromise between maximum headroom and resolution, as well as allowance for "footroom" for the minimum swing on the CE terminal, since the CE terminal generally goes negative in relation to the RE potential as the concentration (sensor current) increases. Bench measurements found the difference between CE and RE to be 180mV at 300ppm for this particular sensor.

To allow for negative CE swing "footroom" and voltage drop across the 10k resistor, 300mV was chosen for V_{REF} .

Therefore +300mV will be used as the minimum V_{ZERO} to add some headroom.

$$V_{ZERO} = V_{REF} = +300\text{mV}$$

where

- V_{ZERO} is the zero concentration voltage
 - V_{REF} is the reference voltage (300mV)
- (3)

Next we calculate the maximum sensor current at highest expected concentration:

$$I_{SENSMAX} = I_{PERPPM} * \text{ppmMAX} = 69\text{nA} * 300\text{ppm} = 20.7\mu\text{A}$$

where

- $I_{SENSMAX}$ is the maximum expected sensor current
 - I_{PERPPM} is the manufacturer specified sensor current in Amps per ppm
 - ppmMAX is the maximum required ppm reading
- (4)

Now find the available output swing range above the reference voltage available for the measurement:

$$V_{SWING} = V_{OUTMAX} - V_{ZERO} = 2.5\text{V} - 0.3\text{V} = 2.2\text{V}$$

where

- V_{SWING} is the expected change in output voltage
 - V_{OUTMAX} is the maximum amplifier output swing (usually near V+)
- (5)

Now we calculate the transimpedance resistor (R_F) value using the maximum swing and the maximum sensor current:

$$R_F = V_{SWING} / I_{SENSMAX} = 2.2\text{V} / 20.7\mu\text{A} = 106.28 \text{ k}\Omega \text{ (we will use } 110 \text{ k}\Omega \text{ for a common value)}$$
(6)

Typical Application: Three Terminal CO Gas Sensor Amplifier (continued)

8.2.3 Application Curve

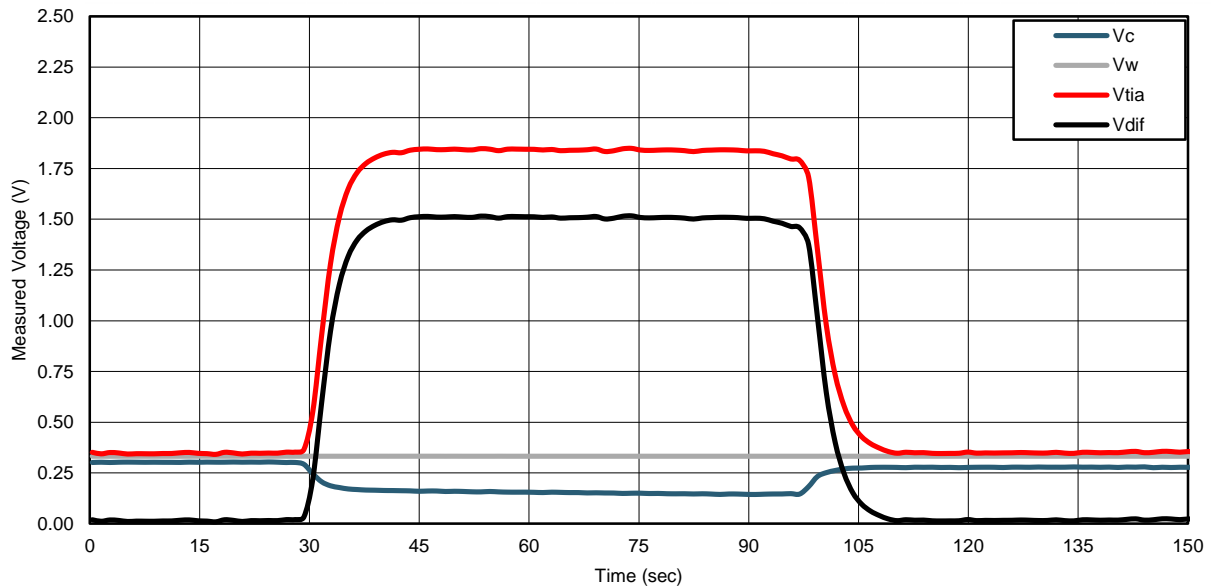

Figure 39. Monitored Voltages when exposed to 200ppm CO

Figure 39 shows the resulting circuit voltages when the sensor was exposed to 200ppm step of carbon monoxide gas. V_C is the monitored CE pin voltage and clearly shows the expected CE voltage dropping below the WE voltage, V_W , as the concentration increases.

V_{TIA} is the output of the transimpedance amplifier U2. V_{DIFF} is the calculated difference between V_{REF} and V_{TIA} , which will be used for the ppm calculation.

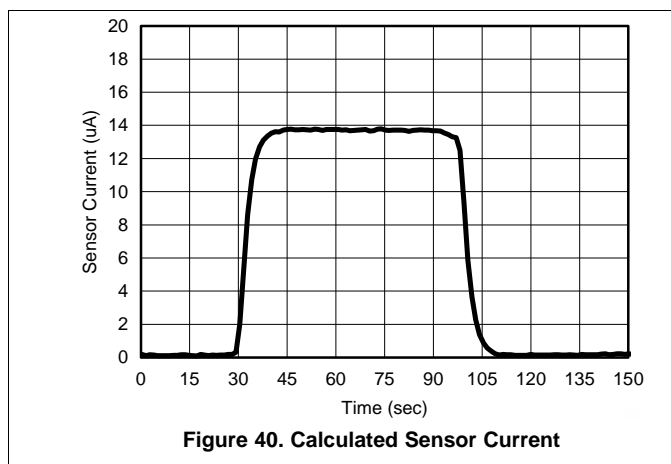

Figure 40. Calculated Sensor Current

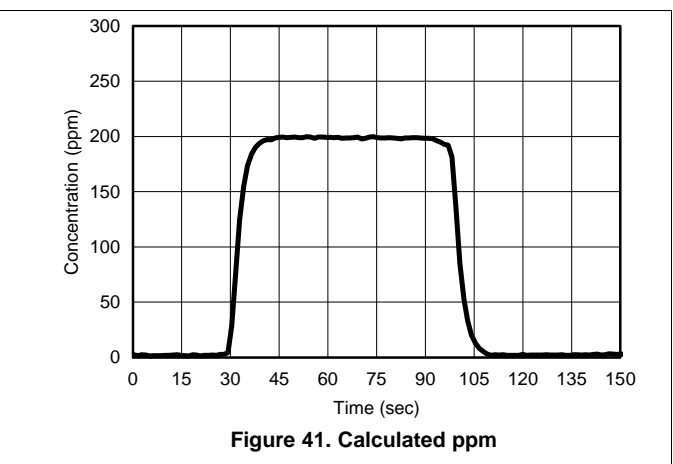

Figure 41. Calculated ppm

Figure 40 shows the calculated sensor current using the formula in Equation 7 :

$$I_{SENSOR} = V_{DIFF} / R_F = 1.52V / 110 \text{ k}\Omega = 13.8\mu A \tag{7}$$

Equation 8 shows the resulting conversion of the sensor current into ppm.

$$\text{ppm} = I_{SENSOR} / I_{PERPPM} = 13.8\mu A / 69nA = 200 \tag{8}$$

Total supply current for the amplifier section is less than 700 nA, minus sensor current. Note that the sensor current is sourced from the amplifier output, which in turn comes from the amplifier supply voltage. Therefore, any continuous sensor current must also be included in supply current budget calculations.

11 Device and Documentation Support

11.1 Device Support

11.1.1 Development Support

[TINA-TI SPICE-Based Analog Simulation Program](#)

[DIP Adapter Evaluation Module](#)

[TI Universal Operational Amplifier Evaluation Module](#)

[TI FilterPro Filter Design Software](#)

11.2 Receiving Notification of Documentation Updates

To receive notification of documentation updates, navigate to the device product folder on ti.com. In the upper right corner, click on *Alert me* to register and receive a weekly digest of any product information that has changed. For change details, review the revision history included in any revised document.

11.3 Community Resources

The following links connect to TI community resources. Linked contents are provided "AS IS" by the respective contributors. They do not constitute TI specifications and do not necessarily reflect TI's views; see TI's [Terms of Use](#).

TI E2E™ Online Community *TI's Engineer-to-Engineer (E2E) Community*. Created to foster collaboration among engineers. At e2e.ti.com, you can ask questions, share knowledge, explore ideas and help solve problems with fellow engineers.

Design Support *TI's Design Support* Quickly find helpful E2E forums along with design support tools and contact information for technical support.

11.4 Related Links

The table below lists quick access links. Categories include technical documents, support and community resources, tools and software, and quick access to sample or buy.

Table 1. Related Links

PARTS	PRODUCT FOLDER	SAMPLE & BUY	TECHNICAL DOCUMENTS	TOOLS & SOFTWARE	SUPPORT & COMMUNITY
LPV801	Click here	Click here	Click here	Click here	Click here
LPV802	Click here	Click here	Click here	Click here	Click here

11.5 Trademarks

E2E is a trademark of Texas Instruments. All other trademarks are the property of their respective owners.

11.6 Electrostatic Discharge Caution



These devices have limited built-in ESD protection. The leads should be shorted together or the device placed in conductive foam during storage or handling to prevent electrostatic damage to the MOS gates.

11.7 Glossary

[SLYZ022](#) — *TI Glossary*.

This glossary lists and explains terms, acronyms, and definitions.

12 Mechanical, Packaging, and Orderable Information

The following pages include mechanical, packaging, and orderable information. This information is the most current data available for the designated devices. This data is subject to change without notice and revision of this document. For browser-based versions of this data sheet, refer to the left-hand navigation.

PACKAGING INFORMATION

Orderable part number	Status (1)	Material type (2)	Package Pins	Package qty Carrier	RoHS (3)	Lead finish/ Ball material (4)	MSL rating/ Peak reflow (5)	Op temp (°C)	Part marking (6)
LPV801DBVR	Active	Production	SOT-23 (DBV) 5	3000 LARGE T&R	Yes	SN	Level-1-260C-UNLIM	-40 to 125	15VM
LPV801DBVR.B	Active	Production	SOT-23 (DBV) 5	3000 LARGE T&R	Yes	SN	Level-1-260C-UNLIM	-40 to 125	15VM
LPV801DBVT	Active	Production	SOT-23 (DBV) 5	250 SMALL T&R	Yes	SN	Level-1-260C-UNLIM	-40 to 125	15VM
LPV801DBVT.B	Active	Production	SOT-23 (DBV) 5	250 SMALL T&R	Yes	SN	Level-1-260C-UNLIM	-40 to 125	15VM
LPV802DGKR	Active	Production	VSSOP (DGK) 8	2500 LARGE T&R	Yes	NIPDAU SN NIPDAUAG	Level-1-260C-UNLIM	-40 to 125	(L802, LPV) 802
LPV802DGKR.B	Active	Production	VSSOP (DGK) 8	2500 LARGE T&R	Yes	NIPDAU	Level-1-260C-UNLIM	-40 to 125	(L802, LPV) 802
LPV802DGKT	Active	Production	VSSOP (DGK) 8	250 SMALL T&R	Yes	NIPDAU SN NIPDAUAG	Level-1-260C-UNLIM	-40 to 125	(L802, LPV) 802
LPV802DGKT.B	Active	Production	VSSOP (DGK) 8	250 SMALL T&R	Yes	NIPDAU	Level-1-260C-UNLIM	-40 to 125	(L802, LPV) 802

(1) **Status:** For more details on status, see our [product life cycle](#).

(2) **Material type:** When designated, preproduction parts are prototypes/experimental devices, and are not yet approved or released for full production. Testing and final process, including without limitation quality assurance, reliability performance testing, and/or process qualification, may not yet be complete, and this item is subject to further changes or possible discontinuation. If available for ordering, purchases will be subject to an additional waiver at checkout, and are intended for early internal evaluation purposes only. These items are sold without warranties of any kind.

(3) **RoHS values:** Yes, No, RoHS Exempt. See the [TI RoHS Statement](#) for additional information and value definition.

(4) **Lead finish/Ball material:** Parts may have multiple material finish options. Finish options are separated by a vertical ruled line. Lead finish/Ball material values may wrap to two lines if the finish value exceeds the maximum column width.

(5) **MSL rating/Peak reflow:** The moisture sensitivity level ratings and peak solder (reflow) temperatures. In the event that a part has multiple moisture sensitivity ratings, only the lowest level per JEDEC standards is shown. Refer to the shipping label for the actual reflow temperature that will be used to mount the part to the printed circuit board.

(6) **Part marking:** There may be an additional marking, which relates to the logo, the lot trace code information, or the environmental category of the part.

Multiple part markings will be inside parentheses. Only one part marking contained in parentheses and separated by a "~" will appear on a part. If a line is indented then it is a continuation of the previous line and the two combined represent the entire part marking for that device.

Important Information and Disclaimer: The information provided on this page represents TI's knowledge and belief as of the date that it is provided. TI bases its knowledge and belief on information provided by third parties, and makes no representation or warranty as to the accuracy of such information. Efforts are underway to better integrate information from third parties. TI has taken and continues to take reasonable steps to provide representative and accurate information but may not have conducted destructive testing or chemical analysis on incoming materials and chemicals. TI and TI suppliers consider certain information to be proprietary, and thus CAS numbers and other limited information may not be available for release.

In no event shall TI's liability arising out of such information exceed the total purchase price of the TI part(s) at issue in this document sold by TI to Customer on an annual basis.

TAPE AND REEL INFORMATION

QUADRANT ASSIGNMENTS FOR PIN 1 ORIENTATION IN TAPE

*All dimensions are nominal

Device	Package Type	Package Drawing	Pins	SPQ	Reel Diameter (mm)	Reel Width W1 (mm)	A0 (mm)	B0 (mm)	K0 (mm)	P1 (mm)	W (mm)	Pin1 Quadrant
LPV801DBVR	SOT-23	DBV	5	3000	180.0	8.4	3.2	3.2	1.4	4.0	8.0	Q3
LPV801DBVR	SOT-23	DBV	5	3000	178.0	8.4	3.2	3.2	1.4	4.0	8.0	Q3
LPV801DBVT	SOT-23	DBV	5	250	178.0	8.4	3.2	3.2	1.4	4.0	8.0	Q3
LPV801DBVT	SOT-23	DBV	5	250	180.0	8.4	3.2	3.2	1.4	4.0	8.0	Q3
LPV802DGKR	VSSOP	DGK	8	2500	330.0	12.4	5.25	3.35	1.25	8.0	12.0	Q1
LPV802DGKT	VSSOP	DGK	8	250	330.0	12.4	5.3	3.4	1.4	8.0	12.0	Q1
LPV802DGKT	VSSOP	DGK	8	250	330.0	12.4	5.25	3.35	1.25	8.0	12.0	Q1

TAPE AND REEL BOX DIMENSIONS

*All dimensions are nominal

Device	Package Type	Package Drawing	Pins	SPQ	Length (mm)	Width (mm)	Height (mm)
LPV801DBVR	SOT-23	DBV	5	3000	210.0	185.0	35.0
LPV801DBVR	SOT-23	DBV	5	3000	208.0	191.0	35.0
LPV801DBVT	SOT-23	DBV	5	250	208.0	191.0	35.0
LPV801DBVT	SOT-23	DBV	5	250	210.0	185.0	35.0
LPV802DGKR	VSSOP	DGK	8	2500	366.0	364.0	50.0
LPV802DGKT	VSSOP	DGK	8	250	353.0	353.0	32.0
LPV802DGKT	VSSOP	DGK	8	250	366.0	364.0	50.0

EXAMPLE BOARD LAYOUT

DBV0005A

SOT-23 - 1.45 mm max height

SMALL OUTLINE TRANSISTOR



LAND PATTERN EXAMPLE
EXPOSED METAL SHOWN
SCALE:15X



SOLDER MASK DETAILS

4214839/K 08/2024

NOTES: (continued)

- 6. Publication IPC-7351 may have alternate designs.
- 7. Solder mask tolerances between and around signal pads can vary based on board fabrication site.

EXAMPLE STENCIL DESIGN

DBV0005A

SOT-23 - 1.45 mm max height

SMALL OUTLINE TRANSISTOR



SOLDER PASTE EXAMPLE
BASED ON 0.125 mm THICK STENCIL
SCALE:15X

4214839/K 08/2024

NOTES: (continued)

8. Laser cutting apertures with trapezoidal walls and rounded corners may offer better paste release. IPC-7525 may have alternate design recommendations.
9. Board assembly site may have different recommendations for stencil design.

DGK0008A



PACKAGE OUTLINE

VSSOP - 1.1 mm max height

SMALL OUTLINE PACKAGE



4214862/A 04/2023

NOTES:

PowerPAD is a trademark of Texas Instruments.

1. All linear dimensions are in millimeters. Any dimensions in parenthesis are for reference only. Dimensioning and tolerancing per ASME Y14.5M.
2. This drawing is subject to change without notice.
3. This dimension does not include mold flash, protrusions, or gate burrs. Mold flash, protrusions, or gate burrs shall not exceed 0.15 mm per side.
4. This dimension does not include interlead flash. Interlead flash shall not exceed 0.25 mm per side.
5. Reference JEDEC registration MO-187.

EXAMPLE BOARD LAYOUT

DGK0008A

™ VSSOP - 1.1 mm max height

SMALL OUTLINE PACKAGE



LAND PATTERN EXAMPLE
EXPOSED METAL SHOWN
SCALE: 15X

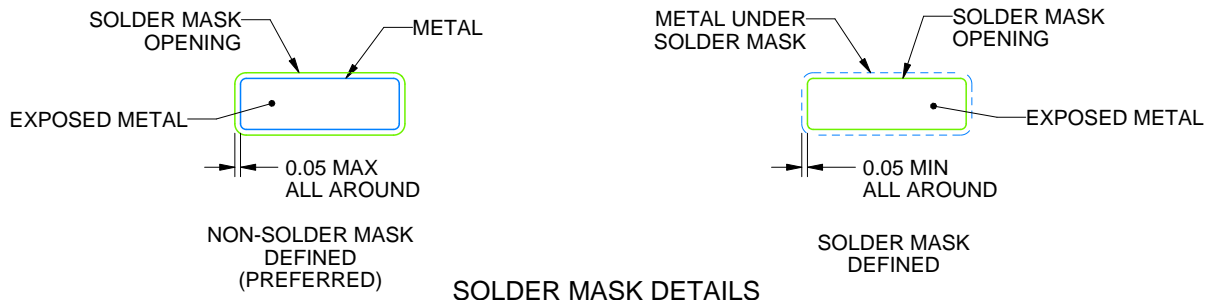

SOLDER MASK DETAILS

4214862/A 04/2023

NOTES: (continued)

6. Publication IPC-7351 may have alternate designs.
7. Solder mask tolerances between and around signal pads can vary based on board fabrication site.
8. Vias are optional depending on application, refer to device data sheet. If any vias are implemented, refer to their locations shown on this view. It is recommended that vias under paste be filled, plugged or tented.
9. Size of metal pad may vary due to creepage requirement.

EXAMPLE STENCIL DESIGN

DGK0008A

TM VSSOP - 1.1 mm max height

SMALL OUTLINE PACKAGE



SOLDER PASTE EXAMPLE
SCALE: 15X

4214862/A 04/2023

NOTES: (continued)

11. Laser cutting apertures with trapezoidal walls and rounded corners may offer better paste release. IPC-7525 may have alternate design recommendations.
12. Board assembly site may have different recommendations for stencil design.

IMPORTANT NOTICE AND DISCLAIMER

TI PROVIDES TECHNICAL AND RELIABILITY DATA (INCLUDING DATASHEETS), DESIGN RESOURCES (INCLUDING REFERENCE DESIGNS), APPLICATION OR OTHER DESIGN ADVICE, WEB TOOLS, SAFETY INFORMATION, AND OTHER RESOURCES "AS IS" AND WITH ALL FAULTS, AND DISCLAIMS ALL WARRANTIES, EXPRESS AND IMPLIED, INCLUDING WITHOUT LIMITATION ANY IMPLIED WARRANTIES OF MERCHANTABILITY, FITNESS FOR A PARTICULAR PURPOSE OR NON-INFRINGEMENT OF THIRD PARTY INTELLECTUAL PROPERTY RIGHTS.

These resources are intended for skilled developers designing with TI products. You are solely responsible for (1) selecting the appropriate TI products for your application, (2) designing, validating and testing your application, and (3) ensuring your application meets applicable standards, and any other safety, security, regulatory or other requirements.

These resources are subject to change without notice. TI grants you permission to use these resources only for development of an application that uses the TI products described in the resource. Other reproduction and display of these resources is prohibited. No license is granted to any other TI intellectual property right or to any third party intellectual property right. TI disclaims responsibility for, and you fully indemnify TI and its representatives against any claims, damages, costs, losses, and liabilities arising out of your use of these resources.

TI's products are provided subject to [TI's Terms of Sale](#), [TI's General Quality Guidelines](#), or other applicable terms available either on ti.com or provided in conjunction with such TI products. TI's provision of these resources does not expand or otherwise alter TI's applicable warranties or warranty disclaimers for TI products. Unless TI explicitly designates a product as custom or customer-specified, TI products are standard, catalog, general purpose devices.

TI objects to and rejects any additional or different terms you may propose.

Copyright © 2026, Texas Instruments Incorporated

Last updated 10/2025