

## 12-Bit, 200kHz, *microPower* Sampling ANALOG-TO-DIGITAL CONVERTER

### FEATURES

- 200kHz Sampling Rate
- *microPower*:  
1.6mW at 200kHz  
0.54mW at 75kHz  
0.06mW at 7.5kHz
- Power Down: 3μA max
- Mini-DIP-8, SO-8, and MSOP-8 Packages
- Pseudo-Differential Input
- Serial Interface

### APPLICATIONS

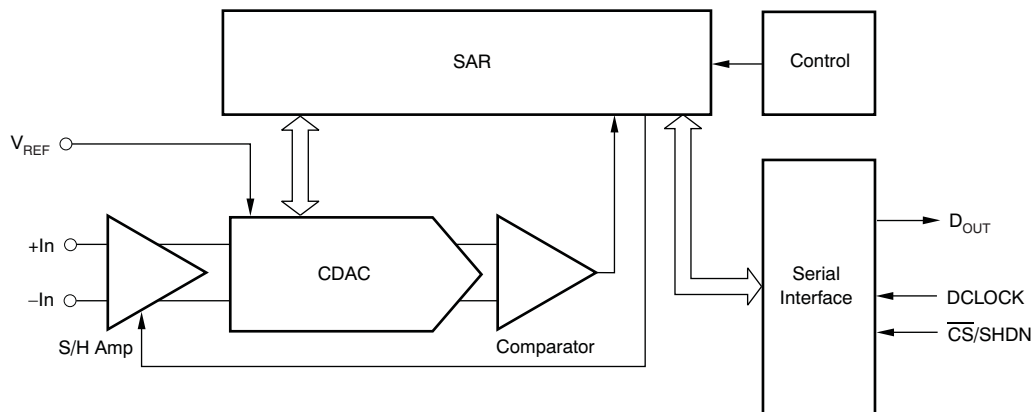
- Battery-Operated Systems
- Remote Data Acquisition
- Isolated Data Acquisition
- Simultaneous Sampling, Multichannel Systems

### DESCRIPTION

The ADS7822 is a 12-bit sampling analog-to-digital (A/D) converter with ensured specifications over a 2.7V to 5.25V supply range. It requires very little power even when operating at the full 200kHz rate. At lower conversion rates, the high speed of the device enables it to spend most of its time in the power-down mode—the power dissipation is less than 60μW at 7.5kHz.

The ADS7822 also features operation from 2.0V to 5V, a synchronous serial interface, and a pseudo-differential input. The reference voltage can be set to any level within the range of 50mV to  $V_{CC}$ .

Ultra low power and small size make the ADS7822 ideal for battery-operated systems. It is also a perfect fit for remote data-acquisition modules, simultaneous multichannel systems, and isolated data acquisition. The ADS7822 is available in a plastic mini-DIP-8, an SO-8, or an MSOP-8 package.



Please be aware that an important notice concerning availability, standard warranty, and use in critical applications of Texas Instruments semiconductor products and disclaimers thereto appears at the end of this data sheet.

All trademarks are the property of their respective owners.



This integrated circuit can be damaged by ESD. Texas Instruments recommends that all integrated circuits be handled with appropriate precautions. Failure to observe proper handling and installation procedures can cause damage.

ESD damage can range from subtle performance degradation to complete device failure. Precision integrated circuits may be more susceptible to damage because very small parametric changes could cause the device not to meet its published specifications.

**ORDERING INFORMATION<sup>(1)</sup>**

PRODUCT	MAXIMUM INTEGRAL LINEARITY ERROR (LSB)	MAXIMUM DIFFERENTIAL LINEARITY ERROR (LSB)	PACKAGE-LEAD	PACKAGE DESIGNATOR	SPECIFIED TEMPERATURE RANGE	PACKAGE MARKING <sup>(2)</sup>	ORDERING NUMBER	TRANSPORT MEDIA, QUANTITY
ADS7822E	±2	±2	MSOP-8	DGK	–40°C to +85°C	A22	ADS7822E/250	Tape and Reel, 250
							ADS7822E/2K5	Tape and Reel, 2500
ADS7822EB	±1	±1	MSOP-8	DGK	–40°C to +85°C	A22	ADS7822EB/250	Tape and Reel, 250
							ADS7822EB/2K5	Tape and Reel, 2500
ADS7822EC	±0.75	±0.75	MSOP-8	DGK	–40°C to +85°C	A22	ADS7822EC/250	Tape and Reel, 250
							ADS7822EC/2K5	Tape and Reel, 2500
ADS7822P	±2	±2	Plastic DIP-8	P	–40°C to +85°C	ADS7822P	ADS7822P	Rails, 50
ADS7822PB	±1	±1	Plastic DIP-8	P	–40°C to +85°C	ADS7822PB	ADS7822PB	Rails, 50
ADS7822PC	±0.75	±0.75	Plastic DIP-8	P	–40°C to +85°C	ADS7822PC	ADS7822PC	Rails, 50
ADS7822U	±2	±2	SO-8	D	–40°C to +85°C	ADS7822U	ADS7822U	Rails, 100
							ADS7822U/2K5	Tape and Reel, 2500
ADS7822UB	±1	±1	SO-8	D	–40°C to +85°C	ADS7822UB	ADS7822UB	Rails, 100
							ADS7822UB/2K5	Tape and Reel, 2500
ADS7822UC	±0.75	±0.75	SO-8	D	–40°C to +85°C	ADS7822UC	ADS7822UC	Rails, 100
							ADS7822UC/2K5	Tape and Reel, 2500

- (1) For the most current package and ordering information, see the Package Option Addendum located at the end of this data sheet, or see the TI website at [www.ti.com](http://www.ti.com).
- (2) Performance grade information is marked on the reel.

**ABSOLUTE MAXIMUM RATINGS<sup>(1)</sup>**

over operating free-air temperature range (unless otherwise noted)

	ADS7822	UNIT
V <sub>CC</sub>	+6	V
Analog input	–0.3 to V <sub>CC</sub> + 0.3	V
Logic input	–0.3 to 6	V
Case temperature	+100	°C
Junction temperature	+150	°C
Storage temperature	+125	°C
External reference voltage	+5.5	V

- (1) Stresses beyond those listed under *Absolute Maximum Ratings* may cause permanent damage to the device. These are stress ratings only, and functional operation of the device at these or any other conditions beyond those indicated under *Recommended Operating Conditions* is not implied. Exposure to absolute-maximum rated conditions for extended periods may affect device reliability.

### ELECTRICAL CHARACTERISTICS: +V<sub>CC</sub> = +2.7V

At –40°C to +85°C, +V<sub>CC</sub> = +2.7V, V<sub>REF</sub> = +2.5V, f<sub>SAMPLE</sub> = 75kHz, and f<sub>CLK</sub> = 16 × f<sub>SAMPLE</sub>, unless otherwise noted.

PARAMETER	TEST CONDITIONS	ADS7822			ADS7822B			ADS7822C			UNIT
		MIN	TYP	MAX	MIN	TYP	MAX	MIN	TYP	MAX	
<b>ANALOG INPUT</b>											
Full-scale input span	+In – (–In)	0		V <sub>REF</sub>	0		V <sub>REF</sub>	0		V <sub>REF</sub>	V
Absolute input range	+In – GND	–0.2		V <sub>CC</sub> + 0.2	–0.2		V <sub>CC</sub> + 0.2	–0.2		V <sub>CC</sub> + 0.2	V
	–In – GND	–0.2		+1.0	–0.2		+1.0	–0.2		+1.0	V
Capacitance			25			25			25		pF
Leakage current			±1			±1			±1		µA
<b>SYSTEM PERFORMANCE</b>											
Resolution			12			12			12		Bits
No missing codes		11			12			11			Bits
Integral linearity error		–2	±0.5	+2	–1	±0.5	+1	–0.75	±0.25	+0.75	LSB <sup>(1)</sup>
Differential linearity error		–2	±0.5	+2	–1	±0.5	+1	–0.75	±0.25	+0.75	LSB
Offset error		–3		+3	–3		+3	–1		+1	LSB
Gain error		–3		+3	–3		+3	–1		+1	LSB
Noise			33			33			33		µVrms
Power-supply rejection			82			82			82		dB
<b>SAMPLING DYNAMICS</b>											
Conversion time				12			12			12	Clk Cycles
Acquisition time		1.5			1.5			1.5			Clk Cycles
Throughput rate				75			75			75	kHz
<b>DYNAMIC CHARACTERISTICS</b>											
Total harmonic distortion	V <sub>IN</sub> = 2.5V <sub>pp</sub> at 1kHz		–82			–82			–82		dB
SINAD	V <sub>IN</sub> = 2.5V <sub>pp</sub> at 1kHz		71			71			71		dB
Spurious-free dynamic range	V <sub>IN</sub> = 2.5V <sub>pp</sub> at 1kHz		86			86			86		dB
<b>REFERENCE OUTPUT</b>											
Voltage range		0.05		V <sub>CC</sub>	0.05		V <sub>CC</sub>	0.05		V <sub>CC</sub>	V
Resistance	$\overline{CS}$ = GND, f <sub>SAMPLE</sub> = 0Hz		5			5			5		GΩ
	$\overline{CS}$ = V <sub>CC</sub>		5			5			5		GΩ
Current drain	At code 710h		8	40		8	40		8	40	µA
	f <sub>SAMPLE</sub> = 7.5kHz		0.8			0.8			0.8		µA
	$\overline{CS}$ = V <sub>CC</sub>		0.001	3		0.001	3		0.001	3	µA
<b>DIGITAL INPUT/OUTPUT</b>											
Logic family			CMOS			CMOS			CMOS		
Logic levels	V <sub>IH</sub>	I <sub>IH</sub> = +5µA	2.0	5.5	2.0	5.5	2.0	5.5	2.0	5.5	V
	V <sub>IL</sub>	I <sub>IL</sub> = +5µA	–0.3	0.8	–0.3	0.8	–0.3	0.8	–0.3	0.8	V
	V <sub>OH</sub>	I <sub>OH</sub> = –250µA	2.1		2.1		2.1		2.1		V
	V <sub>OL</sub>	I <sub>OL</sub> = 250µA		0.4		0.4		0.4		0.4	V
Data format			Straight Binary			Straight Binary			Straight Binary		
<b>POWER-SUPPLY REQUIREMENTS</b>											
V <sub>CC</sub>	Specified performance		2.7	3.6	2.7	3.6	2.7	3.6	2.7	3.6	V
	See Notes <sup>(2)</sup> and <sup>(3)</sup>		2.0	2.7	2.0	2.7	2.0	2.7	2.0	2.7	V
	See Note <sup>(3)</sup>		2.7	3.6	2.7	3.6	2.7	3.6	2.7	3.6	V
Quiescent current	f <sub>SAMPLE</sub> = 7.5kHz <sup>(4)(5)</sup>		20			20			20		µA
	f <sub>SAMPLE</sub> = 75kHz <sup>(5)</sup>		200	325		200	325		200	325	µA
Power down	$\overline{CS}$ = V <sub>CC</sub>			3			3			3	µA
<b>TEMPERATURE RANGE</b>											
Specified performance		–40		+85	–40		+85	–40		+85	°C

- (1) LSB means least significant bit. With V<sub>REF</sub> equal to +2.5V, one LSB is 0.61mV.
- (2) The maximum clock rate of the ADS7822 is less than 1.2MHz in this power-supply range.
- (3) See the [Typical Characteristics](#) for more information.
- (4) f<sub>CLK</sub> = 1.2MHz,  $\overline{CS}$  = V<sub>CC</sub> for 145 clock cycles out of every 160.
- (5) See the [Power Dissipation](#) section for more information regarding lower sample rates.

**ELECTRICAL CHARACTERISTICS: +V<sub>CC</sub> = +5V**

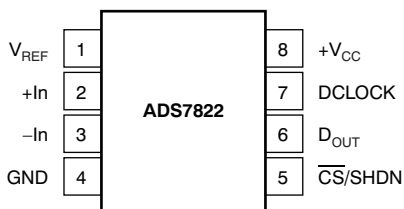
At –40°C to +85°C, +V<sub>CC</sub> = +5V, V<sub>REF</sub> = +5V, f<sub>SAMPLE</sub> = 200kHz, and f<sub>CLK</sub> = 16 × f<sub>SAMPLE</sub>, unless otherwise noted.

PARAMETER	TEST CONDITIONS	ADS7822			ADS7822B			UNIT
		MIN	TYP	MAX	MIN	TYP	MAX	
<b>ANALOG INPUT</b>								
Full-scale input span	+In – (–In)	0		V <sub>REF</sub>	0		V <sub>REF</sub>	V
Absolute input range	+In – GND	–0.2		V <sub>CC</sub> + 0.2	–0.2		V <sub>CC</sub> + 0.2	V
	–In – GND	–0.2		+1.0	–0.2		+1.0	V
Capacitance			25			25		pF
Leakage current			±1			±1		µA
<b>SYSTEM PERFORMANCE</b>								
Resolution			12			12		Bits
No missing codes		11			12			Bits
Integral linearity error		–2		+2	–1		+1	LSB <sup>(1)</sup>
Differential linearity error			±0.8		–1	±0.5	+1	LSB
Offset error		–3		+3	–3		+3	LSB
Gain error		–4		+4	–3		+3	LSB
Noise			33			33		µVrms
Power-supply rejection			70			70		dB
<b>SAMPLING DYNAMICS</b>								
Conversion time				12			12	Clk Cycles
Acquisition time		1.5			1.5			Clk Cycles
Throughput rate				200			200	kHz
<b>DYNAMIC CHARACTERISTICS</b>								
Total harmonic distortion	V <sub>IN</sub> = 5V <sub>pp</sub> at 10kHz		–78			–78		dB
SINAD	V <sub>IN</sub> = 5V <sub>pp</sub> at 10kHz		71			71		dB
Spurious-free dynamic range	V <sub>IN</sub> = 5V <sub>pp</sub> at 10kHz		79			79		dB
<b>REFERENCE OUTPUT</b>								
Voltage range		0.05		V <sub>CC</sub>	0.05		V <sub>CC</sub>	V
Resistance	$\overline{CS}$ = GND, f <sub>SAMPLE</sub> = 0Hz		5			5		GΩ
	$\overline{CS}$ = V <sub>CC</sub>		5			5		GΩ
Current drain	At code 710h		40	100		40	100	µA
	f <sub>SAMPLE</sub> = 12.5kHz		2.5			2.5		µA
	$\overline{CS}$ = V <sub>CC</sub>		0.001	3		0.001	3	µA
<b>DIGITAL INPUT/OUTPUT</b>								
Logic family			CMOS			CMOS		
Logic levels	V <sub>IH</sub>	I <sub>IH</sub> = +5µA	3.0	5.5	3.0	5.5		V
	V <sub>IL</sub>	I <sub>IL</sub> = +5µA	–0.3	0.8	–0.3	0.8		V
	V <sub>OH</sub>	I <sub>OH</sub> = –250µA	3.5		3.5			V
	V <sub>OL</sub>	I <sub>OL</sub> = 250µA		0.4			0.4	V
Data format			Straight Binary			Straight Binary		
<b>POWER-SUPPLY REQUIREMENTS</b>								
V <sub>CC</sub>	Specified performance	4.75		5.25	4.75		5.25	V
Quiescent current	f <sub>SAMPLE</sub> = 200kHz		320	550		320	550	µA
Power down	$\overline{CS}$ = V <sub>CC</sub>			3			3	µA
<b>TEMPERATURE RANGE</b>								
Specified performance		–40		+85	–40		+85	°C

(1) LSB means least significant bit. With V<sub>REF</sub> equal to +5V, one LSB is 1.22mV.

## PIN CONFIGURATION

D, DGK, OR P PACKAGE  
SO, MSOP, or DIP  
(TOP VIEW)



## PIN ASSIGNMENTS

PIN		DESCRIPTION
NAME	NO.	
V <sub>REF</sub>	1	Reference input
+In	2	Noninverting input
-In	3	Inverting input. Connect to ground or to remote ground sense point.
GND	4	Ground
$\overline{\text{CS}}/\text{SHDN}$	5	Chip select when low; Shutdown mode when high.
D <sub>OUT</sub>	6	The serial output data word is comprised of 12 bits of data. In operation, the data are valid on the falling edge of DCLOCK. The second clock pulse after the falling edge of $\overline{\text{CS}}$ enables the serial output. After one null bit, the data are valid for the next edges.
DCLOCK	7	Data clock synchronizes the serial data transfer and determines conversion speed.
+V <sub>CC</sub>	8	Power supply

**TYPICAL CHARACTERISTICS**

At  $T_A = +25^\circ\text{C}$ ,  $V_{CC} = +2.7\text{V}$ ,  $V_{REF} = +2.5\text{V}$ ,  $f_{\text{SAMPLE}} = 75\text{kHz}$ ,  $f_{\text{CLK}} = 16 \times f_{\text{SAMPLE}}$ , unless otherwise specified.

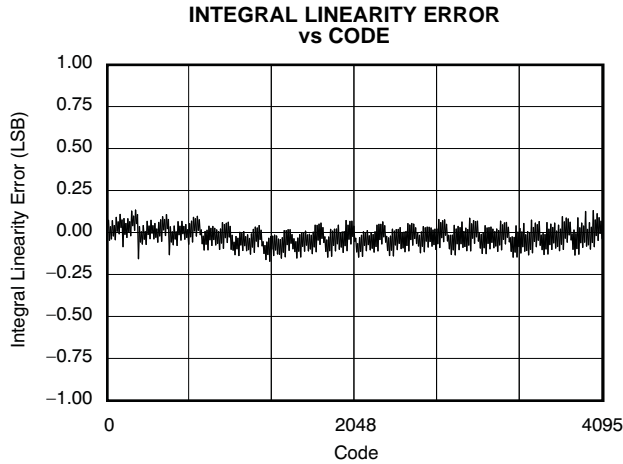


Figure 1.

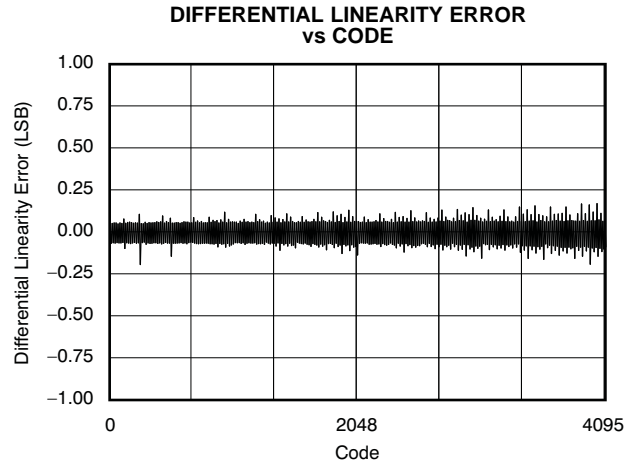


Figure 2.

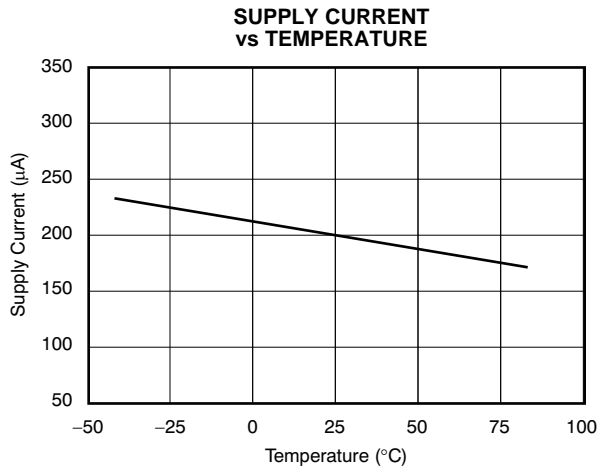


Figure 3.

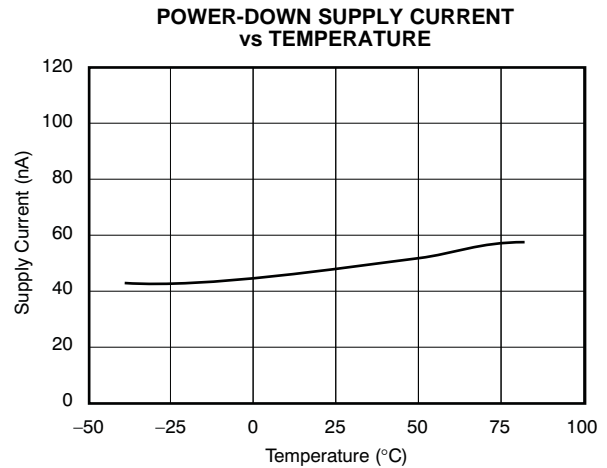


Figure 4.

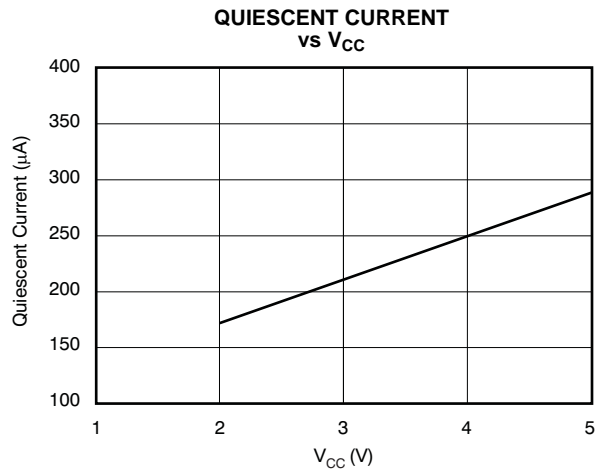


Figure 5.

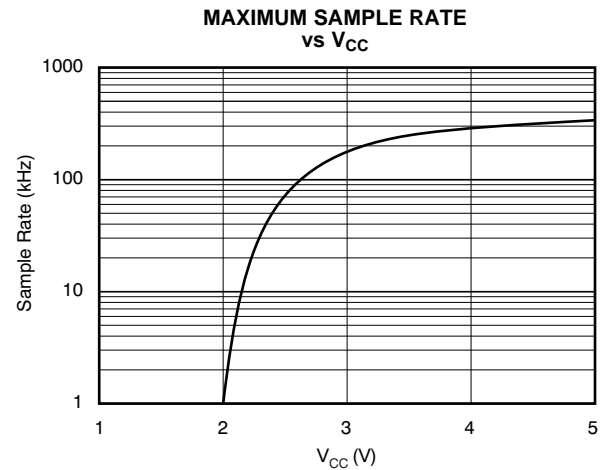


Figure 6.

**TYPICAL CHARACTERISTICS (continued)**

At  $T_A = +25^\circ\text{C}$ ,  $V_{CC} = +2.7\text{V}$ ,  $V_{REF} = +2.5\text{V}$ ,  $f_{SAMPLE} = 75\text{kHz}$ ,  $f_{CLK} = 16 \times f_{SAMPLE}$ , unless otherwise specified.

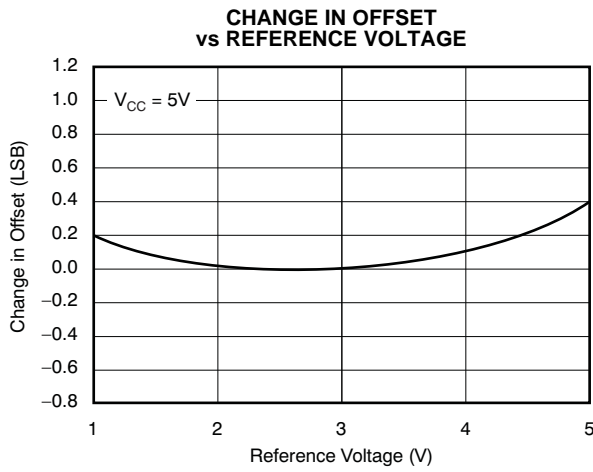


Figure 7.

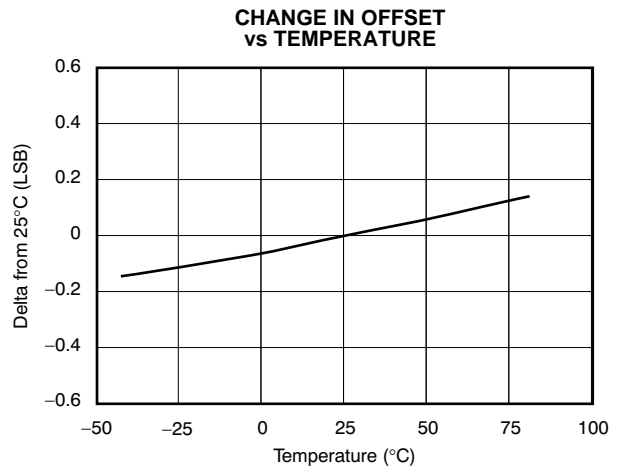


Figure 8.

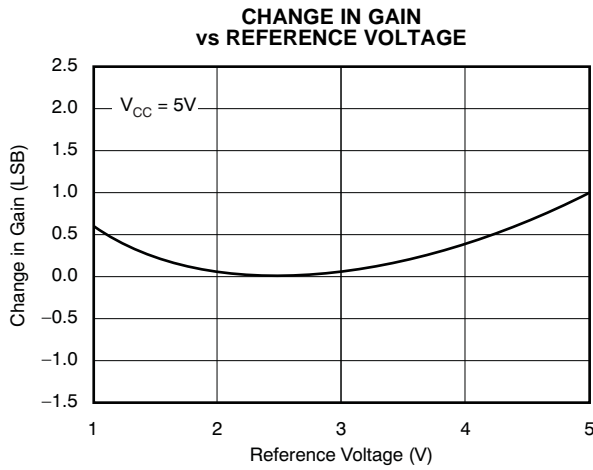


Figure 9.

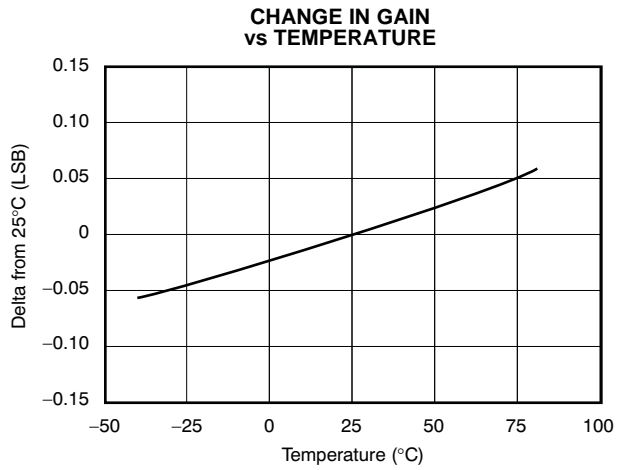


Figure 10.

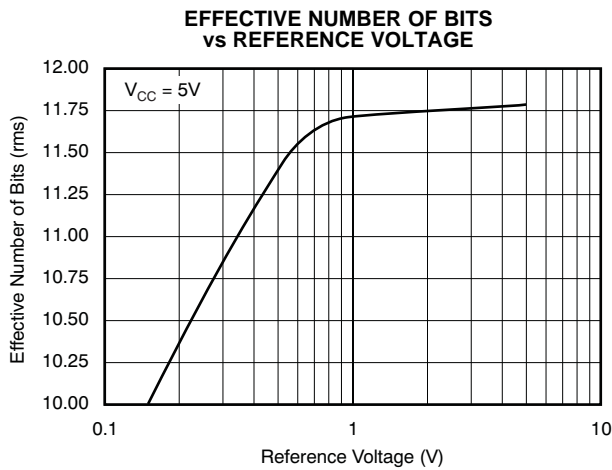


Figure 11.

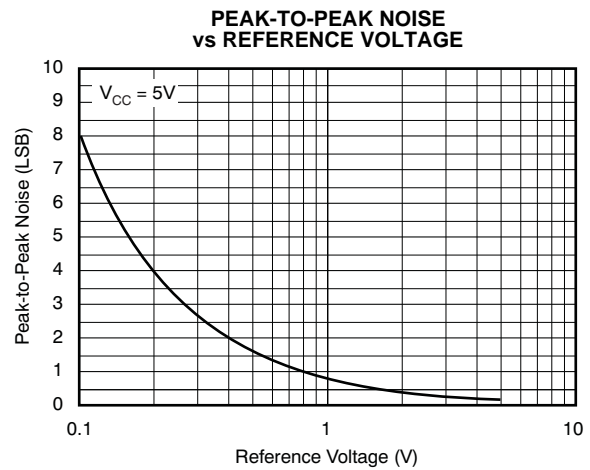


Figure 12.

**TYPICAL CHARACTERISTICS (continued)**

At  $T_A = +25^\circ\text{C}$ ,  $V_{CC} = +2.7\text{V}$ ,  $V_{REF} = +2.5\text{V}$ ,  $f_{\text{SAMPLE}} = 75\text{kHz}$ ,  $f_{\text{CLK}} = 16 \times f_{\text{SAMPLE}}$ , unless otherwise specified.

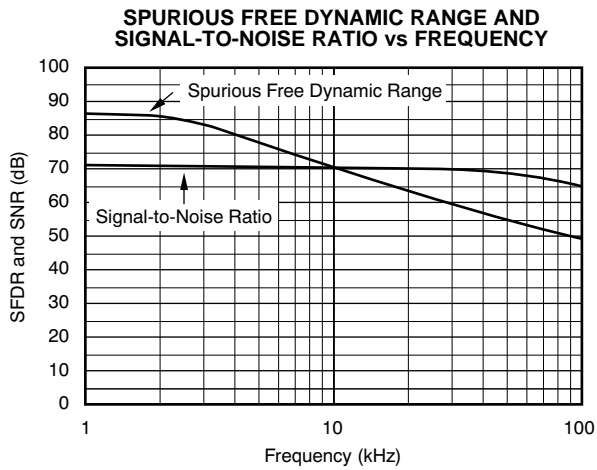


Figure 13.

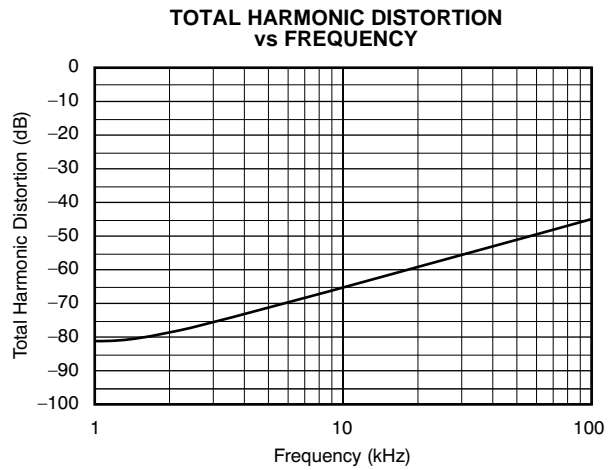


Figure 14.

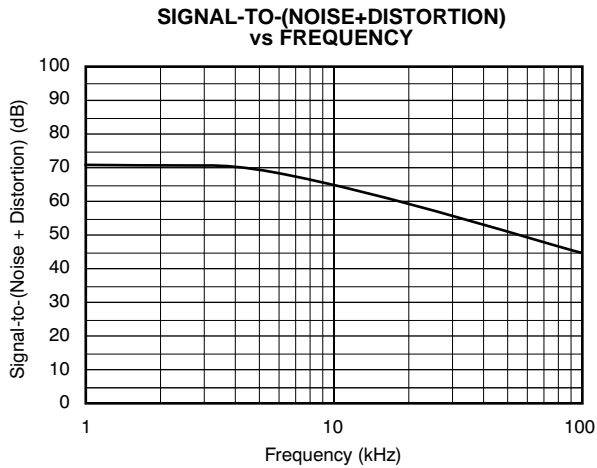


Figure 15.

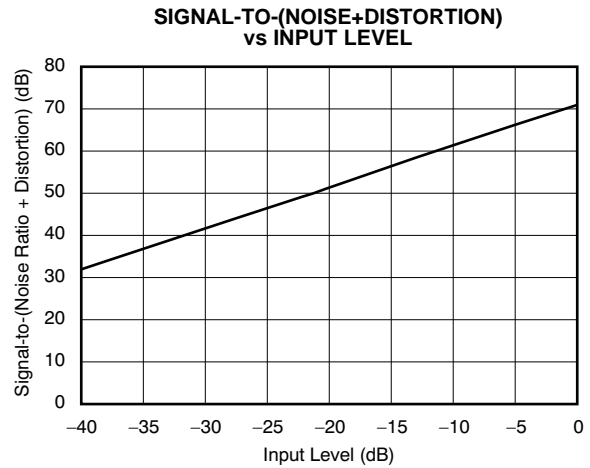


Figure 16.

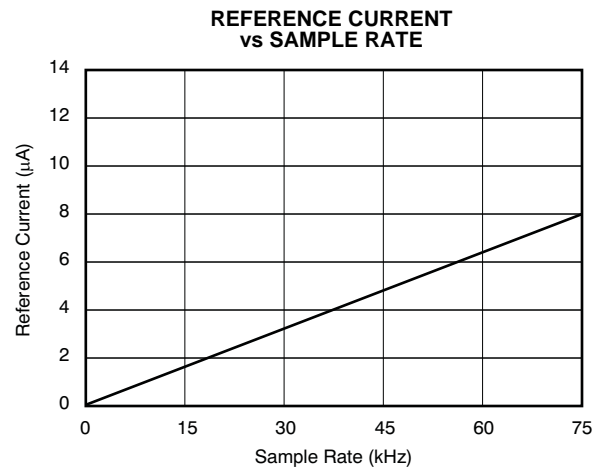


Figure 17.

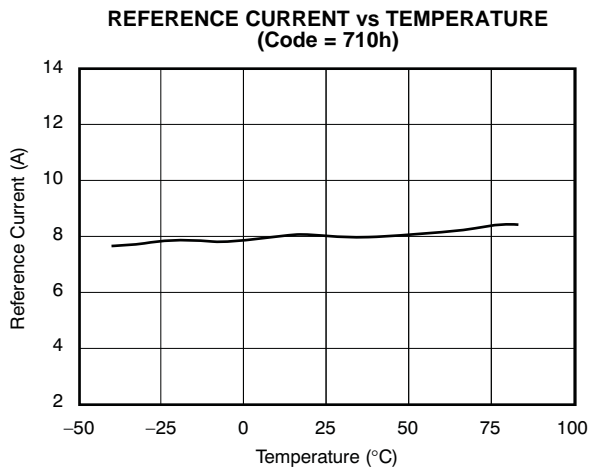
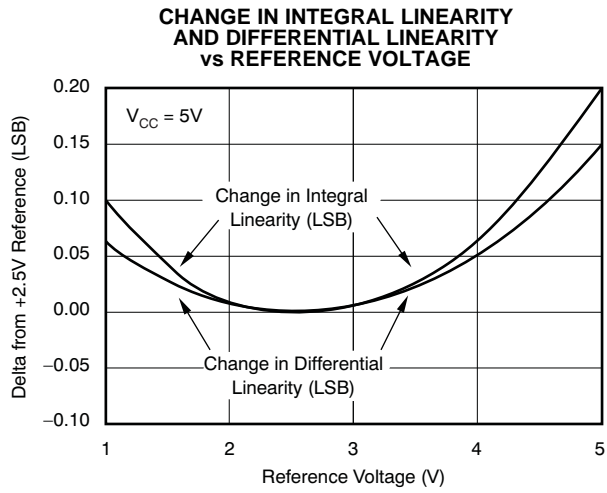
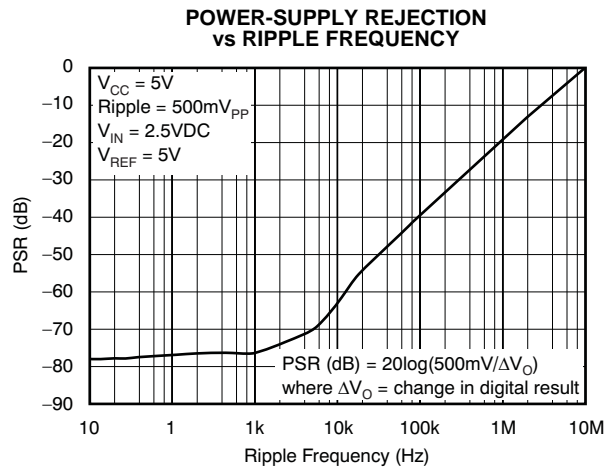
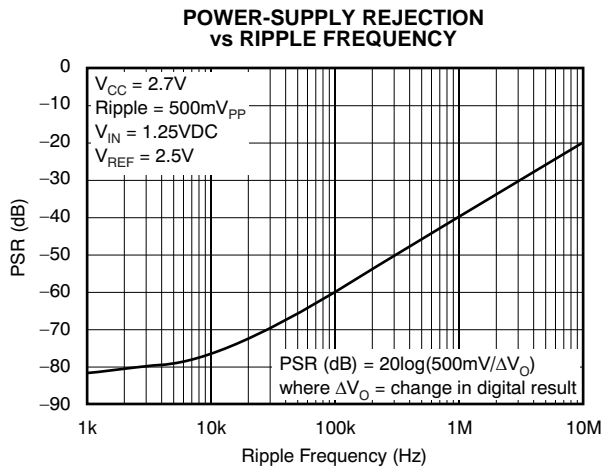


Figure 18.

**TYPICAL CHARACTERISTICS (continued)**

At  $T_A = +25^\circ\text{C}$ ,  $V_{CC} = +2.7\text{V}$ ,  $V_{REF} = +2.5\text{V}$ ,  $f_{\text{SAMPLE}} = 75\text{kHz}$ ,  $f_{\text{CLK}} = 16 \times f_{\text{SAMPLE}}$ , unless otherwise specified.



## THEORY OF OPERATION

The ADS7822 is a classic successive approximation register (SAR) A/D converter. The architecture is based on capacitive redistribution that inherently includes a sample/hold function. The converter is fabricated on a 0.6 $\mu$  CMOS process. The architecture and process allow the ADS7822 to acquire and convert an analog signal at up to 200,000 conversions per second while consuming very little power.

The ADS7822 requires an external reference, an external clock, and a single power source ( $V_{CC}$ ). The external reference can be any voltage between 50mV and  $V_{CC}$ . The value of the reference voltage directly sets the range of the analog input. The reference input current depends on the conversion rate of the ADS7822.

The external clock can vary between 10kHz (625Hz throughput) and 3.2MHz (200kHz throughput). The duty cycle of the clock is essentially unimportant as long as the minimum high and low times are at least 400ns for a supply range between 2.7V to 3.6V, or 125ns for a supply range between 4.75V to 5.25V. The minimum clock frequency is set by the leakage on the capacitors internal to the ADS7822.

The analog input is provided to two input pins: +In and –In. When a conversion is initiated, the differential input on these pins is sampled on the internal capacitor array. While a conversion is in progress, both inputs are disconnected from any internal function.

The digital result of the conversion is clocked out by the DCLOCK input and is provided serially, most significant bit first, on the D<sub>OUT</sub> pin. The digital data that is provided on the D<sub>OUT</sub> pin is for the conversion currently in progress—there is no pipeline delay. It is possible to continue to clock the ADS7822 after the conversion is complete and to obtain the serial data least significant bit first. See the [Digital Interface](#) section for more information.

### ANALOG INPUT

The +In and –In input pins allow for a pseudo-differential input signal. Unlike some converters of this type, the –In input is not resampled later in the conversion cycle. When the converter goes into the hold mode, the voltage difference between +In and –In is captured on the internal capacitor array.

The range of the –In input is limited to –0.2V to +1V. Because of this, the differential input can be used to reject only small signals that are common to both inputs. Thus, the –In input is best used to sense a remote signal ground that may move slightly with respect to the local ground potential.

The input current on the analog inputs depends on a number of factors: sample rate, input voltage, source impedance, and power-down mode. Essentially, the current into the ADS7822 charges the internal capacitor array during the sample period. After this capacitance has been fully charged, there is no further input current. The source of the analog input voltage must be able to charge the input capacitance (25pF) to a 12-bit settling level within 1.5 clock cycles. When the converter goes into the hold mode or while it is in the power-down mode, the input impedance is greater than 1G $\Omega$ .

Care must be taken regarding the absolute analog input voltage. To maintain the linearity of the converter, the –In input should not drop below GND – 200mV or exceed GND + 1V. The +In input should always remain within the range of GND – 200mV to  $V_{CC}$  + 200mV. Outside of these ranges, the converter linearity may not meet specifications.

### REFERENCE INPUT

The external reference sets the analog input range. The ADS7822 operates with a reference in the range of 50mV to  $V_{CC}$ . There are several important implications of this.

As the reference voltage is reduced, the analog voltage weight of each digital output code is reduced. This is often referred to as the LSB (least significant bit) size and is equal to the reference voltage divided by 4096. This means that any offset or gain error inherent in the A/D converter will appear to increase, in terms of LSB size, as the reference voltage is reduced.

The noise inherent in the converter will also appear to increase with lower LSB size. With a 2.5V reference, the internal noise of the converter typically contributes only 0.32 LSB peak-to-peak of potential error to the output code. When the external reference is 50mV, the potential error contribution from the internal noise will be 50 times larger—16 LSBs. The errors due to the internal noise are gaussian in nature and can be reduced by averaging consecutive conversion results.

For more information regarding noise, consult the typical characteristic curves [Effective Number of Bits vs Reference Voltage](#) and [Peak-to-Peak Noise vs Reference Voltage](#). Note that the effective number of bits (ENOB) figure is calculated based on the converter signal-to-(noise + distortion) ratio with a 1kHz, 0dB input signal. SINAD is related to ENOB as follows:

$$\text{SINAD} = 6.02 \cdot \text{ENOB} + 1.76$$

With lower reference voltages, extra care should be taken to provide a clean layout including adequate bypassing, a clean power supply, a low-noise reference, and a low-noise input signal. Because the LSB size is lower, the converter will also be more sensitive to external sources of error such as nearby digital signals and electromagnetic interference.

## DIGITAL INTERFACE

### Signal Levels

The digital inputs of the ADS7822 can accommodate logic levels up to 6V regardless of the value of  $V_{CC}$ . Thus, the ADS7822 can be powered at 3V and still accept inputs from logic powered at 5V.

The CMOS digital output ( $D_{OUT}$ ) will swing 0V to  $V_{CC}$ . If  $V_{CC}$  is 3V and this output is connected to a 5V CMOS logic input, then that IC may require more supply current than normal and may have a slightly longer propagation delay.

### Serial Interface

The ADS7822 communicates with microprocessors and other digital systems via a synchronous 3-wire serial interface, as shown in [Figure 22](#) and [Table 1](#). The DCLOCK signal synchronizes the data transfer with each bit being transmitted on the falling edge of DCLOCK. Most receiving systems will capture the bitstream on the rising edge of DCLOCK. However, if the minimum hold time for  $D_{OUT}$  is acceptable, the system can use the falling edge of DCLOCK to capture each bit.

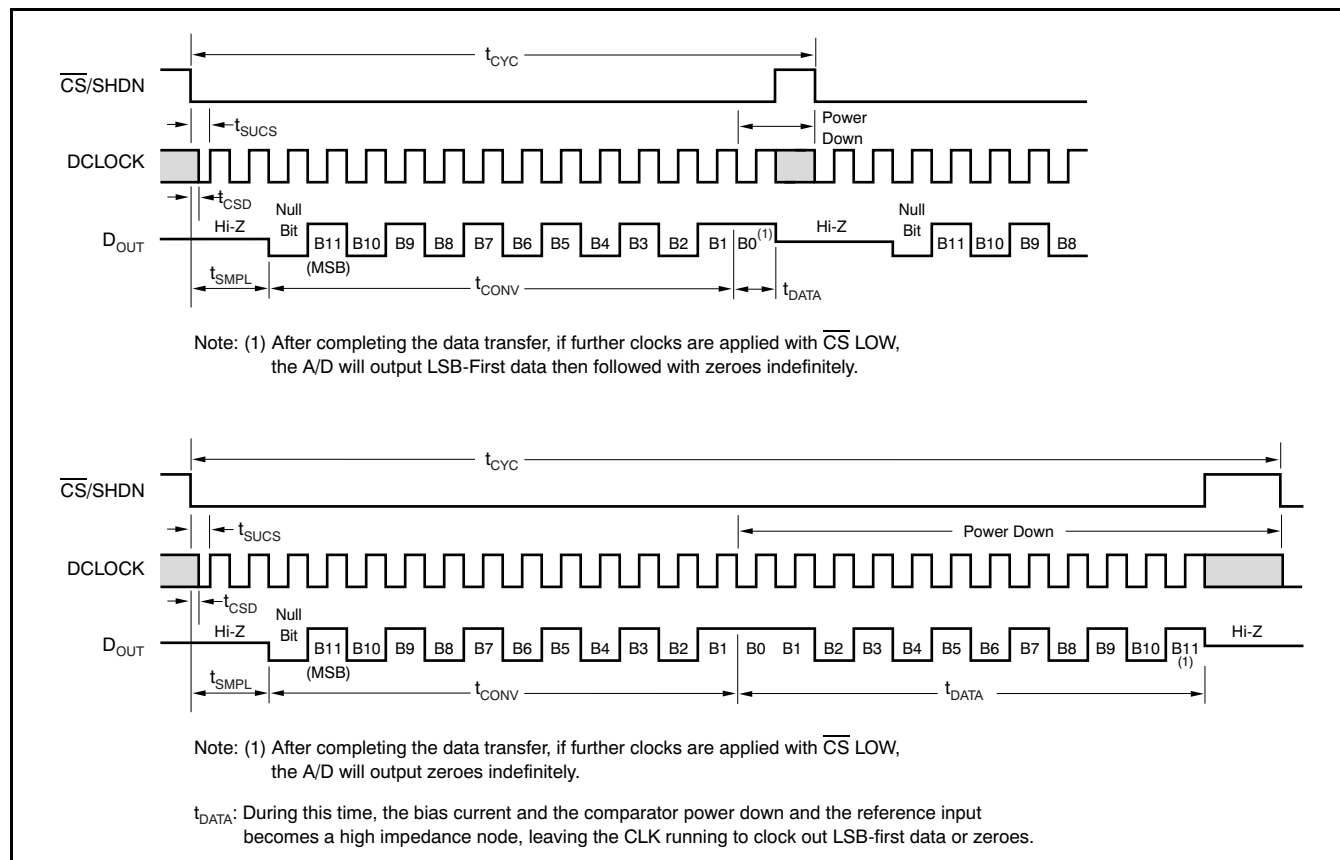
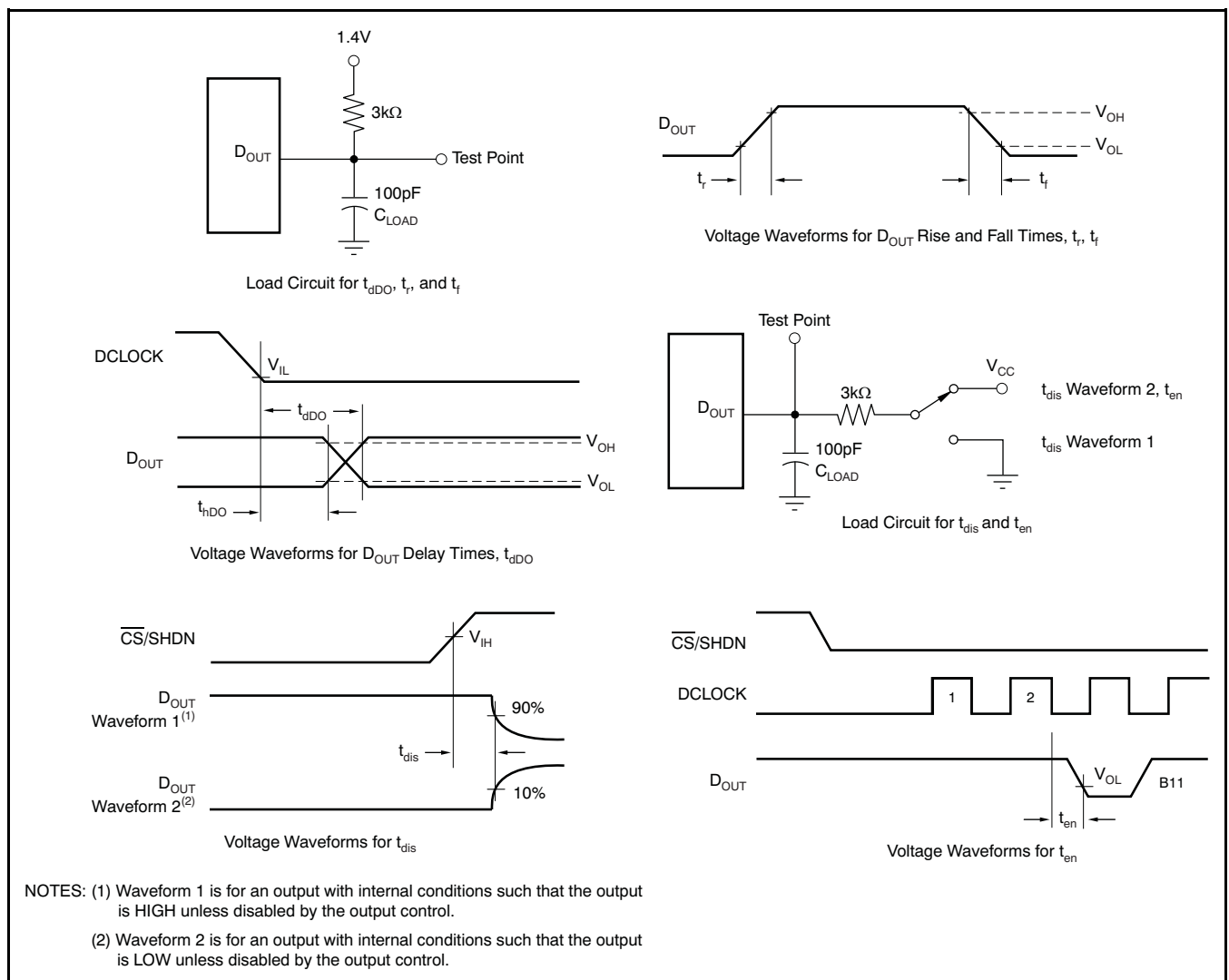


Figure 22. Basic Timing Diagrams

**Table 1. Timing Specifications (–40°C to +85°C)**

SYMBOL	DESCRIPTION	V <sub>CC</sub> = 2.7V			V <sub>CC</sub> = 5V			UNITS
		MIN	TYP	MAX	MIN	TYP	MAX	
t <sub>SMPL</sub>	Analog input sample time	1.5		2.0	1.5		2.0	Clk Cycles
t <sub>CONV</sub>	Conversion time		12			12		Clk Cycles
t <sub>CYC</sub>	Cycle time	16			16			Clk Cycles
t <sub>CSD</sub>	$\overline{CS}$ falling to DCLOCK low			0			0	ns
t <sub>SUCS</sub>	$\overline{CS}$ falling to DCLOCK rising	0.03		1000	0.03		1000	μs
t <sub>hDO</sub>	DCLOCK falling to current D <sub>OUT</sub> not valid	15			15			ns
t <sub>dDO</sub>	DCLOCK falling to next D <sub>OUT</sub> valid		130	200		85	150	ns
t <sub>dis</sub>	$\overline{CS}$ rising to D <sub>OUT</sub> tri-state		40	80		25	50	ns
t <sub>en</sub>	DCLOCK falling to D <sub>OUT</sub> enabled		75	175		50	100	ns
t <sub>f</sub>	D <sub>OUT</sub> fall time		90	200		70	100	ns
t <sub>r</sub>	D <sub>OUT</sub> rise time		110	200		60	100	ns



**Figure 23. Timing Diagrams and Test Circuits for the Parameters in Table 1**

A falling  $\overline{CS}$  signal initiates the conversion and data transfer. The first 1.5 to 2.0 clock periods of the conversion cycle are used to sample the input signal. After the second falling DCLOCK edge,  $D_{OUT}$  is enabled and outputs a low value for one clock period. For the next 12 DCLOCK periods,  $D_{OUT}$  outputs the conversion result, most significant bit first.

After the least significant bit (B0) has been output, subsequent clocks repeat the output data, but in a least significant bit first format. After the most significant bit (B11) has been repeated,  $D_{OUT}$  will tri-state. Subsequent clocks have no effect on the converter. A new conversion is initiated only when  $\overline{CS}$  is taken high and returned low.

**Data Format**

The output data from the ADS7822 is in straight binary format, as shown in Table 2. This table represents the ideal output code for the given input voltage and does not include the effects of offset, gain error, or noise.

**Table 2. Ideal Input Voltages and Output Codes**

DESCRIPTION	ANALOG VALUE	DIGITAL OUTPUT STRAIGHT BINARY	
		BINARY CODE	HEX CODE
Full-Scale range	$V_{REF}$		
Least significant bit (LSB)	$V_{REF}/4096$		
Full-Scale	$V_{REF} - 1 \text{ LSB}$	1111 1111 1111	FFF
Midscale	$V_{REF}/2$	1000 0000 0000	800
Midscale - 1 LSB	$V_{REF}/2 - 1 \text{ LSB}$	0111 1111 1111	7FF
Zero	0V	0000 0000 0000	000

**POWER DISSIPATION**

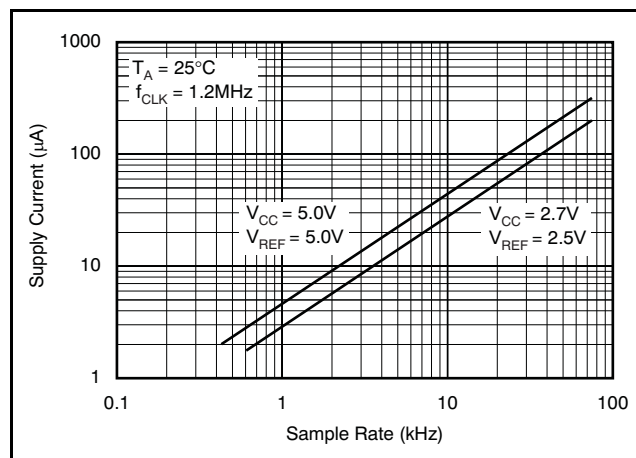
The architecture of the converter, the semiconductor fabrication process, and a careful design allow the ADS7822 to convert at up to a 75kHz rate while requiring very little power. Still, for the absolute lowest power dissipation, there are several things to keep in mind.

The power dissipation of the ADS7822 scales directly with conversion rate. So, the first step to achieving the lowest power dissipation is to find the lowest conversion rate that will satisfy the requirements of the system.

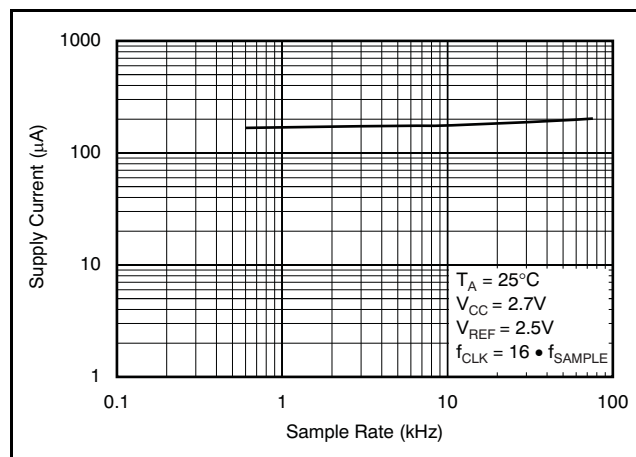
In addition, the ADS7822 goes into power-down mode under two conditions: when the conversion is complete and whenever  $\overline{CS}$  is high (see Figure 22). Ideally, each conversion should occur as quickly as possible; preferably, at a 1.2MHz clock rate. This way, the converter spends the longest possible time in the power-down mode. This is very important since the converter not only uses power on each DCLOCK

transition (as is typical for digital CMOS components), but also uses some current for the analog circuitry, such as the comparator. The analog section dissipates power continuously, until the power-down mode is entered.

Figure 24 shows the current consumption of the ADS7822 versus sample rate. For this graph, the converter is clocked at 1.2MHz regardless of the sample rate— $\overline{CS}$  is high for the remaining sample period. Figure 25 also shows current consumption versus sample rate. However, in this case, the DCLOCK period is 1/16th of the sample period— $\overline{CS}$  is high for one DCLOCK cycle out of every 16.

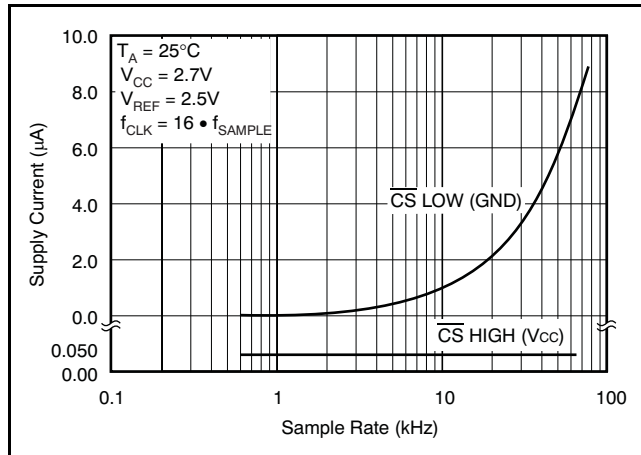


**Figure 24. Maintaining  $f_{CLK}$  at the Highest Possible Rate Allows the Supply Current to Drop Linearly with the Sample Rate**



**Figure 25. Scaling  $f_{CLK}$  Reduces the Supply Current Only Slightly with the Sample Rate**

There is an important distinction between the power-down mode that is entered after a conversion is complete and the full power-down mode that is enabled when  $\overline{CS}$  is high. While both shutdown the analog section, the digital section is completely shutdown only when  $\overline{CS}$  is high. Thus, if  $\overline{CS}$  is left low at the end of a conversion and the converter is continually clocked, the power consumption will not be as low as when  $\overline{CS}$  is high; see Figure 26 for more information.



**Figure 26. Shutdown Current with  $\overline{CS}$  High is Typically 50nA, Regardless of the Clock. Shutdown Current with  $\overline{CS}$  Low varies with Sample Rate.**

Power dissipation can also be reduced by lowering the power-supply voltage and the reference voltage. The ADS7822 operates over a  $V_{CC}$  range of 2.0V to 5.25V. It will run up to a 200kHz throughput rate over a supply range of 4.75V to 5.25V; therefore, it can be clocked at up to 3.2MHz. However, at voltages below 2.7V, the converter does not run at a 75kHz sample rate. See the Typical Characteristic curves for more information regarding power-supply voltage and maximum sample rate.

**Short Cycling**

Another way of saving power is to use the  $\overline{CS}$  signal to short-cycle the conversion. Because the ADS7822 places the latest data bit on the  $D_{OUT}$  line as it is generated, the converter can easily be short-cycled. This term means that the conversion can be terminated at any time. For example, if only eight bits of the conversion result are needed, then the conversion can be terminated (by pulling  $\overline{CS}$  high) after the eighth bit has been clocked out.

This technique can be used to lower the power dissipation (or to increase the conversion rate) in those applications where an analog signal is being monitored until some condition becomes true. For example, if the signal is outside a predetermined range, the full 12-bit conversion result may not be needed. If so, the conversion can be terminated after the first  $n$ -bits, where  $n$  might be as low as 3 or 4. This results in lower power dissipation in both the converter and the rest of the system, because they spend more time in the power-down mode.

## LAYOUT

For optimum performance, care should be taken with the physical layout of the ADS7822 circuitry. This is particularly true if the reference voltage is low and/or the conversion rate is high. At a 75kHz conversion rate, the ADS7822 makes a bit decision every 830ns. If the supply range is limited to 4.75V to 5.25V, then up to a 200kHz conversion rate can be used, which reduces the bit decision time to 312ns. That is, for each subsequent bit decision, the digital output must be updated with the results of the last bit decision, the capacitor array appropriately switched and charged, and the input to the comparator settled to a 12-bit level all within one clock cycle.

The basic SAR architecture is sensitive to spikes on the power supply, reference, and ground connections that occur just prior to latching the comparator output. Thus, during any single conversion for an  $n$ -bit SAR converter, there are  $n$  windows in which large external transient voltages can easily affect the conversion result. Such spikes might originate from switching power supplies, digital logic, and high-power devices, to name a few. This particular source of error can be very difficult to track down if the glitch is almost synchronous to the converter DCLOCK signal because the phase difference between the two changes with time and temperature, causing sporadic misoperation.

With this in mind, power to the ADS7822 should be clean and well-bypassed. A 0.1 $\mu$ F ceramic bypass capacitor should be placed as close to the ADS7822 package as possible. In addition, a 1 $\mu$ F to 10 $\mu$ F capacitor and a 5 $\Omega$  or 10 $\Omega$  series resistor can be used to lowpass filter a noisy supply.

The reference should be similarly bypassed with a 0.1 $\mu$ F capacitor. Again, a series resistor and large capacitor can be used to lowpass filter the reference voltage. If the reference voltage originates from an op amp, be careful that the op amp can drive the bypass capacitor without oscillation (the series resistor can help in this case). Keep in mind that while the ADS7822 draws very little current from the reference on average, there are still instantaneous current demands placed on the external reference circuitry.

Also, keep in mind that the ADS7822 offers no inherent rejection of noise or voltage variation in regards to the reference input. This is of particular concern when the reference input is tied to the power supply. Any noise and ripple from the supply will appear directly in the digital results. While high-frequency noise can be filtered out as described in the previous paragraph, voltage variation due to the line frequency (50Hz or 60Hz), can be difficult to remove.

The GND pin on the ADS7822 should be placed on a clean ground point. In many cases, this will be the analog ground. Avoid connecting the GND pin too close to the grounding point for a microprocessor, microcontroller, or digital signal processor. If needed, run a ground trace directly from the converter to the power-supply connection point. The ideal layout will include an analog ground plane for the converter and associated analog circuitry.

## APPLICATION CIRCUITS

[Figure 27](#) and [Figure 28](#) show some typical application circuits for the ADS7822. [Figure 27](#) uses an ADS7822 and a multiplexer to provide for a flexible data acquisition circuit. A resistor string provides for various voltages at the multiplexer input. The selected voltage is buffered and driven into  $V_{REF}$ . As shown in [Figure 27](#), the input range of the ADS7822 is programmable to 100mV, 200mV, 300mV, or 400mV. The 100mV range would be useful for sensors such as the thermocouple shown.

[Figure 28](#) shows a basic data acquisition system. The ADS7822 input range is 0V to  $V_{CC}$ , as the reference input is connected directly to the power supply. The 5 $\Omega$  resistor and 1 $\mu$ F to 10 $\mu$ F capacitor filter the microcontroller noise on the supply, as well as any high-frequency noise from the supply itself. The exact values should be picked such that the filter provides adequate rejection of the noise.

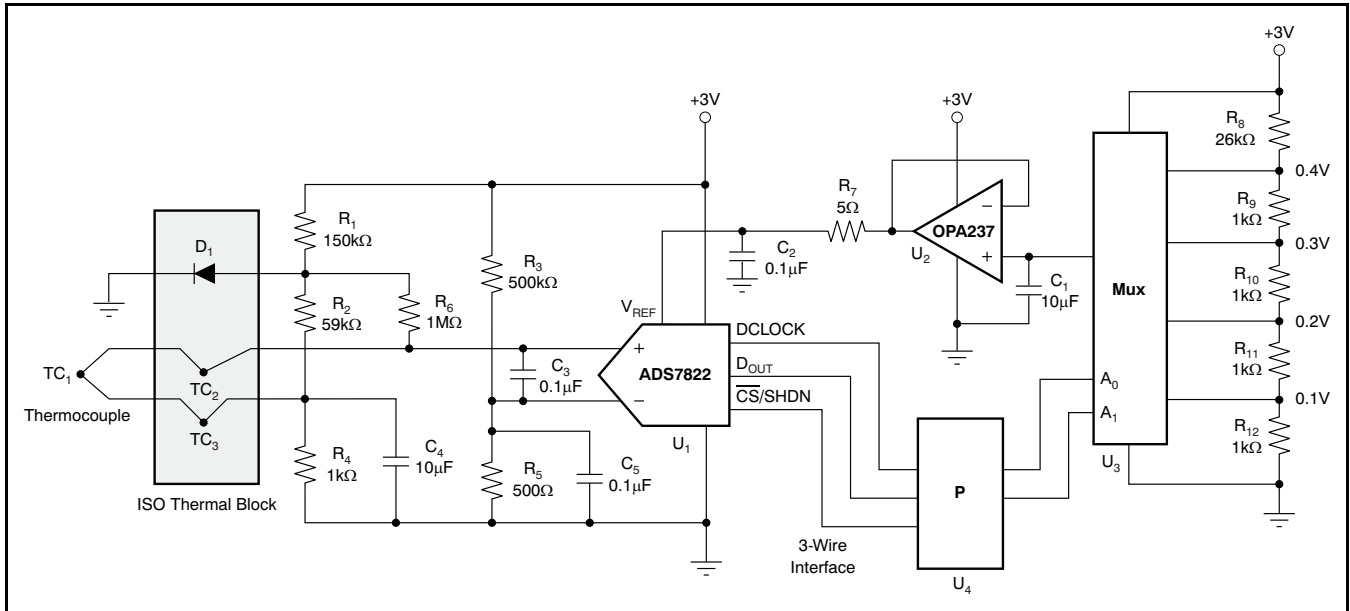


Figure 27. Thermocouple Application Using a Mux to Scale the Input Range of the ADS7822

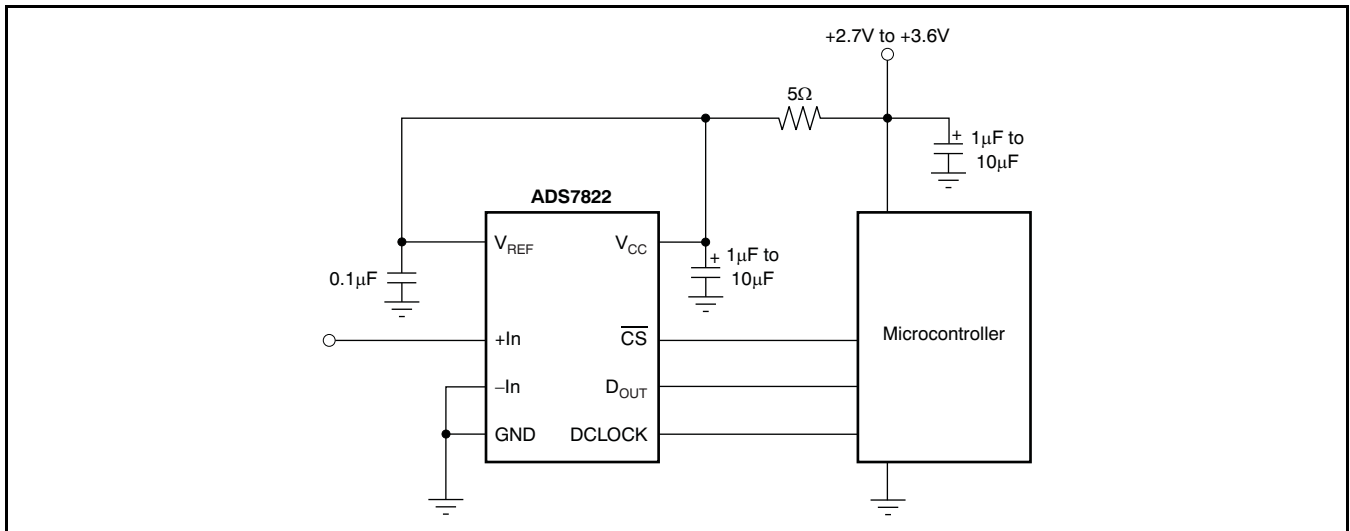


Figure 28. Basic Data Acquisition System

## Revision History

Changes from Revision B (May 2006) to Revision C	Page
• Added – GND to absolute input range test conditions .....	3
• Added – GND to absolute input range test conditions .....	3
• Changed V <sub>CC</sub> min from 3.6 V to 2.7 V .....	3
• Changed V <sub>CC</sub> max from 5.25 V to 3.6 V .....	3
• Changed V <sub>CC</sub> min from 3.6 V to 2.7 V .....	3
• Changed V <sub>CC</sub> max from 5.25 V to 3.6 V .....	3
• Changed V <sub>CC</sub> min from 3.6 V to 2.7 V .....	3
• Changed V <sub>CC</sub> max from 5.25 V to 3.6 V .....	3
• Added – GND to absolute input range test conditions .....	4
• Added – GND to absolute input range test conditions .....	4

**PACKAGING INFORMATION**

Orderable part number	Status (1)	Material type (2)	Package   Pins	Package qty   Carrier	RoHS (3)	Lead finish/ Ball material (4)	MSL rating/ Peak reflow (5)	Op temp (°C)	Part marking (6)
<a href="#">ADS7822E/250</a>	Active	Production	VSSOP (DGK)   8	250   SMALL T&R	Yes	Call TI	Level-2-260C-1 YEAR	-40 to 85	A22
ADS7822E/250.B	Active	Production	VSSOP (DGK)   8	250   SMALL T&R	Yes	Call TI	Level-2-260C-1 YEAR	-40 to 85	A22
ADS7822E/250G4	Active	Production	VSSOP (DGK)   8	250   SMALL T&R	Yes	Call TI	Level-2-260C-1 YEAR	-40 to 85	A22
<a href="#">ADS7822E/2K5</a>	Active	Production	VSSOP (DGK)   8	2500   LARGE T&R	Yes	Call TI	Level-2-260C-1 YEAR	-40 to 85	A22
ADS7822E/2K5.B	Active	Production	VSSOP (DGK)   8	2500   LARGE T&R	Yes	Call TI	Level-2-260C-1 YEAR	-40 to 85	A22
ADS7822E/2K5G4	Active	Production	VSSOP (DGK)   8	2500   LARGE T&R	Yes	Call TI	Level-2-260C-1 YEAR	-40 to 85	A22
<a href="#">ADS7822EB/250</a>	Active	Production	VSSOP (DGK)   8	250   SMALL T&R	Yes	Call TI	Level-2-260C-1 YEAR	-40 to 85	A22
ADS7822EB/250.B	Active	Production	VSSOP (DGK)   8	250   SMALL T&R	Yes	Call TI	Level-2-260C-1 YEAR	-40 to 85	A22
<a href="#">ADS7822EB/2K5</a>	Active	Production	VSSOP (DGK)   8	2500   LARGE T&R	Yes	Call TI	Level-2-260C-1 YEAR	-40 to 85	A22
ADS7822EB/2K5.B	Active	Production	VSSOP (DGK)   8	2500   LARGE T&R	Yes	Call TI	Level-2-260C-1 YEAR	-40 to 85	A22
ADS7822EB/2K5G4	Active	Production	VSSOP (DGK)   8	2500   LARGE T&R	Yes	Call TI	Level-2-260C-1 YEAR	-40 to 85	A22
<a href="#">ADS7822EC/250</a>	Active	Production	VSSOP (DGK)   8	250   SMALL T&R	Yes	Call TI	Level-2-260C-1 YEAR	-40 to 85	A22
ADS7822EC/250.B	Active	Production	VSSOP (DGK)   8	250   SMALL T&R	Yes	Call TI	Level-2-260C-1 YEAR	-40 to 85	A22
<a href="#">ADS7822EC/2K5</a>	Active	Production	VSSOP (DGK)   8	2500   LARGE T&R	Yes	Call TI	Level-2-260C-1 YEAR	-40 to 85	A22
ADS7822EC/2K5.B	Active	Production	VSSOP (DGK)   8	2500   LARGE T&R	Yes	Call TI	Level-2-260C-1 YEAR	-40 to 85	A22
ADS7822EC/2K5G4	Active	Production	VSSOP (DGK)   8	2500   LARGE T&R	Yes	Call TI	Level-2-260C-1 YEAR	-40 to 85	A22
<a href="#">ADS7822U</a>	Active	Production	SOIC (D)   8	75   TUBE	Yes	NIPDAU	Level-2-260C-1 YEAR	-40 to 85	ADS 7822U
ADS7822U.B	Active	Production	SOIC (D)   8	75   TUBE	Yes	NIPDAU	Level-2-260C-1 YEAR	-40 to 85	ADS 7822U
<a href="#">ADS7822U/2K5</a>	Active	Production	SOIC (D)   8	2500   LARGE T&R	Yes	NIPDAU	Level-2-260C-1 YEAR	-40 to 85	ADS 7822U
ADS7822U/2K5.B	Active	Production	SOIC (D)   8	2500   LARGE T&R	Yes	NIPDAU	Level-2-260C-1 YEAR	-40 to 85	ADS 7822U
<a href="#">ADS7822UB</a>	Active	Production	SOIC (D)   8	75   TUBE	Yes	Call TI	Level-2-260C-1 YEAR	-40 to 85	ADS 7822U
ADS7822UB.B	Active	Production	SOIC (D)   8	75   TUBE	Yes	Call TI	Level-2-260C-1 YEAR	-40 to 85	ADS 7822U
<a href="#">ADS7822UB/2K5</a>	Active	Production	SOIC (D)   8	2500   LARGE T&R	Yes	Call TI	Level-2-260C-1 YEAR	-40 to 85	ADS 7822U

Orderable part number	Status (1)	Material type (2)	Package   Pins	Package qty   Carrier	RoHS (3)	Lead finish/ Ball material (4)	MSL rating/ Peak reflow (5)	Op temp (°C)	Part marking (6)
ADS7822UB/2K5.B	Active	Production	SOIC (D)   8	2500   LARGE T&R	Yes	Call TI	Level-2-260C-1 YEAR	-40 to 85	ADS 7822U
ADS7822UBG4	Active	Production	SOIC (D)   8	75   TUBE	Yes	Call TI	Level-2-260C-1 YEAR	-40 to 85	ADS 7822U
<a href="#">ADS7822UC</a>	Active	Production	SOIC (D)   8	75   TUBE	Yes	Call TI	Level-2-260C-1 YEAR	-40 to 85	ADS 7822U
ADS7822UC.B	Active	Production	SOIC (D)   8	75   TUBE	Yes	Call TI	Level-2-260C-1 YEAR	-40 to 85	ADS 7822U
<a href="#">ADS7822UC/2K5</a>	Active	Production	SOIC (D)   8	2500   LARGE T&R	Yes	Call TI	Level-2-260C-1 YEAR	-40 to 85	ADS 7822U
ADS7822UC/2K5.B	Active	Production	SOIC (D)   8	2500   LARGE T&R	Yes	Call TI	Level-2-260C-1 YEAR	-40 to 85	ADS 7822U

<sup>(1)</sup> **Status:** For more details on status, see our [product life cycle](#).

<sup>(2)</sup> **Material type:** When designated, preproduction parts are prototypes/experimental devices, and are not yet approved or released for full production. Testing and final process, including without limitation quality assurance, reliability performance testing, and/or process qualification, may not yet be complete, and this item is subject to further changes or possible discontinuation. If available for ordering, purchases will be subject to an additional waiver at checkout, and are intended for early internal evaluation purposes only. These items are sold without warranties of any kind.

<sup>(3)</sup> **RoHS values:** Yes, No, RoHS Exempt. See the [TI RoHS Statement](#) for additional information and value definition.

<sup>(4)</sup> **Lead finish/Ball material:** Parts may have multiple material finish options. Finish options are separated by a vertical ruled line. Lead finish/Ball material values may wrap to two lines if the finish value exceeds the maximum column width.

<sup>(5)</sup> **MSL rating/Peak reflow:** The moisture sensitivity level ratings and peak solder (reflow) temperatures. In the event that a part has multiple moisture sensitivity ratings, only the lowest level per JEDEC standards is shown. Refer to the shipping label for the actual reflow temperature that will be used to mount the part to the printed circuit board.

<sup>(6)</sup> **Part marking:** There may be an additional marking, which relates to the logo, the lot trace code information, or the environmental category of the part.

Multiple part markings will be inside parentheses. Only one part marking contained in parentheses and separated by a "~" will appear on a part. If a line is indented then it is a continuation of the previous line and the two combined represent the entire part marking for that device.

**Important Information and Disclaimer:** The information provided on this page represents TI's knowledge and belief as of the date that it is provided. TI bases its knowledge and belief on information provided by third parties, and makes no representation or warranty as to the accuracy of such information. Efforts are underway to better integrate information from third parties. TI has taken and continues to take reasonable steps to provide representative

and accurate information but may not have conducted destructive testing or chemical analysis on incoming materials and chemicals. TI and TI suppliers consider certain information to be proprietary, and thus CAS numbers and other limited information may not be available for release.

In no event shall TI's liability arising out of such information exceed the total purchase price of the TI part(s) at issue in this document sold by TI to Customer on an annual basis.

**OTHER QUALIFIED VERSIONS OF ADS7822 :**

- Automotive : [ADS7822-Q1](#)

NOTE: Qualified Version Definitions:

- Automotive - Q100 devices qualified for high-reliability automotive applications targeting zero defects

**TAPE AND REEL INFORMATION**

**QUADRANT ASSIGNMENTS FOR PIN 1 ORIENTATION IN TAPE**


\*All dimensions are nominal

Device	Package Type	Package Drawing	Pins	SPQ	Reel Diameter (mm)	Reel Width W1 (mm)	A0 (mm)	B0 (mm)	K0 (mm)	P1 (mm)	W (mm)	Pin1 Quadrant
ADS7822U/2K5	SOIC	D	8	2500	330.0	12.4	6.4	5.2	2.1	8.0	12.0	Q1
ADS7822U/2K5G4	SOIC	D	8	2500	330.0	12.4	6.4	5.2	2.1	8.0	12.0	Q1
ADS7822UB/2K5	SOIC	D	8	2500	330.0	12.4	6.4	5.2	2.1	8.0	12.0	Q1
ADS7822UC/2K5	SOIC	D	8	2500	330.0	12.4	6.4	5.2	2.1	8.0	12.0	Q1

**TAPE AND REEL BOX DIMENSIONS**


\*All dimensions are nominal

Device	Package Type	Package Drawing	Pins	SPQ	Length (mm)	Width (mm)	Height (mm)
ADS7822U/2K5	SOIC	D	8	2500	353.0	353.0	32.0
ADS7822U/2K5G4	SOIC	D	8	2500	353.0	353.0	32.0
ADS7822UB/2K5	SOIC	D	8	2500	353.0	353.0	32.0
ADS7822UC/2K5	SOIC	D	8	2500	353.0	353.0	32.0

**TUBE**


\*All dimensions are nominal

Device	Package Name	Package Type	Pins	SPQ	L (mm)	W (mm)	T (μm)	B (mm)
ADS7822U	D	SOIC	8	75	506.6	8	3940	4.32
ADS7822U.B	D	SOIC	8	75	506.6	8	3940	4.32
ADS7822UB	D	SOIC	8	75	506.6	8	3940	4.32
ADS7822UB.B	D	SOIC	8	75	506.6	8	3940	4.32
ADS7822UBG4	D	SOIC	8	75	506.6	8	3940	4.32
ADS7822UC	D	SOIC	8	75	506.6	8	3940	4.32
ADS7822UC.B	D	SOIC	8	75	506.6	8	3940	4.32

# DGK0008A



# PACKAGE OUTLINE

VSSOP - 1.1 mm max height

SMALL OUTLINE PACKAGE



4214862/A 04/2023

**NOTES:**

PowerPAD is a trademark of Texas Instruments.

1. All linear dimensions are in millimeters. Any dimensions in parenthesis are for reference only. Dimensioning and tolerancing per ASME Y14.5M.
2. This drawing is subject to change without notice.
3. This dimension does not include mold flash, protrusions, or gate burrs. Mold flash, protrusions, or gate burrs shall not exceed 0.15 mm per side.
4. This dimension does not include interlead flash. Interlead flash shall not exceed 0.25 mm per side.
5. Reference JEDEC registration MO-187.

# EXAMPLE BOARD LAYOUT

DGK0008A

™ VSSOP - 1.1 mm max height

SMALL OUTLINE PACKAGE



LAND PATTERN EXAMPLE  
EXPOSED METAL SHOWN  
SCALE: 15X



SOLDER MASK DETAILS

4214862/A 04/2023

NOTES: (continued)

6. Publication IPC-7351 may have alternate designs.
7. Solder mask tolerances between and around signal pads can vary based on board fabrication site.
8. Vias are optional depending on application, refer to device data sheet. If any vias are implemented, refer to their locations shown on this view. It is recommended that vias under paste be filled, plugged or tented.
9. Size of metal pad may vary due to creepage requirement.

# EXAMPLE STENCIL DESIGN

DGK0008A

<sup>TM</sup> VSSOP - 1.1 mm max height

SMALL OUTLINE PACKAGE



SOLDER PASTE EXAMPLE  
SCALE: 15X

4214862/A 04/2023

NOTES: (continued)

11. Laser cutting apertures with trapezoidal walls and rounded corners may offer better paste release. IPC-7525 may have alternate design recommendations.
12. Board assembly site may have different recommendations for stencil design.



D0008A

# PACKAGE OUTLINE

SOIC - 1.75 mm max height

SMALL OUTLINE INTEGRATED CIRCUIT



4214825/C 02/2019

### NOTES:

- Linear dimensions are in inches [millimeters]. Dimensions in parenthesis are for reference only. Controlling dimensions are in inches. Dimensioning and tolerancing per ASME Y14.5M.
- This drawing is subject to change without notice.
- This dimension does not include mold flash, protrusions, or gate burrs. Mold flash, protrusions, or gate burrs shall not exceed  $.006$  [0.15] per side.
- This dimension does not include interlead flash.
- Reference JEDEC registration MS-012, variation AA.

# EXAMPLE BOARD LAYOUT

D0008A

SOIC - 1.75 mm max height

SMALL OUTLINE INTEGRATED CIRCUIT



LAND PATTERN EXAMPLE  
 EXPOSED METAL SHOWN  
 SCALE:8X



SOLDER MASK DETAILS

4214825/C 02/2019

NOTES: (continued)

- 6. Publication IPC-7351 may have alternate designs.
- 7. Solder mask tolerances between and around signal pads can vary based on board fabrication site.

# EXAMPLE STENCIL DESIGN

D0008A

SOIC - 1.75 mm max height

SMALL OUTLINE INTEGRATED CIRCUIT



SOLDER PASTE EXAMPLE  
BASED ON .005 INCH [0.125 MM] THICK STENCIL  
SCALE:8X

4214825/C 02/2019

NOTES: (continued)

8. Laser cutting apertures with trapezoidal walls and rounded corners may offer better paste release. IPC-7525 may have alternate design recommendations.
9. Board assembly site may have different recommendations for stencil design.

P (R-PDIP-T8)

PLASTIC DUAL-IN-LINE PACKAGE



4040082/E 04/2010

- NOTES:
- A. All linear dimensions are in inches (millimeters).
  - B. This drawing is subject to change without notice.
  - C. Falls within JEDEC MS-001 variation BA.

## IMPORTANT NOTICE AND DISCLAIMER

TI PROVIDES TECHNICAL AND RELIABILITY DATA (INCLUDING DATASHEETS), DESIGN RESOURCES (INCLUDING REFERENCE DESIGNS), APPLICATION OR OTHER DESIGN ADVICE, WEB TOOLS, SAFETY INFORMATION, AND OTHER RESOURCES "AS IS" AND WITH ALL FAULTS, AND DISCLAIMS ALL WARRANTIES, EXPRESS AND IMPLIED, INCLUDING WITHOUT LIMITATION ANY IMPLIED WARRANTIES OF MERCHANTABILITY, FITNESS FOR A PARTICULAR PURPOSE OR NON-INFRINGEMENT OF THIRD PARTY INTELLECTUAL PROPERTY RIGHTS.

These resources are intended for skilled developers designing with TI products. You are solely responsible for (1) selecting the appropriate TI products for your application, (2) designing, validating and testing your application, and (3) ensuring your application meets applicable standards, and any other safety, security, regulatory or other requirements.

These resources are subject to change without notice. TI grants you permission to use these resources only for development of an application that uses the TI products described in the resource. Other reproduction and display of these resources is prohibited. No license is granted to any other TI intellectual property right or to any third party intellectual property right. TI disclaims responsibility for, and you fully indemnify TI and its representatives against any claims, damages, costs, losses, and liabilities arising out of your use of these resources.

TI's products are provided subject to [TI's Terms of Sale](#), [TI's General Quality Guidelines](#), or other applicable terms available either on [ti.com](http://ti.com) or provided in conjunction with such TI products. TI's provision of these resources does not expand or otherwise alter TI's applicable warranties or warranty disclaimers for TI products. Unless TI explicitly designates a product as custom or customer-specified, TI products are standard, catalog, general purpose devices.

TI objects to and rejects any additional or different terms you may propose.

Copyright © 2026, Texas Instruments Incorporated

Last updated 10/2025