

# TPSM8A29 Power Module Evaluation Module User's Guide



## ABSTRACT

The TPSM8A29EVM is designed as a versatile and easy to use evaluation module (EVM) that facilitates the evaluation and performance of the TPSM8A29 power module. This user's guide provides information on how to use the TPSM8A29EVM, and provides an explanation of the featured test points.

## Table of Contents

|  |    |
|--|----|
| <b>1 Introduction</b> .....                                  | 3  |
| <b>2 Description</b> .....                                   | 3  |
| <b>3 Getting Started With the TPSM8A29EVM</b> .....          | 4  |
| 3.1 J1 - Input Voltage Supply Connector.....                 | 5  |
| 3.2 J4 and J7 - Positive and Negative Output Connectors..... | 6  |
| 3.3 J2 - Enable Header.....                                  | 6  |
| 3.4 J5 - Switching Frequency and Operating Mode.....         | 6  |
| 3.5 J6 - Output Voltage Selection Header.....                | 7  |
| <b>4 Test Point Description</b> .....                        | 8  |
| 4.1 TP12 - SS/REF_IN.....                                    | 8  |
| 4.2 TP14 - VCC.....  | 8  |
| <b>5 Test Setup and Results</b> .....                        | 9  |
| 5.1 Startup Procedure.....                                   | 9  |
| 5.2 Efficiency.....  | 9  |
| 5.3 Load Regulation.....                                     | 11 |
| 5.4 Line Regulation.....                                     | 12 |
| 5.5 Output Voltage Ripple.....                               | 12 |
| 5.6 Startup and Shutdown.....                                | 15 |
| 5.7 Load Transient.....                                      | 17 |
| 5.8 Bode Plot.....   | 18 |
| <b>6 TPSM8A29EVM Schematic</b> .....                         | 19 |
| <b>7 TPSM8A29EVM PCB Layers</b> .....                        | 20 |
| <b>8 TPSM8A29EVM Bill of Materials</b> .....                 | 23 |
| <b>9 Revision History</b> .....                              | 26 |

## List of Figures

|  |    |
|--|----|
| Figure 3-1. TPSM8A29EVM 3-D Top View.....  | 4  |
| Figure 3-2. TPSM8A29EVM 3-D Bottom View.....   | 5  |
| Figure 5-1. Efficiency, $V_{OUT} = 0.6\text{ V to }5.0\text{ V}$ .....               | 9  |
| Figure 5-2. Efficiency, $V_{OUT} = 0.6\text{ V and }2.5\text{ V}$ .....              | 9  |
| Figure 5-3. Efficiency, $V_{OUT} = 0.6\text{ V, }2.5\text{ V, and }5\text{ V}$ ..... | 9  |
| Figure 5-4. Efficiency, $V_{OUT} = 0.6\text{ V}$ .....                               | 9  |
| Figure 5-5. Efficiency, $V_{OUT} = 0.8\text{ V}$ .....                               | 10 |
| Figure 5-6. Efficiency, $V_{OUT} = 1.0\text{ V}$ .....                               | 10 |
| Figure 5-7. Efficiency, $V_{OUT} = 1.2\text{ V}$ .....                               | 10 |
| Figure 5-8. Efficiency, $V_{OUT} = 1.8\text{ V}$ .....                               | 10 |
| Figure 5-9. Efficiency, $V_{OUT} = 2.5\text{ V}$ .....                               | 10 |
| Figure 5-10. Efficiency, $V_{OUT} = 3.3\text{ V}$ .....                              | 10 |
| Figure 5-11. Efficiency, $V_{OUT} = 5.0\text{ V}$ .....                              | 10 |
| Figure 5-12. Load Regulation, $V_{OUT} = 0.6\text{ V}$ .....                         | 11 |
| Figure 5-13. Load Regulation, $V_{OUT} = 0.8\text{ V}$ .....                         | 11 |
| Figure 5-14. Load Regulation, $V_{OUT} = 1.0\text{ V}$ .....                         | 11 |

|  |    |
|--|----|
| Figure 5-15. Load Regulation, $V_{OUT} = 1.2\text{ V}$ .....   | 11 |
| Figure 5-16. Load Regulation, $V_{OUT} = 1.8\text{ V}$ .....   | 11 |
| Figure 5-17. Load Regulation, $V_{OUT} = 2.5\text{ V}$ .....   | 11 |
| Figure 5-18. Load Regulation, $V_{OUT} = 3.3\text{ V}$ .....   | 12 |
| Figure 5-19. Load Regulation, $V_{OUT} = 5.0\text{ V}$ .....   | 12 |
| Figure 5-20. Line regulation, $V_{OUT} = 1.0\text{ V}$ .....   | 12 |
| Figure 5-21. Output Ripple, $V_{OUT} = 1.0\text{ V}$ , $V_{RIPPLE} = 6.4\text{ mV}$ .....            | 13 |
| Figure 5-22. Output Ripple, $V_{OUT} = 1.0\text{ V}$ , $V_{RIPPLE} = 7.6\text{ mV}$ .....            | 13 |
| Figure 5-23. Output Ripple, $V_{OUT} = 1.0\text{ V}$ , $V_{RIPPLE} = 20.3\text{ mV}$ .....           | 14 |
| Figure 5-24. Output Ripple, $V_{OUT} = 1.0\text{ V}$ , $V_{RIPPLE} = 10.4\text{ mV}$ .....           | 14 |
| Figure 5-25. Output Ripple, $V_{OUT} = 1.0\text{ V}$ , $V_{RIPPLE} = 8.8\text{ mV}$ .....            | 15 |
| Figure 5-26. Startup Through $V_{IN}$ (enable floating), 0 A load.....                               | 15 |
| Figure 5-27. Startup Through $V_{IN}$ (enable floating), 15 A load.....                              | 16 |
| Figure 5-28. Startup Through Enable, 0 A load.....   | 16 |
| Figure 5-29. Startup Through Enable, 15 A load.....  | 17 |
| Figure 5-30. Startup Through Enable Into Prebiased Output ( $V_{OUT, PREBIAS} = 0.5\text{ V}$ )..... | 17 |
| Figure 5-31. Load Transient, 7.5 A step, 10 $\mu\text{s/div}$ , $V_{TRANS} = 74\text{ mV}$ .....     | 18 |
| Figure 5-32. Bode Plot, $V_{OUT} = 1\text{ V}$ , $I_{OUT} = 15\text{ A}$ .....                       | 18 |
| Figure 6-1. TPSM8A29EVM Schematic.....   | 19 |
| Figure 7-1. TPSM8A29EVM Top Layer Composite View.....  | 20 |
| Figure 7-2. TPSM8A29EVM Bottom Layer Composite View.....   | 20 |
| Figure 7-3. TPSM8A29EVM Top Layer Copper, Top-Down View.....   | 21 |
| Figure 7-4. TPSM8A29EVM Inner Layer 1 Copper, Top-Down View.....                                     | 21 |
| Figure 7-5. TPSM8A29EVM Inner Layer 2 Copper, Top-Down View.....                                     | 22 |
| Figure 7-6. TPSM8A29EVM Bottom Layer Copper, Top-Down View.....                                      | 22 |

## List of Tables

|   |    |
|---|----|
| Table 1-1. TPSM8A29 Operating Conditions.....                 | 3  |
| Table 3-1. Input and Output Connection Descriptions.....      | 5  |
| Table 3-2. Header Descriptions.....                           | 5  |
| Table 3-3. Switching Frequency and Operating Mode Header..... | 7  |
| Table 4-1. Description of Test Points.....                    | 8  |
| Table 8-1. TPSM8A29EVM Bill of Materials.....                 | 23 |

## Trademarks

All trademarks are the property of their respective owners.

## 1 Introduction

The TPSM8A29 is a highly integrated synchronous buck converter module capable of delivering up to 15 A to a load. The TPSM8A29 has an input operating voltage of 4 V to 16 V, and an output voltage of 0.6 V to 5.5 V. The TPSM8A29 features integrated power MOSFETs, an integrated inductor, as well as several integrated capacitors, allowing for a small solution size to minimize the board layout area. By integrating several passive components, the TPSM8A29 module simplifies routing and reduces EMI for fast time-to-market designs.

The TPSM8A29EVM is designed with several test points which allow the user to evaluate the performance of the TPSM8A29 buck converter module. The recommended operating conditions of the TPSM8A29 are given in [Table 1-1](#).

**Table 1-1. TPSM8A29 Operating Conditions**

| Test Point           | Operating Condition   |
|----------------------|---|
| Input voltage range  | 4 V to 16 V without external bias, 2.7 V to 16 V with external bias |
| Output voltage range | 0.6 V to 5.5 V  |
| Output current       | 15 A max  |

## 2 Description

The TPSM8A29EVM is configured for operation with a 4-V to 16-V input voltage. A wide range of output voltages (0.8 V to 5 V) can be configured using the included header (see [Section 3.5](#)). Three different switching frequencies (600 kHz, 800 kHz, 1 MHz), as well as forced-continuous conduction mode (FCCM) or discontinuous conduction mode (DCM) operation are also configured using the included header (see [Section 3.4](#)). Any output voltage from 0.6 V to 5.5 V can be set by using [Equation 3](#) and [Equation 4](#).

Several test points are included to facilitate the measurement and evaluation of device performance. Several other test points can be used to monitor control signals, or to use as external input control signals to the TPSM8A29. See [Section 4](#) for a detailed description of the TPSM8A29EVM test points.

The wide input voltage range, output voltage range, high current output, small solutions size, and flexible operating modes of the TPSM8A29 make the TPSM8A29 an excellent choice for a wide range of markets.

### 3 Getting Started With the TPSM8A29EVM

Figure 3-1 and Figure 3-2 show the user interface of the TPSM8A29EVM. A description of the input and output connections is shown in Table 3-1. A description of the headers is shown in Table 3-2. Further details and considerations are given after the tables.

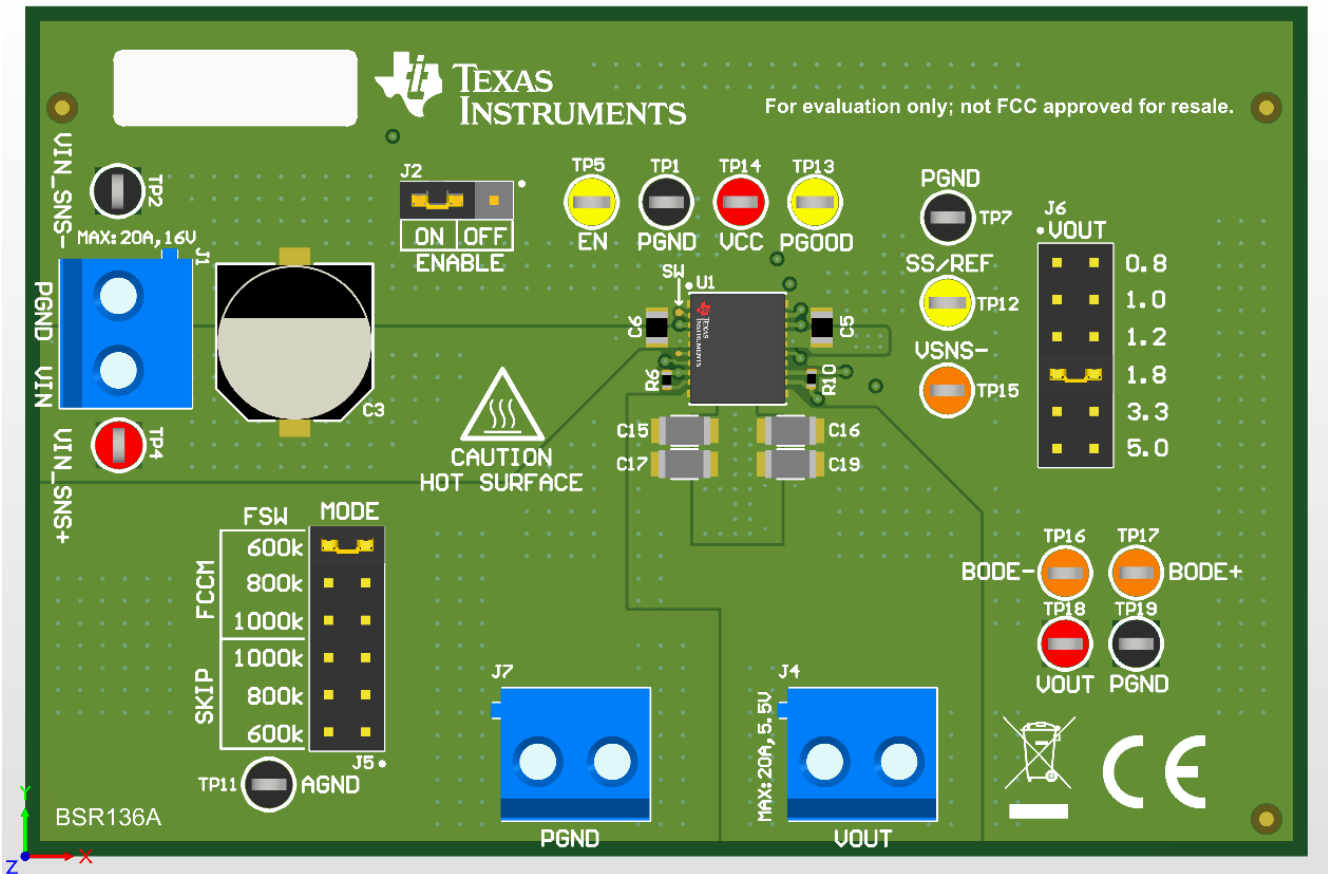

Figure 3-1. TPSM8A29EVM 3-D Top View

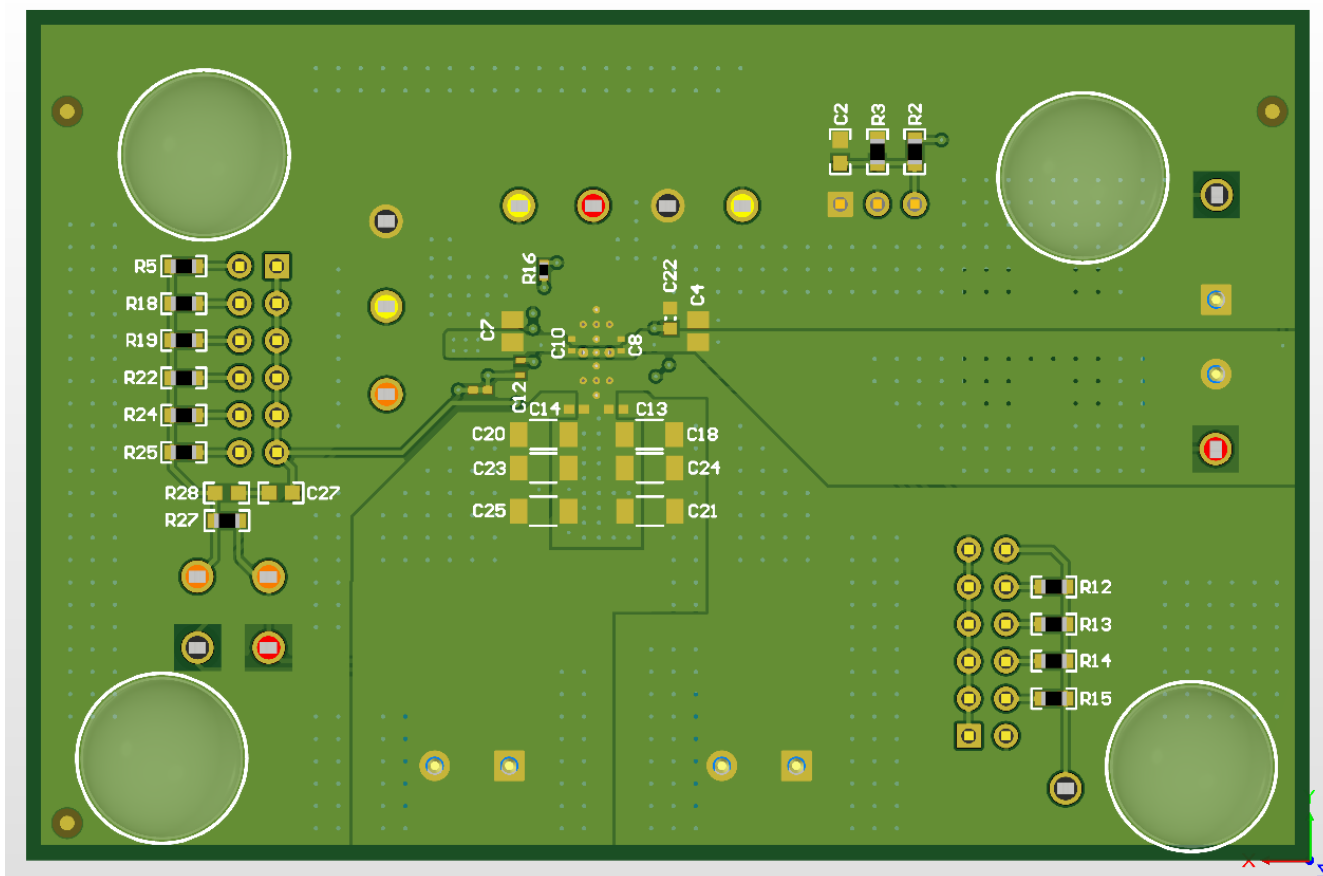

Figure 3-2. TPSM8A29EVM 3-D Bottom View

Table 3-1. Input and Output Connection Descriptions

| Connector | Description   |
|-----------|---|
| J1        | Positive and negative input voltage supply connection, 4 V - 16 V |
| J4        | Positive output voltage connection, 0.8 V - 5 V                   |
| J7        | Negative output voltage connection                                |

Table 3-2. Header Descriptions

| Header | Description   |
|--------|---|
| J2     | Enable header   |
| J5     | Switching frequency and FCCM/DCM operation selection header |
| J6     | Output voltage selection header                             |

### 3.1 J1 - Input Voltage Supply Connector

The connector J1 is used to connect the DC input voltage supply to the EVM. The positive connection of the input supply is connected to J1-1 (J1, pin 1), and the negative connection of the input supply is connected to J1-2. This is indicated by the silkscreen markings on the EVM. This connector is designed to accept a wire size of 14 AWG - 22 AWG. To minimize voltage drops across the input voltage supply cable, wire lengths should be minimized, and a heavier gauge wire should be favored over a lighter gauge. TI recommends using 18 AWG or greater.

For power supplies that support remote sensing, the positive sense point is connected to TP4 (VIN\_SNS+), and the negative sense point is connected to TPS (VIN\_SNS-).

### 3.2 J4 and J7 - Positive and Negative Output Connectors

J4 and J7 are the positive and negative connection points for a load, respectively. Because the expected output current is greater than that of the input current, dedicated connectors are used. For output currents greater than 10 A, it is recommended that both screw terminals of each connector are utilized for connection to the load. This connector is designed to accept a wire size of 14 AWG - 22 AWG. To minimize voltage drops across the output cable, wire lengths should be minimized, and a heavier gauge wire should be favored over a lighter gauge. TI recommends using 16 AWG or greater for connection to a load.

The output voltage can be monitored using the TP18 (VOUT) and TP19 (PGND) test points located on the lower right-hand side of the EVM. These test points are connected across C19 (see [Figure 7-5](#)).

### 3.3 J2 - Enable Header

The TPSM8A29 can be enabled or disabled using the J2 header. A jumper is placed between J2-2 and J2-3 to enable the device, as indicated by the silkscreen on the EVM. Using this configuration, undervoltage lockout (UVLO) can be implemented by adjusting resistors  $R_{EN\_HS}$  (R2) and  $R_{EN\_LS}$  (R3), which form a voltage divider between  $V_{IN}$  and PGND. By default, the EVM is designed to work over the entire input voltage supply range of 4 V to 16 V. To configure the EVM for UVLO, see [Equation 1](#), where  $R_{EN\_HS}$  is the high-side resistor of the UVLO divider (R2),  $V_{START}$  is the desired turn-on voltage,  $V_{ENH}$  is the typical enable pin threshold, and  $V_{EN\_B}$  is the low-side resistor of the UVLO divider (R3).

The TPSM8A29 can also be enabled by floating the enable header. An internal pullup current source enables the device over the entire input voltage supply range. This reduces the BOM count and solution size in applications where UVLO is not required.

To disable the device, a jumper is placed in the OFF position between J2-1 and J2-2, as indicated by the silkscreen on the EVM. This shorts the EN pin of the TPSM8A29 to PGND, disabling the device.

Note that if the EN pin is to be controlled by an external source, the J2 header should be left floating, and the control source should be connected to the EN test point (TP5). The maximum recommended voltage on the EN pin is 5.5 V.

$$R_{ENHS} = \frac{R_{ENLS} \times V_{start}}{V_{ENH}} - R_{ENLS} \quad (1)$$

$$R_{ENHS} = \frac{10 \text{ k}\Omega \times 3.7 \text{ V}}{1.22 \text{ V}} - 10 \text{ k}\Omega = 20 \text{ k}\Omega \quad (2)$$

### 3.4 J5 - Switching Frequency and Operating Mode

A jumper on the J5 header configures both the switching frequency and operating mode of the TPSM8A29 with a single resistor as described in [Table 3-3](#). The dual functionality of the TPSM8A29 MODE pin reduces BOM count and solution size.

Three switching frequencies (600 kHz, 800 kHz, 1 MHz) allow the user to optimize the tradeoff between efficiency and layout area. Because the TPSM8A29 has a fixed integrated inductor, the designer only needs to choose an appropriate output capacitance to meet their output voltage ripple and transient response requirements.

The TPSM8A29 can operate in either FCCM or auto-skip DCM mode. When operating in FCCM, the switching frequency is fixed for all output load current conditions. Operating in this mode yields the best output voltage ripple and load regulation at low load currents at the expense of reduced light-load efficiency. When operating in auto-skip DCM, the switching frequency is reduced to maintain high efficiency, even for light load conditions. The disadvantage to operating in DCM is that the light-load output ripple may be greater than in FCCM, the load regulation may be slightly reduced, and the non-fixed switching frequency at light loads may not be desirable for some applications requiring low system noise.

**Table 3-3. Switching Frequency and Operating Mode Header**

| J5 Jumper Connection | MODE Pin Connection Description | Switching Frequency (kHz) | Operating Mode |
|----------------------|---------------------------------|---------------------------|----------------|
| Pins 1 and 2         | Shorted to VCC                  | 600                       | Auto-skip DCM  |
| Pins 3 and 4         | AGND through 243 kΩ             | 800                       |                |
| Pins 5 and 6         | AGND through 121 kΩ             | 1000                      |                |
| Pins 7 and 8         | AGND through 60.4 kΩ            | 1000                      | FCCM           |
| Pins 9 and 10        | AGND through 30.1 kΩ            | 800                       |                |
| Pins 11 and 12       | Shorted to AGND                 | 600                       |                |

### 3.5 J6 - Output Voltage Selection Header

A jumper on the J6 header is used to configure a range of output voltage from 0.8 V to 5 V. Note that while the default maximum output voltage of the EVM is 5 V, the minimum and maximum output voltage can be increased to 0.6 V and 5.5 V, respectively, by changing one of the high-side feedback resistors.

The output voltage is configured with a voltage divider between  $V_{OUT}$  and PGND, where the midpoint is connected to the FB pin of the TPSM8A29. On this EVM, the low-side feedback resistor ( $R_{FB\_LS}$ , R10) is fixed by default at 10 kΩ, and the jumper on J6 changes the high-side feedback resistor ( $R_{FB\_HS}$ , see [Figure 6-1](#)). To calculate the high-side feedback resistor for any valid output voltage (0.6 V to 5.5 V) for this EVM, [Equation 3](#) is used, where  $R_{FB\_HS}$  is the high-side resistor of the output voltage divider (several options for this EVM, see [Figure 6-1](#)),  $V_{OUT}$  is the desired output voltage,  $V_{INTREF}$  is the internal reference voltage (typical 0.6 V), and  $R_{FB\_LS}$  is the low-side resistor of the output voltage divider (R10). For high DC accuracy, 1% or better resistors should be used with a temperature coefficient of  $\pm 100$  ppm/°C or lower.

$$R_{FBHS} = \frac{V_{OUT} - V_{INTREF}}{V_{INTREF}} \times R_{FBLS} \quad (3)$$

$$R_{FBHS} = \frac{V_{OUT} - 0.6V}{0.6V} \times 10 \text{ k}\Omega \quad (4)$$

## 4 Test Point Description

This section explains the test points found on the TPSM8A29EVM, as well as how to use them. Test points that may benefit from further explanation are addressed after [Table 4-1](#).

**Table 4-1. Description of Test Points**

| Test Point | Function    | Description  |
|------------|-------------|--|
| TP1        | PGND        | Connection to PGND   |
| TP2        | VIN_SNS-    | Negative side of input voltage sensing point, connected to PGND  |
| TP4        | VIN_SNS+    | Positive side of input voltage sensing point, connected to V <sub>IN</sub>   |
| TP5        | EN          | Enable pin of TPSM8A29 - can be used to monitor the EN voltage, or can be used to connect external EN signal, max 5.5 V. See <a href="#">Section 3.3</a> |
| TP7        | PGND        | Connection to PGND   |
| TP11       | AGND        | Connection to AGND - reference point for TRIP and MODE resistors. AGND connected to PGND through single point, NT1, on bottom of EVM                     |
| TP12       | SS/REF_IN   | Soft-start and reference voltage tracking, max 1.5 V. See <a href="#">Section 4.1</a>  |
| TP13       | PGOOD       | Open-drain power good status signal. Pulled up to VCC when voltage on FB pin is within limits of correct operation                                       |
| TP14       | VCC         | Monitor internal LDO voltage or override internal LDO with external bias for improved efficiency. See <a href="#">Section 4.2</a>                        |
| TP15       | VSNS-       | Negative return signal for remote sensing applications, connected to PGND through cuttable jumper net tie NT1 by default.                                |
| TP16       | BODE-/VSNS+ | Negative connection point for Bode measurements, connected to V <sub>OUT</sub>   |
| TP17       | BODE+       | Positive connection point for Bode measurements  |
| TP18       | VOUT_SNS+   | Positive sense point for V <sub>OUT</sub> measurements. Do not use to connect to load  |
| TP19       | VOUT_SNS-   | Negative sense point for V <sub>OUT</sub> measurements. Do not use to connect to load  |
| TP21       | PGND        | Connection to PGND   |

### 4.1 TP12 - SS/REF\_IN

TP12 is connected to the SS/REF\_IN pin of the TPSM8A29. Connecting a capacitor to this pin increases the soft-start time of the converter, as described by [Equation 5](#), where C<sub>SS</sub> is the calculated external soft-start capacitor, in nF, t<sub>SS</sub> is the desired soft-start time, in ms, 36 has units of μA, and V<sub>INTREF</sub> is the internal 0.6 V reference voltage. If no soft-start capacitor is used, the minimum internal soft-start time of 1.5 ms typical is used. By default, a soft-start capacitor is not populated on the EVM, though a footprint for one exists on the bottom of the PCB (C12). The maximum recommended soft-start capacitor is 1 μF.

$$C_{SS}(nF) = \frac{t_{SS}(ms) \times 36 (\mu A)}{V_{INTREF}(V)} \quad (5)$$

The SS/REF\_IN pin can also be used to connect an external bias supply to adjust the control loop voltage reference. The FB pin tracks the voltage on the SS/VREF\_IN pin. This can be useful in applications where the output voltage needs to be adjusted dynamically in-circuit. The maximum recommended external supply voltage to the SS/REF\_IN pin is 1.5 V.

### 4.2 TP14 - VCC

TP14 is the VCC test point for the internal LDO. It can be used to monitor the VCC voltage, or it can be used to override the internal LDO of the TPSM8A29 for higher efficiency. Frequently, systems will have an LDO present somewhere in the design which can be used here to reduce the power losses associated with producing a low-noise supply rail with a linear regulator. The internal LDO produces a typical voltage of 4.5 V, so the recommended input range for an external bias on the VCC pin is 4.75 V to 5.3 V. Because of the limited sourcing current capability of the internal LDO, do not connect any external loading to this pin.



## 5 Test Setup and Results

This section describes how to properly connect, set up, and use the TPSM8A29EVM. This section also includes test results typical for the evaluation module and covers efficiency, load regulation, line regulation, output voltage ripple, startup and shutdown waveforms, transient response, and frequency response.

### 5.1 Startup Procedure

1. Make sure EN jumper is in the ON position.
2. (Optional) Apply appropriate external bias voltage between VCC (TP14) and PGND test points. If no external bias, please go directly to next step. The external bias range is 4.7 V to 5.3 V.
3. Select desired output voltage using J6 header.
4. Select desired operating mode and frequency using J5 header.
5. Connect input power supply positive and negative to J1 VIN and PGND, respectively. If used, connect power supply remote sense connections to VIN\_SNS+ and VIN\_SNS- test points. The input voltage range is 4 V to 16 V.
6. Connect external load to J4 VOUT and J7 PGND. The output voltage can be monitored using TP18 and TP19.
7. Turn on input power supply.

### 5.2 Efficiency

This section presents efficiency data for several conditions. Unless stated otherwise, all measurements were taken at an ambient temperature of 25°C.

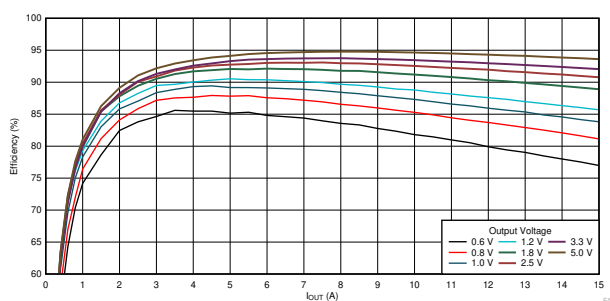

$V_{IN} = 12\text{ V}$   $f_{sw} = 600\text{ kHz}$  Internal bias FCCM

**Figure 5-1. Efficiency,  $V_{OUT} = 0.6\text{ V}$  to  $5.0\text{ V}$**

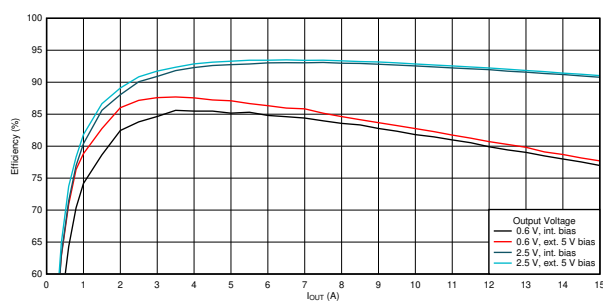

$V_{IN} = 12\text{ V}$   $f_{sw} = 600\text{ kHz}$  Int. vs. ext. 5 V bias FCCM

**Figure 5-2. Efficiency,  $V_{OUT} = 0.6\text{ V}$  and  $2.5\text{ V}$**

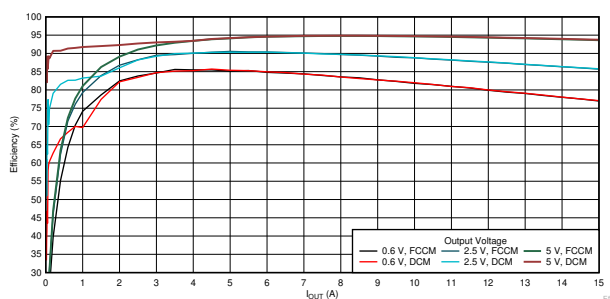

$V_{IN} = 12\text{ V}$   $f_{sw} = 600\text{ kHz}$  Internal bias FCCM vs. DCM

**Figure 5-3. Efficiency,  $V_{OUT} = 0.6\text{ V}$ ,  $2.5\text{ V}$ , and  $5\text{ V}$**

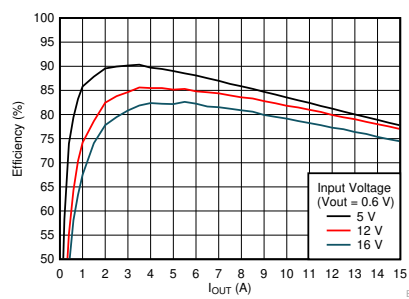

$V_{IN} = 12\text{ V}$   $f_{sw} = 600\text{ kHz}$  Internal bias FCCM

**Figure 5-4. Efficiency,  $V_{OUT} = 0.6\text{ V}$**

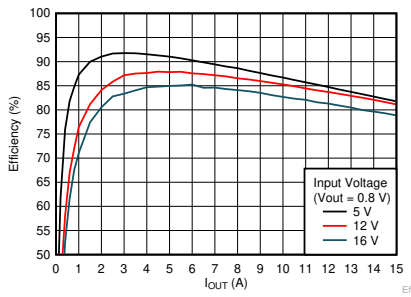

$V_{IN} = 12\text{ V}$   $f_{sw} = 600\text{ kHz}$  Internal bias FCCM

**Figure 5-5. Efficiency,  $V_{OUT} = 0.8\text{ V}$**

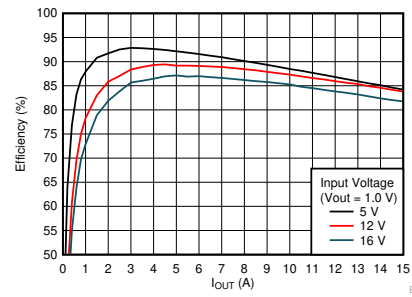

$V_{IN} = 12\text{ V}$   $f_{sw} = 600\text{ kHz}$  Internal bias FCCM

**Figure 5-6. Efficiency,  $V_{OUT} = 1.0\text{ V}$**

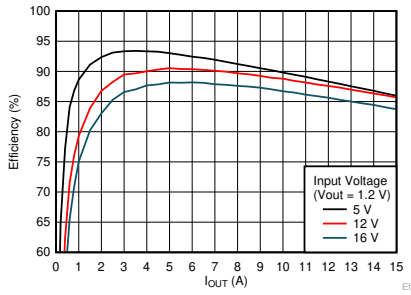

$V_{IN} = 12\text{ V}$   $f_{sw} = 600\text{ kHz}$  Internal bias FCCM

**Figure 5-7. Efficiency,  $V_{OUT} = 1.2\text{ V}$**

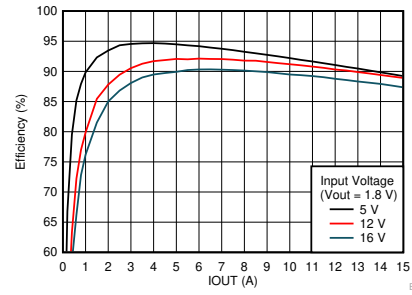

$V_{IN} = 12\text{ V}$   $f_{sw} = 600\text{ kHz}$  Internal bias FCCM

**Figure 5-8. Efficiency,  $V_{OUT} = 1.8\text{ V}$**

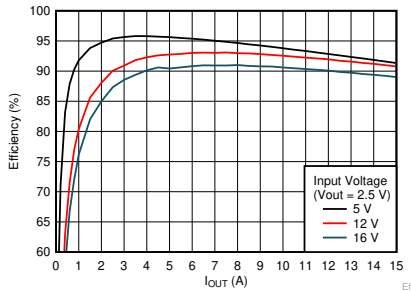

$V_{IN} = 12\text{ V}$   $f_{sw} = 600\text{ kHz}$  Internal bias FCCM

**Figure 5-9. Efficiency,  $V_{OUT} = 2.5\text{ V}$**

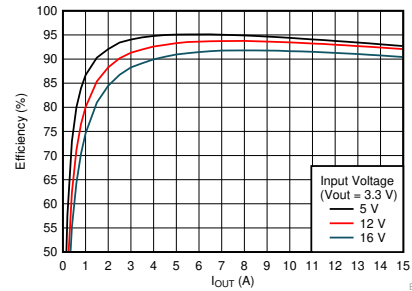

$V_{IN} = 12\text{ V}$   $f_{sw} = 600\text{ kHz}$  Internal bias FCCM

**Figure 5-10. Efficiency,  $V_{OUT} = 3.3\text{ V}$**

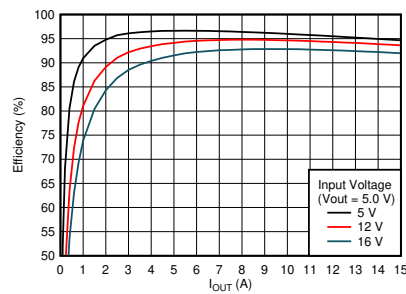

$V_{IN} = 12\text{ V}$

$f_{sw} = 600\text{ kHz}$

Internal bias

FCCM

**Figure 5-11. Efficiency,  $V_{OUT} = 5.0\text{ V}$**

### 5.3 Load Regulation

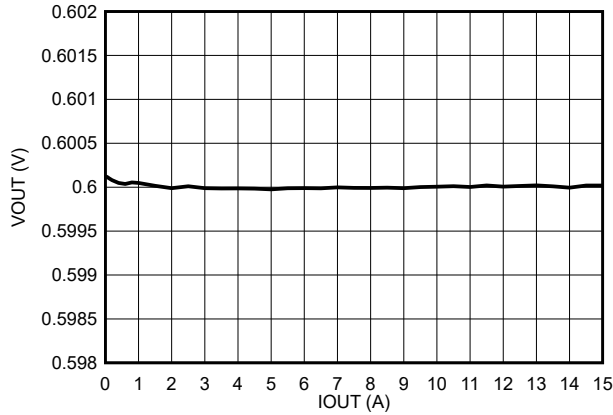

V<sub>IN</sub> = 12 V f<sub>sw</sub> = 600 kHz Internal bias FCCM

**Figure 5-12. Load Regulation, V<sub>OUT</sub> = 0.6 V**

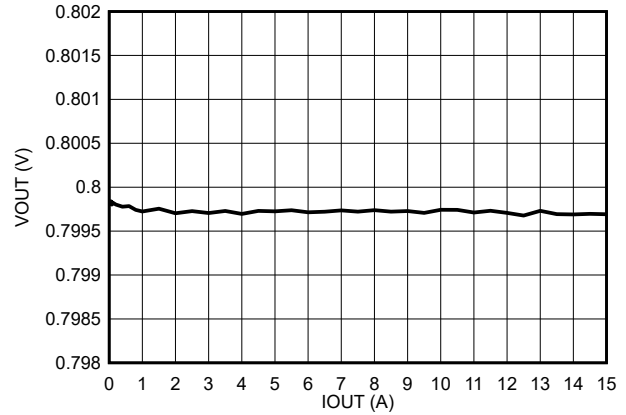

V<sub>IN</sub> = 12 V f<sub>sw</sub> = 600 kHz Internal bias FCCM

**Figure 5-13. Load Regulation, V<sub>OUT</sub> = 0.8 V**

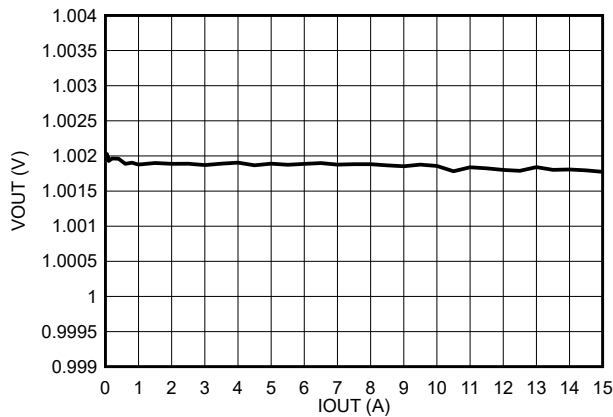

V<sub>IN</sub> = 12 V f<sub>sw</sub> = 600 kHz Internal bias FCCM

**Figure 5-14. Load Regulation, V<sub>OUT</sub> = 1.0 V**

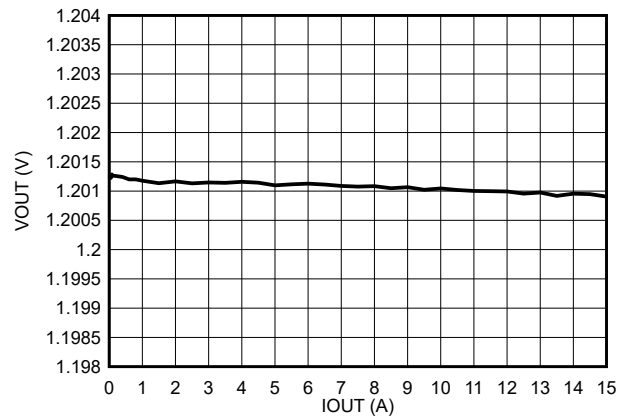

V<sub>IN</sub> = 12 V f<sub>sw</sub> = 600 kHz Internal bias FCCM

**Figure 5-15. Load Regulation, V<sub>OUT</sub> = 1.2 V**

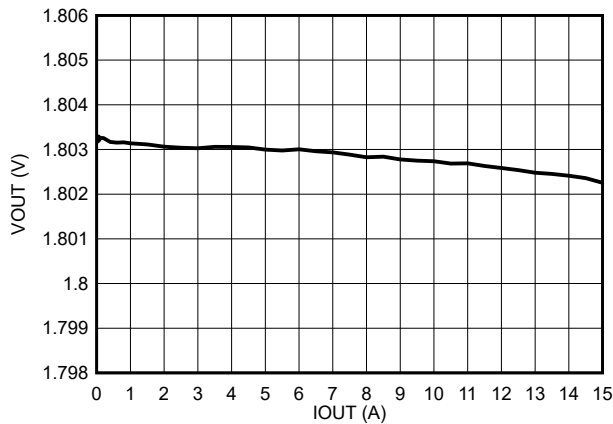

V<sub>IN</sub> = 12 V f<sub>sw</sub> = 600 kHz Internal bias FCCM

**Figure 5-16. Load Regulation, V<sub>OUT</sub> = 1.8 V**

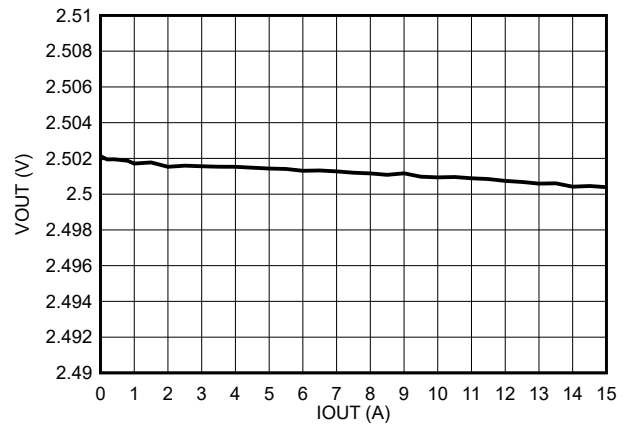

V<sub>IN</sub> = 12 V f<sub>sw</sub> = 600 kHz Internal bias FCCM

**Figure 5-17. Load Regulation, V<sub>OUT</sub> = 2.5 V**

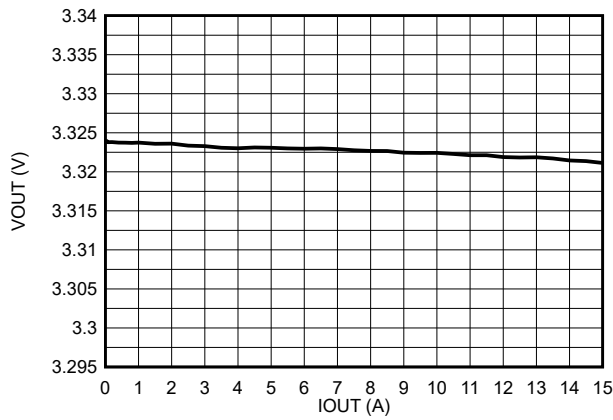

V<sub>IN</sub> = 12 V f<sub>sw</sub> = 600 kHz Internal bias FCCM

**Figure 5-18. Load Regulation, V<sub>OUT</sub> = 3.3V**

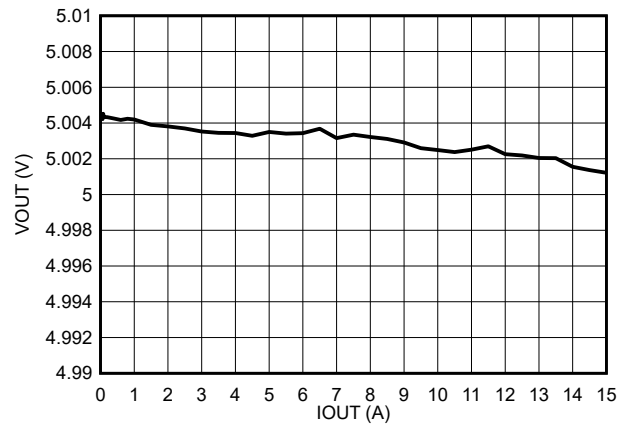

V<sub>IN</sub> = 12 V f<sub>sw</sub> = 600 kHz Internal bias FCCM

**Figure 5-19. Load Regulation, V<sub>OUT</sub> = 5.0 V**

### 5.4 Line Regulation

V<sub>IN</sub> = 12 V, V<sub>OUT</sub> = 1.0 V, C<sub>OUT</sub> = 8x47 μF (6)

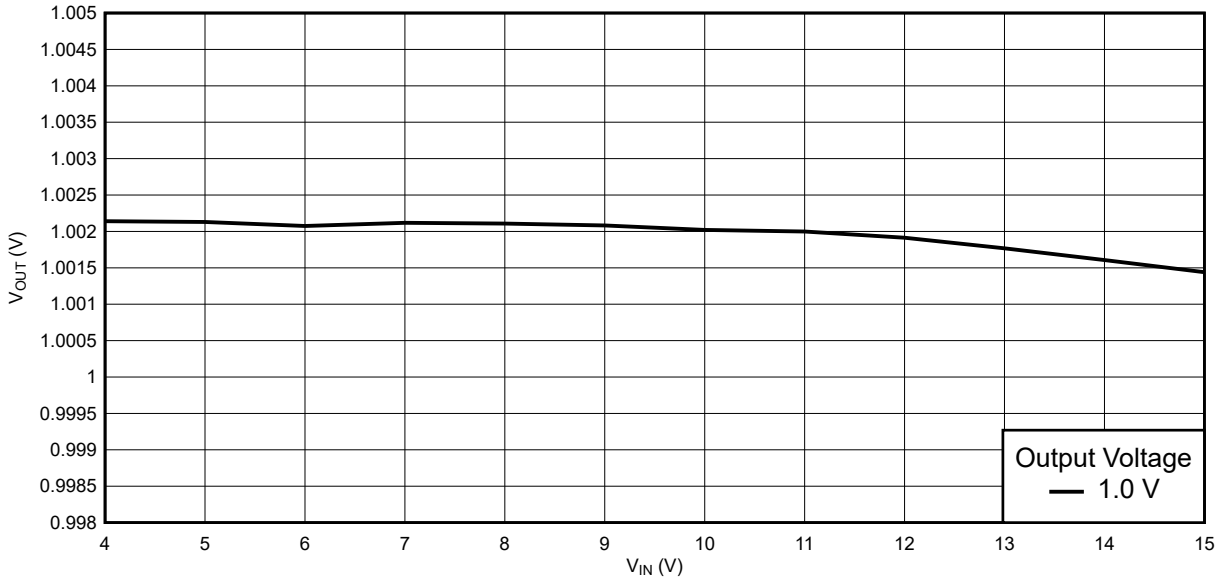

V<sub>IN</sub> = 12 V I<sub>OUT</sub> = 5 A f<sub>sw</sub> = 600 kHz Internal bias FCCM

**Figure 5-20. Line regulation, V<sub>OUT</sub> = 1.0 V**

### 5.5 Output Voltage Ripple

This section contains oscilloscope images showing the output voltage ripple under various load and FCCM/DCM conditions. All images taken at 25°C.

V<sub>IN</sub> = 12 V, V<sub>OUT</sub> = 1.0 V, C<sub>OUT</sub> = 8x47 μF (7)

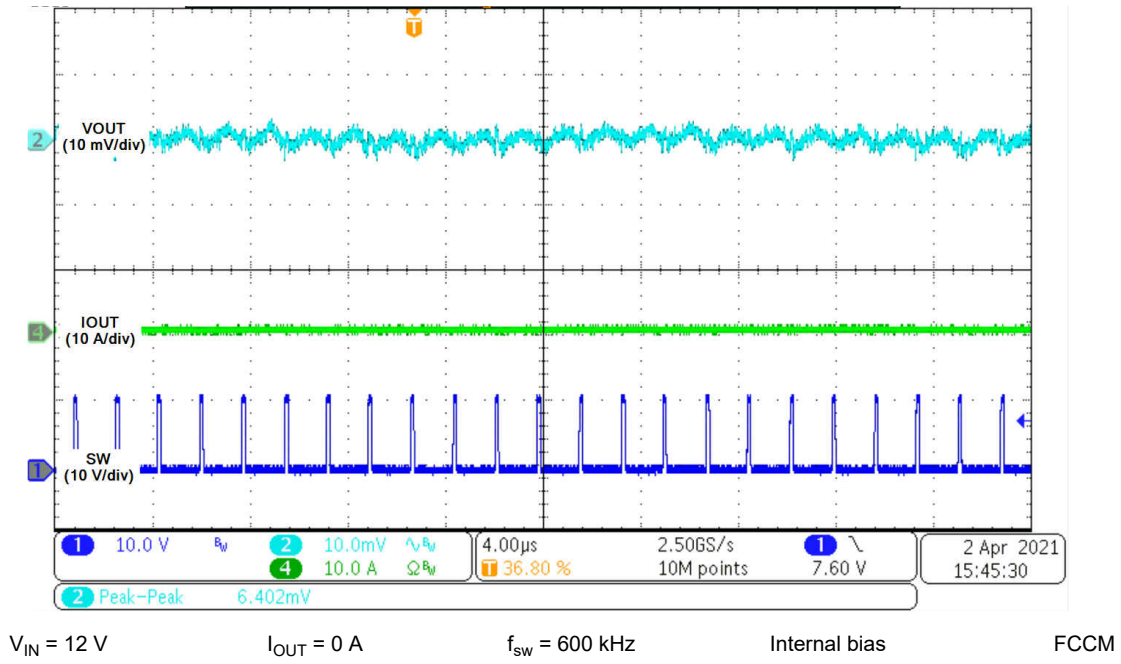

Figure 5-21. Output Ripple,  $V_{OUT} = 1.0\text{ V}$ ,  $V_{RIPPLE} = 6.4\text{ mV}$

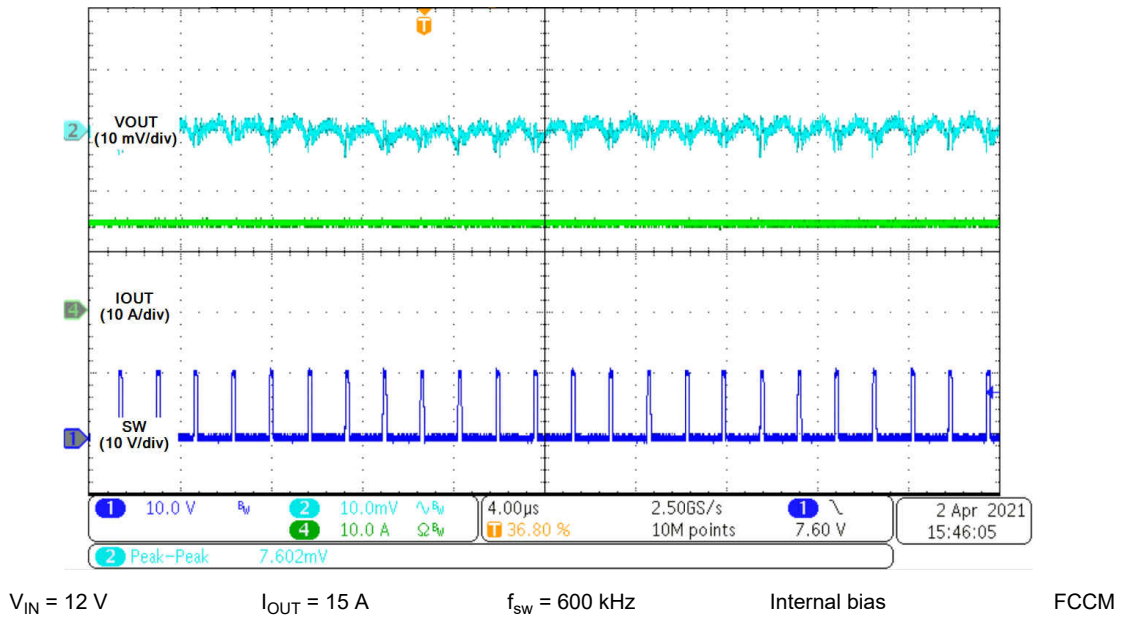

Figure 5-22. Output Ripple,  $V_{OUT} = 1.0\text{ V}$ ,  $V_{RIPPLE} = 7.6\text{ mV}$

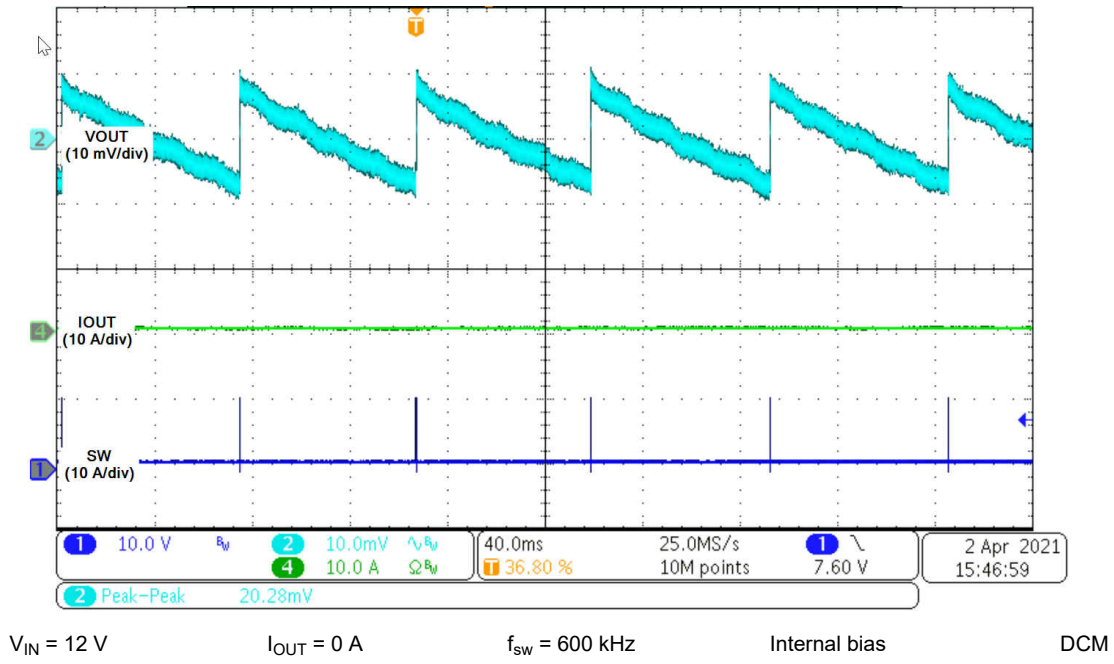

Figure 5-23. Output Ripple,  $V_{OUT} = 1.0\text{ V}$ ,  $V_{RIPPLE} = 20.3\text{ mV}$

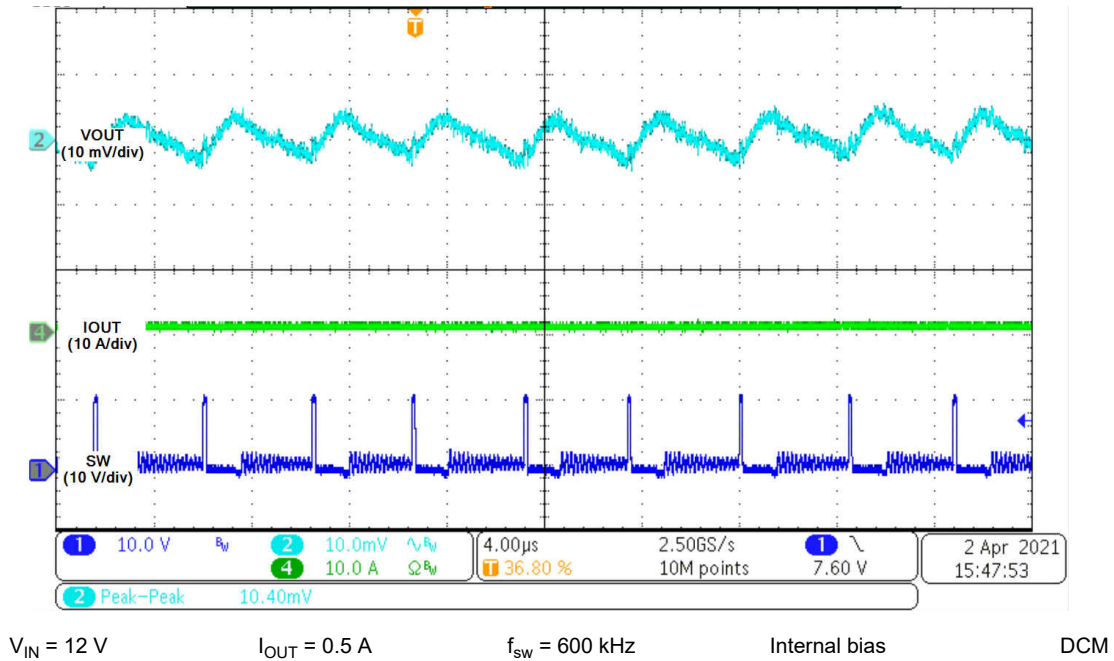

Figure 5-24. Output Ripple,  $V_{OUT} = 1.0\text{ V}$ ,  $V_{RIPPLE} = 10.4\text{ mV}$

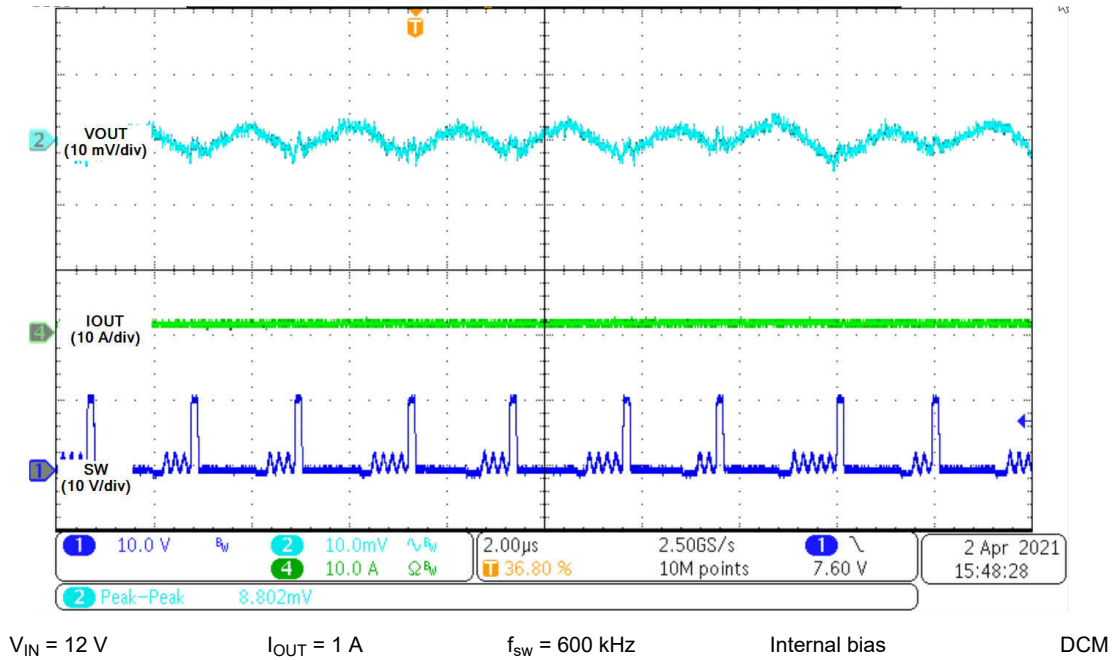

Figure 5-25. Output Ripple,  $V_{OUT} = 1.0\text{ V}$ ,  $V_{RIPPLE} = 8.8\text{ mV}$

### 5.6 Startup and Shutdown

This section contains oscilloscope images showing the startup and shutdown behavior of the TPSM8A29 under different load conditions. All images were taken at 25°C.

$V_{IN} = 12\text{ V}$ ,  $V_{OUT} = 1.0\text{ V}$ ,  $C_{OUT} = 8 \times 47\text{ }\mu\text{F}$  (8)

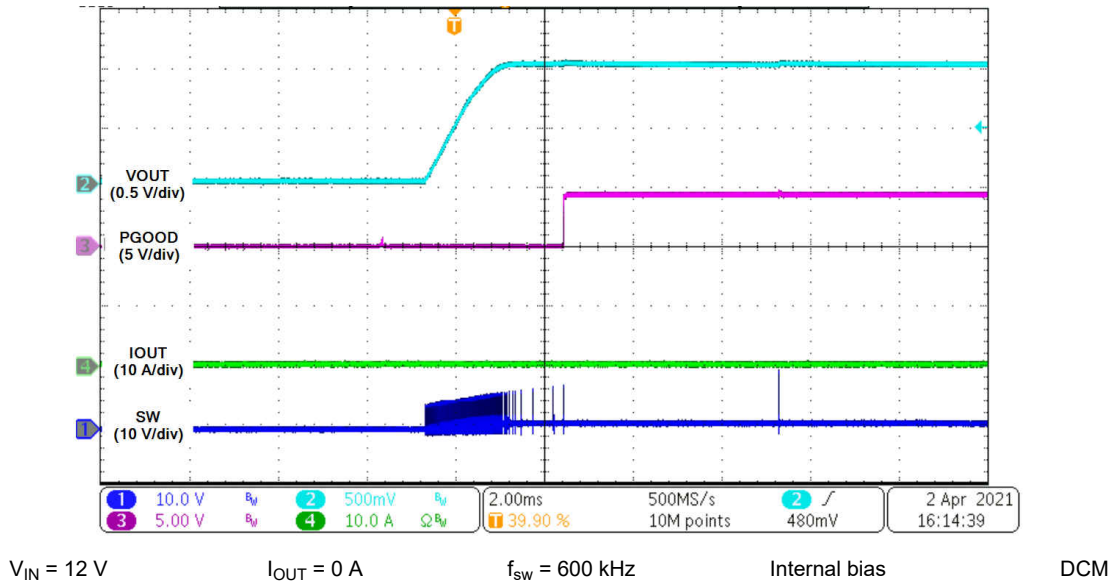

Figure 5-26. Startup Through  $V_{IN}$  (enable floating), 0 A load

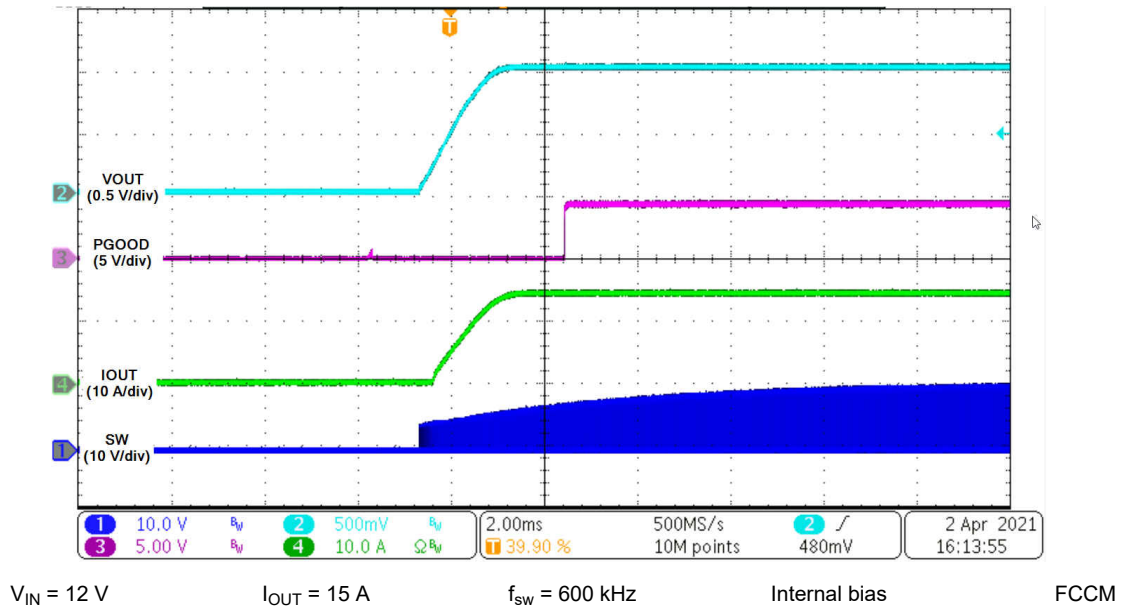

Figure 5-27. Startup Through  $V_{IN}$  (enable floating), 15 A load

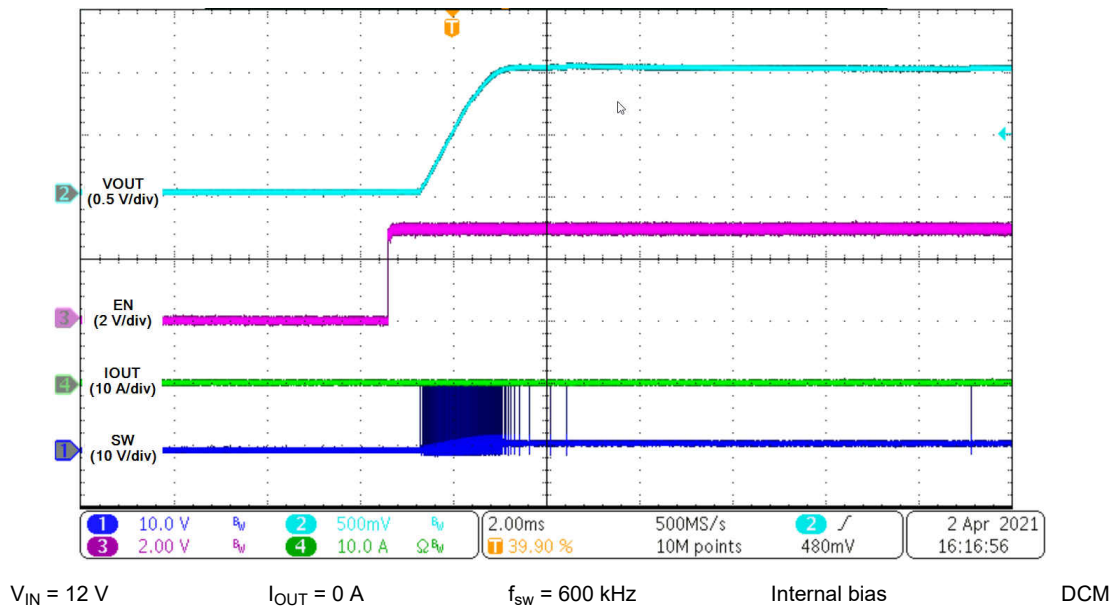

Figure 5-28. Startup Through Enable, 0 A load



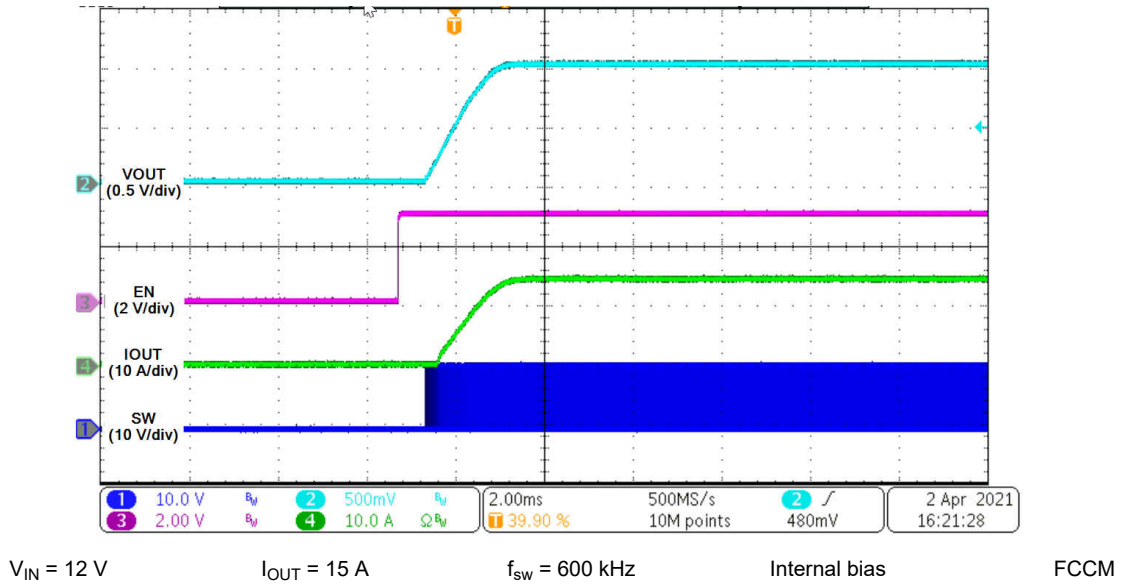

Figure 5-29. Startup Through Enable, 15 A load

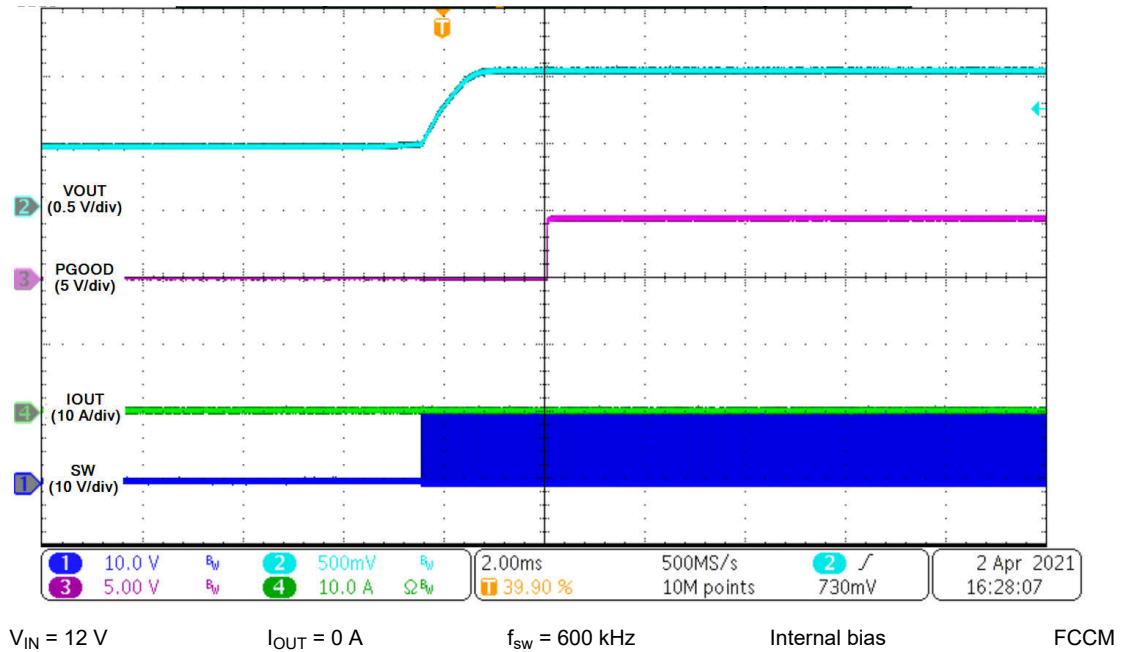

Figure 5-30. Startup Through Enable Into Prebiased Output ( $V_{OUT, PREBIAS} = 0.5\text{ V}$ )

### 5.7 Load Transient

$V_{IN} = 12\text{ V}$ ,  $V_{OUT} = 1.0\text{ V}$ ,  $C_{OUT} = 8 \times 47\text{ }\mu\text{F}$

(9)

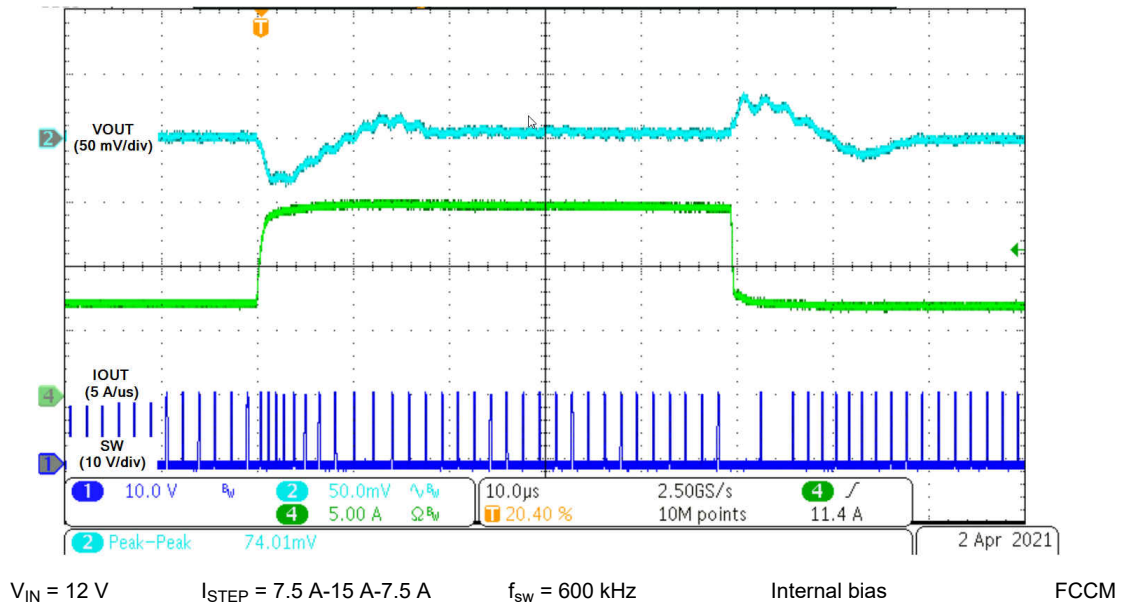

Figure 5-31. Load Transient, 7.5 A step, 10  $\mu\text{s}/\text{div}$ ,  $V_{TRANS} = 74\text{ mV}$

### 5.8 Bode Plot

$V_{IN} = 12\text{ V}$ ,  $V_{OUT} = 1.0\text{ V}$ ,  $C_{OUT} = 8 \times 47\text{ }\mu\text{F}$

(10)

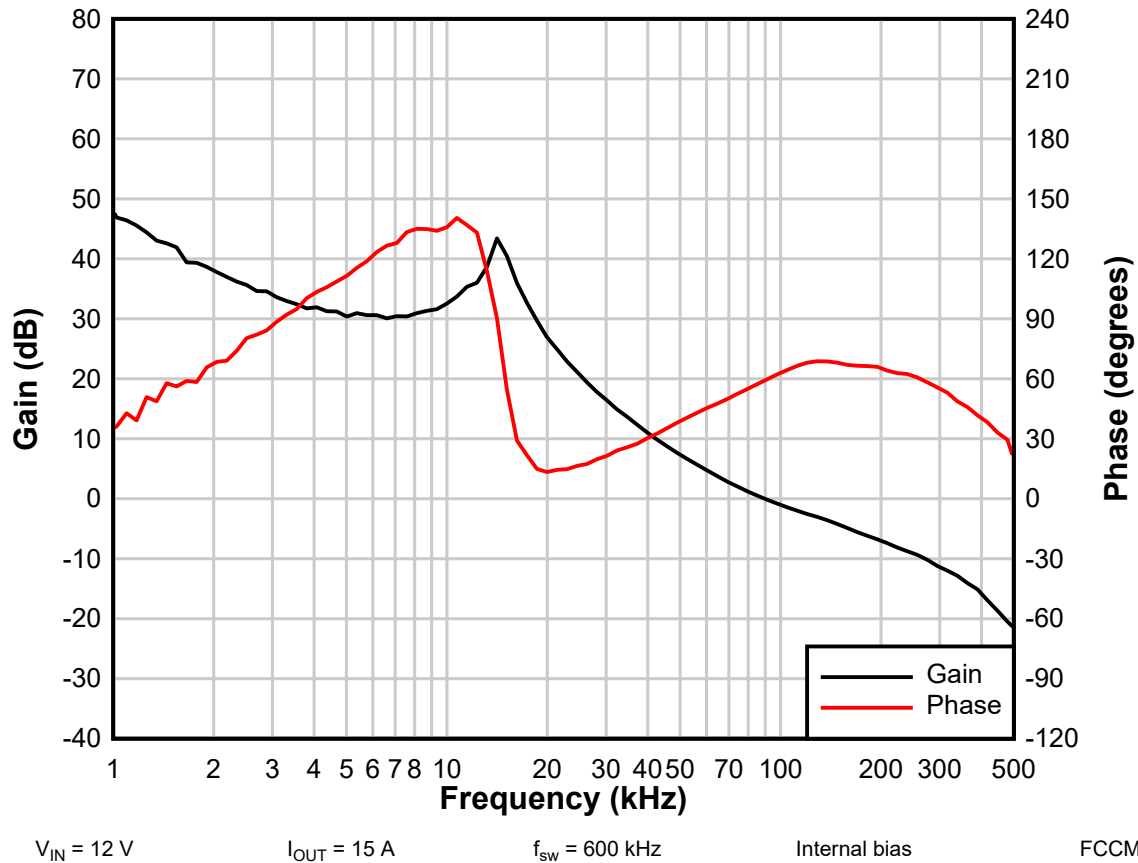

Figure 5-32. Bode Plot,  $V_{OUT} = 1\text{ V}$ ,  $I_{OUT} = 15\text{ A}$

## 6 TPSM8A29EVM Schematic

The schematic for the default TPSM8A29EVM is shown in Figure 6-1. Note that many components are not populated to allow for flexibility for testing designs with a wide range of performance requirements.

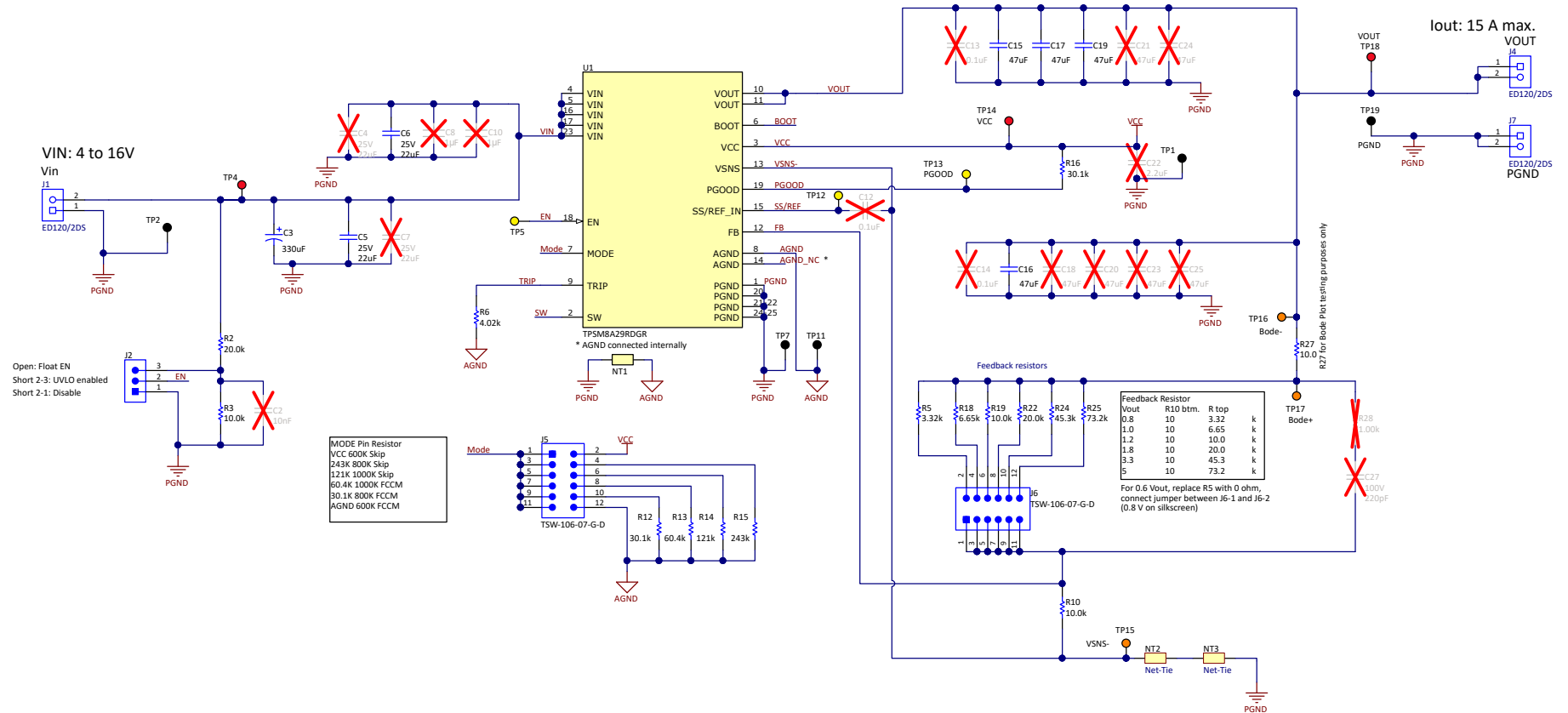

Figure 6-1. TPSM8A29EVM Schematic

## 7 TPSM8A29EVM PCB Layers

This section contains the composite views of the top and bottom layer (copper and silkscreen), as well as the copper views of all layers.

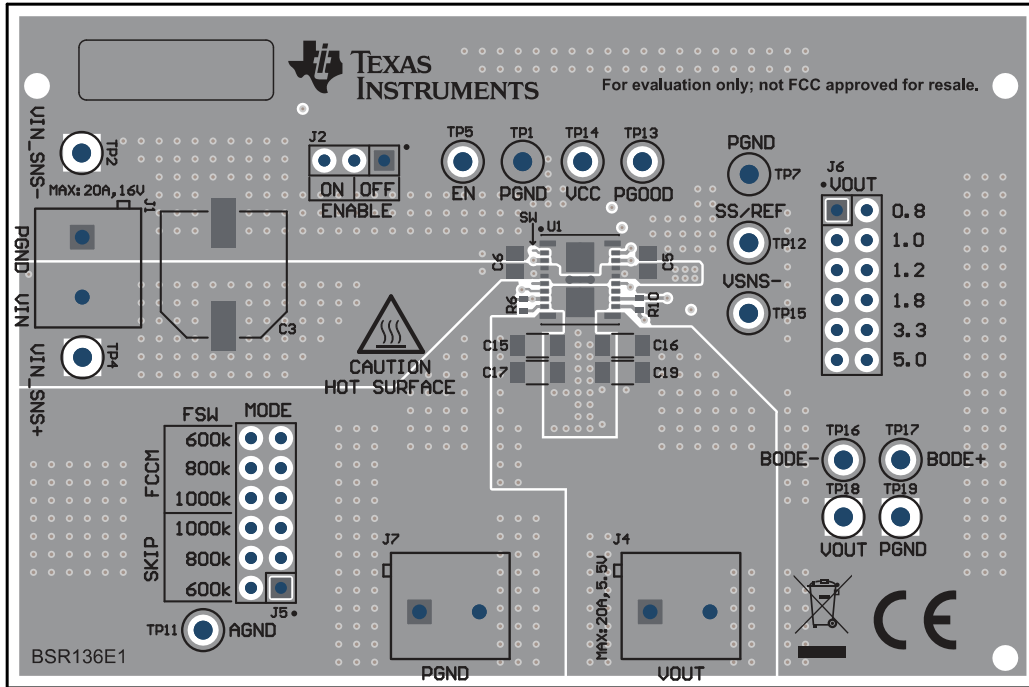

Figure 7-1. TPSM8A29EVM Top Layer Composite View

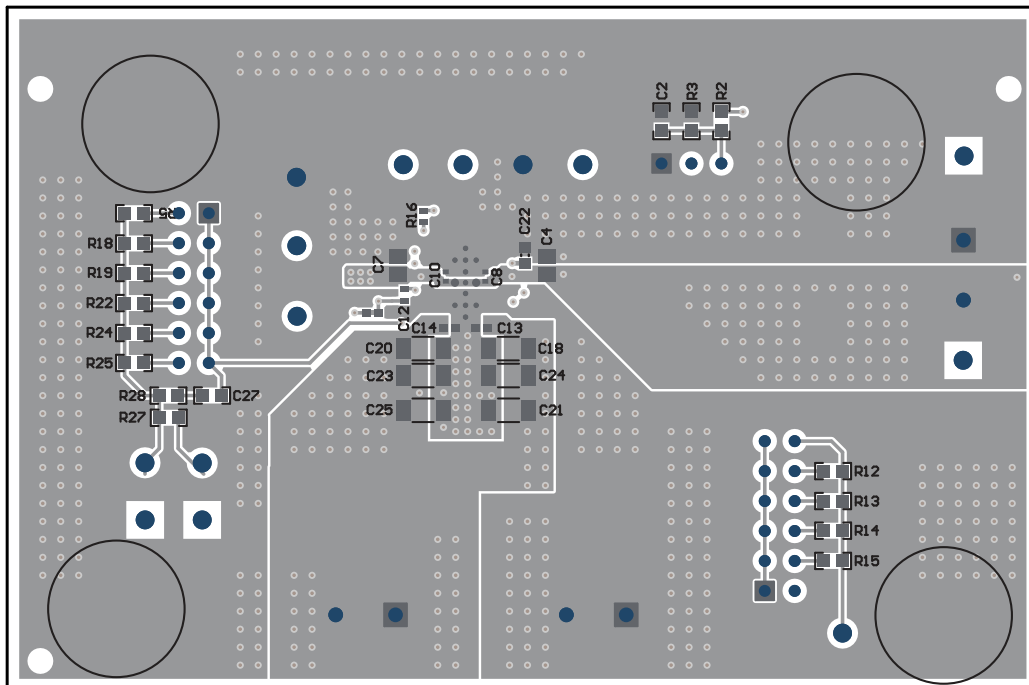

Figure 7-2. TPSM8A29EVM Bottom Layer Composite View

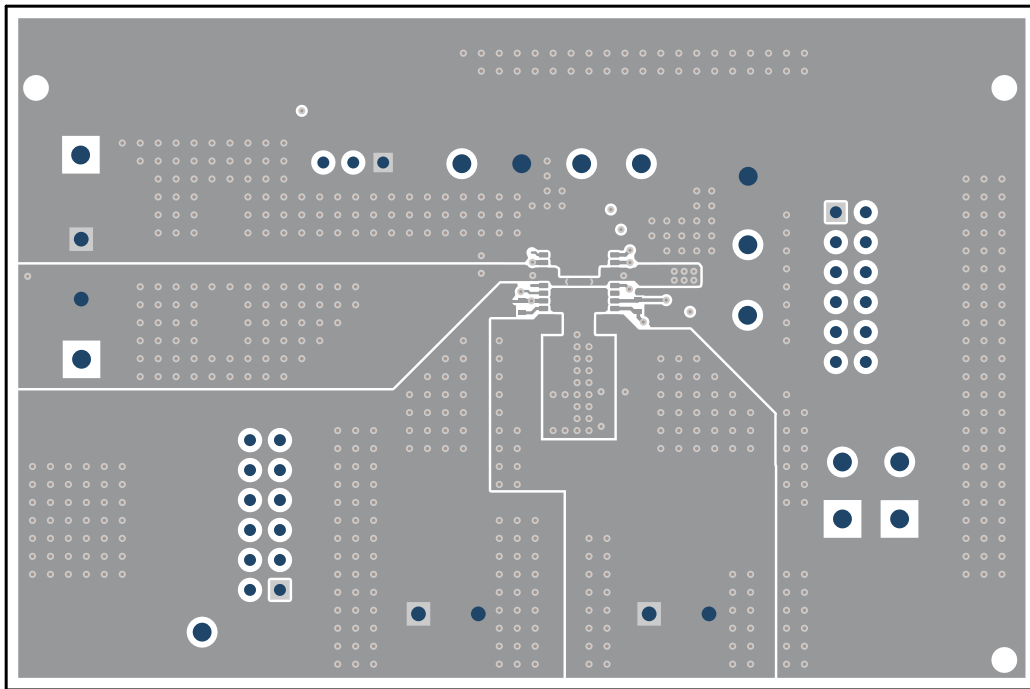

Figure 7-3. TPSM8A29EVM Top Layer Copper, Top-Down View

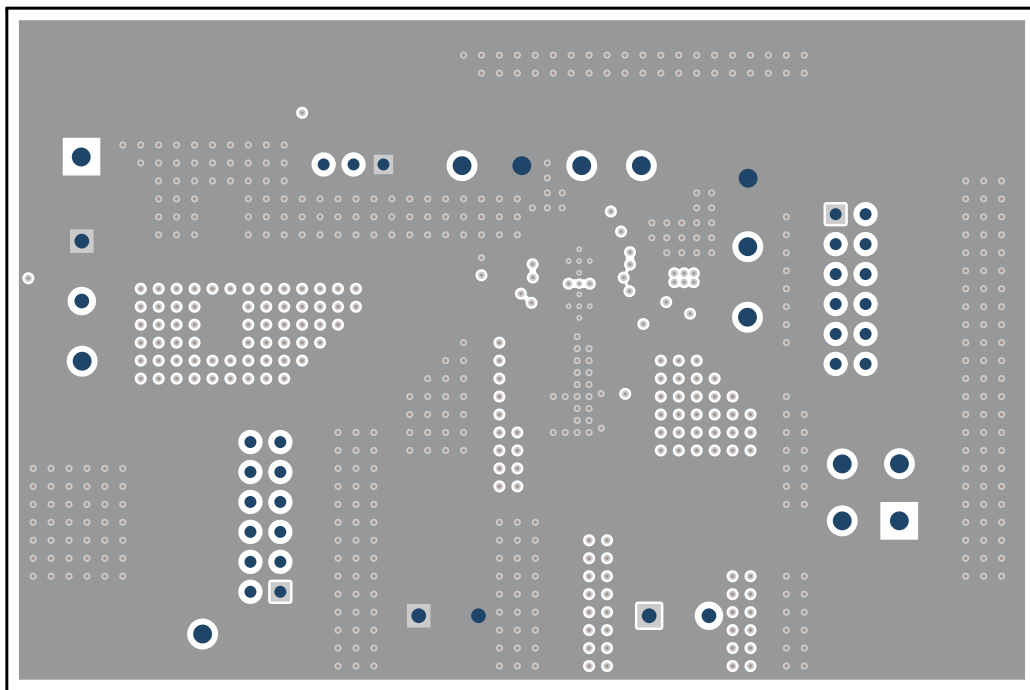
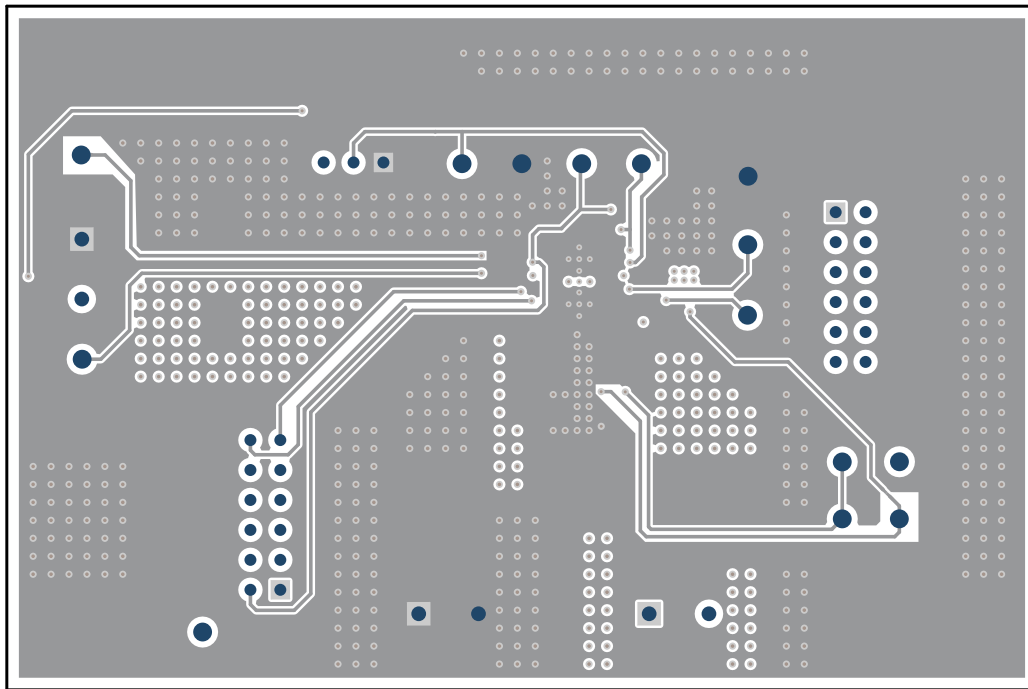
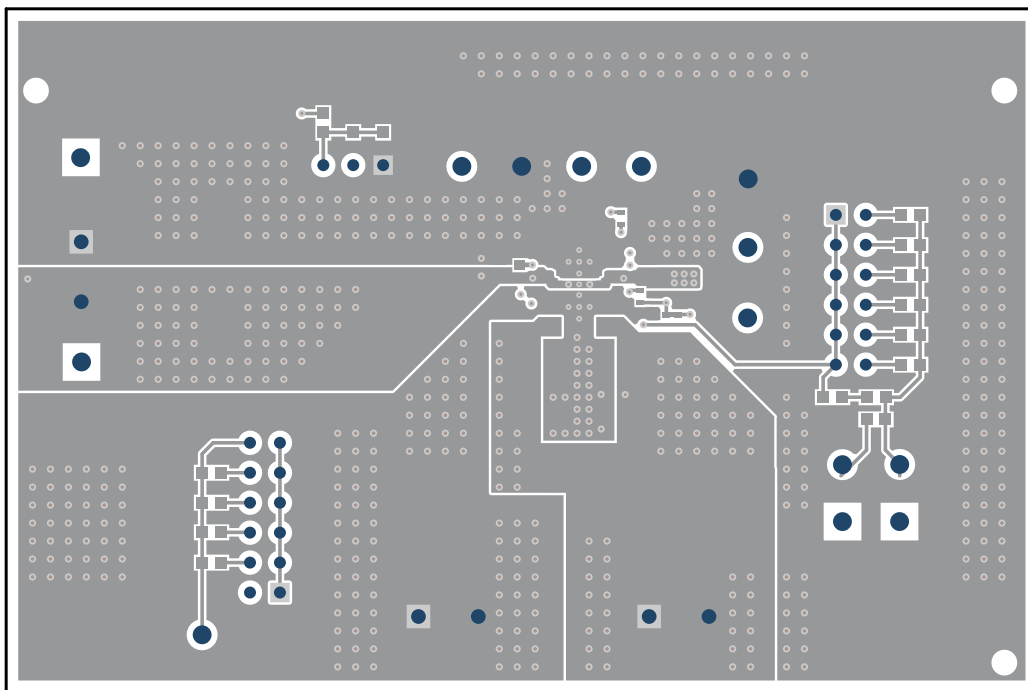

Figure 7-4. TPSM8A29EVM Inner Layer 1 Copper, Top-Down View



**Figure 7-5. TPSM8A29EVM Inner Layer 2 Copper, Top-Down View**



**Figure 7-6. TPSM8A29EVM Bottom Layer Copper, Top-Down View**

## 8 TPSM8A29EVM Bill of Materials

A complete bill of materials (BOM) is shown in [TPSM8A29EVM Bill of Materials](#). Resistors may be substituted as required so long as tolerance and temperature coefficients are considered. Capacitors may be substituted as required so long as dielectric, voltage ratings, and derating are considered. TI makes no guarantees about component availability.

**Table 8-1. TPSM8A29EVM Bill of Materials**

| Designator         | Quantity | Value | Description  | Package Reference            | Part Number        | Manufacturer        |
|--------------------|----------|-------|--|------------------------------|--------------------|---------------------|
| !PCB1              | 1        |       | Printed Circuit Board  |                              | BSR136             | Any                 |
| C3                 | 1        | 330uF | CAP, AL, 330 uF, 25 V, +/- 20%, 0.15 ohm, SMD                            | SMT Radial G                 | EEE-FC1E331P       | Panasonic           |
| C5, C6             | 2        | 22uF  | CAP, CERM, 22 uF, 25 V, +/- 20%, X5R, 0805                               | 0805                         | GRM21BR61E226ME44L | MuRata              |
| C15, C16, C17, C19 | 4        | 47uF  | CAP, CERM, 47 uF, 6.3 V, +/- 10%, X6S, 1206                              | 1206                         | GRM31CC80J476KE18L | MuRata              |
| H1, H2, H3, H4     | 4        |       | Bumpon, Hemisphere, 0.44 X 0.20, Clear                                   | Transparent Bumpon           | SJ-5303 (CLEAR)    | 3M                  |
| J1, J4, J7         | 3        |       | Terminal Block, 5.08 mm, 2x1, Brass, TH                                  | 2x1 5.08 mm Terminal Block   | ED120/2DS          | On-Shore Technology |
| J2                 | 1        |       | Header, 100mil, 3x1, Gold, TH  | Header, 100mil, 3x1, TH      | HTSW-103-07-G-S    | Samtec              |
| J5, J6             | 2        |       | Header, 100mil, 6x2, Gold, TH  | 6x2 Header                   | TSW-106-07-G-D     | Samtec              |
| LBL1               | 1        |       | Thermal Transfer Printable Labels, 0.650" W x 0.200" H - 10,000 per roll | PCB Label 0.650 x 0.200 inch | THT-14-423-10      | Brady               |
| R2                 | 1        | 20.0k | RES, 20.0 k, 1%, 0.1 W, AEC-Q200 Grade 0, 0603                           | 0603                         | CRCW060320K0FKEA   | Vishay-Dale         |
| R3                 | 1        | 10.0k | RES, 10.0 k, 1%, 0.1 W, AEC-Q200 Grade 0, 0603                           | 0603                         | CRCW060310K0FKEA   | Vishay-Dale         |
| R5                 | 1        | 3.32k | RES, 3.32 k, 1%, 0.1 W, 0603   | 0603                         | RC0603FR-073K32L   | Yageo               |
| R6                 | 1        | 4.02k | RES, 4.02 k, 1%, 0.063 W, AEC-Q200 Grade 0, 0402                         | 0402                         | CRCW04024K02FKED   | Vishay-Dale         |

**Table 8-1. TPSM8A29EVM Bill of Materials (continued)**

| Designator                | Quantity | Value | Description                                    | Package Reference            | Part Number      | Manufacturer  |
|---------------------------|----------|-------|--|------------------------------|------------------|---------------|
| R10                       | 1        | 10.0k | RES, 10.0 k, 1%, 0.063 W, 0402                 | 0402                         | RC0402FR-0710KL  | Yageo America |
| R12                       | 1        | 30.1k | RES, 30.1 k, 1%, 0.1 W, AEC-Q200 Grade 0, 0603 | 0603                         | CRCW060330K1FKFA | Vishay-Dale   |
| R13                       | 1        | 60.4k | RES, 60.4 k, 1%, 0.1 W, 0603                   | 0603                         | RC0603FR-0760K4L | Yageo         |
| R14                       | 1        | 121k  | RES, 121 k, 1%, 0.1 W, 0603                    | 0603                         | RC0603FR-07121KL | Yageo         |
| R15                       | 1        | 243k  | RES, 243 k, 1%, 0.1 W, AEC-Q200 Grade 0, 0603  | 0603                         | CRCW0603243KFKEA | Vishay-Dale   |
| R16                       | 1        | 30.1k | RES, 30.1 k, 1%, 0.063 W, 0402                 | 0402                         | RC0402FR-0730K1L | Yageo America |
| R18                       | 1        | 6.65k | RES, 6.65 k, 1%, 0.1 W, 0603                   | 0603                         | RC0603FR-076K65L | Yageo         |
| R19                       | 1        | 10.0k | RES, 10.0 k, 1%, 0.1 W, 0603                   | 0603                         | RC0603FR-0710KL  | Yageo         |
| R22                       | 1        | 20.0k | RES, 20.0 k, 1%, 0.1 W, 0603                   | 0603                         | RC0603FR-0720KL  | Yageo         |
| R24                       | 1        | 45.3k | RES, 45.3 k, 1%, 0.1 W, 0603                   | 0603                         | RC0603FR-0745K3L | Yageo         |
| R25                       | 1        | 73.2k | RES, 73.2 k, 1%, 0.1 W, 0603                   | 0603                         | RC0603FR-0773K2L | Yageo         |
| R27                       | 1        | 10.0  | RES, 10.0, 1%, 0.1 W, AEC-Q200 Grade 0, 0603   | 0603                         | CRCW060310R0FKFA | Vishay-Dale   |
| SH-J1, SH-J2, SH-J3       | 3        | 1x2   | Shunt, 100mil, Gold plated, Black              | Shunt                        | SNT-100-BK-G     | Samtec        |
| TP1, TP2, TP7, TP11, TP19 | 5        |       | Test Point, Multipurpose, Black, TH            | Black Multipurpose Testpoint | 5011             | Keystone      |
| TP4, TP14, TP18           | 3        |       | Test Point, Multipurpose, Red, TH              | Red Multipurpose Testpoint   | 5010             | Keystone      |
| TP5, TP12, TP13           | 3        |       | Test Point, Compact, Yellow, TH                | Yellow Compact Testpoint     | 5009             | Keystone      |



**Table 8-1. TPSM8A29EVM Bill of Materials (continued)**

| Designator                         | Quantity | Value  | Description  | Package Reference             | Part Number        | Manufacturer      |
|------------------------------------|----------|--------|--|-------------------------------|--------------------|-------------------|
| TP15, TP16, TP17                   | 3        |        | Test Point, Multipurpose, Orange, TH                       | Orange Multipurpose Testpoint | 5013               | Keystone          |
| U1                                 | 1        |        | Justin Junior Power Module, 16V, 12A, DC-DC buck converter | QFN-FCMOD                     | TPSM8A29RDGR       | Texas Instruments |
| C2                                 | 0        | 0.01uF | CAP, CERM, 0.01 uF, 16 V, +/- 10%, X7R, 0603               | 0603                          | 885012206040       | Würth Elektronik  |
| C4, C7                             | 0        | 22uF   | CAP, CERM, 22 uF, 25 V, +/- 20%, X5R, 0805                 | 0805                          | GRM21BR61E226ME44L | MuRata            |
| C8, C10                            | 0        |        | CAP CER 1UF 25V X6S 0402                                   | 0402                          | GRM155C81E105KE11D | Murata            |
| C12, C13, C14                      | 0        | 0.1uF  | CAP, CERM, 0.1 uF, 6.3 V, +/- 10%, X7R, 0402               | 0402                          | GRM155R70J104KA01D | MuRata            |
| C18, C20, C21, C23, C24, C25       | 0        | 47uF   | CAP, CERM, 47 uF, 6.3 V, +/- 10%, X6S, 1206                | 1206                          | GRM31CC80J476KE18L | MuRata            |
| C22                                | 0        | 2.2uF  | CAP, CERM, 2.2 uF, 10 V, +/- 10%, X7R, 0603                | 0603                          | GRM188R71A225KE15D | MuRata            |
| C27                                | 0        | 220pF  | CAP, CERM, 220 pF, 100 V, +/- 5%, C0G/NP0, 0603            | 0603                          | GRM1885C2A221JA01D | MuRata            |
| FID1, FID2, FID3, FID4, FID5, FID6 | 0        |        | Fiducial mark. There is nothing to buy or mount.           | N/A                           | N/A                | N/A               |
| R28                                | 0        | 1.00k  | RES, 1.00 k, 1%, 0.1 W, 0603                               | 0603                          | RC0603FR-071KL     | Yageo             |

## 9 Revision History

NOTE: Page numbers for previous revisions may differ from page numbers in the current version.

| <b>Changes from Revision * (July 2021) to Revision A (January 2022)</b> | <b>Page</b>       |
|---|-------------------|
| • Updated user's guide title.....                                       | <a href="#">3</a> |

---

## IMPORTANT NOTICE AND DISCLAIMER

TI PROVIDES TECHNICAL AND RELIABILITY DATA (INCLUDING DATA SHEETS), DESIGN RESOURCES (INCLUDING REFERENCE DESIGNS), APPLICATION OR OTHER DESIGN ADVICE, WEB TOOLS, SAFETY INFORMATION, AND OTHER RESOURCES "AS IS" AND WITH ALL FAULTS, AND DISCLAIMS ALL WARRANTIES, EXPRESS AND IMPLIED, INCLUDING WITHOUT LIMITATION ANY IMPLIED WARRANTIES OF MERCHANTABILITY, FITNESS FOR A PARTICULAR PURPOSE OR NON-INFRINGEMENT OF THIRD PARTY INTELLECTUAL PROPERTY RIGHTS.

These resources are intended for skilled developers designing with TI products. You are solely responsible for (1) selecting the appropriate TI products for your application, (2) designing, validating and testing your application, and (3) ensuring your application meets applicable standards, and any other safety, security, regulatory or other requirements.

These resources are subject to change without notice. TI grants you permission to use these resources only for development of an application that uses the TI products described in the resource. Other reproduction and display of these resources is prohibited. No license is granted to any other TI intellectual property right or to any third party intellectual property right. TI disclaims responsibility for, and you will fully indemnify TI and its representatives against, any claims, damages, costs, losses, and liabilities arising out of your use of these resources.

TI's products are provided subject to [TI's Terms of Sale](#) or other applicable terms available either on [ti.com](http://ti.com) or provided in conjunction with such TI products. TI's provision of these resources does not expand or otherwise alter TI's applicable warranties or warranty disclaimers for TI products.

TI objects to and rejects any additional or different terms you may have proposed.

Mailing Address: Texas Instruments, Post Office Box 655303, Dallas, Texas 75265  
Copyright © 2022, Texas Instruments Incorporated