

# Using isolated comparators for fault detection in electric motor drives

Krunal Maniar

Product marketing engineer  
Texas Instruments

## Introduction

An **electric motor drive** is an electrical system that provides a variable frequency output to an electric motor to drive industrial loads such as heating and air-conditioning, ventilation, pumps, compressors, and elevators, and factory automation loads such as conveyor belts, mining, and papermill equipment.

Electric motor drives in industrial environments experience conditions such as high temperatures and high humidity, AC power-line fluctuations, and mechanical overloads. Users are demanding greater efficiency, along with more reliability. The switching speeds of power semiconductor devices such as insulated-gate bipolar transistors (IGBTs) are continuously increasing, with greater adoption of wide-bandgap technologies such as silicon carbide (SiC) and gallium nitride (GaN) that enable faster switching speeds. Given the increasing need for higher switching speeds and more system reliability, modern motor-drive systems must both detect and protect against several fault events to minimize industrial equipment downtime.

In this article, I will discuss the priority level and impact of different fault events, along with how to detect them to prevent damage to motor-drive circuits.

## Introduction to electric motor drives

An electric motor-drive system, as shown in **Figure 1**, takes power from the AC mains, rectifies it to a DC voltage, and inverts the DC back to AC with variable magnitude and frequency based on load demand through complex feedback control algorithms.

A motor-drive system typically has two voltage domains: the “high-voltage” domain and the “low-voltage” domain. The microcontroller or digital signal processor, typically on the low-voltage domain, receives feedback signals (voltage, current, temperature, etc.) from the three-phase IGBT power stage and generates pulse-width modulated signals for controlling the power switching transistors and other high-side power circuitry. Such systems demand resilient and reliable galvanic isolation to isolate high-voltage circuits from low-voltage circuits. An isolation architecture enables reliable operation of motor-drive systems, preventing damage to expensive circuitry by breaking the ground loops between the high- and low- voltage circuits and helping protect human operators from high voltages.

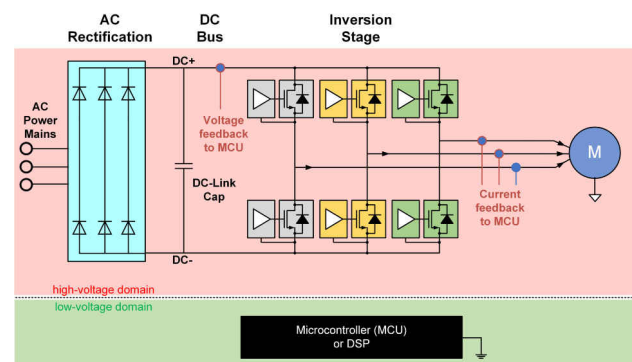
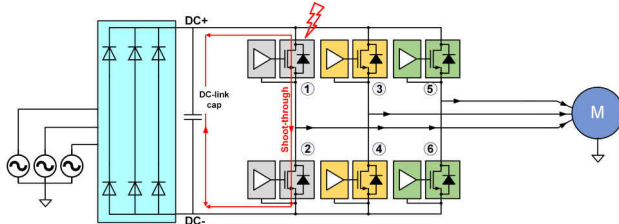

**Figure 1.** AC-input electric motor-drive block diagram

## Understanding fault events in electric motor drives

Electric motor drives are susceptible to several electrical fault events. As shown in **Figure 2**, a shoot-through fault occurs when the adjacent power switching transistors, 1 and 2, accidentally turn on at the same time. This fault can occur because of several reasons: electromagnetic interference, a malfunction in the

microcontroller controlling the switching transistors, or simply worn-out switching transistors. This fault short-circuits the DC-link capacitor and can cause catastrophic failure, resulting in excessive heating, fire or even an explosion. Thus, it is imperative to detect shoot-through faults and take corrective actions such as turning off the power switching transistor very quickly.



**Figure 2.** A shoot-through fault in electric motor drives.

As shown in **Figure 3**, a ground fault occurs when the motor cables, motor casing or motor windings are shorted to ground. Such shorts to ground can occur because of dielectric strength degradation in insulation caused by overstress conditions in temperature or voltage over an extended period of time. Old motors and cables are more vulnerable to ground-fault events, which can put human operators at risk for electric shocks. Thus, a ground fault requires detection and corrective actions such as rewinding or replacing the motor.

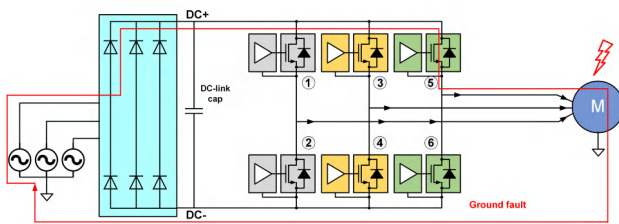

**Figure 3.** A ground fault in electric motor drives.

As shown in **Figure 4**, a phase-to-phase short fault occurs when there is an insulation breakdown in between two windings of the two phases at the stator. These phase-to-phase shorts can occur because of dielectric strength degradation in insulation caused by overstress conditions in temperature or voltage over an extended period of time. This short results in a huge increase in stator current, resulting in potential damage to the IGBTs in the power stage. Old motors and cables are more

vulnerable to phase-to-phase shorts. Like ground faults, phase-to-phase faults need detection and corrective actions such as rewinding or replacing the motor.

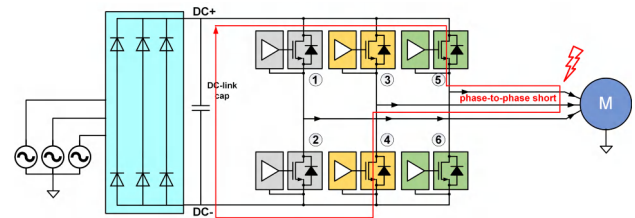

**Figure 4.** A phase-to-phase short in electric motor drives.

Overvoltage occurs for several reasons – back-injection from the motor to the DC-link rail during breaking, poor regulation of AC power abnormal circuit loads, wiring errors and insulation failures. Overvoltage can result in voltage overstresses and excessive current that can damage DC-link capacitors and IGBTs, degrade the electrical insulation, and damage or reduce the lifetime of a motor-drive system. It is extremely important to limit the thermal energy through the IGBT by interrupting or reducing shoot-through, ground faults and phase-to-phase shorts, and avoiding transient overvoltage conditions.

### Achieving reliable detection and protection in electric motor drives

Designers must incorporate multiple levels of reliable detection and protection to prevent damage to motor-drive circuits. Power switching transistors such as IGBTs have relatively short withstand times (less than 10  $\mu\text{s}$ ) and can quickly overheat and become damaged from excessive currents.

Current-limiting fuses and circuit breakers provide excellent overcurrent protection, but have slow reaction times and require user intervention. They are often the last resort for protection during a failure event.

To detect and quickly protect the motor drive against these fault conditions, one solution senses the current and voltage at critical electrical paths within the motor drive. The measured current and voltage are received by a host microcontroller that controls high-side power

circuits such as power switching transistors and circuit breakers. To suppress overcurrents or overvoltage faults, the host microcontroller either turns off or modifies the switching characteristics of power transistors, or trips the circuit breakers.

**Figure 5** shows the Texas Instruments (TI) **AMC23C14** family of low-latency reinforced isolated comparators in short-circuit current, overcurrent, undercurrent, overvoltage, undervoltage and overtemperature fault-detection scenarios. These devices integrate adjustable comparator threshold functions, include a high-side low-dropout regulator for the power supply, and have a response time of sub-0.5  $\mu\text{s}$  in an eight-pin small-outline integrated circuit package.

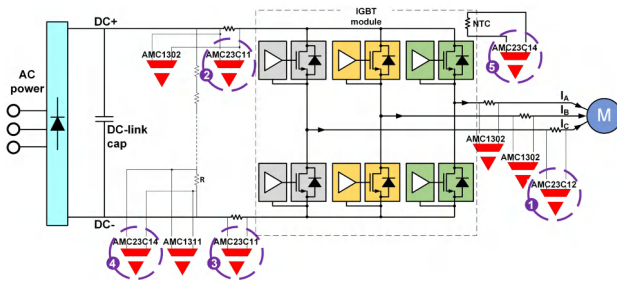
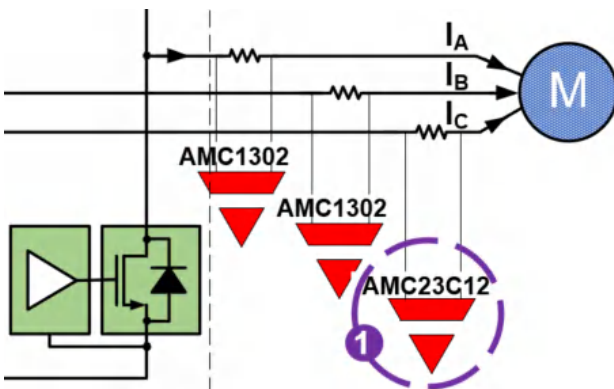

**Figure 5.** Ultra-fast fault detection in electric motor drives.

Next, review the several use cases for **AMC23C14** family of isolated comparators in electric motor drives.

**Use case No. 1: Bidirectional in-phase overcurrent detection**

**Figure 6** shows how **AMC23C12** can be used for bidirectional in-phase overcurrent detection.



**Figure 6.** Bidirectional in-phase overcurrent detection.

In a fully operational three-phase AC motor-drive system, the sum of three-phase current to the AC motor should be zero, regardless of braking or running conditions (that is,  $I_A + I_B + I_C = 0$ ).

Calculating the third-phase current in low- to mid-end motor drives from measured current on two phases can help reduce costs. I recommend monitoring the current on the third phase to detect any electrical fault events. While you could place a current sensor on the third phase with an isolated amplifier or isolated modulator, you could also use a reinforced isolated window comparator **AMC23C12** for simplicity, cost-effectiveness and solution size. The AMC23C12 offers bidirectional overcurrent detection with an integrated window comparator.

As shown in location 1 of **Figure 6**, a shunt resistor produces a voltage drop that the AMC23C12 reinforced window comparator senses. The AMC23C12 has an open-drain output, OUT, which actively pulls low when the input voltage exceeds the pre-defined threshold values of the voltage on the reference pin for the purposes of overcurrent detection. **Figure 7** shows an overcurrent event output waveform.

For both overcurrent and short-circuit detection, you can use the AMC23C14 dual window comparator.

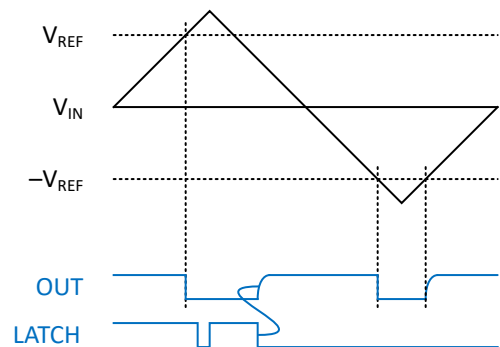

**Figure 7.** AMC23C12 output waveform.

### Use case No. 2: DC+ overcurrent detection

As shown in location 2 of **Figure 8**, the **AMC23C11** can be a good choice for DC+ overcurrent detection.

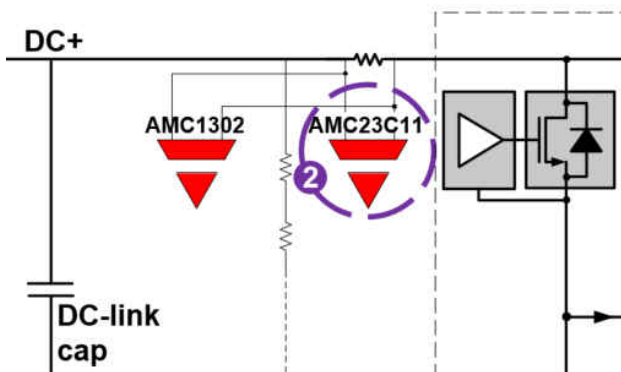

**Figure 8.** DC+ overcurrent detection.

**Figure 9** shows an overcurrent event output waveform. Like the AMC23C12, the AMC23C11 has an open-drain output, OUT, that actively pulls low when the input voltage exceeds the pre-defined threshold value of the voltage on the reference pin. The AMC23C11 also supports latched mode with a LATCH input pin that clears the output only after the latch clears. If you require both overcurrent and short-circuit detection, you can use the AMC23C14 to set the two threshold levels for overcurrent and short-circuit detection, respectively.

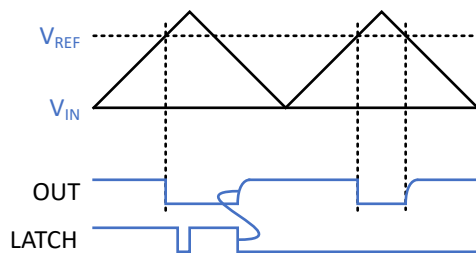

**Figure 9.** AMC23C11 output waveform.

### Use case No. 3: DC- overcurrent or short-circuit detection

Similar to the details as explained in use case No. 2, you can also use the AMC23C11 to detect overcurrent on the DC- line. If you require both overcurrent and short-circuit detection, you can use the AMC23C14 to set the two threshold levels for overcurrent and short-circuit detection, respectively.

### Use case No. 4: DC-link (DC+ to DC-) overvoltage and undervoltage detection

The DC-link voltage should be within the specified range for proper operation of the motor drive. The AMC23C14 can be a good choice for detecting overvoltage and undervoltage conditions.

As shown in location 4 of **Figure 10**, the bottom resistor of a resistor-divider network produces a voltage drop that is sensed by the AMC23C14 dual reinforced window comparator.

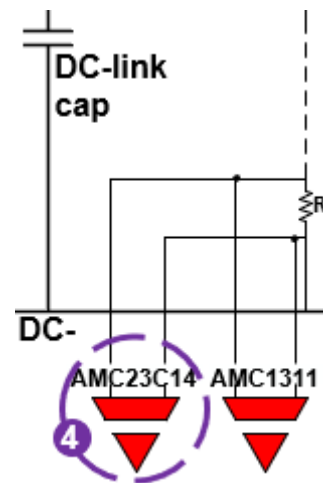

**Figure 10.** DC-link overvoltage and undervoltage detection.

The AMC23C14 has two open-drain outputs, OUT1 and OUT2, one for each window comparator. OUT1 actively pulls low when the input voltage exceeds the pre-defined threshold values of the voltage on the reference pin for the purposes of undervoltage detection. OUT2 actively pulls low when the input voltage exceeds the threshold values defined by the internal 300-mV reference for the purposes of overvoltage detection. **Figure 11** shows the OUT1 and OUT2 outputs for overvoltage and undervoltage events. If you only require overvoltage detection, you can use the AMC23C11.

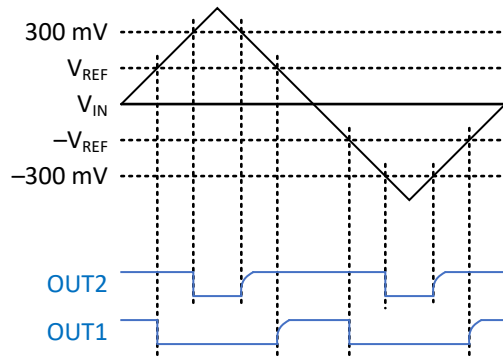

Figure 11. AMC23C14 output waveform.

### Use case No. 5: IGBT module overtemperature detection

As shown in Figure 12, a negative temperature coefficient thermistor (NTC) is typically placed inside the IGBT module for the detection of long-term overload conditions. These NTC terminals are routed to the main power board, where the AMC23C14 can be used for overtemperature detection.

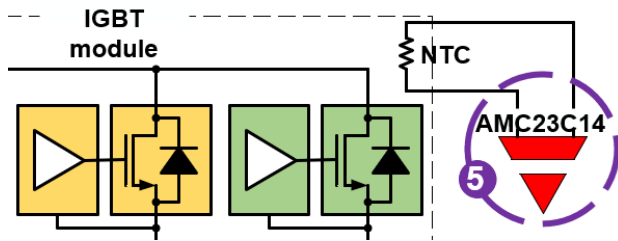

Figure 12. IGBT module overtemperature detection.

Figure 13 shows the output waveform for an overtemperature event, where OUT2 pulls high when the input voltage exceeds the threshold values defined by the internal 300-mV reference. The reference pin of the AMC23C14 connects to a 100- $\mu$ A current source that can bias the NTC.

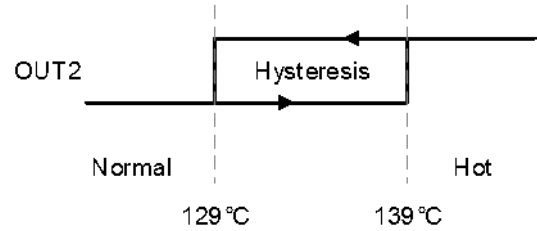

Figure 13. AMC23C14 output waveform.

As the demand to improve system reliability and the adoption of faster switching devices proliferates, the AMC23C14 family of low-latency reinforced isolated comparators solves the critical need for accurate and fast detection in electric motor drives

**Important Notice:** The products and services of Texas Instruments Incorporated and its subsidiaries described herein are sold subject to TI's standard terms and conditions of sale. Customers are advised to obtain the most current and complete information about TI products and services before placing orders. TI assumes no liability for applications assistance, customer's applications or product designs, software performance, or infringement of patents. The publication of information regarding any other company's products or services does not constitute TI's approval, warranty or endorsement thereof.

All trademarks are the property of their respective owners.

## IMPORTANT NOTICE AND DISCLAIMER

TI PROVIDES TECHNICAL AND RELIABILITY DATA (INCLUDING DATA SHEETS), DESIGN RESOURCES (INCLUDING REFERENCE DESIGNS), APPLICATION OR OTHER DESIGN ADVICE, WEB TOOLS, SAFETY INFORMATION, AND OTHER RESOURCES "AS IS" AND WITH ALL FAULTS, AND DISCLAIMS ALL WARRANTIES, EXPRESS AND IMPLIED, INCLUDING WITHOUT LIMITATION ANY IMPLIED WARRANTIES OF MERCHANTABILITY, FITNESS FOR A PARTICULAR PURPOSE OR NON-INFRINGEMENT OF THIRD PARTY INTELLECTUAL PROPERTY RIGHTS.

These resources are intended for skilled developers designing with TI products. You are solely responsible for (1) selecting the appropriate TI products for your application, (2) designing, validating and testing your application, and (3) ensuring your application meets applicable standards, and any other safety, security, regulatory or other requirements.

These resources are subject to change without notice. TI grants you permission to use these resources only for development of an application that uses the TI products described in the resource. Other reproduction and display of these resources is prohibited. No license is granted to any other TI intellectual property right or to any third party intellectual property right. TI disclaims responsibility for, and you will fully indemnify TI and its representatives against, any claims, damages, costs, losses, and liabilities arising out of your use of these resources.

TI's products are provided subject to [TI's Terms of Sale](#) or other applicable terms available either on [ti.com](http://ti.com) or provided in conjunction with such TI products. TI's provision of these resources does not expand or otherwise alter TI's applicable warranties or warranty disclaimers for TI products.

TI objects to and rejects any additional or different terms you may have proposed.

Mailing Address: Texas Instruments, Post Office Box 655303, Dallas, Texas 75265  
Copyright © 2022, Texas Instruments Incorporated