



ABSTRACT

This user's guide describes the characteristics, operation, and use of TI's evaluation module (EVM) for the TPS62816-Q1 devices. The TPS62816EVM-140 is designed to help the user easily evaluate and test the operation and functionality of the TPS62816-Q1 buck converters. The EVM converts a 2.7-V to 6.0-V input voltage to a regulated 1.8-V output voltage that delivers up to 6 A. This user's guide includes setup instructions for the hardware, a printed-circuit board (PCB) layout, a schematic diagram and a bill of materials (BOM).

Table of Contents

1 Warning and Caution	2
2 Introduction	2
3 Setup	4
4 TPS62816EVM-140 Test Results	4
5 Board Layout	4
6 Schematic	7
7 List of Materials	8

List of Figures

Figure 5-1. Top Silk.....	4
Figure 5-2. Top Layer.....	5
Figure 5-3. Layer 2.....	5
Figure 5-4. Layer 3.....	5
Figure 5-5. Layer 4.....	6
Figure 5-6. Layer 5.....	6
Figure 5-7. Bottom Layer.....	6
Figure 6-1. TPS62816EVM-140 Schematic.....	7

List of Tables

Table 2-1. Performance Specification Summary.....	2
Table 7-1. TPS62816EVM-140 List of Materials.....	8

Trademarks

All trademarks are the property of their respective owners.

1 Warning and Caution

	Caution	Caution Hot surface. Contact may cause burns, Do not touch!
---	----------------	---

2 Introduction

The TPS62816-Q1 device is a high-frequency, synchronous, step-down converter optimized for a small solution size and high efficiency. The devices focus on high-efficiency, step-down conversion over a wide output current range. At medium to heavy loads, the converter operates in PWM mode and automatically enters *Power Save Mode* operation at light load to maintain high efficiency over the entire load-current range. The internal compensation circuit allows a compact solution and small external components. The device is available in a 3.0-mm × 2.0-mm, 9-pin VQFN package.

2.1 Performance Specification

Table 2-1 provides a summary of the TPS62816EVM-140 performance specifications.

Table 2-1. Performance Specification Summary

Specification		Test Conditions	MIN	TYP	MAX	Unit
Input voltage			2.7		6.0	V
Output voltage setpoint				1.8		V
Output current	TPS62816EVM-140		0		6.0	A

2.2 Modifications

The printed-circuit board (PCB) for this EVM is designed to accommodate the different adjustable output voltage versions of this integrated circuit (IC). On the EVM, additional input and output capacitors can be added, the soft-start time can be changed and the switching frequency can be modified.

2.2.1 Input and Output Capacitors

A footprint for an additional output capacitor (C19) is provided. This capacitor is not required for proper operation but can be used to reduce output voltage ripple and to improve the load transient response. For proper operation the total output capacitance must remain within the recommended range described in the [TPS62816-Q1 Low Input Voltage, Adjustable-Frequency Step-Down Converter data sheet](#).

2.2.2 Adjustable-Output IC U1 Operation

U1 is configured for evaluation of the adjustable-output version. This unit is set to 1.8 V. Resistors R1 and R2 can be used to set the output voltage between 0.6 V and 5.5 V. For recommended values, see the [TPS62816-Q1 Low Input Voltage, Adjustable-Frequency Step-Down Converter data sheet](#).

2.2.3 Feedforward Capacitor

C10 is the feedforward capacitor. If the feedback divider (R1 and R2) has been modified it may be required to adjust the value of the feedforward capacitor as well. For recommended values, see the [TPS62816-Q1 Low Input Voltage, Adjustable-Frequency Step-Down Converter data sheet](#).

2.2.4 Soft-Start Time

C9 controls the soft-start time of the output voltage. It can be changed for a faster or slower ramp up of the output voltage. For recommended capacitor values, see the [TPS62816-Q1 Low Input Voltage, Adjustable-Frequency Step-Down Converter data sheet](#).

2.2.5 Tracking

A control voltage connected to J4 can be used to control the output voltage. For more details see the [TPS62816-Q1 Low Input Voltage, Adjustable-Frequency Step-Down Converter data sheet](#).

2.2.6 Switching Frequency and Control Loop Compensation

R4 controls the switching frequency of the converter. It is also used to select a predefined control loop compensation setting. For recommended values, see the [TPS62816-Q1 Low Input Voltage, Adjustable-Frequency Step-Down Converter data sheet](#).

3 Setup

This section describes how to correctly use the TPS62816EVM-140.

3.1 Connector Descriptions

J1, Pin 1, 2 and 3 – VIN	Positive input voltage connection from the input supply for the EVM
J1, Pin 4, 5 and 6 – GND	Input return connection from the input supply for the EVM
J2, Pin 1, 2 and 3 – VOUT	Positive output voltage connection
J2, Pin 4, 5 and 6 – GND	Output return connection
JP1 – EN	EN pin jumper. Place the supplied jumper across ON and EN to turn on the IC. Place the jumper across OFF and EN to turn off the IC.
JP2 – MODE/SYNC	MODE/SYNC pin jumper. Place the supplied jumper across VIN and MODE/SYNC to force the device in fixed frequency PWM operation at all load currents. Place the jumper across MODE/SYNC and GND to enable power save mode. Connect a clock signal to MODE/SYNC referenced to GND to synchronize the switching frequency to the clock signal.
J3 – PG	The PG output appears on pin 1 of this header with a convenient ground on pin 2.
J4 – SS/TR	SS/TR input, a voltage connected on pin 1 of this header referenced to GND on pin 2 can be used to control the output voltage (tracking).

3.2 Hardware Setup

To operate the EVM, set jumpers JP1 and JP2 to the desired positions per [Section 3.1](#). Connect the input supply to J1, between VIN and GND and connect the load to J2 between VOUT and GND.

4 TPS62816EVM-140 Test Results

The TPS62816EVM-140 was used to take the typical characteristics data in the TPS62816-Q1 data sheet. See [TPS62816-Q1 Low Input Voltage, Adjustable-Frequency Step-Down Converter data sheet](#) for the performance of this EVM.

5 Board Layout

This section provides the TPS62816EVM-140 board layout. The Gerber files are available on the [TPS62816EVM-140](#) tool page

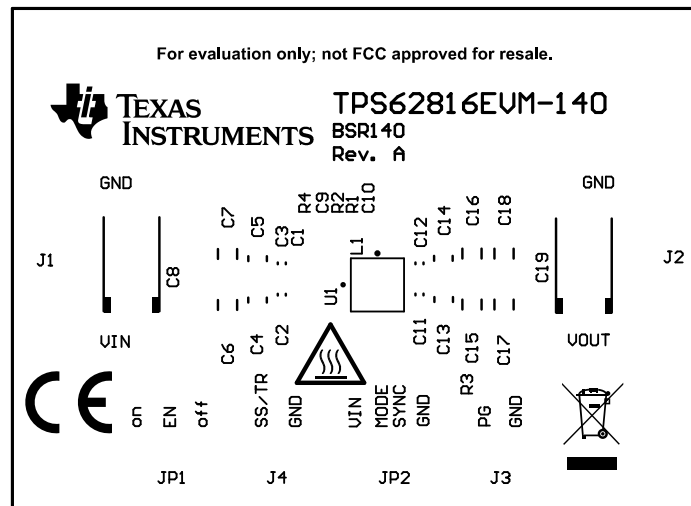

Figure 5-1. Top Silk

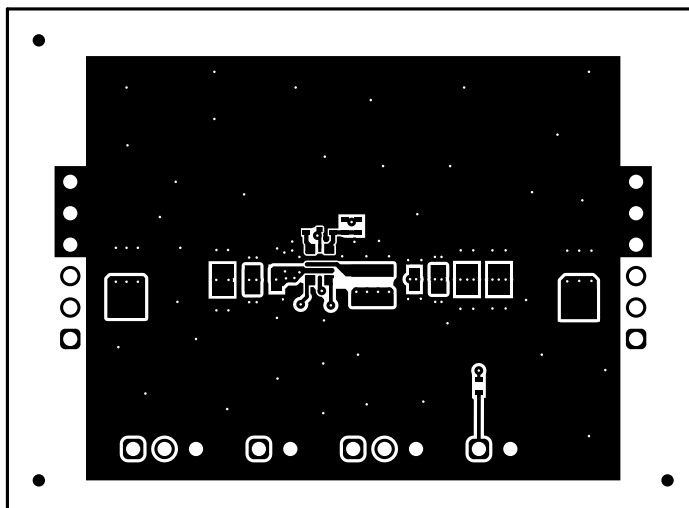

Figure 5-2. Top Layer

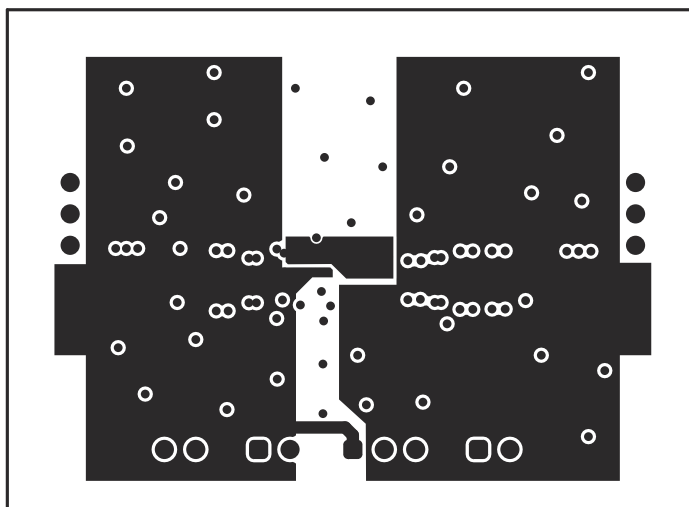

Figure 5-3. Layer 2

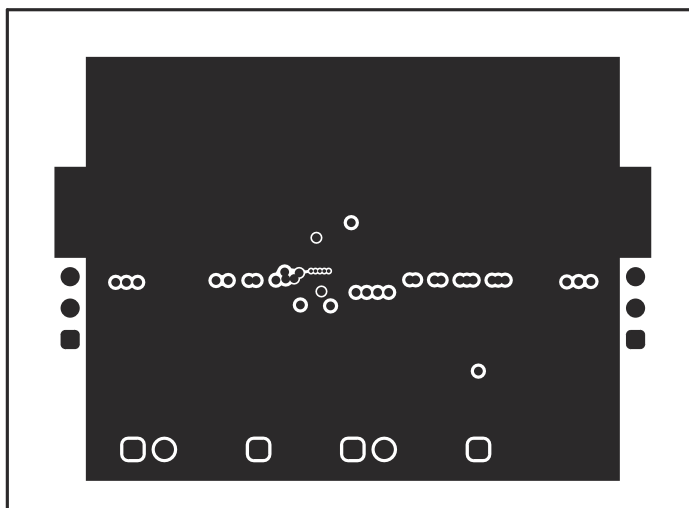

Figure 5-4. Layer 3

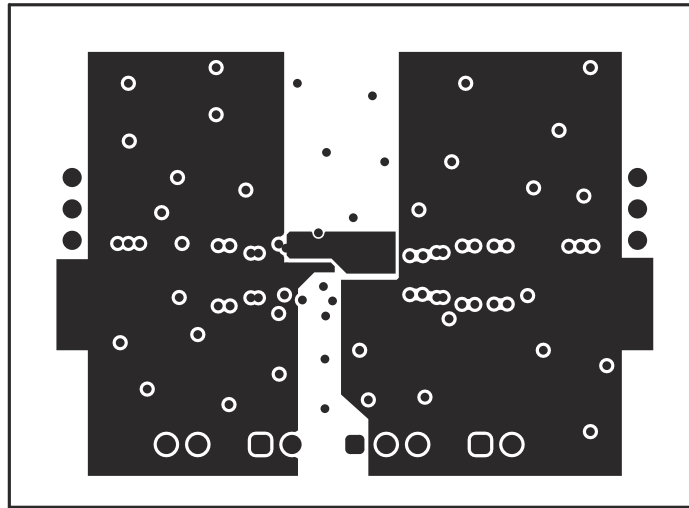

Figure 5-5. Layer 4

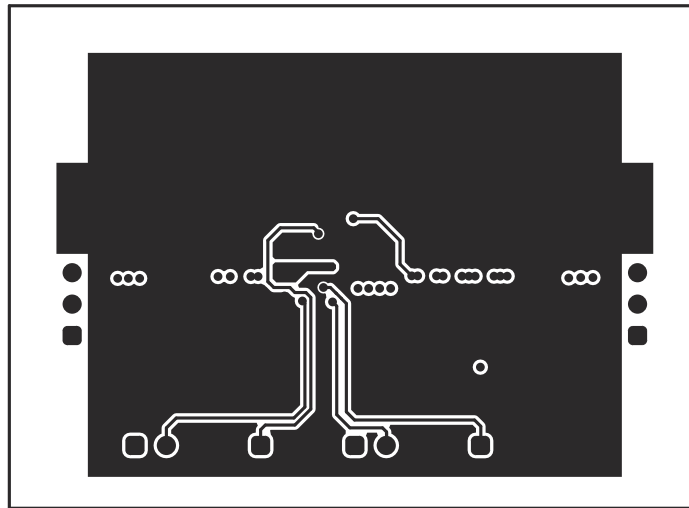

Figure 5-6. Layer 5

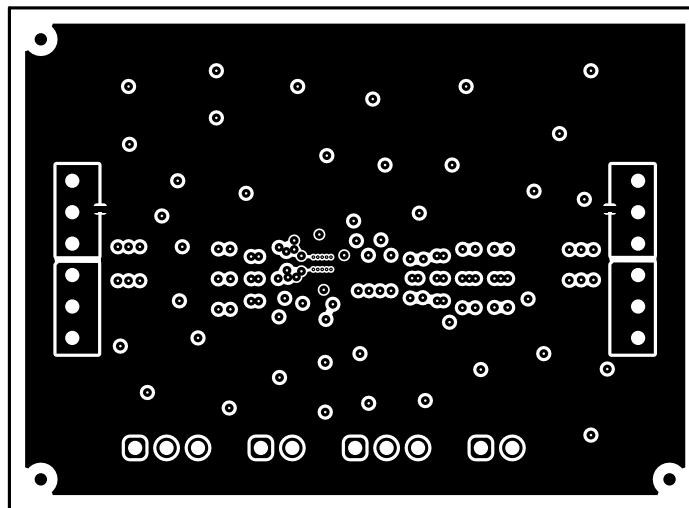

Figure 5-7. Bottom Layer

6 Schematic

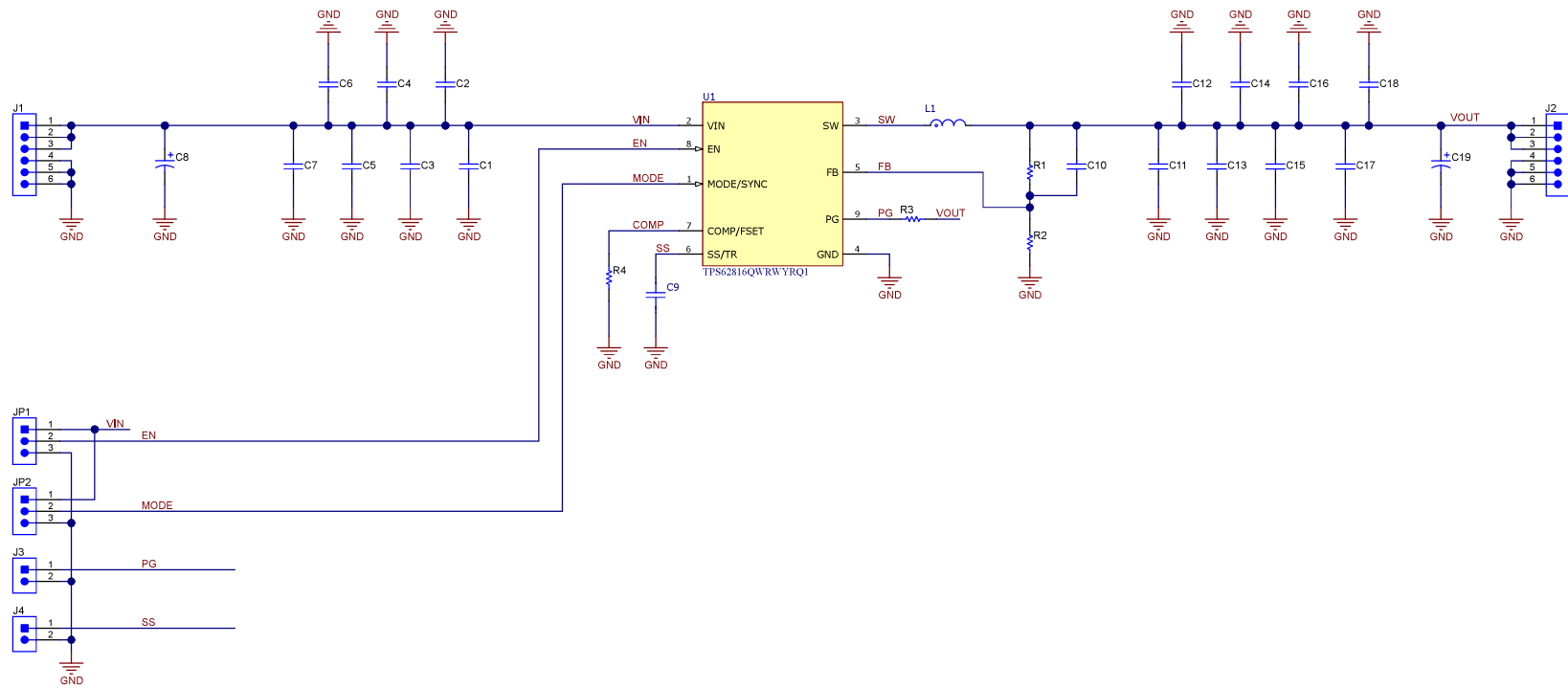

Figure 6-1. TPS62816EVM-140 Schematic

7 List of Materials

Table 7-1 TPS62816EVM-140 list of materials.

Table 7-1. TPS62816EVM-140 List of Materials

QTY	REF DES	VALUE	DESCRIPTION	SIZE	Part Number	MFR
1	C1	0.47 μ F	Ceramic capacitor, 10 V, X7S	0402	GCM155C71A474KE36	MuRata
1	C9	0.015 μ F	Ceramic capacitor, 50 V, COG/NPO	0402		any
1	C10	10 pF	Ceramic capacitor, 50 V, COG/NPO	0402		any
4	C2, C3, C11,C12	2.2 μ F	Ceramic capacitor, 6.3 V, X7R	0603	GCM188R70J225KE22	MuRata
4	C4, C5, C13,C14	10 μ F	Ceramic capacitor, 10 V, X7R	0805	GCM21BR71A106KE22	MuRata
6	C6, C7, C15,C16,C17, C18	22 μ F	Ceramic capacitor, 10 V, X7R	1206	GCM31CR71A226KE02	MuRata
1	C8	100 μ F	Polymer capacitor, 20 V	7.3 x 4.3 mm	20TQC100MYF	Panasonic
1	L1	250 nH	Inductor	4.0 x 4.0 x 2.0 mm	XGL4020-251MEC	Coilcraft
1	R1	80.6 k Ω	Resistor 1%, 0.1 W	0402		any
1	R2	40.2 k Ω	Resistor 1%, 0.1 W	0402		any
1	R3	100 k Ω	Resistor 1%, 0.1 W	0402		any
1	R4	8.06 k Ω	Resistor 1%, 0.1 W	0402		any
1	U1		Low Input Voltage, Adjustable-Frequency Step-down Converter	VQFN-HR-9	TPS62816QWRWYRQ1	Texas Instruments

IMPORTANT NOTICE AND DISCLAIMER

TI PROVIDES TECHNICAL AND RELIABILITY DATA (INCLUDING DATA SHEETS), DESIGN RESOURCES (INCLUDING REFERENCE DESIGNS), APPLICATION OR OTHER DESIGN ADVICE, WEB TOOLS, SAFETY INFORMATION, AND OTHER RESOURCES "AS IS" AND WITH ALL FAULTS, AND DISCLAIMS ALL WARRANTIES, EXPRESS AND IMPLIED, INCLUDING WITHOUT LIMITATION ANY IMPLIED WARRANTIES OF MERCHANTABILITY, FITNESS FOR A PARTICULAR PURPOSE OR NON-INFRINGEMENT OF THIRD PARTY INTELLECTUAL PROPERTY RIGHTS.

These resources are intended for skilled developers designing with TI products. You are solely responsible for (1) selecting the appropriate TI products for your application, (2) designing, validating and testing your application, and (3) ensuring your application meets applicable standards, and any other safety, security, regulatory or other requirements.

These resources are subject to change without notice. TI grants you permission to use these resources only for development of an application that uses the TI products described in the resource. Other reproduction and display of these resources is prohibited. No license is granted to any other TI intellectual property right or to any third party intellectual property right. TI disclaims responsibility for, and you will fully indemnify TI and its representatives against, any claims, damages, costs, losses, and liabilities arising out of your use of these resources.

TI's products are provided subject to [TI's Terms of Sale](#) or other applicable terms available either on ti.com or provided in conjunction with such TI products. TI's provision of these resources does not expand or otherwise alter TI's applicable warranties or warranty disclaimers for TI products.

TI objects to and rejects any additional or different terms you may have proposed.

Mailing Address: Texas Instruments, Post Office Box 655303, Dallas, Texas 75265
Copyright © 2022, Texas Instruments Incorporated