

**ABSTRACT**

This user's guide describes the characteristics, operation, and the use of the TPS55288EVM-045 evaluation module (EVM). The EVM contains the TPS55288, which is a high-performance, high-efficiency synchronous buck-boost converter that integrates two 16-A MOSFETs at the boost leg. The user's guide includes EVM specifications, recommended test setup, test result, schematic diagram, bill of materials, and the board layout.

Table of Contents

1 Introduction	2
1.1 Performance Specification.....	2
1.2 Modification.....	2
2 Connector, Test Point, and Jumper Descriptions	3
2.1 Connector and Test Point Descriptions.....	3
2.2 Jumper Configuration.....	3
3 Test Procedure	4
4 Software User Interface	5
4.1 Install USB2ANY Explorer.....	5
4.2 GUI Installation.....	5
4.3 Interface Hardware Setup.....	5
4.4 User Interface Operation.....	5
4.5 Register Map Screen.....	7
5 Schematic, Bill of Materials, and Board Layout	8
5.1 Schematic.....	8
5.2 Bill of Materials.....	8
5.3 Board Layout.....	11
6 Revision History	14

List of Figures

Figure 4-1. Quick Connection Overview.....	5
Figure 4-2. GUI Auto Connect Button.....	6
Figure 4-3. GUI Auto Connect Notification.....	6
Figure 4-4. GUI User Interface of TPS55288EVM-045.....	6
Figure 4-5. ENABLE Button.....	6
Figure 4-6. Output Current Limit Point Setting.....	7
Figure 4-7. GUI Register Map Screen.....	7
Figure 5-1. TPS55288EVM-045 Schematic.....	8
Figure 5-2. TPS55288EVM-045 Top-Side Layout.....	11
Figure 5-3. TPS55288EVM-045 Inner Layer1.....	12
Figure 5-4. TPS55288EVM-045 Inner Layer2.....	13
Figure 5-5. TPS55288EVM-045 Bottom-Side Layout.....	14

List of Tables

Table 1-1. Performance Specification Summary.....	2
Table 2-1. Connectors and Test Points.....	3
Table 5-1. Bill of Materials.....	8

Trademarks

All trademarks are the property of their respective owners.

1 Introduction

1.1 Performance Specification

Table 1-1 provides a summary of the TPS55288 EVM performance specifications. All specifications are given for an ambient temperature of 25°C.

Table 1-1. Performance Specification Summary

PARAMETER	TEST CONDITION	VALUE	UNIT
Input Voltage	N/A	2.7 – 36	V
Output Voltage	N/A	0.8 – 20	V
Maximum Output Current	$V_{IN} \geq 5\text{ V}, V_{OUT} = 10\text{ V}$	5	A
	$V_{IN} \geq 6\text{ V}, V_{OUT} = 12\text{ V}$		
	$V_{IN} \geq 12\text{ V}, V_{OUT} = 20\text{ V}$		
Default Switching Frequency	N/A	400	kHz

1.2 Modification

The printed-circuit board (PCB) for this EVM is designed to accommodate some modifications by the user. The external component can be changed according to the real application.

1.2.1 Modification

This EVM requires an appropriate I²C interface, such as the TI USB2ANY, to configure the TPS55288.

2 Connector, Test Point, and Jumper Descriptions

This section describes how to properly connect, set up, and use the TPS55288EVM-045.

2.1 Connector and Test Point Descriptions

This EVM includes I/O connectors and test points as shown in [Table 2-1](#). The power supply must be connected to input connectors, J1 and J2. The load must be connected to output connectors, J3 and J4.

Table 2-1. Connectors and Test Points

REFERENCE DESIGNATOR	DESCRIPTION
J1	Input voltage positive connection
J2	Input voltage return connection
J3	Output voltage connection
J4	Output voltage return connection
J7	I ² C connector

2.2 Jumper Configuration

2.2.1 JP1 (ENABLE)

The JP1 jumper enables the device. By default, this jumper is set to the ON position. Put this jumper in the OFF position to disable the output.

2.2.2 JP2 and JP3 (External Feedback and Internal Feedback Selection)

The JP2 jumper is for the external feedback or the internal feedback selection. By default, this jumper is set to the FB_INT position. Place this jumper in the FB_EXT position for the external output voltage feedback.

The JP3 jumper is for the external feedback connection. Place a jumper across JP3 when using external feedback. Left JP3 opens when uses internal feedback.

When using external output voltage feedback, the output voltage is determined by [Equation 1](#):

$$V_{\text{OUT}} = V_{\text{REF}} \times \left(1 + \frac{R_{\text{FB_UP}}}{R_{\text{FB_BT}}} \right) \quad (1)$$

It is recommended to use 100 kΩ for the up resistor RFB_UP. The reference voltage VREF at the FB/INT pin is programmable from 45 mV to 1.2 V by writing a 10-bit data into the register 00H and 01H.

2.2.3 JP4 (SYNC)

The JP4 jumper is for the frequency dithering selection. Placing a jumper across JP4 disables the frequency dithering function. Left JP4 opens when using frequency dithering function.

3 Test Procedure

Step 1: Set the power supply current limit to 20 A. Set the power supply to approximately 10 V. Turn off the power supply. Connect the positive output of the power supply to J1 and the negative output to J2.

Step 2: Connect the load to J3 for the positive connection and connect the load J4 for the negative connection.

Step 3: Turn on the power supply.

Step 4: Enable the IC with the GUI. The default output voltage is 5 V.

Step 5: Set the output voltage to the target value on the GUI user interface page.

Step 6: Slowly increase the load while monitoring the output voltage between J3 and J4. It must remain in regulation when the load current is lower than 5 A.

Step 7: Slowly sweep the input voltage from 5 V to 20 V. The output voltage must remain in regulation when the load current is lower than the maximum load current specified in [Table 2-1](#).

Step 8: Turn off the load and power supply. Then, turn on the load to discharge the output capacitors.

4 Software User Interface

4.1 Install USB2ANY Explorer

Download and install the USB2ANY explorer from: <http://www.ti.com/tool/USB2ANY>. Upgrade the firmware version to 2.8.2.0.

4.2 GUI Installation

A graphical user interface (GUI) is available from on <http://www.ti.com/tool/TPS55288-EVM-GUI>. The GUI allows simple and convenient programming of the device through the TI USB2ANY device.

- Download the zip file for the desired platform.
- Download GUI Composer Runtime.
- Extract the zip folder and install the GUI.
- Run through the installation steps. The installation wizard might prompt for GUI Composer Runtime. This should be done automatically.
- Open the GUI – TPS55288.

4.3 Interface Hardware Setup

Connect the USB2ANY adapter to your PC using the supplied USB cable. Connect the TPS55288EVM connector J7 to the USB2ANY adapter using the supplied 10-pin ribbon cable. The connectors on the ribbon cable are keyed to prevent incorrect installation.

Figure 4-1 shows a quick connection overview.

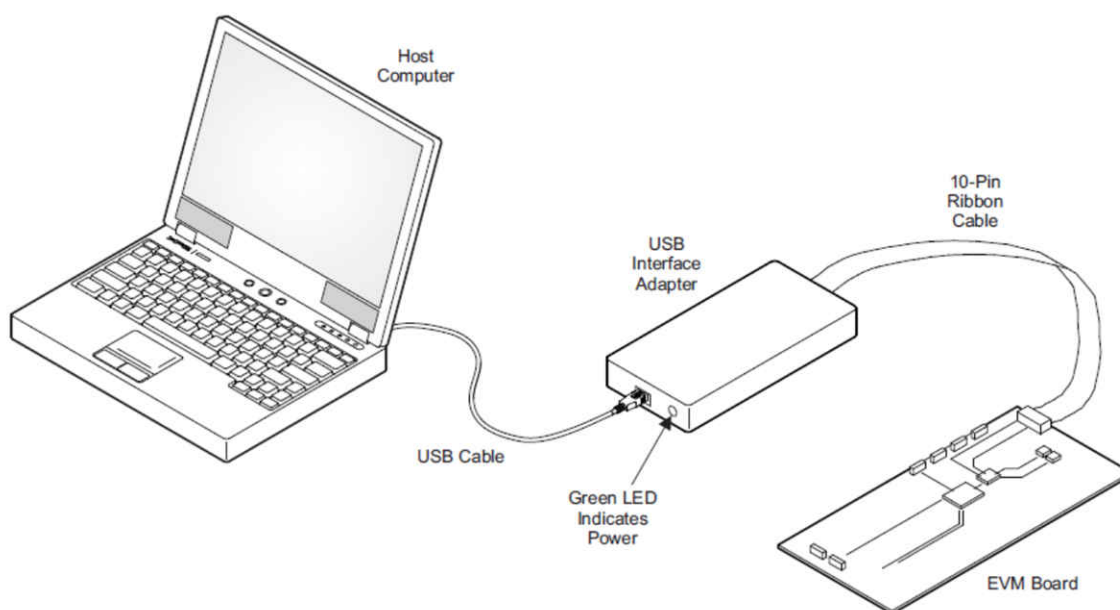

Figure 4-1. Quick Connection Overview

4.4 User Interface Operation

The TPS55288EVM board can be enabled to work by the following steps:

Step 1: Set JP1 to the ON position. Turn on the power supply.

Step 2: Open the TPS55288EVM GUI.

Step 3: Click the auto connect button on the slave address widget (Figure 4-2). It will automatically check for slave addresses (0x74, 0x75) and connect the GUI with the device. After the GUI and device are connected, the GUI reads all eight registers and shows a notification (Figure 4-3).

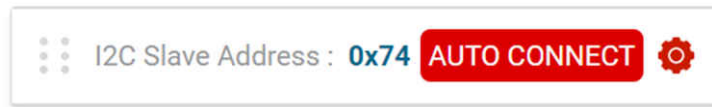

Figure 4-2. GUI Auto Connect Button



Figure 4-3. GUI Auto Connect Notification

Step 4: Click the start button. It will show the GUI user interface of TPS55288EVM-045 (Figure 4-4).

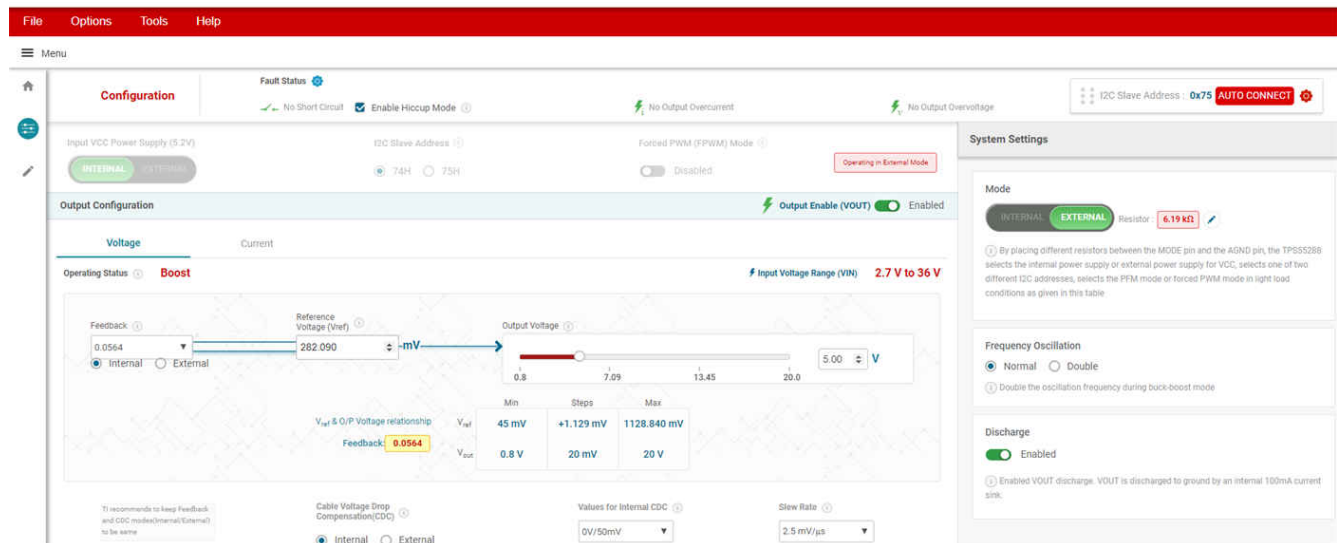

Figure 4-4. GUI User Interface of TPS55288EVM-045

Step 5: Click the Enable button (Figure 4-5). The default output voltage is 5 V.

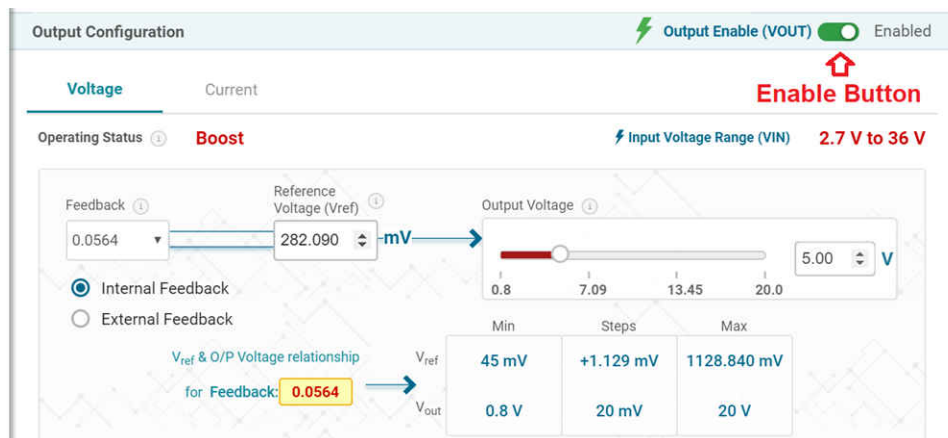
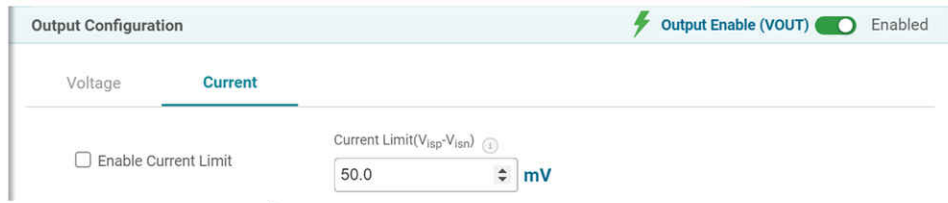

Figure 4-5. ENABLE Button

Step 6: Set the output voltage, current limit point, and so forth according to the design target. If the maximum load current is ≥ 5 A, uncheck the 'Enable Current Limit' check box or increase the current limit value (Figure 4-6).



When Iout >=5A:
untick the 'Enable Current Limit' check box
or
increase the current limit value

Figure 4-6. Output Current Limit Point Setting

4.5 Register Map Screen

The Register Map screen shows a register-wise view of all parameters. Here, single registers can be read or written to the device (if applicable). Refer to the [TPS55288 36-V, 16-A Buck-Boost Converter with I²C Interface Data Sheet](#) for a detailed description of the TPS55288 registers.

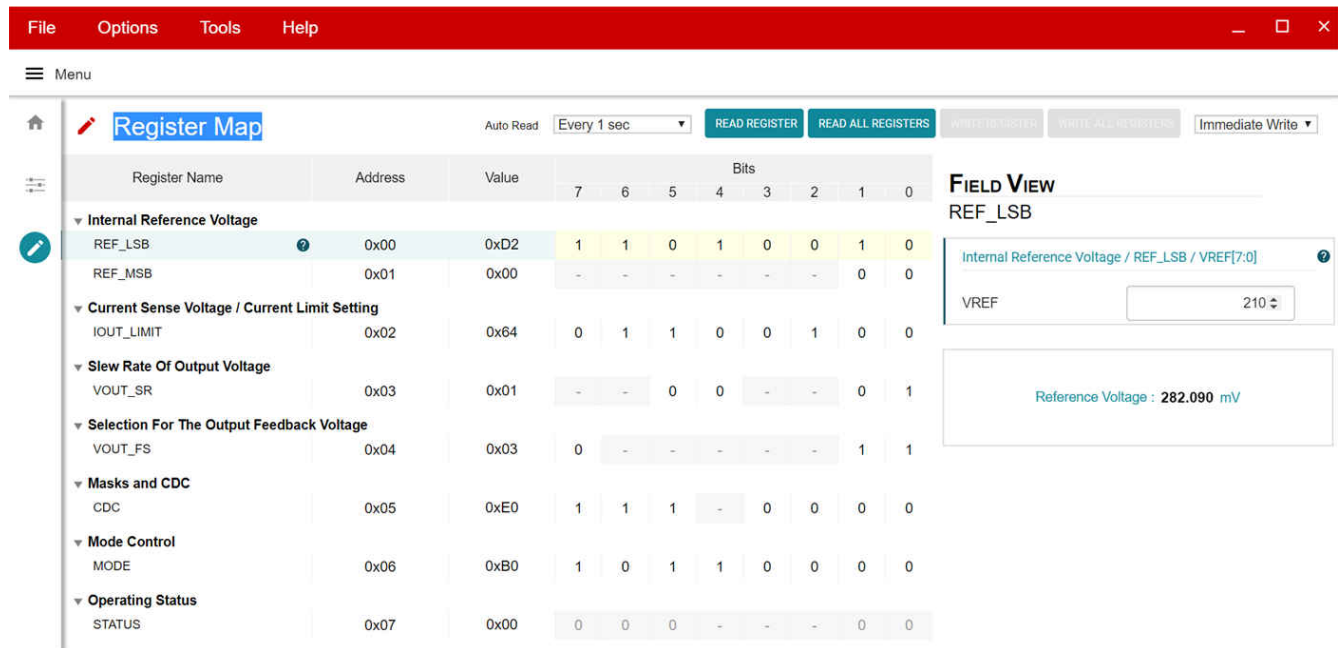

Figure 4-7. GUI Register Map Screen

5 Schematic, Bill of Materials, and Board Layout

This section provides the TPS55288EVM-045 schematic, bill of materials (BOM), and board layout.

5.1 Schematic

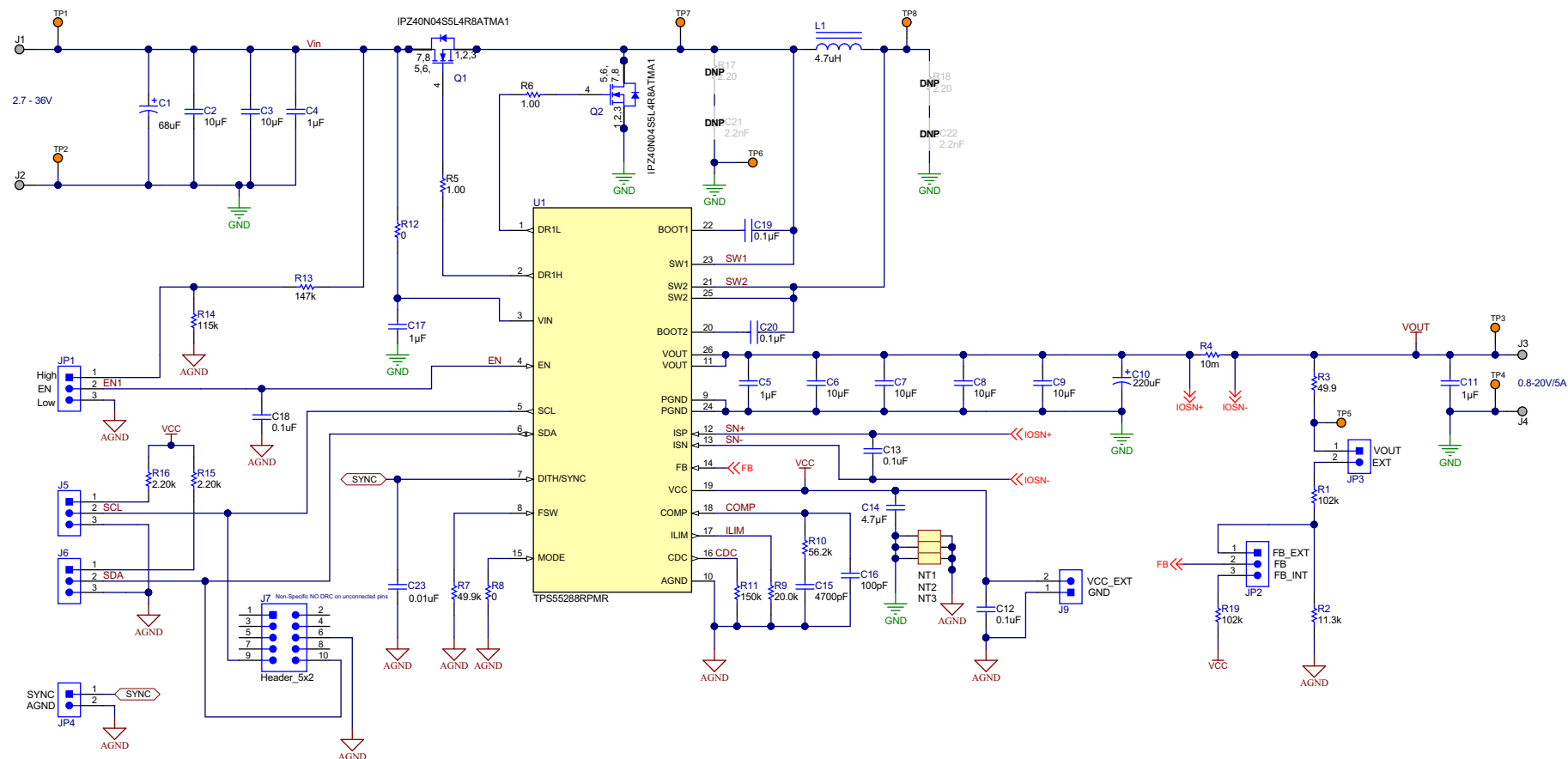

Figure 5-1. TPS55288EVM-045 Schematic

5.2 Bill of Materials

Table 5-1. Bill of Materials

DESIGNATOR	QTY	VALUE	DESCRIPTION	PACKAGE	PART NUMBER	MANUFACTURER
C1	1	68 µF	CAP, Polymer Hybrid, 68 µF, 50 V, ±20%, 30 Ω, 8 × 10 SMD	8 × 10	EEHZA1H680P	Panasonic

Table 5-1. Bill of Materials (continued)

DESIGNATOR	QTY	VALUE	DESCRIPTION	PACKAGE	PART NUMBER	MANUFACTURER
C2, C3	2	10 μ F	CAP, CERM, 10 μ F, 75 V, \pm 20%, X7R, AEC-Q200 Grade 1, 1210	1210	CGA6P1X7R1N106 M250AC	TDK
C4, C5, C11, C17	4	1 μ F	CAP, CERM, 1 μ F, 50 V, \pm 20%, X5R, AEC-Q200 Grade 3, 0603	0603	GRT188R61H105ME 13D	MuRata
C6, C7, C8, C9	4	10 μ F	CAP, CERM, 10 μ F, 50 V, \pm 10%, X7R, AEC-Q200 Grade 1, 1206	1206	CGA5L1X7R1H106K 160AC	TDK
C10	1	220 μ F	CAP, Polymer Hybrid, 220 μ F, 25 V, \pm 20%, 27 Ω , 8 \times 10 SMD	8 \times 10	EEHZA1E221P	Panasonic
C12, C13, C18	3	0.1 μ F	CAP, CERM, 0.1 μ F, 50 V, \pm 10%, X7R, AEC-Q200 Grade 1, 0402	0402	CGA2B3X7R1H104K 050BB	TDK
C14	1	4.7 μ F	CAP, CERM, 4.7 μ F, 16 V, \pm 10%, X5R, AEC-Q200 Grade 3, 0603	0603	GRT188R61C475KE 13D	MuRata
C15	1	4700 pF	CAP, CERM, 4700 pF, 50 V, \pm 10%, X7R, AEC-Q200 Grade 1, 0402	0402	CGA2B2X7R1H472K 050BA	TDK
C16	1	100 pF	CAP, CERM, 100 pF, 50 V, \pm 5%, C0G/ NP0, AEC-Q200 Grade 1, 0402	0402	CGA2B2C0G1H101J 050BA	TDK
C19, C20	2		0.1 μ F \pm 10% 50-V Ceramic Capacitor X8L 0603 (1608 Metric)	0603	GCM188L81H104KA 57D	Murata Electronics North America
C23	1	0.01 μ F	CAP, CERM, 0.01 μ F, 50 V, \pm 10%, X7R, AEC-Q200 Grade 1, 0402	0402	CGA2B3X7R1H103K 050BB	TDK
J1, J2, J3, J4	4		Terminal, Turret, TH, Double	Keystone 1502-2	1502-2	Keystone
J5, J6, JP1, JP2	4		Header, 100 mil, 3 \times 1, Tin, TH	Header, 3 PIN, 100 mil, Tin	PEC03SAAN	Sullins Connector Solutions
J7	1		Header (shrouded), 100 mil, 5 \times 2, Gold, TH	5 \times 2 Shrouded header	5103308-1	TE Connectivity
J9, JP3, JP4	3		Header, 100 mil, 2 \times 1, Tin, TH	Header, 2 PIN, 100 mil, Tin	PEC02SAAN	Sullins Connector Solutions
L1	1	4.7 μ H	Inductor, Shielded, Composite, 4.7 μ H, 24 A, 0.01 Ω , SMD	Inductor, 11.3 \times 10 \times 10 mm	XAL1010-472MEB	Coilcraft
Q1, Q2	2	40 V	MOSFET, N-CH, 40 V, 40 A, AEC-Q101, SON-8	SON-8	IPZ40N04S5L4R8AT MA1	Infineon Technologies
R1, R19	2	102 k	RES, 102 k, 1%, 0.063 W, AEC-Q200 Grade 0, 0402	0402	CRCW0402102KFKE D	Vishay-Dale
R2	1	11.3 k	RES, 11.3 k, 1%, 0.063 W, AEC-Q200 Grade 0, 0402	0402	CRCW040211K3FKE D	Vishay-Dale
R3	1	49.9	RES, 49.9, 1%, 0.063 W, AEC-Q200 Grade 0, 0402	0402	CRCW040249R9FK ED	Vishay-Dale

Table 5-1. Bill of Materials (continued)

DESIGNATOR	QTY	VALUE	DESCRIPTION	PACKAGE	PART NUMBER	MANUFACTURER
R4	1		10 mΩ ±1% 1-W Chip Resistor 1206 (3216 Metric) Automotive AEC-Q200, Current Sense, Moisture Resistant Metal Element	1206	CRF1206-FZ-R010ELF	Bourns
R5, R6	2	1.00	RES, 1.00, 1%, 0.1 W, AEC-Q200 Grade 0, 0603	0603	CRCW06031R00FKEA	Vishay-Dale
R7	1	49.9 k	RES, 49.9 k, 1%, 0.063 W, AEC-Q200 Grade 0, 0402	0402	CRCW040249K9FKE D	Vishay-Dale
R8	1	0	RES, 0, 5%, 0.063 W, AEC-Q200 Grade 0, 0402	0402	CRCW04020000Z0E D	Vishay-Dale
R9	1	20.0 k	RES, 20.0 k, 1%, 0.063 W, AEC-Q200 Grade 0, 0402	0402	CRCW040220K0FKE D	Vishay-Dale
R10	1	56.2 k	RES, 56.2 k, 1%, 0.063 W, AEC-Q200 Grade 0, 0402	0402	CRCW040256K2FKE D	Vishay-Dale
R11	1	150 k	RES, 150 k, 1%, 0.063 W, AEC-Q200 Grade 0, 0402	0402	CRCW0402150KFKE D	Vishay-Dale
R12	1	0	RES, 0, 5%, 0.063 W, AEC-Q200 Grade 0, 0402	0402	CRCW04020000Z0E D	Vishay-Dale
R13	1	147 k	RES, 147 k, 1%, 0.1 W, 0603	0603	RC0603FR-07147KL	Yageo
R14	1	115 k	RES, 115 k, 1%, 0.063 W, AEC-Q200 Grade 0, 0402	0402	CRCW0402115KFKE D	Vishay-Dale
R15, R16	2	2.20 k	RES, 2.20 k, 1%, 0.063 W, AEC-Q200 Grade 0, 0402	0402	CRCW04022K20FKE D	Vishay-Dale
TP1, TP2, TP3, TP4, TP5, TP6, TP7, TP8	8		Test Point, Miniature, Orange, TH	Orange Miniature Testpoint	5003	Keystone
U1	1		36 V, 16-A Buck-Boost Converter, RPM0026A (VQFN-HR-26)	RPM0026A	TPS55288dev	Texas Instruments
C21, C22	0	2200 pF	CAP, CERM, 2200 pF, 250 V, ± 10%, X7R, 0805	0805	GRM21AR72E222K W01D	MuRata
R17, R18	0	2.20	RES, 2.20, 1%, 0.25 W, AEC-Q200 Grade 0, 1206	1206	ERJ-8RQF2R2V	Panasonic

5.3 Board Layout

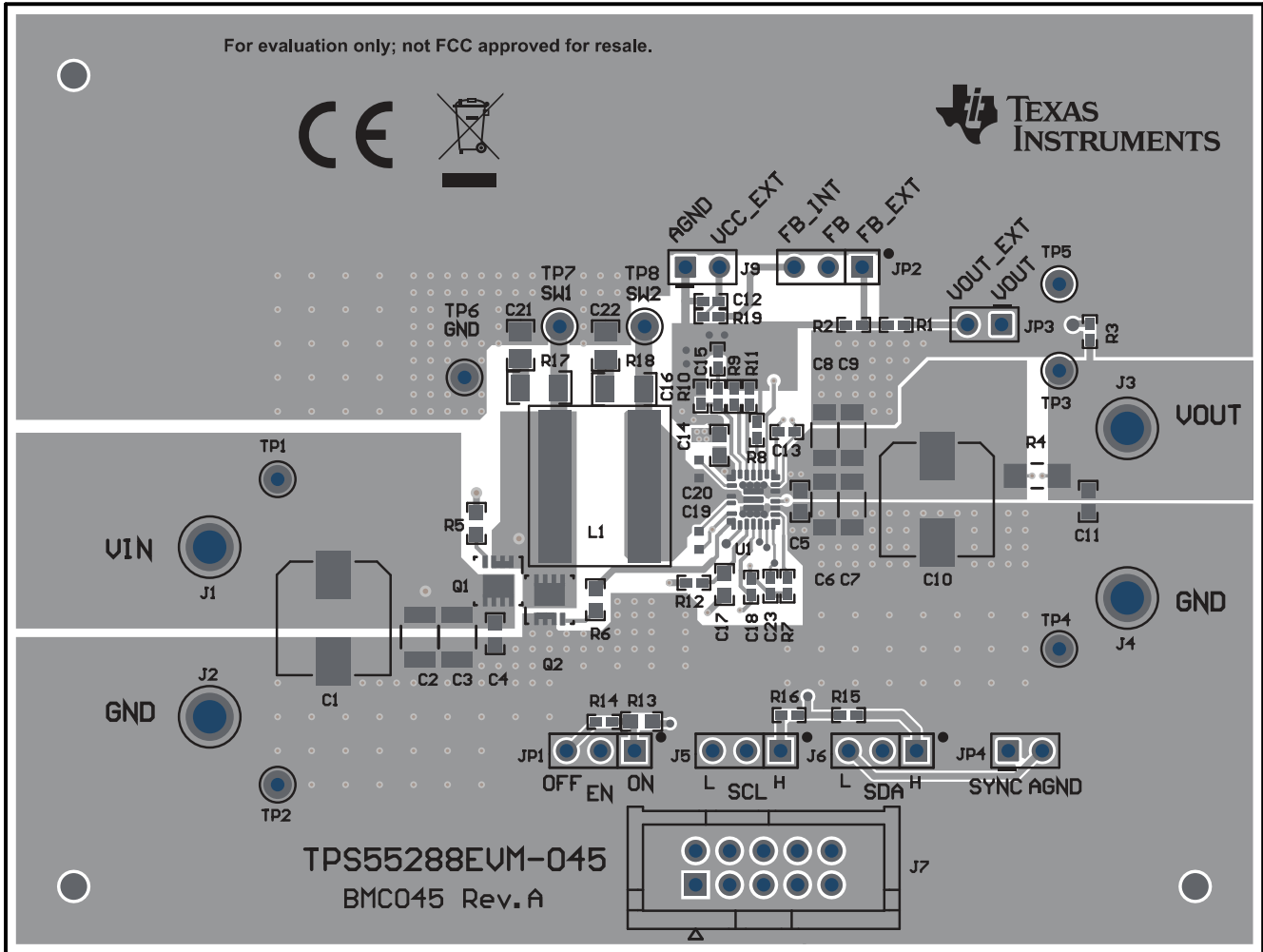

Figure 5-2. TPS55288EVM-045 Top-Side Layout

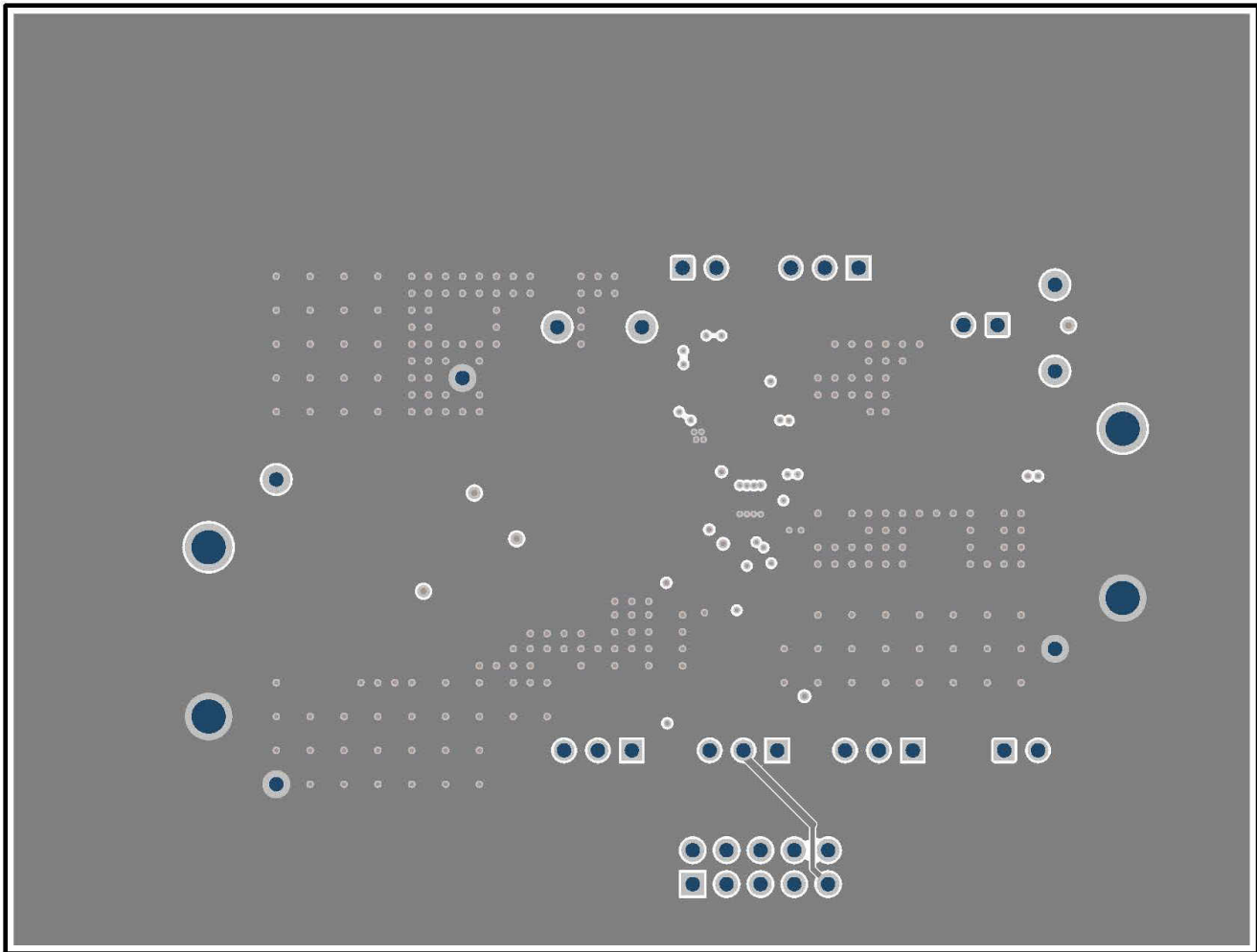

Figure 5-3. TPS55288EVM-045 Inner Layer1

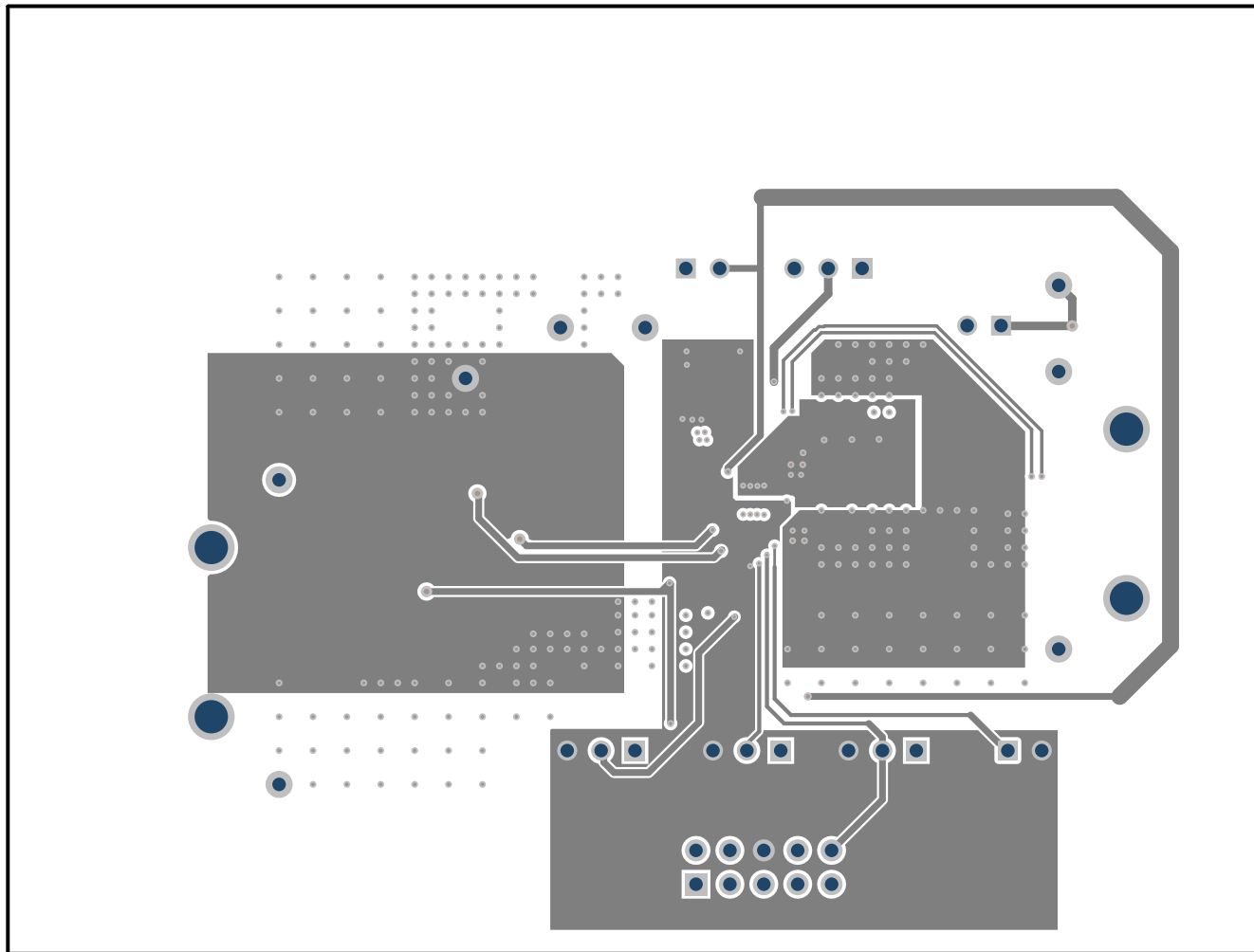

Figure 5-4. TPS55288EVM-045 Inner Layer2

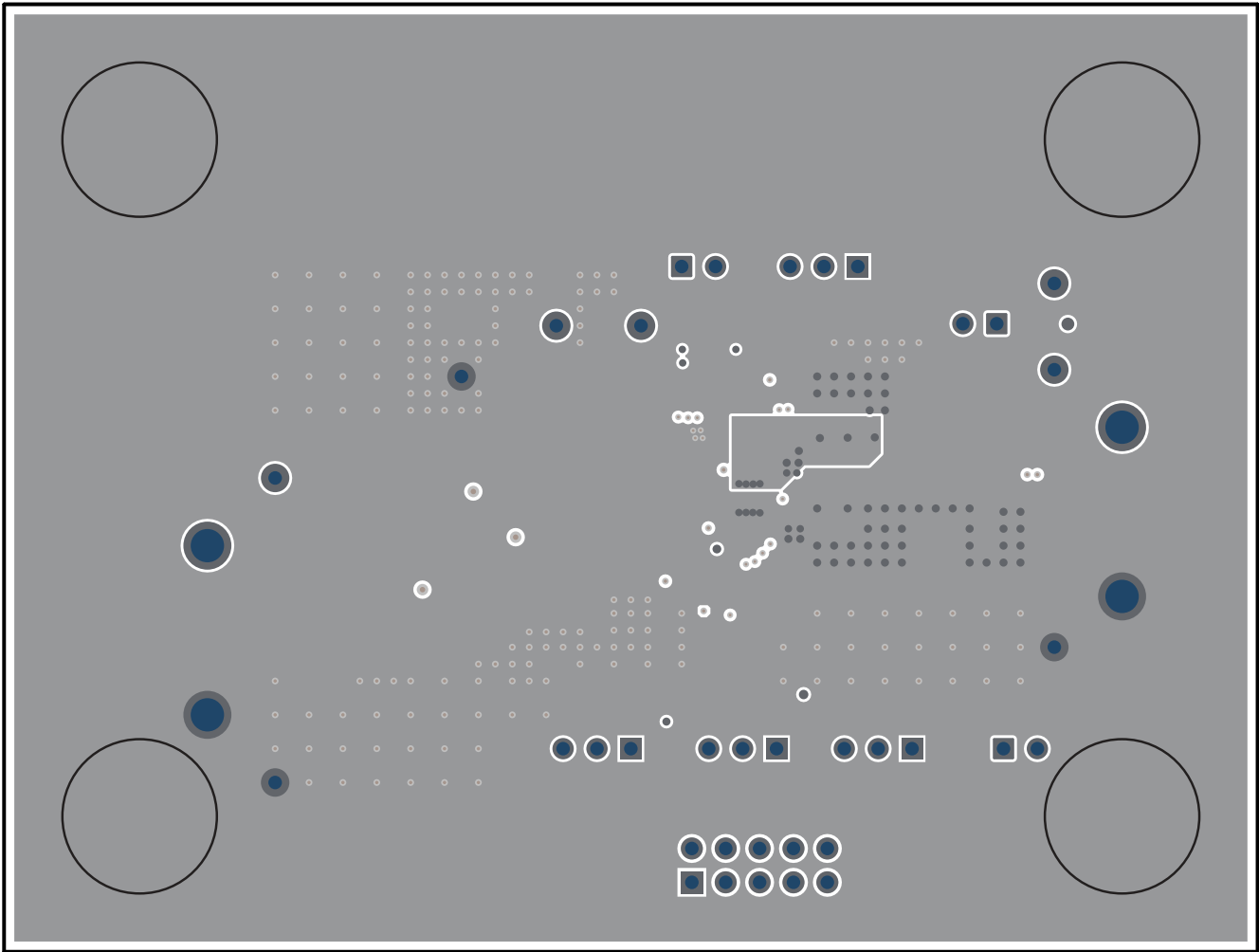

Figure 5-5. TPS55288EVM-045 Bottom-Side Layout

6 Revision History

NOTE: Page numbers for previous revisions may differ from page numbers in the current version.

Changes from Revision A (August 2020) to Revision B (September 2021)		Page
• Updated schematic layout.....		8
• Updated Bill of Materials.....		8
Changes from Revision * (February 2020) to Revision A (August 2020)		Page
• Updated TPS55288EVM-045 Inner Layer 2 image.....		11
• Updated TPS55288EVM-045 Bottom-Side Layout image.....		11

IMPORTANT NOTICE AND DISCLAIMER

TI PROVIDES TECHNICAL AND RELIABILITY DATA (INCLUDING DATASHEETS), DESIGN RESOURCES (INCLUDING REFERENCE DESIGNS), APPLICATION OR OTHER DESIGN ADVICE, WEB TOOLS, SAFETY INFORMATION, AND OTHER RESOURCES "AS IS" AND WITH ALL FAULTS, AND DISCLAIMS ALL WARRANTIES, EXPRESS AND IMPLIED, INCLUDING WITHOUT LIMITATION ANY IMPLIED WARRANTIES OF MERCHANTABILITY, FITNESS FOR A PARTICULAR PURPOSE OR NON-INFRINGEMENT OF THIRD PARTY INTELLECTUAL PROPERTY RIGHTS.

These resources are intended for skilled developers designing with TI products. You are solely responsible for (1) selecting the appropriate TI products for your application, (2) designing, validating and testing your application, and (3) ensuring your application meets applicable standards, and any other safety, security, regulatory or other requirements.

These resources are subject to change without notice. TI grants you permission to use these resources only for development of an application that uses the TI products described in the resource. Other reproduction and display of these resources is prohibited. No license is granted to any other TI intellectual property right or to any third party intellectual property right. TI disclaims responsibility for, and you fully indemnify TI and its representatives against any claims, damages, costs, losses, and liabilities arising out of your use of these resources.

TI's products are provided subject to [TI's Terms of Sale](#), [TI's General Quality Guidelines](#), or other applicable terms available either on [ti.com](#) or provided in conjunction with such TI products. TI's provision of these resources does not expand or otherwise alter TI's applicable warranties or warranty disclaimers for TI products. Unless TI explicitly designates a product as custom or customer-specified, TI products are standard, catalog, general purpose devices.

TI objects to and rejects any additional or different terms you may propose.

Copyright © 2026, Texas Instruments Incorporated

Last updated 10/2025