

TPS54332 Step-Down Converter Evaluation Module User's Guide



Table of Contents

1 Introduction	2
1.1 Background.....	2
1.2 Performance Specification Summary.....	2
1.3 Modifications.....	3
2 Test Setup and Results	4
2.1 Input and Output Connections.....	4
2.2 Efficiency.....	4
2.3 Output Voltage Load Regulation.....	5
2.4 Output Voltage Line Regulation.....	7
2.5 Load Transients.....	7
2.6 Loop Characteristics.....	8
2.7 Output Voltage Ripple.....	8
2.8 Input Voltage Ripple.....	9
2.9 Powering Up.....	9
2.10 Eco-mode Operation.....	10
3 Board Layout	11
3.1 Layout.....	11
3.2 Estimated Circuit Area.....	12
4 Schematic and Bill of Materials	13
4.1 Schematic.....	13
4.2 Bill of Materials.....	14
5 Revision History	14

List of Figures

Figure 2-1. TPS54332EVM-416 Efficiency.....	5
Figure 2-2. TPS54332EVM-416 Low Current Efficiency.....	5
Figure 2-3. TPS54332EVM-416 Load Regulation.....	6
Figure 2-4. TPS54332EVM-416 Line Regulation.....	7
Figure 2-5. TPS54332EVM-416 Transient Response.....	7
Figure 2-6. TPS54332EVM-416 Loop Response.....	8
Figure 2-7. TPS54332EVM-416 Output Ripple.....	8
Figure 2-8. TPS54332EVM-416 Input Ripple.....	9
Figure 2-9. TPS54332EVM-416 Start-Up Relative to V_{IN}	9
Figure 2-10. TPS54332EVM-416 Eco-mode Operation.....	10
Figure 3-1. TPS54332EVM-416 Top-Side Layout.....	11
Figure 3-2. TPS54332EVM-416 Bottom-Side Layout.....	12
Figure 3-3. TPS54332EVM-416 Top-Side Assembly.....	12
Figure 4-1. TPS54332EVM-416 Schematic.....	13

List of Tables

Table 1-1. Input Voltage and Output Current Summary.....	2
Table 1-2. TPS54332EVM-416 Performance Specification Summary.....	2
Table 1-3. Output Voltages Available.....	3
Table 2-1. EVM Connectors and Test Points.....	4
Table 4-1. TPS54332EVM-416 Bill of Materials.....	14

Trademarks

All trademarks are the property of their respective owners.

1 Introduction

This user's guide contains background information for the TPS54332 as well as support documentation for the TPS54332EVM-416 evaluation module (HPA416). This document also includes the performance specifications, the schematic, and the bill of materials for the TPS54332EVM-416.

1.1 Background

The TPS54332 DC/DC converter is designed to provide up to a 3.5-A output from an input voltage source of 3.5 V to 28 V. [Table 1-1](#) provides the rated input voltage and output current range. This evaluation module is designed to demonstrate the small printed-circuit-board areas that can be achieved when designing with the TPS54332 regulator. The switching frequency is internally set at a nominal 1000 kHz. The high-side MOSFET is incorporated inside the TPS54332 package along with the gate drive circuitry. The low drain-to-source on resistance of the MOSFET allows the TPS54332 to achieve high efficiencies and helps keep the junction temperature low at high output currents. The compensation components are external to the integrated circuit (IC), and an external divider allows for an adjustable output voltage. Additionally, the TPS54332 provides adjustable slow start and undervoltage lockout inputs. The absolute maximum input voltage is 30 V for the TPS54332EVM-416.

Table 1-1. Input Voltage and Output Current Summary

EVM	Input Voltage Range	Output Current Range
TPS54332EVM-416	$V_{IN} = 5\text{ V to }15\text{ V}$	0 A to 3.5 A

1.2 Performance Specification Summary

[Table 1-2](#) provides a summary of the TPS54332EVM-416 performance specifications. Specifications are given for an input voltage of $V_{IN} = 12\text{ V}$ and an output voltage of 2.5 V, unless otherwise specified. The TPS54332EVM-416 is designed and tested for $V_{IN} = 7\text{ V to }28\text{ V}$. The ambient temperature is 25°C for all measurements, unless otherwise noted.

Table 1-2. TPS54332EVM-416 Performance Specification Summary

Specification	Test Conditions	MIN	TYP	MAX	Unit
V_{IN} voltage range		5	12	15	V
Output voltage set point			2.5		V
Output current range	$V_{IN} = 5\text{ V to }15\text{ V}$	0		3.5	A
Line regulation	$I_O = 1\text{ A}, V_{IN} = 5\text{ V to }15\text{ V}$		±0.16%		
Load regulation	$V_{IN} = 12\text{ V}, I_O = 0.2\text{ A to }3.5\text{ A}$		±0.10%		
Load transient response	$I_O = 0.75\text{ A to }2.5\text{ A}$	Voltage change		-10	mV
		Recovery time		400	µs
	$I_O = 2.5\text{ A to }0.75\text{ A}$	Voltage change		10	mV
		Recovery time		400	µs
Loop bandwidth	$V_{IN} = 12\text{ V}, I_O = 3.5\text{ A}$		42		kHz
Phase margin	$V_{IN} = 12\text{ V}, I_O = 3.5\text{ A}$		45		°
Input ripple voltage	$I_O = 3.5\text{ A}$		110		mVpp
Output ripple voltage	$I_O = 3.5\text{ A}$		10		mVpp
Output rise time			6		ms
Operating frequency			1000		kHz
Maximum efficiency	TPS54332EVM-416, $V_{IN} = 5\text{ V}, I_O = 0.5\text{ A}$		89%		

1.3 Modifications

These evaluation modules are designed to provide access to the features of the TPS54332. Some modifications can be made to this module.

1.3.1 Output Voltage Set Point

To change the output voltage of the EVM, change the value of resistor R_6 . Changing the value of R_6 can change the output voltage above 0.8 V. The value of R_6 for a specific output voltage can be calculated using [Equation 1](#).

$$R_6 = 10.2 \text{ k}\Omega \times \frac{0.8 \text{ V}}{V_{\text{OUT}} - 0.8 \text{ V}} \quad (1)$$

[Table 1-3](#) lists the R_6 values for some common output voltages. Note that V_{IN} must be in a range so that the minimum on time is greater than 130 ns, and the maximum duty cycle is less than 91%. The values given in [Table 1-3](#) are standard values, not the exact value calculated using [Equation 1](#). Changing the output voltage from 2.5 V effectively changes the output impedance, which affects the loop response. It can be necessary to modify the compensation component values. See the [TPS54332 3-A, 28-V Input Step-Down DC/DC Converter with Eco-mode](#) data sheet for details.

Table 1-3. Output Voltages Available

Output Voltage (V)	R_6 Value (k Ω)
1.8	8.25
2.5	4.75
3.3	3.24
5	1.96

2 Test Setup and Results

This section describes how to properly connect, set up, and use the TPS54332EVM-416 evaluation module. The section also includes test results typical for the evaluation module and covers the following:

- Efficiency
- Output voltage regulation
- Load transients
- Loop response
- Output ripple
- Input ripple
- Start-up

2.1 Input and Output Connections

The TPS54332EVM-416 is provided with input and output connectors and test points as shown in [Table 2-1](#). A power supply capable of supplying 3 A must be connected to J1 through a pair of 20 AWG wires. The load must be connected to J4 through a pair of 20 AWG wires. The maximum load current capability must be 3.5 A. Wire lengths must be minimized to reduce losses in the wires. Test point TP1 provides a place to monitor the V_{IN} input voltages with TP2 providing a convenient ground reference. TP5 is used to monitor the output voltage with TP6 as the ground reference.

Table 2-1. EVM Connectors and Test Points

Reference Designator	Function
J1	V_{IN} (see Table 1-1 for V_{IN} range)
J2	2-pin header for enable. Connect EN to ground to disable, open to enable.
J3	2-pin header for slow start monitor and GND
J4	V_{OUT} , 2.5 V at 3.5 A maximum
TP1	V_{IN} test point at V_{IN} connector
TP2	GND test point at V_{IN}
TP3	PH test point
TP4	Test point between voltage divider network and output. Used for loop response measurements.
TP5	Output voltage test point at OUT connector
TP6	GND test point at OUT connector

2.2 Efficiency

The efficiency of this EVM peaks at a load current of about 0.5 A and 5-V input, then decreases as the load current increases towards full load. [Figure 2-1](#) shows the efficiency for the TPS54332EVM-416 at an ambient temperature of 25°C.

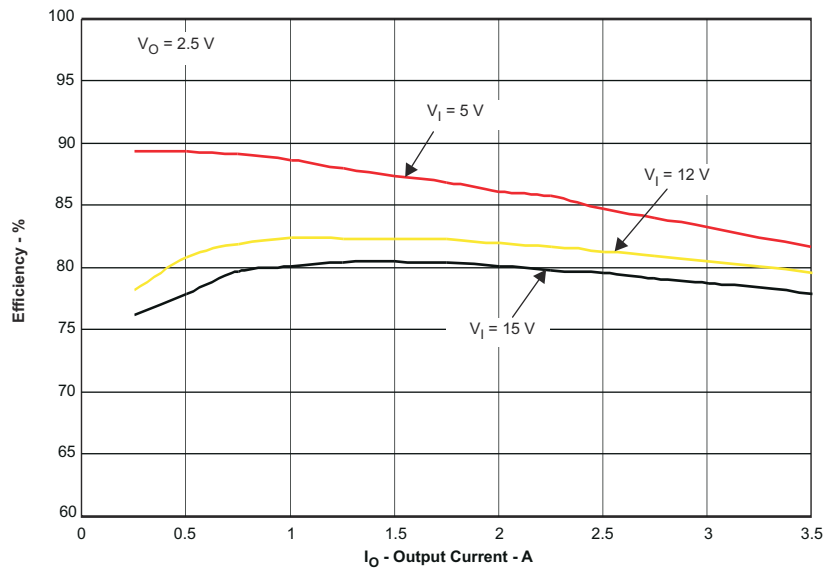

Figure 2-1. TPS54332EVM-416 Efficiency

Figure 2-2 shows the efficiency for the TPS54332EVM-416 at lower output currents between 0.025 A and 0.250 A at an ambient temperature of 25°C.

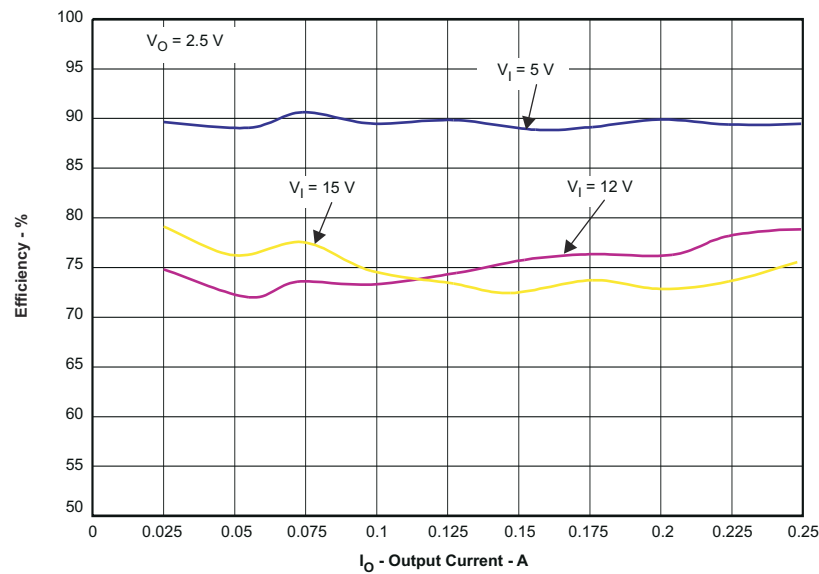

Figure 2-2. TPS54332EVM-416 Low Current Efficiency

The efficiency can be lower at higher ambient temperatures, due to temperature variation in the drain-to-source resistance of the internal MOSFET.

2.3 Output Voltage Load Regulation

Figure 2-3 shows the load regulation for the TPS54332EVM-416.

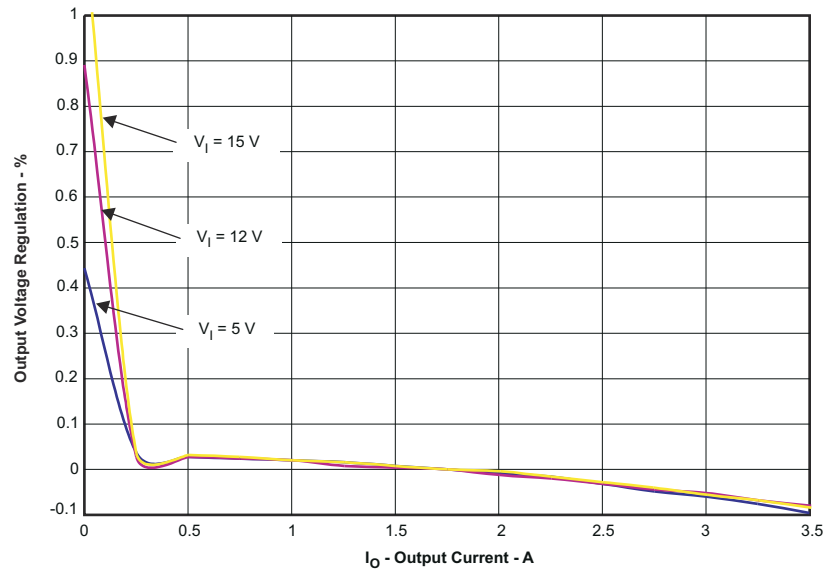

Figure 2-3. TPS54332EVM-416 Load Regulation

Measurements are given for an ambient temperature of 25°C.

2.4 Output Voltage Line Regulation

Figure 2-4 shows the line regulation for the TPS54332EVM-416.

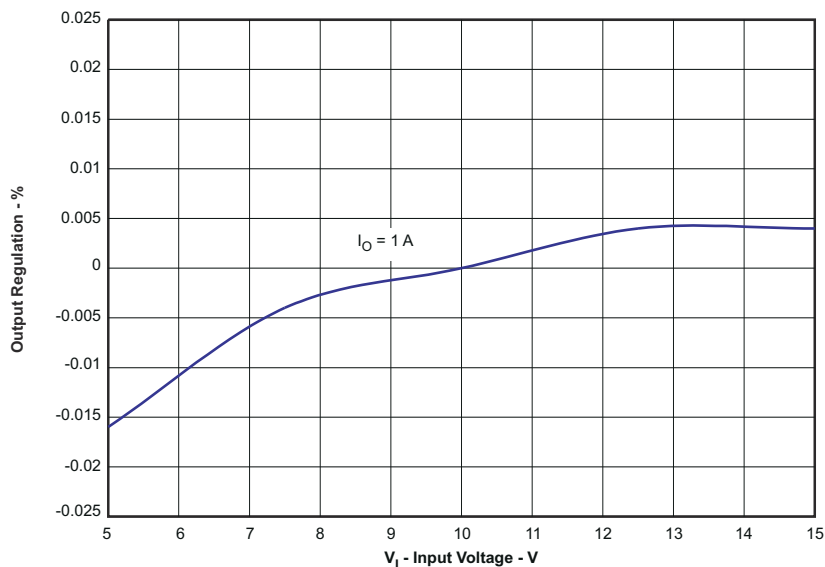

Figure 2-4. TPS54332EVM-416 Line Regulation

2.5 Load Transients

Figure 2-5 shows the TPS54332EVM-416 response to load transients. The current step is from 0.75 A to 2.5 A at 12-V input. Total peak-to-peak voltage variation is as shown, including ripple and noise on the output.

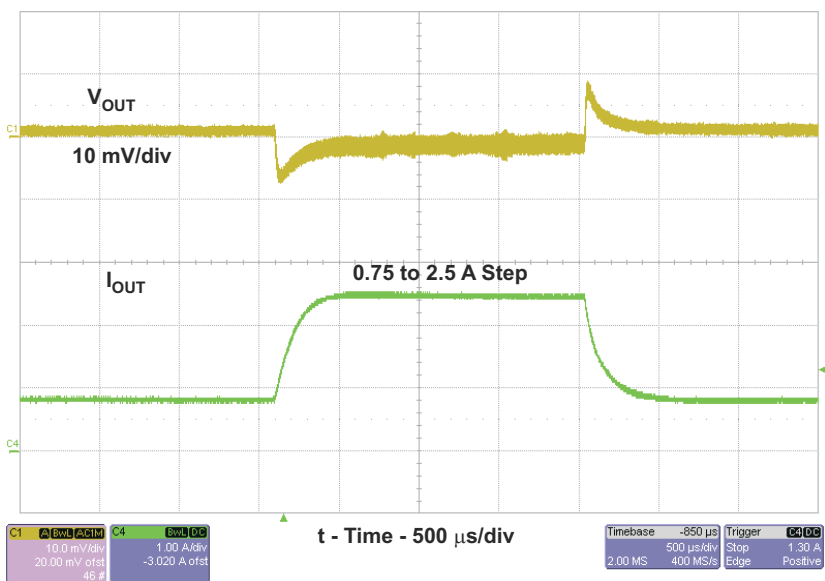

Figure 2-5. TPS54332EVM-416 Transient Response

2.6 Loop Characteristics

Figure 2-6 shows the TPS54332EVM-416 loop response characteristics. Gain and phase plots are shown for V_{IN} voltage of 12 V. Load current for the measurement is 3.5 A.

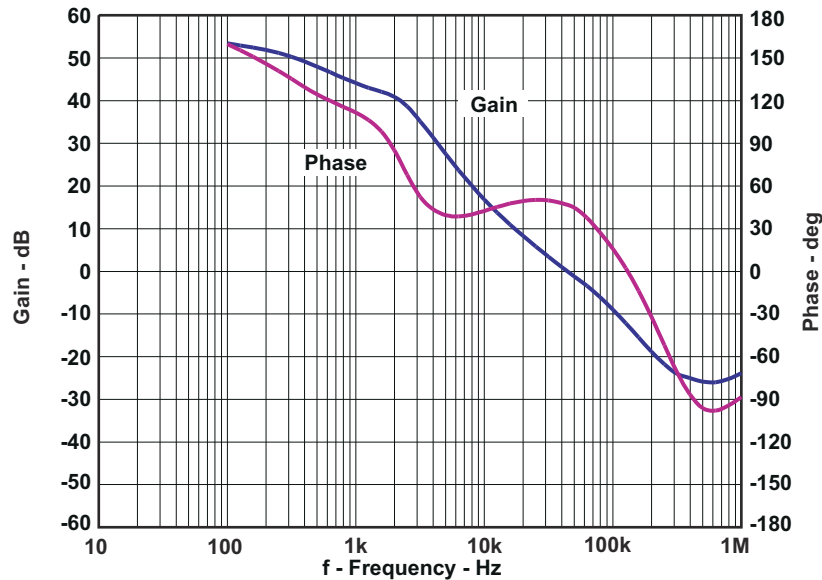

Figure 2-6. TPS54332EVM-416 Loop Response

2.7 Output Voltage Ripple

Figure 2-7 shows the TPS54332EVM-416 output voltage ripple. The output current is the rated full load of 3.5 A and $V_{IN} = 12$ V. The ripple voltage is measured directly across the output capacitors.

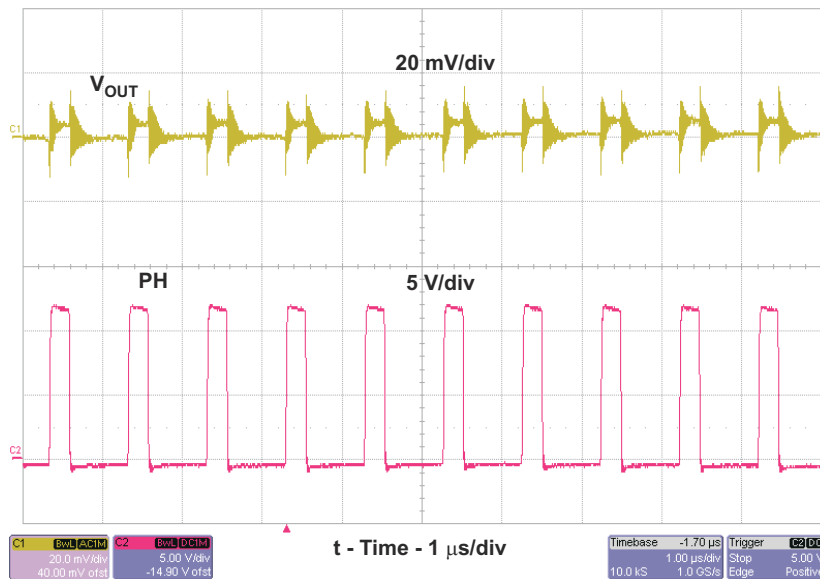

Figure 2-7. TPS54332EVM-416 Output Ripple

2.8 Input Voltage Ripple

Figure 2-8 shows the TPS54332EVM-416 input voltage ripple. The output current is the rated full load of 3.5 A and $V_{IN} = 12$ V. The ripple voltage is measured directly across the input capacitors.

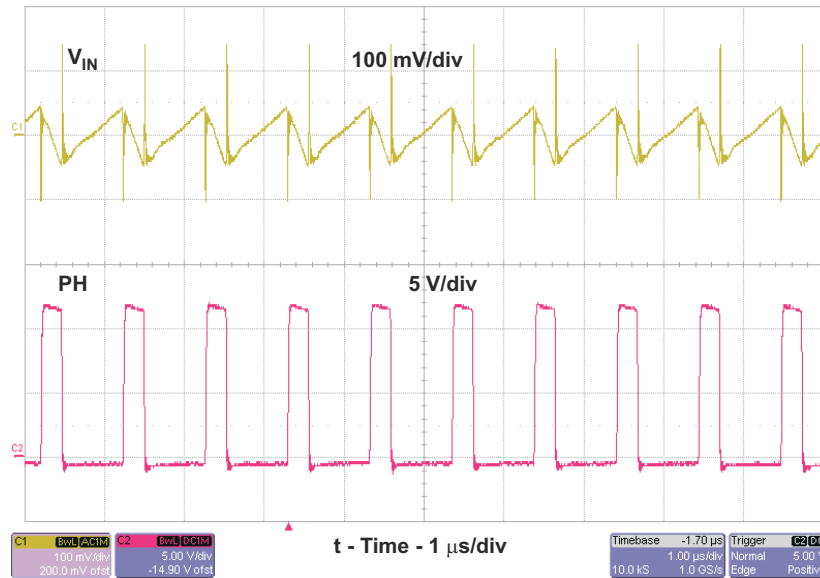

Figure 2-8. TPS54332EVM-416 Input Ripple

2.9 Powering Up

Figure 2-9 shows the start-up waveform. The top trace shows V_{OUT} and the bottom trace shows V_{IN} . The input voltage is 12 V and there is no load.

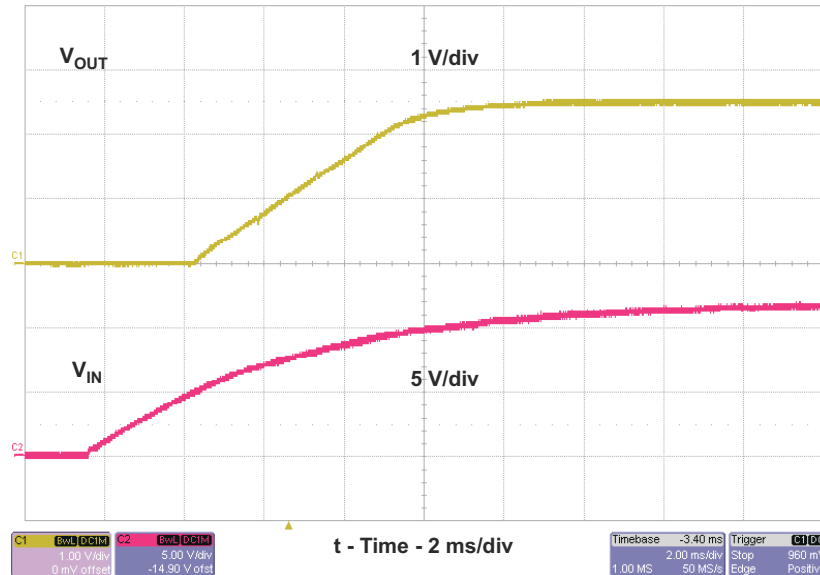

Figure 2-9. TPS54332EVM-416 Start-Up Relative to V_{IN}

2.10 Eco-mode Operation

At light load currents, the TPS54332 is designed to operate in pulse skipping Eco-mode. When the peak inductor current is lower than 100 mA typical, the device enters Eco-mode.

Figure 2-10 shows Eco-mode operation, channel 1 (C1) shows the output voltage while channel 2 (C2) shows the switching node (PH).

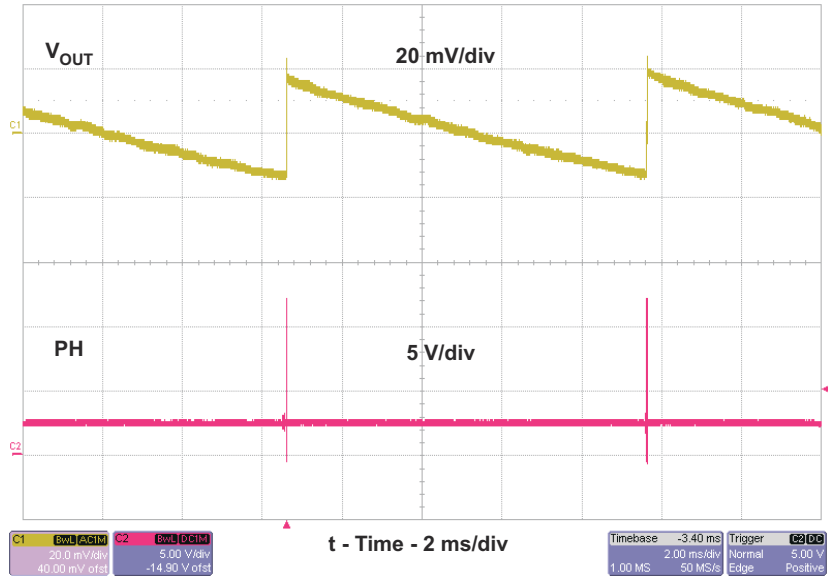

Figure 2-10. TPS54332EVM-416 Eco-mode Operation

3 Board Layout

This section provides a description of the TPS54332EVM-416, board layout, and layer illustrations.

3.1 Layout

Figure 3-1 through Figure 3-3 shows the board layout for the TPS54332EVM-416. The top-side layer of the EVM is laid out in a manner typical of a user application. The top and bottom layers are 2-oz. copper.

The top layer contains the main power traces for V_{IN} , V_{OUT} , and V_{PHASE} . Also on the top layer are connections for the remaining pins of the TPS54332 and a large area filled with ground. The bottom layer contains ground and a signal route for the BOOT capacitor. The top and bottom and internal ground traces are connected with multiple vias placed around the board including ten vias directly under the TPS54332 device to provide a thermal path from the top-side ground plane to the bottom-side ground plane.

The input decoupling capacitor (C2) and bootstrap capacitor (C4) are all located as close to the IC as possible. In addition, the voltage set-point resistor divider components are also kept close to the IC. The voltage divider network ties to the output voltage at the point of regulation, the copper V_{OUT} trace past the output capacitors, C3 and C8. For the TPS54332, an additional input bulk capacitor can be required, depending on the EVM connection to the input supply.

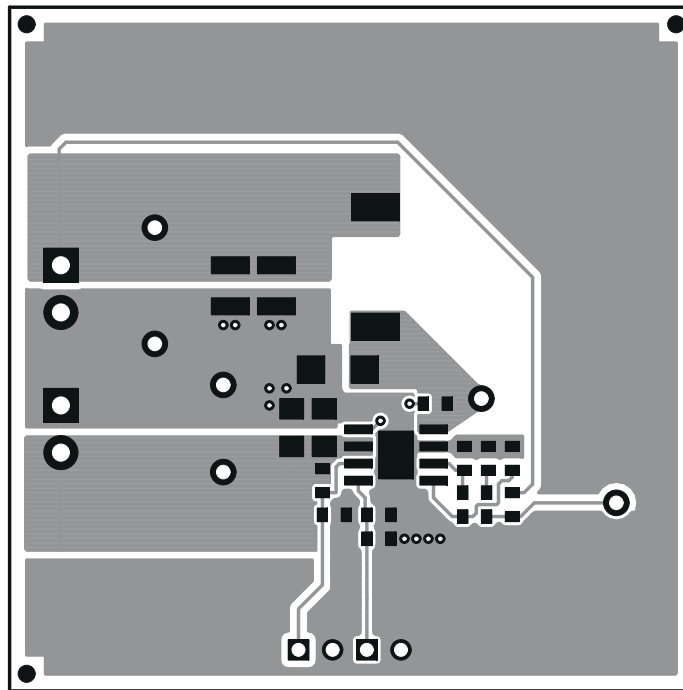

Figure 3-1. TPS54332EVM-416 Top-Side Layout

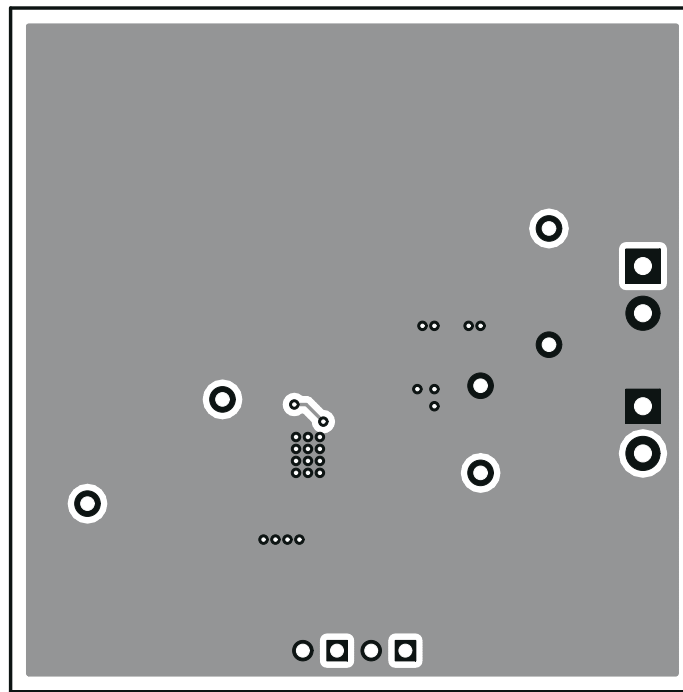

Figure 3-2. TPS54332EVM-416 Bottom-Side Layout

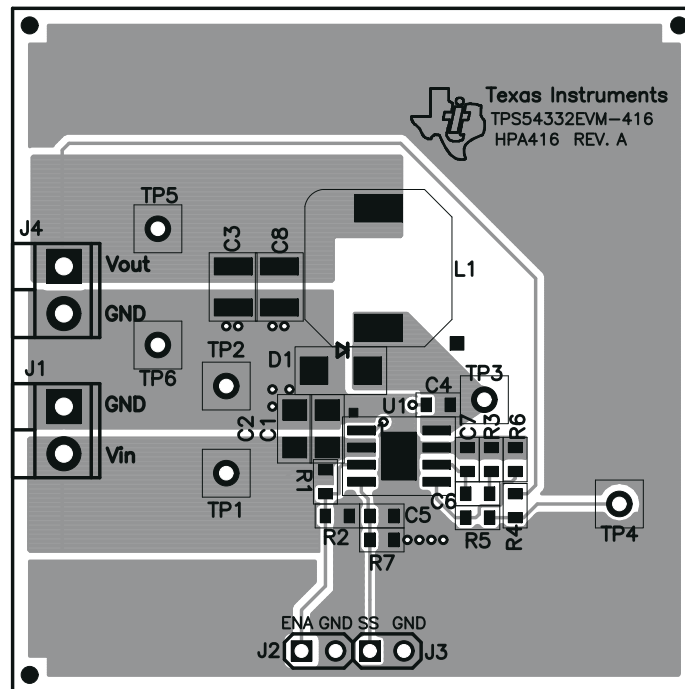

Figure 3-3. TPS54332EVM-416 Top-Side Assembly

3.2 Estimated Circuit Area

The estimated printed circuit board area for the components used in this design is 0.68 in². This area does not include test point or connectors.

4 Schematic and Bill of Materials

This section presents the TPS54332EVM-416 schematic and bill of materials.

4.1 Schematic

Figure 4-1 is the schematic for the TPS54332EVM-416.

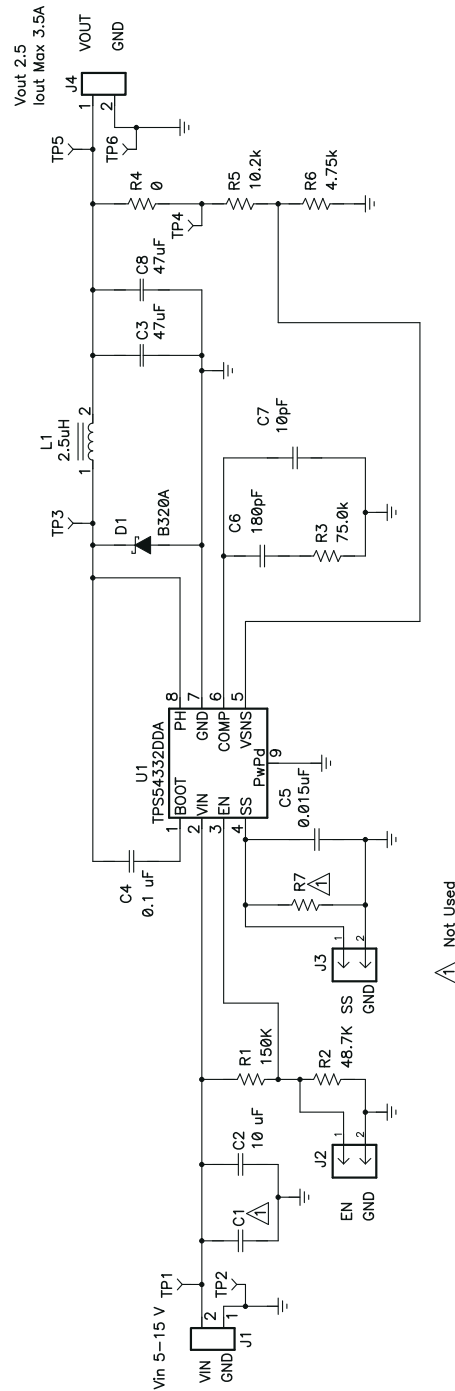

Figure 4-1. TPS54332EVM-416 Schematic

4.2 Bill of Materials

Table 4-1 presents the bill of materials for the TPS54332EVM-416.

Table 4-1. TPS54332EVM-416 Bill of Materials

Count	RefDes	Value	Description	Size	Part Number	MFR
0	C1		Capacitor, Ceramic, 25 V, X5R, 10%	1206		
1	C2	10 μ F	Capacitor, Ceramic, 25 V, X5R, 10%	1206	GRM31CR61E106KA 12	muRata
1	C3, C8	47 μ F	Capacitor, Ceramic, 10 V, X5R, 10%	1210	Std	Std
1	C4	0.1 μ F	Capacitor, Ceramic, 16 V, X7R, 10%	0603	Std	Std
1	C5	0.015 μ F	Capacitor, Ceramic, 16 V, X7R, 10%	0603	Std	Std
1	C6	180 pF	Capacitor, Ceramic, 50 V, NPO, 5%	0603	Std	Std
1	C7	10 pF	Capacitor, Ceramic, 50 V, NPO, 5%	0603	Std	Std
1	D1	B320A	Diode, Schottky, 3 A, 20 V	SMA 0.27 \times 0.25 inch	B320A	Diodes Inc
2	J1, J4	ED1514	Terminal Block, 2-pin, 6-A, 3.5mm	0.100 \times 2	ED1514	OST
2	J2, J3	PTC36SAAN	Header, 2-pin, 100-mil spacing, (36-pin strip)	0.402 \times 0.394 inch	PTC36SAAN	
1	L1	2.5 μ H	Inductor, SMT, 9.26 A, 10 m Ω	0603	MSS1038-252NX_	Coilcraft
1	R1	150 K Ω	Resistor, Chip, 1/16W, 1%	0603	Std	Std
1	R2	48.7 K Ω	Resistor, Chip, 1/16W, 1%	0603	Std	Std
1	R3	75.0 k Ω	Resistor, Chip, 1/16W, 1%	0603	Std	Std
1	R4	0	Resistor, Chip, 1/16W, 1%	0603	Std	Std
1	R5	10.2 k Ω	Resistor, Chip, 1/16W, 1%	0603	Std	Std
1	R6	4.75 k Ω	Resistor, Chip, 1/16W, 1%	0603	Std	Std
0	R7		Resistor, Chip, 1/16W, 1%	0.100 \times 0.100 inch	Std	Std
3	TP1, TP3, TP5	5000	Test Point, Red, Thru Hole Color Keyed	0.100 \times 0.100 inch	5000	Keystone
3	TP2, TP4, TP6	5001	Test Point, Black, Thru Hole Color Keyed	SO8[DDA]	5001	Keystone
1	U1	TPS54332DD A	IC, Step-Down Swift Converter, 3.5 V–28 V, 3.5 A		TPS54332DDA	TI
1			PCB		HPA416	Any
1			Shunt		929950-00	3M

5 Revision History

NOTE: Page numbers for previous revisions may differ from page numbers in the current version.

Changes from Revision * (February 2009) to Revision A (October 2021) Page

- Updated the numbering format for tables, figures, and cross-references throughout the document.2
- Updated the user's guide title..... 2

IMPORTANT NOTICE AND DISCLAIMER

TI PROVIDES TECHNICAL AND RELIABILITY DATA (INCLUDING DATASHEETS), DESIGN RESOURCES (INCLUDING REFERENCE DESIGNS), APPLICATION OR OTHER DESIGN ADVICE, WEB TOOLS, SAFETY INFORMATION, AND OTHER RESOURCES "AS IS" AND WITH ALL FAULTS, AND DISCLAIMS ALL WARRANTIES, EXPRESS AND IMPLIED, INCLUDING WITHOUT LIMITATION ANY IMPLIED WARRANTIES OF MERCHANTABILITY, FITNESS FOR A PARTICULAR PURPOSE OR NON-INFRINGEMENT OF THIRD PARTY INTELLECTUAL PROPERTY RIGHTS.

These resources are intended for skilled developers designing with TI products. You are solely responsible for (1) selecting the appropriate TI products for your application, (2) designing, validating and testing your application, and (3) ensuring your application meets applicable standards, and any other safety, security, regulatory or other requirements.

These resources are subject to change without notice. TI grants you permission to use these resources only for development of an application that uses the TI products described in the resource. Other reproduction and display of these resources is prohibited. No license is granted to any other TI intellectual property right or to any third party intellectual property right. TI disclaims responsibility for, and you fully indemnify TI and its representatives against any claims, damages, costs, losses, and liabilities arising out of your use of these resources.

TI's products are provided subject to [TI's Terms of Sale](#), [TI's General Quality Guidelines](#), or other applicable terms available either on ti.com or provided in conjunction with such TI products. TI's provision of these resources does not expand or otherwise alter TI's applicable warranties or warranty disclaimers for TI products. Unless TI explicitly designates a product as custom or customer-specified, TI products are standard, catalog, general purpose devices.

TI objects to and rejects any additional or different terms you may propose.

Copyright © 2026, Texas Instruments Incorporated

Last updated 10/2025