

ADS5294, 8-Channel, Analog-to-Digital Converter Evaluation Module

This user's guide gives a general overview of the evaluation module (EVM) and provides a general description of the features and functions to be considered while using this module. This manual is applicable to the ADS5294 analog-to-digital converters (ADC), which collectively are referred to as ADS529x. Use this document in combination with the respective ADC data sheet. The ADS529xEVM provides a platform for evaluating the ADC under various signal, clock, reference, and power supply conditions.

Contents

1	Quick View of Evaluation Setup	3
2	Default Configuration	4
3	Software Installation and Operation	5
	3.1 GUI Installation – Mandatory	5
	3.2 USB Interface Driver Installation	5
4	Test Setup	6
5	Power Up ADS5294	7
6	Launch ADS5294 GUI	8
7	Launch TSW1400 GUI.....	11
8	TEST ADS5294.....	12
	8.1 Step 2: Single Tone FFT	15
9	Board Configuration.....	17
	9.1 Input/Output, Power Supply, and USB	17
	9.2 ADC Clock.....	19
	9.3 Light-Emitting Diodes	21
	9.4 Miscellaneous Test Points	22
10	EVM Schematics	23
11	ADS5294EVM Bill of Materials	31
12	ADS5294EVM Printed-Circuit Board Layout.....	33
Appendix A High Speed Data Converter Pro (HSDCPro) GUI Installation.....		41

List of Figures

1	Evaluation Setup	3
2	ADS5294EVM Basic Configuration.....	4
3	HW Setup With Connection Between TSW1400EVM and ADS5294EVM.....	7
4	Power-Up Indications.....	8
5	ADS5294 GUI Launch	9
6	TSW1400 GUI Launch.....	11
7	ADS5294 Time Domain Setup	12
8	ADS5294 Test Pattern.....	13
9	User Interface: Time Domain Format.....	14
10	User Interface: Single FFT Format.....	16
11	I/O, PWR, and USB Connector.....	17
12	ADS5294EVM Default Clock Jumper Locations	19
13	ADS5294EVM LED Location	21

Windows, Microsoft are trademarks of Microsoft Corporation.

14	ADS5294EVM Test Point Locations	22
15	Schematic, Sheet 1 of 9	23
16	Schematic, Sheet 2 of 9	24
17	Schematic, Sheet 3 of 9	24
18	Schematic, Sheet 4 of 9	25
19	Schematic, Sheet 5 of 9	26
20	Schematic, Sheet 6 of 9	27
21	Schematic, Sheet 7 of 9	28
22	Schematic, Sheet 8 of 9	29
23	Schematic, Sheet 9 of 9	30
24	ADS5294EVM Top Layer Assembly Drawing – Top View	33
25	ADS5294EVM Bottom Layer Assembly Drawing – Bottom View	34
26	ADS5294EVM Top Layer Copper – Top View	35
27	ADS5294EVM Internal Layer 1, Ground – Top View	36
28	ADS5294EVM Internal Layer 2, Power – Top View	37
29	ADS5294EVM Internal Layer 3, Power – Top View	38
30	ADS5294EVM Internal Layer 4, Ground – Top View	39
31	ADS5294EVM Bottom Layer Copper – Top View	40
32	HSDCPro Install (Begin).....	41
33	HSDCPro Install (Install Directory)	42
34	HSDCPro Install (TI License Agreement)	43
35	HSDCPro Install (NI License Agreement).....	44
36	HSDCPro Install (Start Installation)	45
37	HSDCPro Install (Installation Progress)	46
38	HSDCPro Install (Installation Complete)	47
39	HSDCPro Install (h)	48
40	HSDCPro Install	48

List of Tables

1	Input/Output, Power, and USB	17
2	Channel 8 Configuration.....	18
3	ADC Clock Various Mode Jumper Settings	19
4	LED Indicators	21
5	Miscellaneous Test Points	22

1 Quick View of Evaluation Setup

Figure 1 shows an overview of the evaluation setup that includes the ADS5294EVM evaluation module (EVM), TSW1400EVM, external equipment, personal computer (PC), and software requirements.

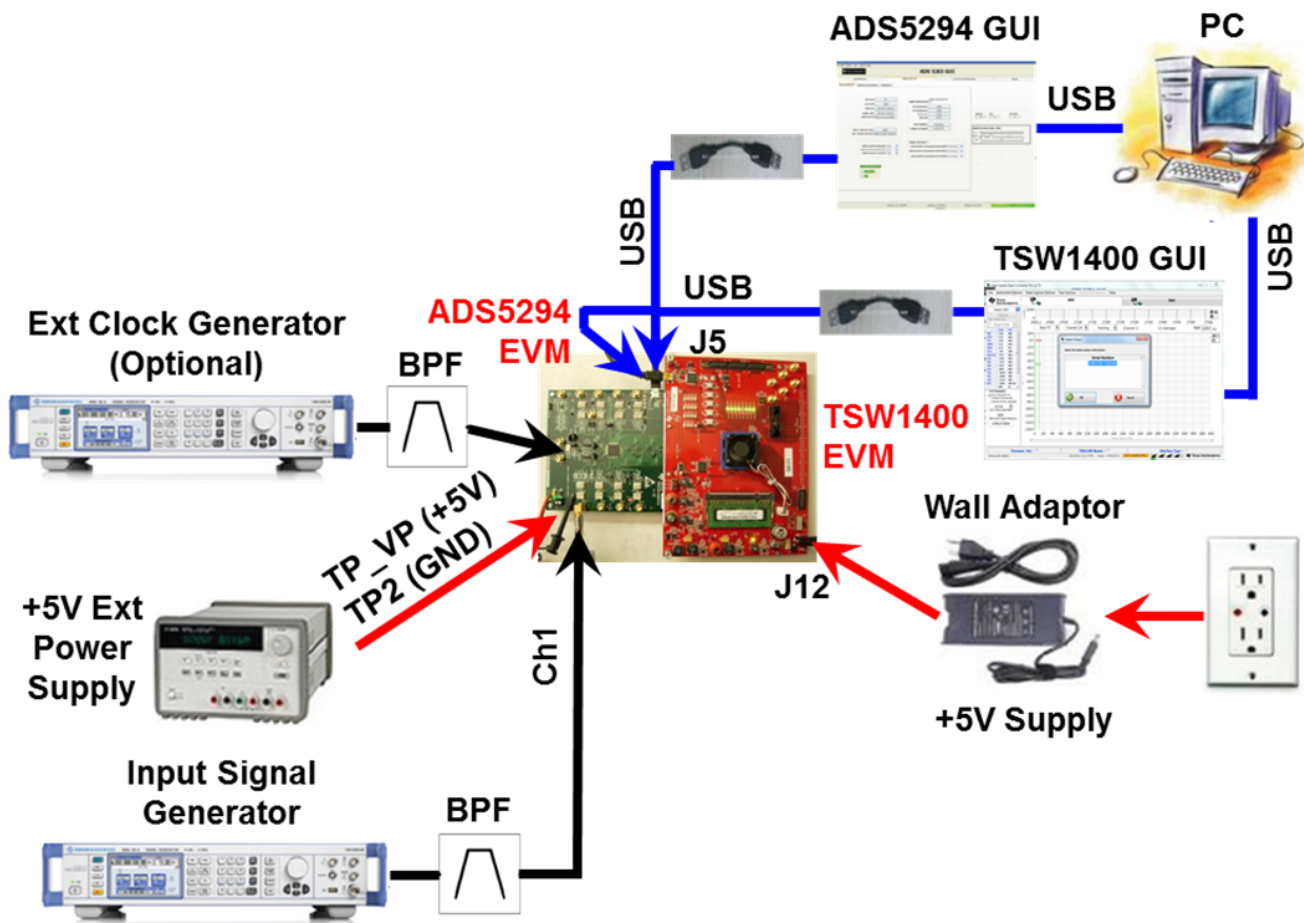

Figure 1. Evaluation Setup

TSW1400EVM: The high-speed LVDS deserializer board is required for capturing data from the ADS5294EVM and its analysis using the TSW1400 graphical user interface (GUI).

For more information pertaining to the TSW1400EVM, see:
<http://www.ti.com/tool/tsw1400evm>.

Equipment: Signal generators (with low-phase noise) must be used as source of input signal and clock (optional) in order to get the desired performance. Additionally, band-pass filters (BPF) are required in signal and clock (optional) paths to attenuate the harmonics and noise from the generators.

Power Supply: A single +5-V supply powers the ADS5294EVM. The supplies for the ADS5294 device are derived from the +5-V supply. The power supply must be able to source up to 1.5 A. A +6-V supply can power the TSW1400EVM using a wall adaptor.

USB Interface to PC: The USB connection from the ADS5294EVM and TSW1400EVM to the personal computer (PC) must be set up; [Section 3.2](#) explains the USB driver installation.

ADS5294GUI: [Section 3.1](#) explains the GUI installation procedure and its operation.

2 Default Configuration

ADS5294 EVM

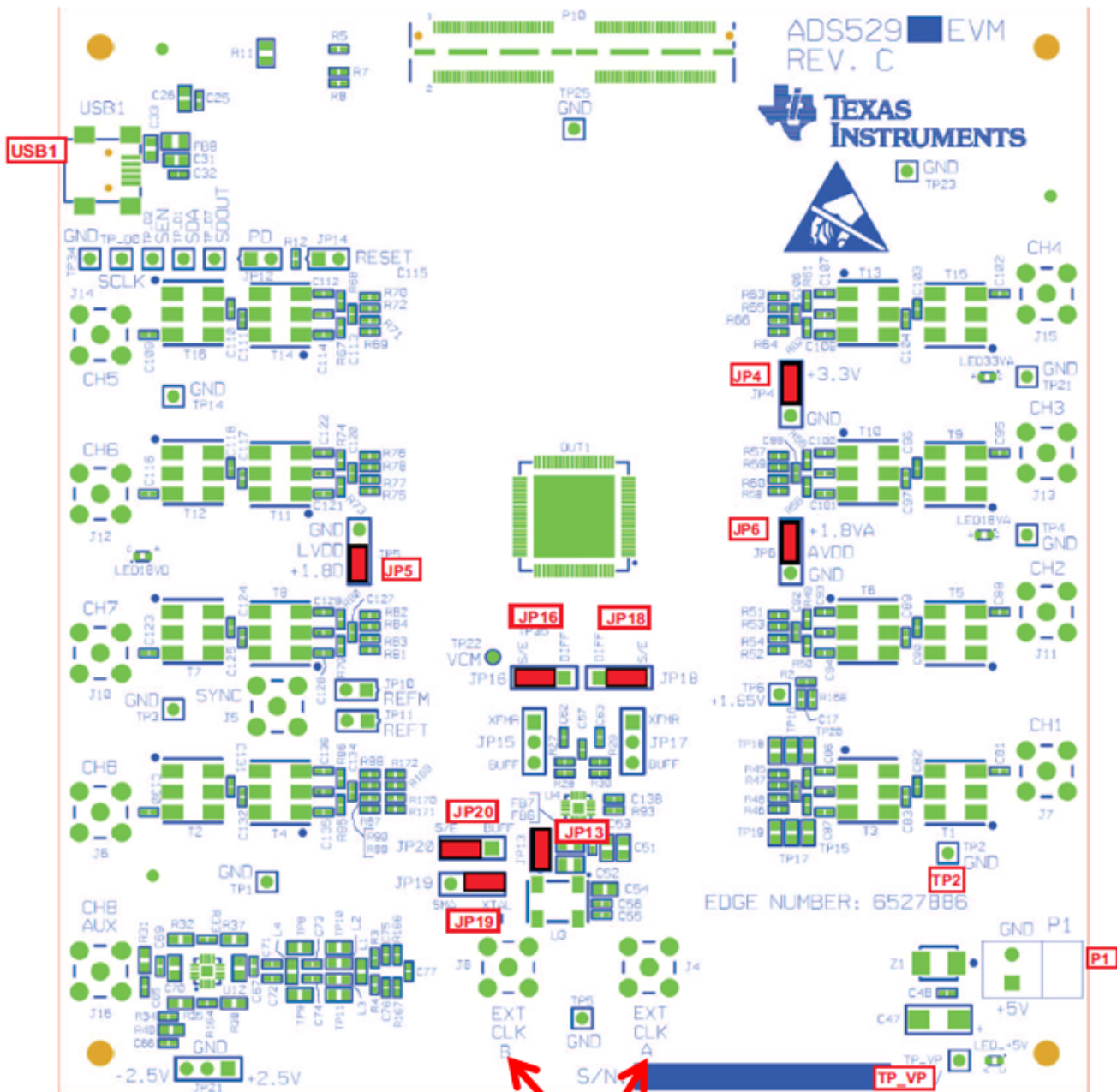

(Optional) 80MHz to
EXT CLK A or B

Figure 2. ADS5294EVM Basic Configuration

1. The ADS5294EVM basic configuration uses the onboard single-ended clock as the default option. See [Section 9.2](#) for the ADC clock, various-mode settings.
2. P1: +5-V Power supplies the connector.
3. JP4, JP5, and JP6 are set to enable +3.3V Analog, +1.8V Digital, and +1.8V Analog to device,

respectively.

4. JP13: Enable onboard CMOS clock.
5. JP16, JP18, JP19, JP20: ADC clock source selection jumpers.

3 Software Installation and Operation

The ADS5294EVM comes with a software install. To Download the software, visit the ADS5294 [product folder](#) under *Tools & software* .

3.1 GUI Installation – Mandatory

Once the zip folder is downloaded, run setup.exe to install the software. The software to use the TSW1400EVM is called HSDCPro (High Speed Data Converter Pro). For information on how to download this software, please see [Appendix A](#).

3.2 USB Interface Driver Installation

- Connect the USB port of EVM to your PC.
- If the driver has not been installed, then the message *Window Found New Hardware* appears. The Wizard as shown in the following illustration launches. Otherwise, skip [Section 3.2](#) and go to [Section 4](#).
- Select *No, not this time* from the options. Press Next button



- Select *Install from a list or specific location (Advanced)* as shown in the following illustration, and then click *Next*.

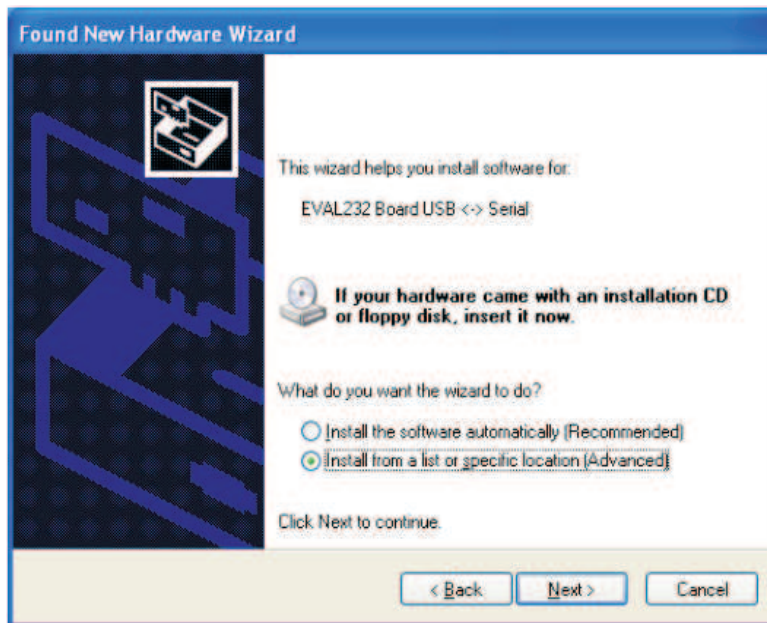

- Select *Search for the best driver in these locations*, and enter the file path for (C:\Program Files\Texas Instruments\ADS 5294EVM\CDM 2.04.06 WHQL Certified) in the combo-box. or browse to it by clicking the browse button. Once the file path has been entered in the box, click *Next* to proceed.
- If Windows™ XP is configured to warn when unsigned (non-WHQL certified) drivers are about to be installed, the following screen is displayed unless installing a Microsoft™ WHQL-certified Driver. Click on *Continue Anyway* to continue with the installation. If Windows XP is configured to ignore file signature warnings, no message appears.



4 Test Setup

To evaluate the ADS5294 device, a TSW1400EVM is required. [Figure 3](#) shows the exact setup of these two boards and external connectors.

- Connect +5-V supply at **P1** connector or across TP_VP (+5V) and TP2 (GND).
- Connect USB cable from PC to **USB1** on ADS5294EVM.
- Connect ADS5294EVM to TSW1400EVM using **P10** connector.
- Connect USB cable from PC to USB port **J8** of TSW1400EVM.
- Connect +6-V wall adapter to TSW1400EVM at **J7** connector.

For the default configuration as shown in Figure 2, it is unnecessary to have an external sampling clock. The onboard CMOS clock oscillator is used.

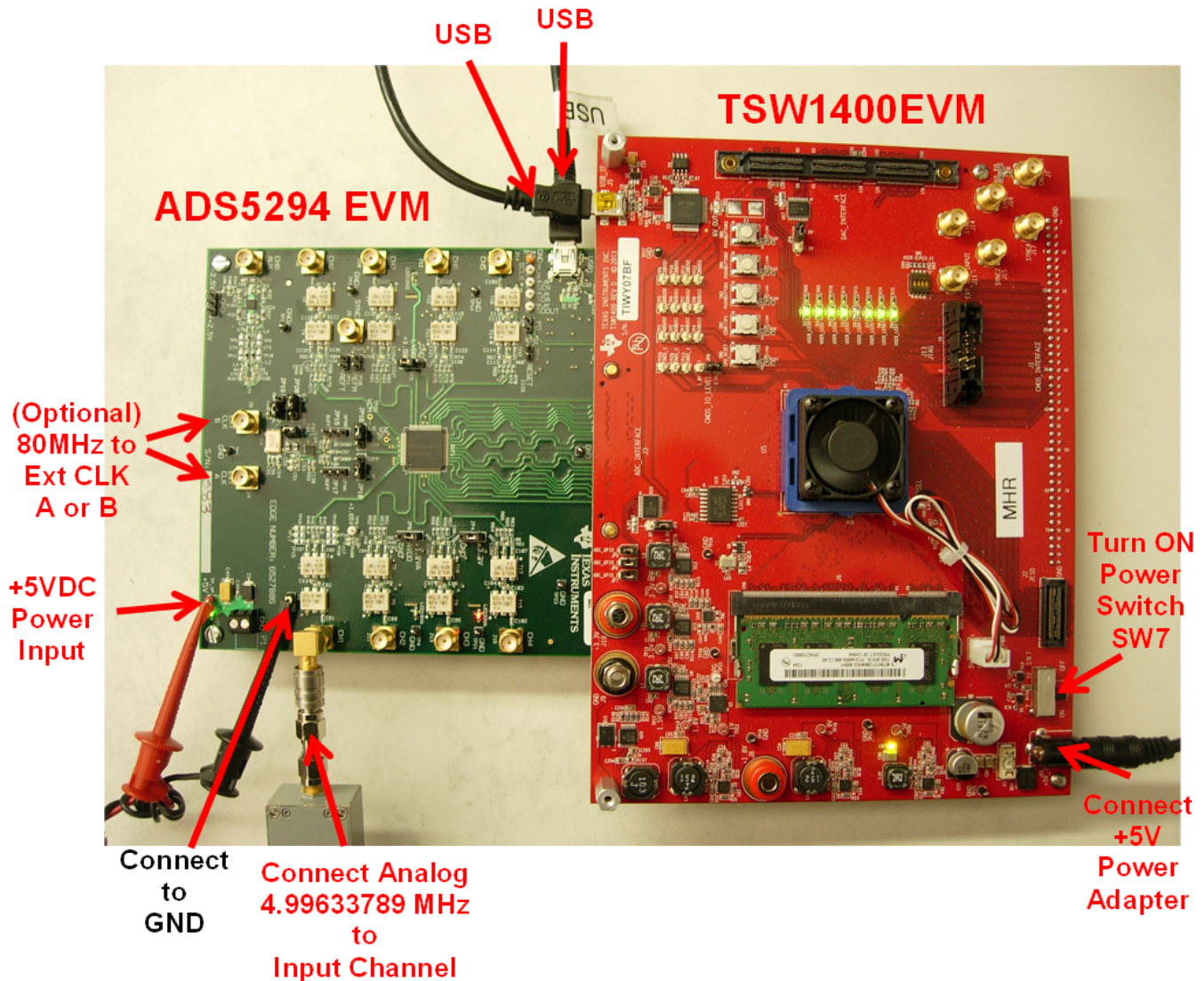

Figure 3. HW Setup With Connection Between TSW1400EVM and ADS5294EVM

5 Power Up ADS5294

After connecting the ADS5294EVM to the TSW1400 using the **P10** connector, +6-V adapter to TSW1400EVM, and +5 V (from the external power supply) to **P1** connector, then power up is complete. Three green LEDs and one orange LED turned on as shown in Figure 4 (also see Figure 13).

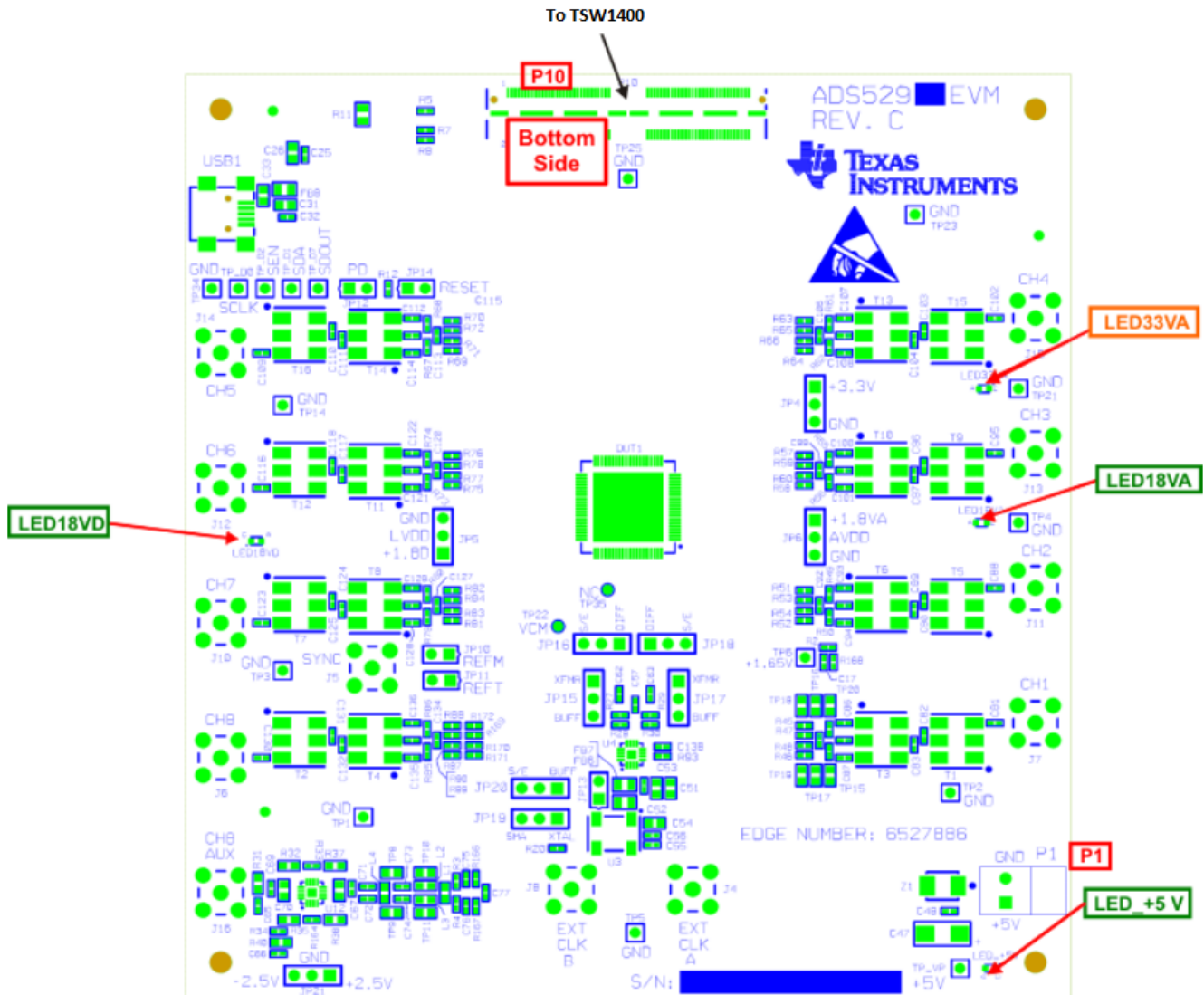

Figure 4. Power-Up Indications

6 Launch ADS5294 GUI

After launching the ADS5294 GUI, the GUI appears as is shown in Figure 5. After the GUI is completely launched, the window appears as is displayed in Figure 5. Select the **Top Level** tab to observe the default condition. The bottom status bar indicates *Ready for new command* and green (highlighted). Click on checkbox **PD**, and select it for power down to ensure proper software link to the hardware by observing change in current reading (approximately 450 mA to 150 mA) of the external +5-V power supply. For the rest of the test, **PD** must be unchecked. Click on **Soft Reset** button to reset device internally.

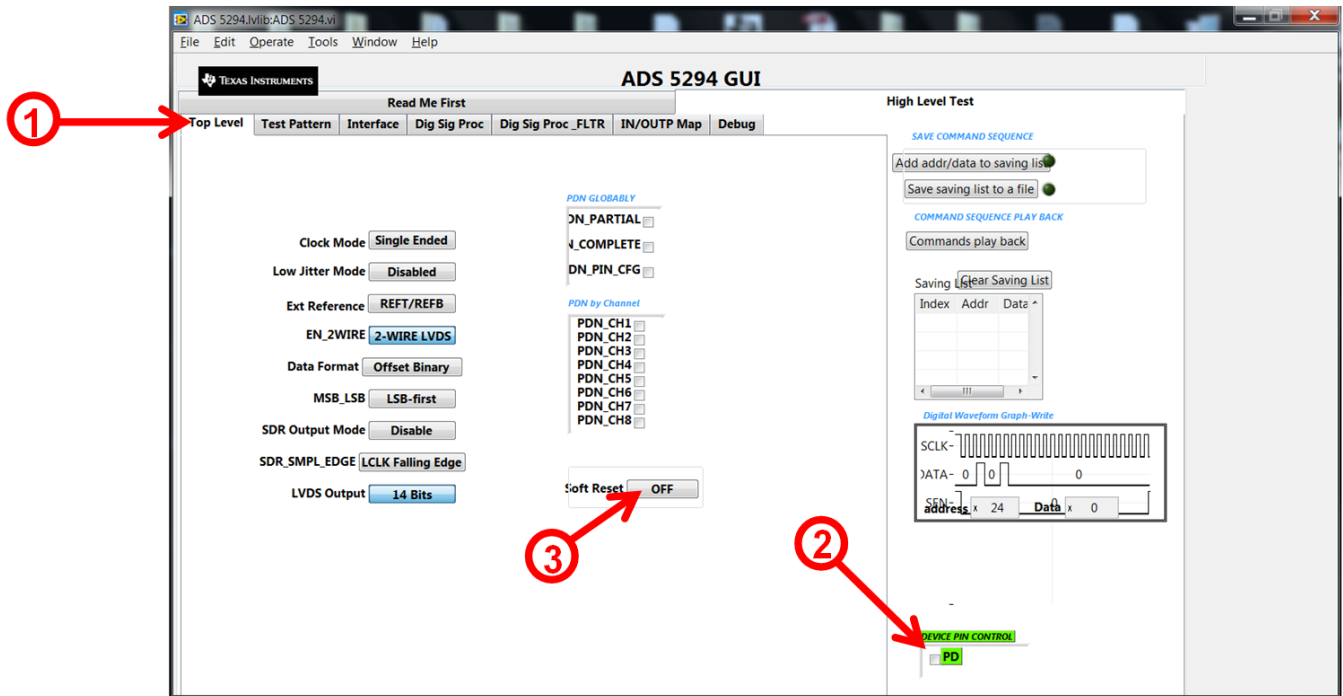
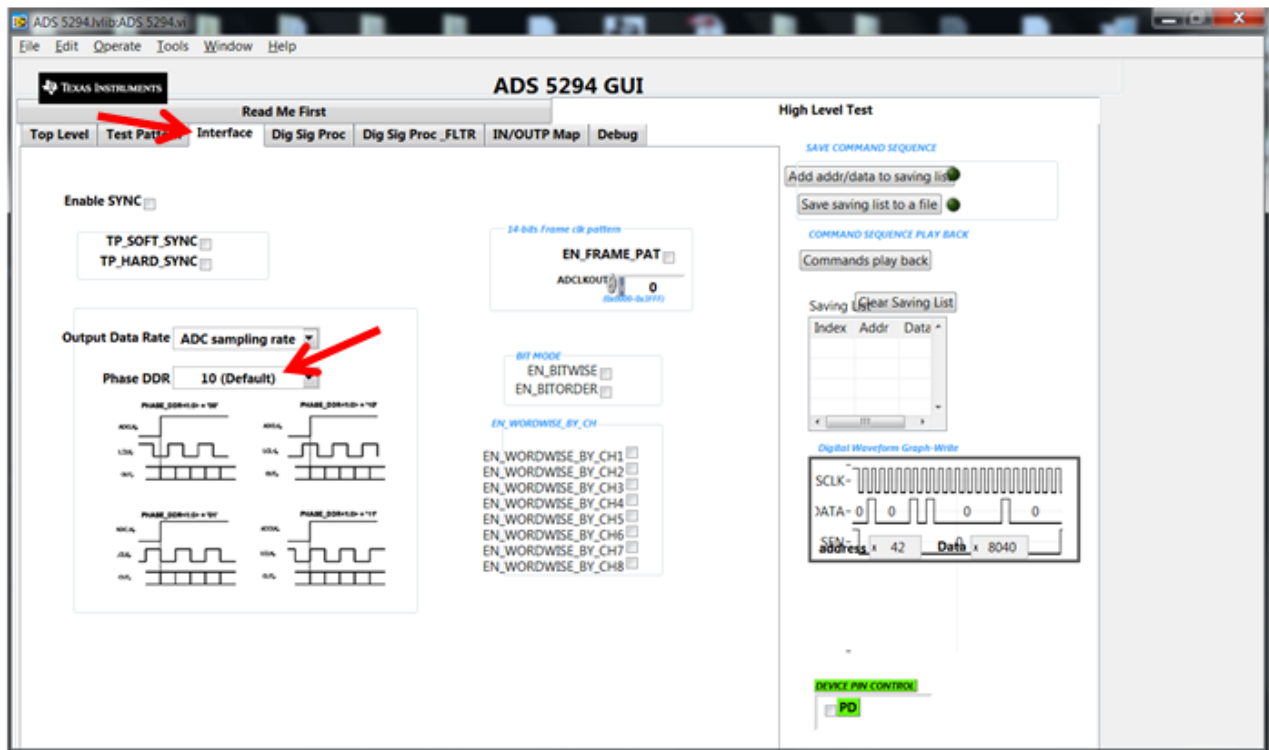
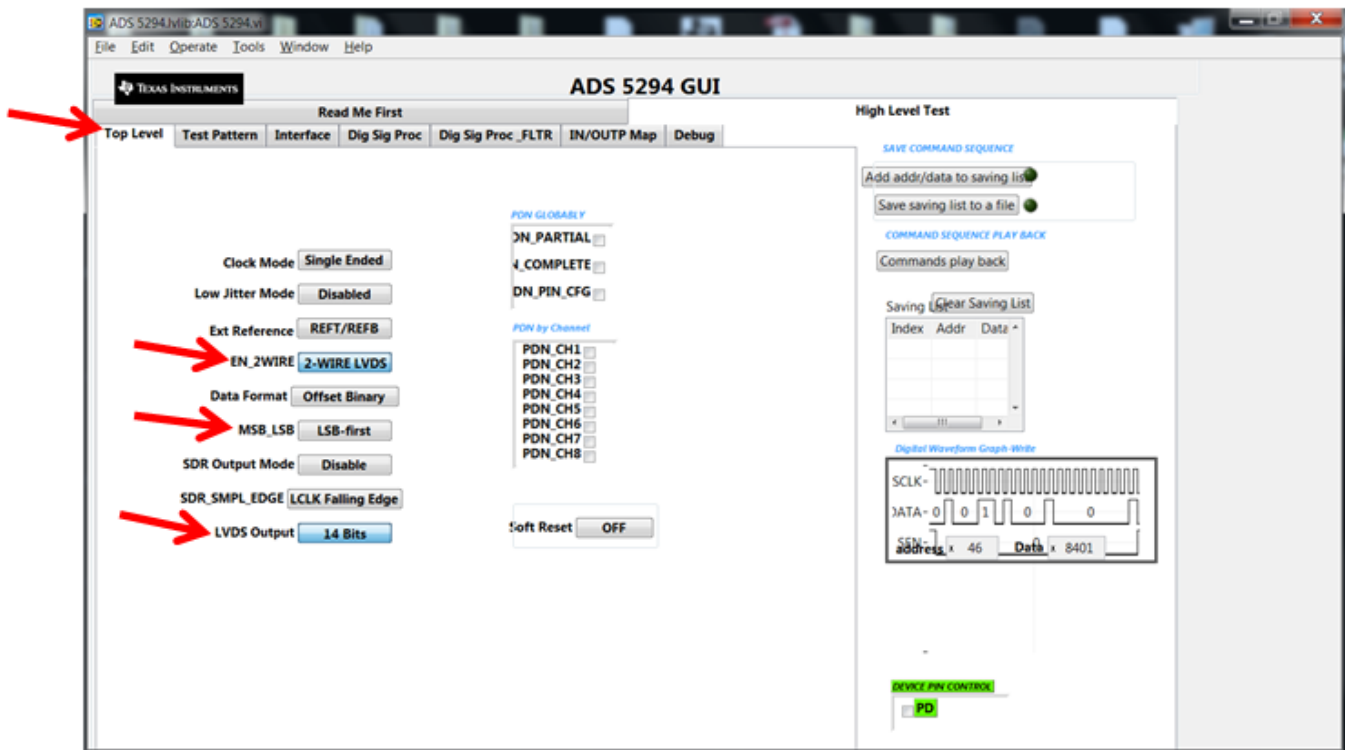

Figure 5. ADS5294 GUI Launch

After GUI launch and verification of software communication with EVM, click on button **EN_2WIRE**. This configures the ADC output interface in **2-WIRE LVDS** mode. Also click button **ADC Bit Resolution** to set ADC in **14 Bits** mode. Ensure that the **MSB_LSB** button status shows **LSB_First**.



7 Launch TSW1400 GUI

Launch TSW1400 GUI. The **Message** window displays this message to indicate that the setup of the TSW1400EVM and ADS5294EVM is working properly. If a different message or an error message appears, contact TI FAE.

1. Select **ADS5294_2W, 14bits**, from the GUI.
2. **ADC Sampling Rate (Fs)** is fixed at 80 MHz; this is the onboard CMOS clock frequency.
3. **ADC Input Frequency** – enter 5M and the GUI calculates the real coherent frequency (Fc) to 4.99633789M.

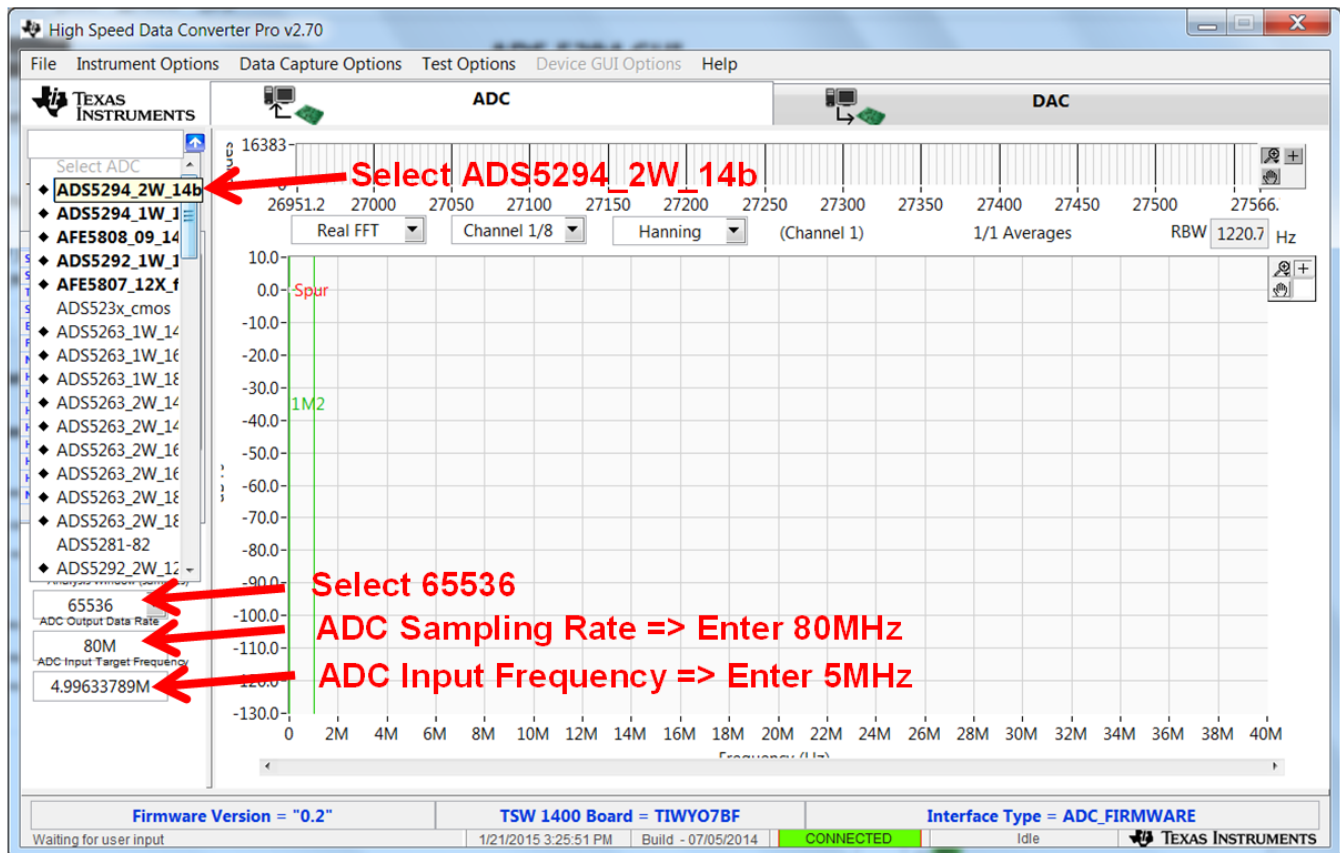

Figure 6. TSW1400 GUI Launch

8 TEST ADS5294

Step 1: Time Domain

- Select Time Domain page from TSW1400 GUI.

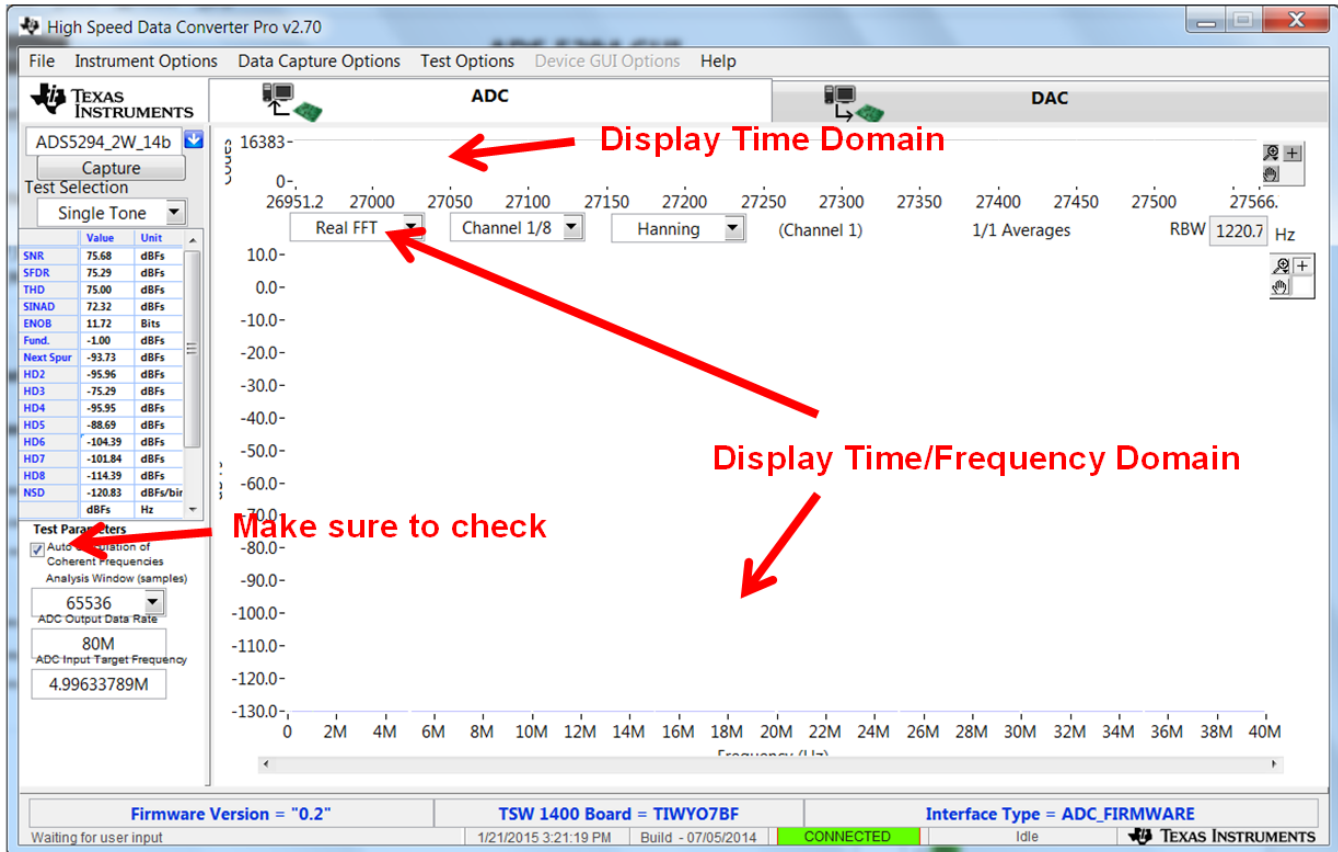

Figure 7. ADS5294 Time Domain Setup

- From ADS5294 GUI, go to **Test Pattern** page, then select **RAMP PATTERN**.

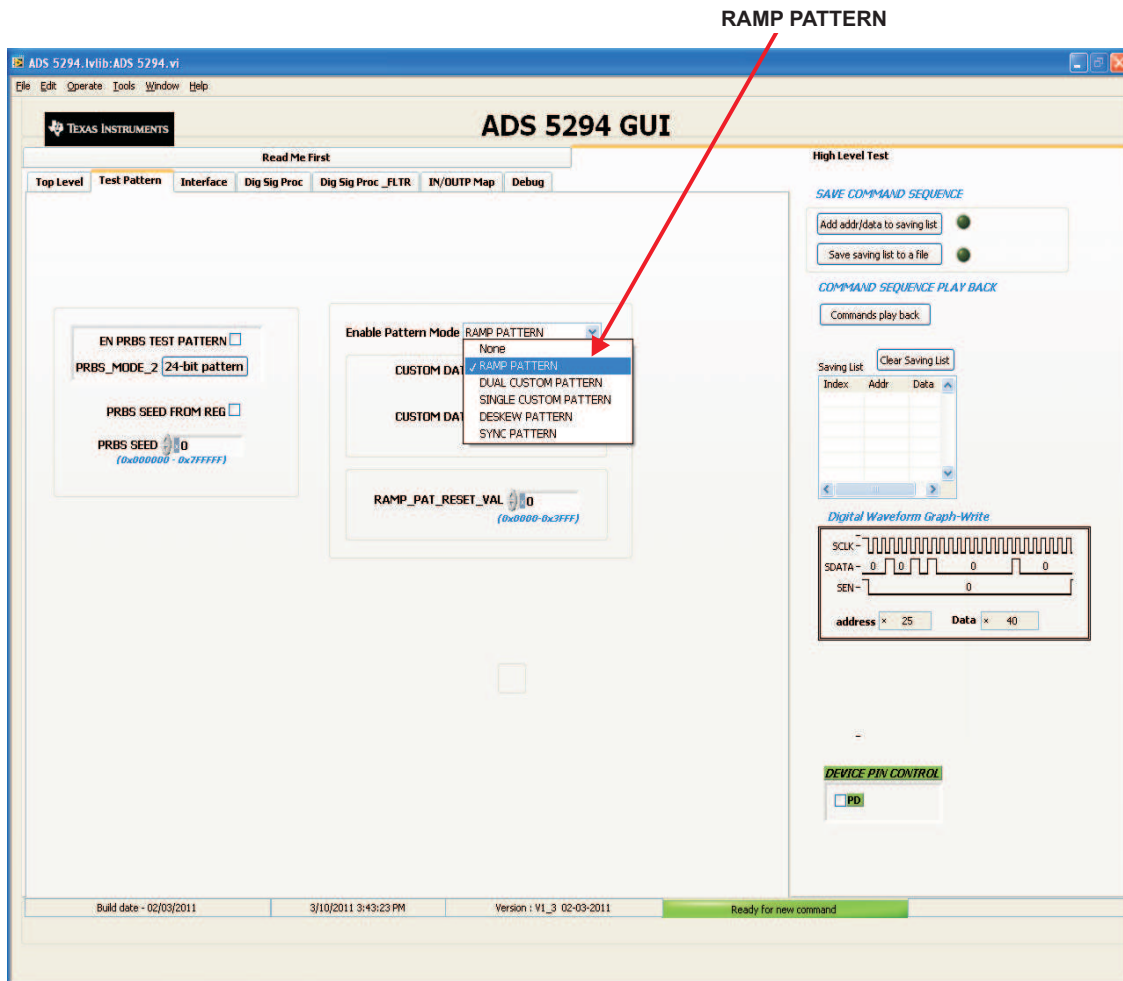

Figure 8. ADS5294 Test Pattern

- Press Capture button on TSW1400 GUI. You observe a ramping waveform on the TSW1400 GUI display area as shown in [Figure 9](#).
- Repeat for Channel 2...Channel 8.
- If each channel has the output as shown in the following illustration, you can proceed with the next step; otherwise, contact the TI FAE (Field Application Engineer) to troubleshoot the problem.**
- On the ADS5294 GUI, change Test Pattern to **None** from **RAMP PATTERN** for next step.

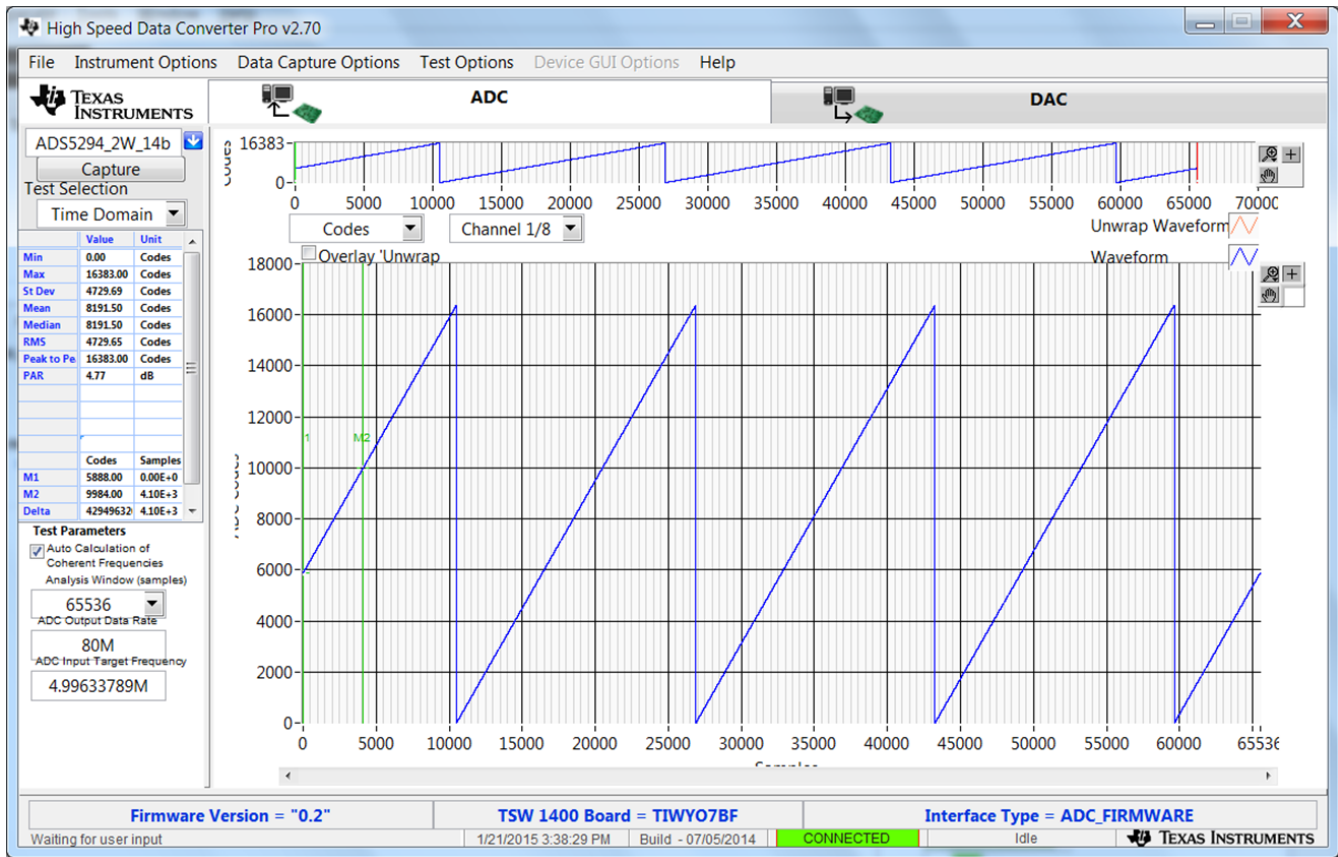
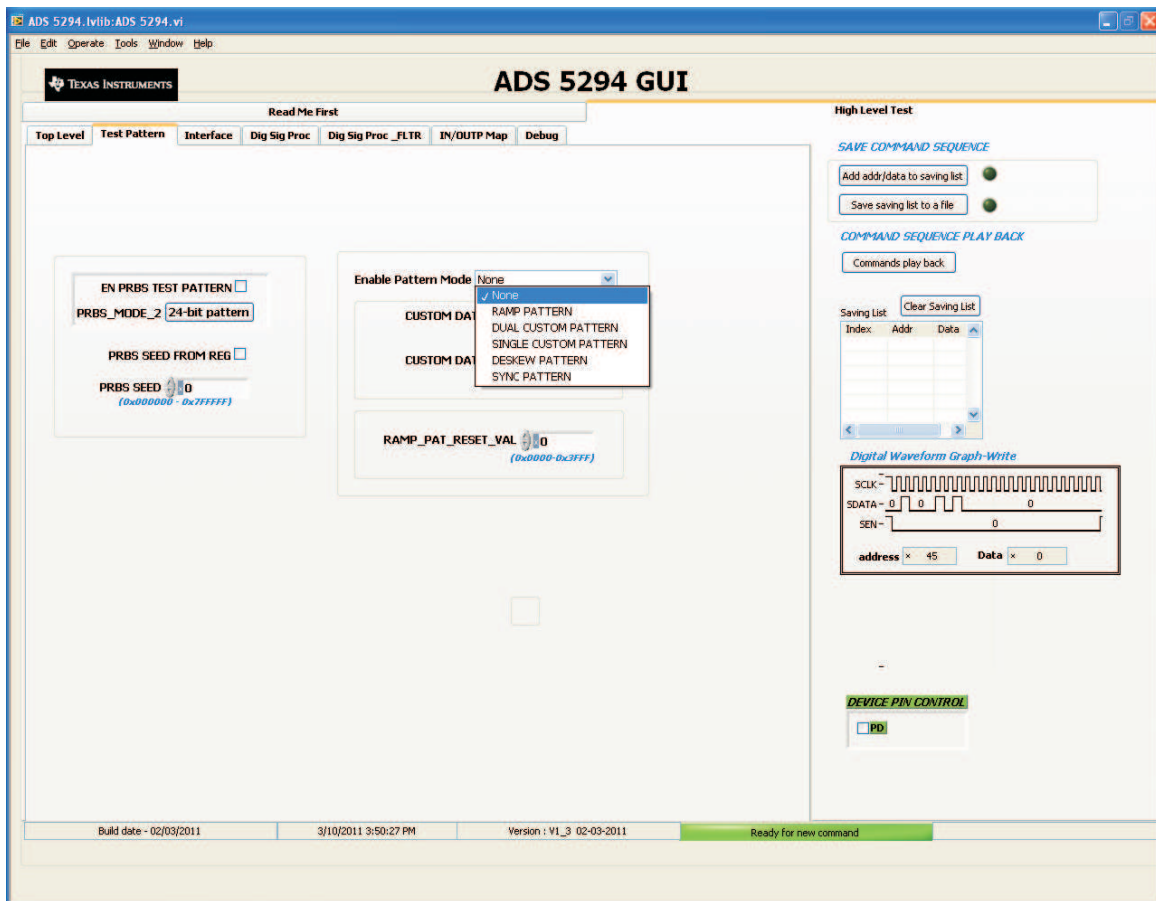

Figure 9. User Interface: Time Domain Format



8.1 Step 2: Single Tone FFT

- Select **Single Tone FFT** page at TSW1400 GUI.
- Connect Channel 1 of ADS5294EVM to a signal generator through a BP filter. If no **BP filter** is presented, the result is not good.
- Set Amplitude of the signal generator to **10dBm**
- Set Frequency of the signal generator to **4.99633789M** to match the GUI.
- Change window option to **Hanning**. This is due to the fact that input signal and onboard CMOS clock are noncoherent.
- Press Capture button to get the test result.
- Repeat for Channel 2...Channel 8.

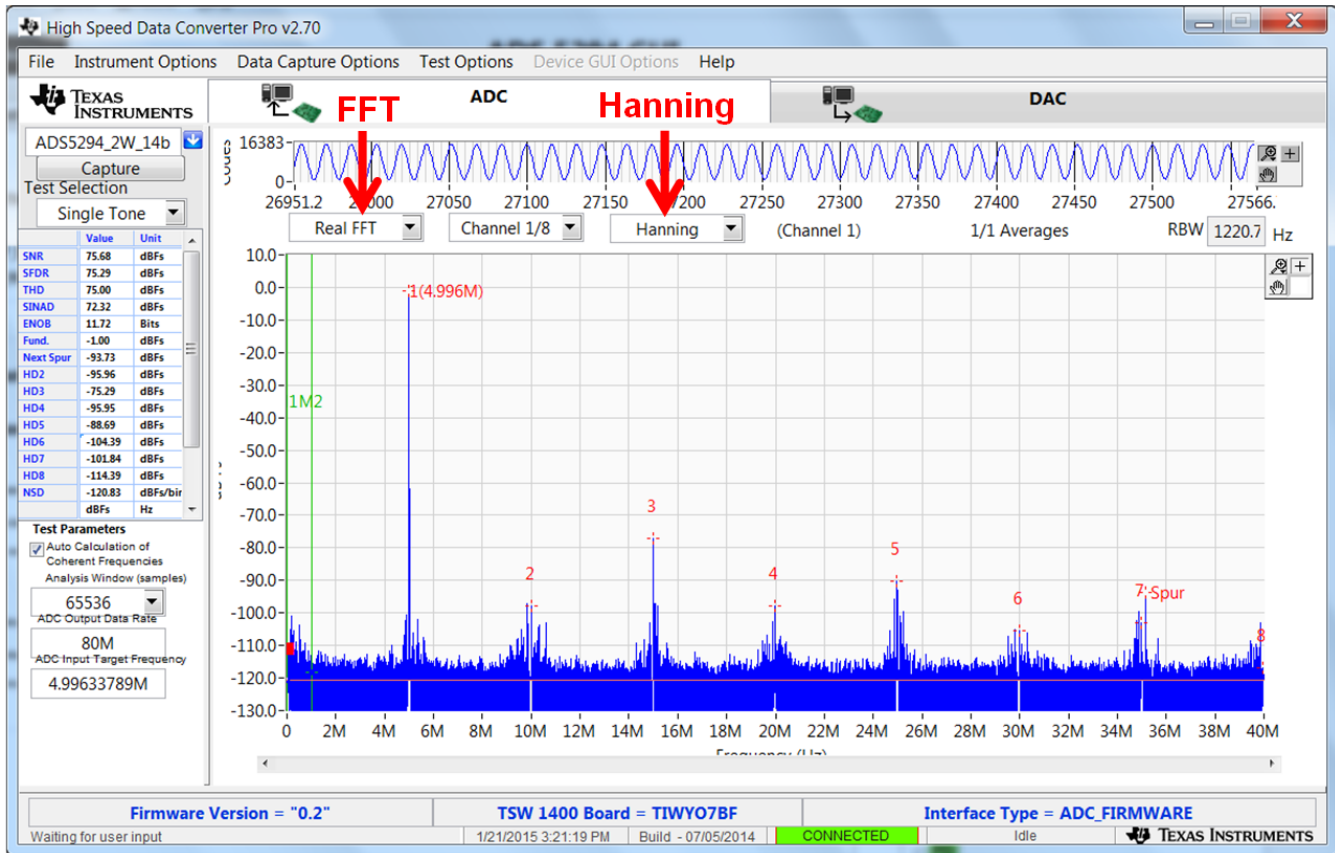

Figure 10. User Interface: Single FFT Format

9 Board Configuration

9.1 Input/Output, Power Supply, and USB

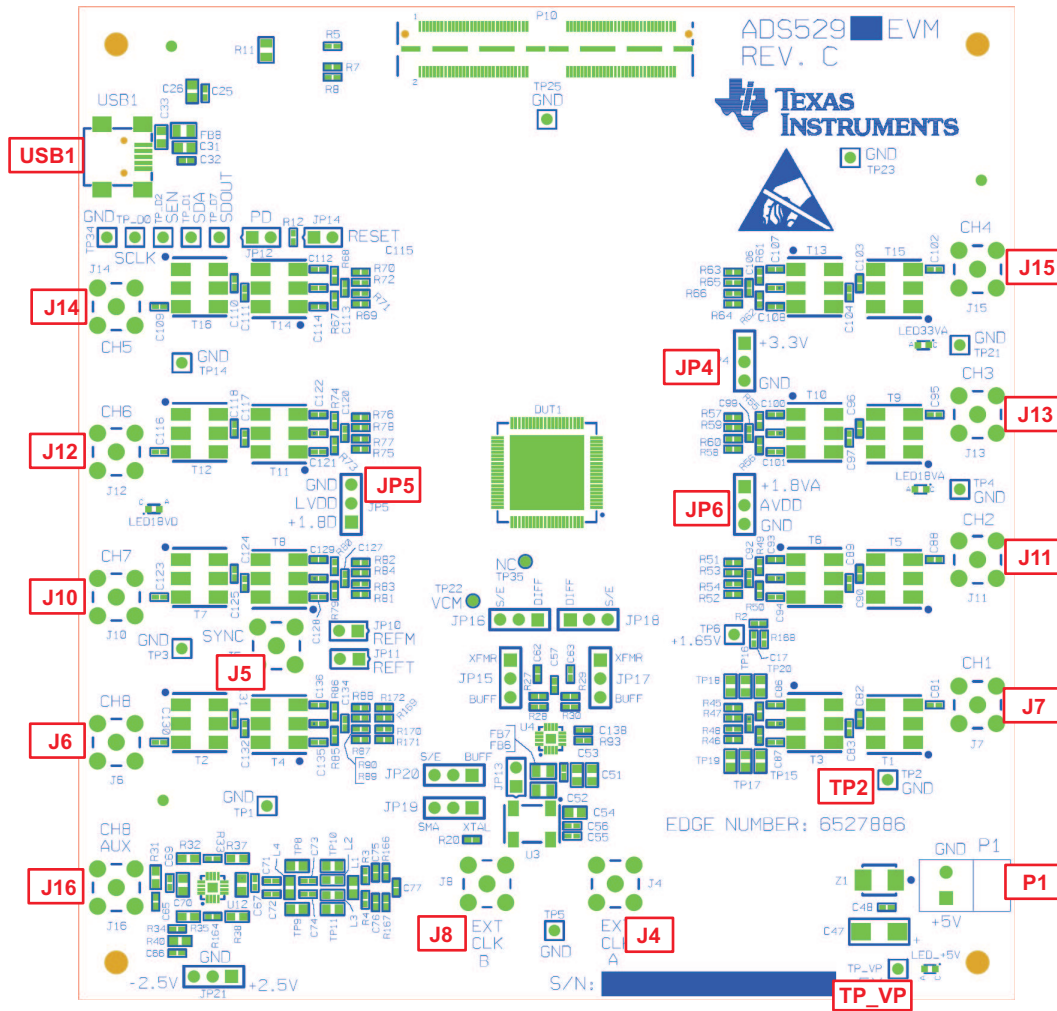

Figure 11. I/O, PWR, and USB Connector

Table 1. Input/Output, Power, and USB

Connector	Description
J6,J7,J10....J15	Analog Input signals for Ch1-Ch8. Connect to a signal generator. A band-pass filter must be applied between the generator and the SMA to get a better result. (See Figure 3)
J16	It is an alternative input for channel 8. Need to install two resistors (R169 and R170) and remove two resistors(R171 and R172) from J6.
P1/TP_VP	P1 is the +5-V power supply connector. TP_VP is the test point for +5-V power supply.
JP4	Onboard 3.3-V Analog enables. Set up as Figure 2 is a must to use onboard 3.3 V
JP5	Onboard 1.8-V Digital enables. Set up as Figure 2 is a must to use onboard 1.8 V
JP6	Onboard 1.8-V Analog enables. Set up as Figure 2 is a must to use onboard 1.8 V
TP1, TP2, TP3, TP4, TP5, TP14, TP21, TP23, TP25, TP34,	Ground test points.
USB1	USB interface connector

Table 2. Channel 8 Configuration

Input Interface Type	Connector	Description
Through Transformer (Default)	J6	In default configuration, R171 and R172 are already populated
Through Amplifier (Not Default)	J16	It is an alternative input for channel 8. Need to install two resistors (R169 and R170) and remove two resistors(R171 and R172) from J6.It uses TI THS4509 single-ended to differential amplifier.

9.2 ADC Clock

Five options are available for the source of the ADC clocks. Refer to Table 3 for details. In Figure 12, ADS5294EVM uses an onboard, single-ended clock as the default option.

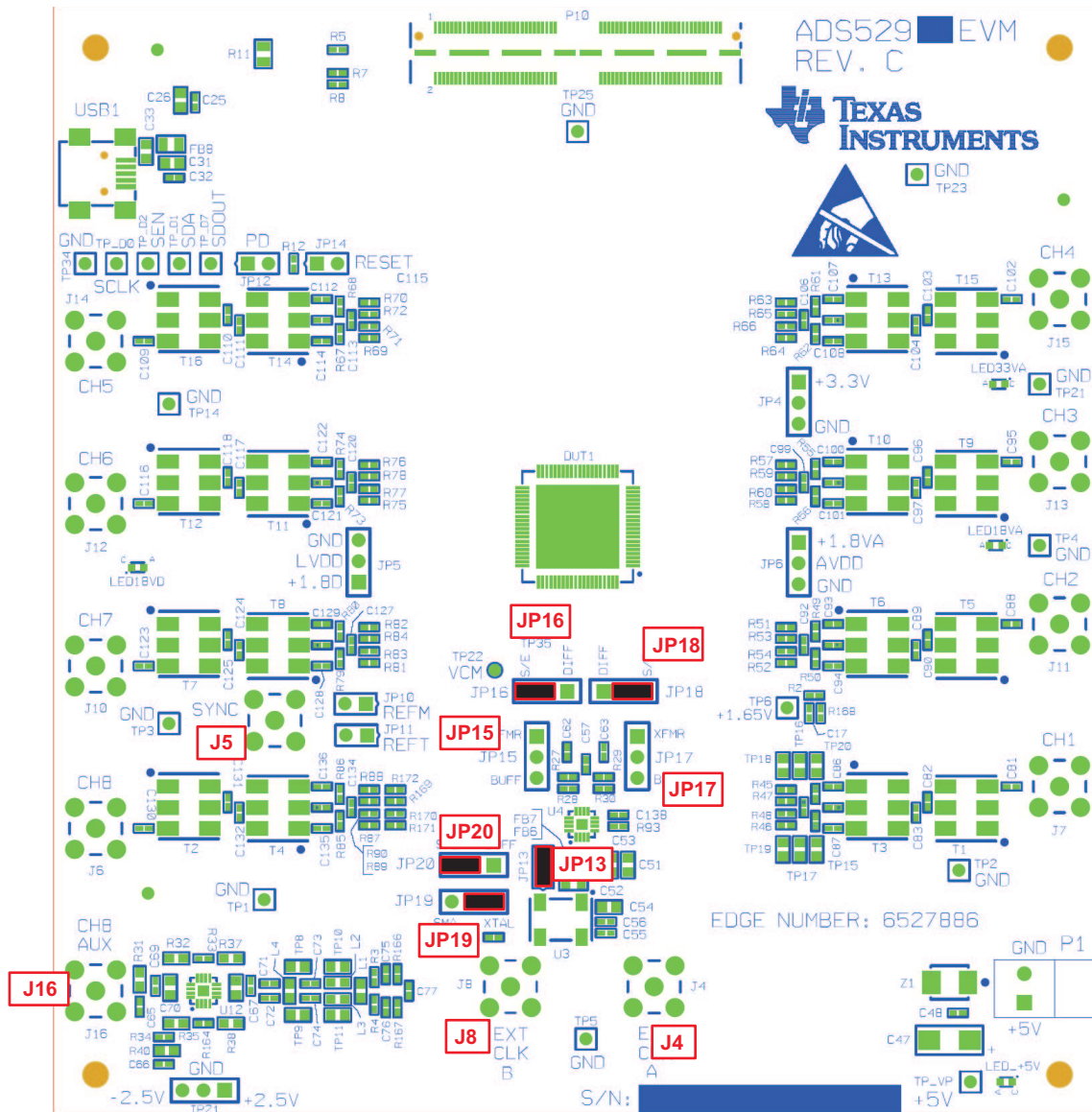

Figure 12. ADS5294EVM Default Clock Jumper Locations

Table 3. ADC Clock Various Mode Jumper Settings

Clock Type	Reference Designator	Jumper Setting	Diagram
Single Ended	Onboard CMOS Oscillator	JP13, JP19, JP20, JP16, JP18	JP13 (1-2), JP20 (2-3), JP19 (1-2), JP16 (2-3), JP18 (2-3)
	External CMOS Clock Generator	J8, JP19, JP20, JP16, JP18	JP20 (2-3), JP19 (2-3), JP16 (2-3), JP18 (2-3) and Connect CMOS clock generator output at SMA connector J8.

Table 3. ADC Clock Various Mode Jumper Settings (continued)

Clock Type		Reference Designator	Jumper Setting	Diagram
Differential Clock Signal	Transformer Based External	JP15, JP17, JP16, JP18, J4	JP15 (1-2), JP16 (1-2), JP17 (1-2), JP18 (1-2), and Connect external Clock source at SMA connector J4	Dia. 3
	Onboard Clock Buffer (CDCLVP1102,U4)	JP13, JP19, JP20, JP15, JP17, JP16, JP18	JP13 (1-2), JP20 (1-2), JP19 (1-2), JP15 (2-3), JP17 (2-3), JP16 (1-2), JP18 (1-2). This configures the onboard CMOS oscillator as clock input to buffer.	Dia. 4
		J8, JP19, JP20, JP15, JP17, JP16, JP18	JP19 (2-3), JP20 (1-2), JP15 (2-3), JP17 (2-3), JP16 (1-2), JP18 (1-2) and Connect External CMOS generator output at SMA connector J8. This configures the external CMOS source as clock input to buffer.	Dia. 5

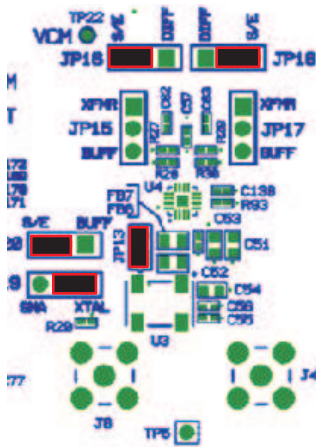

Dia.1

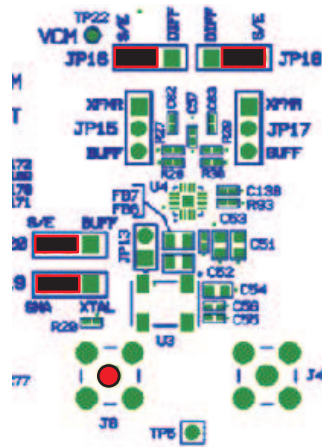

Dia.2

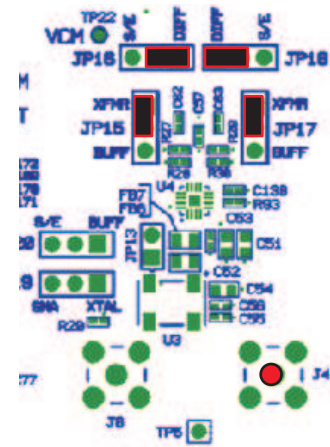

Dia.3

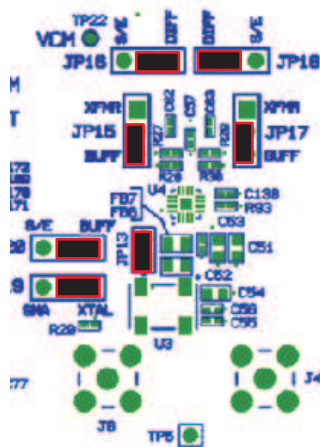

Dia.4

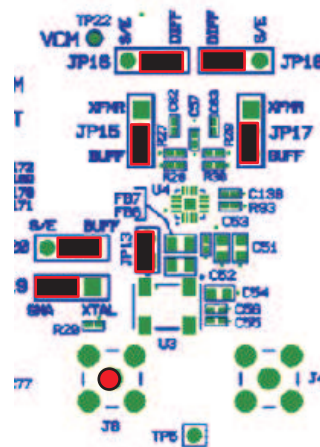

Dia.5

9.3 Light-Emitting Diodes

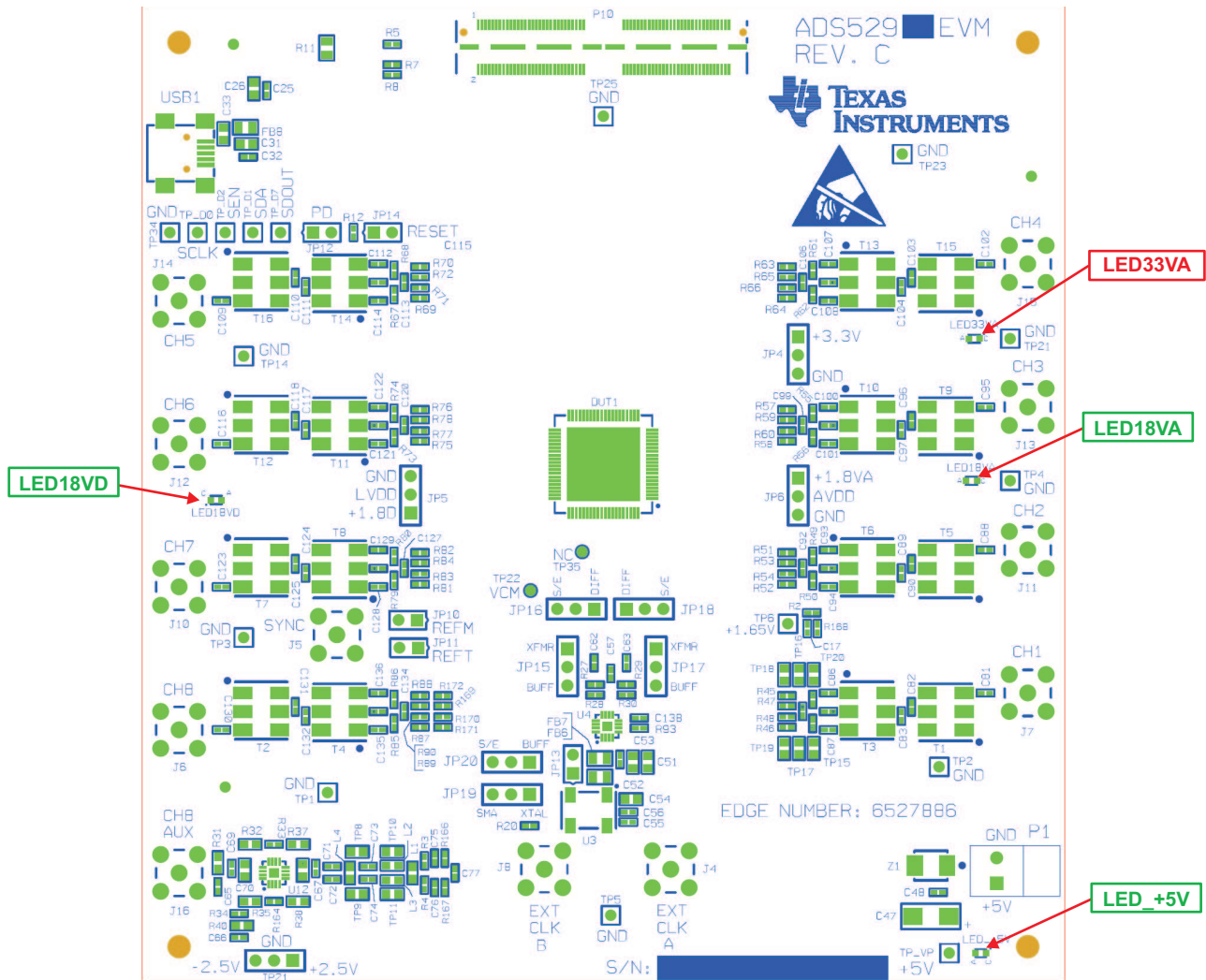

Figure 13. ADS5294EVM LED Location

Table 4. LED Indicators

Reference Designator	Power Supply	Color
LED_+5V	+5 V	Green
LED1.8VA	+1.8 VA	Green
LED1.8VD	+1.8 VD	Green
LED3.3VA	+3.3 VA	Orange

9.4 Miscellaneous Test Points

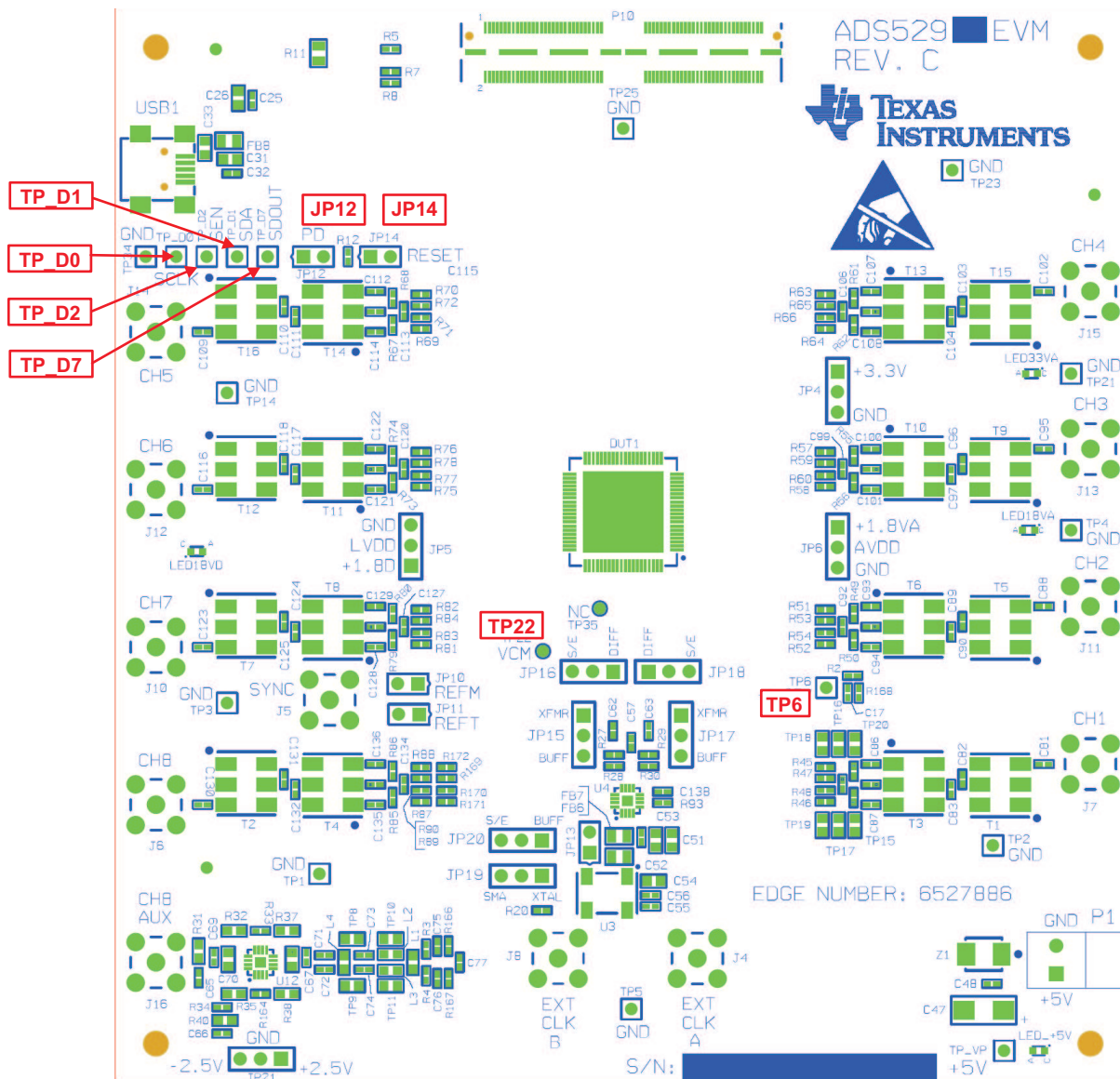

Figure 14. ADS5294EVM Test Point Locations

Table 5. Miscellaneous Test Points

Reference Designator	Description
TP22	VCM: Common-mode output pin, 0.95-V output
TP6	CDC_VTH: Fixed voltage level (1.65 V)
TP_D0	SCLK: Serial clock input
TP_D1	SDA: Serial data input
TP_D2	SEN: Serial enable chip select
TP_D7	SDOUT: Serial data output
JP14	RESET: Install to reset the device (DUT1) manually
JP12	PD: Install to power down the device (DUT1) manually

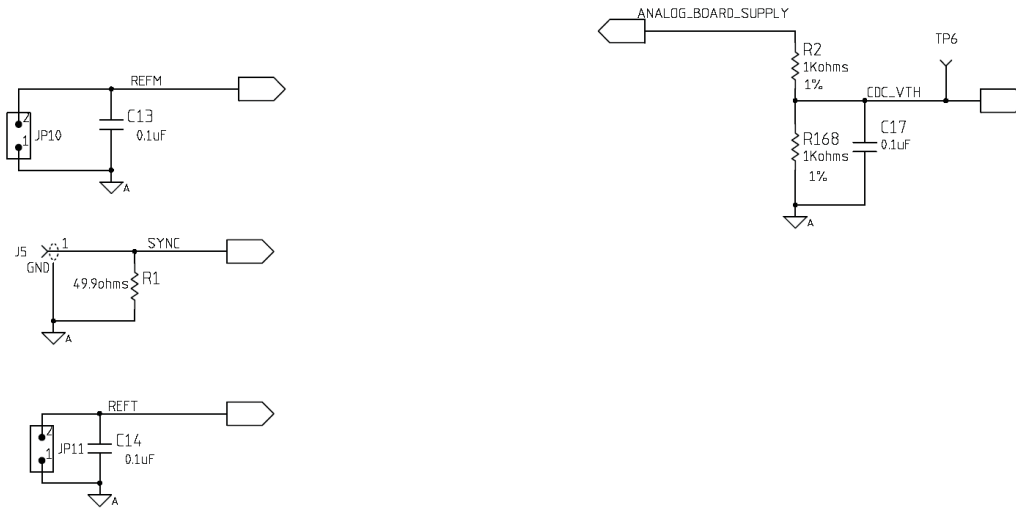

Figure 16. Schematic, Sheet 2 of 9

USB Interface and serial control

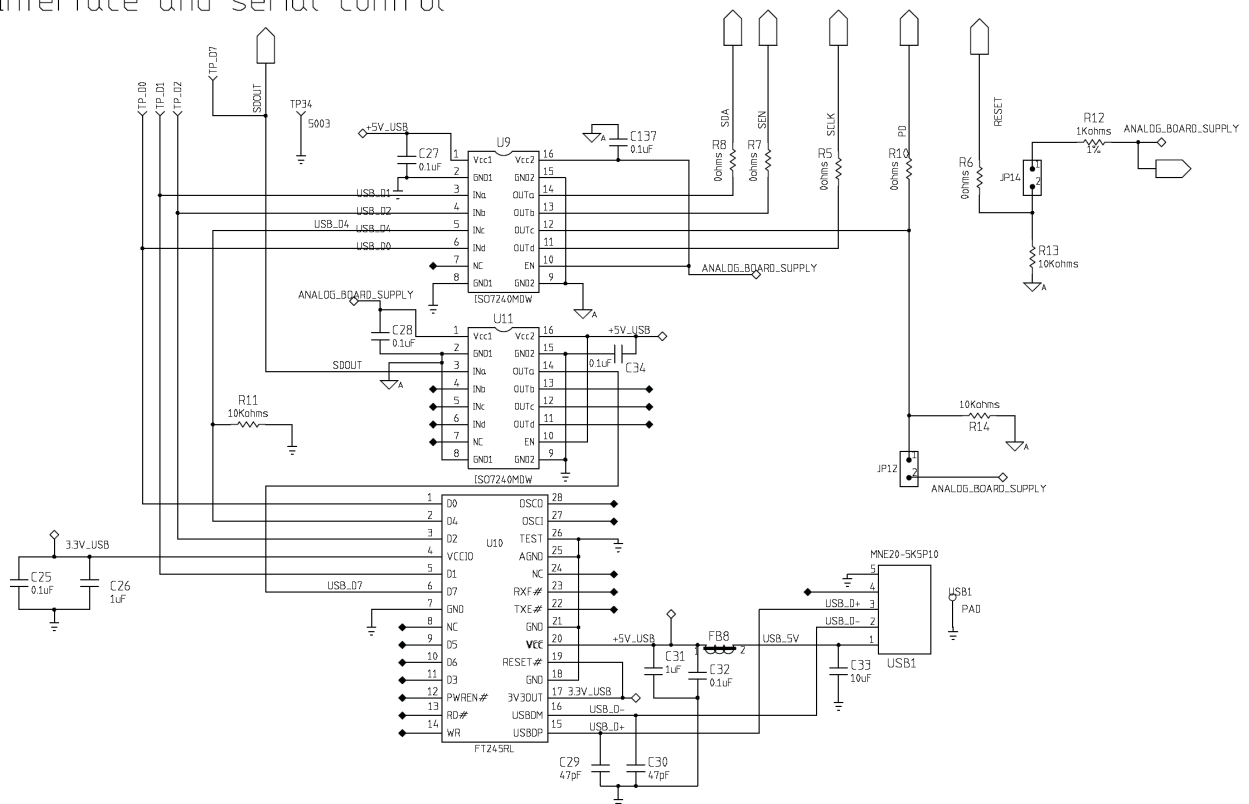

Figure 17. Schematic, Sheet 3 of 9

ADC CLOCK

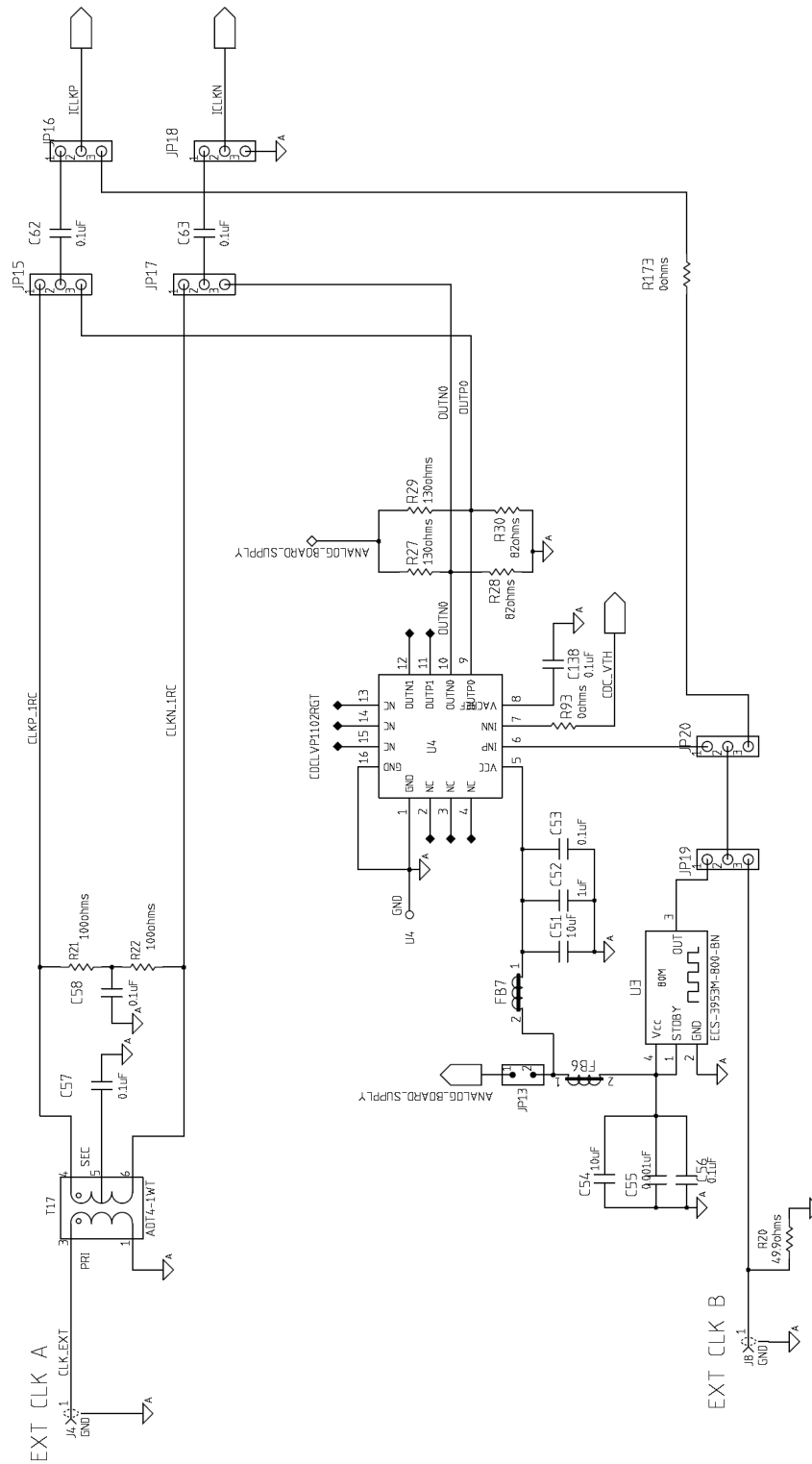

Figure 19. Schematic, Sheet 5 of 9

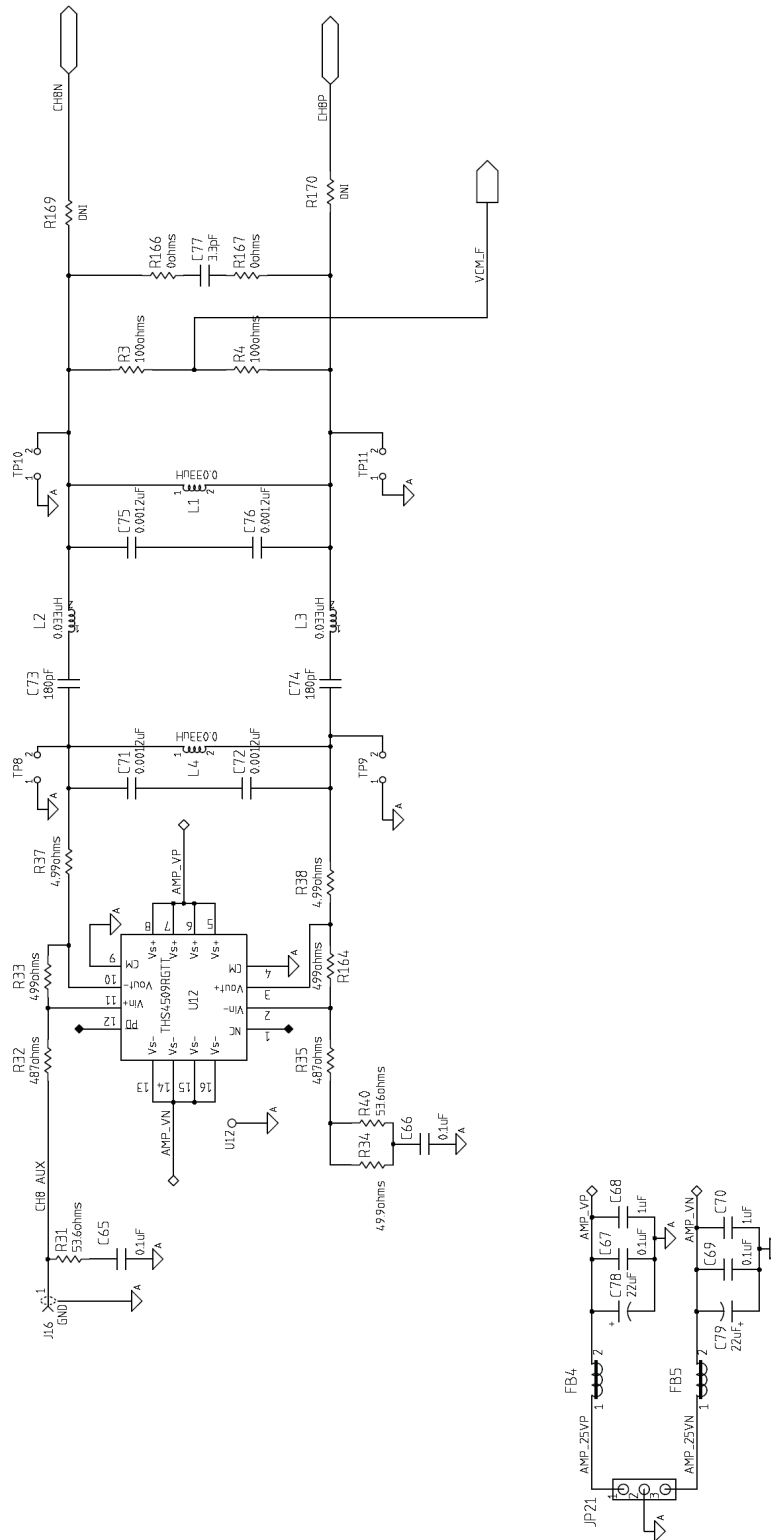

Figure 20. Schematic, Sheet 6 of 9

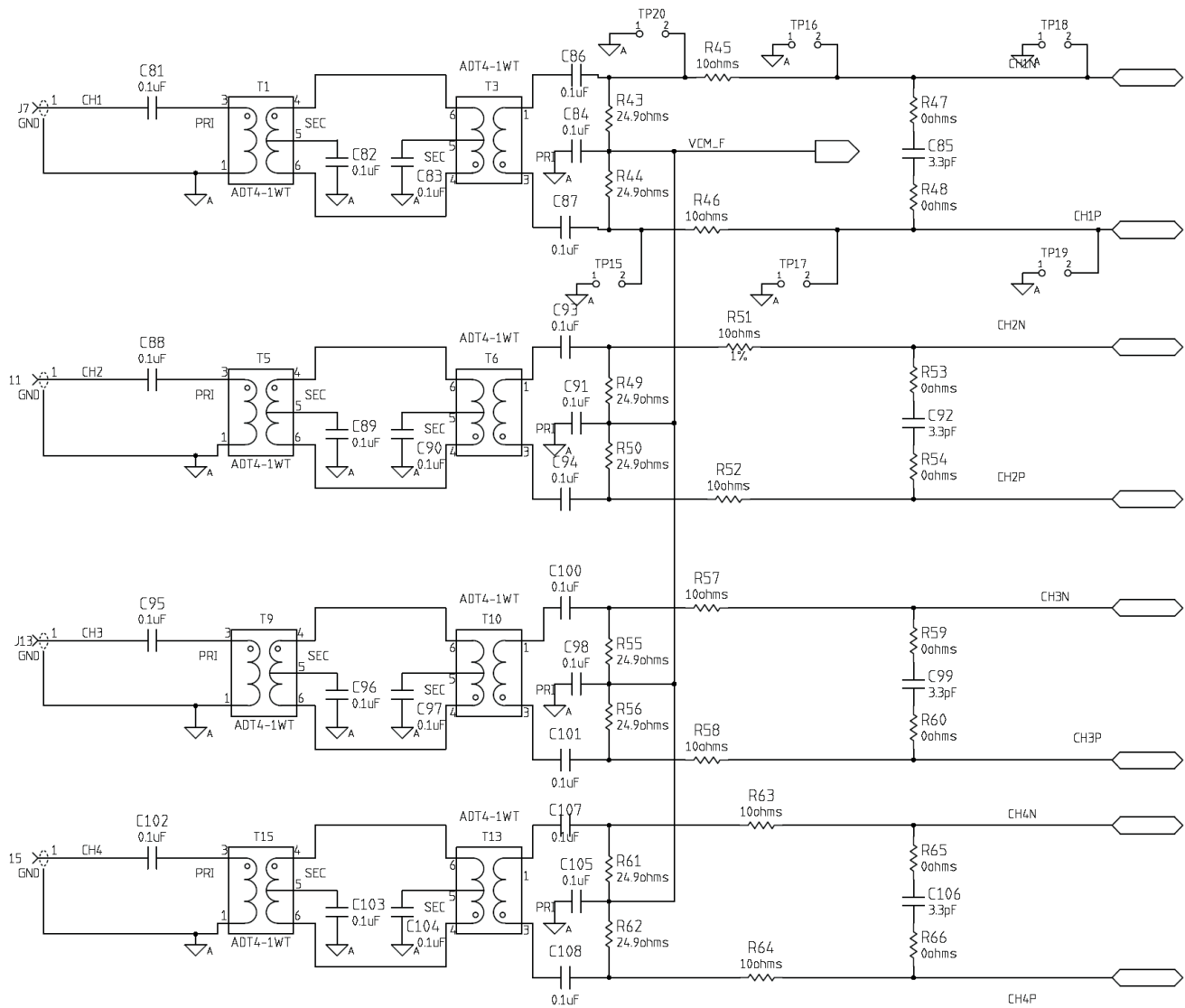

Figure 21. Schematic, Sheet 7 of 9

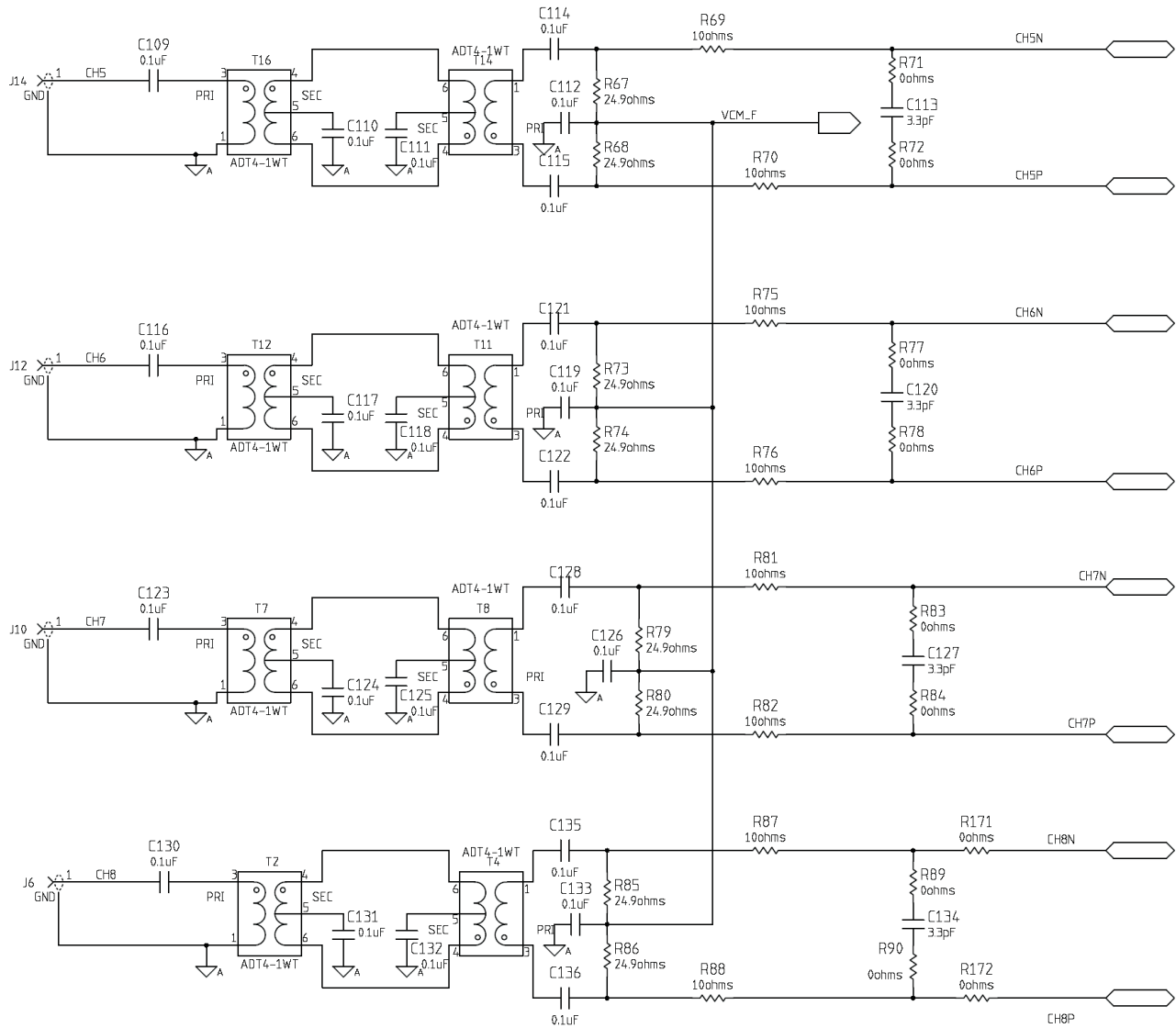

Figure 22. Schematic, Sheet 8 of 9

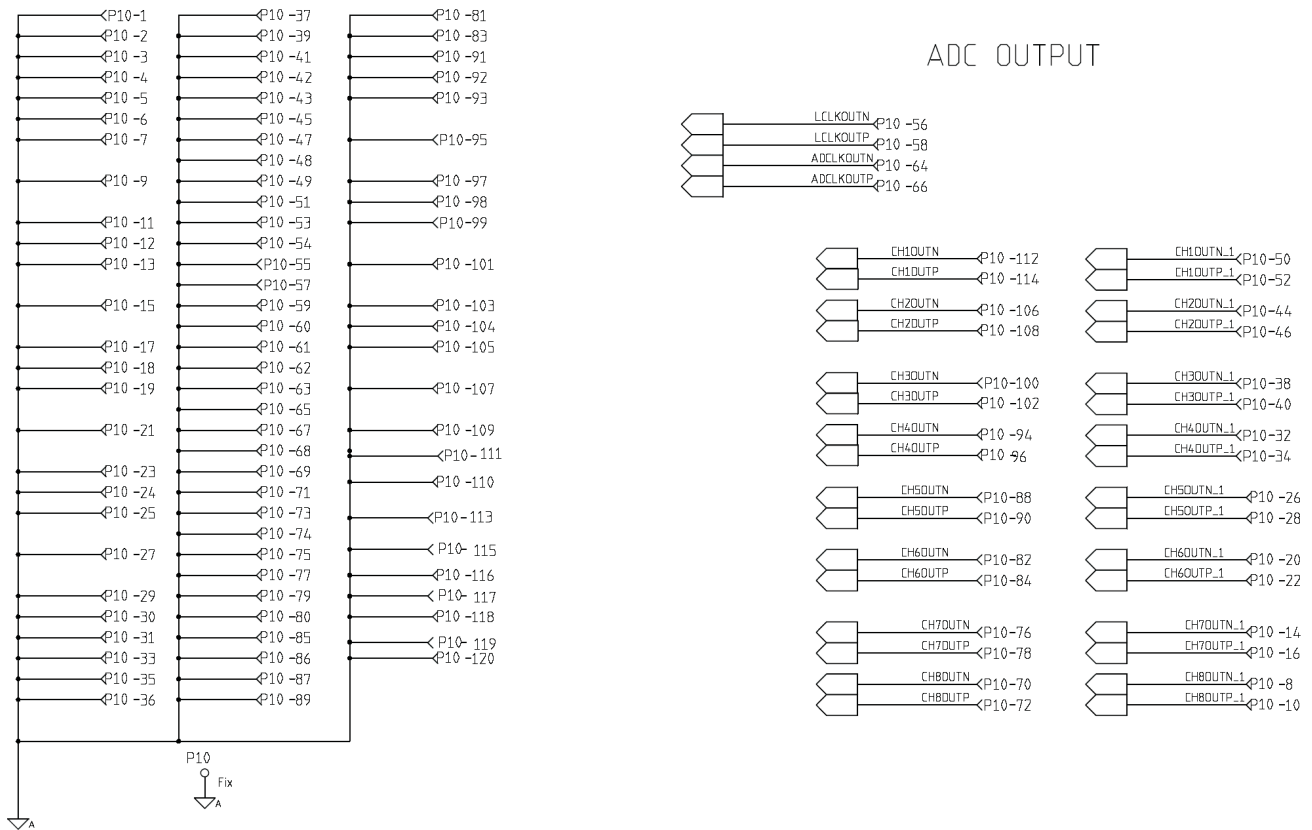

Figure 23. Schematic, Sheet 9 of 9

11 ADS5294EVM Bill of Materials

Bill of Materials

QTY	MFR P/N	Description	Value	MFR	REF DES
1	ADS5294IPFP	14-Bit 8-Channel ADC	ADS5294	Texas Instruments	DUT1
17	ADT4-1WT+	RF TRANSFORMER WIDEBAND, 2-775 MHz, 50 Ω	ADT4-1WT+	Mini-Circuits	T1–T17
1	CDCLVP1102RGT	TWO LVPECL OUTPUT CLOCK BUFFER	CDCLVP1102	Texas Instruments	U4
2	CRCW06034R99FKEA	RES 4.99 Ω, 1/10 W, 1% 0603 SMD	4.99 Ω	Vishay/Dale	R37, R38
16	CRCW040210R0FKED	RES 10 Ω, 1/16W, 1% 0402 SMD	10 Ω	Vishay/Dale	R45, R46, R51, R52, R57, R58, R63, R64, R69, R70, R75, R76, R81, R82, R87, R88
1	CRCW040249R9FKED	RES 49.9 Ω, 1/16W, 1% 0402 SMD	49.9 Ω	Vishay/Dale	R34
2	CRCW060353R6FKEA	RES 53.6 Ω 1/10W 1% 0603 SMD	53.6 Ω	Vishay/Dale	R31, R40
1	CRCW06030000Z0EA	RES 0 Ω 1/10W 0603 SMD	0 Ω	Vishay/Dale	R36
2	CRCW0603487RFKEA	RES 487 Ω 1/10W 1% 0603 SMD	487 Ω	Vishay/Dale	R32, R35
4	CRCW0402100RFKED	RES 100 Ω 1/16W 1% 0402 SMD	100 Ω	Vishay/Dale	R3, R4, R21, R22
3	CRCW04021K00FKED	RES 1K Ω 1/16W 1% 0402 SMD	1 kΩ	Vishay/Dale	R2, R12, R168
2	CRCW0402499RFKED	RES 499 Ω 1/16W 1% 0402 SMD	499 Ω	Vishay/Dale	R33, R164
3	CRCW080510K0FKEA	RES 10K Ω 1/8W 1% 0805 SMD	10K Ω	Vishay/Dale	R11, R13, R14
7	C0402C104K8PACTU	CAP 0.10UF 10V CERAMIC X5R 0402	0.1 μF	Kemet	C36, C37, C40, C41, C44, C45, C48
1	ECJ-0EB1H102K	CAPACITOR, SMT, 0402, CER, 1000pF, 50V, 10%, X7R	1000 pF	Panasonic	C55
4	ECJ-0EB1H122K	CAPACITOR, SMT, 0402, CER, 1200pF, 50V, 10%, X7R	1200 pF	Panasonic	C71, C72, C75, C76
2	ECJ-0EB1E181K	CAP 180PF 25V CERAMIC X7R 0402	180 pF	Panasonic	C73, C74
2	ECJ-0EC1H390J	CAP 39PF 50V CERAMIC 0402 SMD	39 PF	Panasonic	C29, C30
5	ECJ-1V41E105M	CAP 1UF 25V CERAMIC 0603 X5S	1 μF	Panasonic - ECG	C26, C31, C52, C68, C70
1	ECS-3953M-800-BN	OSC, SMT, 3.3V, 50ppm, -40–85°C, 5nS, 80.000 MHz	OSC 80 MHz	ECS Inc	U3
4	ELJ-RE33NGFA	INDUCTOR 33NH 2% 0603 SMD	33NH	Panasonic	L1–L4
2	ERJ-2GEJ131	RESISTOR, SMT, 0402, THICK FILM, 5%, 1/16W, 130	130 Ω	Panasonic	R27, R29
2	ERJ-2GEJ820	RESISTOR, SMT, 0402, THICK FILM, 5%, 1/16W, 82	82 Ω	Panasonic	R28, R30
27	ERJ-2GE0R00X	RESISTOR/JUMPER, SMT, 0402, 0 Ω, 5%, 1/16W	0 Ω	Panasonic	R5–R8, R10, R47, R48, R53, R54, R59, R60, R65, R66, R71, R72, R77, R78, R83, R84, R89, R90, R93, R166, R167, R171–R173
16	ERJ-2RKF24R9X	RESISTOR, SMT, 0402, 24.9 Ω, 1%, 1/16W	24.9 Ω	Panasonic	R43, R44, R49, R50, R55, R56, R61, R62, R67, R68, R73, R74, R79, R80, R85, R86
2	ERJ-2RKF49R9X	RESISTOR, SMT, 0402, 49.9 Ω, 1%, 1/16W	49.9 Ω	Panasonic	R1, R20
3	ERJ-2RKF1000X	RESISTOR, SMT, 0402, 100 Ω, 1%, 1/10W	100 Ω	Panasonic	R15, R16, R18
1	ERJ-2RKF3320X	RESISTOR, SMT, 0402, 332 Ω, 1%, 1/16W	332 Ω	Panasonic	R17
1	FT245RL	USB FIFO IC INCORPORATE FTDICHIP-ID SECURITY DONGLE	USB	FTDI	U10
9	GRM1555C1H3R3CZ01D	CAP CER 3.3PF 50V C0G 0402	3.3 pF	Murata	C77, C85, C92, C99, C106, C113, C120, C127, C134
8	HI0805R800R-10	FERRITE CHIP POWER 80 Ω SMD	FERRITE	Laird-Signal Integrity Products	FB1–FB8
2	ISO7240MDW	QUAD DIGITAL ISOLATORS	IC DGTL ISOL	Texas Instruments	U9, U11
3	JMK107BJ106MA-T	CAPACITOR, SMT, 0603, CERAMIC, 10μF, 6.3V, 20%, X5R	10 μF	Taiyo Yuden	C33, C51, C54
10	JUMPER-0603(UN)	UNINSTALLED JUMPER, SMT0603	DNI		TP8–TP11, TP15–TP20

Bill of Materials (continued)

QTY	MFR P/N	Description	Value	MFR	REF DES
3	LNJ308G8PRA	LED, SMT, 0603, PURE GREEN, 2.03V	LED	Panasonic	LED18VA, LED18VD, LED_+5V
1	LNJ808R8ERA	LED, SMT, 0603, ORANGE, 1.8V	LED	Panasonic	LED33VA
1	897-43-005-00-100001	CONN RECEPT MINI-USB TYPE B SMT	USB Mini B	Mill-Max	USB1
1	QTH-060-01-L-D-A	HEADER, SMT, 120P, 0.5mm, FEM, 2BANK, RECEPTACLE, 168/198H	CONN	Samtec Inc	P10
2	TEST POINT YELLOW	NOT INSTALLED	DNI		TP22, TP35
1	THS4509QRGTRQ1	WIDEBAND, LOW NOISE, LOW DISTORTION FULLY DIFF AMP, 1900 MHz	IC OPAMP	Texas Instruments	U12
9	TPSC226K016R0375	10%, 16V, 22µF	22 µF	AVX	C35, C38, C39, C4, C43, C46, C47, C78, C79
2	TPS79618DCQR	ULTRALOW-NOISE HI PSRR FAST RF 1-A LDO LINEAR REGULATOR, 1.8V	LDO REG	Texas Instruments	U6, U7
1	TPS79633DCQR	ULTRALOW-NOISE HI PSRR FAST RF 1-A LDO LINEAR	LDO REG	Texas Instruments	U8
1	1SMB5921BT3G	DIODE ZENER 6.8V 3W SMB	DIODE Zener	ON Semiconductor	Z1
5	9-146285-0-02	CONN HEADR BRKWAY 0.100 02POS STR	CONN Header	TE Connectivity	JP10–JP14
10	9-146285-0-03	CONN HEADR BRKWAY 0.100 03POS STR	CONN Header	TE Connectivity	JP4–JP6, JP15–JP21
12	901-144-8	SMA COAX STRAIGHT PCB CURRENT P/N IS 901-144-8RFX	SMA	Amphenol	J4–J8, J10–J16
76	0402YD104KAT2A	CAP CERM 0.1µF 10% 16V X5R 0402	0.1 µF	AVX	C1–C8, C13 C14, C17, C25, C27, C28, C32, C34, C53, C56–C58, C6, C63, C65–C67, C69, C81–C84, C86–C91, C93–C98, C100–C105, C107–C112, C114–C119, 121–C126, C128–C133, C135–C138
1	5000	TESTPOINT, THU, MINIATURE, 0.1LS, 120TL, RED	Test Point,Red	Keystone Electronics	TP_VP
9	5001	TESTPOINT, THU, MINIATURE, 0.1LS, 120TL, BLACK	Test Point,Black	Keystone Electronics	TP1–TP5, TP14, TP21, TP23, TP25
5	5002	TESTPOINT, THU, MINIATURE, 0.1LS, 120TL, WHITE	Test Point,White	Keystone Electronics	TP6, TP_D0-TP_D2, TP_D7
1	5003	TESTPOINT, THU, MINIATURE, 0.1LS, 120TL, ORANGE	Test Point,Orange	Keystone Electronics	TP34
1	39357-0002	HEADER, THRU, POWER, 2P, 3.5MM, EUROSTYLE	CONN TERMINAL	Molex Connector Corp	P1
2	RESISTOR (DNI)	NOT INSTALLED	DNI		R169, R170
4	24436	STANDOFF HEX M3 THR ALUM 18MM	STANDOFF	Keystone	STANDOFF HEX M3 THR ALUM 18MM
4	29311	SCREW STEEL M3 THR 6MM	SCREW	Keystone	SCREW STEEL M3 THR 6MM

12 ADS5294EVM Printed-Circuit Board Layout

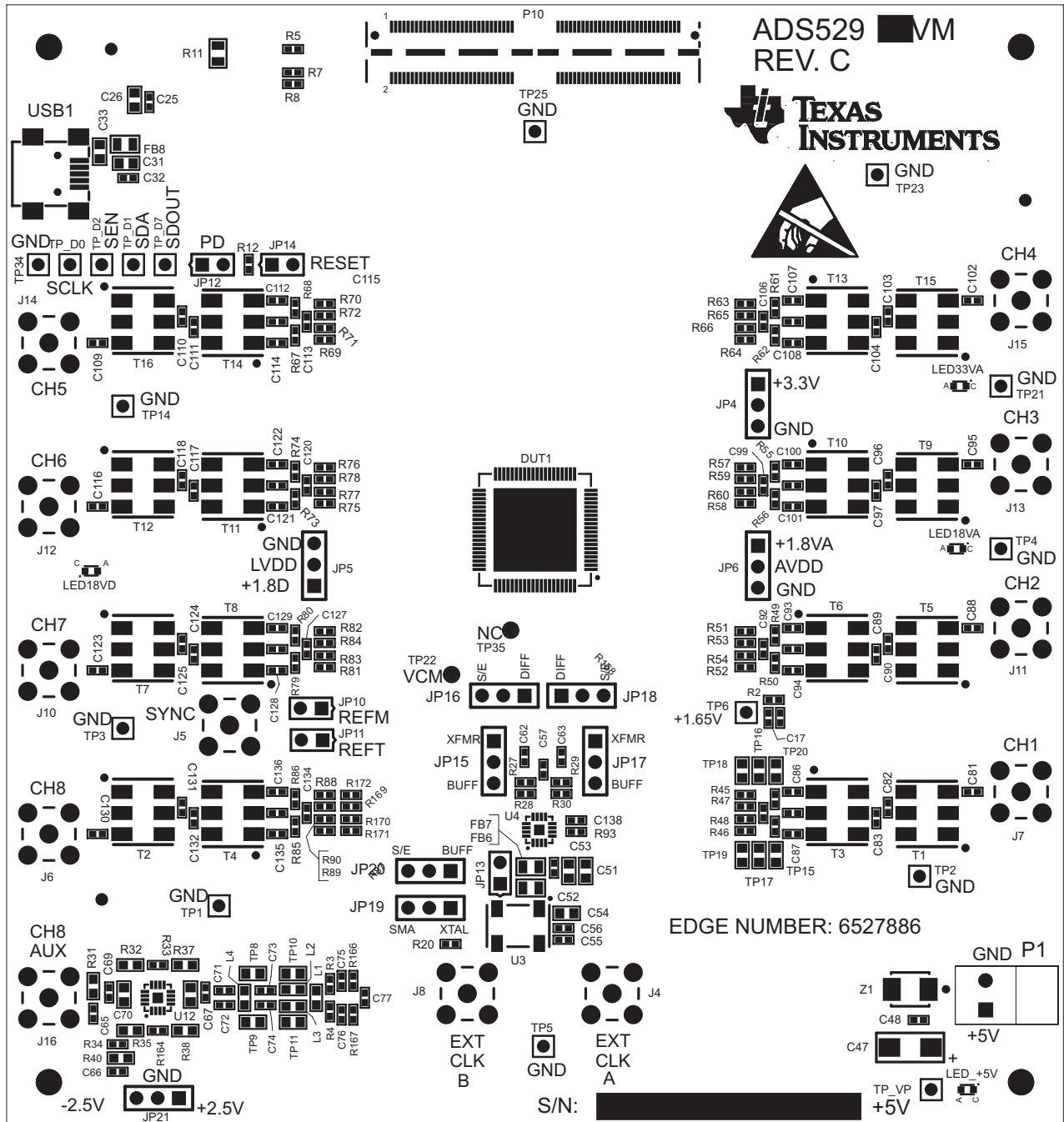

Figure 24. ADS5294EVM Top Layer Assembly Drawing – Top View

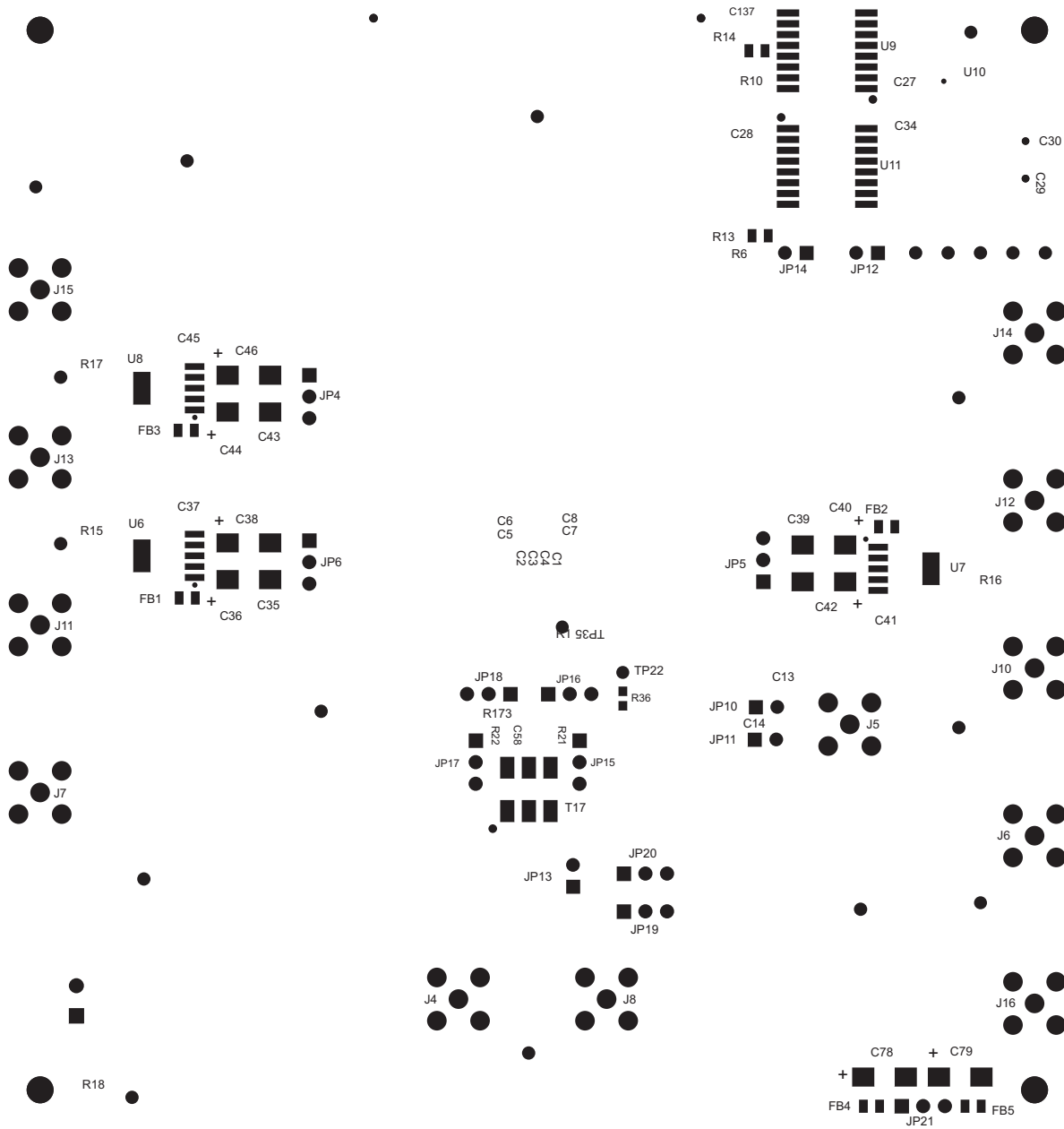

Figure 25. ADS5294EVM Bottom Layer Assembly Drawing – Bottom View

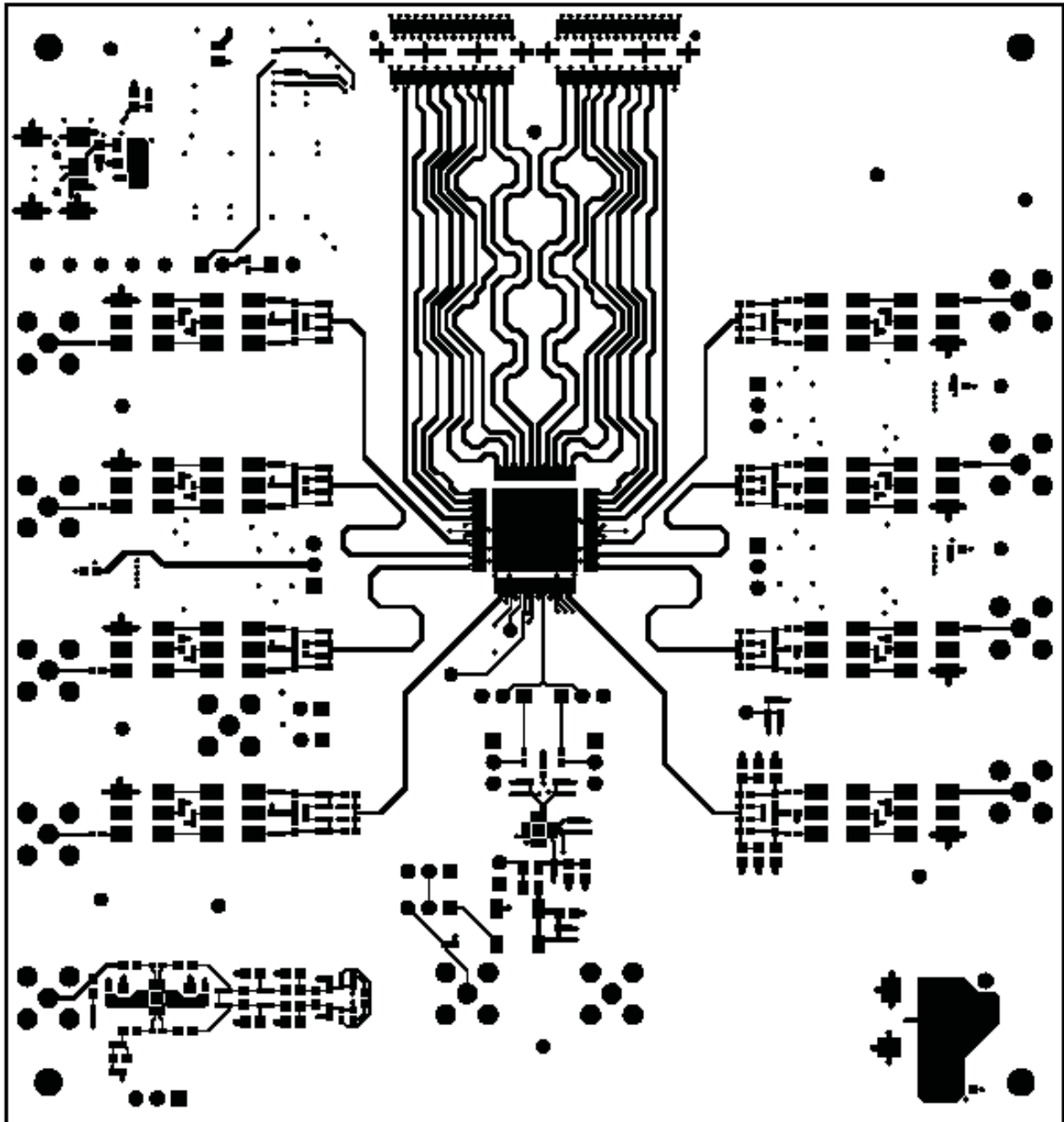

Figure 26. ADS5294EVM Top Layer Copper – Top View

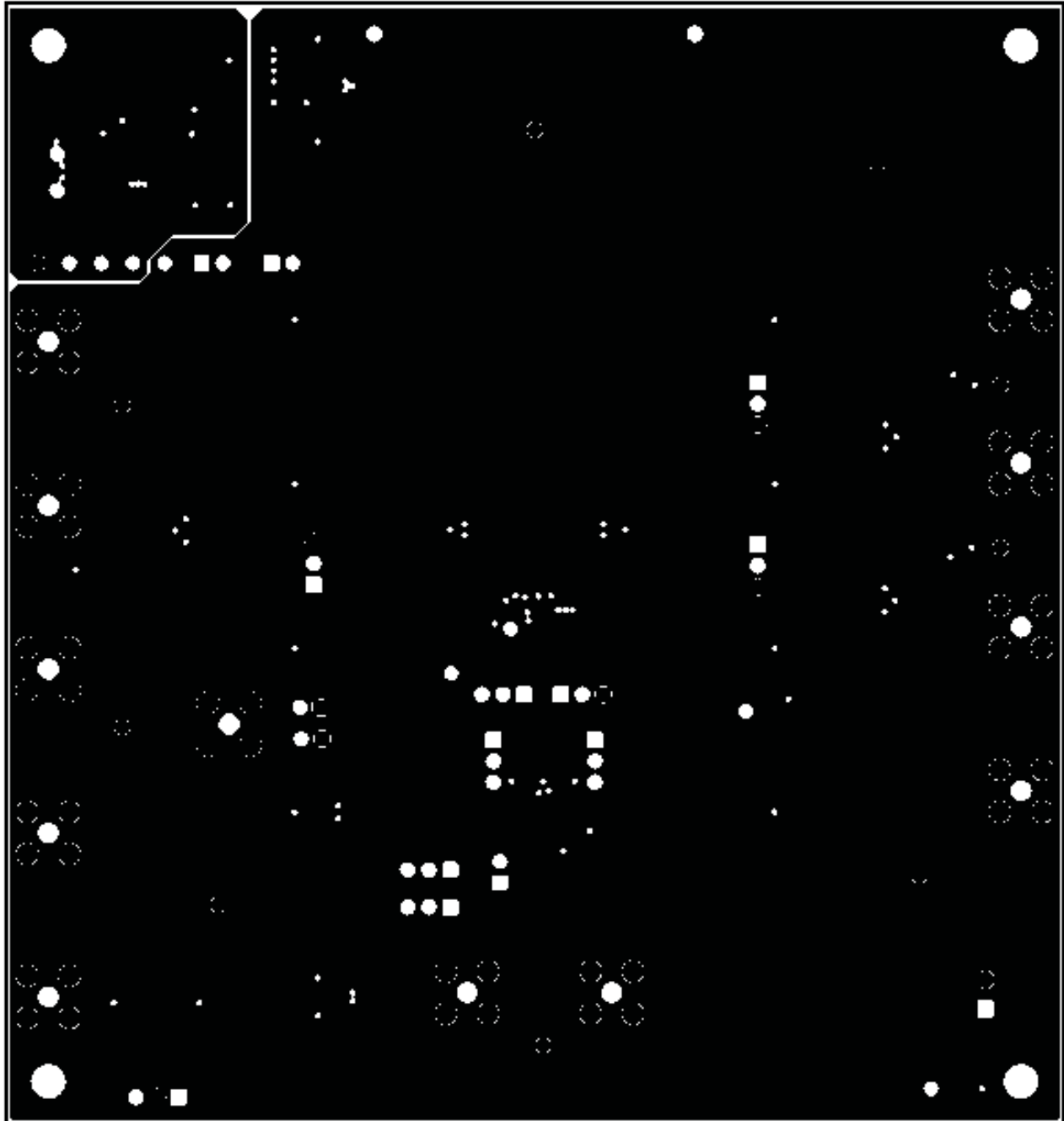

Figure 27. ADS5294EVM Internal Layer 1, Ground – Top View

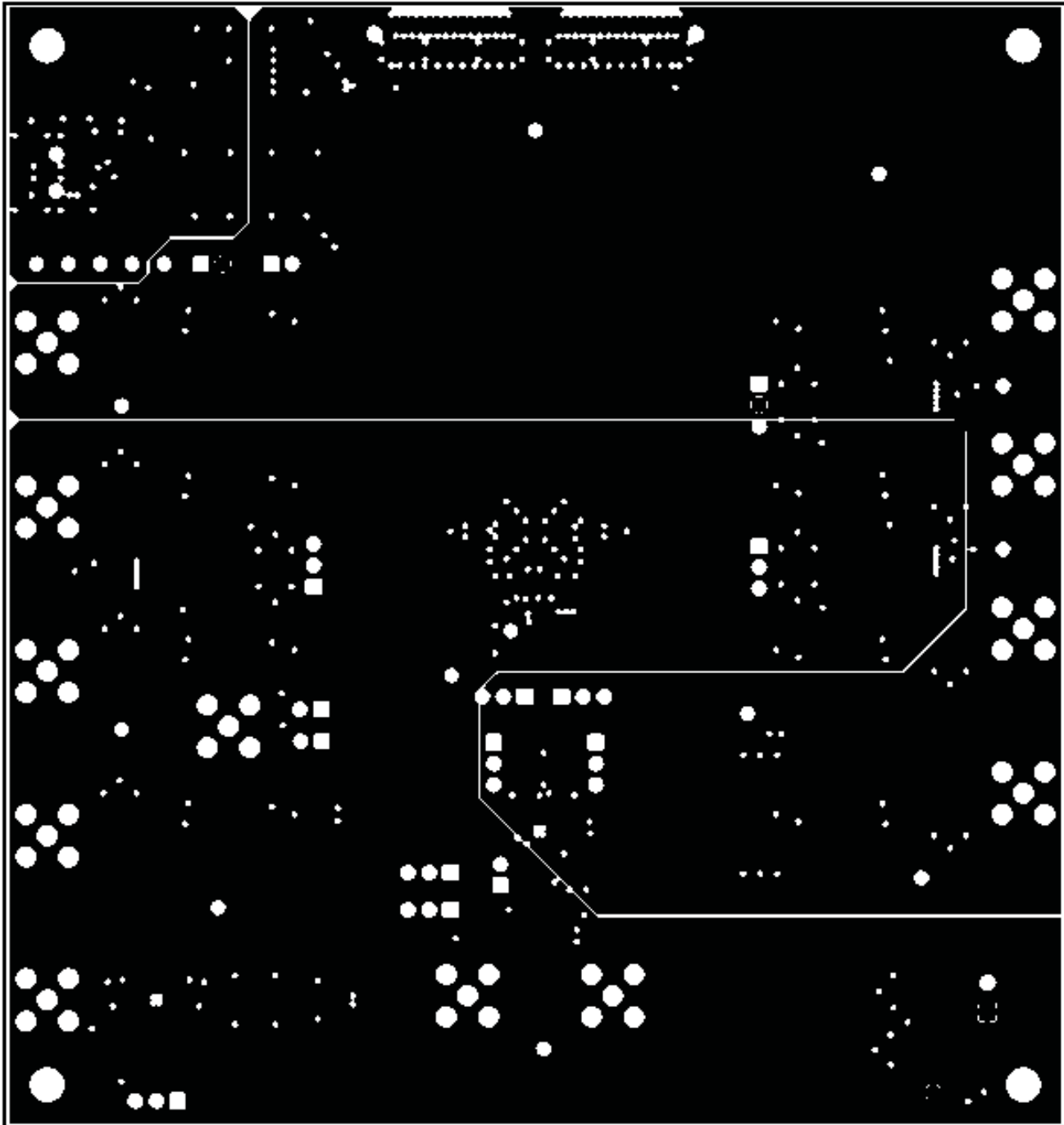

Figure 28. ADS5294EVM Internal Layer 2, Power – Top View

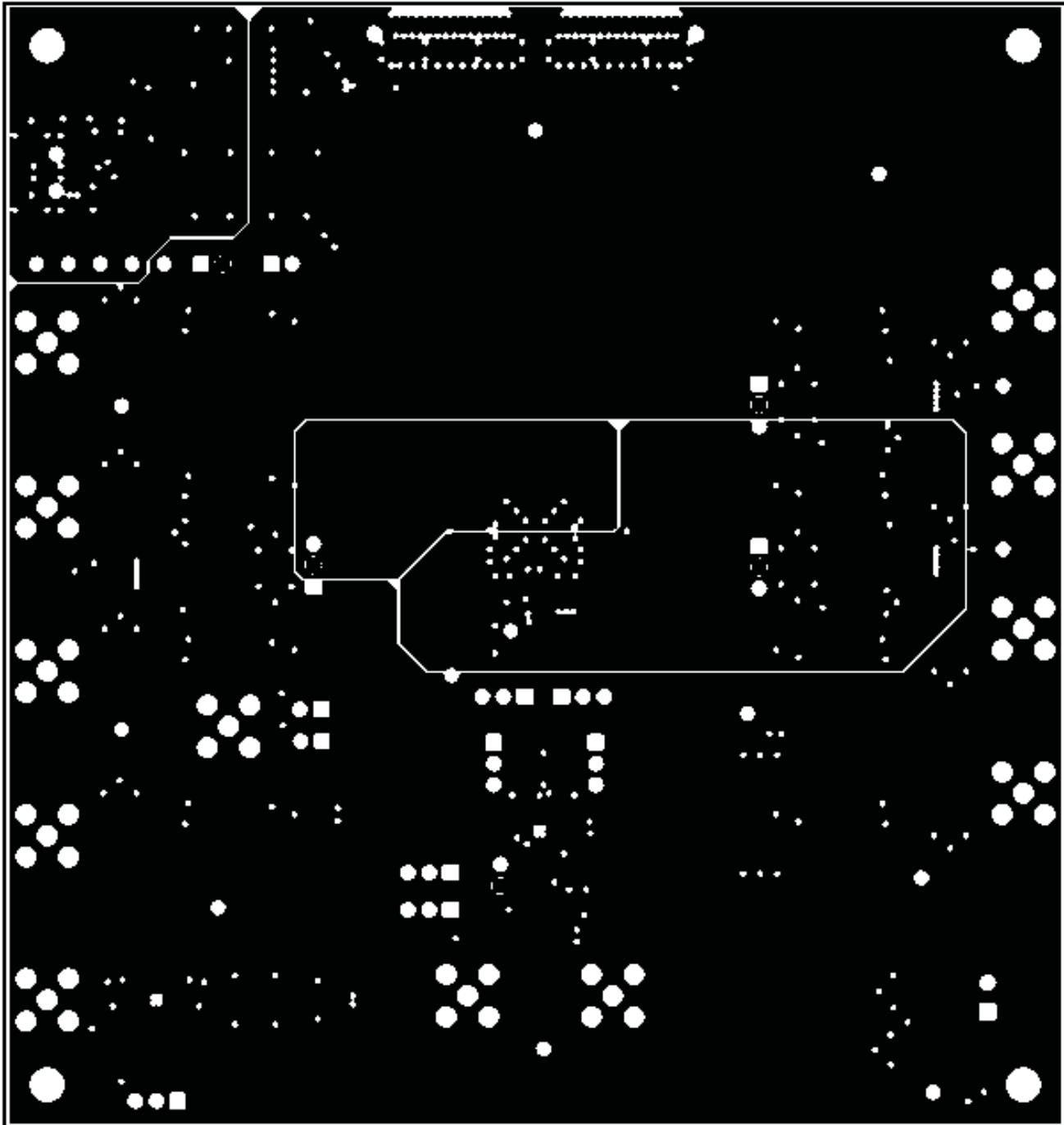

Figure 29. ADS5294EVM Internal Layer 3, Power – Top View

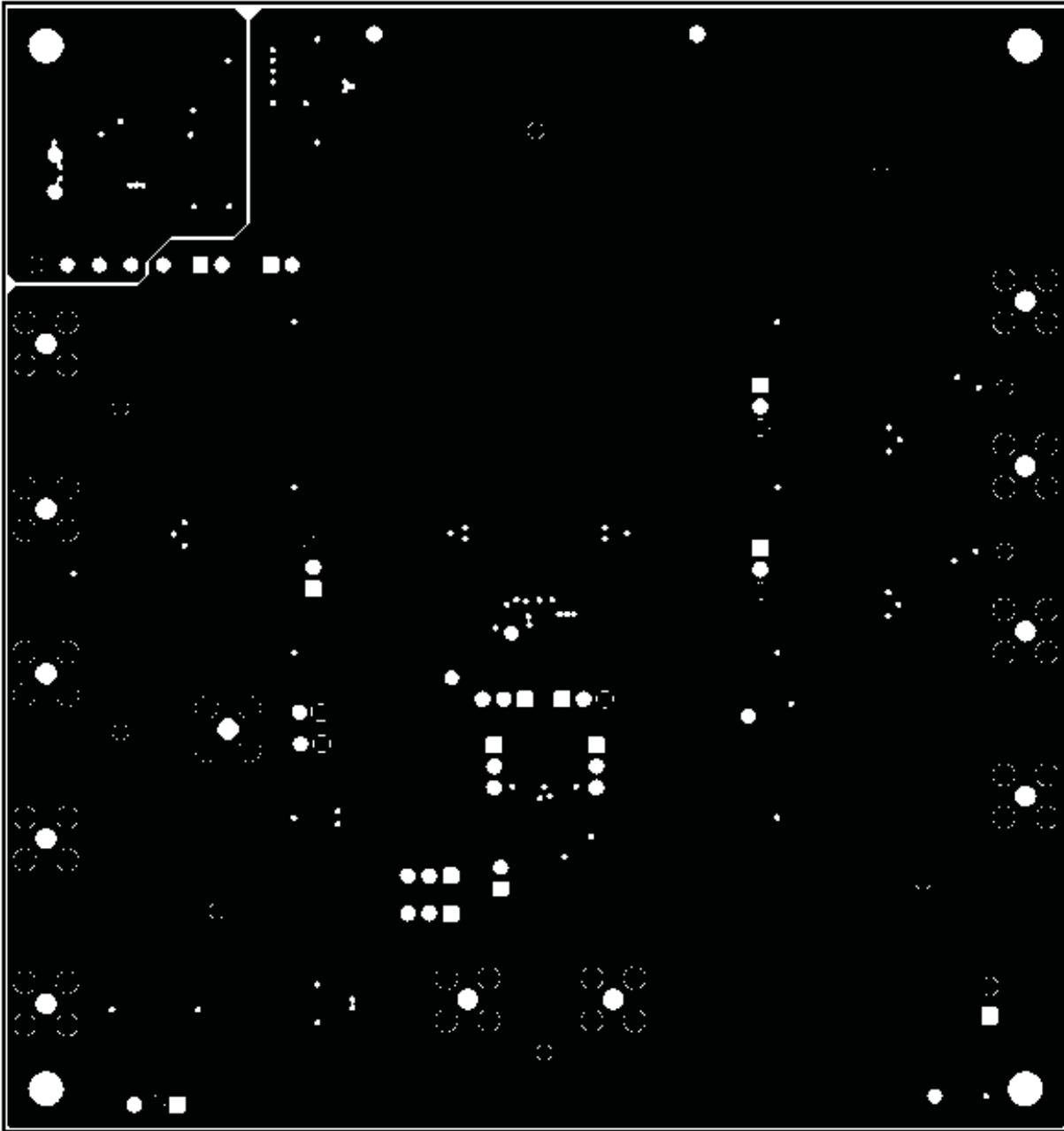

Figure 30. ADS5294EVM Internal Layer 4, Ground – Top View

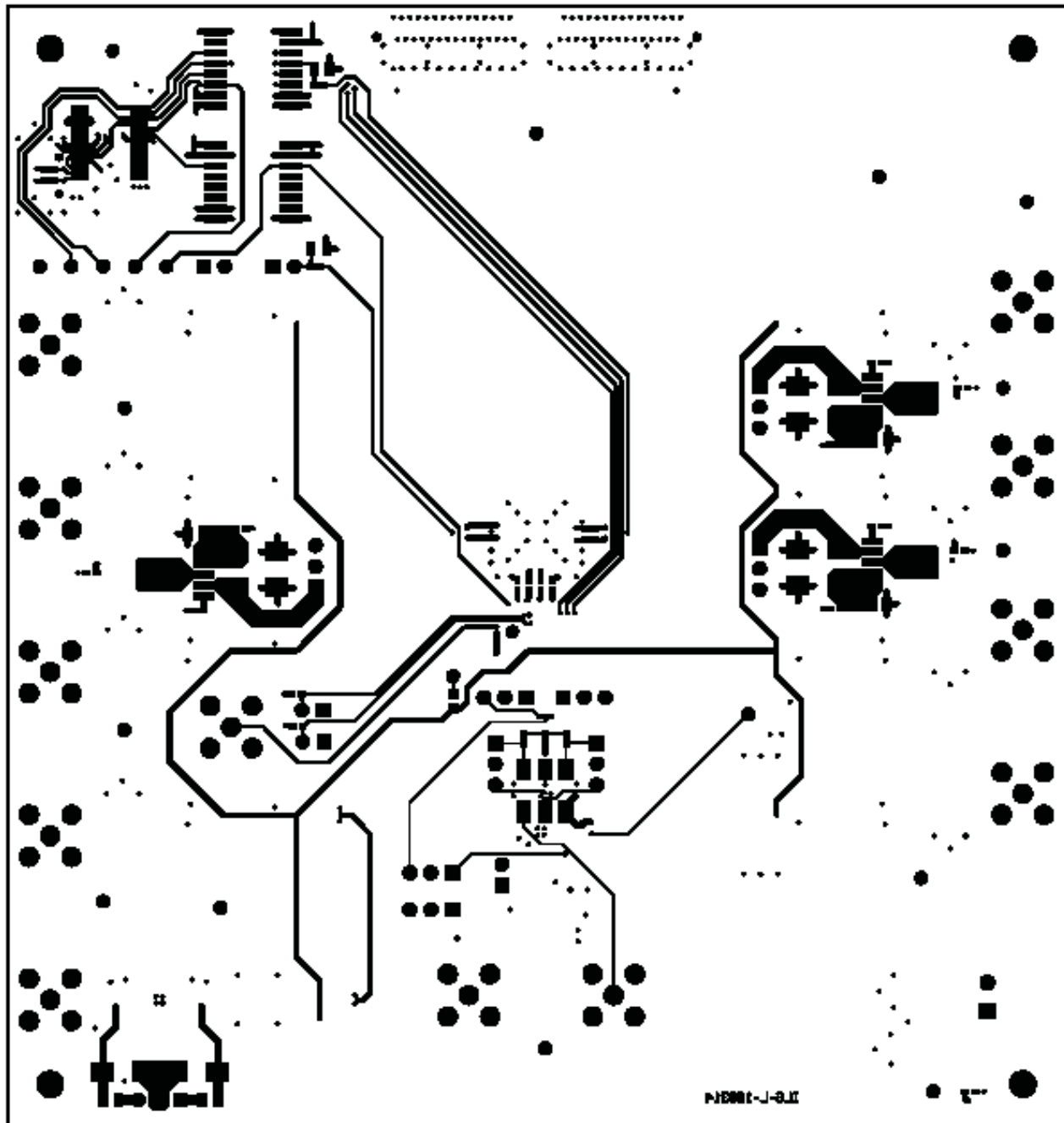

Figure 31. ADS5294EVM Bottom Layer Copper – Top View

High Speed Data Converter Pro (HSDCPro) GUI Installation

Download the HSDCPro GUI Installer using this link: [HSDCPro GUI](#)

- Unzip the saved folder and run the installer executable to obtain the pop-up shown in [Figure 32](#).
- Click the *Install* button.

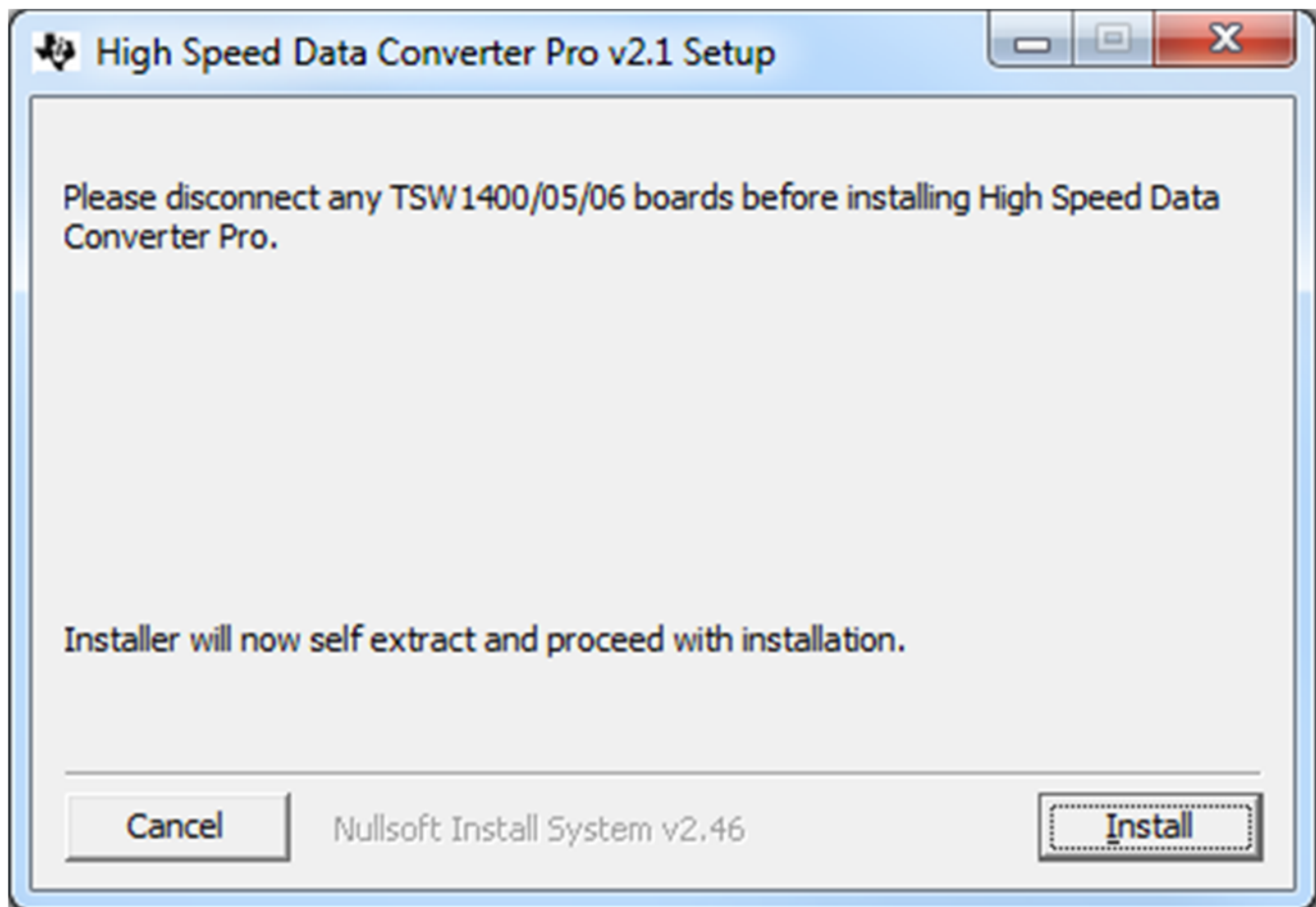

Figure 32. HSDCPro Install (Begin)

- Leave the destination directories as the default location, for the TSW1400GUI installation and press the NEXT button as shown in [Figure 33](#).

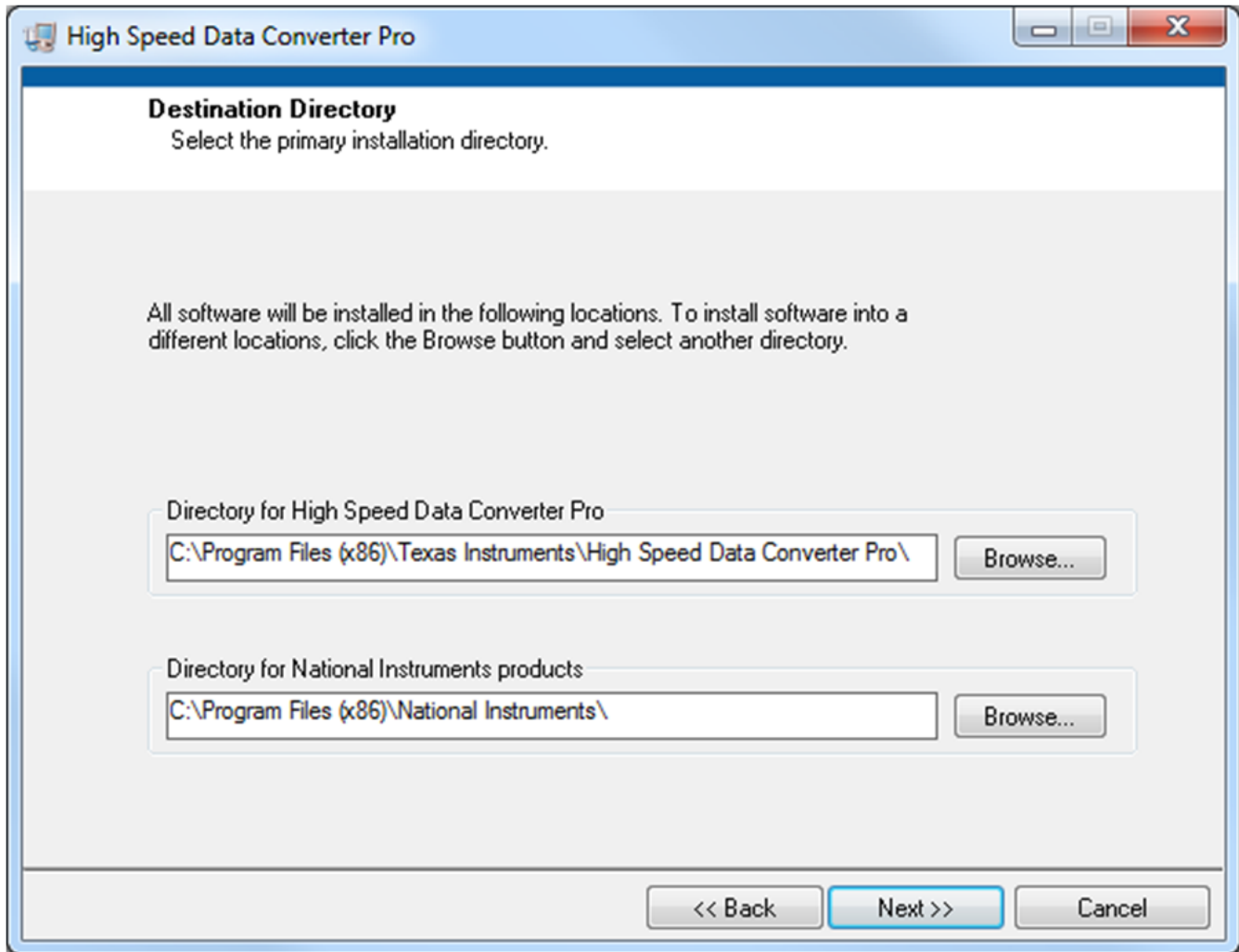

Figure 33. HSDCPro Install (Install Directory)

- Read the License Agreement from Texas Instruments and select *I accept the License Agreement* and press the *Next* button as shown in [Figure 34](#).

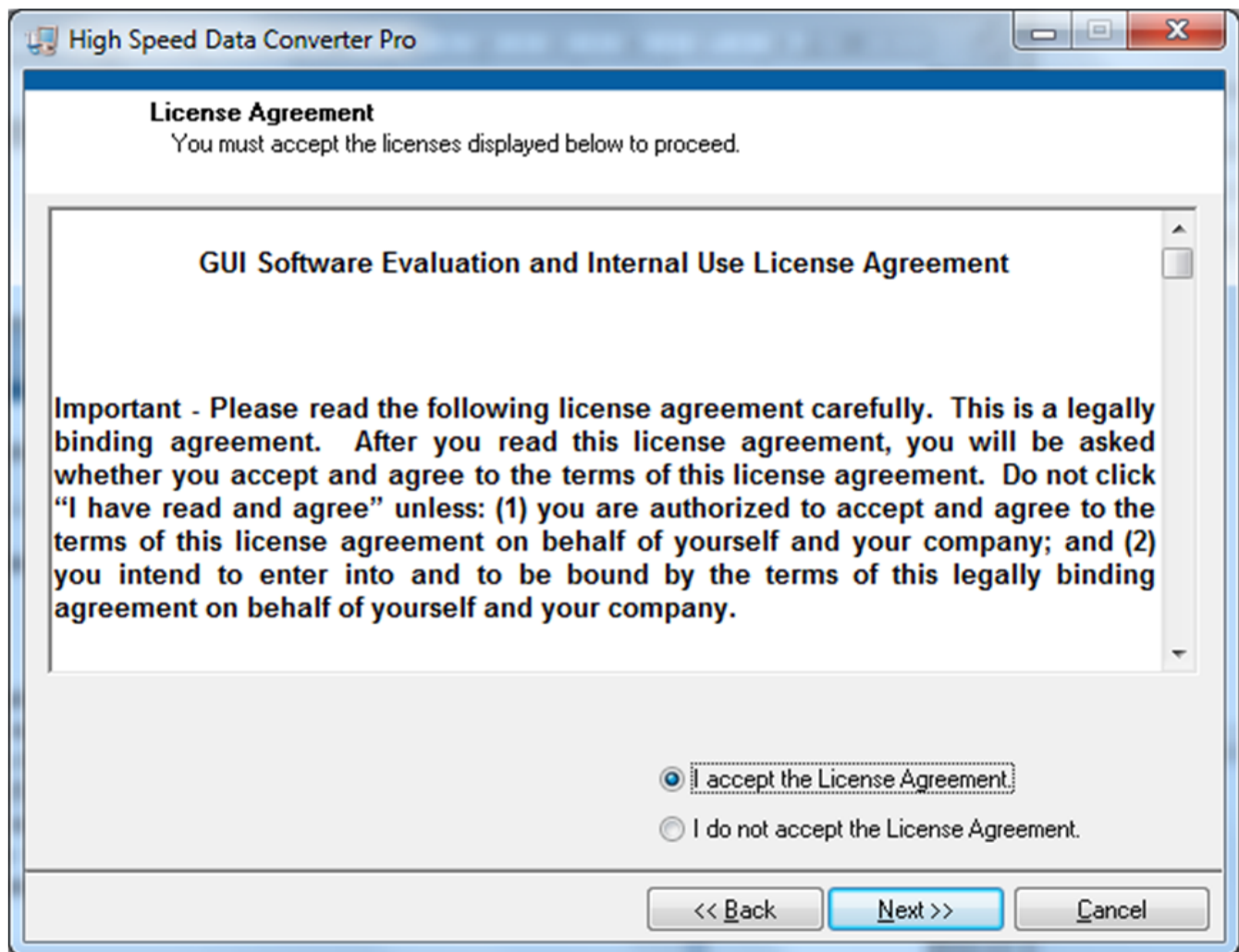

Figure 34. HSDCPro Install (TI License Agreement)

- Read the License Agreement from National Instruments and select *I accept the License Agreement* and press the *Next* button as shown in [Figure 35](#).

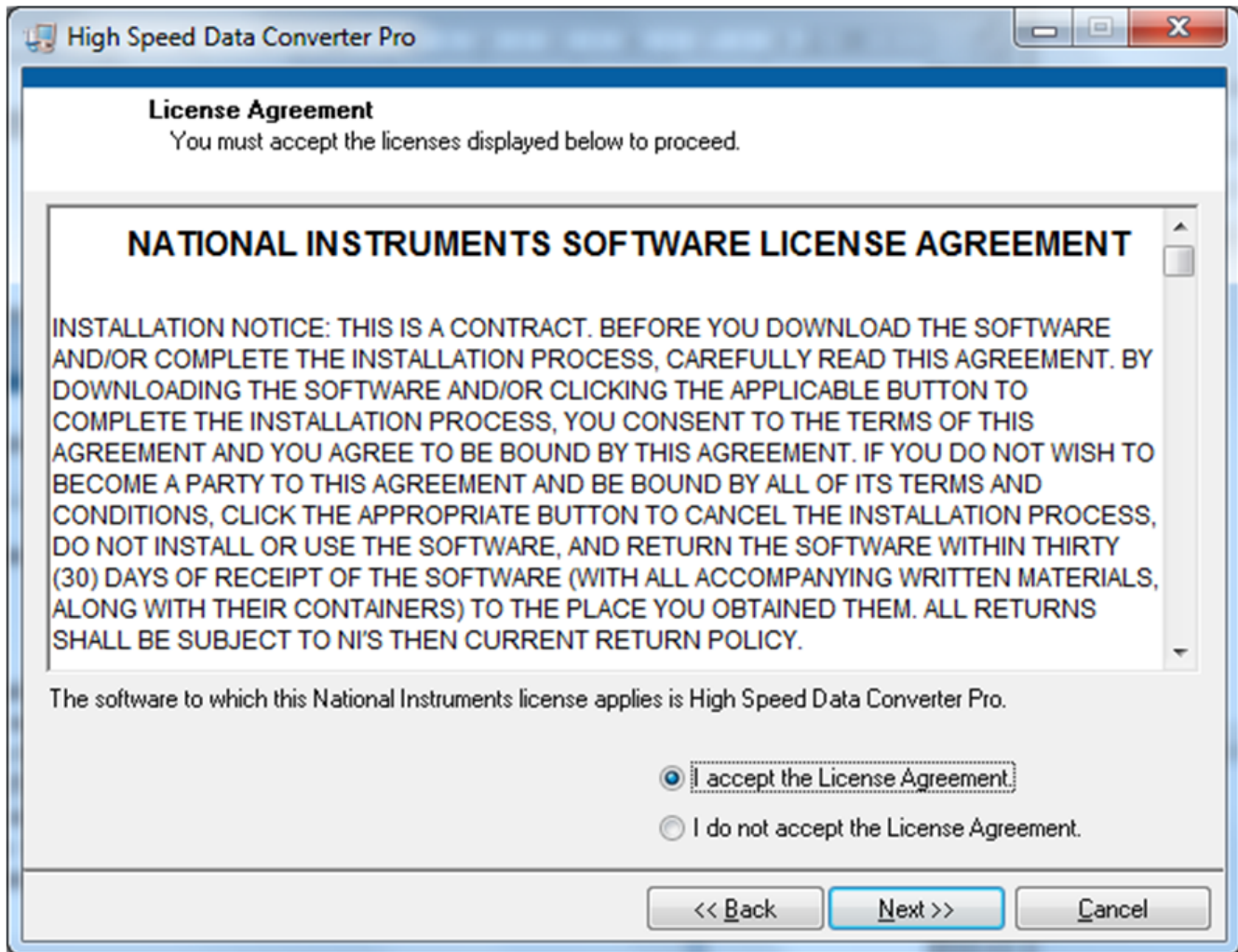

Figure 35. HSDCPro Install (NI License Agreement)

- Press the *Next* button as shown in [Figure 36](#).

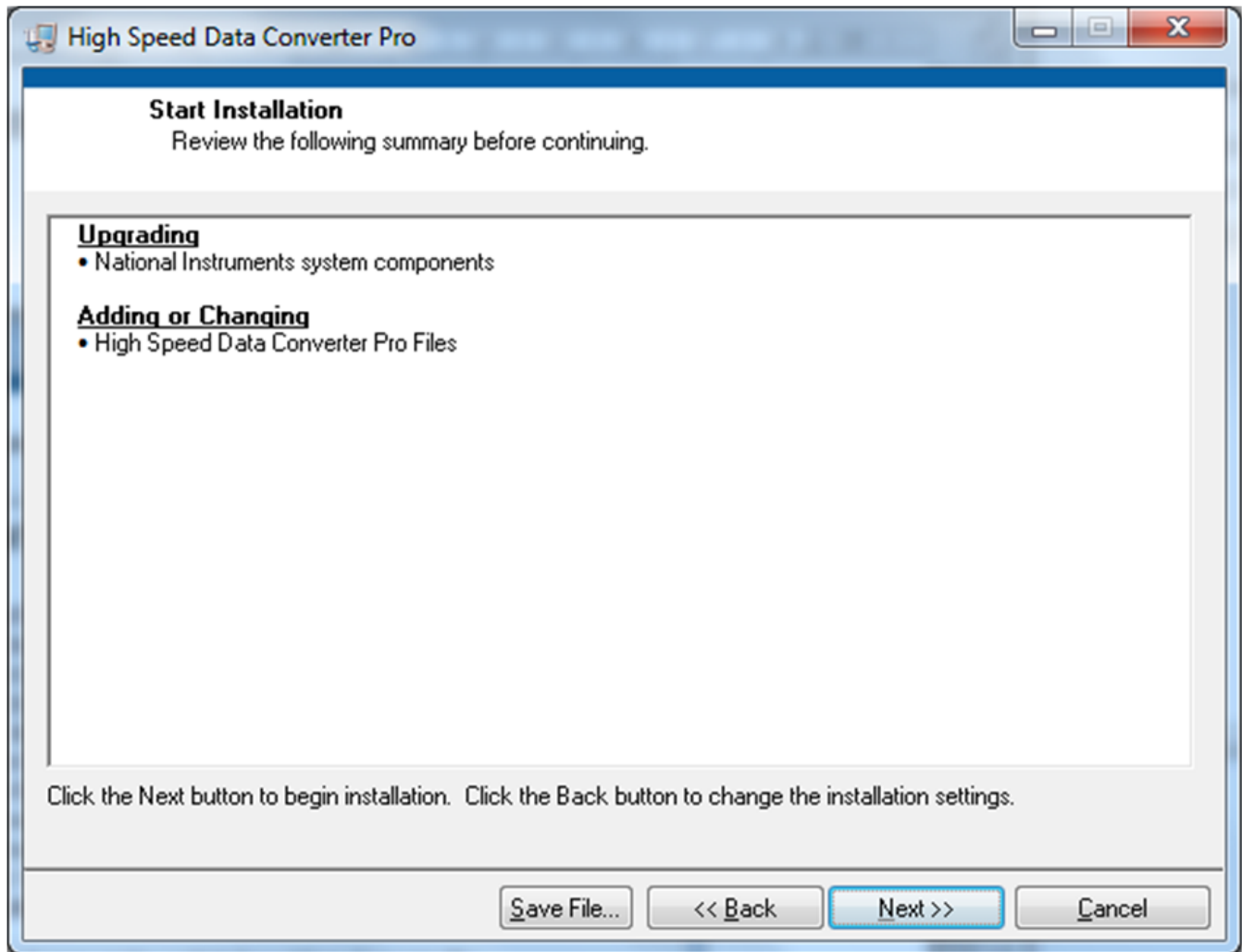

Figure 36. HSDCPro Install (Start Installation)

- The window shown in [Figure 37](#) should appear indicating that the installation is in progress.

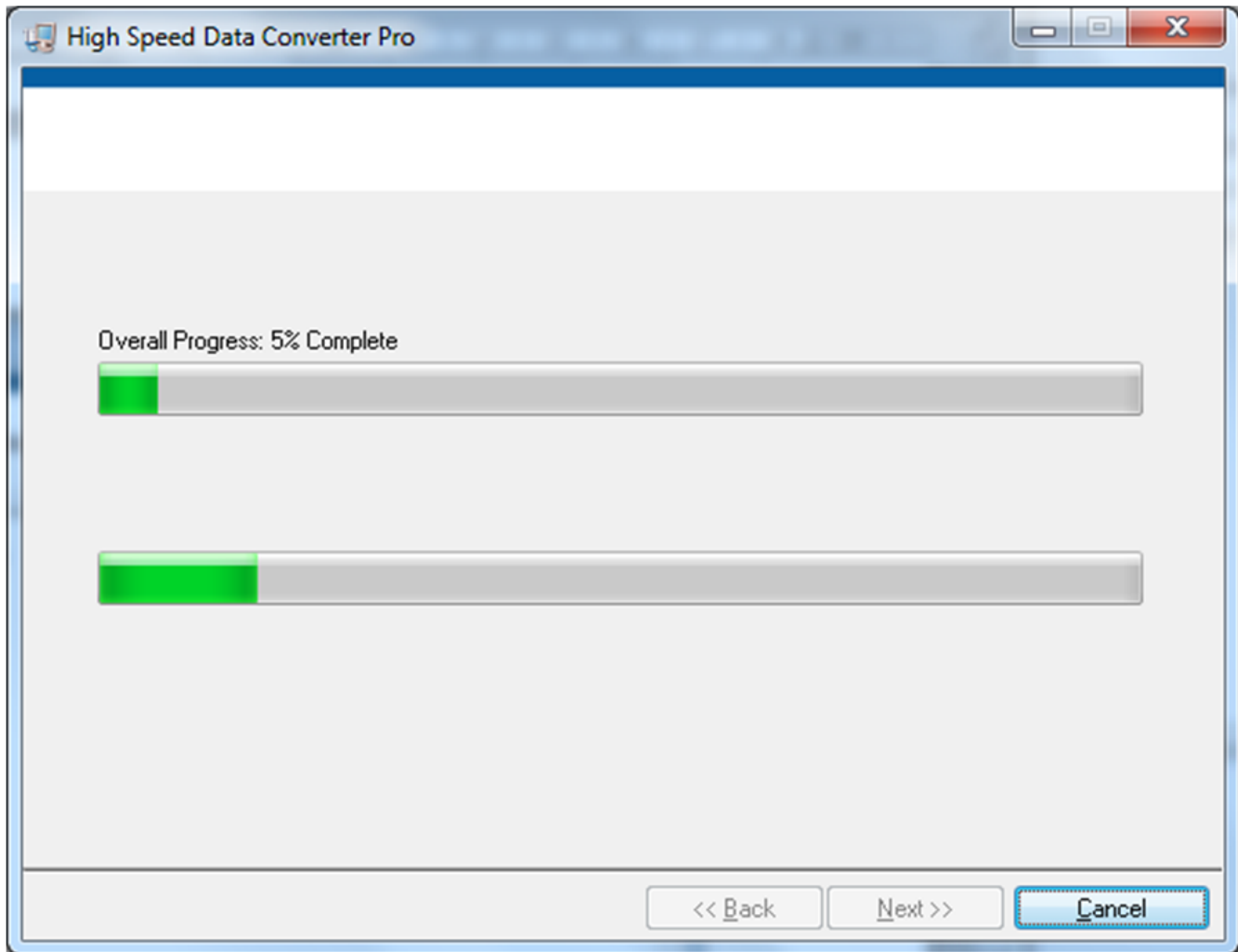

Figure 37. HSDCPro Install (Installation Progress)

- The window shown in [Figure 38](#) appears indicating *Installation Complete*. Press the *Next* button.

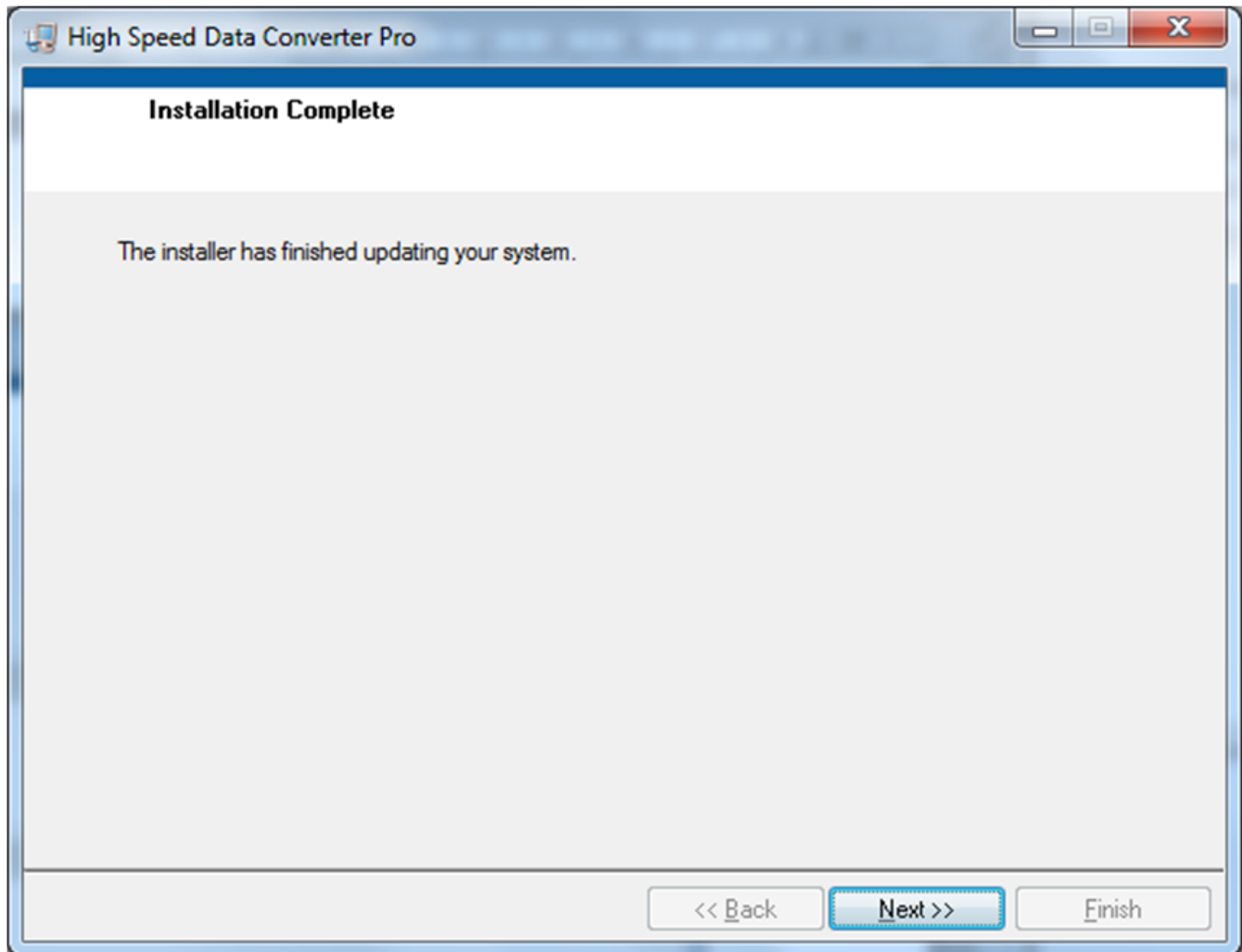

Figure 38. HSDCPro Install (Installation Complete)

- The window shown in [Figure 39](#) appears briefly to complete the process.

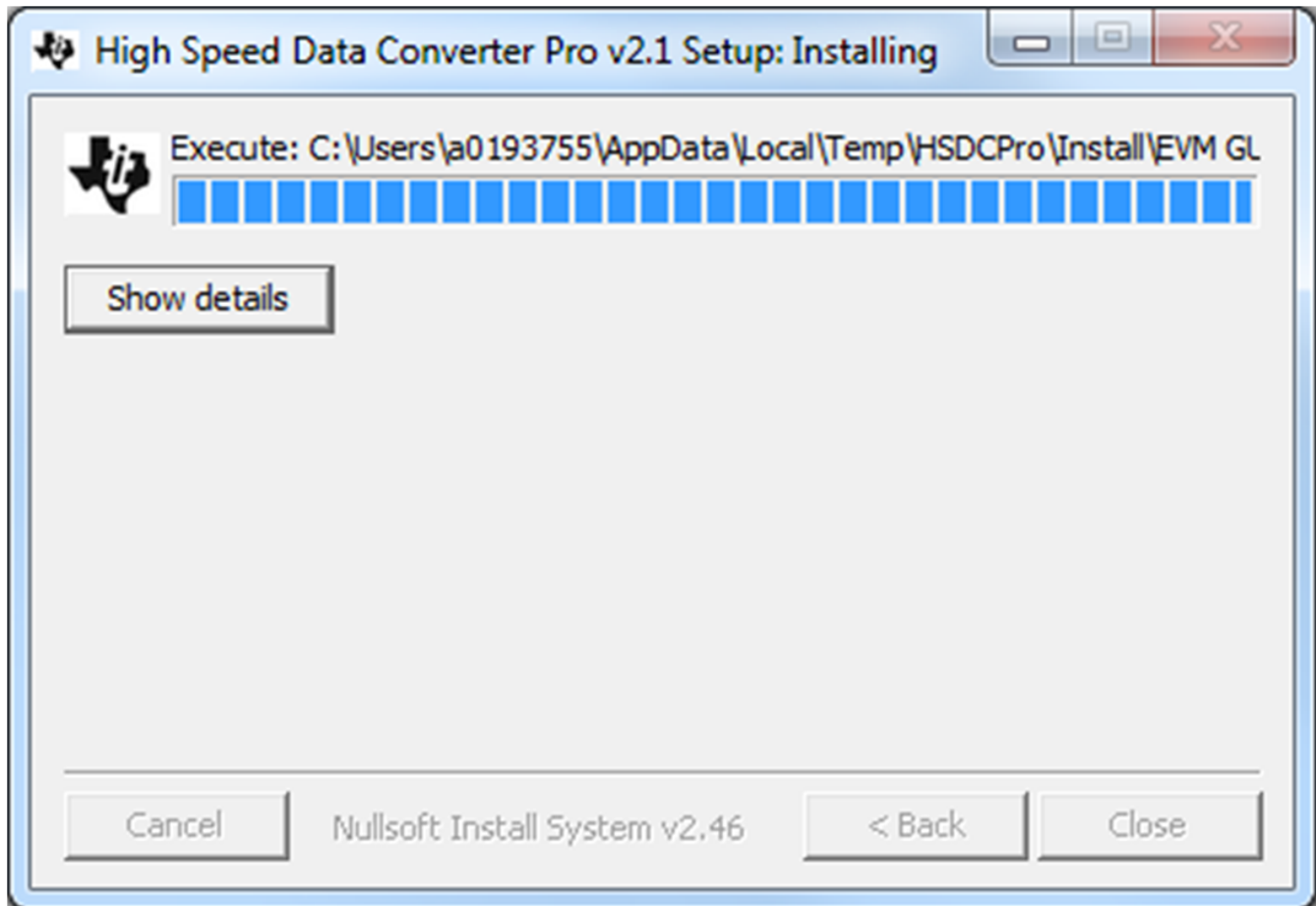

Figure 39. HSDCPro Install (h)

- As shown in Figure 40 a restart might be requested depending on whether or not the PC already had the National Instruments MCR Installer. If requested, hit the *Restart* button to complete the installation.

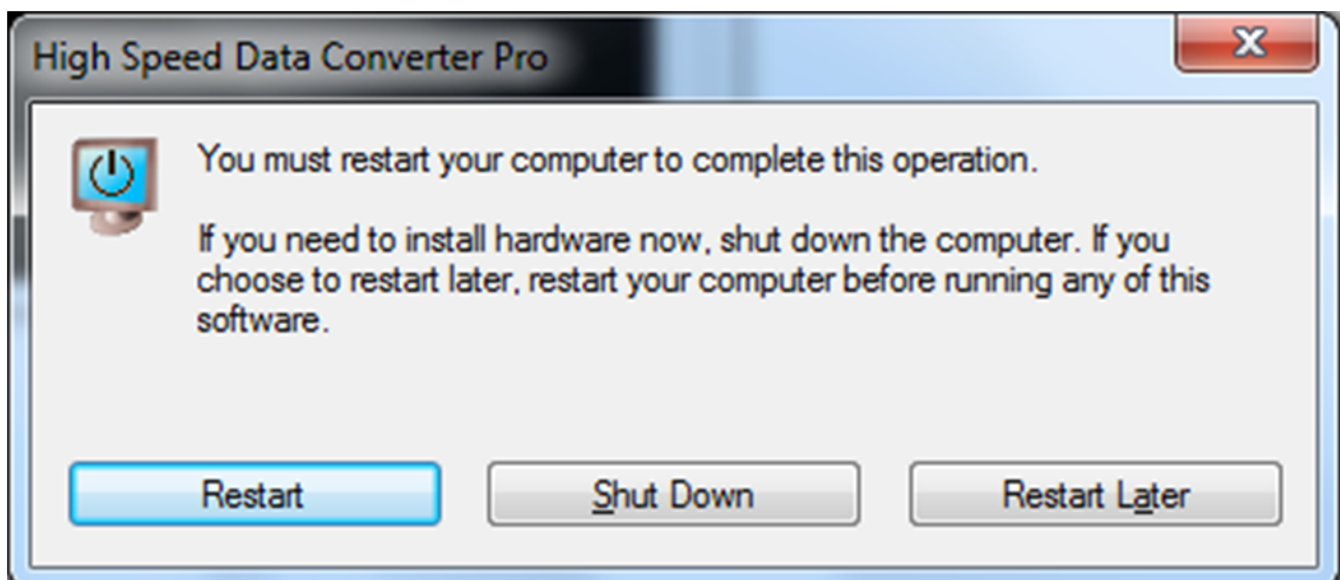

Figure 40. HSDCPro Install

Revision History

Changes from Original (July 2011) to A Revision	Page
--	-------------

- Added Appendix A: High Speed Data Converter Pro (HSDCPro) GUI Installation. [41](#)
-

NOTE: Page numbers for previous revisions may differ from page numbers in the current version.

STANDARD TERMS AND CONDITIONS FOR EVALUATION MODULES

1. *Delivery:* TI delivers TI evaluation boards, kits, or modules, including any accompanying demonstration software, components, or documentation (collectively, an "EVM" or "EVMs") to the User ("User") in accordance with the terms and conditions set forth herein. Acceptance of the EVM is expressly subject to the following terms and conditions.
 - 1.1 EVMs are intended solely for product or software developers for use in a research and development setting to facilitate feasibility evaluation, experimentation, or scientific analysis of TI semiconductor products. EVMs have no direct function and are not finished products. EVMs shall not be directly or indirectly assembled as a part or subassembly in any finished product. For clarification, any software or software tools provided with the EVM ("Software") shall not be subject to the terms and conditions set forth herein but rather shall be subject to the applicable terms and conditions that accompany such Software
 - 1.2 EVMs are not intended for consumer or household use. EVMs may not be sold, sublicensed, leased, rented, loaned, assigned, or otherwise distributed for commercial purposes by Users, in whole or in part, or used in any finished product or production system.
2. *Limited Warranty and Related Remedies/Disclaimers:*
 - 2.1 These terms and conditions do not apply to Software. The warranty, if any, for Software is covered in the applicable Software License Agreement.
 - 2.2 TI warrants that the TI EVM will conform to TI's published specifications for ninety (90) days after the date TI delivers such EVM to User. Notwithstanding the foregoing, TI shall not be liable for any defects that are caused by neglect, misuse or mistreatment by an entity other than TI, including improper installation or testing, or for any EVMs that have been altered or modified in any way by an entity other than TI. Moreover, TI shall not be liable for any defects that result from User's design, specifications or instructions for such EVMs. Testing and other quality control techniques are used to the extent TI deems necessary or as mandated by government requirements. TI does not test all parameters of each EVM.
 - 2.3 If any EVM fails to conform to the warranty set forth above, TI's sole liability shall be at its option to repair or replace such EVM, or credit User's account for such EVM. TI's liability under this warranty shall be limited to EVMs that are returned during the warranty period to the address designated by TI and that are determined by TI not to conform to such warranty. If TI elects to repair or replace such EVM, TI shall have a reasonable time to repair such EVM or provide replacements. Repaired EVMs shall be warranted for the remainder of the original warranty period. Replaced EVMs shall be warranted for a new full ninety (90) day warranty period.
3. *Regulatory Notices:*
 - 3.1 *United States*
 - 3.1.1 *Notice applicable to EVMs not FCC-Approved:*

This kit is designed to allow product developers to evaluate electronic components, circuitry, or software associated with the kit to determine whether to incorporate such items in a finished product and software developers to write software applications for use with the end product. This kit is not a finished product and when assembled may not be resold or otherwise marketed unless all required FCC equipment authorizations are first obtained. Operation is subject to the condition that this product not cause harmful interference to licensed radio stations and that this product accept harmful interference. Unless the assembled kit is designed to operate under part 15, part 18 or part 95 of this chapter, the operator of the kit must operate under the authority of an FCC license holder or must secure an experimental authorization under part 5 of this chapter.
 - 3.1.2 *For EVMs annotated as FCC – FEDERAL COMMUNICATIONS COMMISSION Part 15 Compliant:*

CAUTION

This device complies with part 15 of the FCC Rules. Operation is subject to the following two conditions: (1) This device may not cause harmful interference, and (2) this device must accept any interference received, including interference that may cause undesired operation.

Changes or modifications not expressly approved by the party responsible for compliance could void the user's authority to operate the equipment.

FCC Interference Statement for Class A EVM devices

NOTE: This equipment has been tested and found to comply with the limits for a Class A digital device, pursuant to part 15 of the FCC Rules. These limits are designed to provide reasonable protection against harmful interference when the equipment is operated in a commercial environment. This equipment generates, uses, and can radiate radio frequency energy and, if not installed and used in accordance with the instruction manual, may cause harmful interference to radio communications. Operation of this equipment in a residential area is likely to cause harmful interference in which case the user will be required to correct the interference at his own expense.

FCC Interference Statement for Class B EVM devices

NOTE: This equipment has been tested and found to comply with the limits for a Class B digital device, pursuant to part 15 of the FCC Rules. These limits are designed to provide reasonable protection against harmful interference in a residential installation. This equipment generates, uses and can radiate radio frequency energy and, if not installed and used in accordance with the instructions, may cause harmful interference to radio communications. However, there is no guarantee that interference will not occur in a particular installation. If this equipment does cause harmful interference to radio or television reception, which can be determined by turning the equipment off and on, the user is encouraged to try to correct the interference by one or more of the following measures:

- Reorient or relocate the receiving antenna.
- Increase the separation between the equipment and receiver.
- Connect the equipment into an outlet on a circuit different from that to which the receiver is connected.
- Consult the dealer or an experienced radio/TV technician for help.

3.2 Canada

3.2.1 For EVMs issued with an Industry Canada Certificate of Conformance to RSS-210

Concerning EVMs Including Radio Transmitters:

This device complies with Industry Canada license-exempt RSS standard(s). Operation is subject to the following two conditions: (1) this device may not cause interference, and (2) this device must accept any interference, including interference that may cause undesired operation of the device.

Concernant les EVMs avec appareils radio:

Le présent appareil est conforme aux CNR d'Industrie Canada applicables aux appareils radio exempts de licence. L'exploitation est autorisée aux deux conditions suivantes: (1) l'appareil ne doit pas produire de brouillage, et (2) l'utilisateur de l'appareil doit accepter tout brouillage radioélectrique subi, même si le brouillage est susceptible d'en compromettre le fonctionnement.

Concerning EVMs Including Detachable Antennas:

Under Industry Canada regulations, this radio transmitter may only operate using an antenna of a type and maximum (or lesser) gain approved for the transmitter by Industry Canada. To reduce potential radio interference to other users, the antenna type and its gain should be so chosen that the equivalent isotropically radiated power (e.i.r.p.) is not more than that necessary for successful communication. This radio transmitter has been approved by Industry Canada to operate with the antenna types listed in the user guide with the maximum permissible gain and required antenna impedance for each antenna type indicated. Antenna types not included in this list, having a gain greater than the maximum gain indicated for that type, are strictly prohibited for use with this device.

Concernant les EVMs avec antennes détachables

Conformément à la réglementation d'Industrie Canada, le présent émetteur radio peut fonctionner avec une antenne d'un type et d'un gain maximal (ou inférieur) approuvé pour l'émetteur par Industrie Canada. Dans le but de réduire les risques de brouillage radioélectrique à l'intention des autres utilisateurs, il faut choisir le type d'antenne et son gain de sorte que la puissance isotrope rayonnée équivalente (p.i.r.e.) ne dépasse pas l'intensité nécessaire à l'établissement d'une communication satisfaisante. Le présent émetteur radio a été approuvé par Industrie Canada pour fonctionner avec les types d'antenne énumérés dans le manuel d'usage et ayant un gain admissible maximal et l'impédance requise pour chaque type d'antenne. Les types d'antenne non inclus dans cette liste, ou dont le gain est supérieur au gain maximal indiqué, sont strictement interdits pour l'exploitation de l'émetteur.

3.3 Japan

3.3.1 *Notice for EVMs delivered in Japan:* Please see http://www.tij.co.jp/lstds/ti_ja/general/eStore/notice_01.page 日本国内に輸入される評価用キット、ボードについては、次のところをご覧ください。
http://www.tij.co.jp/lstds/ti_ja/general/eStore/notice_01.page

3.3.2 *Notice for Users of EVMs Considered "Radio Frequency Products" in Japan:* EVMs entering Japan are NOT certified by TI as conforming to Technical Regulations of Radio Law of Japan.

If User uses EVMs in Japan, User is required by Radio Law of Japan to follow the instructions below with respect to EVMs:

1. Use EVMs in a shielded room or any other test facility as defined in the notification #173 issued by Ministry of Internal Affairs and Communications on March 28, 2006, based on Sub-section 1.1 of Article 6 of the Ministry's Rule for Enforcement of Radio Law of Japan,
2. Use EVMs only after User obtains the license of Test Radio Station as provided in Radio Law of Japan with respect to EVMs, or
3. Use of EVMs only after User obtains the Technical Regulations Conformity Certification as provided in Radio Law of Japan with respect to EVMs. Also, do not transfer EVMs, unless User gives the same notice above to the transferee. Please note that if User does not follow the instructions above, User will be subject to penalties of Radio Law of Japan.

【無線電波を送信する製品の開発キットをお使いになる際の注意事項】

本開発キットは技術基準適合証明を受けておりません。

本製品のご使用に際しては、電波法遵守のため、以下のいずれかの措置を取っていただく必要がありますのでご注意ください。

1. 電波法施行規則第6条第1項第1号に基づく平成18年3月28日総務省告示第173号で定められた電波暗室等の試験設備でご使用いただく。
2. 実験局の免許を取得後ご使用いただく。
3. 技術基準適合証明を取得後ご使用いただく。

なお、本製品は、上記の「ご使用にあたっての注意」を譲渡先、移転先に通知しない限り、譲渡、移転できないものとします。

上記を遵守頂けない場合は、電波法の罰則が適用される可能性があることをご留意ください。

日本テキサス・インスツルメンツ株式会社

東京都新宿区西新宿 6 丁目 2 4 番 1 号

西新宿三井ビル

3.3.3 *Notice for EVMs for Power Line Communication:* Please see http://www.tij.co.jp/llds/ti_ja/general/eStore/notice_02.page

電力線搬送波通信についての開発キットをお使いになる際の注意事項については、次のところをご覧ください。http://www.tij.co.jp/llds/ti_ja/general/eStore/notice_02.page

4 *EVM Use Restrictions and Warnings:*

4.1 EVMS ARE NOT FOR USE IN FUNCTIONAL SAFETY AND/OR SAFETY CRITICAL EVALUATIONS, INCLUDING BUT NOT LIMITED TO EVALUATIONS OF LIFE SUPPORT APPLICATIONS.

4.2 User must read and apply the user guide and other available documentation provided by TI regarding the EVM prior to handling or using the EVM, including without limitation any warning or restriction notices. The notices contain important safety information related to, for example, temperatures and voltages.

4.3 *Safety-Related Warnings and Restrictions:*

4.3.1 User shall operate the EVM within TI's recommended specifications and environmental considerations stated in the user guide, other available documentation provided by TI, and any other applicable requirements and employ reasonable and customary safeguards. Exceeding the specified performance ratings and specifications (including but not limited to input and output voltage, current, power, and environmental ranges) for the EVM may cause personal injury or death, or property damage. If there are questions concerning performance ratings and specifications, User should contact a TI field representative prior to connecting interface electronics including input power and intended loads. Any loads applied outside of the specified output range may also result in unintended and/or inaccurate operation and/or possible permanent damage to the EVM and/or interface electronics. Please consult the EVM user guide prior to connecting any load to the EVM output. If there is uncertainty as to the load specification, please contact a TI field representative. During normal operation, even with the inputs and outputs kept within the specified allowable ranges, some circuit components may have elevated case temperatures. These components include but are not limited to linear regulators, switching transistors, pass transistors, current sense resistors, and heat sinks, which can be identified using the information in the associated documentation. When working with the EVM, please be aware that the EVM may become very warm.

4.3.2 EVMs are intended solely for use by technically qualified, professional electronics experts who are familiar with the dangers and application risks associated with handling electrical mechanical components, systems, and subsystems. User assumes all responsibility and liability for proper and safe handling and use of the EVM by User or its employees, affiliates, contractors or designees. User assumes all responsibility and liability to ensure that any interfaces (electronic and/or mechanical) between the EVM and any human body are designed with suitable isolation and means to safely limit accessible leakage currents to minimize the risk of electrical shock hazard. User assumes all responsibility and liability for any improper or unsafe handling or use of the EVM by User or its employees, affiliates, contractors or designees.

4.4 User assumes all responsibility and liability to determine whether the EVM is subject to any applicable international, federal, state, or local laws and regulations related to User's handling and use of the EVM and, if applicable, User assumes all responsibility and liability for compliance in all respects with such laws and regulations. User assumes all responsibility and liability for proper disposal and recycling of the EVM consistent with all applicable international, federal, state, and local requirements.

5. *Accuracy of Information:* To the extent TI provides information on the availability and function of EVMs, TI attempts to be as accurate as possible. However, TI does not warrant the accuracy of EVM descriptions, EVM availability or other information on its websites as accurate, complete, reliable, current, or error-free.

6. *Disclaimers:*

6.1 EXCEPT AS SET FORTH ABOVE, EVMS AND ANY WRITTEN DESIGN MATERIALS PROVIDED WITH THE EVM (AND THE DESIGN OF THE EVM ITSELF) ARE PROVIDED "AS IS" AND "WITH ALL FAULTS." TI DISCLAIMS ALL OTHER WARRANTIES, EXPRESS OR IMPLIED, REGARDING SUCH ITEMS, INCLUDING BUT NOT LIMITED TO ANY IMPLIED WARRANTIES OF MERCHANTABILITY OR FITNESS FOR A PARTICULAR PURPOSE OR NON-INFRINGEMENT OF ANY THIRD PARTY PATENTS, COPYRIGHTS, TRADE SECRETS OR OTHER INTELLECTUAL PROPERTY RIGHTS.

6.2 EXCEPT FOR THE LIMITED RIGHT TO USE THE EVM SET FORTH HEREIN, NOTHING IN THESE TERMS AND CONDITIONS SHALL BE CONSTRUED AS GRANTING OR CONFERRING ANY RIGHTS BY LICENSE, PATENT, OR ANY OTHER INDUSTRIAL OR INTELLECTUAL PROPERTY RIGHT OF TI, ITS SUPPLIERS/LICENSORS OR ANY OTHER THIRD PARTY, TO USE THE EVM IN ANY FINISHED END-USER OR READY-TO-USE FINAL PRODUCT, OR FOR ANY INVENTION, DISCOVERY OR IMPROVEMENT MADE, CONCEIVED OR ACQUIRED PRIOR TO OR AFTER DELIVERY OF THE EVM.

7. *USER'S INDEMNITY OBLIGATIONS AND REPRESENTATIONS.* USER WILL DEFEND, INDEMNIFY AND HOLD TI, ITS LICENSORS AND THEIR REPRESENTATIVES HARMLESS FROM AND AGAINST ANY AND ALL CLAIMS, DAMAGES, LOSSES, EXPENSES, COSTS AND LIABILITIES (COLLECTIVELY, "CLAIMS") ARISING OUT OF OR IN CONNECTION WITH ANY HANDLING OR USE OF THE EVM THAT IS NOT IN ACCORDANCE WITH THESE TERMS AND CONDITIONS. THIS OBLIGATION SHALL APPLY WHETHER CLAIMS ARISE UNDER STATUTE, REGULATION, OR THE LAW OF TORT, CONTRACT OR ANY OTHER LEGAL THEORY, AND EVEN IF THE EVM FAILS TO PERFORM AS DESCRIBED OR EXPECTED.

8. *Limitations on Damages and Liability:*

8.1 *General Limitations.* IN NO EVENT SHALL TI BE LIABLE FOR ANY SPECIAL, COLLATERAL, INDIRECT, PUNITIVE, INCIDENTAL, CONSEQUENTIAL, OR EXEMPLARY DAMAGES IN CONNECTION WITH OR ARISING OUT OF THESE TERMS AND CONDITIONS OR THE USE OF THE EVMS PROVIDED HEREUNDER, REGARDLESS OF WHETHER TI HAS BEEN ADVISED OF THE POSSIBILITY OF SUCH DAMAGES. EXCLUDED DAMAGES INCLUDE, BUT ARE NOT LIMITED TO, COST OF REMOVAL OR REINSTALLATION, ANCILLARY COSTS TO THE PROCUREMENT OF SUBSTITUTE GOODS OR SERVICES, RETESTING, OUTSIDE COMPUTER TIME, LABOR COSTS, LOSS OF GOODWILL, LOSS OF PROFITS, LOSS OF SAVINGS, LOSS OF USE, LOSS OF DATA, OR BUSINESS INTERRUPTION. NO CLAIM, SUIT OR ACTION SHALL BE BROUGHT AGAINST TI MORE THAN ONE YEAR AFTER THE RELATED CAUSE OF ACTION HAS OCCURRED.

8.2 *Specific Limitations.* IN NO EVENT SHALL TI'S AGGREGATE LIABILITY FROM ANY WARRANTY OR OTHER OBLIGATION ARISING OUT OF OR IN CONNECTION WITH THESE TERMS AND CONDITIONS, OR ANY USE OF ANY TI EVM PROVIDED HEREUNDER, EXCEED THE TOTAL AMOUNT PAID TO TI FOR THE PARTICULAR UNITS SOLD UNDER THESE TERMS AND CONDITIONS WITH RESPECT TO WHICH LOSSES OR DAMAGES ARE CLAIMED. THE EXISTENCE OF MORE THAN ONE CLAIM AGAINST THE PARTICULAR UNITS SOLD TO USER UNDER THESE TERMS AND CONDITIONS SHALL NOT ENLARGE OR EXTEND THIS LIMIT.

9. *Return Policy.* Except as otherwise provided, TI does not offer any refunds, returns, or exchanges. Furthermore, no return of EVM(s) will be accepted if the package has been opened and no return of the EVM(s) will be accepted if they are damaged or otherwise not in a resalable condition. If User feels it has been incorrectly charged for the EVM(s) it ordered or that delivery violates the applicable order, User should contact TI. All refunds will be made in full within thirty (30) working days from the return of the components(s), excluding any postage or packaging costs.

10. *Governing Law:* These terms and conditions shall be governed by and interpreted in accordance with the laws of the State of Texas, without reference to conflict-of-laws principles. User agrees that non-exclusive jurisdiction for any dispute arising out of or relating to these terms and conditions lies within courts located in the State of Texas and consents to venue in Dallas County, Texas. Notwithstanding the foregoing, any judgment may be enforced in any United States or foreign court, and TI may seek injunctive relief in any United States or foreign court.

Mailing Address: Texas Instruments, Post Office Box 655303, Dallas, Texas 75265
Copyright © 2015, Texas Instruments Incorporated

IMPORTANT NOTICE AND DISCLAIMER

TI PROVIDES TECHNICAL AND RELIABILITY DATA (INCLUDING DATASHEETS), DESIGN RESOURCES (INCLUDING REFERENCE DESIGNS), APPLICATION OR OTHER DESIGN ADVICE, WEB TOOLS, SAFETY INFORMATION, AND OTHER RESOURCES "AS IS" AND WITH ALL FAULTS, AND DISCLAIMS ALL WARRANTIES, EXPRESS AND IMPLIED, INCLUDING WITHOUT LIMITATION ANY IMPLIED WARRANTIES OF MERCHANTABILITY, FITNESS FOR A PARTICULAR PURPOSE OR NON-INFRINGEMENT OF THIRD PARTY INTELLECTUAL PROPERTY RIGHTS.

These resources are intended for skilled developers designing with TI products. You are solely responsible for (1) selecting the appropriate TI products for your application, (2) designing, validating and testing your application, and (3) ensuring your application meets applicable standards, and any other safety, security, regulatory or other requirements.

These resources are subject to change without notice. TI grants you permission to use these resources only for development of an application that uses the TI products described in the resource. Other reproduction and display of these resources is prohibited. No license is granted to any other TI intellectual property right or to any third party intellectual property right. TI disclaims responsibility for, and you fully indemnify TI and its representatives against any claims, damages, costs, losses, and liabilities arising out of your use of these resources.

TI's products are provided subject to [TI's Terms of Sale](#), [TI's General Quality Guidelines](#), or other applicable terms available either on [ti.com](#) or provided in conjunction with such TI products. TI's provision of these resources does not expand or otherwise alter TI's applicable warranties or warranty disclaimers for TI products. Unless TI explicitly designates a product as custom or customer-specified, TI products are standard, catalog, general purpose devices.

TI objects to and rejects any additional or different terms you may propose.

Copyright © 2026, Texas Instruments Incorporated

Last updated 10/2025