

LP295x 100mA, 30V, Adjustable Voltage Regulator With Shutdown

1 Features

- Wide input voltage range
 - V_{IN} range : 2V to 30V
- Wide output voltage range V_{OUT}
 - Fixed option: 3V (legacy Chip), 3.3V, 5.0V
 - Adjustable option: V_{REF} to 29V
- Output current: 100mA
- V_{OUT} accuracy:
 - $\pm 2\%$ over line, load, and temperature (legacy chip)
 - $\pm 1\%$ over line, load, and temperature (new chip)
- Quiescent current I_Q (new chip): 50 μ A (typical)
- Low dropout (new chip): 340mV (typical)
- Output current limiting and thermal shutdown
- Stable over a wide range of ceramic output capacitor values
 - C_{OUT} range: 1 μ F to 100 μ F (new chip)
 - ESR range: 0 to 2 Ω (new chip)
- Operating junction temperature: -40° C to 125° C
- Package option:
 - LP (3-pin TO-92)
 - D (8-pin SOIC)
 - DRG (8-pin WSON)

2 Applications

- [Grid infrastructure](#)
- [Factory automation](#)
- [Motor drives](#)
- [Building automation](#)

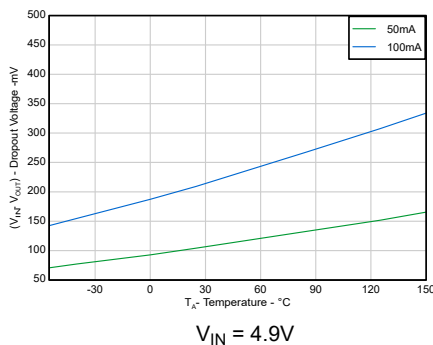

Dropout Voltage vs Temperature (New Chip)

3 Description

The LP2951 is a wide input low-dropout regulator (LDO) supporting an input voltage range from 2V to 30V and can supply up to 100mA of load current. The LP2951 is able to output either a fixed or adjustable output from the same device. By tying the OUTPUT and SENSE pins together, and the FEEDBACK and V_{TAP} pins together, the LP2951 gives 3.3V or 5V fixed output voltages. Alternatively, leave the SENSE and V_{TAP} pins open and connect FEEDBACK to an external resistor divider. This configuration allows the output to be set to any value between V_{REF} to 29V (refer to [Electrical Characteristics \(Both Legacy and New Chip\)](#) for V_{REF} details).

The LP2951 has a \overline{ERROR} output that monitors the voltage at the feedback pin to indicate the status of the output voltage. The SHUTDOWN input and \overline{ERROR} output are used for sequencing multiple power supplies in the system.

Package Information

| PART NUMBER | PACKAGE ⁽¹⁾ | PACKAGE SIZE ⁽²⁾ |
|-------------|------------------------|-----------------------------|
| LP2950 | LP (TO-92, 3) | 4.83mm × 4.83mm |
| LP2951 | D (SOIC, 8) | 4.90mm x 6.00mm |
| | DRG (SON, 8) | 3.00mm x 3.00mm |

- (1) For all available packages, see the orderable addendum at the end of the data sheet.
- (2) The package size (length × width) is a nominal value and includes pins, where applicable.

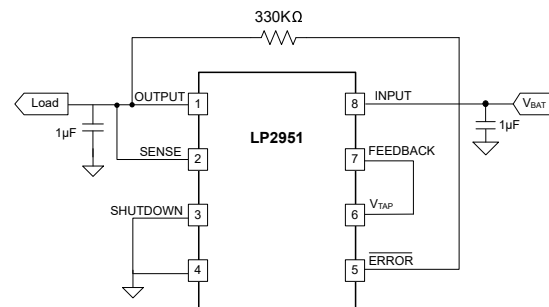

Typical Application Circuit



Table of Contents

| | | | |
|-------------------------------------------------------------------|-----------|----------------------------------------------------------------------|-----------|
| 1 Features | 1 | 7 Application and Implementation | 24 |
| 2 Applications | 1 | 7.1 Application Information..... | 24 |
| 3 Description | 1 | 7.2 Typical Application..... | 26 |
| 4 Pin Configuration and Functions | 3 | 7.3 Power Supply Recommendations..... | 30 |
| 5 Specifications | 4 | 7.4 Layout..... | 30 |
| 5.1 Absolute Maximum Ratings..... | 4 | 8 Device and Documentation Support | 31 |
| 5.2 ESD Ratings..... | 4 | 8.1 Device Support..... | 31 |
| 5.3 Recommended Operating Conditions..... | 5 | 8.2 Receiving Notification of Documentation Updates...31 | |
| 5.4 Thermal Information..... | 5 | 8.3 Device Nomenclature..... | 31 |
| 5.5 Electrical Characteristics (Both Legacy and New Chip)..... | 5 | 8.4 Documentation Support..... | 31 |
| 5.6 Timing Requirements (New Chip only)..... | 9 | 8.5 Support Resources..... | 31 |
| 5.7 Typical Characteristics..... | 11 | 8.6 Trademarks..... | 31 |
| 6 Detailed Description | 22 | 8.7 Electrostatic Discharge Caution..... | 32 |
| 6.1 Overview..... | 22 | 8.8 Glossary..... | 32 |
| 6.2 Functional Block Diagrams..... | 22 | 9 Revision History | 32 |
| 6.3 Feature Description..... | 23 | 10 Mechanical, Packaging, and Orderable Information | 32 |
| 6.4 Device Functional Modes..... | 24 | | |

4 Pin Configuration and Functions

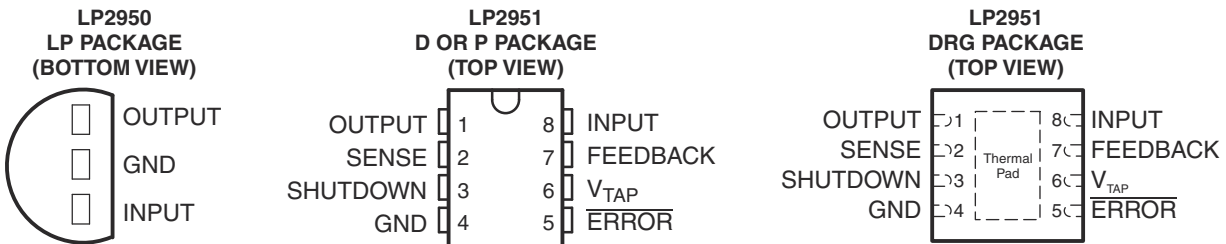

Table 4-1. Pin Functions

| NAME | PIN | | TYPE ⁽¹⁾ | DESCRIPTION |
|-----------|--------|--------|---------------------|---------------------------------------------------------------------------------------------------------------------------------------------------------------------------------------------------------------------------------------------------------------------------------------------------------------------------|
| | LP2950 | LP2951 | | |
| ERROR | — | 5 | O | Active-low open-drain error output. Goes low when V_{OUT} drops by 6% of the nominal value. |
| FEEDBACK | — | 7 | I | Determines the output voltage. Connect to V_{TAP} (with OUTPUT tied to SENSE) for fixed output option, or connect to a resistor divider for adjustable output option. |
| GND | 2 | 4 | — | Ground |
| INPUT | 3 | 8 | I | Input supply pin. Use a capacitor with a value of 1 μ F or larger from this pin to ground is recommended. See the Section 7.1.2 section for more information. |
| OUTPUT | 1 | 1 | O | A capacitor is required from OUTPUT to GND for stability. For best transient response, use the nominal recommended value or larger ceramic capacitor from OUTPUT to GND ⁽²⁾ . Place the output capacitor as close to output of the device as possible. See the Section 7.1.2 for more details. |
| SENSE | — | 2 | I | Senses the output voltage. Connect to OUTPUT (with FEEDBACK tied to V_{TAP}) for fixed output option only. If using the device as adjustable output, this pin must be left floating. |
| SHUTDOWN | — | 3 | I | Active-high input. High signal disables the device; low signal enables the device. |
| V_{TAP} | — | 6 | I | Connect to FEEDBACK for fixed output option. If using the device as adjustable output, this pin must be left floating. |

(1) I = Input; O = Output

(2) The nominal output capacitance must be greater than 1 μ F. Throughout this document, the nominal derating on these capacitors is 50%. Verify that the effective capacitance at the pin is greater than 1 μ F.

5 Specifications

5.1 Absolute Maximum Ratings

over operating free-air temperature range (unless otherwise noted)⁽¹⁾

| | | MIN | MAX | UNIT |
|--------------------|-----------------------------------------------------------------|------|-------------------------------------|------|
| V _{IN} | Continuous input voltage (legacy chip) | -0.3 | 35 | V |
| | Continuous input voltage (new chip) | -0.3 | 42 | |
| V _{OUT} | Output voltage | -0.3 | V _{IN} +0.3 ⁽⁴⁾ | |
| V _{SHDN} | SHUTDOWN input voltage (legacy chip) | -1.5 | 35 | |
| | SHUTDOWN input voltage (new chip) | -0.3 | 42 | |
| V _{ERROR} | ERROR comparator output voltage (legacy chip) ⁽²⁾ | -1.5 | 30 | |
| | ERROR comparator output voltage (new chip) ⁽²⁾ | -0.3 | 39 | |
| V _{FDBK} | FEEDBACK input voltage (legacy chip) ^{(2) (3)} | -1.5 | 30 | |
| | FEEDBACK input voltage (new chip) ^{(2) (3)} | -0.3 | 5 | |
| V _{TAP} | Internal resistor divider (fixed voltage option only, new chip) | -0.3 | 5 | |
| V _{SENSE} | Output voltage sense (fixed voltage option only, new chip) | -0.3 | 6 | |
| T _{stg} | Storage temperature | -65 | 150 | °C |

- (1) Operation outside the Absolute Maximum Ratings may cause permanent device damage. Absolute Maximum Ratings do not imply functional operation of the device at these or any other conditions beyond those listed under Recommended Operating Conditions. If used outside the Recommended Operating Conditions but within the Absolute Maximum Ratings, the device may not be fully functional, and this may affect device reliability, functionality, performance, and shorten the device lifetime.
- (2) Can exceed input supply voltage.
- (3) If load is returned to a negative power supply, the output must be diode clamped to GND.
- (4) The absolute maximum rating is V_{IN} + 0.3V or 39V, whichever is smaller.

5.2 ESD Ratings

| | | | VALUE (Legacy Chip) | VALUE (New Chip) | UNIT |
|--------------------|-------------------------|------------------------------------------------------------------------------------------|---------------------------|------------------------|------|
| V _(ESD) | Electrostatic discharge | Human body model (HBM), per ANSI/ESDA/JEDEC JS-001, all pins ⁽¹⁾ | ±2500 | ±3000 | V |
| | | Charged device model (CDM), per JEDEC specification JESD22-C101, all pins ⁽²⁾ | ±1000 | ±1000 | V |

- (1) JEDEC document JEP155 states that 500V HBM allows safe manufacturing with a standard ESD control process.
- (2) JEDEC document JEP157 states that 250V CDM allows safe manufacturing with a standard ESD control process.

5.3 Recommended Operating Conditions

over operating free-air temperature range (unless otherwise noted)

| | | MIN | NOM | MAX | UNIT |
|-------------------------|-------------------------------------------------------------------------------|-----|-----|-----|------|
| V _{IN} | Input voltage | 2.0 | | 30 | V |
| V _{EN} | Enable voltage | 0 | | 30 | |
| V _{OUT} | Output voltage | 1.2 | | 30 | |
| I _L | Output current | 0 | | 100 | mA |
| C _{OUT} | Output capacitor ⁽¹⁾ | 1 | 2.2 | 100 | μF |
| C _{OUT} ESR | Output capacitor ESR (legacy chip) | 30m | | 5 | Ω |
| | Output capacitor ESR (new chip) ⁽³⁾ | 0 | | 2 | |
| C _{IN} | Input capacitor | | 1 | | μF |
| C _{FF} | Feed-forward capacitor (optional ⁽²⁾ , for adjustable device only) | | 10 | | pF |
| I _{FB_DIVIDER} | Feedback divider current ⁽²⁾ (adjustable device only) | 12 | | | μA |
| T _J | Junction temperature | -40 | | 125 | °C |

- (1) Effective output capacitance of 0.5μF minimum required for stability.
- (2) C_{FF} required for stability if the feedback divider current < 12μA. Feedback divider current = V_{OUT} / (R₁ + R₂). See the *Feed-Forward Capacitor (C_{FF})* section for details.
- (3) Maximum supported ESR range for new chip is 2Ω. For output capacitor with higher ESR values, place a low ESR MLCC capacitor.

5.4 Thermal Information

| THERMAL METRIC ^{(1) (2)} | | Legacy Chip | | | New Chip | | | UNIT |
|-----------------------------------|----------------------------------------------|-------------|--------|--------|----------|--------|--------|------|
| | | D | DRG | LP | D | DRG | LP | |
| | | 8 PINS | 8 PINS | 3 PINS | 8 PINS | 8 PINS | 3 PINS | |
| R _{θJA} | Junction-to-ambient thermal resistance | 97 | 52.44 | 140 | 123 | 61.7 | 132.6 | °C/W |
| R _{θJC(top)} | Junction-to-case (top) thermal resistance | - | - | - | 67.8 | 63.1 | 114.4 | °C/W |
| R _{θJB} | Junction-to-board thermal resistance | - | - | - | 70.7 | 31.0 | 94.9 | °C/W |
| Ψ _{JT} | Junction-to-top characterization parameter | - | - | - | 18.0 | 2.2 | 26.9 | °C/W |
| Ψ _{JB} | Junction-to-board characterization parameter | - | - | - | 69.8 | 30.9 | 94.9 | °C/W |
| R _{θJC(bot)} | Junction-to-case (bottom) thermal resistance | - | - | - | n/a | 2.9 | n/a | °C/W |

- (1) The thermal data is based on the JEDEC standard high K profile, JESD 51-7. Two-signal, two-plane, four-layer board with 2-oz. copper. The copper pad is soldered to the thermal land pattern. Also, correct attachment procedure must be incorporated.
- (2) For more information about traditional and new thermal metrics, see the *Semiconductor and IC Package Thermal Metrics* application note.

5.5 Electrical Characteristics (Both Legacy and New Chip)

V_{IN} = V_{OUT} (nominal) + 1V, I_L = 100μA, C_L = 1μF (for new chip) and C_L = 2.2μF (for legacy chip),
8-pin version: FEEDBACK tied to V_{TAP}, OUTPUT tied to SENSE, V_{SHUTDOWN} ≤ 0.7V

| PARAMETER | TEST CONDITIONS | T _J | MIN | TYP | MAX | UNIT | |
|-----------------------------------------|------------------------|----------------|----------------|--------|-----|--------|---|
| 3.3-V VERSION (LP295x-33) | | | | | | | |
| Output voltage | I _L = 100μA | Legacy chip | 25°C | 3.267 | 3.3 | 3.333 | V |
| | | | -40°C to 125°C | 3.234 | 3.3 | 3.366 | |
| | | New chip | 25°C | 3.2868 | 3.3 | 3.3132 | |
| | | | -40°C to 125°C | 3.2736 | 3.3 | 3.3264 | |
| 3.3-V ADJ VERSION (LP295x-33ADJ) | | | | | | | |

5.5 Electrical Characteristics (Both Legacy and New Chip) (continued)

$V_{IN} = V_{OUT} \text{ (nominal)} + 1V$, $I_L = 100\mu A$, $C_L = 1\mu F$ (for new chip) and $C_L = 2.2\mu F$ (for legacy chip),
8-pin version: FEEDBACK tied to V_{TAP} , OUTPUT tied to SENSE, $V_{SHUTDOWN} \leq 0.7V$

| PARAMETER | TEST CONDITIONS | | T_J | MIN | TYP | MAX | UNIT |
|----------------------------------------------------------|------------------------------------------------------------------|--------------------------------|-------------------|--------|--------|--------|--------|
| Output voltage | $I_L = 100\mu A$ | New chip (LP295x-33A DJ) | 25°C | 3.3451 | 3.37 | 3.3923 | V |
| | | | –40°C to 125°C | 3.3283 | 3.37 | 3.4091 | V |
| 5-V VERSION (LP295x-50) | | | | | | | |
| Output voltage | $I_L = 100\mu A$ | Legacy chip | 25°C | 4.95 | 5 | 5.05 | V |
| | | | –40°C to 125°C | 4.900 | 5 | 5.100 | |
| | | New chip | 25°C | 4.98 | 5 | 5.02 | |
| | | | –40°C to 125°C | 4.96 | 5 | 5.04 | |
| 5-V ADJ VERSION (LP295x-50ADJ) | | | | | | | |
| Output voltage | $I_L = 100\mu A$ | New chip (LP295x-50A DJ) | 25°C | 5.0608 | 5.1 | 5.1475 | V |
| | | | –40°C to 125°C | 5.0353 | 5.1 | 5.1731 | V |
| ALL VOLTAGE OPTIONS | | | | | | | |
| Output voltage accuracy | $V_{IN} = [V_{OUT(NOM)} + 1V]$ to 30V, $I_L = 100\mu A$ to 100mA | New chip | –40°C to 125°C | –1 | | 1 | % |
| | | New chip (LP295x- XXADJ) | | –1.35 | | 1.35 | % |
| | | New chip | | –1.2 | | 1.2 | % |
| Output voltage temperature coefficient ⁽¹⁾ | $I_L = 100\mu A$ | Legacy chip | –40°C to 125°C | | 20 | 100 | ppm/°C |
| | | New chip | | | 20 | 60 | |
| Line regulation ⁽²⁾ | $V_{IN} = [V_{OUT(NOM)} + 1V]$ to 30V | Legacy chip | 25°C | | 0.03 | 0.2 | %V |
| | | | –40°C to 125°C | | | 0.4 | |
| | | New chip | 25°C | | 0.0006 | 0.01 | |
| | | | –40°C to 125°C | | | 0.015 | |
| Load regulation ⁽²⁾ | $I_L = 100\mu A$ to 100mA | Legacy chip | 25°C | | 0.04 | 0.2 | % |
| | | | –40°C to 125°C | | | 0.3 | |
| | | New chip | 25°C | | 0.04 | 0.1 | |
| | | | –40°C to 125°C | | | 0.2 | |
| Dropout voltage | $V_{IN} = 2V$, $I_L = 100\mu A$ | Legacy chip | 25°C | | 50 | 80 | mV |
| | | | –40°C to 125°C | | | 150 | |
| | | New chip | 25°C | | 1 | 4 | |
| | | | –40°C to 125°C | | | 5 | |
| | $V_{IN} = 2V$, $I_L = 100mA$ | Legacy chip | 25°C | | 380 | 450 | |
| | | | –40°C to 125°C | | | 600 | |
| New chip | 25°C | | 340 | 420 | | | |
| | –40°C to 125°C | | | 570 | | | |

5.5 Electrical Characteristics (Both Legacy and New Chip) (continued)

$V_{IN} = V_{OUT} \text{ (nominal)} + 1V$, $I_L = 100\mu A$, $C_L = 1\mu F$ (for new chip) and $C_L = 2.2\mu F$ (for legacy chip),
8-pin version: FEEDBACK tied to V_{TAP} , OUTPUT tied to SENSE, $V_{SHUTDOWN} \leq 0.7V$

| PARAMETER | TEST CONDITIONS | T_J | MIN | TYP | MAX | UNIT | |
|---------------------------------------------------------------------|------------------------------------------------------------------------|----------------|----------------|------|-----|---------|---|
| GND current | $I_L = 100\mu A$ | Legacy chip | 25°C | 75 | 120 | μA | |
| | | | -40°C to 125°C | | 140 | | |
| | | New chip | 25°C | 50 | 65 | | |
| | | | -40°C to 125°C | | 80 | | |
| | $I_L = 100mA$ | Legacy chip | 25°C | 8 | 12 | mA | |
| | | | -40°C to 125°C | | 14 | | |
| New chip | | 25°C | | 0.8 | | | |
| | | -40°C to 125°C | | 0.9 | | | |
| Dropout ground current | $V_{IN} = V_{OUT(NOM)} - 0.5V$, $I_L = 100\mu A$ | Legacy chip | 25°C | 110 | 170 | μA | |
| | | | -40°C to 125°C | | 200 | | |
| | | New chip | 25°C | 78 | 120 | | |
| | | | -40°C to 125°C | | 150 | | |
| UVLO V_{IN} rising | $I_L = 100\mu A$ | New chip | -40°C to 125°C | 1.8 | 1.9 | 2.0 | V |
| UVLO V_{IN} falling | | | | 1.7 | 1.8 | 1.9 | |
| Hysteresis | | | | | 100 | | |
| Current limit | $V_{OUT} = 0V$ | Legacy chip | 25°C | 160 | 200 | mA | |
| | | | -40°C to 125°C | | 220 | | |
| | | New chip | 25°C | 180 | 200 | | |
| | | | -40°C to 125°C | | 230 | | |
| Thermal regulation ⁽³⁾ | $I_L = 100\mu A$ | Legacy chip | 25°C | 0.05 | 0.2 | %/ W | |
| | | New chip | | 0.05 | 0.2 | | |
| Output noise (RMS), 10Hz to 100kHz | $C_L = 1\mu F$ (5V only) | Legacy chip | 25°C | 430 | | μV | |
| | | New chip | | 265 | | | |
| | $C_L = 200\mu F$ | Legacy chip | 25°C | 160 | | | |
| | | New chip | | 250 | | | |
| | $C_L = 3.3\mu F$, $C_{Bypass} = 0.01\mu F$ between pins 1 and 7 | Legacy chip | 25°C | 100 | | | |
| | | New chip | | 100 | | | |
| Power-supply ripple rejection | $V_{IN} - V_{OUT} = 1V$, frequency = 100Hz, $I_{OUT} \geq 5mA$ | New chip | 25°C | 80 | | dB | |
| (LP2951-xx & LP2951-xxADJ) 8-PIN VERSION ONLY ADJUSTABLE | | | | | | | |

5.5 Electrical Characteristics (Both Legacy and New Chip) (continued)

$V_{IN} = V_{OUT} \text{ (nominal)} + 1V$, $I_L = 100\mu A$, $C_L = 1\mu F$ (for new chip) and $C_L = 2.2\mu F$ (for legacy chip),
8-pin version: FEEDBACK tied to V_{TAP} , OUTPUT tied to SENSE, $V_{SHUTDOWN} \leq 0.7V$

| PARAMETER | TEST CONDITIONS | T_J | MIN | TYP | MAX | UNIT | |
|------------------------------------------------------------|-------------------------------------------------------------------------|-------------------------|----------------|-------|-------|---------|---|
| Reference voltage | | Legacy chip | 25°C | 1.218 | 1.235 | 1.252 | V |
| | | | -40°C to 125°C | 1.212 | | 1.257 | |
| | | New chip | 25°C | 1.192 | 1.2 | 1.208 | |
| | | | -40°C to 125°C | 1.189 | | 1.211 | |
| | | New chip (LP295x-XXADJ) | 25°C | 1.215 | 1.23 | 1.245 | |
| | | -40°C to 125°C | 1.205 | | 1.255 | | |
| Reference voltage | $V_{IN} = 2.3V \text{ to } 30V$, $I_L = 100\mu A \text{ to } 100mA$ | Legacy chip | -40°C to 125°C | 1.2 | 1.272 | | |
| | | New chip | | 1.188 | 1.212 | | |
| | | New chip (LP295x-XXADJ) | | 1.212 | 1.257 | | |
| Reference voltage temperature coefficient ⁽¹⁾ | | Legacy chip | 25°C | 20 | | ppm/°C | |
| | | New chip | | 5 | | | |
| FEEDBACK bias current | | Legacy chip | 25°C | 20 | 40 | nA | |
| | | | -40°C to 125°C | | 60 | | |
| | | New chip | 25°C | 10 | 50 | | |
| | | | -40°C to 125°C | | 60 | | |
| FEEDBACK bias current temperature coefficient | | Legacy chip | 25°C | 0.1 | | nA/°C | |
| | | New chip | | 0.1 | | | |
| ERROR COMPARATOR | | | | | | | |
| Output leakage current | $V_{OUT} = 30V$ | Legacy chip | 25°C | 0.01 | 1 | μA | |
| | | | -40°C to 125°C | | 2 | | |
| | | New chip | 25°C | 0.2 | 0.5 | | |
| | | | -40°C to 125°C | | 1 | | |
| Output low voltage | $V_{IN} \geq 2V$ $I_{OL} = 400\mu A$ | Legacy chip | 25°C | 150 | 250 | mV | |
| | | | -40°C to 125°C | | 400 | | |
| | | New chip | 25°C | 180 | 250 | | |
| | | | -40°C to 125°C | | 350 | | |
| Upper threshold voltage (ERROR output high) ⁽⁴⁾ | | Legacy chip | 25°C | 40 | 60 | mV | |
| | | | -40°C to 125°C | 25 | | | |
| | | New chip | 25°C | 40 | 60 | | |
| | | | -40°C to 125°C | 25 | | | |

5.5 Electrical Characteristics (Both Legacy and New Chip) (continued)

$V_{IN} = V_{OUT} (\text{nominal}) + 1V$, $I_L = 100\mu A$, $C_L = 1\mu F$ (for new chip) and $C_L = 2.2\mu F$ (for legacy chip),
8-pin version: FEEDBACK tied to V_{TAP} , OUTPUT tied to SENSE, $V_{SHUTDOWN} \leq 0.7V$

| PARAMETER | TEST CONDITIONS | | T_J | MIN | TYP | MAX | UNIT |
|--------------------------------------------------------------------------------|-----------------------------------------------------------------------------------------------|-------------|----------------|-----|-----|-----|---------|
| Lower threshold voltage ($\overline{\text{ERROR}}$ output low) ⁽⁴⁾ | Legacy chip | | 25°C | | 75 | 95 | mV |
| | | | –40°C to 125°C | | | 140 | |
| | New chip | | 25°C | | 75 | 95 | |
| | | | –40°C to 125°C | | | 140 | |
| Hysteresis ⁽⁴⁾ | Legacy chip | | 25°C | | 15 | | mV |
| | New chip | | | | 15 | | |
| SHUTDOWN INPUT | | | | | | | |
| Input logic voltage | Low (regulator ON) | Legacy chip | –40°C to 125°C | | | 0.7 | V |
| | | New chip | | | | 0.7 | |
| | High (regulator OFF) | Legacy chip | –40°C to 125°C | | 2 | | |
| | | New chip | | | 2 | | |
| SHUTDOWN input current | SHUTDOWN = 2.4V | Legacy chip | 25°C | | 30 | 50 | μA |
| | | | –40°C to 125°C | | | 100 | |
| | | New chip | 25°C | | 0.2 | 0.5 | |
| | | | –40°C to 125°C | | | 1 | |
| | SHUTDOWN = 30V | Legacy chip | 25°C | | 450 | 600 | |
| | | | –40°C to 125°C | | | 750 | |
| New chip | 25°C | | 0.3 | 0.5 | | | |
| | –40°C to 125°C | | | 1 | | | |
| Regulator output current in shutdown | $V_{SHUTDOWN} \geq 2V$, $V_{IN} \geq 30V$, $V_{OUT} = 0$, FEEDBACK tied to V_{TAP} | Legacy chip | 25°C | | 3 | 10 | μA |
| | | | –40°C to 125°C | | | 20 | |
| | | New chip | 25°C | | 4 | 6 | |
| | | | –40°C to 125°C | | | 7.5 | |

- Output or reference voltage temperature coefficient is defined as the worst-case voltage change divided by the total temperature range.
- Regulation is measured at constant junction temperature, using pulse testing with a low duty cycle. Changes in output voltage resulting from heating effects are covered under the specification for thermal regulation.
- Thermal regulation is defined as the change in output voltage at a time (T) after a change in power dissipation is applied, excluding load or line regulation effects. Specifications are for a 50-mA load pulse at $V_{IN} = 30V$, $V_{OUT} = 5V$ (1.25W pulse) for $t = 10ms$.
- Comparator thresholds are expressed in terms of a voltage differential equal to the nominal reference voltage (measured at $V_{IN} - V_{OUT} = 1V$) minus FEEDBACK terminal voltage. To express these thresholds in terms of output voltage change, multiply by the error amplifier gain = $V_{OUT}/V_{REF} = (R1 + R2)/R2$. For example, at a programmed output voltage of 5V, the $\overline{\text{ERROR}}$ output is specified to go low when the output drops by $95mV \times 5V/V_{REF}$. Thresholds remain constant as a percentage of V_{OUT} (as V_{OUT} is varied), with the low-output warning occurring at 6% below nominal (typ) and 7.7%(max).

5.6 Timing Requirements (New Chip only)

| PARAMETER | TEST CONDITIONS | MIN | TYP | MAX | UNIT |
|------------|---------------------------------------------------------------------------|-----|-----|-----|---------|
| t_{PGDH} | PG delay time rising, time from 92% V_{OUT} to 20% of PG ⁽¹⁾ | | 40 | | μs |

5.6 Timing Requirements (New Chip only) (continued)

| PARAMETER | TEST CONDITIONS | MIN | TYP | MAX | UNIT |
|------------|----------------------------------------------------------------------------|-----|-----|-----|---------|
| t_{PGDL} | PG delay time falling, time from 90% V_{OUT} to 80% of PG ⁽¹⁾ | | 10 | | μ s |

(1) Output Overdrive = 10%.

5.7 Typical Characteristics

at $V_{IN} = V_{OUT} (\text{nominal}) + 1V$, $I_L = 100\mu A$, $C_L = 1\mu F$ (for new chip) and $C_L = 2.2\mu F$ (for legacy chip) (unless otherwise noted)

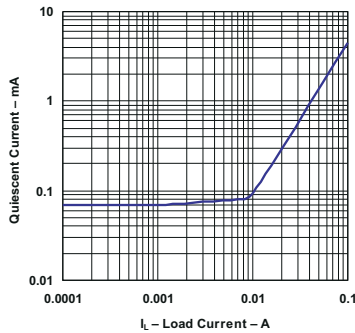
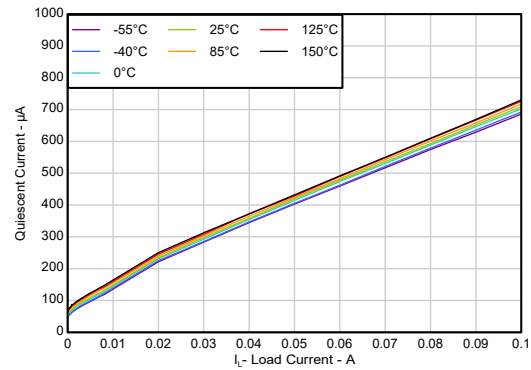

Figure 5-1. Quiescent Current vs Load Current (Legacy Chip)



$V_{IN} = 6V, V_{OUT} = 5V$

Figure 5-2. Quiescent Current vs Load Current (New Chip)

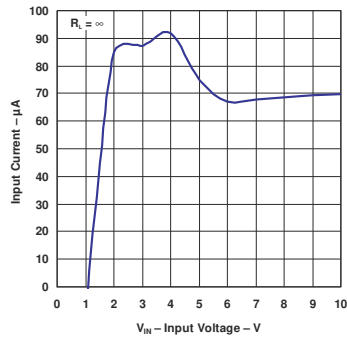
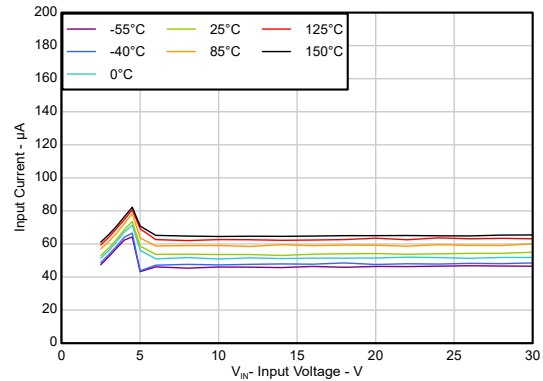

Figure 5-3. Input Current vs Input Voltage ($R_L = \text{OPEN}$) (Legacy Chip)



$V_{OUT} = 5V, I_L = 0mA$

Figure 5-4. Input Current vs Input Voltage ($R_L = \text{OPEN}$) (New Chip)

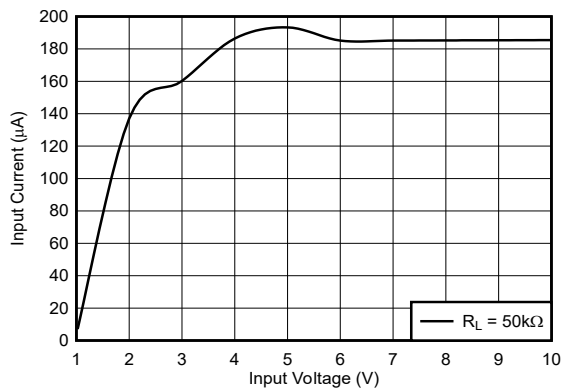
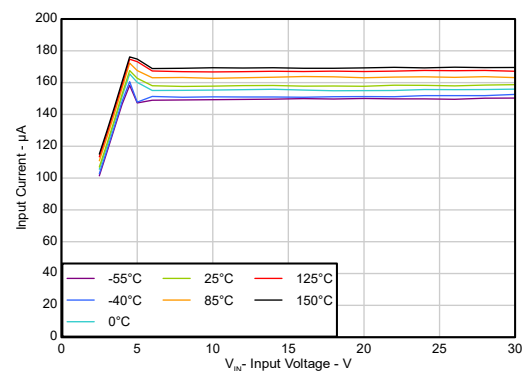

Figure 5-5. Input Current vs Input Voltage ($R_L = 50k\Omega$)



$V_{OUT} = 5V, I_L = 100\mu A$

Figure 5-6. Input Current vs Input Voltage ($R_L = 50k\Omega$) (New Chip)

5.7 Typical Characteristics (continued)

at $V_{IN} = V_{OUT} (\text{nominal}) + 1V$, $I_L = 100\mu A$, $C_L = 1\mu F$ (for new chip) and $C_L = 2.2\mu F$ (for legacy chip) (unless otherwise noted)

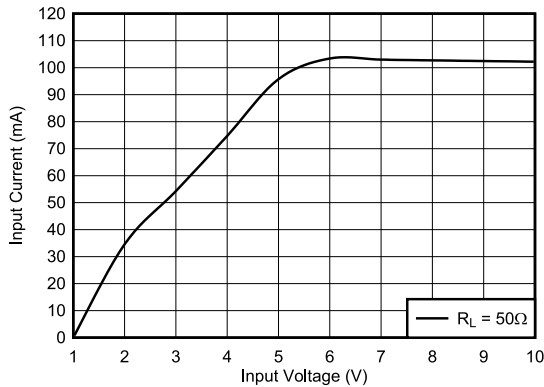
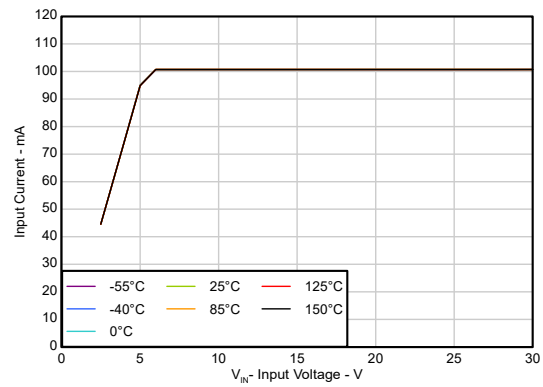

Figure 5-7. Input Current vs Input Voltage ($R_L = 50\Omega$) (Legacy Chip)



$V_{OUT} = 5V$, $I_L = 100mA$

Figure 5-8. Input Current vs Input Voltage ($R_L = 50\Omega$) (New Chip)

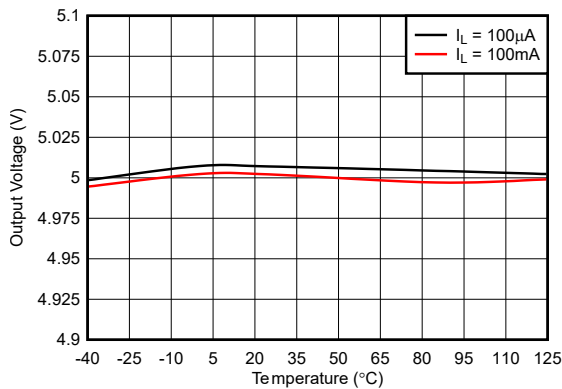
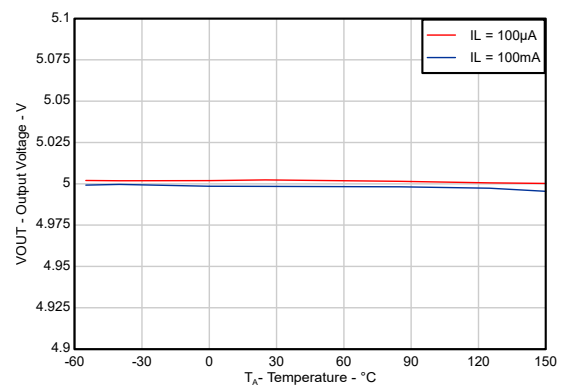

Figure 5-9. Output Voltage vs Temperature (Legacy Chip)



$V_{IN} = 6V$, $V_{OUT} = 5V$

Figure 5-10. Output Voltage vs Temperature (New Chip)

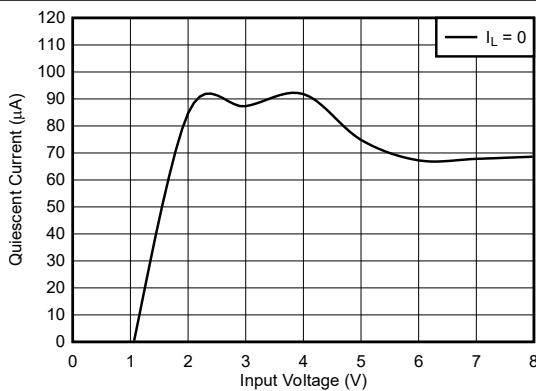
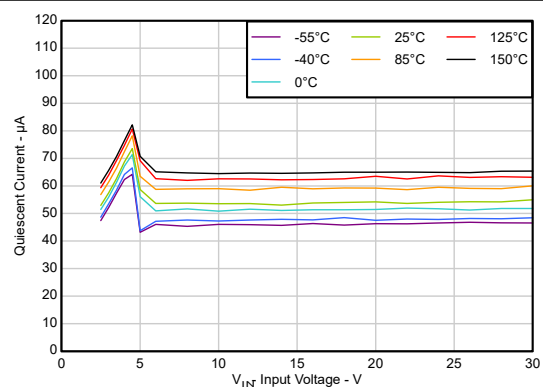

Figure 5-11. Quiescent Current vs Input Voltage ($I_L = 0$) (Legacy Chip)



$V_{OUT} = 5V$

Figure 5-12. Quiescent Current vs Input Voltage ($I_L = 0$) (New Chip)

5.7 Typical Characteristics (continued)

at $V_{IN} = V_{OUT} (\text{nominal}) + 1V$, $I_L = 100\mu A$, $C_L = 1\mu F$ (for new chip) and $C_L = 2.2\mu F$ (for legacy chip) (unless otherwise noted)

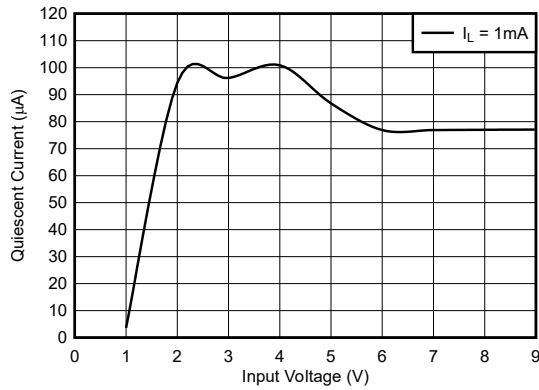
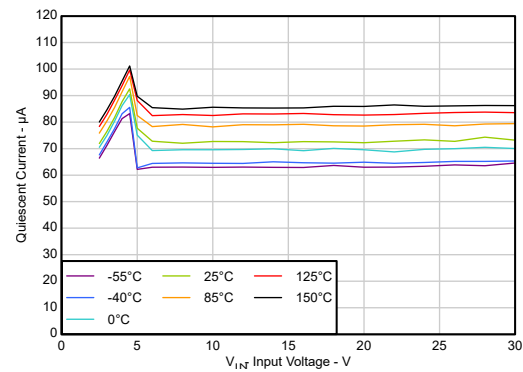

Figure 5-13. Quiescent Current vs Input Voltage ($I_L = 1\text{mA}$) (Legacy Chip)



$V_{OUT} = 5V$

Figure 5-14. Quiescent Current vs Input Voltage ($I_L = 1\text{mA}$) (New Chip)

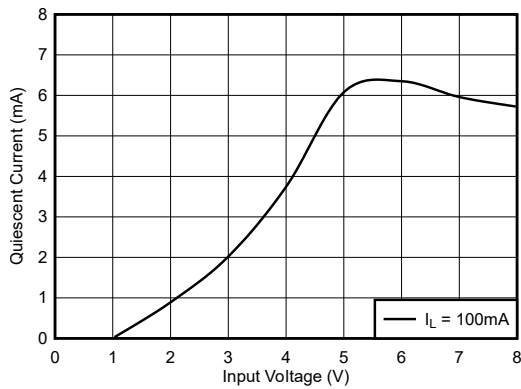
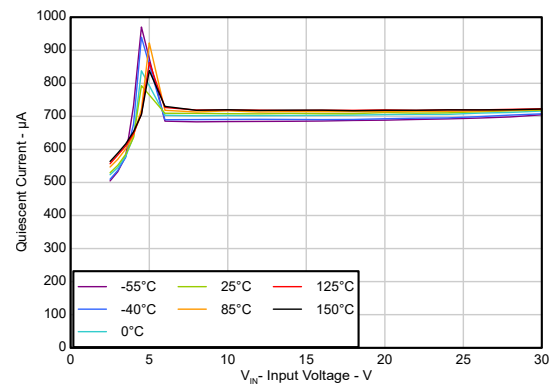

Figure 5-15. Quiescent Current vs Input Voltage ($I_L = 100\text{mA}$) (Legacy Chip)



$V_{OUT} = 5V$

Figure 5-16. Quiescent Current vs Input Voltage ($I_L = 100\text{mA}$) (New Chip)

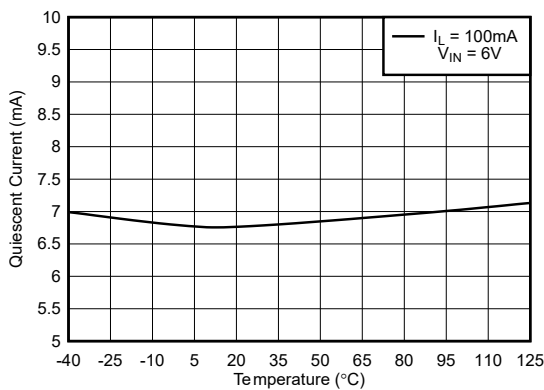
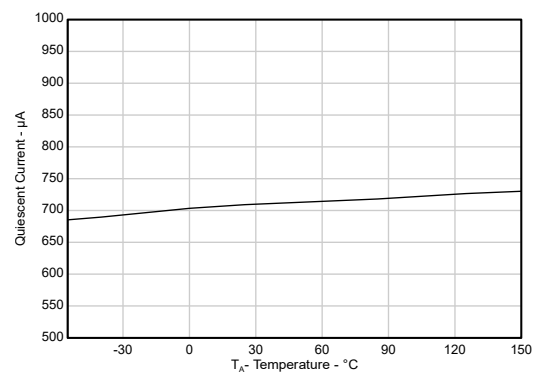

Figure 5-17. Quiescent Current vs Temperature ($I_L = 100\text{mA}$) (Legacy Chip)



$V_{IN} = 6V, V_{OUT} = 5V$

Figure 5-18. Quiescent Current vs Temperature ($I_L = 100\text{mA}$) (New Chip)

5.7 Typical Characteristics (continued)

at $V_{IN} = V_{OUT} \text{ (nominal)} + 1V$, $I_L = 100\mu A$, $C_L = 1\mu F$ (for new chip) and $C_L = 2.2\mu F$ (for legacy chip) (unless otherwise noted)

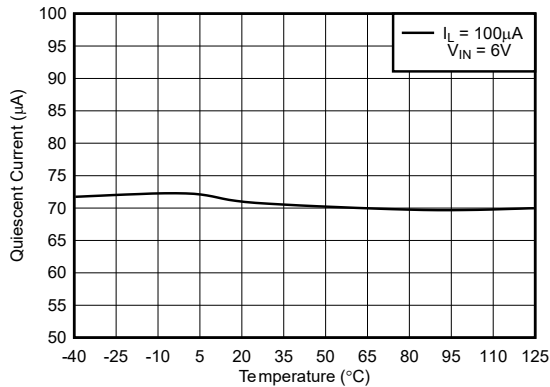
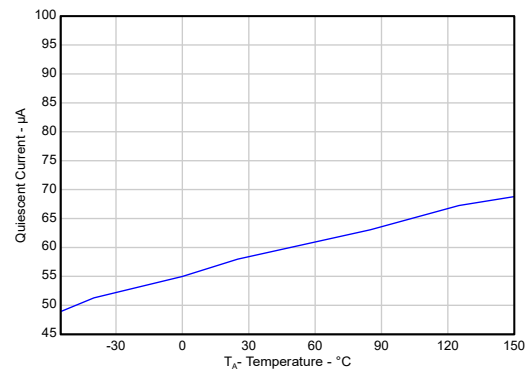

Figure 5-19. Quiescent Current vs Temperature ($I_L = 100\mu A$) (Legacy Chip)



$V_{IN} = 6V, V_{OUT} = 5V$

Figure 5-20. Quiescent Current vs Temperature ($I_L = 100\mu A$) (New Chip)

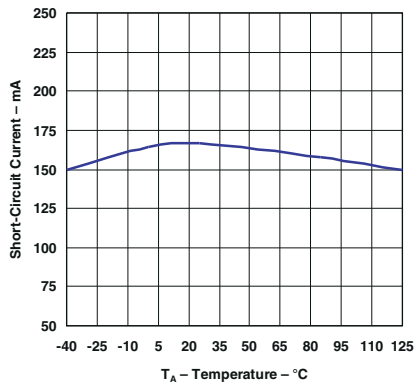
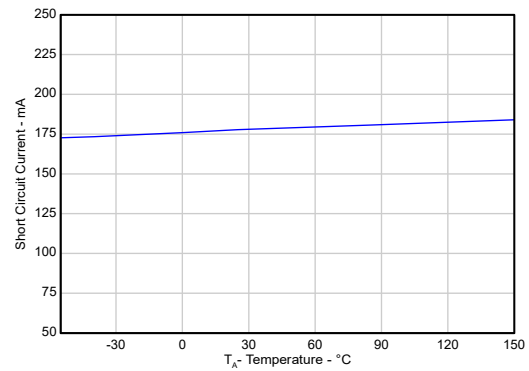

Figure 5-21. Short-Circuit Current vs Temperature (Legacy Chip)



$V_{IN} = 6V, V_{OUT} = 0V$

Figure 5-22. Short-Circuit Current vs Temperature (New Chip)

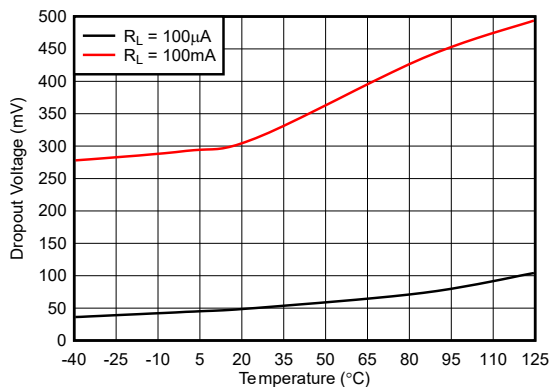
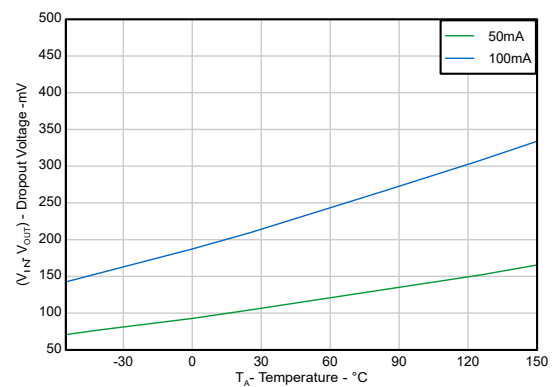

Figure 5-23. Dropout Voltage vs Temperature (Legacy Chip)



$V_{IN} = 4.9V$

Figure 5-24. Dropout Voltage vs Temperature (New Chip)

5.7 Typical Characteristics (continued)

at $V_{IN} = V_{OUT} (\text{nominal}) + 1V$, $I_L = 100\mu A$, $C_L = 1\mu F$ (for new chip) and $C_L = 2.2\mu F$ (for legacy chip) (unless otherwise noted)

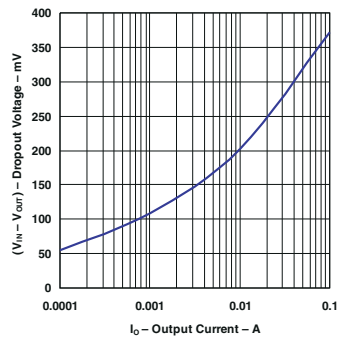
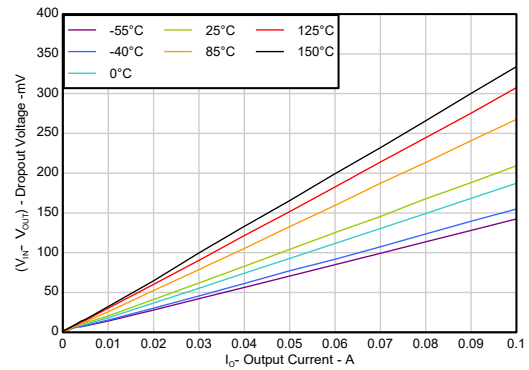

Figure 5-25. Dropout Voltage vs Dropout Current (Legacy Chip)



$V_{IN} = 4.9V$

Figure 5-26. Dropout Voltage vs Dropout Current (New Chip)

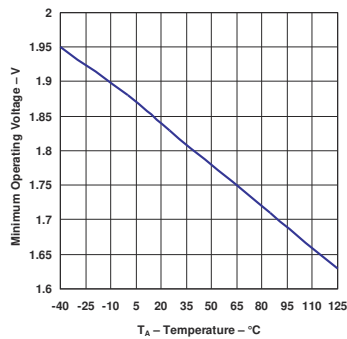

Figure 5-27. Minimum Operating Voltage vs Temperature (Legacy Chip)

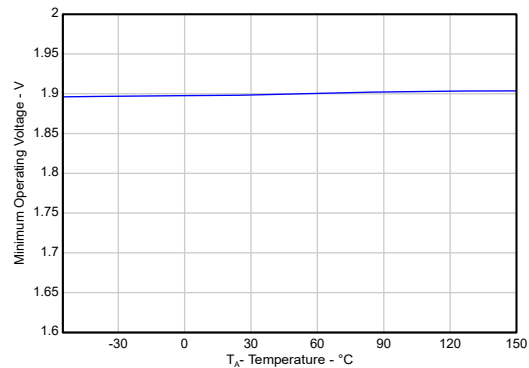

Figure 5-28. Minimum Operating Voltage vs Temperature (New Chip)

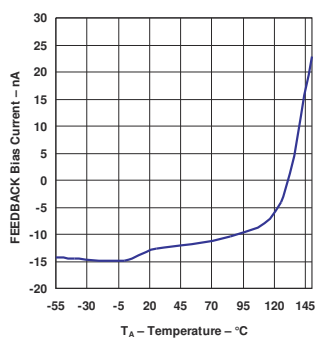

Figure 5-29. LP2951 FEEDBACK Bias Current vs Temperature (Legacy Chip)

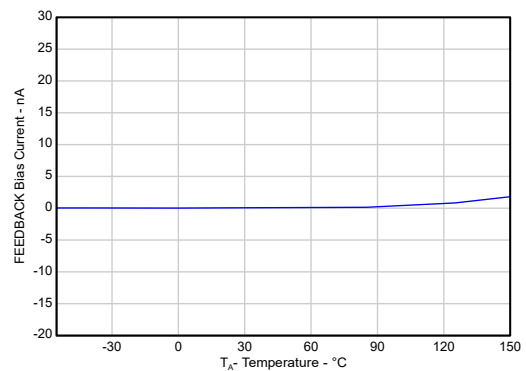

Figure 5-30. FEEDBACK Bias Current vs Temperature (New Chip)

5.7 Typical Characteristics (continued)

at $V_{IN} = V_{OUT} \text{ (nominal)} + 1V$, $I_L = 100\mu A$, $C_L = 1\mu F$ (for new chip) and $C_L = 2.2\mu F$ (for legacy chip) (unless otherwise noted)

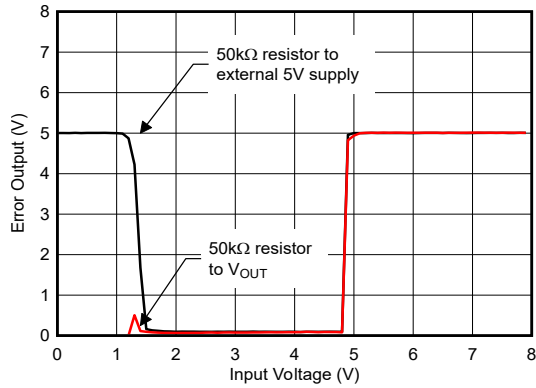

Figure 5-31. LP2951 ERROR Comparator Output vs Input Voltage (Legacy Chip)

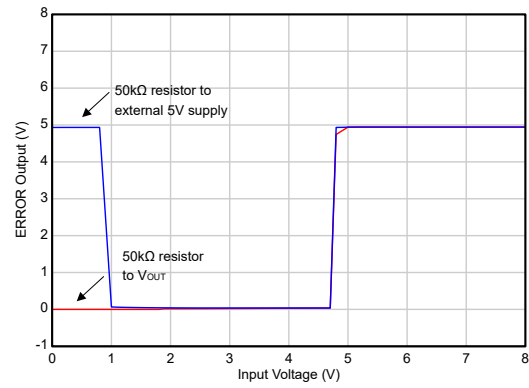

Figure 5-32. ERROR Comparator Output vs Input Voltage (New Chip)

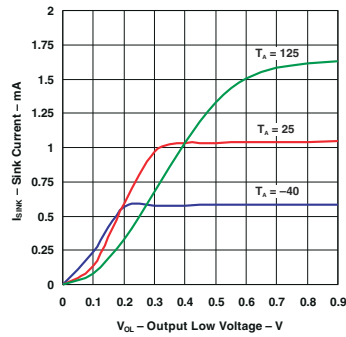

Figure 5-33. LP2951 ERROR Comparator Sink Current vs Output Low Voltage (Legacy Chip)

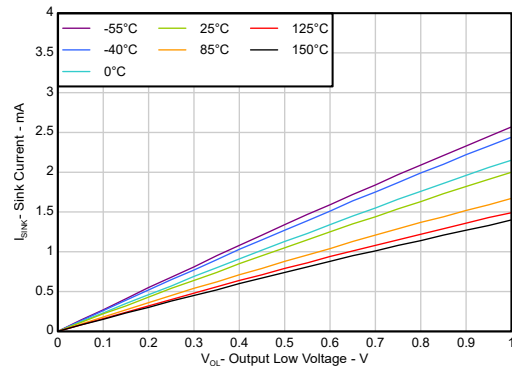

Figure 5-34. ERROR Comparator Sink Current vs Output Low Voltage (New Chip)

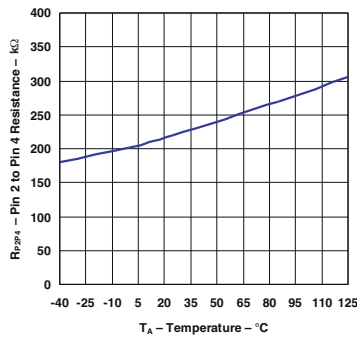

Figure 5-35. LP2951 Divider Resistance vs Temperature (Legacy Chip)

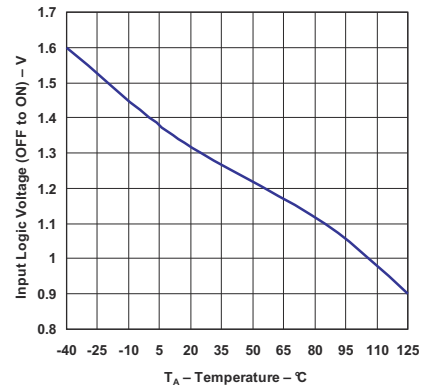

Figure 5-36. Shutdown Threshold Voltage (Off to On) vs Temperature (Legacy Chip)

5.7 Typical Characteristics (continued)

at $V_{IN} = V_{OUT} (\text{nominal}) + 1V$, $I_L = 100\mu A$, $C_L = 1\mu F$ (for new chip) and $C_L = 2.2\mu F$ (for legacy chip) (unless otherwise noted)

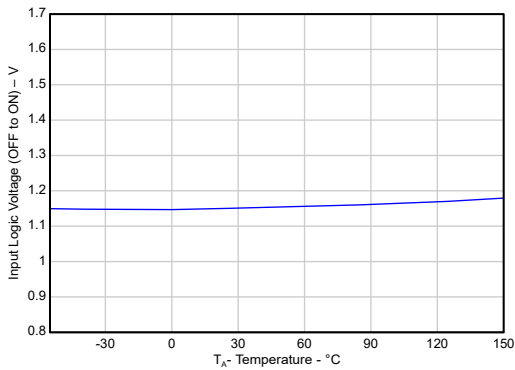

Figure 5-37. Shutdown Threshold Voltage (Off to On) vs Temperature (New Chip)

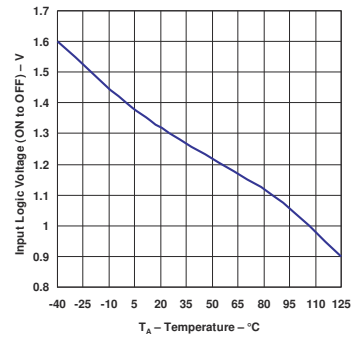

Figure 5-38. Shutdown Threshold Voltage (On to Off) vs Temperature (Legacy Chip)

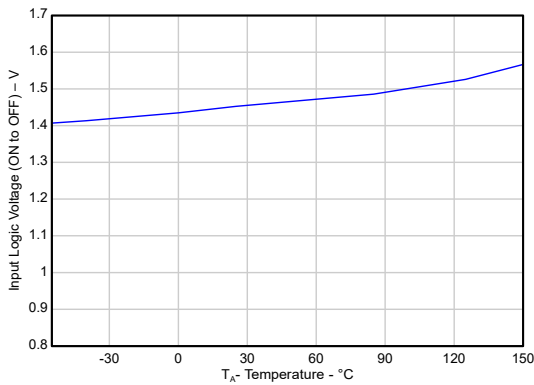

Figure 5-39. Shutdown Threshold Voltage (On to Off) vs Temperature (New Chip)

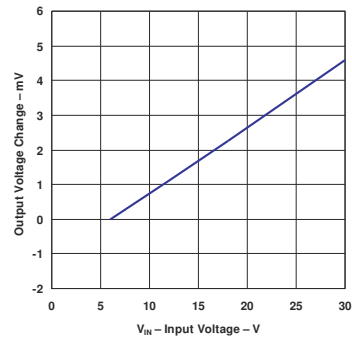
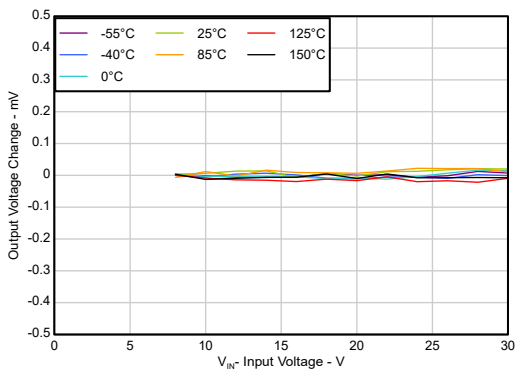
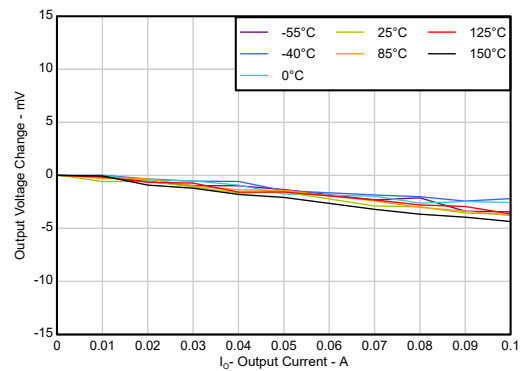

Figure 5-40. Line Regulation vs Input Voltage (Legacy Chip)



$V_{OUT} = 5V$, $I_{OUT} = 100\mu A$

Figure 5-41. Line Regulation vs Input Voltage (New Chip)



$V_{IN} = 6V$, $V_{OUT} = 5V$

Figure 5-42. Load Regulation vs Load Current (New Chip)

5.7 Typical Characteristics (continued)

at $V_{IN} = V_{OUT} (\text{nominal}) + 1V$, $I_L = 100\mu A$, $C_L = 1\mu F$ (for new chip) and $C_L = 2.2\mu F$ (for legacy chip) (unless otherwise noted)

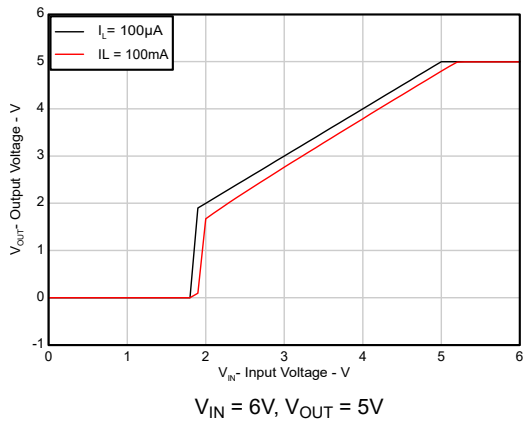

Figure 5-43. Output Voltage vs Input Voltage (New Chip)

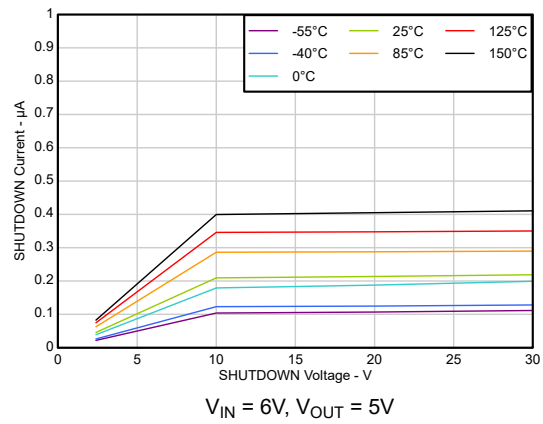

Figure 5-44. SHUTDOWN Input Current vs SHUTDOWN Voltage (New Chip)

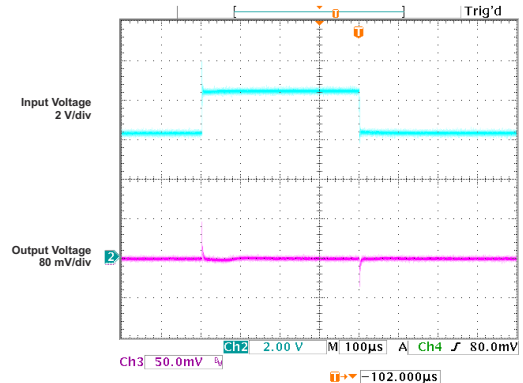

Figure 5-45. Line Transient Response vs Time (Legacy Chip)

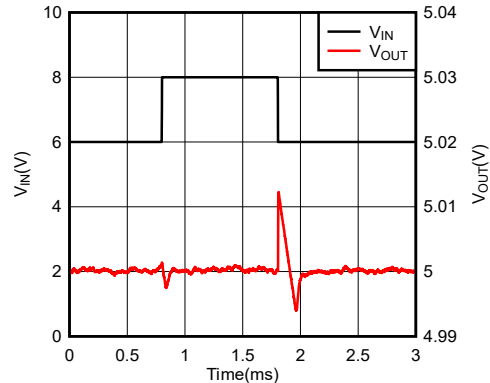

Figure 5-46. Line Transient Response vs Time (New Chip)

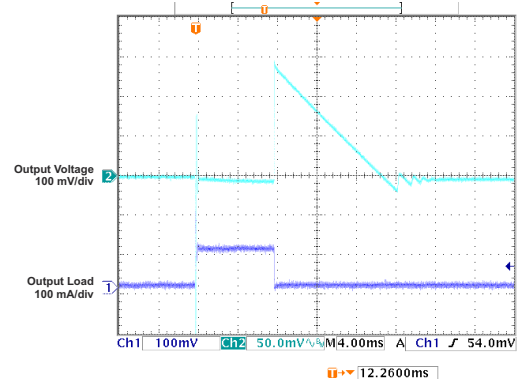

Figure 5-47. Load Transient Response vs Time ($V_{OUT} = 5V$, $C_L = 10\mu F$) (Legacy Chip)

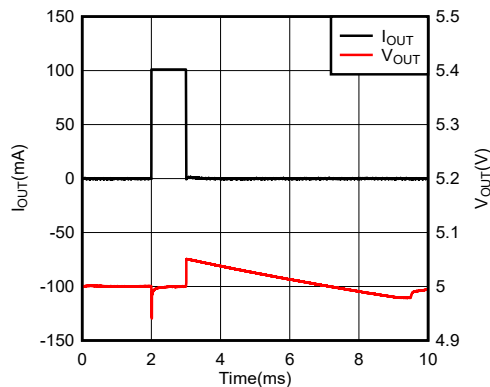
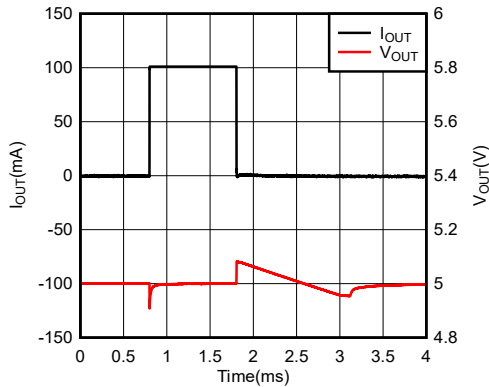

Figure 5-48. Load Transient Response vs Time (New Chip)

5.7 Typical Characteristics (continued)

at $V_{IN} = V_{OUT} (\text{nominal}) + 1V$, $I_L = 100\mu A$, $C_L = 1\mu F$ (for new chip) and $C_L = 2.2\mu F$ (for legacy chip) (unless otherwise noted)



$V_{IN} = 6V$, $V_{OUT} = 5V$, $I_{OUT} = 0$ to $100mA$, $C_{OUT} = 1\mu F$

Figure 5-49. Load Transient Response vs Time (New Chip)

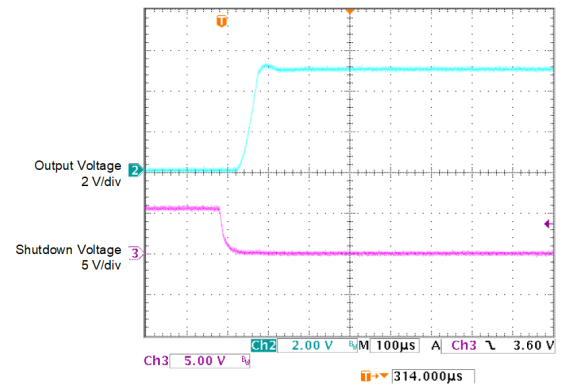
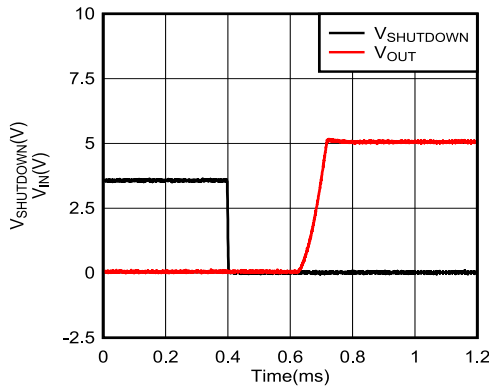

Figure 5-50. Enable Transient Response vs Time ($I_L = 1mA$, $C_L = 1\mu F$) (Legacy Chip)



$V_{IN} = 6V$, $V_{OUT} = 5V$, $C_{OUT} = 1\mu F$, $I_{OUT} = 1mA$

Figure 5-51. Enable Transient Response vs Time (New Chip)

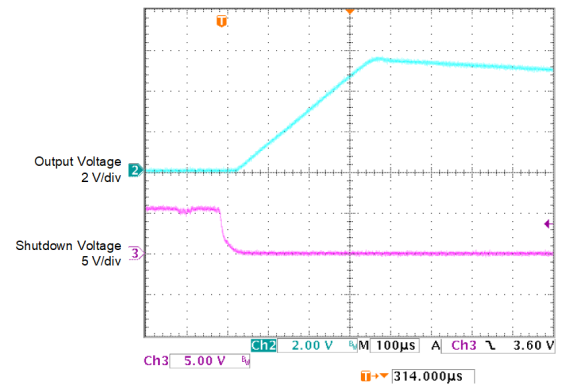
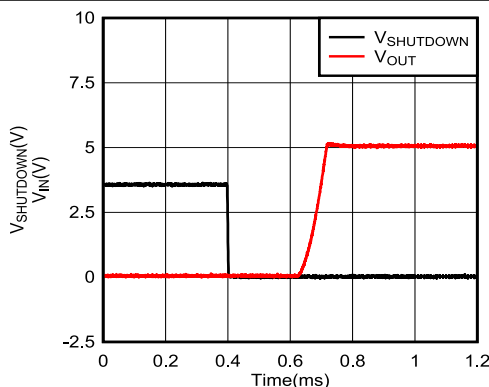

Figure 5-52. Enable Transient Response vs Time ($I_L = 1mA$, $C_L = 10\mu F$)



$V_{IN} = 6V$, $V_{OUT} = 5V$, $C_{OUT} = 10\mu F$, $I_{OUT} = 1mA$

Figure 5-53. Enable Transient Response vs Time (New Chip)

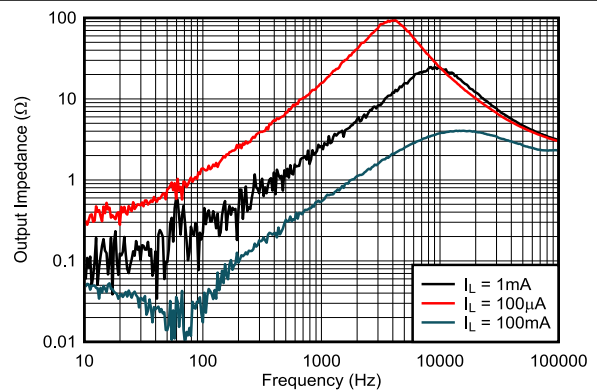

Figure 5-54. Output Impedance vs Frequency (Legacy Chip)

5.7 Typical Characteristics (continued)

at $V_{IN} = V_{OUT} (\text{nominal}) + 1V$, $I_L = 100\mu A$, $C_L = 1\mu F$ (for new chip) and $C_L = 2.2\mu F$ (for legacy chip) (unless otherwise noted)

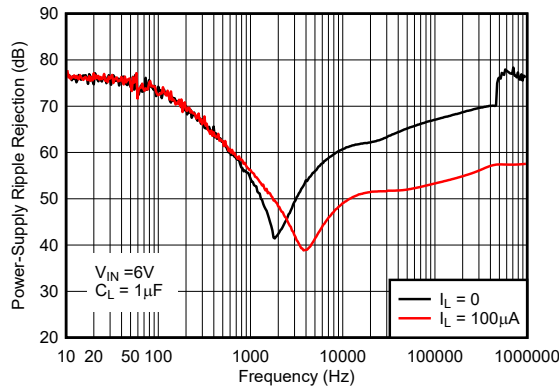

Figure 5-55. Ripple Rejection vs Frequency (Legacy Chip)

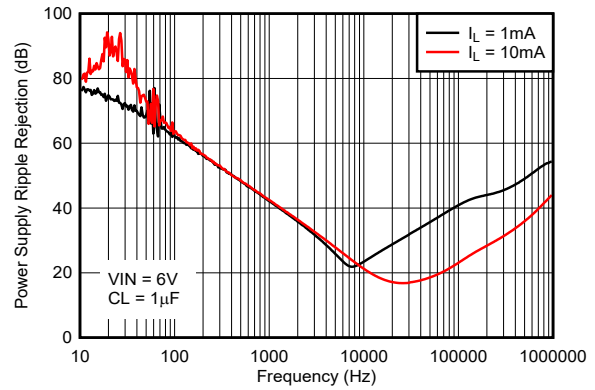

Figure 5-56. Ripple Rejection vs Frequency (Legacy Chip)

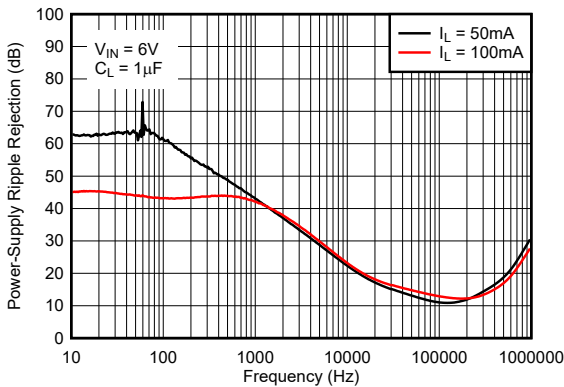

Figure 5-57. Ripple Rejection vs Frequency (Legacy Chip)

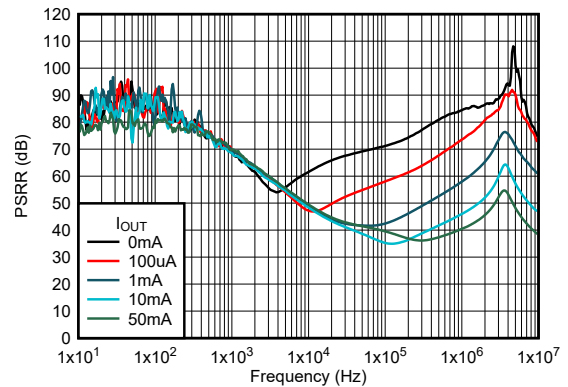

Figure 5-58. Ripple Rejection vs Frequency (New Chip)

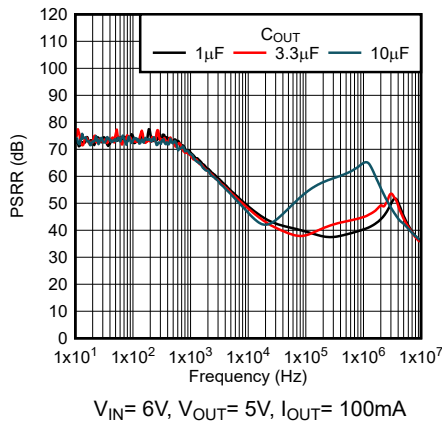

Figure 5-59. Ripple Rejection vs Frequency (New Chip)

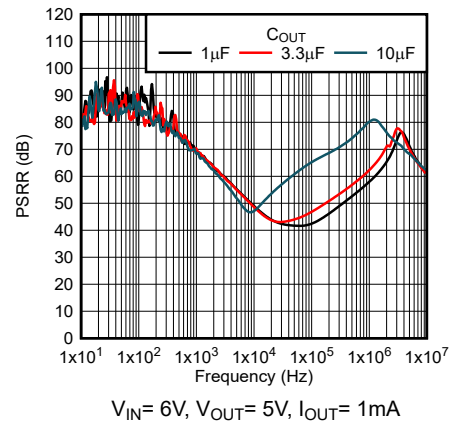

Figure 5-60. Ripple Rejection vs Frequency (New Chip)

5.7 Typical Characteristics (continued)

at $V_{IN} = V_{OUT} \text{ (nominal)} + 1V$, $I_L = 100\mu A$, $C_L = 1\mu F$ (for new chip) and $C_L = 2.2\mu F$ (for legacy chip) (unless otherwise noted)

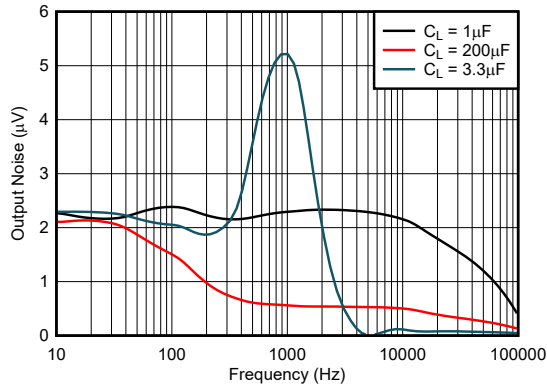
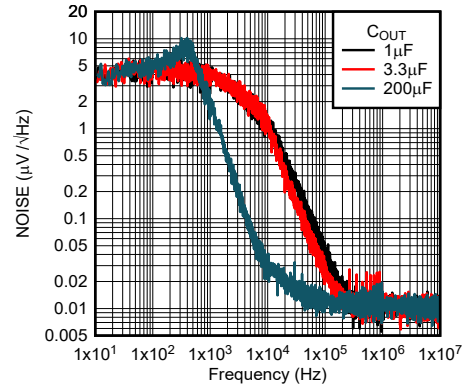
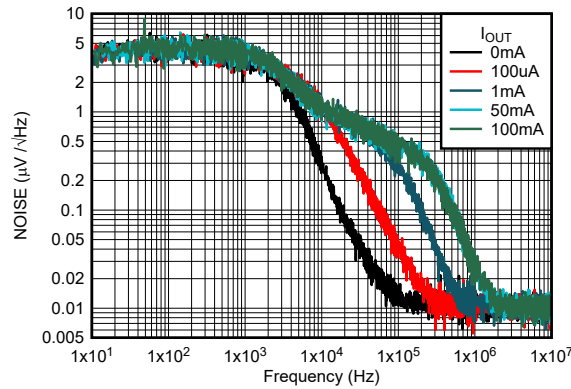

Figure 5-61. Output Noise vs Frequency (Legacy Chip)



$V_{IN} = 6V$, $V_{OUT} = 5V$, $I_{OUT} = 100\mu A$

Figure 5-62. Output Noise vs Frequency (New Chip)



$V_{IN} = 6V$, $V_{OUT} = 5V$, $C_{OUT} = 1\mu F$

Figure 5-63. Output Noise vs Frequency (New Chip)

6 Detailed Description

6.1 Overview

The LP2950 and LP2951 devices are low-dropout voltage regulators that accommodate a wide input supply-voltage range of up to 30V. The easy-to-use, 3-pin LP2950 is available in fixed-output voltages of 5V and 3.3V. However, the 8-pin LP2951 device outputs either a fixed or adjustable output from the same device. By tying the OUTPUT and SENSE pins together, and the FEEDBACK and V_{TAP} pins together, the LP295x device outputs a fixed 5V or 3.3V (depending on the version). Alternatively, by leaving the SENSE and V_{TAP} pins unconnected and connecting FEEDBACK to an external resistor divider, the output can be set to any value between V_{REF} to 30V (refer to [Electrical Characteristics \(Both Legacy and New Chip\)](#) for V_{REF} details).

The LP295x has a error flag output (\overline{ERROR}) that monitors the voltage at the feedback pin to indicate the status of the output voltage. The SHUTDOWN input and \overline{ERROR} output can be used for sequencing multiple power supplies in the system.

The LP295x devices are stable with small ceramic output capacitors, allowing for a small overall solution size. The LP295x devices has an output tolerance of 1% across line, load, and temperature variation (for the new chip) and is capable of delivering 100mA of continuous load current. This device includes integrated thermal shutdown, current limit, and undervoltage lockout (UVLO) features. These devices deliver excellent line and load transient performance. The operating ambient temperature range of the device is -40°C to 125°C .

6.2 Functional Block Diagrams

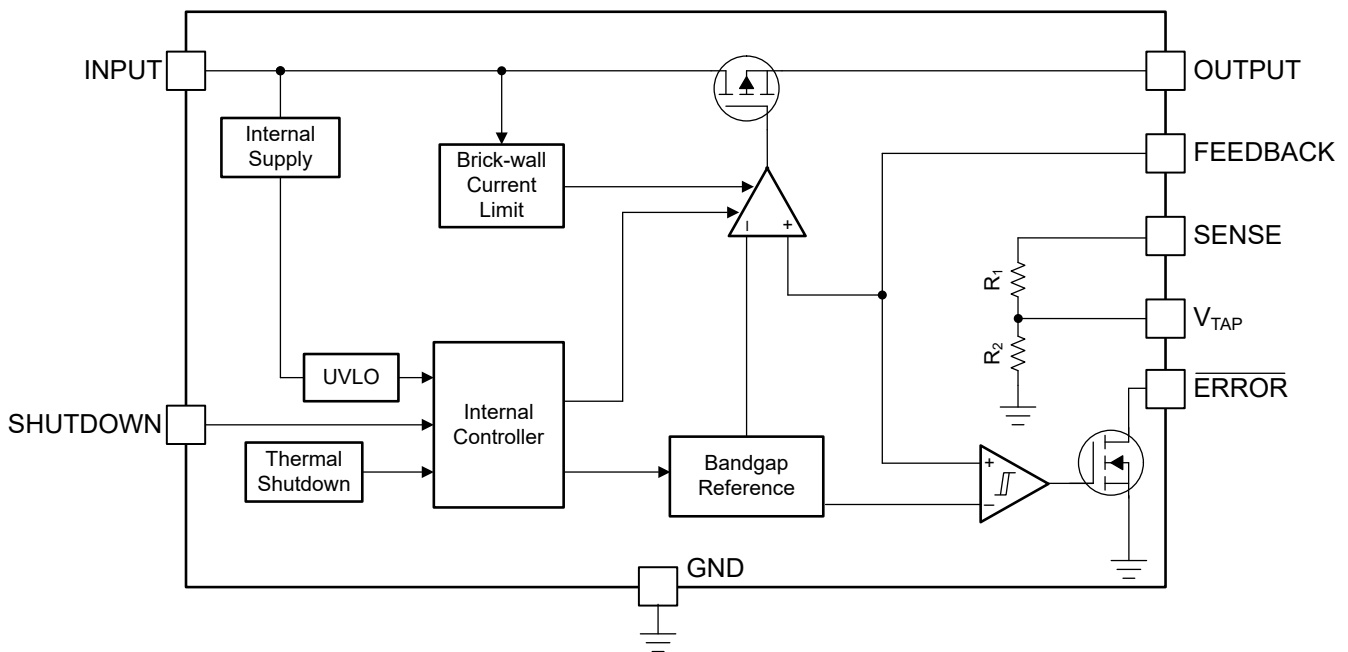

Figure 6-1. LP2951 Functional Block Diagram

6.3 Feature Description

6.3.1 Output Enable

The SHUTDOWN pin for the device is an active-high pin. The output voltage is enabled when the SHUTDOWN pin voltage is less than the low-level input voltage of the SHUTDOWN pin. The output voltage is disabled when the SHUTDOWN pin voltage is greater than the high-level input voltage of the SHUTDOWN pin. If independent control of the output voltage is not needed, connect the SHUTDOWN pin to the GND of the device.

6.3.2 Dropout Voltage

Dropout voltage (V_{DO}) is defined as $V_{IN} - V_{OUT}$ at the rated output current (I_{RATED}), where the pass transistor is fully on. V_{IN} is the input voltage, V_{OUT} is the output voltage and I_{RATED} is the maximum I_{OUT} listed in the [Section 5.3](#) table. At this operating point, the pass transistor is driven fully on. Dropout voltage indirectly specifies a minimum input voltage greater than the nominal programmed output voltage where the output voltage is expected to stay in regulation. If the input voltage falls to less than the nominal output regulation, then the output voltage falls as well.

For a CMOS regulator, the dropout voltage is determined by the drain-source on-state resistance ($R_{DS(ON)}$) of the pass transistor. Therefore, if the linear regulator operates at less than the rated current, the dropout voltage for that current scales accordingly. The following equation calculates the $R_{DS(ON)}$ of the device.

$$R_{DS(ON)} = \frac{V_{DO}}{I_{RATED}} \quad (1)$$

6.3.3 Current Limit

The device has an internal current limit circuit that protects the regulator during transient high-load current faults or shorting events. The current limit is a brick-wall scheme. In a high-load current fault, the brick-wall scheme limits the output current to the current limit (I_{CL}). I_{CL} is listed in the [Section 5.5](#) table.

The output voltage is not regulated when the device is in current limit. When a current limit event occurs, the device begins to heat up because of the increase in power dissipation. When the device is in brick-wall current limit, the pass transistor dissipates power $[(V_{IN} - V_{OUT}) \times I_{CL}]$. If thermal shutdown is triggered, the device turns off. After the device cools down, the internal thermal shutdown circuit turns the device back on. If the output current fault condition continues, the device cycles between current limit and thermal shutdown. For more information on current limits, see the [Know Your Limits application note](#).

Figure 6-2 shows a diagram of the current limit.

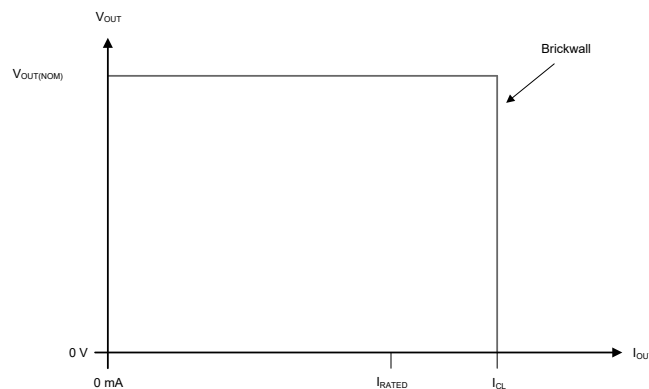

Figure 6-2. Current Limit

6.3.4 Undervoltage Lockout (UVLO)

The device has an independent undervoltage lockout (UVLO) circuit that monitors the input voltage, allowing a controlled and consistent turn on and off of the output voltage. To prevent the device from turning off if the input drops during turn on, the UVLO has hysteresis as specified in the [Section 5.5](#) table.

6.3.5 Thermal Shutdown

The device contains a thermal shutdown protection circuit to disable the device when the junction temperature (T_J) of the pass transistor rises to $T_{SD(\text{shutdown})}$ (typical). Thermal shutdown hysteresis verifies that the device resets (turns on) when the temperature falls to $T_{SD(\text{reset})}$ (typical).

The thermal time-constant of the semiconductor die is fairly short, thus the device cycles on and off when thermal shutdown is reached until power dissipation is reduced. Power dissipation during start up is potentially high from large $V_{IN} - V_{OUT}$ voltage drops across the device or from high inrush currents charging large output capacitors. Under some conditions, the thermal shutdown protection disables the device before start-up completes.

For reliable operation, limit the junction temperature to the maximum listed in the [Section 5.3](#) table. Operation above this maximum temperature causes the device to exceed operational specifications. Although the internal protection circuitry of the device is designed to protect against thermal overall conditions, this circuitry is not intended to replace proper heat sinking. Continuously running the device into thermal shutdown or above the maximum recommended junction temperature reduces long-term reliability.

6.4 Device Functional Modes

6.4.1 Shutdown Mode

These devices can be placed in shutdown mode with a logic high at the SHUTDOWN pin. Return the logic level low to restore operation or tie SHUTDOWN to ground if the feature is not being used.

7 Application and Implementation

Note

Information in the following applications sections is not part of the TI component specification, and TI does not warrant its accuracy or completeness. TI's customers are responsible for determining suitability of components for their purposes, as well as validating and testing their design implementation to confirm system functionality.

7.1 Application Information

The LP295x devices are used as low-dropout regulators with a wide range of input voltages.

7.1.1 Reverse Current

Excessive reverse current potentially damages this device. Reverse current flows through the intrinsic body diode of the pass transistor instead of the normal conducting channel. At high magnitudes, this current flow degrades the long-term reliability of the device.

Conditions where reverse current occurs are outlined in this section, all of which potentially exceed the absolute maximum rating of $V_{OUT} \leq V_{IN} + 0.3V$.

- If the device has a large C_{OUT} and the input supply collapses with little or no load current
- The output is biased when the input supply is not established
- The output is biased above the input supply

If reverse current flow is expected in the application, use external protection to protect the device. Reverse current is not limited in the device, so external limiting is required if extended reverse voltage operation is anticipated.

[Figure 7-1](#) shows one approach for protecting the device.

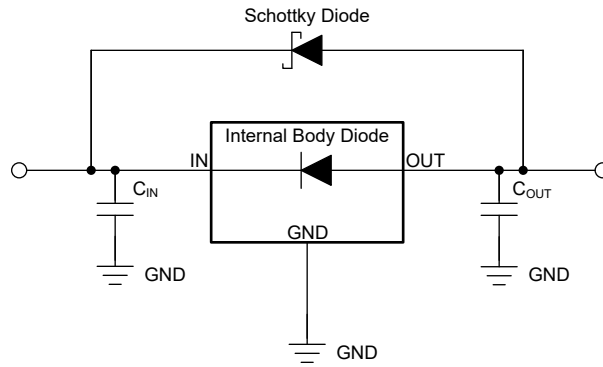

Figure 7-1. Example Circuit for Reverse Current Protection Using a Schottky Diode

7.1.2 Input and Output Capacitor Requirements

Although an input capacitor is not required for stability, good analog design practice is to connect a capacitor from IN to GND. This capacitor counteracts reactive input sources and improves transient response, input ripple, and PSRR. Use an input capacitor if the source impedance is more than 0.5Ω . A higher value capacitor can be necessary if large, fast rise-time load or line transients are anticipated or if the device is located several inches from the input power source.

Dynamic performance of the device is improved with the use of an output capacitor. Use an output capacitor within the range specified in the [Section 5.3](#) table for stability.

7.1.3 Estimating Junction Temperature

The JEDEC standard now recommends the use of psi (Ψ) thermal metrics to estimate the junction temperatures of the linear regulator when in-circuit on a typical PCB board application. These metrics are not thermal resistance parameters and instead offer a practical and relative way to estimate junction temperature. These psi metrics are determined to be significantly independent of the copper area available for heat-spreading. The [Section 5.4](#) table lists the primary thermal metrics, which are the junction-to-top characterization parameter (ψ_{JT}) and junction-to-board characterization parameter (ψ_{JB}). These parameters provide two methods for calculating the junction temperature (T_J), as described in the following equations. Use the junction-to-top characterization parameter (ψ_{JT}) with the temperature at the center-top of device package (T_T) to calculate the junction temperature. Use the junction-to-board characterization parameter (ψ_{JB}) with the PCB surface temperature 1mm from the device package (T_B) to calculate the junction temperature.

$$T_J = T_T + \psi_{JT} \times P_D \quad (2)$$

where:

- P_D is the dissipated power
- T_T is the temperature at the center-top of the device package

$$T_J = T_B + \psi_{JB} \times P_D \quad (3)$$

where:

- T_B is the PCB surface temperature measured 1mm from the device package and centered on the package edge

For detailed information on the thermal metrics and how to use the metrics, see the [Semiconductor and IC Package Thermal Metrics](#) application note.

7.1.4 Power Dissipation (P_D)

Circuit reliability requires consideration of the device power dissipation, location of the circuit on the printed circuit board (PCB), and correct sizing of the thermal plane. The PCB area around the regulator must have few or no other heat-generating devices that cause added thermal stress.

To first-order approximation, power dissipation in the regulator depends on the input-to-output voltage difference and load conditions. The following equation calculates power dissipation (P_D).

$$P_D = (V_{IN} - V_{OUT}) \times I_{OUT} \tag{4}$$

Note

Power dissipation is minimized, and therefore greater efficiency is achieved, by correct selection of the system voltage rails. For the lowest power dissipation use the minimum input voltage required for correct output regulation.

For devices with a thermal pad, the primary heat conduction path for the device package is through the thermal pad to the PCB. Solder the thermal pad to a copper pad area under the device. Make sure this pad area contains an array of plated vias that conduct heat to additional copper planes for increased heat dissipation.

The maximum power dissipation determines the maximum allowable ambient temperature (T_A) for the device. According to the following equation, power dissipation and junction temperature are most often related by the junction-to-ambient thermal resistance ($R_{\theta JA}$) of the combined PCB and device package and the temperature of the ambient air (T_A).

$$T_J = T_A + (R_{\theta JA} \times P_D) \tag{5}$$

Thermal resistance ($R_{\theta JA}$) is highly dependent on the heat-spreading capability built into the particular PCB design, and therefore varies according to the total copper area, copper weight, and location of the planes. The junction-to-ambient thermal resistance listed in the [Section 5.4](#) table is determined by the JEDEC standard PCB and copper-spreading area. This thermal resistance is used as a relative measure of package thermal performance.

7.2 Typical Application

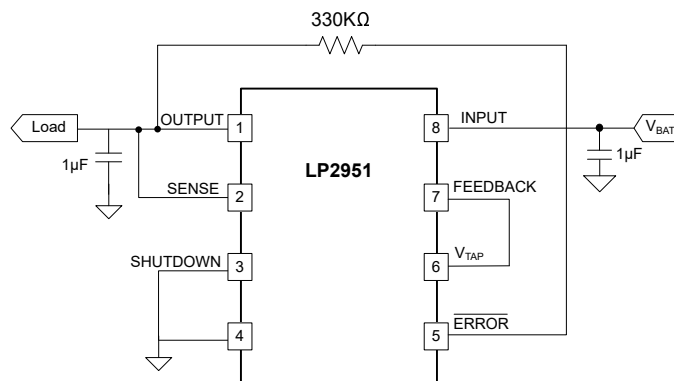

Figure 7-2. 12V to 5V Converter

7.2.1 Design Requirements

Minimum C_{OUT} value for stability (can be increased to 100µF for improved stability and transient response)

SHUTDOWN must be actively terminated. Connect to GND if shutdown feature is not used.

7.2.1.1 Recommended Capacitor Types

7.2.1.1.1 Recommended Capacitors for the Legacy Chip

Most tantalum or aluminum electrolytics are used at the input. Film-type capacitors also work but at higher cost. Ceramic capacitors are available for use at the output, but the low ESR (as low as 5mΩ to 10mΩ) potentially causes the output to not meet the minimum ESR requirement. If a ceramic capacitor is used, add a series resistor between 0.1Ω to 2Ω to meet the minimum ESR requirement.

Ceramic capacitors can be used, but because of the low ESR (as low as 5mΩ to 10mΩ), these capacitors can possibly not meet the minimum ESR requirement previously discussed. If a ceramic capacitor is used, a series resistor between 0.1Ω to 2Ω must be added to meet the minimum ESR requirement. In addition, ceramic capacitors have one glaring disadvantage that must be taken into account — a poor temperature coefficient, where the capacitance can vary significantly with temperature. For instance, a large-value ceramic capacitor ($\geq 2.2\mu\text{F}$) can lose more than half of the capacitance as temperature rises from 25°C to 85°C. Thus, a 2.2μF capacitor at 25°C drops well below the minimum C_L required for stability as ambient temperature rises. For this reason, select an output capacitor that maintains the minimum 2.2μF required for stability for the entire operating temperature range.

7.2.1.1.1.1 ESR Range (Legacy Chip)

The regulator control loop relies on the ESR of the output capacitor to provide a zero to add sufficient phase margin to provide unconditional regulator stability. This condition requires the closed-loop gain to intersect the open-loop response in a region where the open-loop gain rolls off at 20dB/decade. This roll off makes sure that the phase is always less than 180° (phase margin greater than 0°) at unity gain. Thus, a minimum-maximum range for the ESR must be observed.

The upper limit of this ESR range is established by the fact that an ESR that is too high can result in the zero occurring too soon, causing the gain to roll off too slowly. This effect, in turn, allows a third pole to appear before unity gain and introduces enough phase shift to cause instability. This phase shift typically limits the maximum ESR to approximately 5Ω.

Conversely, the lower limit of the ESR range is tied to the fact that an ESR that is too low shifts the zero too far out, past unity gain, which allows the gain to roll off at 40dB/decade at unity gain, resulting in a phase shift of greater than 180°. Typically, this limits the minimum ESR to approximately 20mΩ to 30mΩ.

For specific ESR requirements, see the [Section 5.7](#) section.

7.2.1.1.2 Recommended Capacitors for the New Chip

The new chip requires an output capacitor of at least 1μF for stability and an equivalent series resistance (ESR) between 0Ω and 2Ω. Without the output capacitor, the regulator oscillates. For best transient performance, use X5R- and X7R-type ceramic capacitors because these capacitors have minimal variation in value and ESR over temperature. When choosing a capacitor for a specific application, be mindful of the DC bias characteristics for the capacitor. Higher output voltages cause a significant derating of the capacitor. For best performance, the maximum recommended output capacitor is 100μF. An input capacitor is not required for stability, however, good analog practice is to connect a capacitor (500nF or higher) between the GND and IN pin. Some input supplies have a high impedance, thus placing the input capacitor on the input supply helps reduce input impedance. This capacitor counteracts reactive input sources and improves transient response, input ripple, and PSRR. If the input supply has a high impedance over a large range of frequencies, use several input capacitors in parallel to lower the impedance over frequency. Use a higher-value capacitor if large, fast rise-time load transients are anticipated, or if the device is located several inches from the input power source.

7.2.2 Detailed Design Procedure

7.2.2.1 Feedback Resistor Selection

V_{OUT} is set by the external feedback resistors R_1 and R_2 according to the following equation:

$$V_{\text{OUT}} = V_{\text{REF}} \times \left(1 + \frac{R_1}{R_2}\right) \quad (6)$$

Refer to [Section 5.5](#) table for V_{REF} details.

To ignore the FEEDBACK pin current (I_{FB}) error term in the V_{OUT} equation, set the feedback divider current to 100 times the FEEDBACK pin current (I_{FB}) listed in the [Section 5.5](#) table. This setting provides the maximum feedback divider series resistance, as shown in the following equation:

$$R_1 + R_2 \leq \frac{V_{OUT}}{(I_{FB} \times 100)} \quad (7)$$

7.2.2.2 Feedforward Capacitor

Connect a feedforward capacitor (C_{FF}) between the OUT pin and the FEEDBACK pin. C_{FF} improves transient, noise, and PSRR performance. A higher capacitance C_{FF} is possible, however, the start-up time increases. For a detailed description of C_{FF} tradeoffs, see the [Pros and Cons of Using a Feedforward Capacitor with a Low-Dropout Regulator application note](#).

As shown in [Formation of Parasitic Capacitor at the FEEDBACK Pin](#), poor layout practices and using long traces at the FEEDBACK pin results in the formation of a parasitic capacitor (C_{FB}).

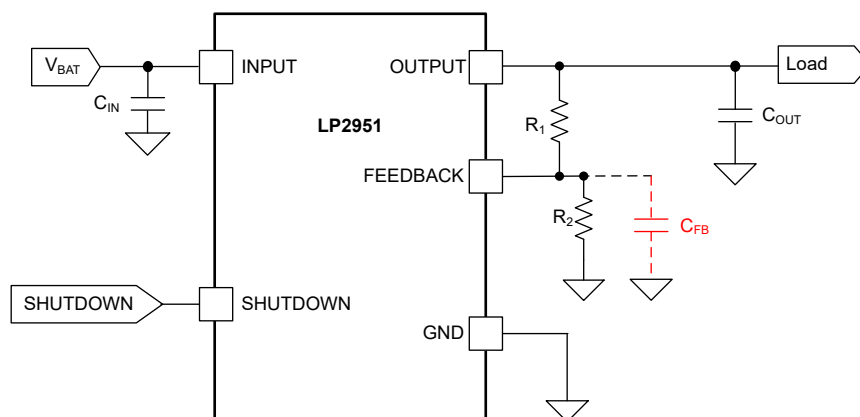

Figure 7-3. Formation of Parasitic Capacitor at the FEEDBACK Pin

C_{FB} , along with the feedback resistors R_1 and R_2 potentially result in the formation of an uncompensated pole in the transfer function of the loop gain. A C_{FB} value as small as 6pF potentially causes the parasitic pole frequency, given by [Equation 8](#), to fall within the bandwidth of the LDO and result in instability.

$$f_P = \frac{1}{(2 \times \pi \times C_{FB} \times (R_1 \parallel R_2))} \quad (8)$$

Adding a feedforward capacitor (C_{FF}), as shown in [Figure 7-4](#), creates a zero in the loop gain transfer function that can compensate for the parasitic pole created by C_{FB} . [Equation 9](#) and [Equation 10](#) calculate the pole and zero frequencies.

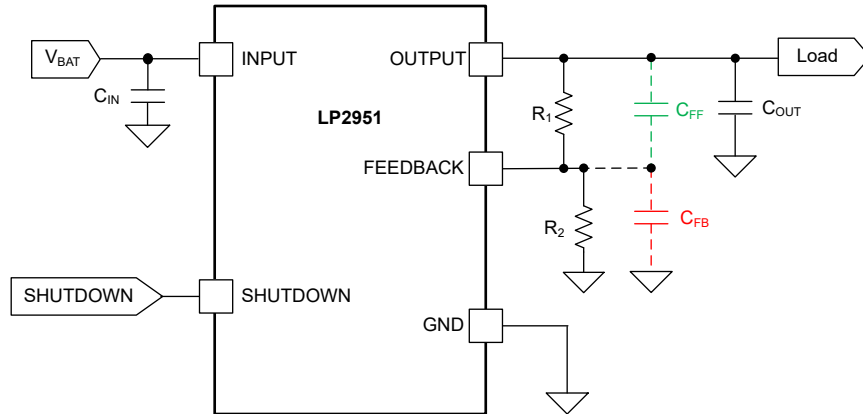

Figure 7-4. Feedforward Capacitor Can Compensate the Effects of the Parasitic Capacitor

$$f_p = \frac{1}{(2 \times \pi \times (R_1 \parallel R_2) \times (C_{FF} + C_{FB}))} \quad (9)$$

$$f_z = \frac{1}{(2 \times \pi \times C_{FF} \times R_1)} \quad (10)$$

The C_{FF} value that makes f_p equal to f_z , and result in a pole-zero cancellation, depends on the values of C_{FB} and the feedback resistors used in the application. Alternatively, if the feedforward capacitor is selected so that $C_{FF} \gg C_{FB}$, then the pole and zero frequencies given by Equation 9 and Equation 10 are related as:

$$\frac{f_p}{f_z} \cong \left(1 + \frac{R_1}{R_2}\right) = \frac{V_{OUT}}{V_{REF}} \quad (11)$$

In most applications, particularly where a 3.3V or 5V V_{OUT} is generated, this ratio is not very large, implying that the frequencies are located close to each other and therefore the parasitic pole is compensated. Even for large V_{OUT} values, where this ratio can be as large as 20, a C_{FF} value in the range $100\text{pF} \leq C_{FF} \leq 10\text{nF}$ typically helps prevent instability caused by the parasitic capacitance on the feedback node.

7.2.3 Application Curve

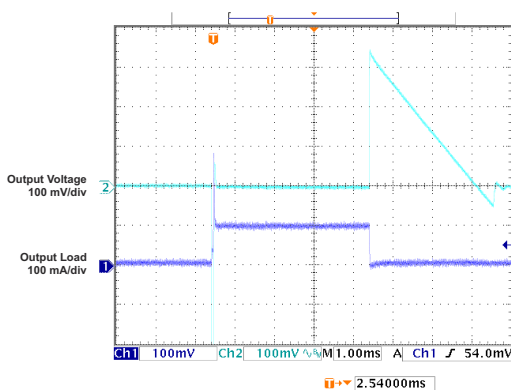
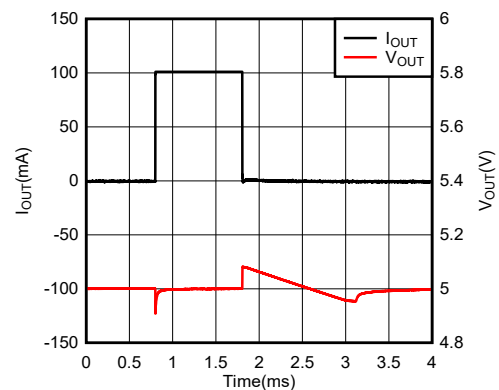

Figure 7-5. Load Transient Response vs Time (Legacy Chip)



$V_{IN} = 6\text{V}$, $V_{OUT} = 5\text{V}$, $I_{OUT} = 0$ to 100mA , $C_{OUT} = 1\mu\text{F}$

Figure 7-6. Load Transient Response vs Time (New Chip)

7.3 Power Supply Recommendations

Maximum input voltage must be limited to 30V for proper operation. Place input and output capacitors as close to the device as possible to take advantage of the high frequency noise filtering properties.

7.4 Layout

7.4.1 Layout Guidelines

Make sure that traces on the input and outputs of the device are wide enough to handle the desired currents. For this device, the output trace must be larger to accommodate the larger available current.

Place input and output capacitors as close to the device as possible to take advantage of the high-frequency, noise-filtering properties.

7.4.2 Layout Example

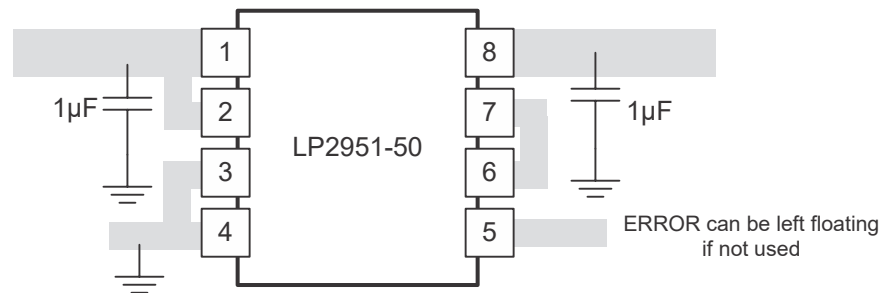

Figure 7-7. LP2951 Layout Example (D or P Package)

8 Device and Documentation Support

8.1 Device Support

8.1.1 Development Support

An evaluation module (EVM) is available to assist in the initial circuit performance evaluation. The [LP2951EVM](#) (and [related user guide](#)) can be requested at the Texas Instruments website through the product folders or purchased directly from the [TI eStore](#).

8.2 Receiving Notification of Documentation Updates

To receive notification of documentation updates, navigate to the device product folder on [ti.com](#). Click on *Notifications* to register and receive a weekly digest of any product information that has changed. For change details, review the revision history included in any revised document.

8.3 Device Nomenclature

Table 8-1. Device Nomenclature

| PRODUCT ⁽¹⁾ | V _{OUT} |
|--------------------------|---------------------------------------------------------------------------------------------------------------------------------------------------------------------------------------------------------------------------------------------------------------------------------------------------------------------------------------------------------------------------------------------------------------------------------------------------------------------------------------------------|
| LP2951- xyyyz | xx is the nominal output voltage (for example, 50 = 5.0V, 33 = 3.3V). yyy is the package designator. z is the package quantity. This device can be configured to have both adjustable or fixed output. Devices can ship with the legacy chip (CSO: SHE) or the new chip (CSO: RFB). The reel packaging label provides CSO information to distinguish which chip is being used. Device performance for new and legacy chips is denoted throughout the data sheet. |
| LP2951DR | Adjustable option. Devices can ship with the legacy chip (CSO: SHE) or the new chip (CSO: RFB). The reel packaging label provides CSO information to distinguish which chip is being used. Device performance for new and legacy chips is denoted throughout the data sheet. |
| LP2951- xxADJyyyz | xx is the nominal output voltage (for example, 50 = 5.0V, 33 = 3.3V). yyy is the package designator. z is the package quantity. This device can be configured to have both adjustable or fixed output.. ADJ indicates that this device only ships with the new chip and retains legacy chip internal reference (VREF) limits in adjustable configuration. |
| LP2950- xyyyz | xx is the nominal output voltage (for example, 50 = 5.0V, 33 = 3.3V). yyy is the package designator. z is the package quantity. Devices can ship with the legacy chip (CSO: SHE) or the new chip (CSO: RFB). The reel packaging label provides CSO information to distinguish which chip is being used. Device performance for new and legacy chips is denoted throughout the data sheet. |

(1) For the most current package and ordering information see the Package Option Addendum at the end of this document, or see the TI website at [www.ti.com](#).

8.4 Documentation Support

8.4.1 Related Documentation

- Texas Instruments, [LP2951EVM](#), EVM user's guide

8.5 Support Resources

[TI E2E™ support forums](#) are an engineer's go-to source for fast, verified answers and design help — straight from the experts. Search existing answers or ask your own question to get the quick design help you need.

Linked content is provided "AS IS" by the respective contributors. They do not constitute TI specifications and do not necessarily reflect TI's views; see TI's [Terms of Use](#).

8.6 Trademarks

TI E2E™ is a trademark of Texas Instruments.
All trademarks are the property of their respective owners.

8.7 Electrostatic Discharge Caution



This integrated circuit can be damaged by ESD. Texas Instruments recommends that all integrated circuits be handled with appropriate precautions. Failure to observe proper handling and installation procedures can cause damage.

ESD damage can range from subtle performance degradation to complete device failure. Precision integrated circuits may be more susceptible to damage because very small parametric changes could cause the device not to meet its published specifications.

8.8 Glossary

[TI Glossary](#) This glossary lists and explains terms, acronyms, and definitions.

9 Revision History

NOTE: Page numbers for previous revisions may differ from page numbers in the current version.

| Changes from Revision K (December 2024) to Revision L (June 2026) | | Page |
|--------------------------------------------------------------------------|--|-------------|
| • Updated output range for the adjustable configuration..... | | 1 |
| • Updated output range for adjustable configuration..... | | 1 |
| • Updated thermal details of DRG package..... | | 5 |
| • Added Electrical limits for LP295X-XXADJ variant | | 5 |
| • Updated details about V_{REF} for adjustable configuration..... | | 22 |
| • Updated details about V_{REF} for adjustable configuration..... | | 27 |
| • Corrected the details about Feedback pin and I_{FB} | | 28 |
| • Added nomenclature details for LP2951-xxADJ OPNs..... | | 31 |

| Changes from Revision J (August 2024) to Revision K (December 2024) | | Page |
|---------------------------------------------------------------------------------------------------------------------|--|-------------|
| • Updated the numbering format for tables, figures, and cross-references throughout the document..... | | 1 |
| • Updated accuracy and dropout specifications for LP package..... | | 1 |
| • Added thermal information for LP package..... | | 1 |
| • Updated and added corrections to the operating temperature range in Recommended Operating Conditions section..... | | 4 |

10 Mechanical, Packaging, and Orderable Information

The following pages include mechanical, packaging, and orderable information. This information is the most current data available for the designated devices. This data is subject to change without notice and revision of this document. For browser-based versions of this data sheet, refer to the left-hand navigation.

PACKAGING INFORMATION

| Orderable part number | Status (1) | Material type (2) | Package Pins | Package qty Carrier | RoHS (3) | Lead finish/ Ball material (4) | MSL rating/ Peak reflow (5) | Op temp (°C) | Part marking (6) |
|--------------------------------|---------------|----------------------|----------------|-----------------------|-------------|--------------------------------------|-----------------------------------|--------------|---------------------|
| LP2950-30LP | Active | Production | TO-92 (LP) 3 | 1000 BULK | Yes | SN | N/A for Pkg Type | -40 to 125 | KY5030 |
| LP2950-30LP.A | Active | Production | TO-92 (LP) 3 | 1000 BULK | Yes | SN | N/A for Pkg Type | -40 to 125 | KY5030 |
| LP2950-30LPR | Active | Production | TO-92 (LP) 3 | 2000 LARGE T&R | Yes | SN | N/A for Pkg Type | -40 to 125 | KY5030 |
| LP2950-30LPR.A | Active | Production | TO-92 (LP) 3 | 2000 LARGE T&R | Yes | SN | N/A for Pkg Type | -40 to 125 | KY5030 |
| LP2950-30LPRE3 | Active | Production | TO-92 (LP) 3 | 2000 LARGE T&R | Yes | SN | N/A for Pkg Type | -40 to 125 | KY5030 |
| LP2950-33LPE3 | Active | Production | TO-92 (LP) 3 | 1000 BULK | Yes | SN | N/A for Pkg Type | -40 to 125 | KY5033 |
| LP2950-33LPE3.A | Active | Production | TO-92 (LP) 3 | 1000 BULK | Yes | SN | N/A for Pkg Type | -40 to 125 | KY5033 |
| LP2950-33LPRE3 | Active | Production | TO-92 (LP) 3 | 2000 LARGE T&R | Yes | SN | N/A for Pkg Type | -40 to 125 | KY5033 |
| LP2950-33LPRE3.A | Active | Production | TO-92 (LP) 3 | 2000 LARGE T&R | Yes | SN | N/A for Pkg Type | -40 to 125 | KY5033 |
| LP2950-50LPRE3 | Active | Production | TO-92 (LP) 3 | 2000 LARGE T&R | Yes | SN | N/A for Pkg Type | -40 to 125 | KY5050 |
| LP2950-50LPRE3.A | Active | Production | TO-92 (LP) 3 | 2000 LARGE T&R | Yes | SN | N/A for Pkg Type | -40 to 125 | KY5050 |
| LP2951-30D | Active | Production | SOIC (D) 8 | 75 TUBE | Yes | NIPDAU | Level-1-260C-UNLIM | -40 to 125 | KY5130 |
| LP2951-30D.A | Active | Production | SOIC (D) 8 | 75 TUBE | Yes | NIPDAU | Level-1-260C-UNLIM | -40 to 125 | KY5130 |
| LP2951-30DR | Active | Production | SOIC (D) 8 | 2500 LARGE T&R | Yes | NIPDAU | Level-1-260C-UNLIM | -40 to 125 | KY5130 |
| LP2951-30DR.A | Active | Production | SOIC (D) 8 | 2500 LARGE T&R | Yes | NIPDAU | Level-1-260C-UNLIM | -40 to 125 | KY5130 |
| LP2951-30DRGR | Active | Production | SON (DRG) 8 | 3000 LARGE T&R | Yes | NIPDAU | Level-2-260C-1 YEAR | -40 to 125 | ZUD |
| LP2951-30DRGR.A | Active | Production | SON (DRG) 8 | 3000 LARGE T&R | Yes | NIPDAU | Level-2-260C-1 YEAR | -40 to 125 | ZUD |
| LP2951-33D | Active | Production | SOIC (D) 8 | 75 TUBE | Yes | NIPDAU | Level-1-260C-UNLIM | -40 to 125 | KY5133 |
| LP2951-33D.A | Active | Production | SOIC (D) 8 | 75 TUBE | Yes | NIPDAU | Level-1-260C-UNLIM | -40 to 125 | KY5133 |
| LP2951-33DR | Active | Production | SOIC (D) 8 | 2500 LARGE T&R | Yes | NIPDAU | Level-1-260C-UNLIM | -40 to 125 | KY5133 |
| LP2951-33DR.A | Active | Production | SOIC (D) 8 | 2500 LARGE T&R | Yes | NIPDAU | Level-1-260C-UNLIM | -40 to 125 | KY5133 |
| LP2951-33DRG4 | Active | Production | SOIC (D) 8 | 2500 LARGE T&R | Yes | NIPDAU | Level-1-260C-UNLIM | -40 to 125 | KY5133 |
| LP2951-33DRGR | Active | Production | SON (DRG) 8 | 3000 LARGE T&R | Yes | NIPDAU | Level-2-260C-1 YEAR | -40 to 125 | ZUE |
| LP2951-33DRGR.A | Active | Production | SON (DRG) 8 | 3000 LARGE T&R | Yes | NIPDAU | Level-2-260C-1 YEAR | -40 to 125 | ZUE |
| LP2951-50D | Active | Production | SOIC (D) 8 | 75 TUBE | Yes | NIPDAU | Level-1-260C-UNLIM | -40 to 125 | KY5150 |
| LP2951-50D.A | Active | Production | SOIC (D) 8 | 75 TUBE | Yes | NIPDAU | Level-1-260C-UNLIM | -40 to 125 | KY5150 |
| LP2951-50DR | Active | Production | SOIC (D) 8 | 2500 LARGE T&R | Yes | NIPDAU | Level-1-260C-UNLIM | -40 to 125 | KY5150 |
| LP2951-50DR.A | Active | Production | SOIC (D) 8 | 2500 LARGE T&R | Yes | NIPDAU | Level-1-260C-UNLIM | -40 to 125 | KY5150 |
| LP2951-50DRG4 | Active | Production | SOIC (D) 8 | 2500 LARGE T&R | Yes | NIPDAU | Level-1-260C-UNLIM | -40 to 125 | KY5150 |

| Orderable part number | Status (1) | Material type (2) | Package Pins | Package qty Carrier | RoHS (3) | Lead finish/ Ball material (4) | MSL rating/ Peak reflow (5) | Op temp (°C) | Part marking (6) |
|-------------------------------|---------------|----------------------|----------------|-----------------------|-------------|--------------------------------------|-----------------------------------|--------------|---------------------|
| LP2951-50DRGR | Active | Production | SON (DRG) 8 | 3000 LARGE T&R | Yes | NIPDAU | Level-2-260C-1 YEAR | -40 to 125 | ZUF |
| LP2951-50DRGR.A | Active | Production | SON (DRG) 8 | 3000 LARGE T&R | Yes | NIPDAU | Level-2-260C-1 YEAR | -40 to 125 | ZUF |
| LP2951D | Active | Production | SOIC (D) 8 | 75 TUBE | Yes | NIPDAU | Level-1-260C-UNLIM | -40 to 125 | LP2951 |
| LP2951D.A | Active | Production | SOIC (D) 8 | 75 TUBE | Yes | NIPDAU | Level-1-260C-UNLIM | -40 to 125 | LP2951 |
| LP2951DR | Active | Production | SOIC (D) 8 | 2500 LARGE T&R | Yes | NIPDAU | Level-1-260C-UNLIM | -40 to 125 | LP2951 |
| LP2951DR.A | Active | Production | SOIC (D) 8 | 2500 LARGE T&R | Yes | NIPDAU | Level-1-260C-UNLIM | -40 to 125 | LP2951 |
| LP2951DRG4 | Active | Production | SOIC (D) 8 | 2500 LARGE T&R | Yes | NIPDAU | Level-1-260C-UNLIM | -40 to 125 | LP2951 |

(1) **Status:** For more details on status, see our [product life cycle](#).

(2) **Material type:** When designated, preproduction parts are prototypes/experimental devices, and are not yet approved or released for full production. Testing and final process, including without limitation quality assurance, reliability performance testing, and/or process qualification, may not yet be complete, and this item is subject to further changes or possible discontinuation. If available for ordering, purchases will be subject to an additional waiver at checkout, and are intended for early internal evaluation purposes only. These items are sold without warranties of any kind.

(3) **RoHS values:** Yes, No, RoHS Exempt. See the [TI RoHS Statement](#) for additional information and value definition.

(4) **Lead finish/Ball material:** Parts may have multiple material finish options. Finish options are separated by a vertical ruled line. Lead finish/Ball material values may wrap to two lines if the finish value exceeds the maximum column width.

(5) **MSL rating/Peak reflow:** The moisture sensitivity level ratings and peak solder (reflow) temperatures. In the event that a part has multiple moisture sensitivity ratings, only the lowest level per JEDEC standards is shown. Refer to the shipping label for the actual reflow temperature that will be used to mount the part to the printed circuit board.

(6) **Part marking:** There may be an additional marking, which relates to the logo, the lot trace code information, or the environmental category of the part.

Multiple part markings will be inside parentheses. Only one part marking contained in parentheses and separated by a "-" will appear on a part. If a line is indented then it is a continuation of the previous line and the two combined represent the entire part marking for that device.

Important Information and Disclaimer: The information provided on this page represents TI's knowledge and belief as of the date that it is provided. TI bases its knowledge and belief on information provided by third parties, and makes no representation or warranty as to the accuracy of such information. Efforts are underway to better integrate information from third parties. TI has taken and continues to take reasonable steps to provide representative and accurate information but may not have conducted destructive testing or chemical analysis on incoming materials and chemicals. TI and TI suppliers consider certain information to be proprietary, and thus CAS numbers and other limited information may not be available for release.

In no event shall TI's liability arising out of such information exceed the total purchase price of the TI part(s) at issue in this document sold by TI to Customer on an annual basis.

OTHER QUALIFIED VERSIONS OF LP2951 :

- Automotive : [LP2951-Q1](#)

NOTE: Qualified Version Definitions:

- Automotive - Q100 devices qualified for high-reliability automotive applications targeting zero defects

TAPE AND REEL INFORMATION

QUADRANT ASSIGNMENTS FOR PIN 1 ORIENTATION IN TAPE

*All dimensions are nominal

| Device | Package Type | Package Drawing | Pins | SPQ | Reel Diameter (mm) | Reel Width W1 (mm) | A0 (mm) | B0 (mm) | K0 (mm) | P1 (mm) | W (mm) | Pin1 Quadrant |
|---------------|--------------|-----------------|------|------|--------------------|--------------------|---------|---------|---------|---------|--------|---------------|
| LP2951-30DR | SOIC | D | 8 | 2500 | 330.0 | 12.4 | 6.4 | 5.2 | 2.1 | 8.0 | 12.0 | Q1 |
| LP2951-30DRGR | SON | DRG | 8 | 3000 | 330.0 | 12.4 | 3.3 | 3.3 | 1.1 | 8.0 | 12.0 | Q2 |
| LP2951-33DR | SOIC | D | 8 | 2500 | 330.0 | 12.4 | 6.4 | 5.2 | 2.1 | 8.0 | 12.0 | Q1 |
| LP2951-33DRGR | SON | DRG | 8 | 3000 | 330.0 | 12.4 | 3.3 | 3.3 | 1.1 | 8.0 | 12.0 | Q2 |
| LP2951-50DR | SOIC | D | 8 | 2500 | 330.0 | 12.4 | 6.4 | 5.2 | 2.1 | 8.0 | 12.0 | Q1 |
| LP2951-50DR | SOIC | D | 8 | 2500 | 330.0 | 12.4 | 6.4 | 5.2 | 2.1 | 8.0 | 12.0 | Q1 |
| LP2951-50DRGR | SON | DRG | 8 | 3000 | 330.0 | 12.4 | 3.3 | 3.3 | 1.1 | 8.0 | 12.0 | Q2 |
| LP2951DR | SOIC | D | 8 | 2500 | 330.0 | 12.4 | 6.4 | 5.2 | 2.1 | 8.0 | 12.0 | Q1 |
| LP2951DR | SOIC | D | 8 | 2500 | 330.0 | 12.4 | 6.4 | 5.2 | 2.1 | 8.0 | 12.0 | Q1 |

TAPE AND REEL BOX DIMENSIONS

*All dimensions are nominal

| Device | Package Type | Package Drawing | Pins | SPQ | Length (mm) | Width (mm) | Height (mm) |
|---------------|--------------|-----------------|------|------|-------------|------------|-------------|
| LP2951-30DR | SOIC | D | 8 | 2500 | 353.0 | 353.0 | 32.0 |
| LP2951-30DRGR | SON | DRG | 8 | 3000 | 353.0 | 353.0 | 32.0 |
| LP2951-33DR | SOIC | D | 8 | 2500 | 340.5 | 338.1 | 20.6 |
| LP2951-33DRGR | SON | DRG | 8 | 3000 | 353.0 | 353.0 | 32.0 |
| LP2951-50DR | SOIC | D | 8 | 2500 | 353.0 | 353.0 | 32.0 |
| LP2951-50DR | SOIC | D | 8 | 2500 | 340.5 | 338.1 | 20.6 |
| LP2951-50DRGR | SON | DRG | 8 | 3000 | 353.0 | 353.0 | 32.0 |
| LP2951DR | SOIC | D | 8 | 2500 | 353.0 | 353.0 | 32.0 |
| LP2951DR | SOIC | D | 8 | 2500 | 340.5 | 338.1 | 20.6 |

TUBE

*All dimensions are nominal

| Device | Package Name | Package Type | Pins | SPQ | L (mm) | W (mm) | T (μm) | B (mm) |
|--------------|--------------|--------------|------|-----|--------|--------|--------|--------|
| LP2951-30D | D | SOIC | 8 | 75 | 507 | 8 | 3940 | 4.32 |
| LP2951-30D.A | D | SOIC | 8 | 75 | 507 | 8 | 3940 | 4.32 |
| LP2951-33D | D | SOIC | 8 | 75 | 507 | 8 | 3940 | 4.32 |
| LP2951-33D.A | D | SOIC | 8 | 75 | 507 | 8 | 3940 | 4.32 |
| LP2951-50D | D | SOIC | 8 | 75 | 507 | 8 | 3940 | 4.32 |
| LP2951-50D.A | D | SOIC | 8 | 75 | 507 | 8 | 3940 | 4.32 |
| LP2951D | D | SOIC | 8 | 75 | 507 | 8 | 3940 | 4.32 |
| LP2951D.A | D | SOIC | 8 | 75 | 507 | 8 | 3940 | 4.32 |

GENERIC PACKAGE VIEW

DRG 8

WSO - 0.8 mm max height

3 x 3, 0.5 mm pitch

PLASTIC SMALL OUTLINE - NO LEAD

This image is a representation of the package family, actual package may vary.
Refer to the product data sheet for package details.

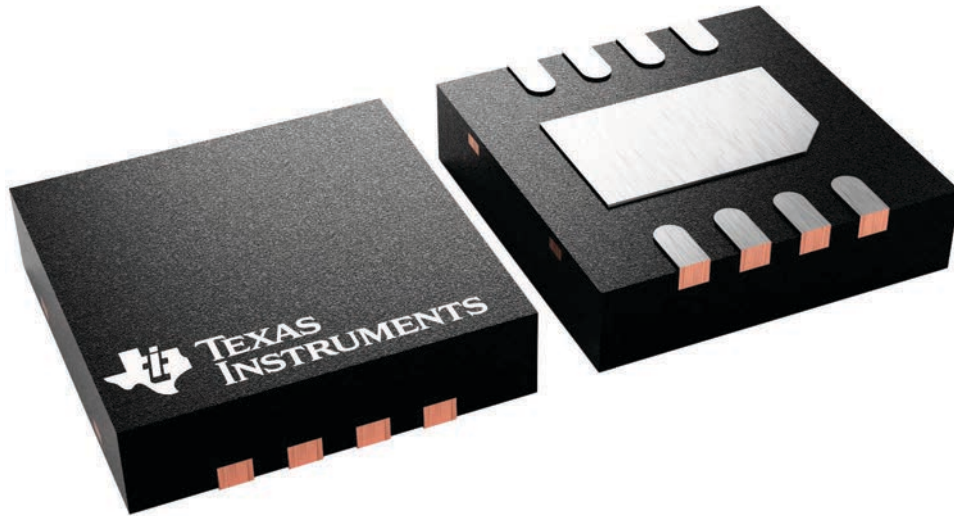

4225794/A

EXAMPLE STENCIL DESIGN

DRG0008A

WSON - 0.8 mm max height

PLASTIC SMALL OUTLINE - NO LEAD

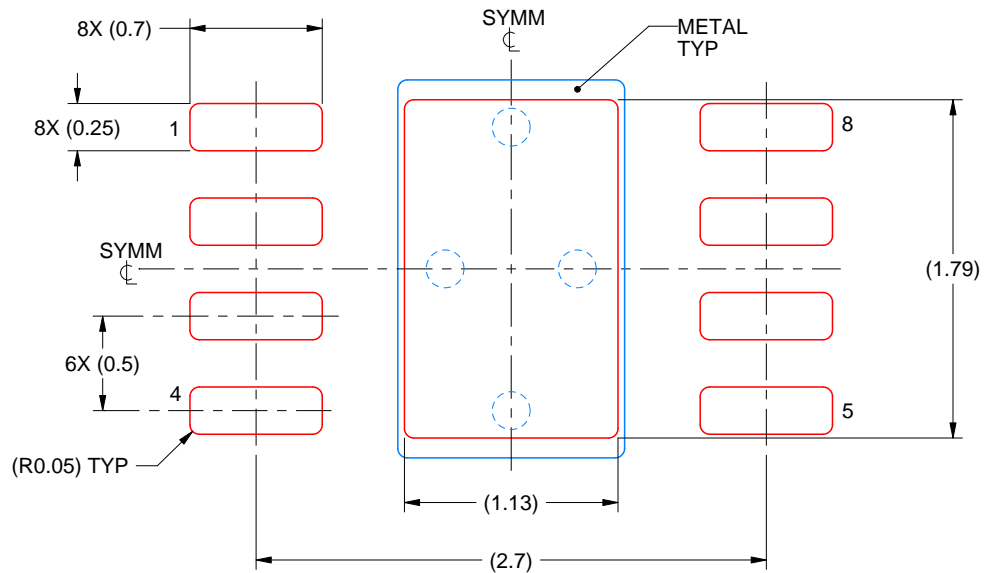

SOLDER PASTE EXAMPLE
BASED ON 0.125 mm THICK STENCIL
EXPOSED PAD
84% PRINTED SOLDER COVERAGE BY AREA
SCALE:25X

4218885/A 03/2020

NOTES: (continued)

6. Laser cutting apertures with trapezoidal walls and rounded corners may offer better paste release. IPC-7525 may have alternate design recommendations.



D0008A

PACKAGE OUTLINE

SOIC - 1.75 mm max height

SMALL OUTLINE INTEGRATED CIRCUIT



4214825/C 02/2019

NOTES:

- Linear dimensions are in inches [millimeters]. Dimensions in parenthesis are for reference only. Controlling dimensions are in inches. Dimensioning and tolerancing per ASME Y14.5M.
- This drawing is subject to change without notice.
- This dimension does not include mold flash, protrusions, or gate burrs. Mold flash, protrusions, or gate burrs shall not exceed .006 [0.15] per side.
- This dimension does not include interlead flash.
- Reference JEDEC registration MS-012, variation AA.

EXAMPLE BOARD LAYOUT

D0008A

SOIC - 1.75 mm max height

SMALL OUTLINE INTEGRATED CIRCUIT

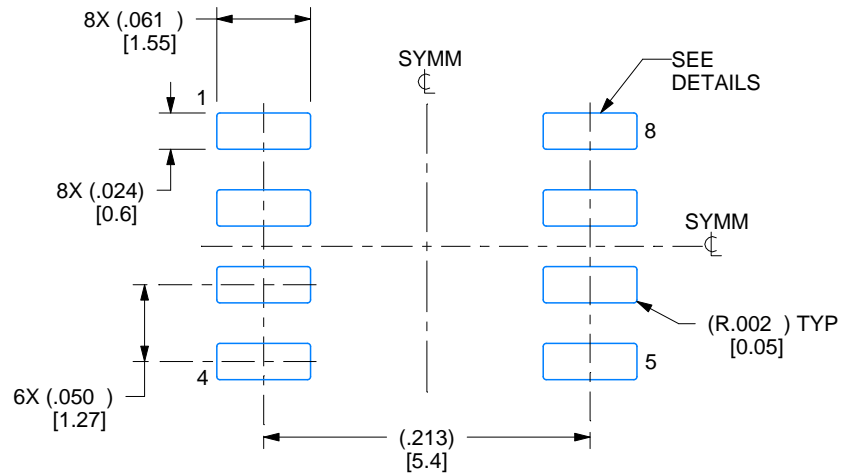

LAND PATTERN EXAMPLE
EXPOSED METAL SHOWN
SCALE:8X

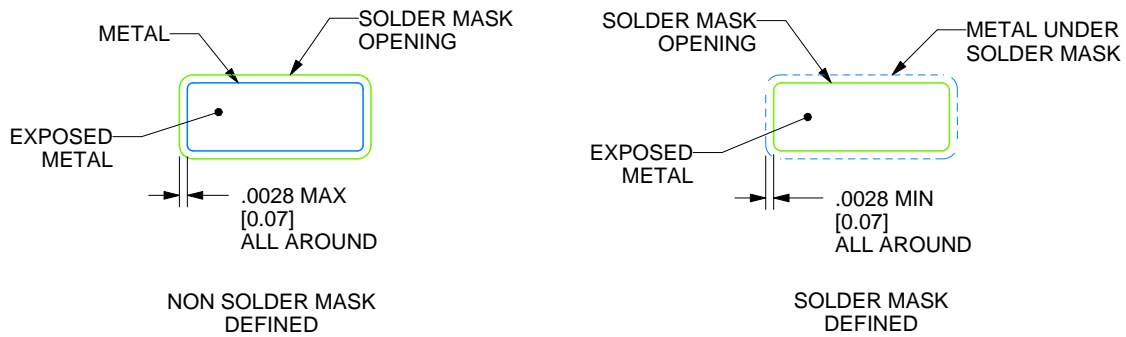

SOLDER MASK DETAILS

4214825/C 02/2019

NOTES: (continued)

6. Publication IPC-7351 may have alternate designs.

7. Solder mask tolerances between and around signal pads can vary based on board fabrication site.

EXAMPLE STENCIL DESIGN

D0008A

SOIC - 1.75 mm max height

SMALL OUTLINE INTEGRATED CIRCUIT



SOLDER PASTE EXAMPLE
BASED ON .005 INCH [0.125 MM] THICK STENCIL
SCALE:8X

4214825/C 02/2019

NOTES: (continued)

8. Laser cutting apertures with trapezoidal walls and rounded corners may offer better paste release. IPC-7525 may have alternate design recommendations.
9. Board assembly site may have different recommendations for stencil design.

LP0003A



PACKAGE OUTLINE

TO-92 - 5.34 mm max height

TO-92

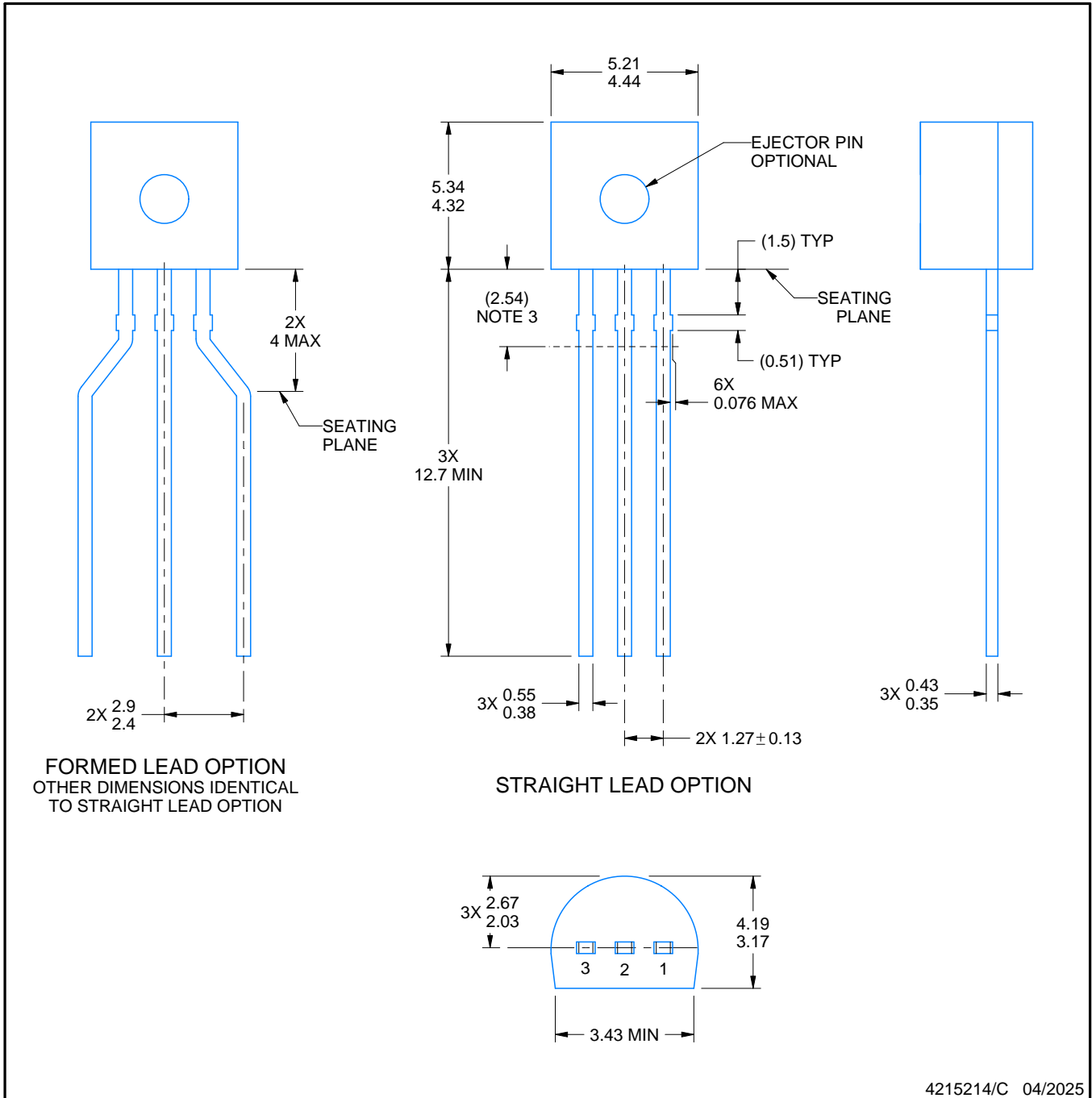

4215214/C 04/2025

NOTES:

1. All linear dimensions are in millimeters. Any dimensions in parenthesis are for reference only. Dimensioning and tolerancing per ASME Y14.5M.
2. This drawing is subject to change without notice.
3. Lead dimensions are not controlled within this area.
4. Reference JEDEC TO-226, variation AA.
5. Shipping method:
 - a. Straight lead option available in bulk pack only.
 - b. Formed lead option available in tape and reel or ammo pack.
 - c. Specific products can be offered in limited combinations of shipping medium and lead options.
 - d. Consult product folder for more information on available options.

EXAMPLE BOARD LAYOUT

LP0003A

TO-92 - 5.34 mm max height

TO-92

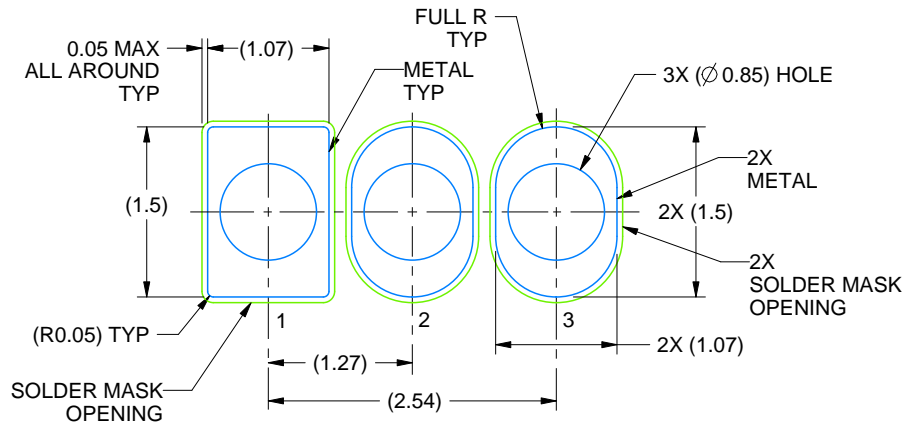

LAND PATTERN EXAMPLE
STRAIGHT LEAD OPTION
NON-SOLDER MASK DEFINED
SCALE:15X

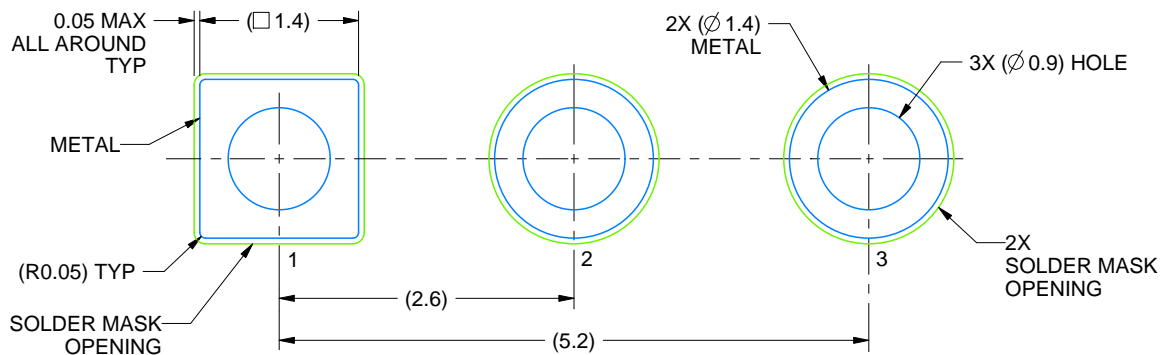

LAND PATTERN EXAMPLE
FORMED LEAD OPTION
NON-SOLDER MASK DEFINED
SCALE:15X

4215214/C 04/2025

TAPE SPECIFICATIONS

LP0003A

TO-92 - 5.34 mm max height

TO-92

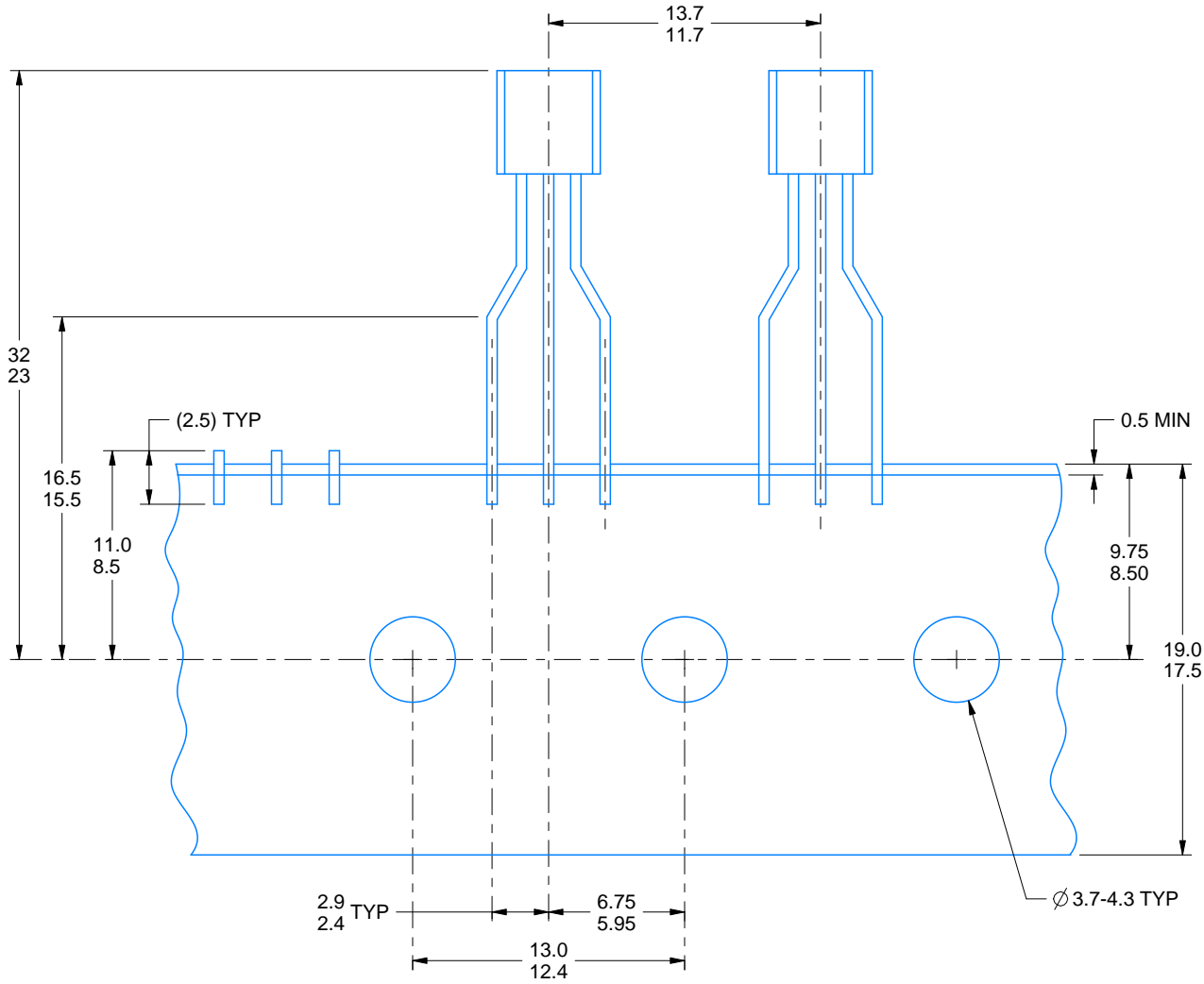

FOR FORMED LEAD OPTION PACKAGE

4215214/C 04/2025

IMPORTANT NOTICE AND DISCLAIMER

TI PROVIDES TECHNICAL AND RELIABILITY DATA (INCLUDING DATASHEETS), DESIGN RESOURCES (INCLUDING REFERENCE DESIGNS), APPLICATION OR OTHER DESIGN ADVICE, WEB TOOLS, SAFETY INFORMATION, AND OTHER RESOURCES "AS IS" AND WITH ALL FAULTS, AND DISCLAIMS ALL WARRANTIES, EXPRESS AND IMPLIED, INCLUDING WITHOUT LIMITATION ANY IMPLIED WARRANTIES OF MERCHANTABILITY, FITNESS FOR A PARTICULAR PURPOSE OR NON-INFRINGEMENT OF THIRD PARTY INTELLECTUAL PROPERTY RIGHTS.

These resources are intended for skilled developers designing with TI products. You are solely responsible for (1) selecting the appropriate TI products for your application, (2) designing, validating and testing your application, and (3) ensuring your application meets applicable standards, and any other safety, security, regulatory or other requirements.

These resources are subject to change without notice. TI grants you permission to use these resources only for development of an application that uses the TI products described in the resource. Other reproduction and display of these resources is prohibited. No license is granted to any other TI intellectual property right or to any third party intellectual property right. TI disclaims responsibility for, and you fully indemnify TI and its representatives against any claims, damages, costs, losses, and liabilities arising out of your use of these resources.

TI's products are provided subject to [TI's Terms of Sale](#), [TI's General Quality Guidelines](#), or other applicable terms available either on ti.com or provided in conjunction with such TI products. TI's provision of these resources does not expand or otherwise alter TI's applicable warranties or warranty disclaimers for TI products. Unless TI explicitly designates a product as custom or customer-specified, TI products are standard, catalog, general purpose devices.

TI objects to and rejects any additional or different terms you may propose.

Copyright © 2026, Texas Instruments Incorporated

Last updated 10/2025