

## TPS2291xx, 5.5V, 2A, 37mΩ On-Resistance Load Switch

### 1 Features

- Integrated Single Channel Load Switch
- Input Voltage Range: 1.05V to 5.5V
- Low On-Resistance ( $R_{ON}$ )
  - $R_{ON} = 37m\Omega$  (Typical) at  $V_{IN} = 5V$
  - $R_{ON} = 38m\Omega$  (Typical) at  $V_{IN} = 3.3V$
  - $R_{ON} = 43m\Omega$  (Typical) at  $V_{IN} = 1.8V$
- 2A Maximum Continuous Switch Current
- Low Quiescent Current
  - $7.7\mu A$  (Typical) at  $V_{IN} = 3.3V$
- Low Control Input Threshold Enables Use of 1V or Higher GPIO
- Controlled Slew Rate
  - $t_R(TPS22914B/15B) = 64\mu s$  at  $V_{IN} = 3.3V$
  - $t_R(TPS22914C/15C) = 913\mu s$  at  $V_{IN} = 3.3V$
- Quick Output Discharge (TPS22915 only)
- Ultra-Small Wafer-Chip-Scale Package
  - 0.74mm × 0.74mm, 0.4mm Pitch, 0.5mm Height (YFP)
- ESD Performance Tested per JESD 22
  - 2kV HBM and 1kV CDM

### 2 Applications

- [Smartphones, Mobile Phones](#)
- [Ultrathin, Ultrabook™ / Notebook PC](#)
- [Tablet PC](#)
- [Wearable Technology](#)
- [Solid State Drives](#)
- [Digital Cameras](#)

### 3 Description

The TPS22914/15 is a small, low  $R_{ON}$ , single channel load switch with controlled slew rate. The device contains an N-channel MOSFET that can operate over an input voltage range of 1.05V to 5.5V and can support a maximum continuous current of 2A. The switch is controlled by an on and off input, which is capable of interfacing directly with low-voltage control signals.

The small size and low  $R_{ON}$  makes the device designed for being use in space-constrained, battery-powered applications. The wide input voltage range of the switch makes the device a versatile design for many different voltage rails. The controlled rise time of the device greatly reduces inrush current caused by large bulk load capacitances, thereby reducing or eliminating power supply droop. The TPS22915 further reduces the total solution size by integrating a 143Ω pulldown resistor for quick output discharge (QOD) when the switch is turned off.

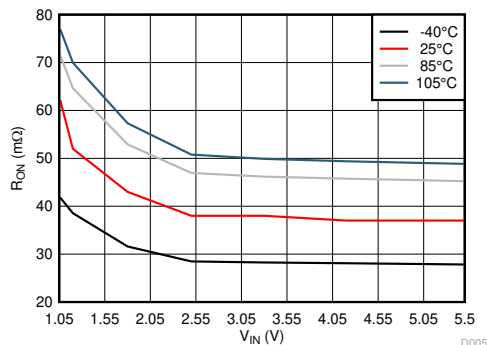
The TPS22914/15 is available in a small, space-saving 0.74mm × 0.74mm, 0.4mm pitch, 0.5mm height 4-pin Wafer-Chip-Scale (WCSP) package (YFP). The device is characterized for operation over the free-air temperature range of  $-40^{\circ}C$  to  $+105^{\circ}C$ .

#### Package Information

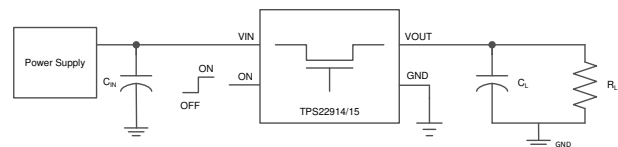
| PART NUMBER | PACKAGE <sup>(1)</sup> | PACKAGE SIZE <sup>(2)</sup> |
|-------------|------------------------|-----------------------------|
| TPS22914B   | DSBGA (4)              | 0.74mm × 0.74mm             |
| TPS22914C   |                        |                             |
| TPS22915B   |                        |                             |
| TPS22915C   |                        |                             |

(1) For more information, see [Section 12](#).

(2) The package size (length × width) is a nominal value and includes pins, where applicable.



$R_{ON}$  vs  $V_{IN}$  ( $I_{OUT} = -200mA$ )



Simplified Schematic



## Table of Contents

|   |    |  |    |
|---|----|--|----|
| <b>1 Features</b> .....                             | 1  | 8.3 Feature Description.....   | 16 |
| <b>2 Applications</b> .....                         | 1  | 8.4 Device Functional Modes.....                                     | 17 |
| <b>3 Description</b> .....                          | 1  | <b>9 Application and Implementation</b> .....                        | 18 |
| <b>4 Device Comparison Table</b> .....              | 3  | 9.1 Application Information.....                                     | 18 |
| <b>5 Pin Configuration and Functions</b> .....      | 3  | 9.2 Typical Application.....   | 18 |
| <b>6 Specifications</b> .....                       | 4  | 9.3 Power Supply Recommendations.....                                | 20 |
| 6.1 Absolute Maximum Ratings.....                   | 4  | 9.4 Layout.....  | 20 |
| 6.2 ESD Ratings.....                                | 4  | <b>10 Device and Documentation Support</b> .....                     | 22 |
| 6.3 Recommended Operating Conditions.....           | 4  | 10.1 Documentation Support.....                                      | 22 |
| 6.4 Thermal Information.....                        | 4  | 10.2 Related Links.....  | 22 |
| 6.5 Electrical Characteristics.....                 | 5  | 10.3 Receiving Notification of Documentation Updates..               | 22 |
| 6.6 Switching Characteristics.....                  | 8  | 10.4 Support Resources.....  | 22 |
| 6.7 Typical DC Characteristics.....                 | 9  | 10.5 Trademarks.....   | 22 |
| 6.8 Typical AC Characteristics (TPS22914B/15B)..... | 11 | 10.6 Electrostatic Discharge Caution.....                            | 22 |
| 6.9 Typical AC Characteristics (TPS22914C/15C)..... | 13 | 10.7 Glossary.....   | 22 |
| <b>7 Parameter Measurement Information</b> .....    | 15 | <b>11 Revision History</b> .....                                     | 22 |
| <b>8 Detailed Description</b> .....                 | 16 | <b>12 Mechanical, Packaging, and Orderable<br/>Information</b> ..... | 23 |
| 8.1 Overview.....                                   | 16 |  |    |
| 8.2 Functional Block Diagram.....                   | 16 |  |    |

## 4 Device Comparison Table

| DEVICE    | R <sub>ON</sub> at 3.3V (TYPICAL) | t <sub>R</sub> at 3.3V (TYPICAL) | QUICK OUTPUT DISCHARGE | MAXIMUM OUTPUT CURRENT | ENABLE      |
|-----------|-----------------------------------|----------------------------------|------------------------|------------------------|-------------|
| TPS22914B | 38mΩ                              | 64μs                             | No                     | 2A                     | Active High |
| TPS22914C | 38mΩ                              | 913μs                            | No                     | 2A                     | Active High |
| TPS22915B | 38mΩ                              | 64μs                             | Yes                    | 2A                     | Active High |
| TPS22915C | 38mΩ                              | 913μs                            | Yes                    | 2A                     | Active High |

## 5 Pin Configuration and Functions

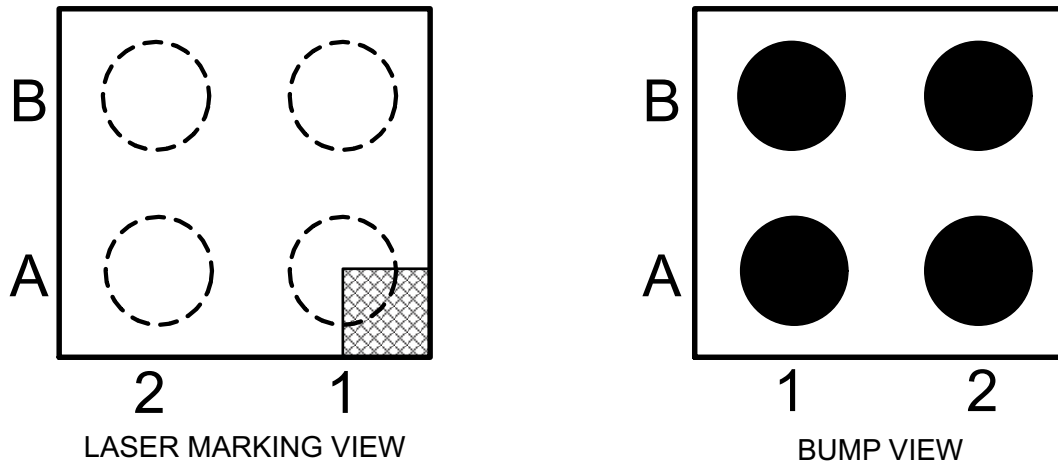


Figure 5-1. YFP PACKAGE 4 PIN DSBGA TOP VIEW

Table 5-1. Pin Description

|   |     |      |
|---|-----|------|
| B | ON  | GND  |
| A | VIN | VOUT |
|   | 2   | 1    |

Table 5-2. Pin Functions

| PIN |      | TYPE <sup>(1)</sup> | DESCRIPTION  |
|-----|------|---------------------|--|
| NO. | NAME |                     |  |
| A1  | VOUT | O                   | Switch output. Place ceramic bypass capacitors between this pin and GND. See the <a href="#">Detailed Description</a> section for more information |
| A2  | VIN  | I                   | Switch input. Place ceramic bypass capacitors between this pin and GND. See the <a href="#">Detailed Description</a> section for more information  |
| B1  | GND  | —                   | Device ground  |
| B2  | ON   | I                   | Active high switch control input. Do not leave floating  |

(1) I = Input; O = Output.

## 6 Specifications

### 6.1 Absolute Maximum Ratings

Over operating free-air temperature range (unless otherwise noted)<sup>(1) (2)</sup>

|                  |   | MIN  | MAX | UNIT |
|------------------|---|------|-----|------|
| V <sub>IN</sub>  | Input voltage   | -0.3 | 6   | V    |
| V <sub>OUT</sub> | Output voltage  | -0.3 | 6   | V    |
| V <sub>ON</sub>  | ON voltage  | -0.3 | 6   | V    |
| I <sub>MAX</sub> | Maximum continuous switch current                           |      | 2   | A    |
| I <sub>PLS</sub> | Maximum pulsed switch current, pulse < 300µs, 2% duty cycle |      | 2.5 | A    |
| T <sub>J</sub>   | Maximum junction temperature                                |      | 125 | °C   |
| T <sub>STG</sub> | Storage temperature   | -65  | 150 | °C   |

- (1) Operation outside the *Absolute Maximum Ratings* may cause permanent device damage. *Absolute Maximum Ratings* do not imply functional operation of the device at these or any other conditions beyond those listed under *Recommended Operating Conditions*. If used outside the *Recommended Operating Conditions* but within the *Absolute Maximum Ratings*, the device may not be fully functional, and this may affect device reliability, functionality, performance, and shorten the device lifetime.
- (2) All voltage values are with respect to network ground terminal.

### 6.2 ESD Ratings

|                    |                         |  | VALUE | UNIT |
|--------------------|-------------------------|--|-------|------|
| V <sub>(ESD)</sub> | Electrostatic discharge | Human-body model (HBM), per ANSI/ESDA/JEDEC JS-001 <sup>(1)</sup>              | ±2000 | V    |
|                    |                         | Charged-device model (CDM), per JEDEC specification JESD22-C101 <sup>(2)</sup> | ±1000 |      |

- (1) JEDEC document JEP155 states that 500V HBM allows safe manufacturing with a standard ESD control process.
- (2) JEDEC document JEP157 states that 250V CDM allows safe manufacturing with a standard ESD control process.

### 6.3 Recommended Operating Conditions

Over operating free-air temperature range (unless otherwise noted)

|                     |   |                                 | MIN              | MAX             | UNIT |
|---------------------|---|---------------------------------|------------------|-----------------|------|
| V <sub>IN</sub>     | Input voltage                                       |                                 | 1.05             | 5.5             | V    |
| V <sub>ON</sub>     | ON voltage  |                                 | 0                | 5.5             | V    |
| V <sub>OUT</sub>    | Output voltage                                      |                                 |                  | V <sub>IN</sub> | V    |
| V <sub>IH, ON</sub> | High-level input voltage, ON                        | V <sub>IN</sub> = 1.05V to 5.5V | 1                | 5.5             | V    |
| V <sub>IL, ON</sub> | Low-level input voltage, ON                         | V <sub>IN</sub> = 1.05V to 5.5V | 0                | 0.5             | V    |
| T <sub>A</sub>      | Operating free-air temperature range <sup>(1)</sup> |                                 | -40              | 105             | °C   |
| C <sub>IN</sub>     | Input Capacitor                                     |                                 | 1 <sup>(2)</sup> |                 | µF   |

- (1) In applications where high power dissipation or poor package thermal resistance is present, the maximum ambient temperature may have to be derated. Maximum ambient temperature [T<sub>A(max)</sub>] is dependent on the maximum operating junction temperature [T<sub>J(max)</sub>], the maximum power dissipation of the device in the application [P<sub>D(max)</sub>], and the junction-to-ambient thermal resistance of the part/package in the application (θ<sub>JA</sub>), as given by the following equation: T<sub>A(max)</sub> = T<sub>J(max)</sub> - (θ<sub>JA</sub> × P<sub>D(max)</sub>).
- (2) Refer to the [Detailed Description](#) section.

### 6.4 Thermal Information

| THERMAL METRIC <sup>(1)</sup> |  | TPS2291x    | UNIT |
|-------------------------------|--|-------------|------|
|                               |  | YFP (DSBGA) |      |
|                               |  | 4 PINS      |      |
| R <sub>θJA</sub>              | Junction-to-ambient thermal resistance     | 193         | °C/W |
| R <sub>θJC(top)</sub>         | Junction-to-case (top) thermal resistance  | 2.3         | °C/W |
| R <sub>θJB</sub>              | Junction-to-board thermal resistance       | 36          | °C/W |
| ψ <sub>JT</sub>               | Junction-to-top characterization parameter | 12          | °C/W |

## 6.4 Thermal Information (continued)

| THERMAL METRIC <sup>(1)</sup> |  | TPS2291x    | UNIT |
|-------------------------------|--|-------------|------|
|                               |  | YFP (DSBGA) |      |
|                               |  | 4 PINS      |      |
| $\Psi_{JB}$                   | Junction-to-board characterization parameter | 36          | °C/W |

(1) For more information about traditional and new thermal metrics, see the [Semiconductor and IC Package Thermal Metrics](#) application note.

## 6.5 Electrical Characteristics

Unless otherwise noted, the specification in the following table applies over the operating ambient temperature  $-40^{\circ}\text{C} \leq T_A \leq +105^{\circ}\text{C}$ . **Typical values are for  $T_A = 25^{\circ}\text{C}$ .**

| PARAMETER        |  | TEST CONDITION              |   | $T_A$  | MIN  | TYP  | MAX           | UNIT |
|------------------|--|-----------------------------|---|--|------|------|---------------|------|
| $I_{Q, VIN}$     | Quiescent current (TPS22914B/15B)              | $V_{ON} = 5V, I_{OUT} = 0A$ | $V_{IN} = 5.5V$                               | $-40^{\circ}\text{C to } +85^{\circ}\text{C}$  | 7.7  | 10.8 | $\mu\text{A}$ |      |
|                  |  |                             |   | $-40^{\circ}\text{C to } +105^{\circ}\text{C}$ |      | 12.1 |               |      |
|                  |  |                             | $V_{IN} = 5V$                                 | $-40^{\circ}\text{C to } +85^{\circ}\text{C}$  | 7.6  | 9.6  |               |      |
|                  |  |                             |   | $-40^{\circ}\text{C to } +105^{\circ}\text{C}$ |      | 11.9 |               |      |
|                  |  |                             | $V_{IN} = 3.3V$                               | $-40^{\circ}\text{C to } +85^{\circ}\text{C}$  | 7.7  | 9.6  |               |      |
|                  |  |                             |   | $-40^{\circ}\text{C to } +105^{\circ}\text{C}$ |      | 12   |               |      |
|                  |  |                             | $V_{IN} = 1.8V$                               | $-40^{\circ}\text{C to } +85^{\circ}\text{C}$  | 8.4  | 11   |               |      |
|                  | $-40^{\circ}\text{C to } +105^{\circ}\text{C}$ |                             |   | 13.5   |      |      |               |      |
|                  | Quiescent current (TPS22914C/15C)              | $V_{ON} = 5V, I_{OUT} = 0A$ | $V_{IN} = 5.5V$                               | $-40^{\circ}\text{C to } +85^{\circ}\text{C}$  | 7.7  | 11.5 |               |      |
|                  |  |                             |   | $-40^{\circ}\text{C to } +105^{\circ}\text{C}$ |      | 14.1 |               |      |
|                  |  |                             | $V_{IN} = 5V$                                 | $-40^{\circ}\text{C to } +85^{\circ}\text{C}$  | 7.6  | 11.1 |               |      |
|                  |  |                             |   | $-40^{\circ}\text{C to } +105^{\circ}\text{C}$ |      | 13.7 |               |      |
|                  |  |                             | $V_{IN} = 3.3V$                               | $-40^{\circ}\text{C to } +85^{\circ}\text{C}$  | 7.7  | 10.7 |               |      |
|                  |  |                             |   | $-40^{\circ}\text{C to } +105^{\circ}\text{C}$ |      | 13.3 |               |      |
| $V_{IN} = 1.8V$  |  |                             | $-40^{\circ}\text{C to } +85^{\circ}\text{C}$ | 8.4  | 11.7 |      |               |      |
|                  | $-40^{\circ}\text{C to } +105^{\circ}\text{C}$ |                             | 13.4  |  |      |      |               |      |
| $V_{IN} = 1.2V$  | $-40^{\circ}\text{C to } +85^{\circ}\text{C}$  | 7.4                         | 11  |  |      |      |               |      |
|                  | $-40^{\circ}\text{C to } +105^{\circ}\text{C}$ |                             | 12.8  |  |      |      |               |      |
| $V_{IN} = 1.05V$ | $-40^{\circ}\text{C to } +85^{\circ}\text{C}$  | 6.7                         | 10.9  |  |      |      |               |      |
|                  | $-40^{\circ}\text{C to } +105^{\circ}\text{C}$ |                             | 10.9  |  |      |      |               |      |

## 6.5 Electrical Characteristics (continued)

Unless otherwise noted, the specification in the following table applies over the operating ambient temperature  $-40^{\circ}\text{C} \leq T_A \leq +105^{\circ}\text{C}$ . Typical values are for  $T_A = 25^{\circ}\text{C}$ .

| PARAMETER                                       | TEST CONDITION                                  | $T_A$                                 | MIN   | TYP   | MAX              | UNIT          |    |                  |               |
|---|---|---------------------------------------|---|---|------------------|---------------|----|------------------|---------------|
| $I_{SD, VIN}$ Shutdown current                  | $V_{ON} = 0V, V_{OUT} = 0V$                     | $V_{IN} = 5.5V$                       | $-40^{\circ}\text{C}$ to $+85^{\circ}\text{C}$  | 0.5   | 2                | $\mu\text{A}$ |    |                  |               |
|   |   |                                       | $-40^{\circ}\text{C}$ to $+105^{\circ}\text{C}$ |   | 3                |               |    |                  |               |
|   |   | $V_{IN} = 5.0V$                       | $-40^{\circ}\text{C}$ to $+85^{\circ}\text{C}$  | 0.5   | 2                |               |    |                  |               |
|   |   |                                       | $-40^{\circ}\text{C}$ to $+105^{\circ}\text{C}$ |   | 3                |               |    |                  |               |
|   |   | $V_{IN} = 3.3V$                       | $-40^{\circ}\text{C}$ to $+85^{\circ}\text{C}$  | 0.5   | 2                |               |    |                  |               |
|   |   |                                       | $-40^{\circ}\text{C}$ to $+105^{\circ}\text{C}$ |   | 3                |               |    |                  |               |
|   |   | $V_{IN} = 1.8V$                       | $-40^{\circ}\text{C}$ to $+85^{\circ}\text{C}$  | 0.5   | 2                |               |    |                  |               |
|   |   |                                       | $-40^{\circ}\text{C}$ to $+105^{\circ}\text{C}$ |   | 3                |               |    |                  |               |
|   |   | $V_{IN} = 1.2V$                       | $-40^{\circ}\text{C}$ to $+85^{\circ}\text{C}$  | 0.4   | 2                |               |    |                  |               |
|   |   |                                       | $-40^{\circ}\text{C}$ to $+105^{\circ}\text{C}$ |   | 3                |               |    |                  |               |
|   |   | $V_{IN} = 1.05V$                      | $-40^{\circ}\text{C}$ to $+85^{\circ}\text{C}$  | 0.4   | 2                |               |    |                  |               |
|   |   |                                       | $-40^{\circ}\text{C}$ to $+105^{\circ}\text{C}$ |   | 3                |               |    |                  |               |
|   |   | $I_{ON}$ ON pin input leakage current | $V_{IN} = 5.5V, I_{OUT} = 0A$                   | $-40^{\circ}\text{C}$ to $+105^{\circ}\text{C}$ |                  |               |    | 0.1              | $\mu\text{A}$ |
|   |   | $R_{ON}$ On-resistance                | $V_{IN} = 5.5V, I_{OUT} = -200\text{mA}$        | $25^{\circ}\text{C}$                            | 37               |               | 40 | $\text{m}\Omega$ |               |
| $-40^{\circ}\text{C}$ to $+85^{\circ}\text{C}$  |   |                                       |   | 51  |                  |               |    |                  |               |
| $-40^{\circ}\text{C}$ to $+105^{\circ}\text{C}$ |   |                                       |   | 57  |                  |               |    |                  |               |
| $V_{IN} = 5V, I_{OUT} = -200\text{mA}$          | $25^{\circ}\text{C}$                            |                                       | 37  | 41  | $\text{m}\Omega$ |               |    |                  |               |
|   | $-40^{\circ}\text{C}$ to $+85^{\circ}\text{C}$  |                                       |   | 51  |                  |               |    |                  |               |
|   | $-40^{\circ}\text{C}$ to $+105^{\circ}\text{C}$ |                                       |   | 57  |                  |               |    |                  |               |
| $V_{IN} = 4.2V, I_{OUT} = -200\text{mA}$        | $25^{\circ}\text{C}$                            |                                       | 37  | 41  | $\text{m}\Omega$ |               |    |                  |               |
|   | $-40^{\circ}\text{C}$ to $+85^{\circ}\text{C}$  |                                       |   | 52  |                  |               |    |                  |               |
|   | $-40^{\circ}\text{C}$ to $+105^{\circ}\text{C}$ |                                       |   | 58  |                  |               |    |                  |               |
| $V_{IN} = 3.3V, I_{OUT} = -200\text{mA}$        | $25^{\circ}\text{C}$                            |                                       | 38  | 41  | $\text{m}\Omega$ |               |    |                  |               |
|   | $-40^{\circ}\text{C}$ to $+85^{\circ}\text{C}$  |                                       |   | 52  |                  |               |    |                  |               |
|   | $-40^{\circ}\text{C}$ to $+105^{\circ}\text{C}$ |                                       |   | 59  |                  |               |    |                  |               |
| $V_{IN} = 2.5V, I_{OUT} = -200\text{mA}$        | $25^{\circ}\text{C}$                            |                                       | 38  | 42  | $\text{m}\Omega$ |               |    |                  |               |
|   | $-40^{\circ}\text{C}$ to $+85^{\circ}\text{C}$  |                                       |   | 53  |                  |               |    |                  |               |
|   | $-40^{\circ}\text{C}$ to $+105^{\circ}\text{C}$ |                                       |   | 58  |                  |               |    |                  |               |
| $V_{IN} = 1.8V, I_{OUT} = -200\text{mA}$        | $25^{\circ}\text{C}$                            |                                       | 43  | 48  | $\text{m}\Omega$ |               |    |                  |               |
|   | $-40^{\circ}\text{C}$ to $+85^{\circ}\text{C}$  |                                       |   | 59  |                  |               |    |                  |               |
|   | $-40^{\circ}\text{C}$ to $+105^{\circ}\text{C}$ |                                       |   | 66  |                  |               |    |                  |               |
| $V_{IN} = 1.2V, I_{OUT} = -200\text{mA}$        | $25^{\circ}\text{C}$                            |                                       | 52  | 61  | $\text{m}\Omega$ |               |    |                  |               |
|   | $-40^{\circ}\text{C}$ to $+85^{\circ}\text{C}$  |                                       |   | 73  |                  |               |    |                  |               |
|   | $-40^{\circ}\text{C}$ to $+105^{\circ}\text{C}$ |                                       |   | 85  |                  |               |    |                  |               |
| $V_{IN} = 1.05V, I_{OUT} = -200\text{mA}$       | $25^{\circ}\text{C}$                            |                                       | 63  | 96  | $\text{m}\Omega$ |               |    |                  |               |
|   | $-40^{\circ}\text{C}$ to $+85^{\circ}\text{C}$  |                                       |   | 102   |                  |               |    |                  |               |
|   | $-40^{\circ}\text{C}$ to $+105^{\circ}\text{C}$ |                                       |   | 107   |                  |               |    |                  |               |

## 6.5 Electrical Characteristics (continued)

Unless otherwise noted, the specification in the following table applies over the operating ambient temperature  $-40^{\circ}\text{C} \leq T_A \leq +105^{\circ}\text{C}$ . **Typical values are for  $T_A = 25^{\circ}\text{C}$ .**

| PARAMETER  | TEST CONDITION  | $T_A$   | MIN | TYP | MAX | UNIT     |
|--|---|---|-----|-----|-----|----------|
| $V_{\text{HYS}}$ ON pin hysteresis                       | $V_{\text{IN}} = 5.5\text{V}$   | 25°C  |     | 102 |     | mV       |
|  | $V_{\text{IN}} = 5\text{V}$   |   |     | 100 |     |          |
|  | $V_{\text{IN}} = 3.3\text{V}$   |   |     | 98  |     |          |
|  | $V_{\text{IN}} = 2.5\text{V}$   |   |     | 96  |     |          |
|  | $V_{\text{IN}} = 1.8\text{V}$   |   |     | 96  |     |          |
|  | $V_{\text{IN}} = 1.2\text{V}$   |   |     | 94  |     |          |
|  | $V_{\text{IN}} = 1.05\text{V}$  |   |     | 92  |     |          |
| $R_{\text{PD}}$ <sup>(1)</sup> Output pull down resistor | $V_{\text{IN}} = V_{\text{OUT}} = 3.3\text{V}, V_{\text{ON}} = 0\text{V}$ | $-40^{\circ}\text{C}$ to $+105^{\circ}\text{C}$ | 143 | 200 |     | $\Omega$ |

(1) TPS22915B/C only.

## 6.6 Switching Characteristics

Refer to the timing test circuit in [Figure 7-1](#) (unless otherwise noted) for references to external components used for the test condition in the switching characteristics table. Switching characteristics shown below are only valid for the power-up sequence where VIN is already in steady state condition before the ON pin is asserted high.

| PARAMETER   |                            | TEST CONDITION  | TYP<br>(TPS22914B/15B) | TYP<br>(TPS22914C/15C) | UNIT |
|---|----------------------------|---|------------------------|------------------------|------|
| <b>V<sub>IN</sub> = 5V, V<sub>ON</sub> = 5V, T<sub>A</sub> = 25°C (unless otherwise noted)</b>    |                            |   |                        |                        |      |
| t <sub>ON</sub>   | Turnon time                | R <sub>L</sub> = 10Ω, C <sub>IN</sub> = 1μF, C <sub>OUT</sub> = 0.1μF | 104                    | 1300                   | μs   |
| t <sub>OFF</sub>  | Turnoff time               | R <sub>L</sub> = 10Ω, C <sub>IN</sub> = 1μF, C <sub>OUT</sub> = 0.1μF | 2                      | 2                      | μs   |
| t <sub>R</sub>  | V <sub>OUT</sub> rise time | R <sub>L</sub> = 10Ω, C <sub>IN</sub> = 1μF, C <sub>OUT</sub> = 0.1μF | 89                     | 1277                   | μs   |
| t <sub>F</sub>  | V <sub>OUT</sub> fall time | R <sub>L</sub> = 10Ω, C <sub>IN</sub> = 1μF, C <sub>OUT</sub> = 0.1μF | 2                      | 2                      | μs   |
| t <sub>D</sub>  | Delay time                 | R <sub>L</sub> = 10Ω, C <sub>IN</sub> = 1μF, C <sub>OUT</sub> = 0.1μF | 59                     | 663                    | μs   |
| <b>V<sub>IN</sub> = 3.3V, V<sub>ON</sub> = 5V, T<sub>A</sub> = 25°C (unless otherwise noted)</b>  |                            |   |                        |                        |      |
| t <sub>ON</sub>   | Turnon time                | R <sub>L</sub> = 10Ω, C <sub>IN</sub> = 1μF, C <sub>OUT</sub> = 0.1μF | 83                     | 1077                   | μs   |
| t <sub>OFF</sub>  | Turnoff time               | R <sub>L</sub> = 10Ω, C <sub>IN</sub> = 1μF, C <sub>OUT</sub> = 0.1μF | 2                      | 2                      | μs   |
| t <sub>R</sub>  | V <sub>OUT</sub> rise time | R <sub>L</sub> = 10Ω, C <sub>IN</sub> = 1μF, C <sub>OUT</sub> = 0.1μF | 64                     | 913                    | μs   |
| t <sub>F</sub>  | V <sub>OUT</sub> fall time | R <sub>L</sub> = 10Ω, C <sub>IN</sub> = 1μF, C <sub>OUT</sub> = 0.1μF | 2                      | 2                      | μs   |
| t <sub>D</sub>  | Delay time                 | R <sub>L</sub> = 10Ω, C <sub>IN</sub> = 1μF, C <sub>OUT</sub> = 0.1μF | 52                     | 622                    | μs   |
| <b>V<sub>IN</sub> = 1.05V, V<sub>ON</sub> = 5V, T<sub>A</sub> = 25°C (unless otherwise noted)</b> |                            |   |                        |                        |      |
| t <sub>ON</sub>   | Turnon time                | R <sub>L</sub> = 10Ω, C <sub>IN</sub> = 1μF, C <sub>OUT</sub> = 0.1μF | 61                     | 752                    | μs   |
| t <sub>OFF</sub>  | Turnoff time               | R <sub>L</sub> = 10Ω, C <sub>IN</sub> = 1μF, C <sub>OUT</sub> = 0.1μF | 3                      | 3                      | μs   |
| t <sub>R</sub>  | V <sub>OUT</sub> rise time | R <sub>L</sub> = 10Ω, C <sub>IN</sub> = 1μF, C <sub>OUT</sub> = 0.1μF | 28                     | 409                    | μs   |
| t <sub>F</sub>  | V <sub>OUT</sub> fall time | R <sub>L</sub> = 10Ω, C <sub>IN</sub> = 1μF, C <sub>OUT</sub> = 0.1μF | 2                      | 2                      | μs   |
| t <sub>D</sub>  | Delay time                 | R <sub>L</sub> = 10Ω, C <sub>IN</sub> = 1μF, C <sub>OUT</sub> = 0.1μF | 47                     | 547                    | μs   |



## 6.7 Typical DC Characteristics

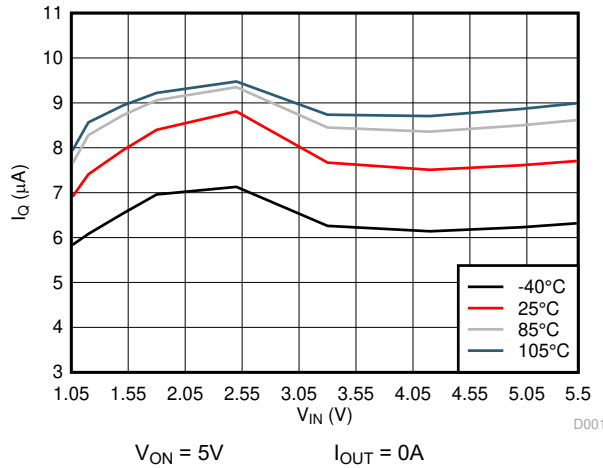


Figure 6-1.  $I_Q$  vs  $V_{IN}$  (TPS22914B/15B)

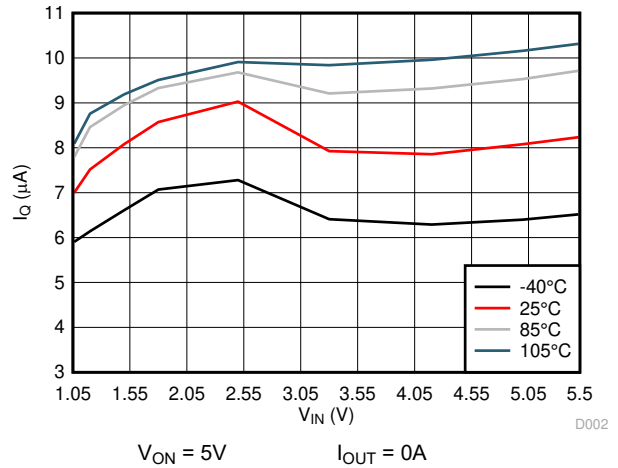


Figure 6-2.  $I_Q$  vs  $V_{IN}$  (TPS22914C/15C)

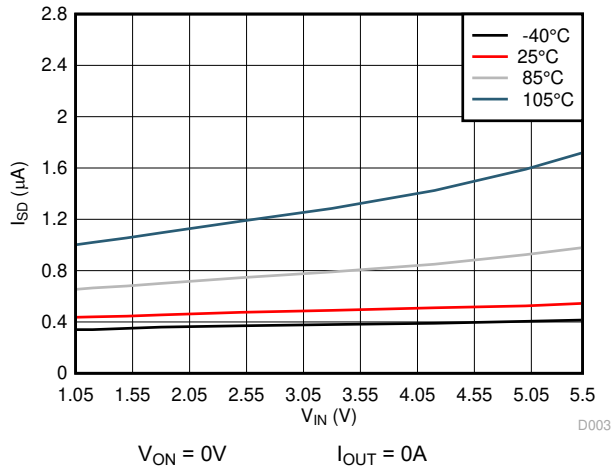


Figure 6-3.  $I_{SD}$  vs  $V_{IN}$

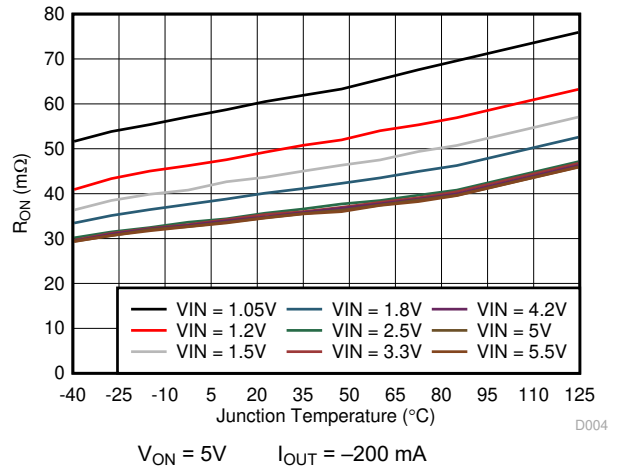


Figure 6-4.  $R_{ON}$  vs  $T_J$

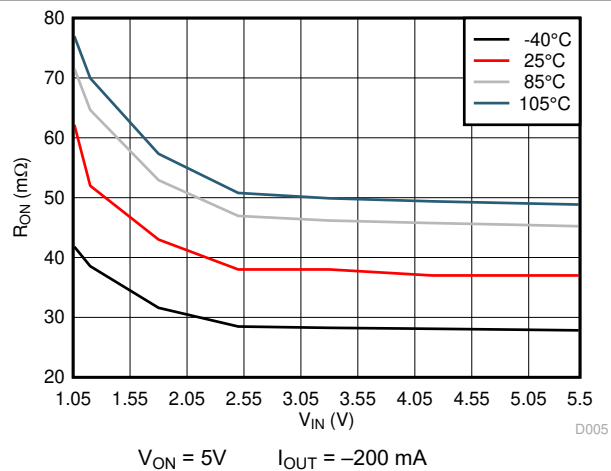


Figure 6-5.  $R_{ON}$  vs  $V_{IN}$

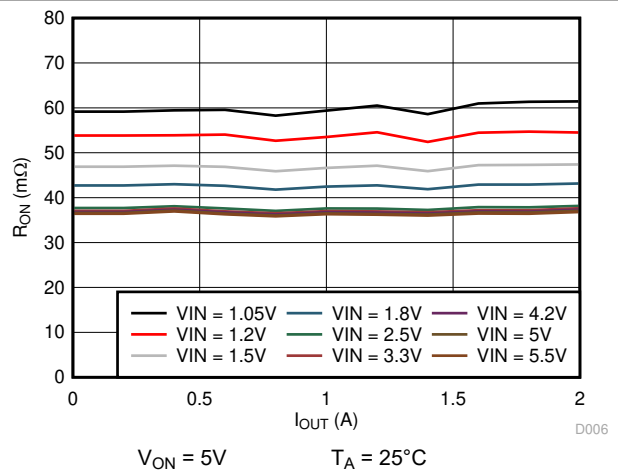
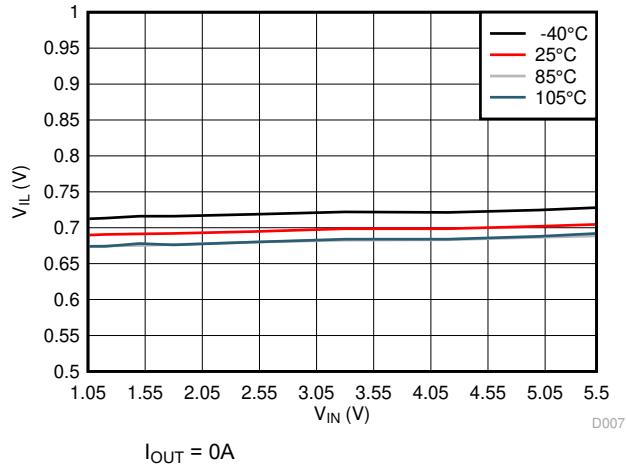
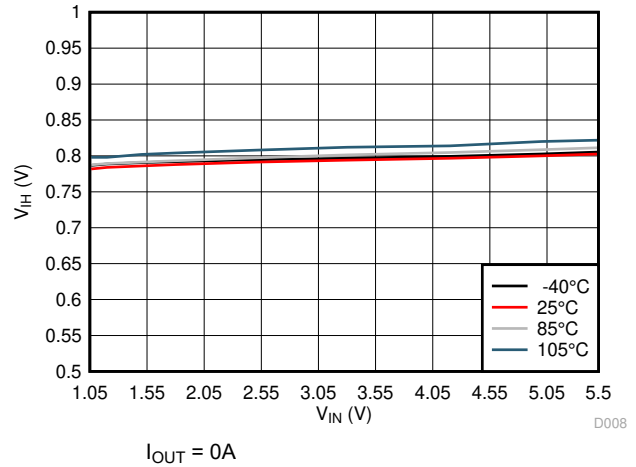


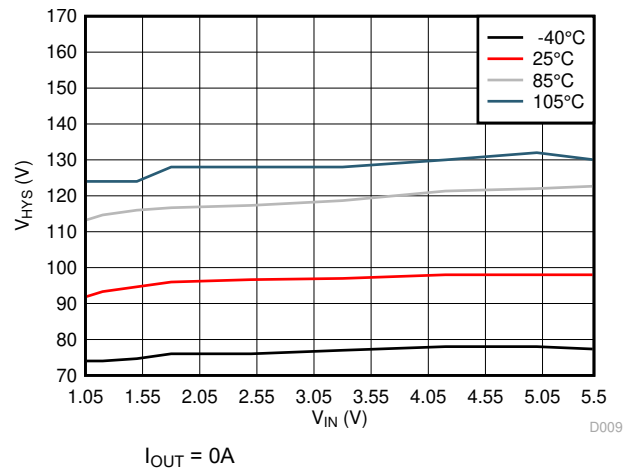
Figure 6-6.  $R_{ON}$  vs  $I_{OUT}$



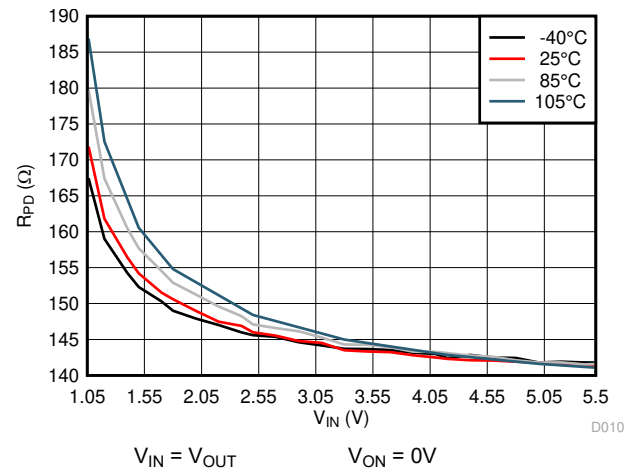
**Figure 6-7.  $V_{IL}$  vs  $V_{IN}$**



**Figure 6-8.  $V_{IH}$  vs  $V_{IN}$**

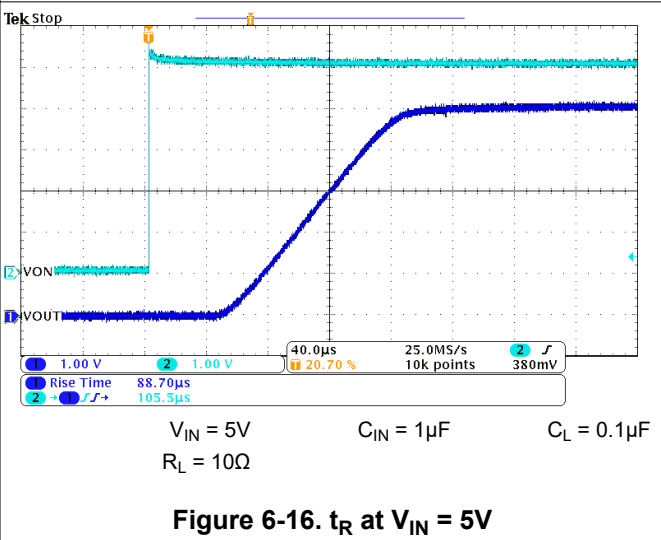
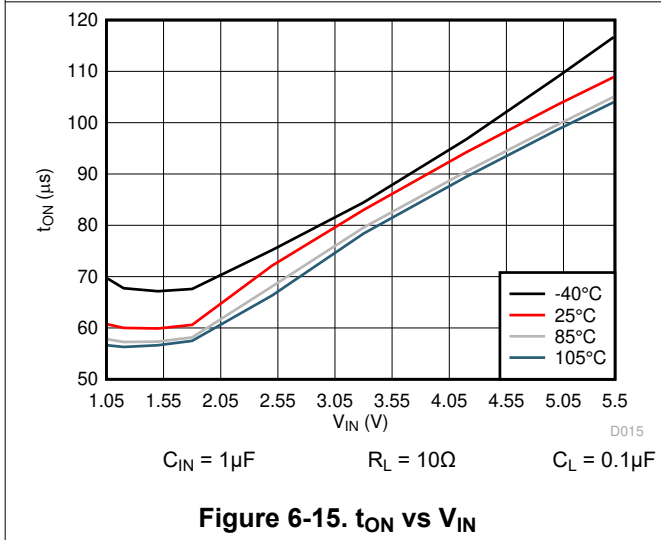
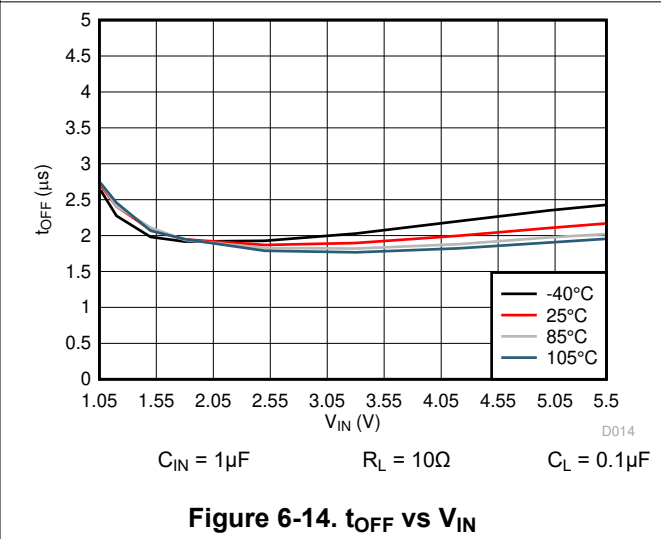
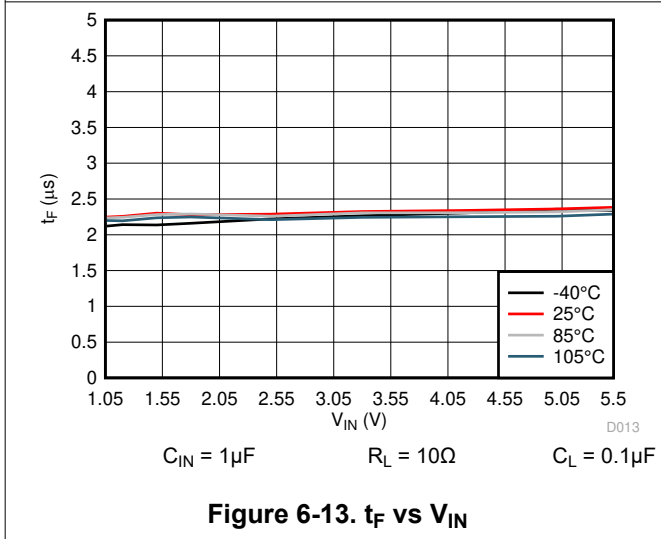
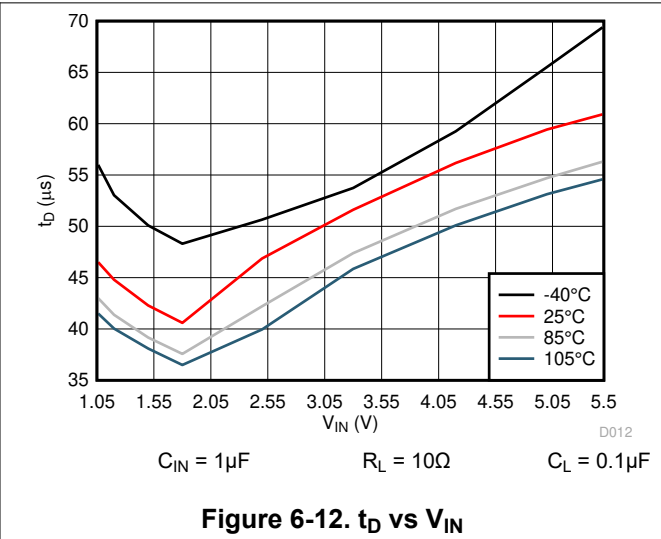
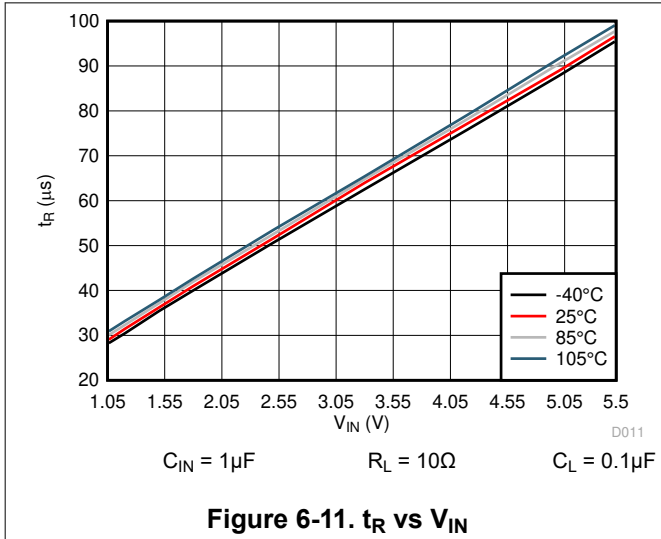


**Figure 6-9.  $V_{HYS}$  vs  $V_{IN}$**



**Figure 6-10.  $R_{PD}$  vs  $V_{IN}$**

### 6.8 Typical AC Characteristics (TPS22914B/15B)



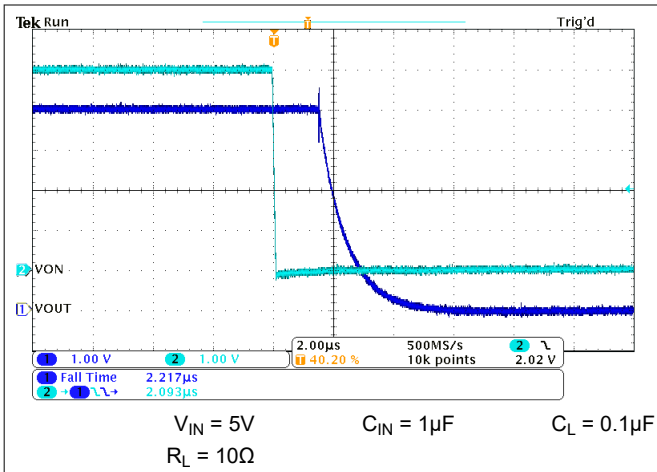


Figure 6-17.  $t_F$  at  $V_{IN} = 5V$

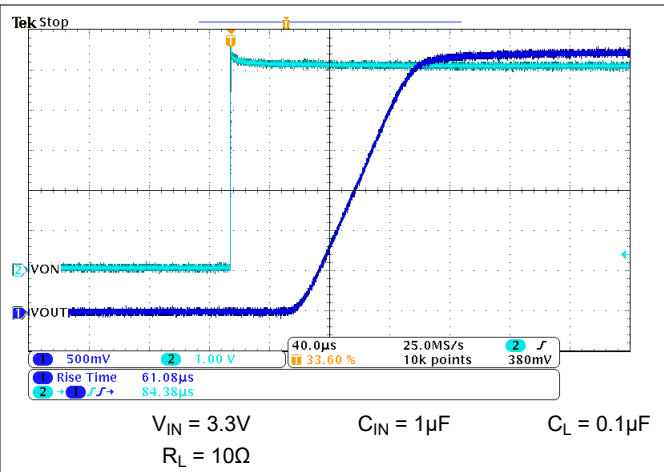


Figure 6-18.  $t_R$  at  $V_{IN} = 3.3V$

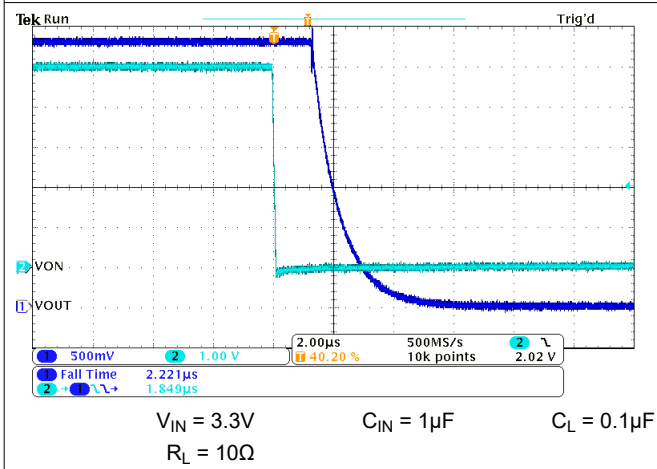


Figure 6-19.  $t_F$  at  $V_{IN} = 3.3V$

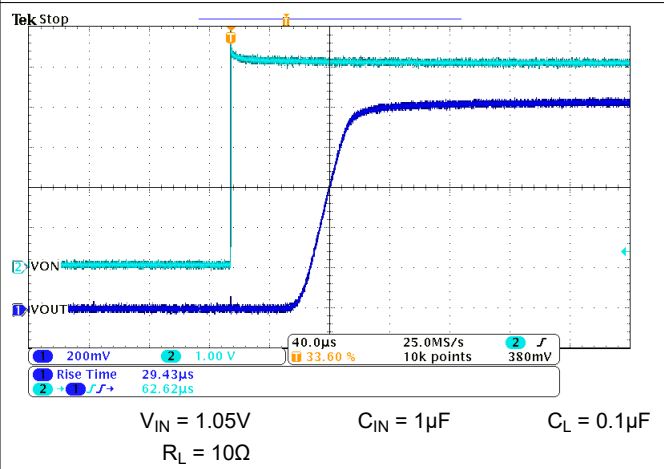


Figure 6-20.  $t_R$  at  $V_{IN} = 1.05V$

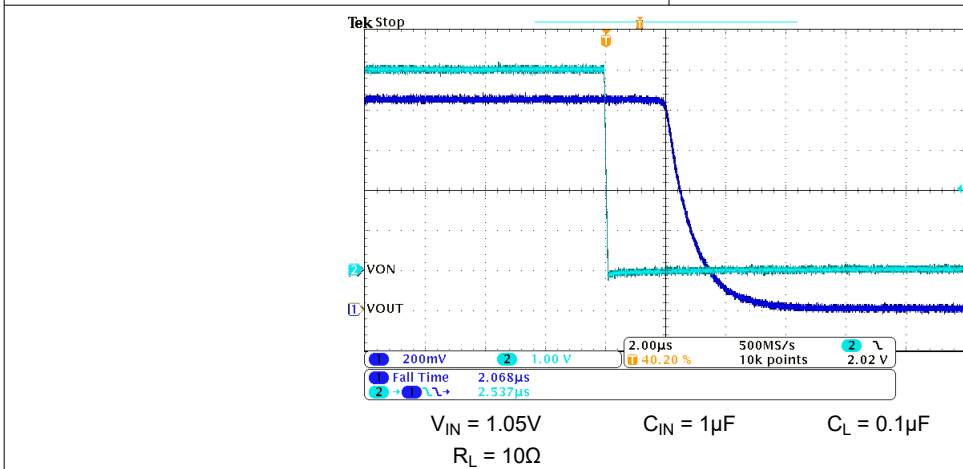
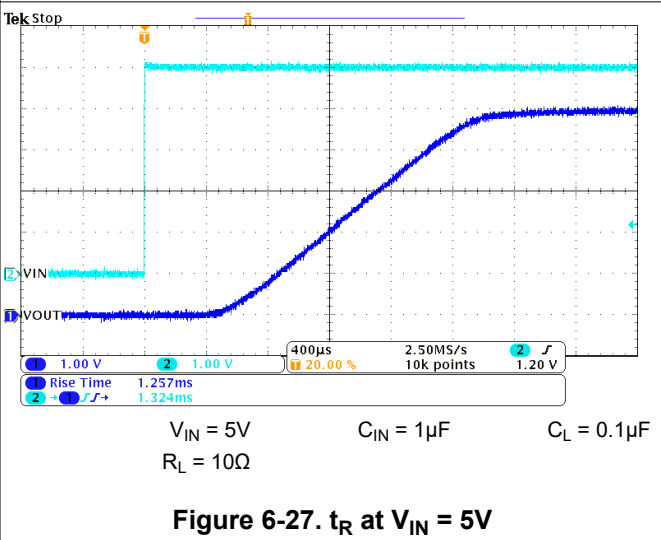
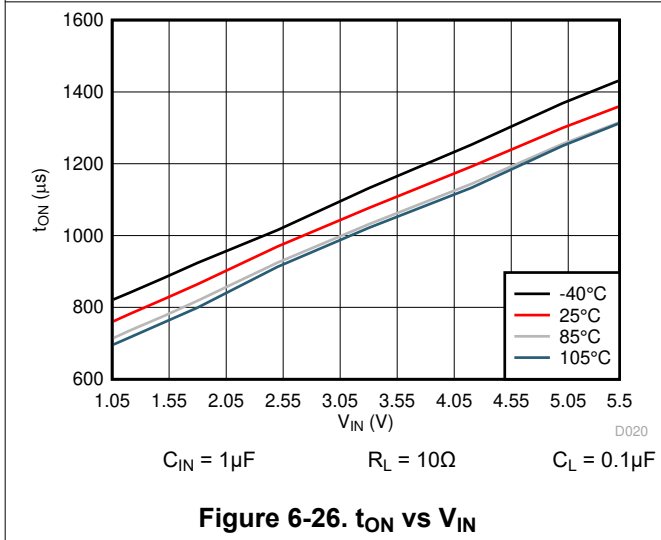
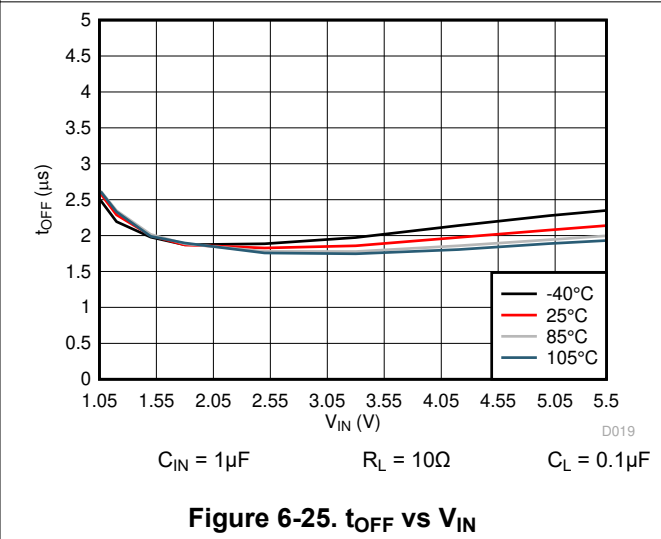
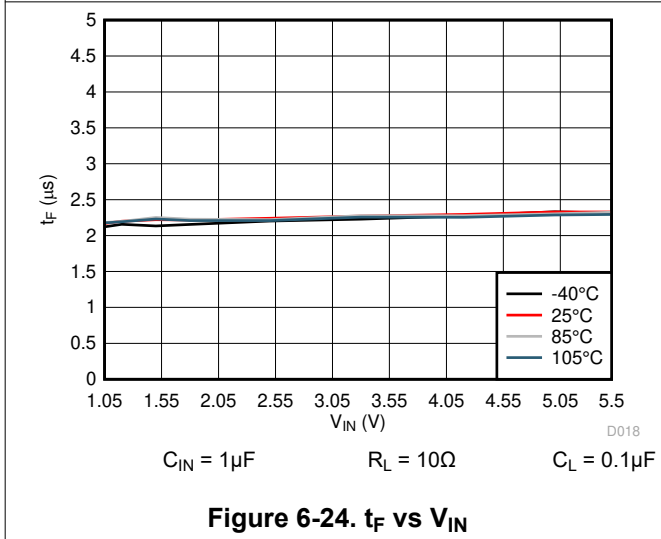
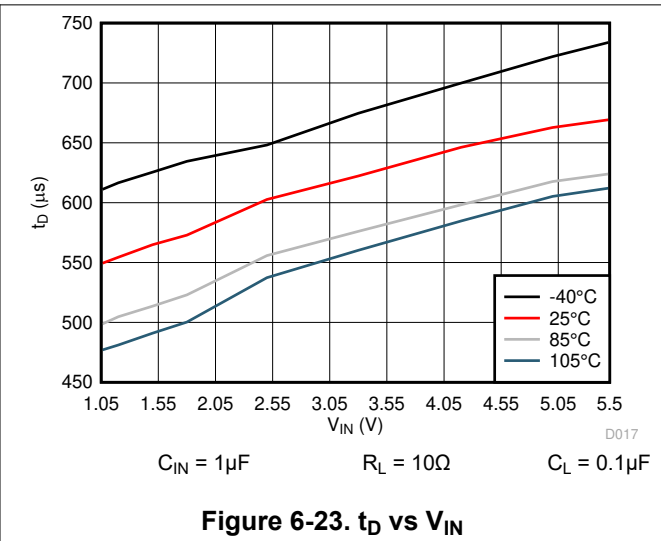
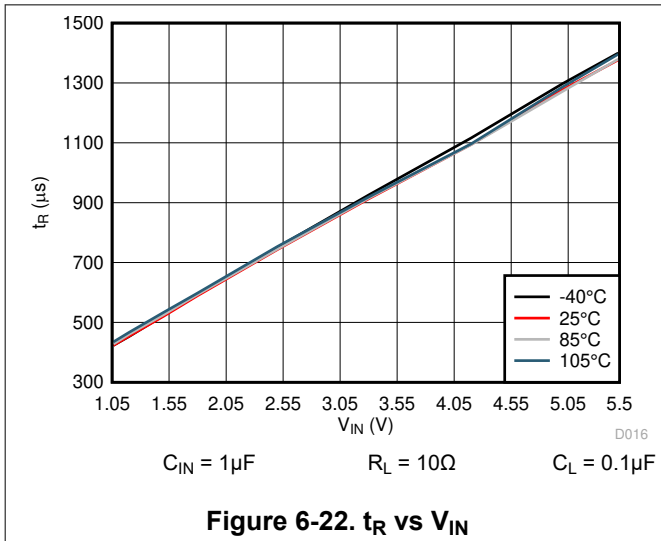


Figure 6-21.  $t_F$  at  $V_{IN} = 1.05V$

### 6.9 Typical AC Characteristics (TPS22914C/15C)



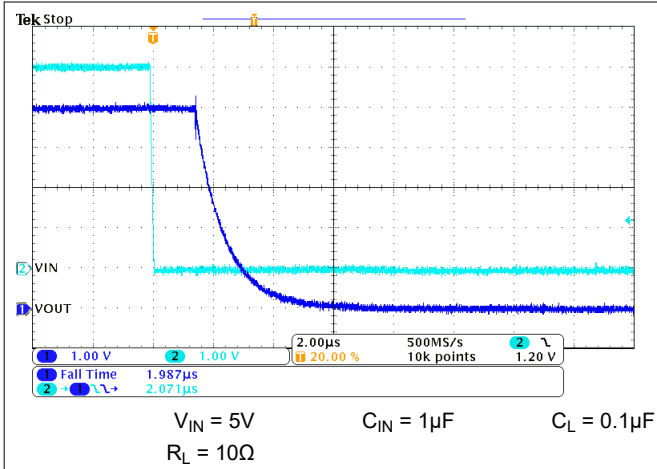


Figure 6-28.  $t_F$  at  $V_{IN} = 5V$

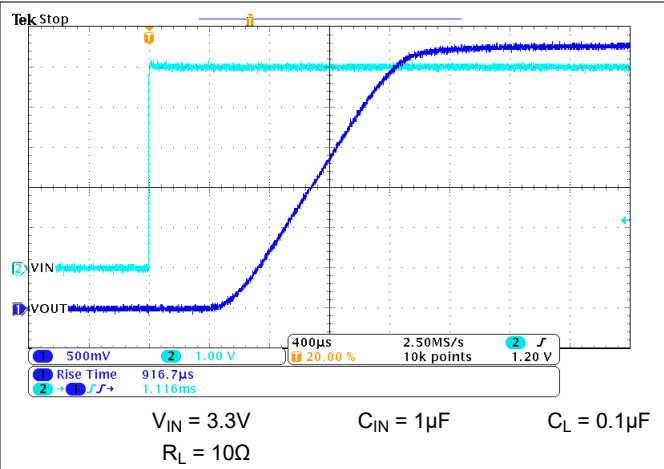


Figure 6-29.  $t_R$  at  $V_{IN} = 3.3V$

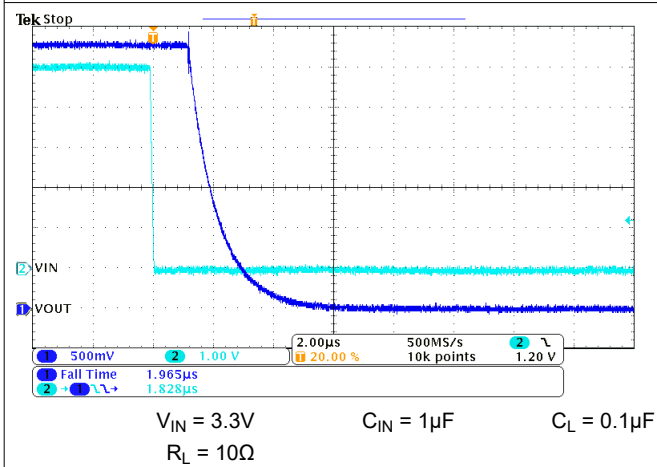


Figure 6-30.  $t_F$  at  $V_{IN} = 3.3V$

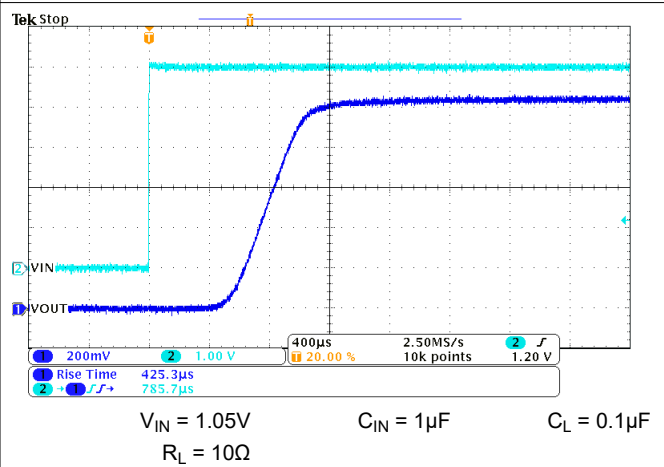


Figure 6-31.  $t_R$  at  $V_{IN} = 1.05V$

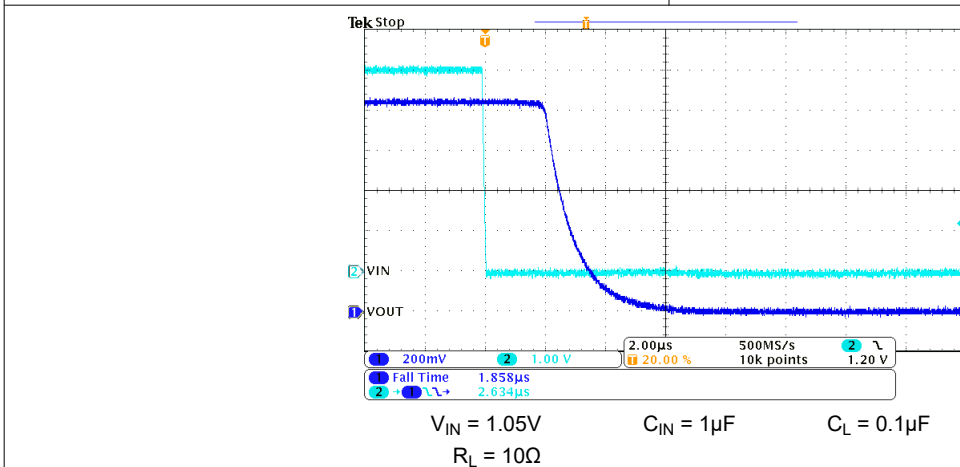
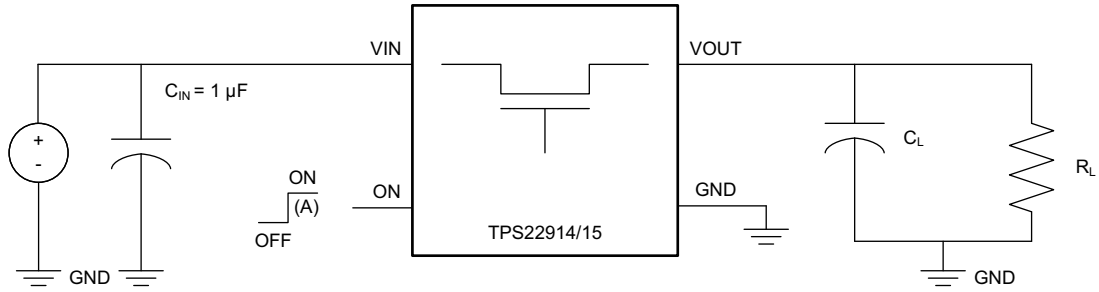


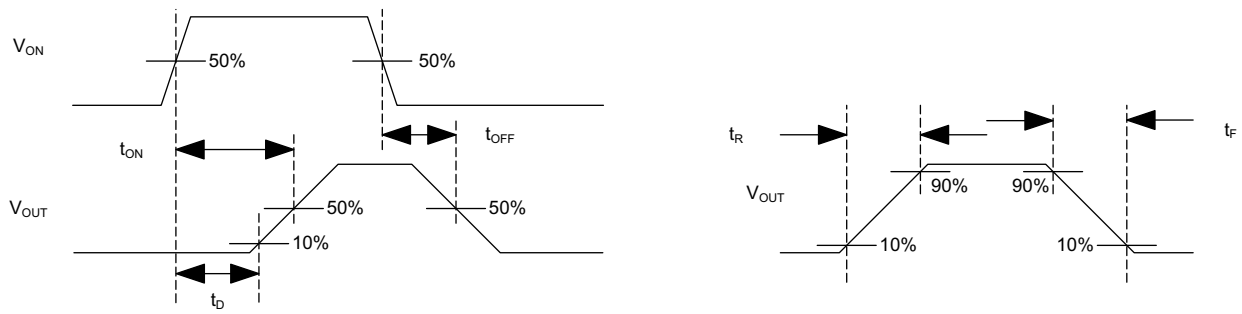
Figure 6-32.  $t_F$  at  $V_{IN} = 1.05V$

## 7 Parameter Measurement Information



A. Rise and fall times of the control signal is 100ns

**Figure 7-1. Test Circuit**



**Figure 7-2. Timing Waveforms**

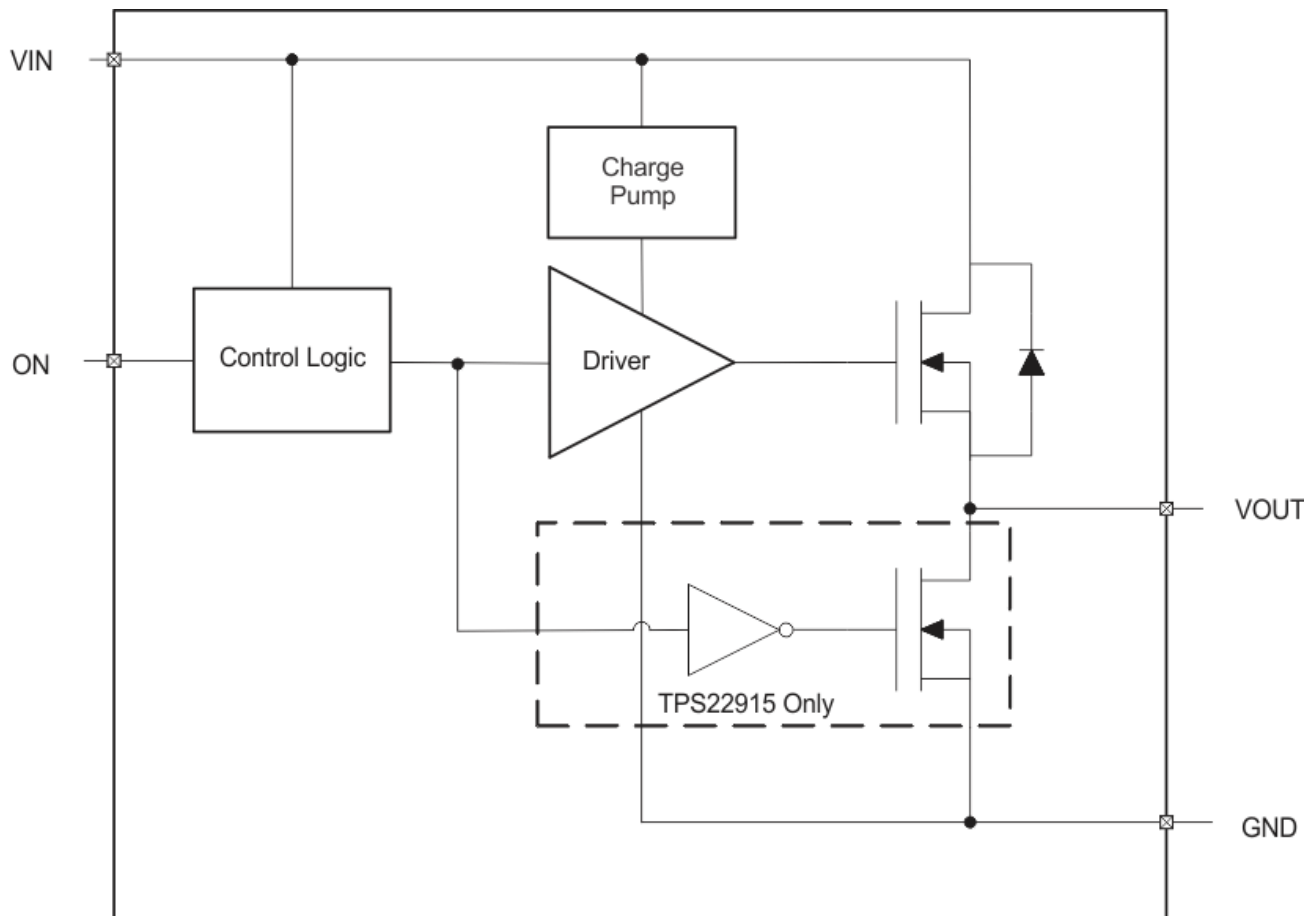
## 8 Detailed Description

### 8.1 Overview

The device is a 5.5V, 2A load switch in a 4-pin YFP package. To reduce voltage drop for low voltage and high current rails, the device implements an ultra-low resistance N-channel MOSFET which reduces the drop out voltage through the device.

The device has a controlled and fixed slew rate which helps reduce or eliminate power supply droop due to large inrush currents. During shutdown, the device has very low leakage currents, thereby reducing unnecessary leakages for downstream modules during standby. Integrated control logic, driver, charge pump, and output discharge FET eliminates the need for any external components, which reduces solution size and bill of materials (BOM) count.

### 8.2 Functional Block Diagram



### 8.3 Feature Description

#### 8.3.1 On and Off Control

The ON pins control the state of the switch. Asserting ON high enables the switch. ON is active high and has a low threshold, making the device capable of interfacing with low-voltage signals. The ON pin is compatible with standard GPIO logic threshold. The device can be used with any microcontroller with 1V or higher GPIO voltage. This pin cannot be left floating and must be driven either high or low for proper functionality.

#### 8.3.2 Input Capacitor ( $C_{IN}$ )

To limit the voltage drop on the input supply caused by transient in-rush currents when the switch turns on into a discharged load capacitor or short-circuit, a capacitor needs to be placed between VIN and GND. A 1 $\mu$ F



ceramic capacitor,  $C_{IN}$ , placed close to the pins, is typically sufficient. Higher values of  $C_{IN}$  can be used to further reduce the voltage drop during high-current application. When switching heavy loads, use an input capacitor approximately 10 times higher than the output capacitor to avoid excessive voltage drop.

### 8.3.3 Output Capacitor ( $C_L$ )

Due to the integrated body diode in the MOSFET, a  $C_{IN}$  greater than  $C_L$  is highly recommended. A  $C_L$  greater than  $C_{IN}$  can cause  $V_{OUT}$  to exceed  $V_{IN}$  when the system supply is removed. This can result in current flow through the body diode from  $V_{OUT}$  to  $V_{IN}$ . A  $C_{IN}$  to  $C_L$  ratio of 10 to 1 is recommended for minimizing  $V_{IN}$  dip caused by inrush currents during startup.

## 8.4 Device Functional Modes

Table 8-1 describes the connection of the  $V_{OUT}$  pin depending on the state of the ON pin.

**Table 8-1. VOUT Connection**

| ON | TPS22914 | TPS22915 |
|----|----------|----------|
| L  | Open     | GND      |
| H  | VIN      | VIN      |

## 9 Application and Implementation

### Note

Information in the following applications sections is not part of the TI component specification, and TI does not warrant its accuracy or completeness. TI's customers are responsible for determining suitability of components for their purposes, as well as validating and testing their design implementation to confirm system functionality.

### 9.1 Application Information

This section highlights some of the design considerations when implementing this device in various applications. A PSPICE model for this device is also available in the product page of this device.

### 9.2 Typical Application

This typical application demonstrates how the TPS22914 and TPS22915 can be used to power downstream modules.

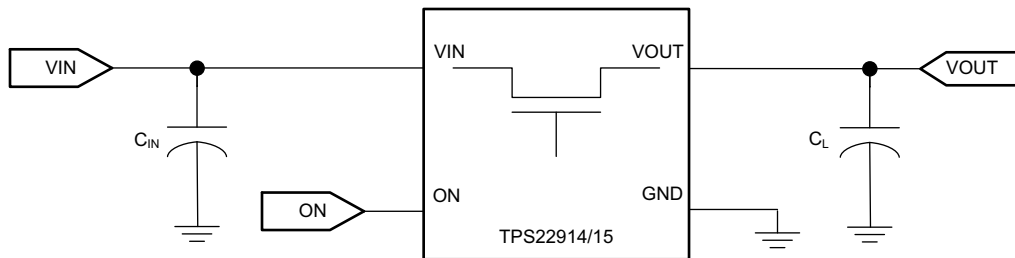


Figure 9-1. Typical Application Schematic

#### 9.2.1 Design Requirements

For this design example, use the input parameters shown in [Table 9-1](#).

Table 9-1. Design Parameters

| DESIGN PARAMETER | EXAMPLE VALUE |
|------------------|---------------|
| $V_{IN}$         | 5V            |
| Load current     | 2A            |

## 9.2.2 Detailed Design Procedure

To begin the design process, the designer needs to know the following:

- $V_{IN}$  voltage
- Load Current

### 9.2.2.1 $V_{IN}$ to $V_{OUT}$ Voltage Drop

The  $V_{IN}$  to  $V_{OUT}$  voltage drop in the device is determined by the  $R_{ON}$  of the device and the load current. The  $R_{ON}$  of the device depends upon the  $V_{IN}$  conditions of the device. Refer to the  $R_{ON}$  specification of the device in the [Electrical Characteristics](#) table of this data sheet. Once the  $R_{ON}$  of the device is determined based upon the  $V_{IN}$  conditions, use [Equation 1](#) to calculate the  $V_{IN}$  to  $V_{OUT}$  voltage drop.

$$\Delta V = I_{LOAD} \times R_{ON} \quad (1)$$

where

- $\Delta V$  = voltage drop from  $V_{IN}$  to  $V_{OUT}$
- $I_{LOAD}$  = load current
- $R_{ON}$  = On-resistance of the device for a specific  $V_{IN}$

An appropriate  $I_{LOAD}$  must be chosen such that the  $I_{MAX}$  specification of the device is not violated.

### 9.2.2.2 Inrush Current

To determine how much inrush current is caused by the  $C_L$  capacitor, use [Equation 2](#).

$$I_{INRUSH} = C_L \times \frac{dV_{OUT}}{dt} \quad (2)$$

where

- $I_{INRUSH}$  = amount of inrush caused by  $C_L$
- $C_L$  = capacitance on  $V_{OUT}$
- $dt$  = rise time in  $V_{OUT}$  during the ramp up of  $V_{OUT}$  when the device is enabled
- $dV_{OUT}$  = change in  $V_{OUT}$  during the ramp up of  $V_{OUT}$  when the device is enabled

An appropriate  $C_L$  value must be placed on  $V_{OUT}$  such that the  $I_{MAX}$  and  $I_{PLS}$  specifications of the device are not violated.

## 9.2.3 Application Curves

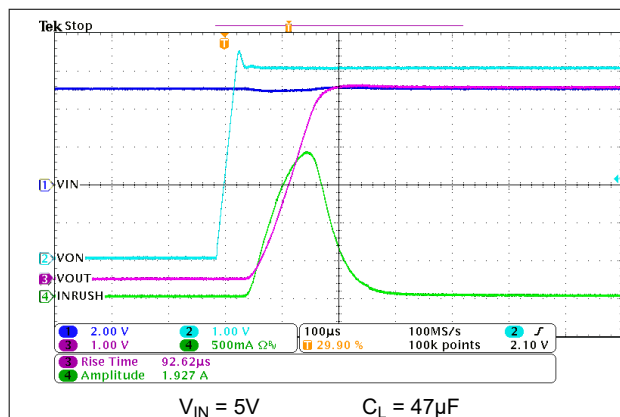


Figure 9-2. TPS22914B/15B Inrush Current

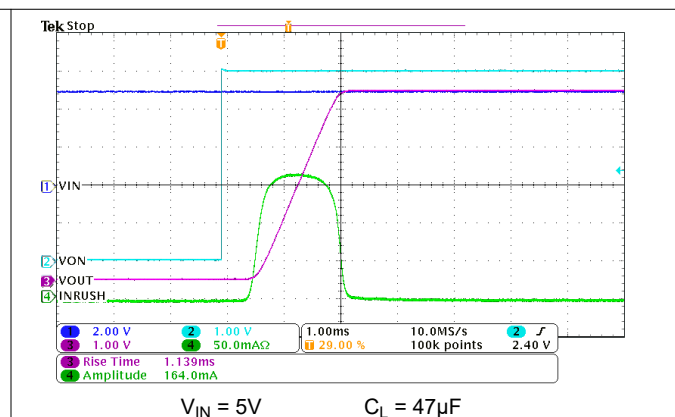


Figure 9-3. TPS22914C/15C Inrush Current

## 9.3 Power Supply Recommendations

The device is designed to operate from a VIN range of 1.05V to 5.5V. This supply must be well regulated and placed as close to the device terminal as possible with the recommended 1µF bypass capacitor. If the supply is located more than a few inches from the device terminals, additional bulk capacitance can be required in addition to the ceramic bypass capacitors. If additional bulk capacitance is required, an electrolytic, tantalum, or ceramic capacitor of 1µF can be sufficient.

## 9.4 Layout

### 9.4.1 Layout Guidelines

1. VIN and VOUT traces must be as short and wide as possible to accommodate for high current.
2. The VIN pin must be bypassed to ground with low ESR ceramic bypass capacitors. The typical recommended bypass capacitance is 1µF ceramic with X5R or X7R dielectric. This capacitor must be placed as close to the device pins as possible.
3. The VOUT pin must be bypassed to ground with low ESR ceramic bypass capacitors. The typical recommended bypass capacitance is one-tenth of the VIN bypass capacitor of X5R or X7R dielectric rating. This capacitor must be placed as close to the device pins as possible.

#### 9.4.1.1 Thermal Considerations

For best performance, all traces must be as short as possible. To be most effective, the input and output capacitors must be placed close to the device to minimize the effects that parasitic trace inductances can have on normal and short-circuit operation. Using wide traces for VIN, VOUT, and GND helps minimize the parasitic electrical effects along with minimizing the case to ambient thermal impedance.

The maximum IC junction temperature must be restricted to 125°C under normal operating conditions. To calculate the maximum allowable dissipation,  $P_{D(MAX)}$  for a given output current and ambient temperature, use [Equation 3](#).

$$P_{D(MAX)} = \frac{T_{J(MAX)} - T_A}{\theta_{JA}} \quad (3)$$

where

- $P_{D(MAX)}$  = maximum allowable power dissipation
- $T_{J(MAX)}$  = maximum allowable junction temperature (125°C for the TPS22914/15)
- $T_A$  = ambient temperature of the device
- $\theta_{JA}$  = junction to air thermal impedance. Refer to the [Thermal Information](#) table. This parameter is highly dependent upon board layout.

### 9.4.2 Layout Example

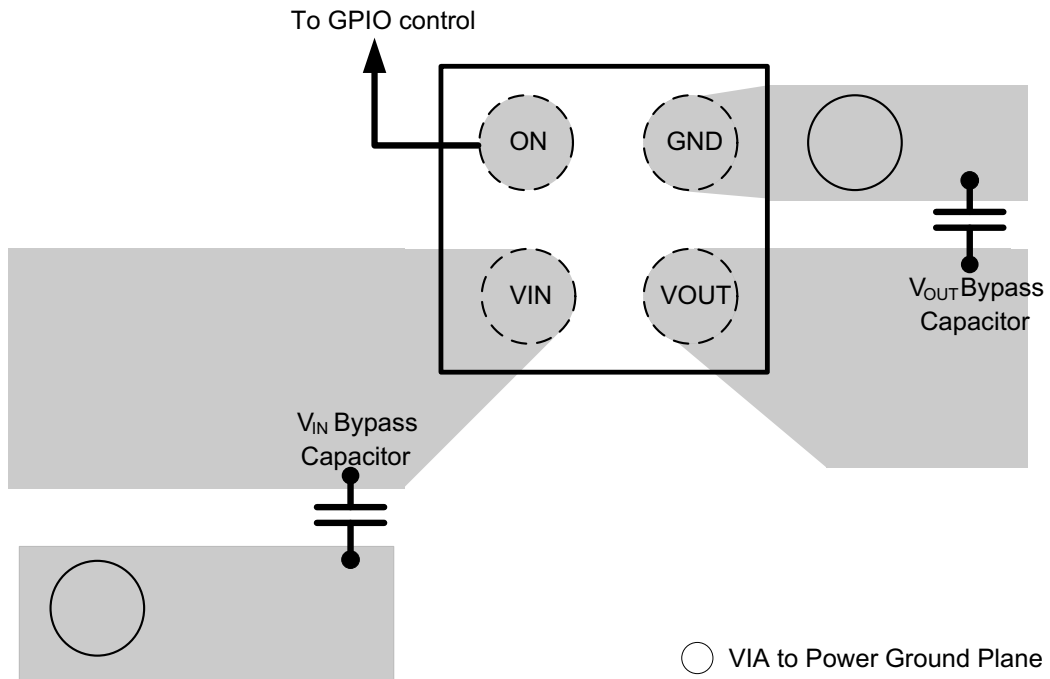


Figure 9-4. Recommended Board Layout

## 10 Device and Documentation Support

### 10.1 Documentation Support

#### 10.1.1 Related Documentation

For related documentation see the following:

- [Basics of Load Switches](#)
- [Managing Inrush Current](#)
- [Load Switch Thermal Considerations](#)
- [Using the TPS22915BEVM-078 Single Channel Load Switch IC](#)
- [Implementing Ship Mode Using the TPS22915B Load Switches](#)

### 10.2 Related Links

The table below lists quick access links. Categories include technical documents, support and community resources, tools and software, and quick access to sample or buy.

**Table 10-1. Related Links**

| PARTS     | PRODUCT FOLDER             | SAMPLE & BUY               | TECHNICAL DOCUMENTS        | TOOLS & SOFTWARE           | SUPPORT & COMMUNITY        |
|-----------|----------------------------|----------------------------|----------------------------|----------------------------|----------------------------|
| TPS22914B | <a href="#">Click here</a> | <a href="#">Click here</a> | <a href="#">Click here</a> | <a href="#">Click here</a> | <a href="#">Click here</a> |
| TPS22914C | <a href="#">Click here</a> | <a href="#">Click here</a> | <a href="#">Click here</a> | <a href="#">Click here</a> | <a href="#">Click here</a> |
| TPS22915B | <a href="#">Click here</a> | <a href="#">Click here</a> | <a href="#">Click here</a> | <a href="#">Click here</a> | <a href="#">Click here</a> |
| TPS22915C | <a href="#">Click here</a> | <a href="#">Click here</a> | <a href="#">Click here</a> | <a href="#">Click here</a> | <a href="#">Click here</a> |

### 10.3 Receiving Notification of Documentation Updates

To receive notification of documentation updates, navigate to the device product folder on [ti.com](http://ti.com). Click on *Notifications* to register and receive a weekly digest of any product information that has changed. For change details, review the revision history included in any revised document.

### 10.4 Support Resources

[TI E2E™ support forums](#) are an engineer's go-to source for fast, verified answers and design help — straight from the experts. Search existing answers or ask your own question to get the quick design help you need.

Linked content is provided "AS IS" by the respective contributors. They do not constitute TI specifications and do not necessarily reflect TI's views; see TI's [Terms of Use](#).

### 10.5 Trademarks

Ultrabook™ is a trademark of Intel.

TI E2E™ is a trademark of Texas Instruments.

All trademarks are the property of their respective owners.

### 10.6 Electrostatic Discharge Caution



This integrated circuit can be damaged by ESD. Texas Instruments recommends that all integrated circuits be handled with appropriate precautions. Failure to observe proper handling and installation procedures can cause damage.

ESD damage can range from subtle performance degradation to complete device failure. Precision integrated circuits may be more susceptible to damage because very small parametric changes could cause the device not to meet its published specifications.

### 10.7 Glossary

[TI Glossary](#) This glossary lists and explains terms, acronyms, and definitions.

## 11 Revision History

NOTE: Page numbers for previous revisions may differ from page numbers in the current version.

---

| <b>Changes from Revision E (October 2020) to Revision F (July 2025)</b> | <b>Page</b> |
|---|-------------|
| • Updated the size of the device .....                                  | 1           |
| • Updated package size in the Description paragraph.....                | 1           |

---

| <b>Changes from Revision D (September 2016) to Revision E (October 2020)</b>                         | <b>Page</b> |
|--|-------------|
| • Updated the numbering format for tables, figures and cross-references throughout the document..... | 1           |
| • Updated the body size in the <i>Device Information</i> table.....                                  | 1           |

---

## **12 Mechanical, Packaging, and Orderable Information**

The following pages include mechanical, packaging, and orderable information. This information is the most current data available for the designated devices. This data is subject to change without notice and revision of this document. For browser-based versions of this data sheet, refer to the left-hand navigation.

**PACKAGING INFORMATION**

| Orderable part number         | Status<br>(1) | Material type<br>(2) | Package   Pins  | Package qty   Carrier | RoHS<br>(3) | Lead finish/<br>Ball material<br>(4) | MSL rating/<br>Peak reflow<br>(5) | Op temp (°C) | Part marking<br>(6) |
|-------------------------------|---------------|----------------------|-----------------|-----------------------|-------------|--------------------------------------|-----------------------------------|--------------|---------------------|
| <a href="#">TPS22914BYFPR</a> | Active        | Production           | DSBGA (YFP)   4 | 3000   LARGE T&R      | Yes         | SNAGCU                               | Level-1-260C-UNLIM                | -40 to 105   | S3                  |
| TPS22914BYFPR.A               | Active        | Production           | DSBGA (YFP)   4 | 3000   LARGE T&R      | Yes         | SNAGCU                               | Level-1-260C-UNLIM                | -40 to 105   | S3                  |
| <a href="#">TPS22914BYFPT</a> | Active        | Production           | DSBGA (YFP)   4 | 250   SMALL T&R       | Yes         | SNAGCU                               | Level-1-260C-UNLIM                | -40 to 105   | S3                  |
| TPS22914BYFPT.A               | Active        | Production           | DSBGA (YFP)   4 | 250   SMALL T&R       | Yes         | SNAGCU                               | Level-1-260C-UNLIM                | -40 to 105   | S3                  |
| <a href="#">TPS22914CYFPR</a> | Active        | Production           | DSBGA (YFP)   4 | 3000   LARGE T&R      | Yes         | SNAGCU                               | Level-1-260C-UNLIM                | -40 to 105   | S6                  |
| TPS22914CYFPR.A               | Active        | Production           | DSBGA (YFP)   4 | 3000   LARGE T&R      | Yes         | SNAGCU                               | Level-1-260C-UNLIM                | -40 to 105   | S6                  |
| <a href="#">TPS22914CYFPT</a> | Active        | Production           | DSBGA (YFP)   4 | 250   SMALL T&R       | Yes         | SNAGCU                               | Level-1-260C-UNLIM                | -40 to 105   | S6                  |
| TPS22914CYFPT.A               | Active        | Production           | DSBGA (YFP)   4 | 250   SMALL T&R       | Yes         | SNAGCU                               | Level-1-260C-UNLIM                | -40 to 105   | S6                  |
| <a href="#">TPS22915BYFPR</a> | Active        | Production           | DSBGA (YFP)   4 | 3000   LARGE T&R      | Yes         | SNAGCU                               | Level-1-260C-UNLIM                | -40 to 105   | S4                  |
| TPS22915BYFPR.A               | Active        | Production           | DSBGA (YFP)   4 | 3000   LARGE T&R      | Yes         | SNAGCU                               | Level-1-260C-UNLIM                | -40 to 105   | S4                  |
| <a href="#">TPS22915BYFPT</a> | Active        | Production           | DSBGA (YFP)   4 | 250   SMALL T&R       | Yes         | SNAGCU                               | Level-1-260C-UNLIM                | -40 to 105   | S4                  |
| TPS22915BYFPT.A               | Active        | Production           | DSBGA (YFP)   4 | 250   SMALL T&R       | Yes         | SNAGCU                               | Level-1-260C-UNLIM                | -40 to 105   | S4                  |
| <a href="#">TPS22915CYFPR</a> | Active        | Production           | DSBGA (YFP)   4 | 3000   LARGE T&R      | Yes         | SNAGCU                               | Level-1-260C-UNLIM                | -40 to 105   | S7                  |
| TPS22915CYFPR.A               | Active        | Production           | DSBGA (YFP)   4 | 3000   LARGE T&R      | Yes         | SNAGCU                               | Level-1-260C-UNLIM                | -40 to 105   | S7                  |
| <a href="#">TPS22915CYFPT</a> | Active        | Production           | DSBGA (YFP)   4 | 250   SMALL T&R       | Yes         | SNAGCU                               | Level-1-260C-UNLIM                | -40 to 105   | S7                  |
| TPS22915CYFPT.A               | Active        | Production           | DSBGA (YFP)   4 | 250   SMALL T&R       | Yes         | SNAGCU                               | Level-1-260C-UNLIM                | -40 to 105   | S7                  |

(1) **Status:** For more details on status, see our [product life cycle](#).

(2) **Material type:** When designated, preproduction parts are prototypes/experimental devices, and are not yet approved or released for full production. Testing and final process, including without limitation quality assurance, reliability performance testing, and/or process qualification, may not yet be complete, and this item is subject to further changes or possible discontinuation. If available for ordering, purchases will be subject to an additional waiver at checkout, and are intended for early internal evaluation purposes only. These items are sold without warranties of any kind.

(3) **RoHS values:** Yes, No, RoHS Exempt. See the [TI RoHS Statement](#) for additional information and value definition.

(4) **Lead finish/Ball material:** Parts may have multiple material finish options. Finish options are separated by a vertical ruled line. Lead finish/Ball material values may wrap to two lines if the finish value exceeds the maximum column width.

(5) **MSL rating/Peak reflow:** The moisture sensitivity level ratings and peak solder (reflow) temperatures. In the event that a part has multiple moisture sensitivity ratings, only the lowest level per JEDEC standards is shown. Refer to the shipping label for the actual reflow temperature that will be used to mount the part to the printed circuit board.



(6) **Part marking:** There may be an additional marking, which relates to the logo, the lot trace code information, or the environmental category of the part.

Multiple part markings will be inside parentheses. Only one part marking contained in parentheses and separated by a "-" will appear on a part. If a line is indented then it is a continuation of the previous line and the two combined represent the entire part marking for that device.

**Important Information and Disclaimer:**The information provided on this page represents TI's knowledge and belief as of the date that it is provided. TI bases its knowledge and belief on information provided by third parties, and makes no representation or warranty as to the accuracy of such information. Efforts are underway to better integrate information from third parties. TI has taken and continues to take reasonable steps to provide representative and accurate information but may not have conducted destructive testing or chemical analysis on incoming materials and chemicals. TI and TI suppliers consider certain information to be proprietary, and thus CAS numbers and other limited information may not be available for release.

In no event shall TI's liability arising out of such information exceed the total purchase price of the TI part(s) at issue in this document sold by TI to Customer on an annual basis.

**TAPE AND REEL INFORMATION**

**QUADRANT ASSIGNMENTS FOR PIN 1 ORIENTATION IN TAPE**

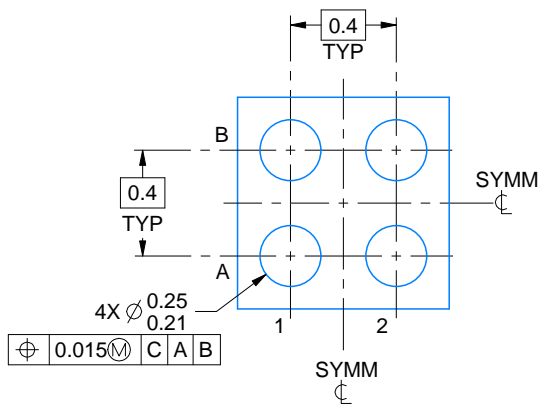
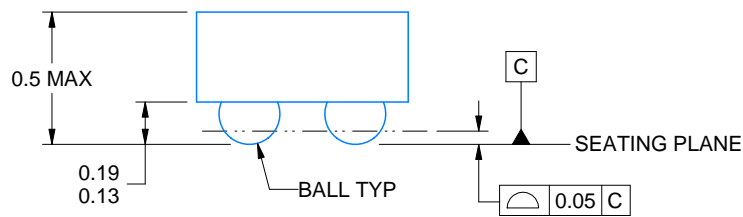
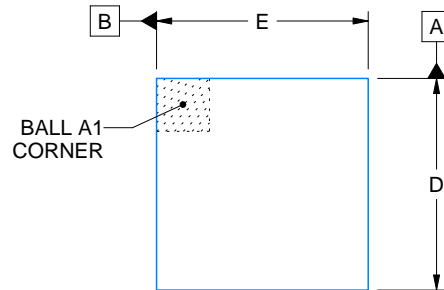

\*All dimensions are nominal

| Device        | Package Type | Package Drawing | Pins | SPQ  | Reel Diameter (mm) | Reel Width W1 (mm) | A0 (mm) | B0 (mm) | K0 (mm) | P1 (mm) | W (mm) | Pin1 Quadrant |
|---------------|--------------|-----------------|------|------|--------------------|--------------------|---------|---------|---------|---------|--------|---------------|
| TPS22914BYFPR | DSBGA        | YFP             | 4    | 3000 | 180.0              | 8.4                | 0.85    | 0.85    | 0.64    | 4.0     | 8.0    | Q1            |
| TPS22914BYFPT | DSBGA        | YFP             | 4    | 250  | 180.0              | 8.4                | 0.85    | 0.85    | 0.64    | 4.0     | 8.0    | Q1            |
| TPS22914CYFPR | DSBGA        | YFP             | 4    | 3000 | 180.0              | 8.4                | 0.85    | 0.85    | 0.64    | 4.0     | 8.0    | Q1            |
| TPS22914CYFPT | DSBGA        | YFP             | 4    | 250  | 180.0              | 8.4                | 0.85    | 0.85    | 0.64    | 4.0     | 8.0    | Q1            |
| TPS22915BYFPR | DSBGA        | YFP             | 4    | 3000 | 180.0              | 8.4                | 0.85    | 0.85    | 0.64    | 4.0     | 8.0    | Q1            |
| TPS22915BYFPT | DSBGA        | YFP             | 4    | 250  | 180.0              | 8.4                | 0.85    | 0.85    | 0.64    | 4.0     | 8.0    | Q1            |
| TPS22915CYFPR | DSBGA        | YFP             | 4    | 3000 | 180.0              | 8.4                | 0.85    | 0.85    | 0.64    | 4.0     | 8.0    | Q1            |
| TPS22915CYFPT | DSBGA        | YFP             | 4    | 250  | 180.0              | 8.4                | 0.85    | 0.85    | 0.64    | 4.0     | 8.0    | Q1            |

**TAPE AND REEL BOX DIMENSIONS**


\*All dimensions are nominal

| Device        | Package Type | Package Drawing | Pins | SPQ  | Length (mm) | Width (mm) | Height (mm) |
|---------------|--------------|-----------------|------|------|-------------|------------|-------------|
| TPS22914BYFPR | DSBGA        | YFP             | 4    | 3000 | 182.0       | 182.0      | 20.0        |
| TPS22914BYFPT | DSBGA        | YFP             | 4    | 250  | 182.0       | 182.0      | 20.0        |
| TPS22914CYFPR | DSBGA        | YFP             | 4    | 3000 | 182.0       | 182.0      | 20.0        |
| TPS22914CYFPT | DSBGA        | YFP             | 4    | 250  | 182.0       | 182.0      | 20.0        |
| TPS22915BYFPR | DSBGA        | YFP             | 4    | 3000 | 182.0       | 182.0      | 20.0        |
| TPS22915BYFPT | DSBGA        | YFP             | 4    | 250  | 182.0       | 182.0      | 20.0        |
| TPS22915CYFPR | DSBGA        | YFP             | 4    | 3000 | 182.0       | 182.0      | 20.0        |
| TPS22915CYFPT | DSBGA        | YFP             | 4    | 250  | 182.0       | 182.0      | 20.0        |



D: Max = 0.778 mm, Min = 0.718 mm  
 E: Max = 0.778 mm, Min = 0.718 mm

4223507/A 01/2017

NOTES:

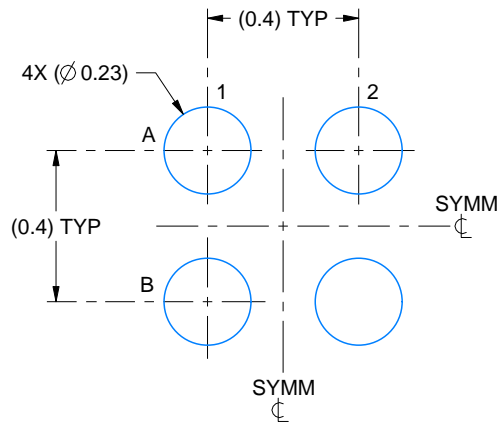
1. All linear dimensions are in millimeters. Any dimensions in parenthesis are for reference only. Dimensioning and tolerancing per ASME Y14.5M.
2. This drawing is subject to change without notice.

# EXAMPLE BOARD LAYOUT

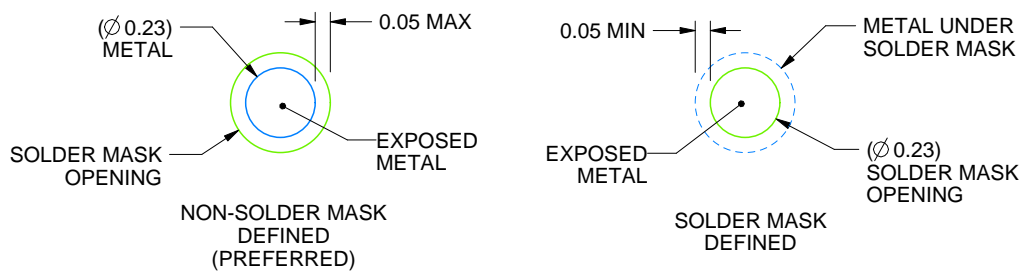
YFP0004

DSBGA - 0.5 mm max height

DIE SIZE BALL GRID ARRAY



LAND PATTERN EXAMPLE  
EXPOSED METAL SHOWN  
SCALE:50X



SOLDER MASK DETAILS  
NOT TO SCALE

4223507/A 01/2017

NOTES: (continued)

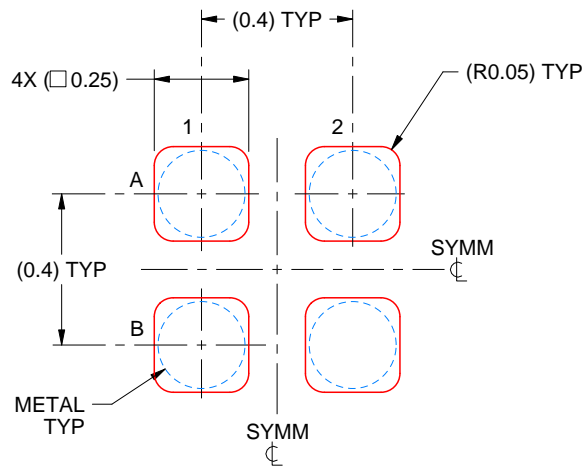
- Final dimensions may vary due to manufacturing tolerance considerations and also routing constraints. For more information, see Texas Instruments literature number SNVA009 ([www.ti.com/lit/snva009](http://www.ti.com/lit/snva009)).

# EXAMPLE STENCIL DESIGN

YFP0004

DSBGA - 0.5 mm max height

DIE SIZE BALL GRID ARRAY



SOLDER PASTE EXAMPLE  
BASED ON 0.1 mm THICK STENCIL  
SCALE:50X

4223507/A 01/2017

NOTES: (continued)

4. Laser cutting apertures with trapezoidal walls and rounded corners may offer better paste release.

## IMPORTANT NOTICE AND DISCLAIMER

TI PROVIDES TECHNICAL AND RELIABILITY DATA (INCLUDING DATASHEETS), DESIGN RESOURCES (INCLUDING REFERENCE DESIGNS), APPLICATION OR OTHER DESIGN ADVICE, WEB TOOLS, SAFETY INFORMATION, AND OTHER RESOURCES "AS IS" AND WITH ALL FAULTS, AND DISCLAIMS ALL WARRANTIES, EXPRESS AND IMPLIED, INCLUDING WITHOUT LIMITATION ANY IMPLIED WARRANTIES OF MERCHANTABILITY, FITNESS FOR A PARTICULAR PURPOSE OR NON-INFRINGEMENT OF THIRD PARTY INTELLECTUAL PROPERTY RIGHTS.

These resources are intended for skilled developers designing with TI products. You are solely responsible for (1) selecting the appropriate TI products for your application, (2) designing, validating and testing your application, and (3) ensuring your application meets applicable standards, and any other safety, security, regulatory or other requirements.

These resources are subject to change without notice. TI grants you permission to use these resources only for development of an application that uses the TI products described in the resource. Other reproduction and display of these resources is prohibited. No license is granted to any other TI intellectual property right or to any third party intellectual property right. TI disclaims responsibility for, and you fully indemnify TI and its representatives against any claims, damages, costs, losses, and liabilities arising out of your use of these resources.

TI's products are provided subject to [TI's Terms of Sale](#), [TI's General Quality Guidelines](#), or other applicable terms available either on [ti.com](#) or provided in conjunction with such TI products. TI's provision of these resources does not expand or otherwise alter TI's applicable warranties or warranty disclaimers for TI products. Unless TI explicitly designates a product as custom or customer-specified, TI products are standard, catalog, general purpose devices.

TI objects to and rejects any additional or different terms you may propose.

Copyright © 2025, Texas Instruments Incorporated

Last updated 10/2025