

# TLV9051 / TLV9052 / TLV9054 5MHz, 15V/ $\mu$ s High Slew-Rate, RRIO Op Amp

## 1 Features

- High slew rate: 15V/ $\mu$ s
- Low quiescent current: 330 $\mu$ A
- Rail-to-rail input and output
- Low input offset voltage:  $\pm 0.33$ mV
- Unity-gain bandwidth: 5MHz
- Low broadband noise: 15nV/ $\sqrt{\text{Hz}}$
- Low input bias current: 2pA
- Unity-gain stable
- Internal RFI and EMI filter
- Scalable family of CMOS op amps for low-cost applications
- Operational at supply voltages as low as 1.8V
- Extended temperature range:  $-40^{\circ}\text{C}$  to  $125^{\circ}\text{C}$

## 2 Applications

- HVAC: heating, ventilating, and air conditioning
- Photodiode amplifier
- Current shunt monitoring for DC motor control
- White goods (refrigerators, washing machines, and so forth)
- Sensor signal conditioning
- Active filters
- Low-side current sensing

## 3 Description

The TLV9051, TLV9052, and TLV9054 devices are single, dual, and quad operational amplifiers, respectively. The devices are designed for low voltage operation from 1.8V to 6.0V. The inputs and outputs can operate from rail to rail at a very high slew rate. These devices are an excellent choice for cost-constrained applications where low-voltage operation, high slew rate, and low quiescent current is needed. The capacitive-load drive of the TLV905x family is 150pF, and the resistive open-loop output impedance makes stabilization easier with much higher capacitive loads.

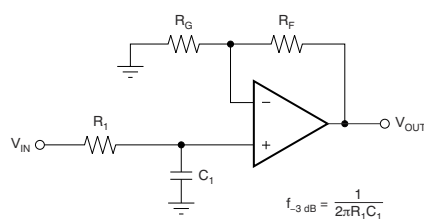

$$\frac{V_{OUT}}{V_{IN}} = \left(1 + \frac{R_F}{R_G}\right) \left(\frac{1}{1 + sR_1C_1}\right)$$

**Single-Pole, Low-Pass Filter**

The TLV905xS devices include a shutdown mode that allow the amplifiers to be switched off into a standby mode with typical current consumption less than 1 $\mu$ A.

The TLV905x family is easy to use due to the devices being unity-gain stable, including a RFI and EMI filter, and being free from phase reversal in an overdrive condition.

### Device Information

PART NUMBER <sup>(1)</sup>	CHANNEL COUNT	PACKAGE <sup>(2)</sup>	PACKAGE SIZE <sup>(4)</sup>
TLV9051	Single	DBV (SOT-23, 5)	2.9mm × 2.8mm
		DCK (SC70, 5)	2mm × 2.1mm
		DRL (SOT553, 5) <sup>(3)</sup>	1.6mm × 1.6mm
		DPW (X2SON, 5)	0.8mm × 0.8mm
TLV9051S	Single, Shutdown	DBV (SOT-23, 6)	2.9mm × 2.8mm
TLV9052	Dual	D (SOIC, 8)	4.9mm × 6mm
		PW (TSSOP, 8)	3mm × 6.4mm
		DGK (VSSOP, 8)	3mm × 4.9mm
		DDF (SOT-23, 8)	2.9mm × 2.8mm
		DSG (WSON, 8)	2mm × 2mm
TLV9052S	Dual, Shutdown	DGS (VSSOP, 10)	3mm × 4.9mm
		RUG (X2QFN, 10)	1.5mm × 2mm
TLV9054	Quad	D (SOIC, 14)	8.65mm × 6mm
		PW (TSSOP, 14)	5mm × 6.4mm
		RUC (WQFN, 14)	2mm × 2mm
		RTE (WQFN, 16)	3mm × 3mm
TLV9054S	Quad, Shutdown	RTE (WQFN, 16)	3mm × 3mm

- (1) See [Device Comparison](#)
- (2) For more information, see [Section 11](#)
- (3) Package is for preview only.
- (4) The package size (length × width) is a nominal value and includes pins, where applicable.

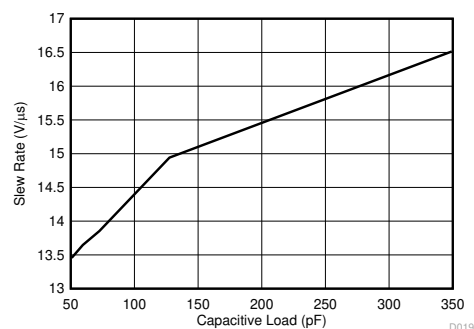

**Slew Rate vs Load Capacitance**



## Table of Contents

<b>1 Features</b> .....	1	7.3 Feature Description.....	21
<b>2 Applications</b> .....	1	7.4 Device Functional Modes.....	24
<b>3 Description</b> .....	1	<b>8 Application and Implementation</b> .....	25
<b>4 Device Comparison Table</b> .....	2	8.1 Application Information.....	25
<b>5 Pin Configuration and Functions</b> .....	3	8.2 Typical Low-Side Current Sense Application.....	25
<b>6 Specifications</b> .....	9	8.3 Power Supply Recommendations.....	27
6.1 Absolute Maximum Ratings.....	9	8.4 Layout.....	27
6.2 ESD Ratings.....	9	<b>9 Device and Documentation Support</b> .....	29
6.3 Recommended Operating Conditions.....	9	9.1 Documentation Support.....	29
6.4 Thermal Information for Single Channel.....	9	9.2 Receiving Notification of Documentation Updates.....	29
6.5 Thermal Information for Dual Channel.....	10	9.3 Support Resources.....	29
6.6 Thermal Information for Quad Channel.....	10	9.4 Trademarks.....	29
6.7 Electrical Characteristics: $V_S$ (Total Supply Voltage) = $(V_+) - (V_-) = 1.8\text{ V to }5.5\text{ V}$ .....	11	9.5 Electrostatic Discharge Caution.....	29
6.8 Typical Characteristics.....	13	9.6 Glossary.....	29
<b>7 Detailed Description</b> .....	20	<b>10 Revision History</b> .....	29
7.1 Overview.....	20	<b>11 Mechanical, Packaging, and Orderable Information</b> .....	30
7.2 Functional Block Diagram.....	20		

## 4 Device Comparison Table

DEVICE	NO. OF CH.	PACKAGE LEADS												
		SC70 DCK	SOT-23 DBV	SOT-553 <sup>(1)</sup> DRL	X2SON DPW	SOIC D	WSON DSG	VSSOP DGK	TSSOP PW	SOT-23 DDF	VSSOP DGS	X2QFN RUG	X2QFN RUC	WQFN RTE
TLV9051	1	5	5	5	5	—	—	—	—	—	—	—	—	—
TLV9051S		—	6	—	—	—	—	—	—	—	—	—	—	—
TLV9052	2	—	—	—	—	8	8	8	8	8	—	—	—	—
TLV9052S		—	—	—	—	—	—	—	—	—	10	10	—	—
TLV9054	4	—	—	—	—	14	—	—	14	—	—	—	14	16
TLV9054S		—	—	—	—	—	—	—	—	—	—	—	—	16

(1) Package is for preview only.

## 5 Pin Configuration and Functions

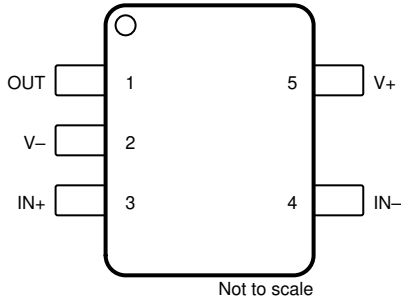

**Figure 5-1. TLV9051 DBV, DRL Packages 5-Pin SOT-23, SOT-553 Top View**

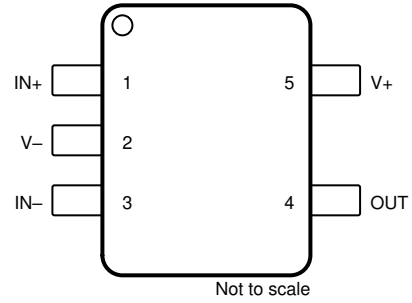

**Figure 5-2. TLV9051 DCK Package 5-Pin SC70 Top View**

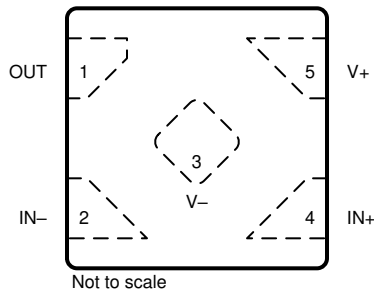

**Figure 5-3. TLV9051 DPW Package 5-Pin X2SON Top View**

**Table 5-1. Pin Functions: TLV9051**

NAME	PIN			I/O	DESCRIPTION
	SOT-23, SOT-553	SC-70	X2SON		
IN-	4	3	2	I	Inverting input
IN+	3	1	4	I	Noninverting input
OUT	1	4	1	O	Output
V-	2	2	3	—	Negative (low) supply or ground (for single-supply operation)
V+	5	5	5	—	Positive (high) supply

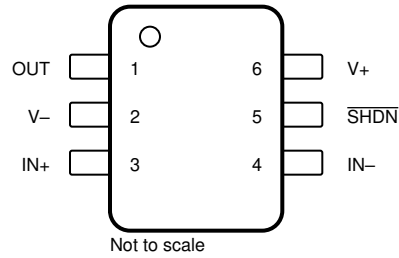

**Figure 5-4. TLV9051S DBV Package 6-Pin SOT-23 Top View**

**Table 5-2. Pin Functions: TLV9051S**

PIN		I/O	DESCRIPTION
NAME	NO.		
-IN	4	I	Inverting input
+IN	3	I	Noninverting input
OUT	1	O	Output
SHDN	5	I	Shutdown: low = amp disabled, high = amp enabled. See <a href="#">Section 7.3.9</a> for more information.
V-	2	—	Negative (lowest) supply or ground (for single-supply operation).
V+	6	—	Positive (highest) supply



**Figure 5-5. TLV9052 D, DGK, PW, DDF Packages 8-Pin SOIC, VSSOP, TSSOP, SOT-23 Top View**



Connect exposed thermal pad to V-. See [Section 7.3.6](#) for more information.

**Figure 5-6. TLV9052 DSG Package 8-Pin WSON With Exposed Thermal Pad Top View**

**Table 5-3. Pin Functions: TLV9052**

PIN		I/O	DESCRIPTION
NAME	NO.		
IN1-	2	I	Inverting input, channel 1
IN1+	3	I	Noninverting input, channel 1
IN2-	6	I	Inverting input, channel 2
IN2+	5	I	Noninverting input, channel 2
OUT1	1	O	Output, channel 1
OUT2	7	O	Output, channel 2
V-	4	—	Negative (low) supply or ground (for single-supply operation)
V+	8	—	Positive (high) supply



Figure 5-7. TLV9052S DGS Package 10-Pin VSSOP Top View



Figure 5-8. TLV9052S RUG Package 10-Pin X2QFN Top View

Table 5-4. Pin Functions: TLV9052S

NAME	PIN		I/O	DESCRIPTION
	VSSOP	X2QFN		
IN1-	2	9	I	Inverting input, channel 1
IN1+	3	10	I	Noninverting input, channel 1
IN2-	8	5	I	Inverting input, channel 2
IN2+	7	4	I	Noninverting input, channel 2
OUT1	1	8	O	Output, channel 1
OUT2	9	6	O	Output, channel 2
SHDN1	5	2	I	Shutdown: low = amp disabled, high = amp enabled, channel 1. See <a href="#">Section 7.3.9</a> for more information.
SHDN2	6	3	I	Shutdown: low = amp disabled, high = amp enabled, channel 2. See <a href="#">Section 7.3.9</a> for more information.
V-	4	1	—	Negative (low) supply or ground (for single-supply operation)
V+	10	7	—	Positive (high) supply

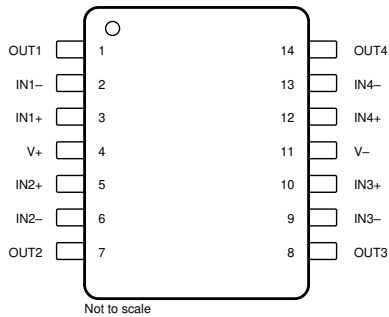

**Figure 5-9. TLV9054 D, PW Packages 14-Pin SOIC, TSSOP Top View**

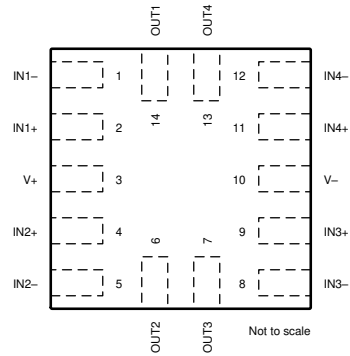

**Figure 5-10. TLV9054 RUC Package 14-Pin X2QFN Top View**

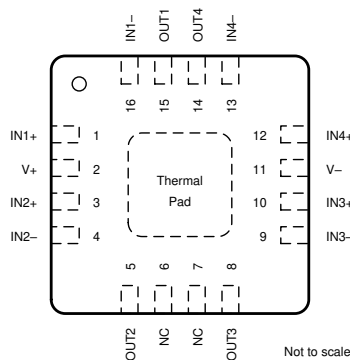

Connect exposed thermal pad to V-. See [Section 7.3.6](#) for more information.

**Figure 5-11. TLV9054 RTE Package 16-Pin WQFN With Exposed Thermal Pad Top View**

**Table 5-5. Pin Functions: TLV9054**

NAME	PIN			I/O	DESCRIPTION
	SOIC, TSSOP	WQFN	X2QFN		
IN1-	2	16	1	I	Inverting input, channel 1
IN1+	3	1	2	I	Noninverting input, channel 1
IN2-	6	4	5	I	Inverting input, channel 2
IN2+	5	3	4	I	Noninverting input, channel 2
IN3-	9	9	8	I	Inverting input, channel 3
IN3+	10	10	9	I	Noninverting input, channel 3
IN4-	13	13	12	I	Inverting input, channel 4
IN4+	12	12	11	I	Noninverting input, channel 4
NC	—	6, 7	—	—	No internal connection
OUT1	1	15	14	O	Output, channel 1
OUT2	7	5	6	O	Output, channel 2
OUT3	8	8	7	O	Output, channel 3
OUT4	14	14	13	O	Output, channel 4
V-	11	11	10	—	Negative (low) supply or ground (for single-supply operation)
V+	4	2	3	—	Positive (high) supply



Connect exposed thermal pad to V-. See [Section 7.3.6](#) for more information.

**Figure 5-12. TLV9054S RTE Package 16-Pin WQFN With Exposed Thermal Pad Top View**

**Table 5-6. Pin Functions: TLV9054S**

PIN		I/O	DESCRIPTION
NAME	NO.		
IN1+	1	I	Noninverting input, channel 1
IN1-	16	I	Inverting input, channel 1
IN2+	3	I	Noninverting input, channel 2
IN2-	4	I	Inverting input, channel 2
IN3+	10	I	Noninverting input, channel 3
IN3-	9	I	Inverting input, channel 3
IN4+	12	I	Noninverting input, channel 4
IN4-	13	I	Inverting input, channel 4
SHDN12	6	I	Shutdown: low = amp disabled, high = amp enabled, channel 1 and 2. See <a href="#">Section 7.3.9</a> for more information.
SHDN34	7	I	Shutdown: low = amp disabled, high = amp enabled, channel 3 and 4. See <a href="#">Section 7.3.9</a> for more information.
OUT1	15	O	Output, channel 1
OUT2	5	O	Output, channel 2
OUT3	8	O	Output, channel 3
OUT4	14	O	Output, channel 4
V-	11	—	Negative (low) supply or ground (for single-supply operation)
V+	2	—	Positive (high) supply

## 6 Specifications

### 6.1 Absolute Maximum Ratings

over operating free-air temperature (unless otherwise noted)<sup>(1)</sup>

		MIN	MAX	UNIT	
Supply voltage			7	V	
Signal input pins	Voltage <sup>(2)</sup>	Common-mode	(V-) – 0.5	(V+) + 0.5	V
		Differential		(V+) – (V-) + 0.2	
	Current <sup>(2)</sup>	–10	10	mA	
Output short-circuit <sup>(3)</sup>		Continuous		mA	
Temperature	Specified, T <sub>A</sub>	–40	125	°C	
	Junction, T <sub>J</sub>		150		
	Storage, T <sub>stg</sub>	–65	150		

- (1) Stresses beyond those listed under *Absolute Maximum Ratings* may cause permanent damage to the device. These are stress ratings only, and functional operation of the device at these or any other conditions beyond those indicated under *Recommended Operating Conditions* is not implied. Exposure to absolute-maximum-rated conditions for extended periods may affect device reliability.
- (2) Input pins are diode-clamped to the power-supply rails. Current limit input signals that can swing more than 0.5 V beyond the supply rails to 10 mA or less.
- (3) Short-circuit to ground, one amplifier per package.

### 6.2 ESD Ratings

			VALUE	UNIT
<b>TLV9051 X2SON PACKAGE</b>				
V <sub>(ESD)</sub>	Electrostatic discharge	Human-body model (HBM), per ANSI/ESDA/JEDEC JS-001 <sup>(1)</sup>	±3000	V
		Charged-device model (CDM), per JEDEC specification JESD22-C101 <sup>(2)</sup>	±1500	
<b>ALL OTHER PACKAGES</b>				
V <sub>(ESD)</sub>	Electrostatic discharge	Human-body model (HBM), per ANSI/ESDA/JEDEC JS-001 <sup>(1)</sup>	±4000	V
		Charged-device model (CDM), per JEDEC specification JESD22-C101 <sup>(2)</sup>	±1500	

- (1) JEDEC document JEP155 states that 500-V HBM allows safe manufacturing with a standard ESD control process.
- (2) JEDEC document JEP157 states that 250-V CDM allows safe manufacturing with a standard ESD control process.

### 6.3 Recommended Operating Conditions

over operating junction temperature range (unless otherwise noted)

		MIN	MAX	UNIT
V <sub>S</sub>	Supply voltage, V <sub>S</sub> = (V+) – (V–)	1.8	6.0	V
V <sub>IN</sub>	Input pin voltage	(V–) – 0.1	(V+) + 0.1	V
	Specified temperature	–40	125	°C

### 6.4 Thermal Information for Single Channel

THERMAL METRIC <sup>(1)</sup>	TLV9051, TLV9051S					UNIT	
	DPW (X2SON)	DBV (SOT-23)		DCK (SC70)	DRL (SOT553) <sup>(2)</sup>		
	5 PINS	5 PINS	6 PINS	5 PINS	5 PINS		
R <sub>θJA</sub>	Junction-to-ambient thermal resistance	470.0	228.1	210.8	231.2	TBD	°C/W
R <sub>θJC(top)</sub>	Junction-to-case(top) thermal resistance	211.9	152.1	152.1	144.4	TBD	°C/W
R <sub>θJB</sub>	Junction-to-board thermal resistance	334.8	97.7	92.3	78.6	TBD	°C/W
ψ <sub>JT</sub>	Junction-to-top characterization parameter	29.8	74.1	76.2	51.3	TBD	°C/W

### 6.4 Thermal Information for Single Channel (continued)

THERMAL METRIC <sup>(1)</sup>	TLV9051, TLV9051S					UNIT
	DPW (X2SON)	DBV (SOT-23)		DCK (SC70)	DRL (SOT553) <sup>(2)</sup>	
	5 PINS	5 PINS	6 PINS	5 PINS	5 PINS	
$\Psi_{JB}$ Junction-to-board characterization parameter	333.2	97.3	92.1	78.3	TBD	°C/W
$R_{\theta JC(bot)}$ Junction-to-case(bottom) thermal resistance	N/A	N/A	N/A	N/A	TBD	°C/W

(1) For more information about traditional and new thermal metrics, see the [Semiconductor and IC Package Thermal Metrics](#) application report.

(2) This package option is for preview only.

### 6.5 Thermal Information for Dual Channel

THERMAL METRIC <sup>(1)</sup>	TLV9052, TLV9052S							UNIT
	D (SOIC)	DGK (VSSOP)	DSG (WSON)	PW (TSSOP)	DDF (SOT-23)	DGS (VSSOP)	RUG (X2QFN)	
	8 PINS	8 PINS	8 PINS	8 PINS	8 PINS	10 PINS	10 PINS	
$R_{\theta JA}$ Junction-to-ambient thermal resistance	155.4	208.8	102.3	205.1	184.4	170.4	197.2	°C/W
$R_{\theta JC(top)}$ Junction-to-case(top) thermal resistance	95.5	93.3	120.0	93.7	112.8	84.9	93.3	°C/W
$R_{\theta JB}$ Junction-to-board thermal resistance	98.9	130.7	68.2	135.7	99.9	113.5	123.8	°C/W
$\Psi_{JT}$ Junction-to-top characterization parameter	41.9	26.1	15.1	25.0	18.7	16.4	3.7	°C/W
$\Psi_{JB}$ Junction-to-board characterization parameter	98.1	128.9	68.2	134.0	99.3	112.3	120.2	°C/W
$R_{\theta JC(bot)}$ Junction-to-case(bottom) thermal resistance	N/A	N/A	43.6	N/A	N/A	N/A	N/A	°C/W

(1) For more information about traditional and new thermal metrics, see the [Semiconductor and IC Package Thermal Metrics](#) application report.

### 6.6 Thermal Information for Quad Channel

THERMAL METRIC <sup>(1)</sup>	TLV9054, TLV9054S					UNIT
	D (SOIC)	PW (TSSOP)	RTE (WQFN)		RUC (X2SQFN)	
	14 PINS	14 PINS	14 PINS	16 PINS	14 PINS	
$R_{\theta JA}$ Junction-to-ambient thermal resistance	115.0	147.2	65.5	65.6	209.4	°C/W
$R_{\theta JC(top)}$ Junction-to-case(top) thermal resistance	71.1	67.2	70.6	70.6	68.8	°C/W
$R_{\theta JB}$ Junction-to-board thermal resistance	71.0	91.6	40.5	40.5	153.3	°C/W
$\Psi_{JT}$ Junction-to-top characterization parameter	29.7	16.6	5.8	5.8	3.0	°C/W
$\Psi_{JB}$ Junction-to-board characterization parameter	70.6	90.7	40.5	40.5	152.8	°C/W
$R_{\theta JC(bot)}$ Junction-to-case(bottom) thermal resistance	N/A	N/A	24.5	24.5	N/A	°C/W

(1) For more information about traditional and new thermal metrics, see the [Semiconductor and IC Package Thermal Metrics](#) application report.

## 6.7 Electrical Characteristics: $V_S$ (Total Supply Voltage) = $(V+) - (V-) = 1.8\text{ V to }5.5\text{ V}$

at  $T_A = 25^\circ\text{C}$ ,  $R_L = 10\text{ k}\Omega$  connected to  $V_S / 2$ ,  $V_{CM} = V_S / 2$ , and  $V_{OUT} = V_S / 2$  (unless otherwise noted);

PARAMETER		TEST CONDITIONS	MIN	TYP	MAX	UNIT
<b>OFFSET VOLTAGE</b>						
$V_{OS}$	Input offset voltage	$V_S = 5\text{ V}$		$\pm 0.33$	$\pm 1.6$	mV
		$V_S = 5\text{ V}$ , $T_A = -40^\circ\text{C to }+125^\circ\text{C}$			$\pm 2$	
$dV_{OS}/dT$	Drift	$V_S = 5\text{ V}$ , $T_A = -40^\circ\text{C to }+125^\circ\text{C}$		$\pm 0.5$		$\mu\text{V}/^\circ\text{C}$
PSRR	Power-supply rejection ratio	$V_S = 1.8\text{ V} - 5.5\text{ V}$ , $V_{CM} = (V-)$		$\pm 13$	$\pm 80$	$\mu\text{V}/\text{V}$
	Channel separation, dc	At dc		115		dB
<b>INPUT VOLTAGE RANGE</b>						
$V_{CM}$	Common-mode voltage	$V_S = 1.8\text{ V to }5.5\text{ V}$	$(V-) - 0.1$		$(V+) + 0.1$	V
CMRR	Common-mode rejection ratio	$V_S = 5.5\text{ V}$ , $(V-) - 0.1\text{ V} < V_{CM} < (V+) - 1.4\text{ V}$ , $T_A = -40^\circ\text{C to }+125^\circ\text{C}$	80	96		dB
		$V_S = 5.5\text{ V}$ , $V_{CM} = -0.1\text{ V to }5.6\text{ V}$ , $T_A = -40^\circ\text{C to }+125^\circ\text{C}$	62	79		
		$V_S = 1.8\text{ V}$ , $(V-) - 0.1\text{ V} < V_{CM} < (V+) - 1.4\text{ V}$ , $T_A = -40^\circ\text{C to }+125^\circ\text{C}$		88		
		$V_S = 1.8\text{ V}$ , $V_{CM} = -0.1\text{ V to }1.9\text{ V}$ , $T_A = -40^\circ\text{C to }+125^\circ\text{C}$		72		
<b>INPUT BIAS CURRENT</b>						
$I_B$	Input bias current			$\pm 2$	$\pm 18^{(2)}$	pA
		$T_A = -40^\circ\text{C to }+125^\circ\text{C}$				$\pm 525^{(2)}$
$I_{OS}$	Input offset current			$\pm 1$	$\pm 15^{(2)}$	pA
		$T_A = -40^\circ\text{C to }+125^\circ\text{C}$				$\pm 440^{(2)}$
<b>NOISE</b>						
$E_n$	Input voltage noise (peak-to-peak)	$V_S = 5\text{ V}$ , $f = 0.1\text{ Hz to }10\text{ Hz}$		6		$\mu\text{V}_{PP}$
$e_n$	Input voltage noise density	$V_S = 5\text{ V}$ , $f = 10\text{ kHz}$		15		$\text{nV}/\sqrt{\text{Hz}}$
		$V_S = 5\text{ V}$ , $f = 1\text{ kHz}$		20		$\text{nV}/\sqrt{\text{Hz}}$
$i_n$	Input current noise density	$f = 1\text{ kHz}$		18		$\text{fA}/\sqrt{\text{Hz}}$
<b>INPUT CAPACITANCE</b>						
$C_{ID}$	Differential			2		pF
$C_{IC}$	Common-mode			4		pF
<b>OPEN-LOOP GAIN</b>						
$A_{OL}$	Open-loop voltage gain	$V_S = 1.8\text{ V}$ , $(V-) + 0.04\text{ V} < V_O < (V+) - 0.04\text{ V}$ , $R_L = 10\text{ k}\Omega$		106		dB
		$V_S = 5.5\text{ V}$ , $(V-) + 0.05\text{ V} < V_O < (V+) - 0.05\text{ V}$ , $R_L = 10\text{ k}\Omega$	104	128		
		$V_S = 1.8\text{ V}$ , $(V-) + 0.06\text{ V} < V_O < (V+) - 0.06\text{ V}$ , $R_L = 2\text{ k}\Omega$		108		
		$V_S = 5.5\text{ V}$ , $(V-) + 0.15\text{ V} < V_O < (V+) - 0.15\text{ V}$ , $R_L = 2\text{ k}\Omega$		130		
<b>FREQUENCY RESPONSE</b>						
GBP	Gain bandwidth product	$V_S = 5.5\text{ V}$ , $G = +1$		5		MHz
$\phi_m$	Phase margin	$V_S = 5.5\text{ V}$ , $G = +1$		60		Degrees
SR	Slew rate	$V_S = 5.5\text{ V}$ , $G = +1$ , $C_L = 130\text{ pF}$		15		$\text{V}/\mu\text{s}$
$t_s$	Settling time	To 0.1%, $V_S = 5.5\text{ V}$ , 2-V step, $G = +1$ , $C_L = 100\text{ pF}$		0.75		$\mu\text{s}$
		To 0.01%, $V_S = 5.5\text{ V}$ , 2-V step, $G = +1$ , $C_L = 100\text{ pF}$		1		
$t_{OR}$	Overload recovery time	$V_S = 5.5\text{ V}$ , $V_{IN} \times \text{gain} > V_S$		0.3		$\mu\text{s}$
THD + N	Total harmonic distortion + noise <sup>(1)</sup>	$V_S = 5.5\text{ V}$ , $V_{CM} = 2.5\text{ V}$ , $V_O = 1\text{ V}_{RMS}$ , $G = +1$ , $f = 1\text{ kHz}$		0.0006%		
<b>OUTPUT</b>						
$V_O$	Voltage output swing from supply rails	$V_S = 5.5\text{ V}$ , $R_L = 10\text{ k}\Omega$ ,			16	mV
		$V_S = 5.5\text{ V}$ , $R_L = 2\text{ k}\Omega$ ,			40	

## 6.7 Electrical Characteristics: $V_S$ (Total Supply Voltage) = $(V+) - (V-) = 1.8\text{ V to }5.5\text{ V}$ (continued)

 at  $T_A = 25^\circ\text{C}$ ,  $R_L = 10\text{ k}\Omega$  connected to  $V_S / 2$ ,  $V_{CM} = V_S / 2$ , and  $V_{OUT} = V_S / 2$  (unless otherwise noted);

PARAMETER		TEST CONDITIONS	MIN	TYP	MAX	UNIT
$I_{SC}$	Short-circuit current	$V_S = 5\text{ V}$		$\pm 50$		mA
$Z_O$	Open-loop output impedance	$V_S = 5\text{ V}$ , $f = 5\text{ MHz}$		250		$\Omega$
<b>POWER SUPPLY</b>						
$I_Q$	Quiescent current per amplifier	$V_S = 5.5\text{ V}$ , $I_O = 0\text{ mA}$ ,		330	450	$\mu\text{A}$
		$V_S = 5.5\text{ V}$ , $I_O = 0\text{ mA}$ , $T_A = -40^\circ\text{C to }+125^\circ\text{C}$			475	
<b>SHUTDOWN</b>						
$I_{QSD}$	Quiescent current per amplifier	$V_S = 1.8\text{ to }5.5\text{ V}$ , all amplifiers disabled, SHDN = $V_-$		0.35	1	$\mu\text{A}$
$Z_{SHDN}$	Output impedance	$V_S = 1.8\text{ to }5.5\text{ V}$ , amplifier disabled		$10 \parallel 2$		$\text{G}\Omega \parallel \text{pF}$
	High-level voltage shutdown threshold (amplifier enabled)	$V_S = 1.8\text{ to }5.5\text{ V}$		$(V_-) + 0.9$	$(V_-) + 1.1$	V
	Low-level voltage shutdown threshold (amplifier disabled)	$V_S = 1.8\text{ to }5.5\text{ V}$	$(V_-) + 0.2$	$(V_-) + 0.7$		V
$t_{ON}$	Amplifier enabled time (full shutdown) <sup>(3) (4)</sup>			35		$\mu\text{S}$
$t_{ON}$	Amplifier enabled time (partial shutdown) <sup>(3) (4)</sup>			10		$\mu\text{S}$
$t_{OFF}$	Amplifier disabled time <sup>(3)</sup>			6		$\mu\text{S}$
	SHDN pin input bias current (per pin)	$V_S = 1.8\text{ V to }5.5\text{ V}$ , $V+ \geq (V+) - 0.8\text{ V}$		6.5		nA
	SHDN pin input bias current (per pin)	$V_S = 1.8\text{ V to }5.5\text{ V}$ , $V+ \leq (V-) + 0.8\text{ V}$		155		nA

- (1) Third-order filter; bandwidth = 80 kHz at -3 dB.
- (2) Specified by design and characterization; not production tested.
- (3) Disable time ( $t_{OFF}$ ) and enable time ( $t_{ON}$ ) are defined as the time interval between the 50% point of the signal applied to the SHDN pin and the point at which the output voltage reaches the 10% (disable) or 90% (enable) level.
- (4) Full shutdown refers to the dual TLV9052S having both channels 1 and 2 disabled (SHDN1 = SHDN2 =  $V_-$ ) and the quad TLV9054S having all channels 1 to 4 disabled (SHDN12 = SHDN34 =  $V_-$ ). For partial shutdown, only one SHDN pin is exercised; in this mode, the internal biasing circuitry remains operational and the enable time is shorter.

## 6.8 Typical Characteristics

at  $T_A = 25^\circ\text{C}$ ,  $V_S = 5.5\text{V}$ ,  $R_L = 10\text{k}\Omega$  connected to  $V_S / 2$ ,  $V_{CM} = V_S / 2$ , and  $V_{OUT} = V_S / 2$  (unless otherwise noted)

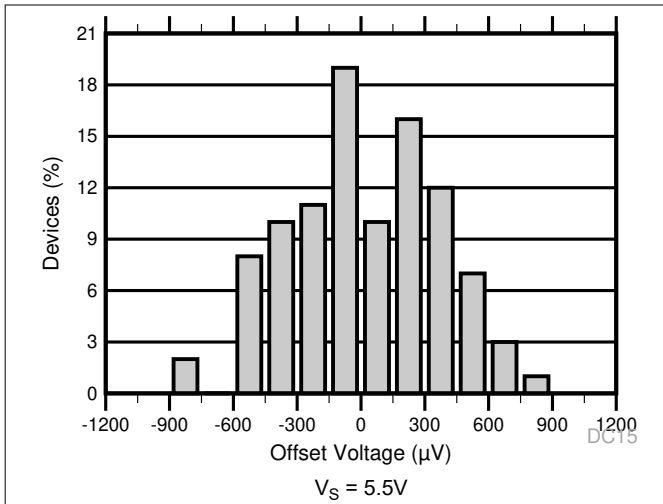

Figure 6-1. Offset Voltage Production Distribution

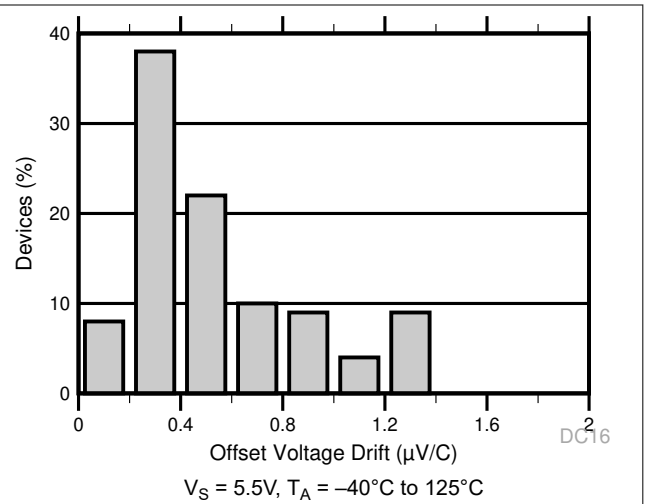

Figure 6-2. Offset Voltage Drift Distribution

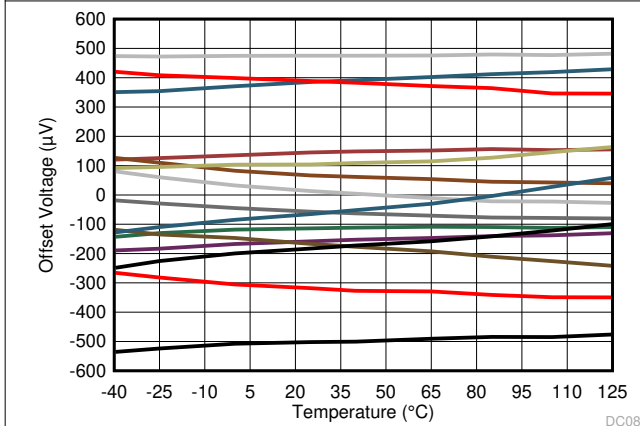

Figure 6-3. Offset Voltage vs Temperature

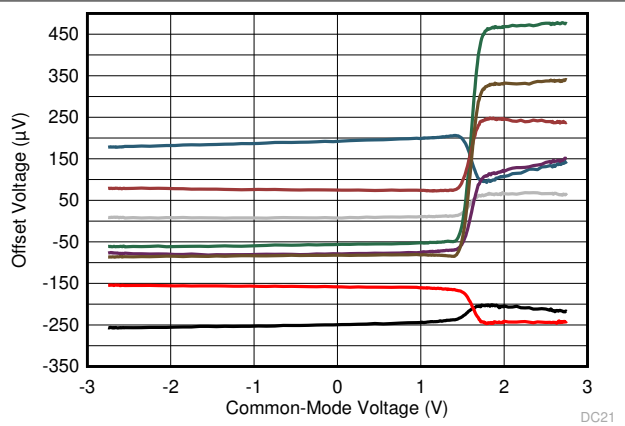

Figure 6-4. Offset Voltage vs Common-Mode Voltage

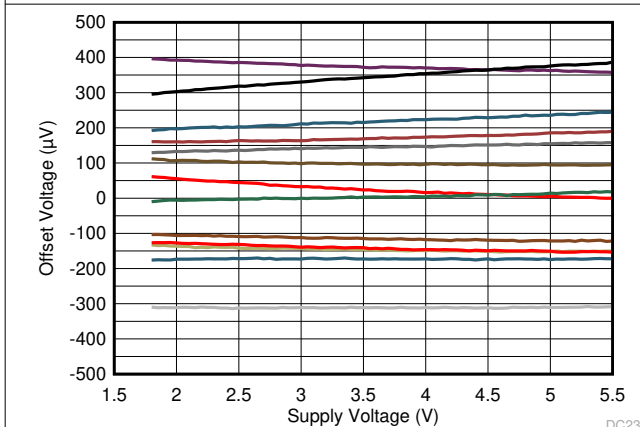

Figure 6-5. Offset Voltage vs Power Supply

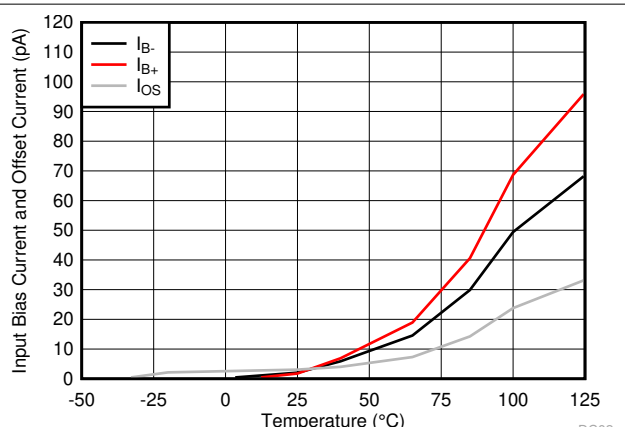
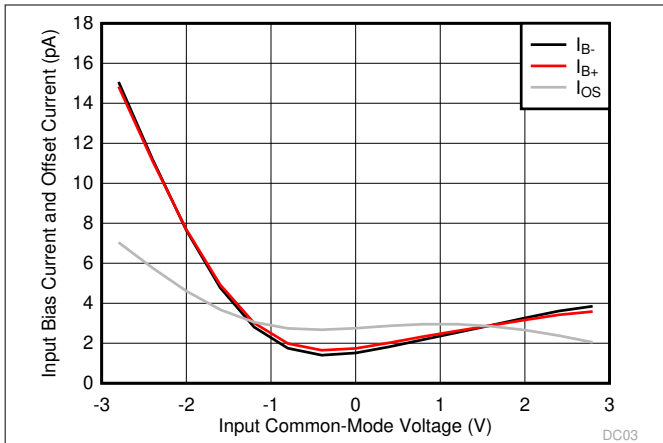

Figure 6-6. Input Bias Current vs Temperature

### 6.8 Typical Characteristics (continued)

at  $T_A = 25^\circ\text{C}$ ,  $V_S = 5.5\text{V}$ ,  $R_L = 10\text{k}\Omega$  connected to  $V_S / 2$ ,  $V_{CM} = V_S / 2$ , and  $V_{OUT} = V_S / 2$  (unless otherwise noted)



**Figure 6-7. Input Bias Current and Offset Current vs Common-Mode Voltage**

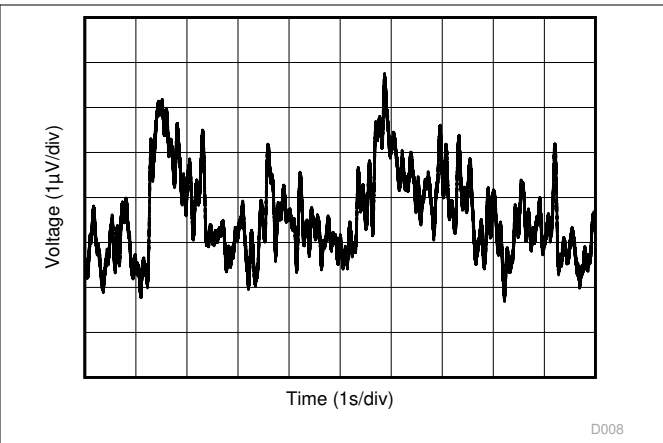

**Figure 6-8. 0.1-Hz to 10-Hz Input Voltage Noise**

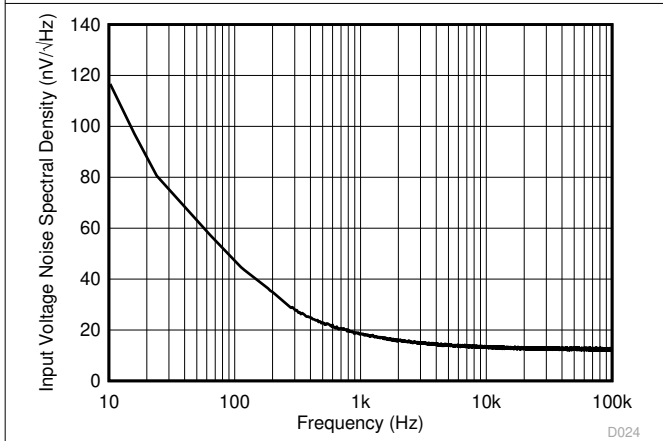

**Figure 6-9. Input Voltage Noise Spectral Density vs Frequency**

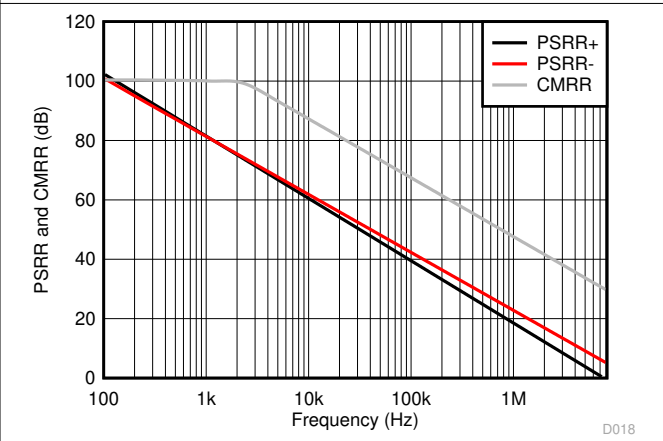

**Figure 6-10. CMRR and PSRR vs Frequency (Referred to Input)**

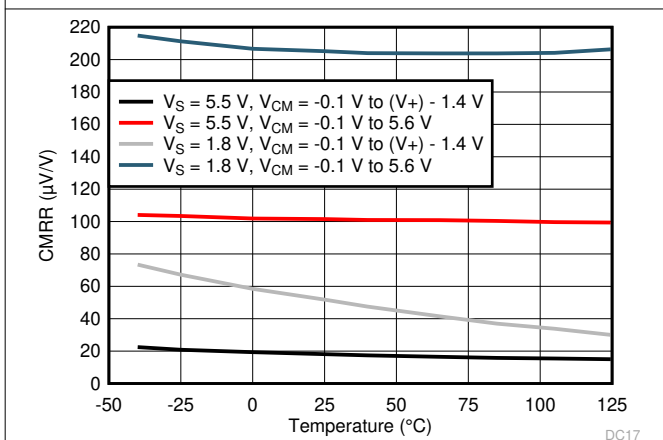

**Figure 6-11. CMRR vs Temperature**

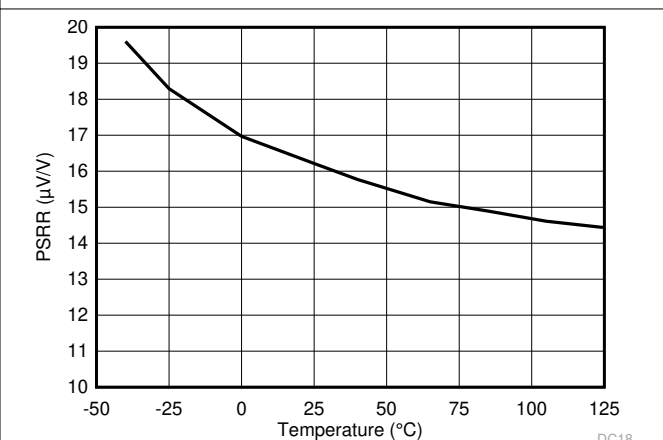

**Figure 6-12. PSRR vs Temperature**  
 $V_S = 1.8\text{V to } 5.5\text{V}$

## 6.8 Typical Characteristics (continued)

at  $T_A = 25^\circ\text{C}$ ,  $V_S = 5.5\text{V}$ ,  $R_L = 10\text{k}\Omega$  connected to  $V_S / 2$ ,  $V_{CM} = V_S / 2$ , and  $V_{OUT} = V_S / 2$  (unless otherwise noted)

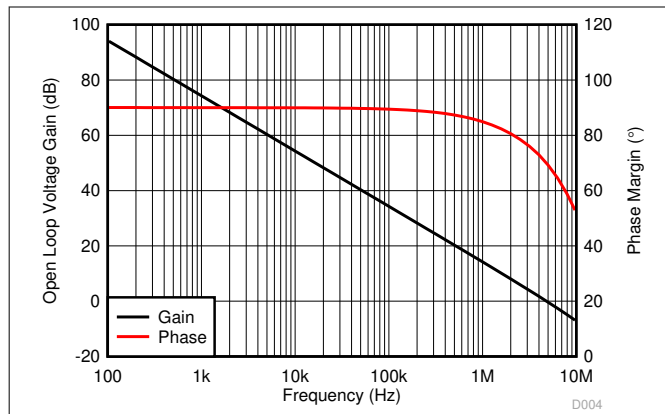

**Figure 6-13. Open Loop Voltage Gain and Phase vs Frequency**

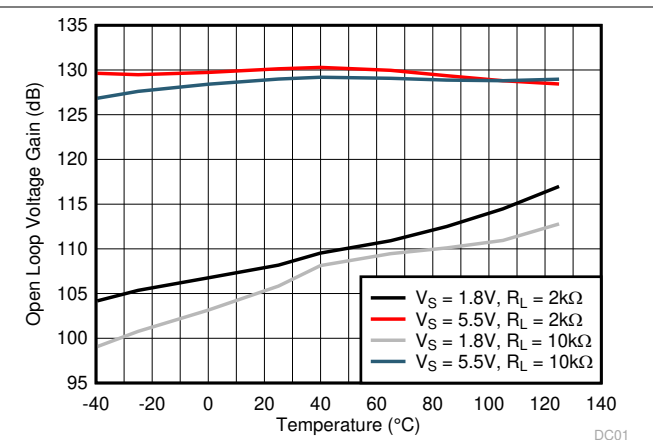

**Figure 6-14. Open Loop Voltage Gain vs Temperature**

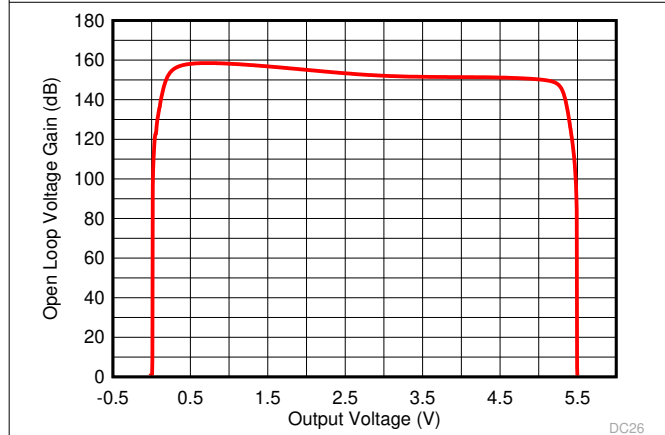

**Figure 6-15. Open Loop Voltage Gain vs Output Voltage**

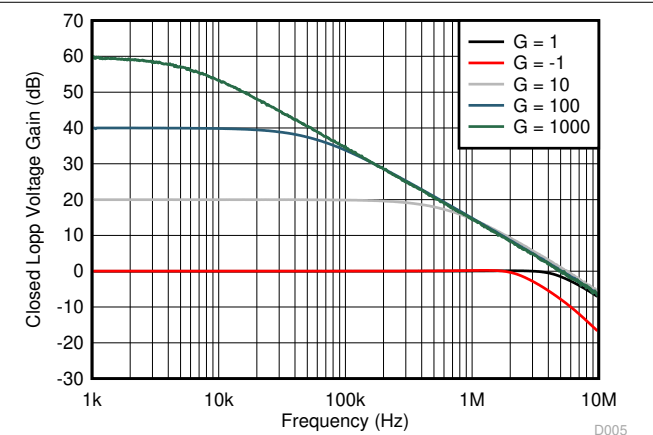

**Figure 6-16. Closed Loop Voltage Gain vs Frequency**

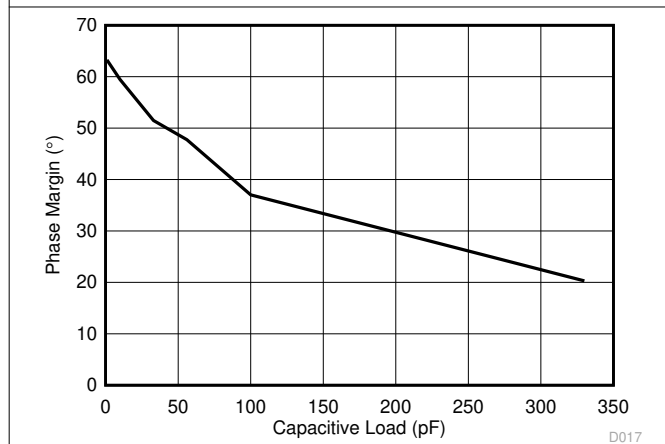

**Figure 6-17. Phase Margin vs Capacitive Load**

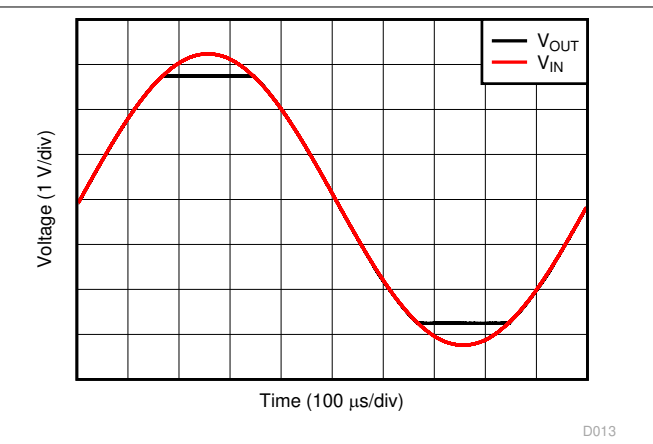

**Figure 6-18. No Phase Reversal**

### 6.8 Typical Characteristics (continued)

at  $T_A = 25^\circ\text{C}$ ,  $V_S = 5.5\text{V}$ ,  $R_L = 10\text{k}\Omega$  connected to  $V_S / 2$ ,  $V_{CM} = V_S / 2$ , and  $V_{OUT} = V_S / 2$  (unless otherwise noted)

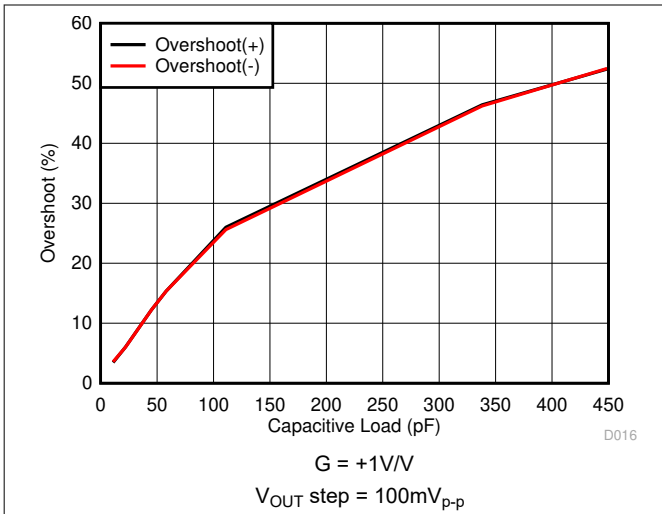

Figure 6-19. Small-Signal Overshoot vs Load Capacitance

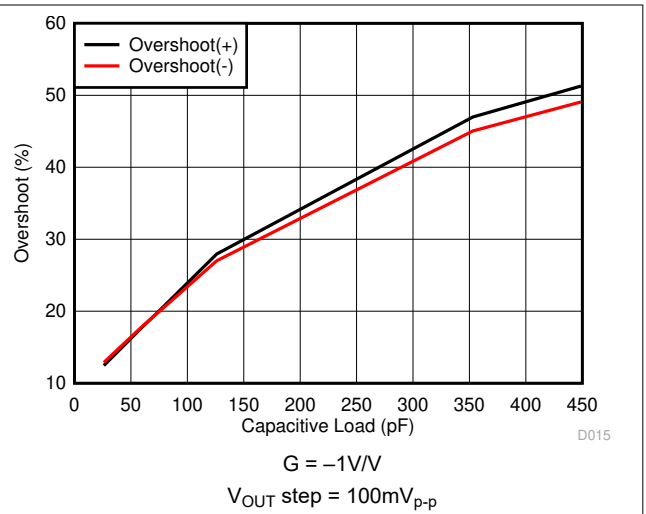

Figure 6-20. Small-Signal Overshoot vs Load Capacitance

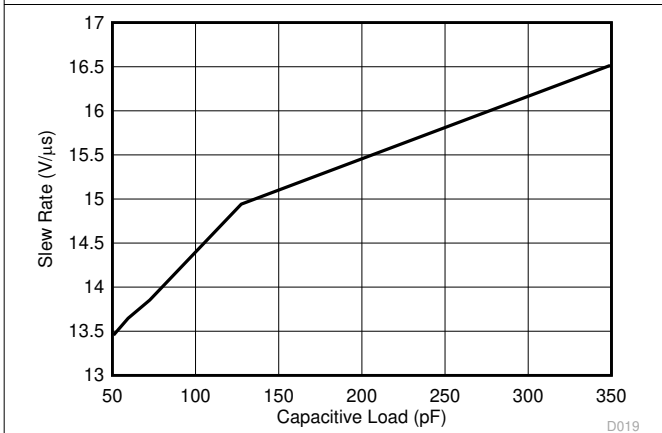

Figure 6-21. Slew Rate vs Capacitive Load

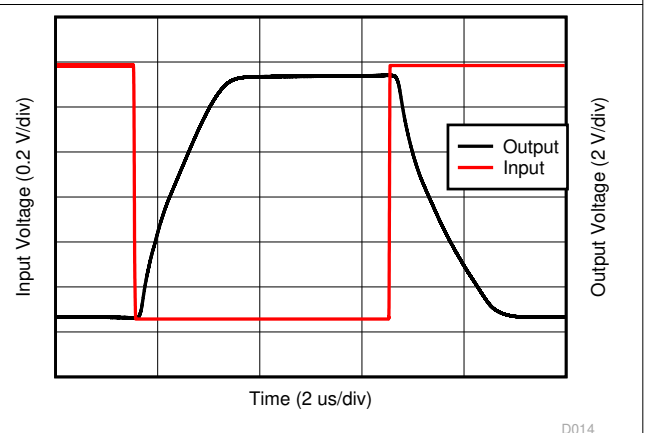

Figure 6-22. Overload Recovery

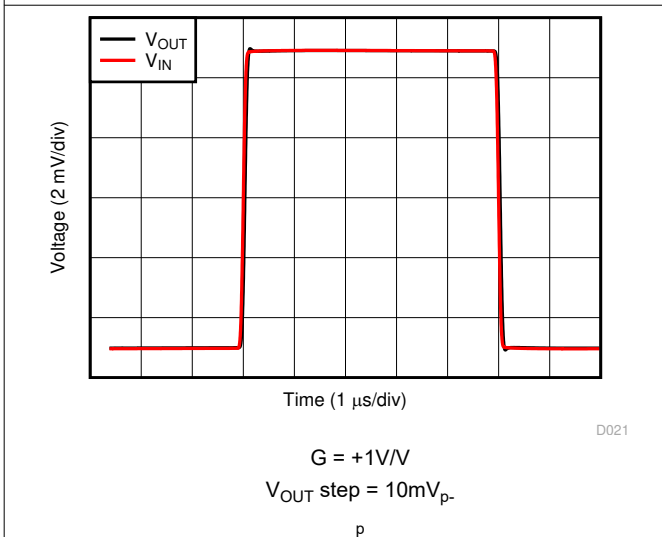

Figure 6-23. Small-Signal Step Response

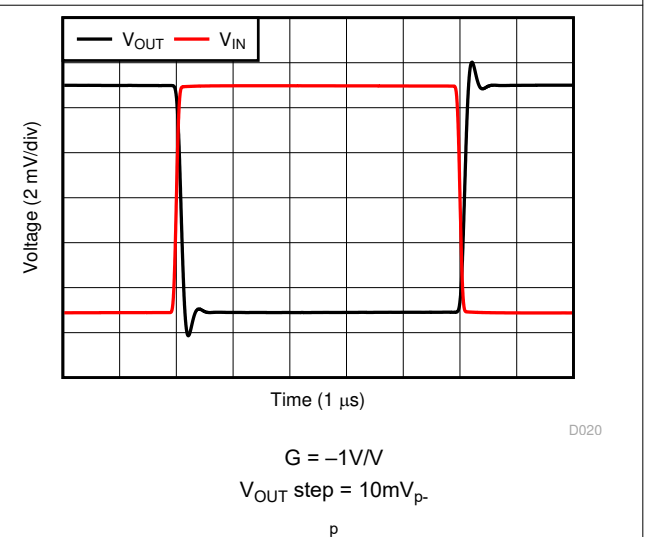
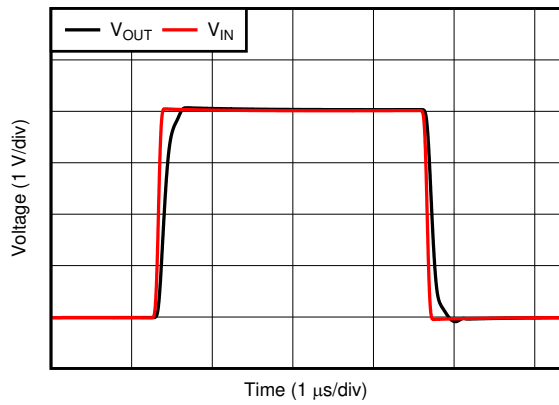

Figure 6-24. Small-Signal Step Response

### 6.8 Typical Characteristics (continued)

at  $T_A = 25^\circ\text{C}$ ,  $V_S = 5.5\text{V}$ ,  $R_L = 10\text{k}\Omega$  connected to  $V_S / 2$ ,  $V_{CM} = V_S / 2$ , and  $V_{OUT} = V_S / 2$  (unless otherwise noted)



$G = +1\text{V/V}$   
 $V_{OUT}$  step =  $4V_{p-p}$

**Figure 6-25. Large-Signal Step Response**



$G = -1\text{V/V}$   
 $V_{OUT}$  step =  $4V_{p-p}$

**Figure 6-26. Large-Signal Step Response**

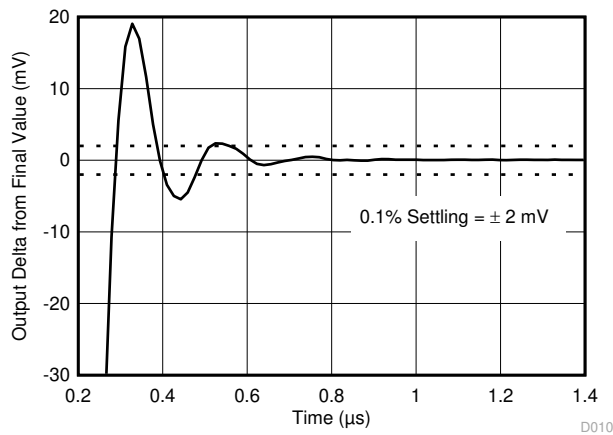

$C_L = 100\text{pF}$        $G = +1\text{V/V}$   
**Figure 6-27. Positive Large-Signal Settling Time**

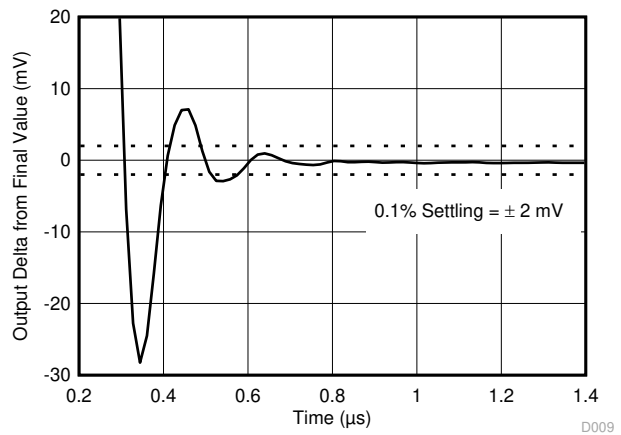

$C_L = 100\text{pF}$        $G = +1\text{V/V}$   
**Figure 6-28. Negative Large-Signal Settling Time**

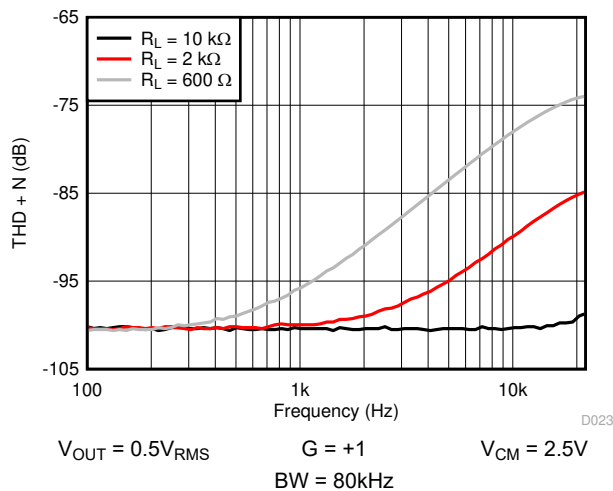

**Figure 6-29. THD + N vs Frequency**

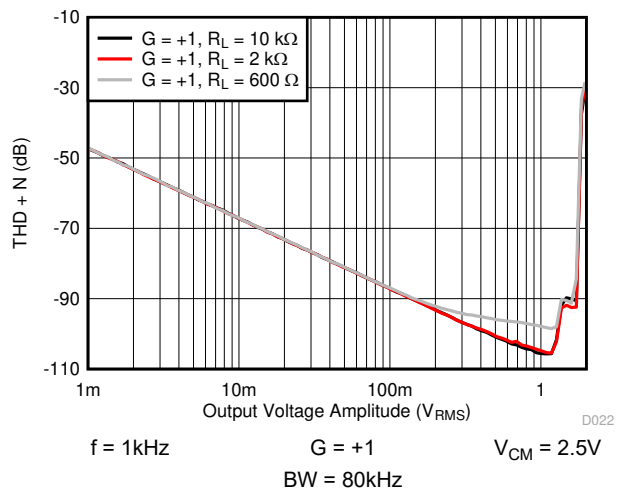

**Figure 6-30. THD + N vs Amplitude**

### 6.8 Typical Characteristics (continued)

at  $T_A = 25^\circ\text{C}$ ,  $V_S = 5.5\text{V}$ ,  $R_L = 10\text{k}\Omega$  connected to  $V_S / 2$ ,  $V_{CM} = V_S / 2$ , and  $V_{OUT} = V_S / 2$  (unless otherwise noted)

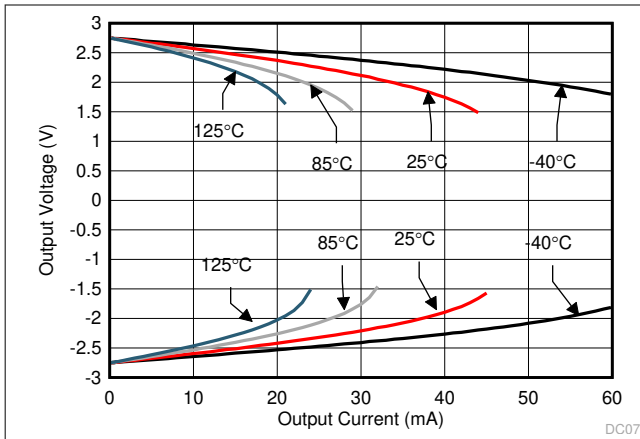

Figure 6-31. Output Voltage Swing vs Output Current

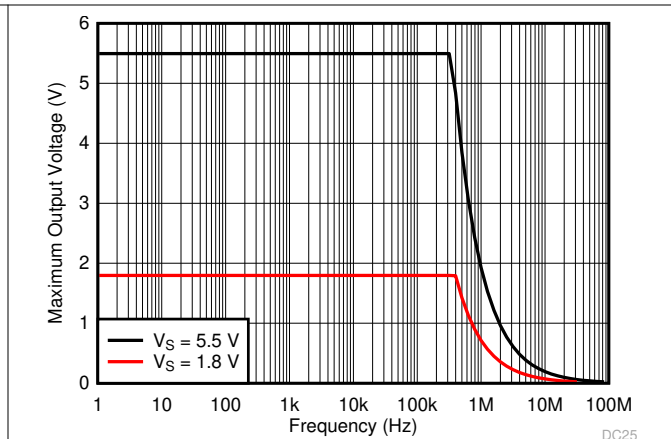

Figure 6-32. Maximum Output Voltage vs Frequency and Supply Voltage

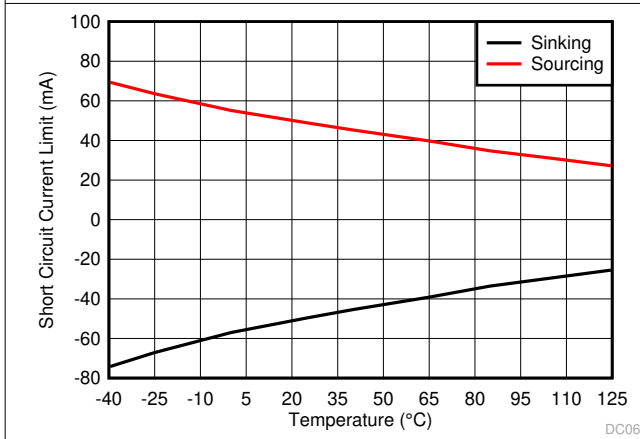

Figure 6-33. Short-Circuit Current vs Temperature

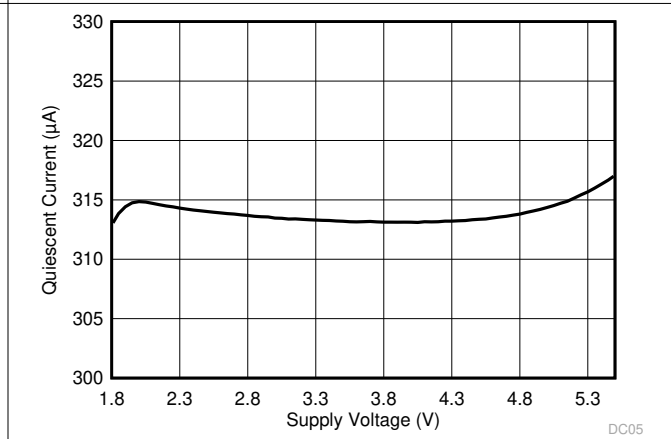

Figure 6-34. Quiescent Current vs Supply Voltage

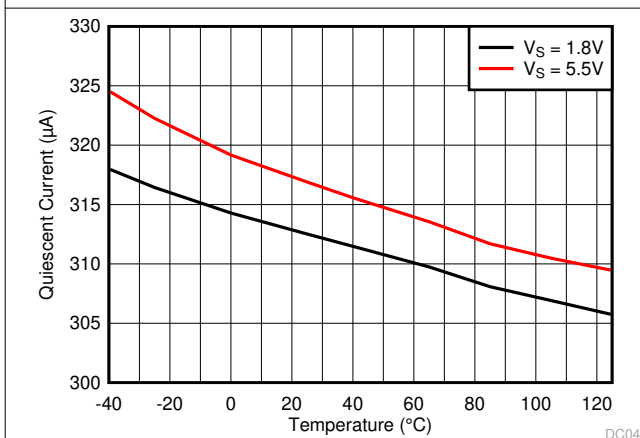

Figure 6-35. Quiescent Current vs Temperature

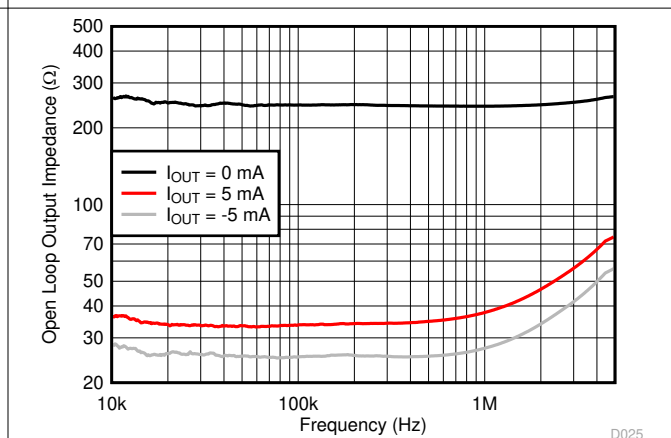
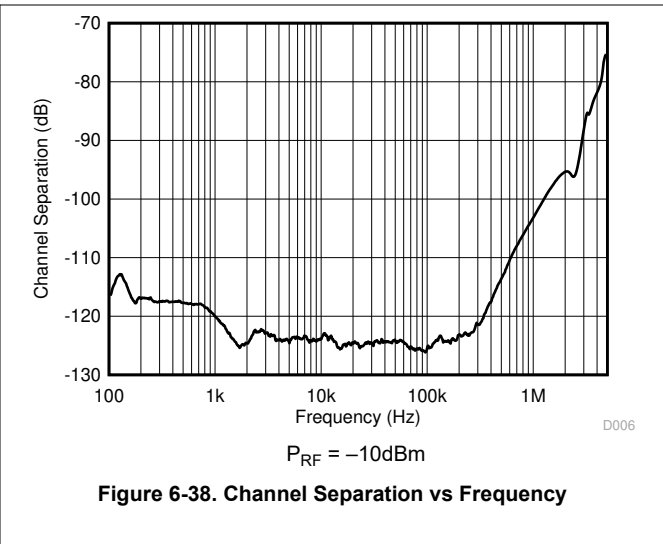
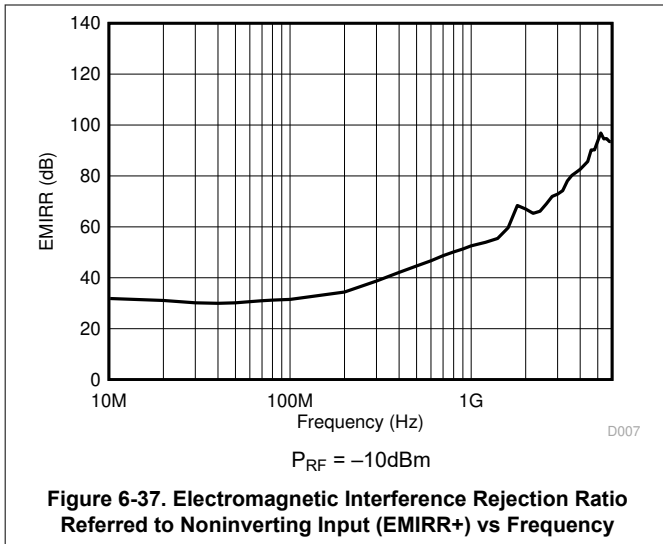

Figure 6-36. Open-Loop Output Impedance vs Frequency

### 6.8 Typical Characteristics (continued)

at  $T_A = 25^\circ\text{C}$ ,  $V_S = 5.5\text{V}$ ,  $R_L = 10\text{k}\Omega$  connected to  $V_S / 2$ ,  $V_{CM} = V_S / 2$ , and  $V_{OUT} = V_S / 2$  (unless otherwise noted)



## 7 Detailed Description

### 7.1 Overview

The TLV905x devices are a 5MHz family of low-power, rail-to-rail input and output op amps. These devices operate from 1.8V to 5.5V, are unity-gain stable, and are designed for a wide range of general-purpose applications. The input common-mode voltage range includes both rails and allows the TLV905x family to be used in virtually any single-supply application. The unique combination of a high slew rate and low quiescent current makes this family a potential choice for battery-powered motor-drive applications. Rail-to-rail input and output swing significantly increase dynamic range, especially in low-supply applications.

### 7.2 Functional Block Diagram



## 7.3 Feature Description

### 7.3.1 Operating Voltage

The TLV905x family of op amps is specified for operation from 1.8V to 6.0V. In addition, many specifications apply from  $-40^{\circ}\text{C}$  to  $125^{\circ}\text{C}$ . Parameters that vary significantly with operating voltages or temperature are illustrated in the [Section 6.8](#).

### 7.3.2 Rail-to-Rail Input

The input common-mode voltage range of the TLV905x family extends 100mV beyond the supply rails for the full supply voltage range of 1.8V to 6.0V. This performance is achieved with a complementary input stage: an N-channel input differential pair in parallel with a P-channel differential pair, as shown in the [Section 7.2](#). The N-channel pair is active for input voltages close to the positive rail, typically  $(V+) - 1.4\text{V}$  to 200mV above the positive supply, whereas the P-channel pair is active for inputs from 200mV below the negative supply to approximately  $(V+) - 1.4\text{V}$ . There is a small transition region, typically  $(V+) - 1.2\text{V}$  to  $(V+) - 1\text{V}$ , in which both pairs are on. This 200-mV transition region can vary up to 200mV with process variation. Thus, the transition region (with both stages on) can range from  $(V+) - 1.4\text{V}$  to  $(V+) - 1.2\text{V}$  on the low end, and up to  $(V+) - 1\text{V}$  to  $(V+) - 0.8\text{V}$  on the high end. Within this transition region, PSRR, CMRR, offset voltage, offset drift, and THD can degrade compared to device operation outside this region.

### 7.3.3 Rail-to-Rail Output

Designed as low-power, low-voltage operational amplifiers, the TLV905x family delivers a robust output drive capability. A class AB output stage with common-source transistors achieves full rail-to-rail output swing capability. For resistive loads of  $10\text{k}\Omega$ , the output swings to within 16mV of either supply rail, regardless of the applied power-supply voltage. Different load conditions change the ability of the amplifier to swing close to the rails.

### 7.3.4 EMI Rejection

The TLV905x uses integrated electromagnetic interference (EMI) filtering to reduce the effects of EMI from sources such as wireless communications and densely-populated boards with a mix of analog signal chain and digital components. EMI immunity can be improved with circuit design techniques; the TLV905x benefits from these design improvements. Texas Instruments has developed the ability to accurately measure and quantify the immunity of an operational amplifier over a broad frequency spectrum extending from 10MHz to 6GHz. [Figure 7-1](#) shows the results of this testing on the TLV905x. [Table 7-1](#) shows the EMIRR IN+ values for the TLV905x at particular frequencies commonly encountered in real-world applications. The [EMI Rejection Ratio of Operational Amplifiers](#) application report contains detailed information on the topic of EMIRR performance as it relates to op amps and is available for download from [www.ti.com](http://www.ti.com).

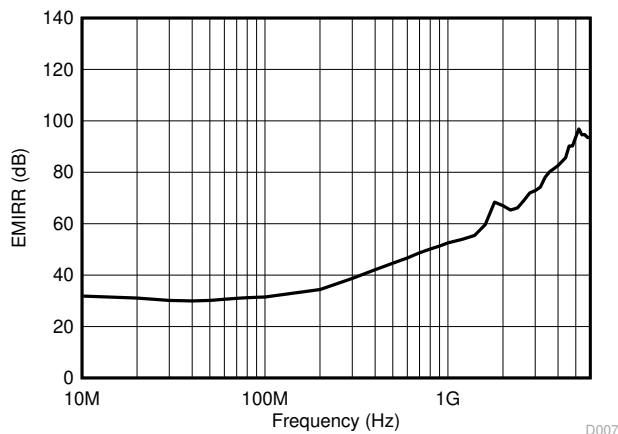

**Figure 7-1. EMIRR Testing**

**Table 7-1. TLV905x EMIRR IN+ for Frequencies of Interest**

FREQUENCY	APPLICATION OR ALLOCATION	EMIRR IN+
400MHz	Mobile radio, mobile satellite, space operation, weather, radar, ultra-high frequency (UHF) applications	41.8dB
900MHz	Global system for mobile communications (GSM) applications, radio communication, navigation, GPS (to 1.6GHz), GSM, aeronautical mobile, UHF applications	53.1dB
1.8GHz	GSM applications, mobile personal communications, broadband, satellite, L-band (1GHz to 2GHz)	71.8dB
2.4GHz	802.11b, 802.11g, 802.11n, Bluetooth®, mobile personal communications, industrial, scientific and medical (ISM) radio band, amateur radio and satellite, S-band (2GHz to 4GHz)	70.0dB
3.6GHz	Radiolocation, aero communication and navigation, satellite, mobile, S-band	81.2dB
5GHz	802.11a, 802.11n, aero communication and navigation, mobile communication, space and satellite operation, C-band (4GHz to 8GHz)	92.5dB

### 7.3.5 Overload Recovery

Overload recovery is defined as the time required for the operational amplifier output to recover from a saturated state to a linear state. The output devices of the operational amplifier enter a saturation region when the output voltage exceeds the rated operating voltage, because of the high input voltage or high gain. After the device enters the saturation region, the output devices require time to return to the linear operating state. After the output devices return to their linear operating state, the device begins to slew at the specified slew rate. Therefore, the propagation delay (in case of an overload condition) is the sum of the overload recovery time and the slew time. The overload recovery time for the TLV905x family is approximately 300 ns.

### 7.3.6 Packages With an Exposed Thermal Pad

The TLV905x family is available in packages such as the WSON-8 (DSG) and WQFN-16 (RTE) which feature an exposed thermal pad. Inside the package, the die is attached to this thermal pad using an electrically conductive compound. For this reason, when using a package with an exposed thermal pad, the thermal pad must either be connected to V– or left floating. Attaching the thermal pad to a potential other than V– is not allowed, and the performance of the device is not verified when doing so.

### 7.3.7 Electrical Overstress

Designers often ask questions about the capability of an operational amplifier to withstand electrical overstress. These questions tend to focus on the device inputs, but can involve the supply voltage pins or even the output pin. Each of these different pin functions have electrical stress limits determined by the voltage breakdown characteristics of the particular semiconductor fabrication process and specific circuits connected to the pin. Additionally, internal electrostatic discharge (ESD) protection is built into these circuits to protect them from accidental ESD events both before and during product assembly.

Having a good understanding of this basic ESD circuitry and its relevance to an electrical overstress event is helpful. [Figure 7-2](#) shows the ESD circuits contained in the TLV905x devices. The ESD protection circuitry involves several current-steering diodes connected from the input and output pins and routed back to the internal power supply lines, where they meet at an absorption device internal to the operational amplifier. This protection circuitry is intended to remain inactive during normal circuit operation.

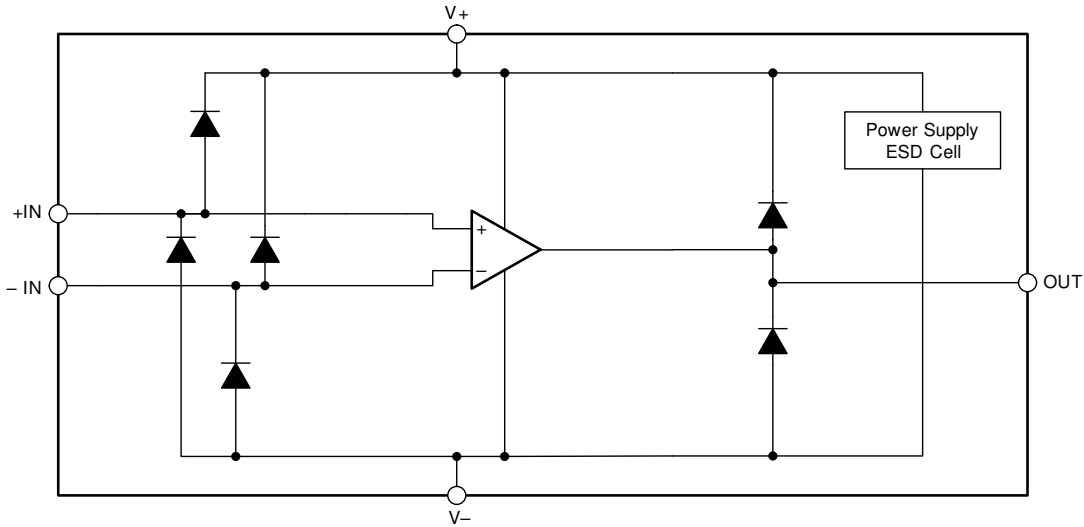

**Figure 7-2. Equivalent Internal ESD Circuitry**

### 7.3.8 Input Protection

The TLV905x family incorporates internal ESD protection circuits on all pins. For input and output pins, this protection primarily consists of current-steering diodes connected between the input and power-supply pins. These ESD protection diodes provide in-circuit, input overdrive protection, as long as the current is limited to 10mA, as shown in the [Section 6.1](#). [Figure 7-3](#) shows how a series input resistor can be added to the driven input to limit the input current. The added resistor contributes thermal noise at the amplifier input and the value must be kept to a minimum in noise-sensitive applications.



**Figure 7-3. Input Current Protection**

### 7.3.9 Shutdown Function

The TLV905xS devices feature  $\overline{\text{SHDN}}$  pins that disable the op amp, placing the device into a low-power standby mode. In this mode, the op amp consumes 1 $\mu$ A of maximum quiescent current, referred to as  $I_{\text{QSD}}$ . The  $\overline{\text{SHDN}}$  pins are active low, meaning that shutdown mode is enabled when the input to the  $\overline{\text{SHDN}}$  pin is a valid logic low.

The  $\overline{\text{SHDN}}$  pins are referenced to the negative supply voltage of the op amp. The threshold of the shutdown feature lies around 800mV (typical) and does not change with respect to the supply voltage. Hysteresis has been included in the switching threshold for smooth switching characteristics. For shutdown behavior, the  $\overline{\text{SHDN}}$  pins should be driven with valid logic signals. A valid logic low is defined as a voltage between  $V_-$  and  $V_- + 0.4\text{V}$ . A valid logic high is defined as a voltage between  $V_- + 1.2\text{V}$  and  $V_+$ . The shutdown pin circuitry includes a pull-up resistor, which will inherently pull the voltage of the pin to the positive supply rail if not driven. Thus, to enable the amplifier, the  $\overline{\text{SHDN}}$  pins must either be left floating or driven to a valid logic high. To disable the amplifier, the  $\overline{\text{SHDN}}$  pins must be driven to a valid logic low. While TI highly recommends that the shutdown pin be connected to a valid high or a low voltage or driven, TI has included a pull-up resistor connected to VCC. The maximum voltage allowed at the  $\overline{\text{SHDN}}$  pins is  $(V_+) + 0.5\text{V}$ . Exceeding this voltage level will damage the device.

The  $\overline{\text{SHDN}}$  pins are high-impedance CMOS inputs. Dual op amp versions are independently controlled and quad op amp versions are controlled in pairs with logic inputs. For battery-operated applications, this feature

may be used to greatly reduce the average current and extend battery life. The enable time is 35  $\mu$ s for full shutdown of all channels; disable time is 6  $\mu$ s. When disabled, the output assumes a high-impedance state. This architecture allows the TLV905xS to be operated as a gated amplifier (or to have the device output multiplexed onto a common analog output bus). Shutdown time ( $t_{OFF}$ ) depends on loading conditions and increases as load resistance increases. For shutdown (disable) within a specific shutdown time, the specified 10k $\Omega$  load to midsupply ( $V_S / 2$ ) is required. If using the TLV905xS without a load, the resulting turnoff time is significantly increased.

#### 7.4 Device Functional Modes

The TLV905x family is operational when the power-supply voltage is between 1.8V ( $\pm 0.9$ V) and 6.0V ( $\pm 3.0$ V).

The TLV905xS devices feature a shutdown mode and are shutdown when a valid logic low is applied to the shutdown pin.

## 8 Application and Implementation

### Note

Information in the following applications sections is not part of the TI component specification, and TI does not warrant its accuracy or completeness. TI's customers are responsible for determining suitability of components for their purposes, as well as validating and testing their design implementation to confirm system functionality.

### 8.1 Application Information

The TLV905x family features 5MHz bandwidth and very high slew rate of 15V/ $\mu$ s with only 330 $\mu$ A of supply current per channel, providing excellent AC performance at very low-power consumption. DC applications are well served with a very low input noise voltage of 15nV/ $\sqrt{\text{Hz}}$  at 10kHz, low input bias current, and a typical input offset voltage of 0.33mV.

### 8.2 Typical Low-Side Current Sense Application

Figure 8-1 shows the TLV905x configured in a low-side current sensing application.

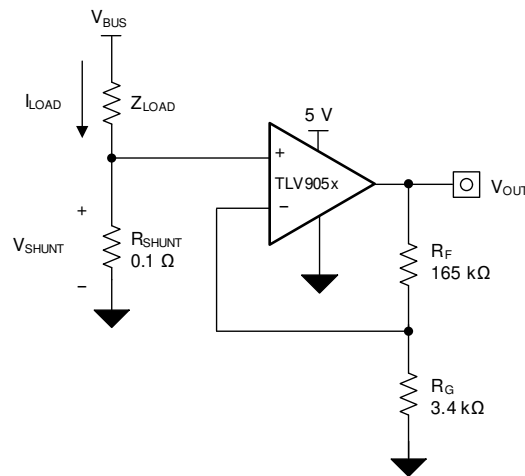

**Figure 8-1. TLV905x in a Low-Side, Current-Sensing Application**

#### 8.2.1 Design Requirements

The design requirements for this design are:

- Load current: 0A to 1A
- Output voltage: 4.95V
- Maximum shunt voltage: 100mV

## 8.2.2 Detailed Design Procedure

The transfer function of the circuit in [Figure 8-1](#) is given in [Equation 1](#).

$$V_{OUT} = I_{LOAD} \times R_{SHUNT} \times \text{Gain} \quad (1)$$

The load current ( $I_{LOAD}$ ) produces a voltage drop across the shunt resistor ( $R_{SHUNT}$ ). The load current is set from 0A to 1A. To keep the shunt voltage below 100mV at maximum load current, the largest shunt resistor is defined using [Equation 2](#).

$$R_{SHUNT} = \frac{V_{SHUNT\_MAX}}{I_{LOAD\_MAX}} = \frac{100\text{ mV}}{1\text{ A}} = 100\text{ m}\Omega \quad (2)$$

Using [Equation 2](#),  $R_{SHUNT}$  equals 100 m $\Omega$ . The voltage drop produced by  $I_{LOAD}$  and  $R_{SHUNT}$  is amplified by the TLV905x device to produce an output voltage of approximately 0V to 4.95V. [Equation 3](#) calculates the gain required for the TLV905x device to produce the required output voltage.

$$\text{Gain} = \frac{(V_{OUT\_MAX} - V_{OUT\_MIN})}{(V_{IN\_MAX} - V_{IN\_MIN})} \quad (3)$$

Using [Equation 3](#), the required gain equals 49.5V/V, which is set with the  $R_F$  and  $R_G$  resistors. [Equation 4](#) sizes the  $R_F$  and  $R_G$ , resistors to set the gain of the TLV905x device to 49.5V/V.

$$\text{Gain} = 1 + \frac{(R_F)}{(R_G)} \quad (4)$$

Selecting  $R_F$  to equal 165k $\Omega$  and  $R_G$  to equal 3.4k $\Omega$  provides a combination that equals approximately 49.5V/V. [Figure 8-2](#) shows the measured transfer function of the circuit shown in [Figure 8-1](#).

## 8.2.3 Application Curve

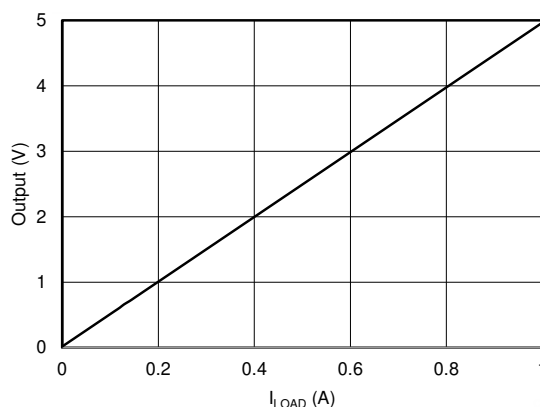

**Figure 8-2. Low-Side, Current-Sense Transfer Function**

## 8.3 Power Supply Recommendations

The TLV905x family is specified for operation from 1.8V to 6.0V ( $\pm 0.9V$  to  $\pm 3.0V$ ); many specifications apply from  $-40^{\circ}\text{C}$  to  $125^{\circ}\text{C}$ . The [Section 6.8](#) section presents parameters that can exhibit significant variance with regard to operating voltage or temperature.

### CAUTION

Supply voltages larger than 7V can permanently damage the device; see the [Section 6.1](#) table.

Place 0.1 $\mu\text{F}$  bypass capacitors close to the power-supply pins to reduce errors coupling in from noisy or high-impedance power supplies. For more-detailed information on bypass capacitor placement, see the [Section 8.4.2](#) section.

## 8.4 Layout

### 8.4.1 Layout Guidelines

For best operational performance of the device, use good printed circuit board (PCB) layout practices, including:

- Noise can propagate into analog circuitry through the power pins of the circuit as a whole and of the op amp itself. Bypass capacitors are used to reduce the coupled noise by providing low-impedance power sources local to the analog circuitry.
  - Connect low-ESR, 0.1 $\mu\text{F}$  ceramic bypass capacitors between each supply pin and ground, placed as close to the device as possible. A single bypass capacitor from V+ to ground is applicable for single-supply applications.
- Separate grounding for analog and digital portions of circuitry is one of the simplest and most-effective methods of noise suppression. One or more layers on multilayer PCBs are usually devoted to ground planes. A ground plane helps distribute heat and reduces electromagnetic interference (EMI) noise pickup. Take care to physically separate digital and analog grounds, paying attention to the flow of the ground current. For more detailed information, see [Circuit Board Layout Techniques](#).
- To reduce parasitic coupling, run the input traces as far away from the supply or output traces as possible. If these traces cannot be kept separate, crossing the sensitive trace perpendicular is much better as opposed to in parallel with the noisy trace.
- Place the external components as close to the device as possible. As illustrated in [Figure 8-4](#), keeping R<sub>F</sub> and R<sub>G</sub> close to the inverting input minimizes parasitic capacitance on the inverting input.
- Keep the length of input traces as short as possible. Always remember that the input traces are the most sensitive part of the circuit.
- Consider a driven, low-impedance guard ring around the critical traces. A guard ring can significantly reduce leakage currents from nearby traces that are at different potentials.
- Cleaning the PCB following board assembly is recommended for best performance.
- Any precision integrated circuit can experience performance shifts resulting from moisture ingress into the plastic package. Following any aqueous PCB cleaning process, baking the PCB assembly is recommended to remove moisture introduced into the device packaging during the cleaning process. A low-temperature, post-cleaning bake at 85 $^{\circ}\text{C}$  for 30 minutes is sufficient for most circumstances.

### 8.4.2 Layout Example



Figure 8-3. Schematic Representation for Figure 8-4



Figure 8-4. Layout Example

## 9 Device and Documentation Support

### 9.1 Documentation Support

#### 9.1.1 Related Documentation

For related documentation, see the following:

- Texas Instruments, [TLVx313 Low-Power, Rail-to-Rail In/Out, 500- \$\mu\$ V Typical Offset, 1MHz Operational Amplifier for Cost-Sensitive Systems](#)
- Texas Instruments, [TLVx314 3MHz, Low-Power, Internal EMI Filter, RRIO, Operational Amplifier](#)
- Texas Instruments, [EMI Rejection Ratio of Operational Amplifiers](#)
- Texas Instruments, [QFN/SON PCB Attachment](#)
- Texas Instruments, [Quad Flatpack No-Lead Logic Packages](#)
- Texas Instruments, [Circuit Board Layout Techniques](#)
- Texas Instruments, [Single-Ended Input to Differential Output Conversion Circuit Reference Design](#)

#### 9.2 Receiving Notification of Documentation Updates

To receive notification of documentation updates, navigate to the device product folder on ti.com. In the upper right corner, click on *Alert me* to register and receive a weekly digest of any product information that has changed. For change details, review the revision history included in any revised document.

#### 9.3 Support Resources

[TI E2E™ support forums](#) are an engineer's go-to source for fast, verified answers and design help — straight from the experts. Search existing answers or ask your own question to get the quick design help you need.

Linked content is provided "AS IS" by the respective contributors. They do not constitute TI specifications and do not necessarily reflect TI's views; see TI's [Terms of Use](#).

#### 9.4 Trademarks

TI E2E™ is a trademark of Texas Instruments.  
Bluetooth® is a registered trademark of Bluetooth SIG, Inc.  
All trademarks are the property of their respective owners.

#### 9.5 Electrostatic Discharge Caution



This integrated circuit can be damaged by ESD. Texas Instruments recommends that all integrated circuits be handled with appropriate precautions. Failure to observe proper handling and installation procedures can cause damage.

ESD damage can range from subtle performance degradation to complete device failure. Precision integrated circuits may be more susceptible to damage because very small parametric changes could cause the device not to meet its published specifications.

#### 9.6 Glossary

[TI Glossary](#) This glossary lists and explains terms, acronyms, and definitions.

## 10 Revision History

NOTE: Page numbers for previous revisions may differ from page numbers in the current version.

<b>Changes from Revision I (November 2022) to Revision J (February 2024)</b>	<b>Page</b>
• Changed pins 3 and 4 the TLV9051S DBV pin diagram.....	<b>3</b>
• Added shutdown section into the Electrical Characteristics table.....	<b>11</b>

<b>Changes from Revision H (October 2019) to Revision I (November 2022)</b>	<b>Page</b>
• Increased maximum supply voltage in <i>Absolute Maximum Ratings</i> from 6 V to 7 V.....	9
• Added maximum limits for input bias current and input offset current.....	11

---

<b>Changes from Revision G (September 2019) to Revision H (October 2019)</b>	<b>Page</b>
• Added new human-body model and charged-device model ratings for TLV9051 X2SON package to the <i>ESD Ratings</i> .....	9
• Added <i>Packages With an Exposed Thermal Pad</i> section to <i>Feature Description</i> section.....	22

---

<b>Changes from Revision F (June 2019) to Revision G (September 2019)</b>	<b>Page</b>
• Deleted preview tags for all TLV9051 packages.....	1
• Deleted preview tags for the TLV9052 SOT-23, 8) - DDF package.....	1
• Added link to <i>Shutdown Function</i> section in all of the $\overline{\text{SHDN}}$ pin function rows.....	3
• Added <i>EMI Rejection</i> section to <i>Feature Description</i> section.....	21
• Added clarification to the <i>Shutdown Function</i> section.....	23

---

## 11 Mechanical, Packaging, and Orderable Information

The following pages include mechanical, packaging, and orderable information. This information is the most-current data available for the designated devices. This data is subject to change without notice and without revision of this document. For browser-based versions of this data sheet, see the left-hand navigation pane.

**PACKAGING INFORMATION**

Orderable part number	Status (1)	Material type (2)	Package   Pins	Package qty   Carrier	RoHS (3)	Lead finish/ Ball material (4)	MSL rating/ Peak reflow (5)	Op temp (°C)	Part marking (6)
<a href="#">TLV9051IDBVR</a>	Active	Production	SOT-23 (DBV)   5	3000   LARGE T&R	Yes	NIPDAU   SN	Level-1-260C-UNLIM	-40 to 125	T51D
TLV9051IDBVR.A	Active	Production	SOT-23 (DBV)   5	3000   LARGE T&R	Yes	NIPDAU	Level-1-260C-UNLIM	-40 to 125	T51D
<a href="#">TLV9051IDCKR</a>	Active	Production	SC70 (DCK)   5	3000   LARGE T&R	Yes	SN	Level-2-260C-1 YEAR	-40 to 125	T51
TLV9051IDCKR.A	Active	Production	SC70 (DCK)   5	3000   LARGE T&R	Yes	SN	Level-2-260C-1 YEAR	-40 to 125	T51
<a href="#">TLV9051IDPWR</a>	Active	Production	X2SON (DPW)   5	3000   LARGE T&R	Yes	NIPDAUAG	Level-2-260C-1 YEAR	-40 to 125	FH
TLV9051IDPWR.A	Active	Production	X2SON (DPW)   5	3000   LARGE T&R	Yes	NIPDAUAG	Level-2-260C-1 YEAR	-40 to 125	FH
<a href="#">TLV9051SIDBVR</a>	Active	Production	SOT-23 (DBV)   6	3000   LARGE T&R	Yes	NIPDAU   SN	Level-1-260C-UNLIM	-40 to 125	T51S
TLV9051SIDBVR.A	Active	Production	SOT-23 (DBV)   6	3000   LARGE T&R	Yes	NIPDAU	Level-1-260C-UNLIM	-40 to 125	T51S
TLV9051SIDBVRG4	Active	Production	SOT-23 (DBV)   6	3000   LARGE T&R	Yes	NIPDAU	Level-1-260C-UNLIM	-40 to 125	T51S
TLV9051SIDBVRG4.A	Active	Production	SOT-23 (DBV)   6	3000   LARGE T&R	Yes	NIPDAU	Level-1-260C-UNLIM	-40 to 125	T51S
<a href="#">TLV9052IDDFR</a>	Active	Production	SOT-23-THIN (DDF)   8	3000   LARGE T&R	Yes	NIPDAU	Level-1-260C-UNLIM	-40 to 125	T052
TLV9052IDDFR.A	Active	Production	SOT-23-THIN (DDF)   8	3000   LARGE T&R	Yes	NIPDAU	Level-1-260C-UNLIM	-40 to 125	T052
TLV9052IDDFRG4	Active	Production	SOT-23-THIN (DDF)   8	3000   LARGE T&R	Yes	NIPDAU	Level-1-260C-UNLIM	-40 to 125	T052
TLV9052IDDFRG4.A	Active	Production	SOT-23-THIN (DDF)   8	3000   LARGE T&R	Yes	NIPDAU	Level-1-260C-UNLIM	-40 to 125	T052
<a href="#">TLV9052IDGKR</a>	Active	Production	VSSOP (DGK)   8	2500   LARGE T&R	Yes	NIPDAU   SN   NIPDAUAG	Level-2-260C-1 YEAR	-40 to 125	1PWX
TLV9052IDGKR.A	Active	Production	VSSOP (DGK)   8	2500   LARGE T&R	Yes	SN	Level-2-260C-1 YEAR	-40 to 125	1PWX
TLV9052IDGKRG4	Active	Production	VSSOP (DGK)   8	2500   LARGE T&R	Yes	NIPDAU	Level-1-260C-UNLIM	-40 to 125	1PWX
TLV9052IDGKRG4.A	Active	Production	VSSOP (DGK)   8	2500   LARGE T&R	Yes	NIPDAU	Level-1-260C-UNLIM	-40 to 125	1PWX
<a href="#">TLV9052IDR</a>	Active	Production	SOIC (D)   8	2500   LARGE T&R	Yes	NIPDAU	Level-1-260C-UNLIM	-40 to 125	TL9052
TLV9052IDR.A	Active	Production	SOIC (D)   8	2500   LARGE T&R	Yes	NIPDAU	Level-1-260C-UNLIM	-40 to 125	TL9052
TLV9052IDRG4	Active	Production	SOIC (D)   8	2500   LARGE T&R	Yes	NIPDAU	Level-1-260C-UNLIM	-40 to 125	TL9052
TLV9052IDRG4.A	Active	Production	SOIC (D)   8	2500   LARGE T&R	Yes	NIPDAU	Level-1-260C-UNLIM	-40 to 125	TL9052
<a href="#">TLV9052IDSGR</a>	Active	Production	WSON (DSG)   8	3000   LARGE T&R	Yes	SN	Level-1-260C-UNLIM	-40 to 125	9052
TLV9052IDSGR.A	Active	Production	WSON (DSG)   8	3000   LARGE T&R	Yes	SN	Level-1-260C-UNLIM	-40 to 125	9052
TLV9052IDSGRG4	Active	Production	WSON (DSG)   8	3000   LARGE T&R	Yes	NIPDAU	Level-1-260C-UNLIM	-40 to 125	9052
TLV9052IDSGRG4.A	Active	Production	WSON (DSG)   8	3000   LARGE T&R	Yes	NIPDAU	Level-1-260C-UNLIM	-40 to 125	9052
<a href="#">TLV9052IPWR</a>	Active	Production	TSSOP (PW)   8	2000   LARGE T&R	Yes	NIPDAU	Level-1-260C-UNLIM	-40 to 125	TL9052
TLV9052IPWR.A	Active	Production	TSSOP (PW)   8	2000   LARGE T&R	Yes	NIPDAU	Level-1-260C-UNLIM	-40 to 125	TL9052

Orderable part number	Status (1)	Material type (2)	Package   Pins	Package qty   Carrier	RoHS (3)	Lead finish/ Ball material (4)	MSL rating/ Peak reflow (5)	Op temp (°C)	Part marking (6)
<a href="#">TLV9052SIDGSR</a>	Active	Production	VSSOP (DGS)   10	2500   LARGE T&R	Yes	NIPDAUAG	Level-2-260C-1 YEAR	-40 to 125	T052
TLV9052SIDGSR.A	Active	Production	VSSOP (DGS)   10	2500   LARGE T&R	Yes	NIPDAUAG	Level-2-260C-1 YEAR	-40 to 125	T052
<a href="#">TLV9052SIRUGR</a>	Active	Production	X2QFN (RUG)   10	3000   LARGE T&R	Yes	NIPDAUAG	Level-2-260C-1 YEAR	-40 to 125	FPF
TLV9052SIRUGR.A	Active	Production	X2QFN (RUG)   10	3000   LARGE T&R	Yes	NIPDAUAG	Level-2-260C-1 YEAR	-40 to 125	FPF
<a href="#">TLV9054IDR</a>	Active	Production	SOIC (D)   14	2500   LARGE T&R	Yes	NIPDAU	Level-1-260C-UNLIM	-40 to 125	TLV9054D
TLV9054IDR.A	Active	Production	SOIC (D)   14	2500   LARGE T&R	Yes	NIPDAU	Level-1-260C-UNLIM	-40 to 125	TLV9054D
TLV9054IDRG4	Active	Production	SOIC (D)   14	2500   LARGE T&R	Yes	NIPDAU	Level-1-260C-UNLIM	-40 to 125	TLV9054D
TLV9054IDRG4.A	Active	Production	SOIC (D)   14	2500   LARGE T&R	Yes	NIPDAU	Level-1-260C-UNLIM	-40 to 125	TLV9054D
<a href="#">TLV9054IPWR</a>	Active	Production	TSSOP (PW)   14	2000   LARGE T&R	Yes	NIPDAU   SN	Level-2-260C-1 YEAR	-40 to 125	(T9054PW, TLV9054)
TLV9054IPWR.A	Active	Production	TSSOP (PW)   14	2000   LARGE T&R	Yes	SN	Level-2-260C-1 YEAR	-40 to 125	(T9054PW, TLV9054)
<a href="#">TLV9054IRTER</a>	Active	Production	WQFN (RTE)   16	3000   LARGE T&R	Yes	NIPDAU	Level-1-260C-UNLIM	-40 to 125	T54RT
TLV9054IRTER.A	Active	Production	WQFN (RTE)   16	3000   LARGE T&R	Yes	NIPDAU	Level-1-260C-UNLIM	-40 to 125	T54RT
<a href="#">TLV9054IRUCR</a>	Active	Production	QFN (RUC)   14	3000   LARGE T&R	Yes	NIPDAU	Level-2-260C-1 YEAR	-40 to 125	1FF
TLV9054IRUCR.A	Active	Production	QFN (RUC)   14	3000   LARGE T&R	Yes	NIPDAU	Level-2-260C-1 YEAR	-40 to 125	1FF
<a href="#">TLV9054SIRTER</a>	Active	Production	WQFN (RTE)   16	3000   LARGE T&R	Yes	SN	Level-1-260C-UNLIM	-40 to 125	T9054S
TLV9054SIRTER.A	Active	Production	WQFN (RTE)   16	3000   LARGE T&R	Yes	SN	Level-1-260C-UNLIM	-40 to 125	T9054S

(1) **Status:** For more details on status, see our [product life cycle](#).

(2) **Material type:** When designated, preproduction parts are prototypes/experimental devices, and are not yet approved or released for full production. Testing and final process, including without limitation quality assurance, reliability performance testing, and/or process qualification, may not yet be complete, and this item is subject to further changes or possible discontinuation. If available for ordering, purchases will be subject to an additional waiver at checkout, and are intended for early internal evaluation purposes only. These items are sold without warranties of any kind.

(3) **RoHS values:** Yes, No, RoHS Exempt. See the [TI RoHS Statement](#) for additional information and value definition.

(4) **Lead finish/Ball material:** Parts may have multiple material finish options. Finish options are separated by a vertical ruled line. Lead finish/Ball material values may wrap to two lines if the finish value exceeds the maximum column width.

(5) **MSL rating/Peak reflow:** The moisture sensitivity level ratings and peak solder (reflow) temperatures. In the event that a part has multiple moisture sensitivity ratings, only the lowest level per JEDEC standards is shown. Refer to the shipping label for the actual reflow temperature that will be used to mount the part to the printed circuit board.

**(6) Part marking:** There may be an additional marking, which relates to the logo, the lot trace code information, or the environmental category of the part.

Multiple part markings will be inside parentheses. Only one part marking contained in parentheses and separated by a "-" will appear on a part. If a line is indented then it is a continuation of the previous line and the two combined represent the entire part marking for that device.

**Important Information and Disclaimer:**The information provided on this page represents TI's knowledge and belief as of the date that it is provided. TI bases its knowledge and belief on information provided by third parties, and makes no representation or warranty as to the accuracy of such information. Efforts are underway to better integrate information from third parties. TI has taken and continues to take reasonable steps to provide representative and accurate information but may not have conducted destructive testing or chemical analysis on incoming materials and chemicals. TI and TI suppliers consider certain information to be proprietary, and thus CAS numbers and other limited information may not be available for release.

In no event shall TI's liability arising out of such information exceed the total purchase price of the TI part(s) at issue in this document sold by TI to Customer on an annual basis.

**OTHER QUALIFIED VERSIONS OF TLV9051, TLV9052 :**

- Automotive : [TLV9051-Q1](#), [TLV9052-Q1](#)

NOTE: Qualified Version Definitions:

- Automotive - Q100 devices qualified for high-reliability automotive applications targeting zero defects

**TAPE AND REEL INFORMATION**

**QUADRANT ASSIGNMENTS FOR PIN 1 ORIENTATION IN TAPE**

\*All dimensions are nominal

Device	Package Type	Package Drawing	Pins	SPQ	Reel Diameter (mm)	Reel Width W1 (mm)	A0 (mm)	B0 (mm)	K0 (mm)	P1 (mm)	W (mm)	Pin1 Quadrant
TLV9051IDBVR	SOT-23	DBV	5	3000	178.0	8.4	3.2	3.2	1.4	4.0	8.0	Q3
TLV9051IDCKR	SC70	DCK	5	3000	178.0	8.4	2.25	2.45	1.2	4.0	8.0	Q3
TLV9051IDPWR	X2SON	DPW	5	3000	178.0	8.4	0.91	0.91	0.5	2.0	8.0	Q2
TLV9051SIDBVR	SOT-23	DBV	6	3000	180.0	8.4	3.2	3.2	1.4	4.0	8.0	Q3
TLV9051SIDBVRG4	SOT-23	DBV	6	3000	180.0	8.4	3.2	3.2	1.4	4.0	8.0	Q3
TLV9052IDDFR	SOT-23-THIN	DDF	8	3000	180.0	8.4	3.2	3.2	1.4	4.0	8.0	Q3
TLV9052IDDFRG4	SOT-23-THIN	DDF	8	3000	180.0	8.4	3.2	3.2	1.4	4.0	8.0	Q3
TLV9052IDGKR	VSSOP	DGK	8	2500	330.0	12.4	5.3	3.4	1.4	8.0	12.0	Q1
TLV9052IDGKR	VSSOP	DGK	8	2500	330.0	12.4	5.25	3.35	1.25	8.0	12.0	Q1
TLV9052IDGKR	VSSOP	DGK	8	2500	330.0	12.4	5.3	3.4	1.4	8.0	12.0	Q1
TLV9052IDGKRG4	VSSOP	DGK	8	2500	330.0	12.4	5.3	3.4	1.4	8.0	12.0	Q1
TLV9052IDR	SOIC	D	8	2500	330.0	12.4	6.4	5.2	2.1	8.0	12.0	Q1
TLV9052IDRG4	SOIC	D	8	2500	330.0	12.4	6.4	5.2	2.1	8.0	12.0	Q1
TLV9052IDSGR	WSO	DSG	8	3000	180.0	8.4	2.3	2.3	1.15	4.0	8.0	Q2
TLV9052IDSGRG4	WSO	DSG	8	3000	180.0	8.4	2.3	2.3	1.15	4.0	8.0	Q2

Device	Package Type	Package Drawing	Pins	SPQ	Reel Diameter (mm)	Reel Width W1 (mm)	A0 (mm)	B0 (mm)	K0 (mm)	P1 (mm)	W (mm)	Pin1 Quadrant
TLV9052IPWR	TSSOP	PW	8	2000	330.0	12.4	7.0	3.6	1.6	8.0	12.0	Q1
TLV9052SIDGSR	VSSOP	DGS	10	2500	330.0	12.4	5.3	3.4	1.4	8.0	12.0	Q1
TLV9052SIRUGR	X2QFN	RUG	10	3000	178.0	8.4	1.75	2.25	0.56	4.0	8.0	Q1
TLV9054IDR	SOIC	D	14	2500	330.0	16.4	6.5	9.0	2.1	8.0	16.0	Q1
TLV9054IDR	SOIC	D	14	2500	330.0	16.4	6.5	9.0	2.1	8.0	16.0	Q1
TLV9054IDRG4	SOIC	D	14	2500	330.0	16.4	6.5	9.0	2.1	8.0	16.0	Q1
TLV9054IPWR	TSSOP	PW	14	2000	330.0	12.4	6.9	5.6	1.6	8.0	12.0	Q1
TLV9054IPWR	TSSOP	PW	14	2000	330.0	12.4	6.9	5.6	1.6	8.0	12.0	Q1
TLV9054IRTER	WQFN	RTE	16	3000	330.0	12.4	3.3	3.3	1.1	8.0	12.0	Q2
TLV9054IRUCR	QFN	RUC	14	3000	180.0	9.5	2.16	2.16	0.5	4.0	8.0	Q2
TLV9054SIRTER	WQFN	RTE	16	3000	330.0	12.4	3.3	3.3	1.1	8.0	12.0	Q2

**TAPE AND REEL BOX DIMENSIONS**

\*All dimensions are nominal

Device	Package Type	Package Drawing	Pins	SPQ	Length (mm)	Width (mm)	Height (mm)
TLV9051IDBVR	SOT-23	DBV	5	3000	208.0	191.0	35.0
TLV9051IDCKR	SC70	DCK	5	3000	208.0	191.0	35.0
TLV9051IDPWR	X2SON	DPW	5	3000	205.0	200.0	33.0
TLV9051SIDBVR	SOT-23	DBV	6	3000	210.0	185.0	35.0
TLV9051SIDBVRG4	SOT-23	DBV	6	3000	210.0	185.0	35.0
TLV9052IDDFR	SOT-23-THIN	DDF	8	3000	210.0	185.0	35.0
TLV9052IDDFRG4	SOT-23-THIN	DDF	8	3000	210.0	185.0	35.0
TLV9052IDGKR	VSSOP	DGK	8	2500	366.0	364.0	50.0
TLV9052IDGKR	VSSOP	DGK	8	2500	366.0	364.0	50.0
TLV9052IDGKR	VSSOP	DGK	8	2500	356.0	356.0	36.0
TLV9052IDGKRG4	VSSOP	DGK	8	2500	353.0	353.0	32.0
TLV9052IDR	SOIC	D	8	2500	353.0	353.0	32.0
TLV9052IDRG4	SOIC	D	8	2500	353.0	353.0	32.0
TLV9052IDSGR	WSON	DSG	8	3000	210.0	185.0	35.0
TLV9052IDSGRG4	WSON	DSG	8	3000	210.0	185.0	35.0
TLV9052IPWR	TSSOP	PW	8	2000	353.0	353.0	32.0
TLV9052SIDGSR	VSSOP	DGS	10	2500	366.0	364.0	50.0
TLV9052SIRUGR	X2QFN	RUG	10	3000	205.0	200.0	33.0

Device	Package Type	Package Drawing	Pins	SPQ	Length (mm)	Width (mm)	Height (mm)
TLV9054IDR	SOIC	D	14	2500	353.0	353.0	32.0
TLV9054IDR	SOIC	D	14	2500	353.0	353.0	32.0
TLV9054IDRG4	SOIC	D	14	2500	353.0	353.0	32.0
TLV9054IPWR	TSSOP	PW	14	2000	356.0	356.0	35.0
TLV9054IPWR	TSSOP	PW	14	2000	353.0	353.0	32.0
TLV9054IRTER	WQFN	RTE	16	3000	367.0	367.0	35.0
TLV9054IRUCR	QFN	RUC	14	3000	205.0	200.0	30.0
TLV9054SIRTER	WQFN	RTE	16	3000	367.0	367.0	35.0

# DBV0005A



# PACKAGE OUTLINE

SOT-23 - 1.45 mm max height

SMALL OUTLINE TRANSISTOR



4214839/K 08/2024

## NOTES:

1. All linear dimensions are in millimeters. Any dimensions in parenthesis are for reference only. Dimensioning and tolerancing per ASME Y14.5M.
2. This drawing is subject to change without notice.
3. Reference JEDEC MO-178.
4. Body dimensions do not include mold flash, protrusions, or gate burrs. Mold flash, protrusions, or gate burrs shall not exceed 0.25 mm per side.
5. Support pin may differ or may not be present.



# EXAMPLE STENCIL DESIGN

DBV0005A

SOT-23 - 1.45 mm max height

SMALL OUTLINE TRANSISTOR



SOLDER PASTE EXAMPLE  
BASED ON 0.125 mm THICK STENCIL  
SCALE:15X

4214839/K 08/2024

NOTES: (continued)

8. Laser cutting apertures with trapezoidal walls and rounded corners may offer better paste release. IPC-7525 may have alternate design recommendations.
9. Board assembly site may have different recommendations for stencil design.

# DGK0008A



# PACKAGE OUTLINE

VSSOP - 1.1 mm max height

SMALL OUTLINE PACKAGE



4214862/A 04/2023

**NOTES:**

PowerPAD is a trademark of Texas Instruments.

1. All linear dimensions are in millimeters. Any dimensions in parenthesis are for reference only. Dimensioning and tolerancing per ASME Y14.5M.
2. This drawing is subject to change without notice.
3. This dimension does not include mold flash, protrusions, or gate burrs. Mold flash, protrusions, or gate burrs shall not exceed 0.15 mm per side.
4. This dimension does not include interlead flash. Interlead flash shall not exceed 0.25 mm per side.
5. Reference JEDEC registration MO-187.

# EXAMPLE BOARD LAYOUT

DGK0008A

™ VSSOP - 1.1 mm max height

SMALL OUTLINE PACKAGE



LAND PATTERN EXAMPLE  
EXPOSED METAL SHOWN  
SCALE: 15X



SOLDER MASK DETAILS

4214862/A 04/2023

NOTES: (continued)

6. Publication IPC-7351 may have alternate designs.
7. Solder mask tolerances between and around signal pads can vary based on board fabrication site.
8. Vias are optional depending on application, refer to device data sheet. If any vias are implemented, refer to their locations shown on this view. It is recommended that vias under paste be filled, plugged or tented.
9. Size of metal pad may vary due to creepage requirement.

# EXAMPLE STENCIL DESIGN

DGK0008A

<sup>TM</sup> VSSOP - 1.1 mm max height

SMALL OUTLINE PACKAGE



SOLDER PASTE EXAMPLE  
SCALE: 15X

4214862/A 04/2023

NOTES: (continued)

11. Laser cutting apertures with trapezoidal walls and rounded corners may offer better paste release. IPC-7525 may have alternate design recommendations.
12. Board assembly site may have different recommendations for stencil design.

## GENERIC PACKAGE VIEW

**RTE 16**

**WQFN - 0.8 mm max height**

3 x 3, 0.5 mm pitch

PLASTIC QUAD FLATPACK - NO LEAD

This image is a representation of the package family, actual package may vary.  
Refer to the product data sheet for package details.

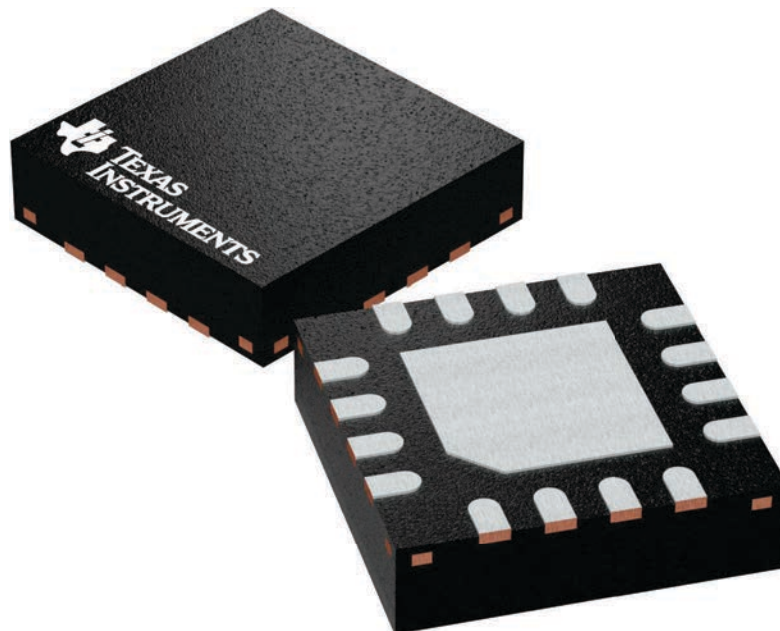

4225944/A

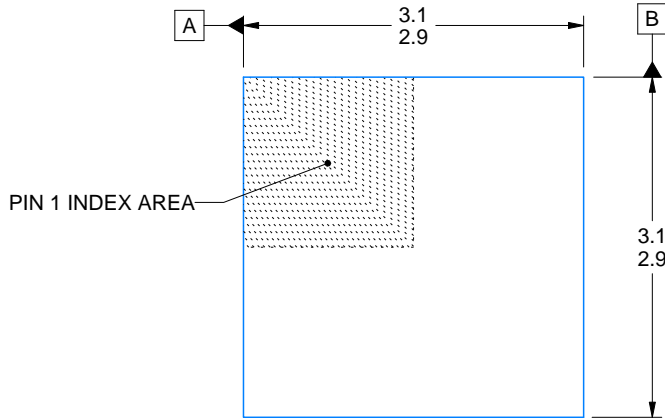

SIDE WALL METAL THICKNESS DIM A	
OPTION 1	OPTION 2
0.1	0.2

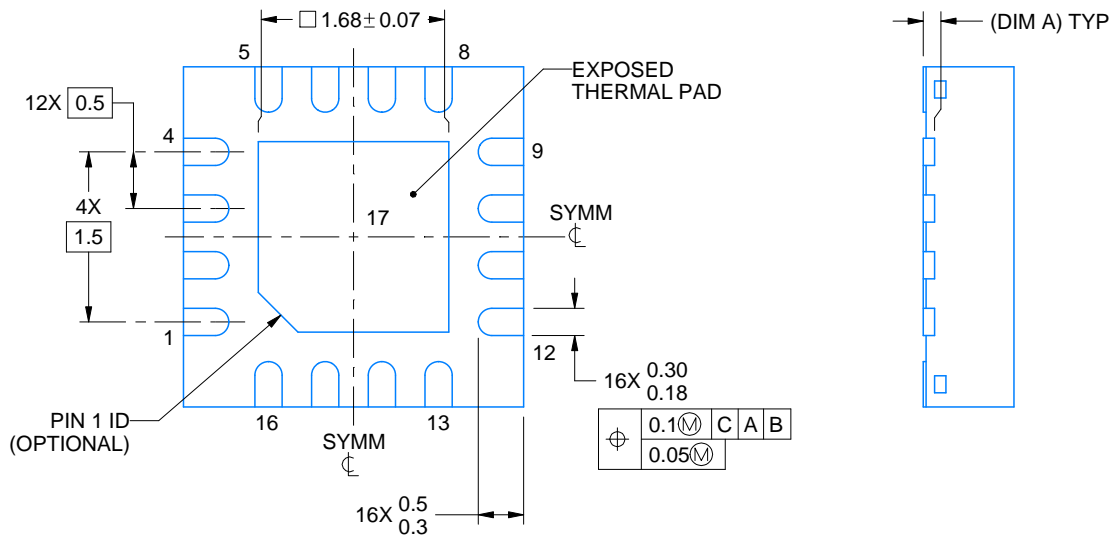
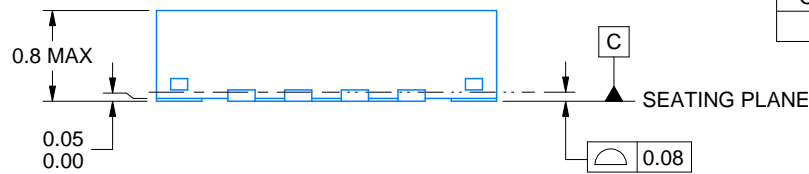

4219117/B 04/2022

NOTES:

1. All linear dimensions are in millimeters. Any dimensions in parenthesis are for reference only. Dimensioning and tolerancing per ASME Y14.5M.
2. This drawing is subject to change without notice.
3. The package thermal pad must be soldered to the printed circuit board for thermal and mechanical performance.

# EXAMPLE BOARD LAYOUT

RTE0016C

WQFN - 0.8 mm max height

PLASTIC QUAD FLATPACK - NO LEAD

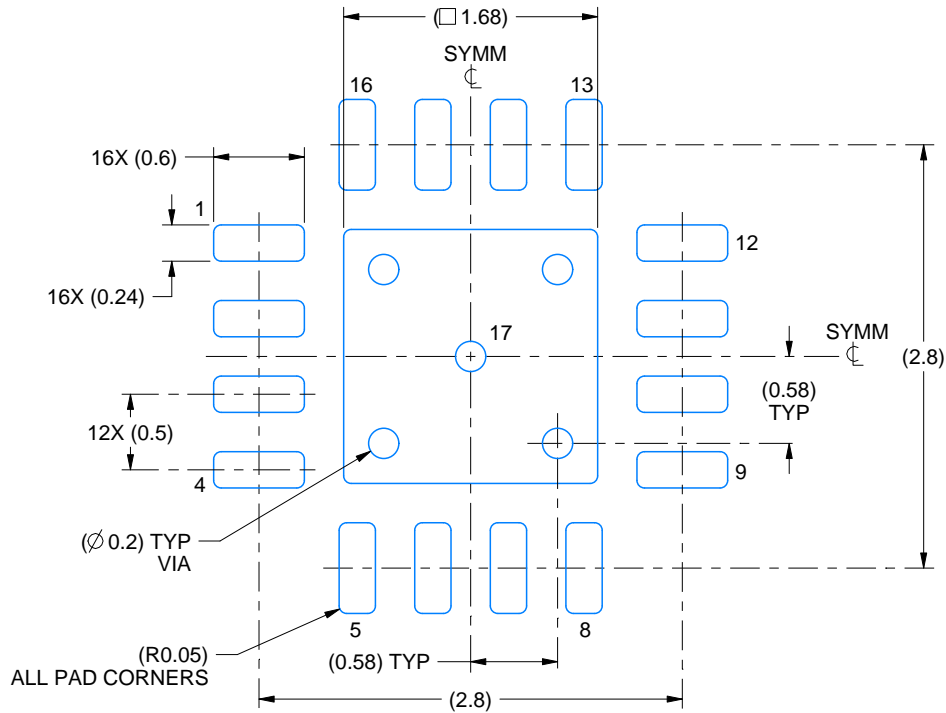

LAND PATTERN EXAMPLE  
EXPOSED METAL SHOWN  
SCALE:20X

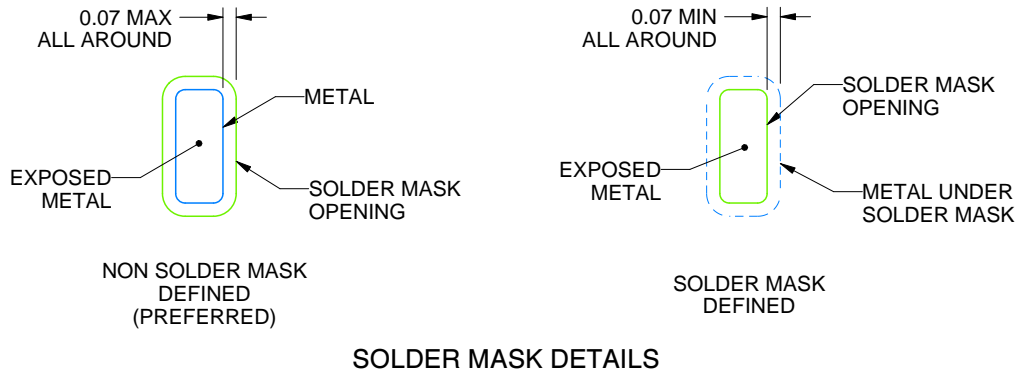

SOLDER MASK DETAILS

4219117/B 04/2022

NOTES: (continued)

- This package is designed to be soldered to a thermal pad on the board. For more information, see Texas Instruments literature number SLUA271 ([www.ti.com/lit/slua271](http://www.ti.com/lit/slua271)).
- Vias are optional depending on application, refer to device data sheet. If any vias are implemented, refer to their locations shown on this view. It is recommended that vias under paste be filled, plugged or tented.

# EXAMPLE STENCIL DESIGN

RTE0016C

WQFN - 0.8 mm max height

PLASTIC QUAD FLATPACK - NO LEAD



**SOLDER PASTE EXAMPLE**  
BASED ON 0.125 mm THICK STENCIL

EXPOSED PAD 17:  
85% PRINTED SOLDER COVERAGE BY AREA UNDER PACKAGE  
SCALE:25X

4219117/B 04/2022

NOTES: (continued)

6. Laser cutting apertures with trapezoidal walls and rounded corners may offer better paste release. IPC-7525 may have alternate design recommendations.



# D0014A

# PACKAGE OUTLINE

## SOIC - 1.75 mm max height

SMALL OUTLINE INTEGRATED CIRCUIT



4220718/A 09/2016

### NOTES:

1. All linear dimensions are in millimeters. Dimensions in parenthesis are for reference only. Dimensioning and tolerancing per ASME Y14.5M.
2. This drawing is subject to change without notice.
3. This dimension does not include mold flash, protrusions, or gate burrs. Mold flash, protrusions, or gate burrs shall not exceed 0.15 mm, per side.
4. This dimension does not include interlead flash. Interlead flash shall not exceed 0.43 mm, per side.
5. Reference JEDEC registration MS-012, variation AB.

# EXAMPLE BOARD LAYOUT

D0014A

SOIC - 1.75 mm max height

SMALL OUTLINE INTEGRATED CIRCUIT



LAND PATTERN EXAMPLE  
SCALE:8X



SOLDER MASK DETAILS

4220718/A 09/2016

NOTES: (continued)

- 6. Publication IPC-7351 may have alternate designs.
- 7. Solder mask tolerances between and around signal pads can vary based on board fabrication site.

# EXAMPLE STENCIL DESIGN

D0014A

SOIC - 1.75 mm max height

SMALL OUTLINE INTEGRATED CIRCUIT



SOLDER PASTE EXAMPLE  
BASED ON 0.125 mm THICK STENCIL  
SCALE:8X

4220718/A 09/2016

NOTES: (continued)

8. Laser cutting apertures with trapezoidal walls and rounded corners may offer better paste release. IPC-7525 may have alternate design recommendations.
9. Board assembly site may have different recommendations for stencil design.

## GENERIC PACKAGE VIEW

**RUG 10**

**X2QFN - 0.4 mm max height**

1.5 x 2, 0.5 mm pitch

PLASTIC QUAD FLATPACK - NO LEAD

This image is a representation of the package family, actual package may vary.  
Refer to the product data sheet for package details.



4231768/A

# RUG0010A



# PACKAGE OUTLINE

## X2QFN - 0.4 mm max height

PLASTIC QUAD FLATPACK - NO LEAD

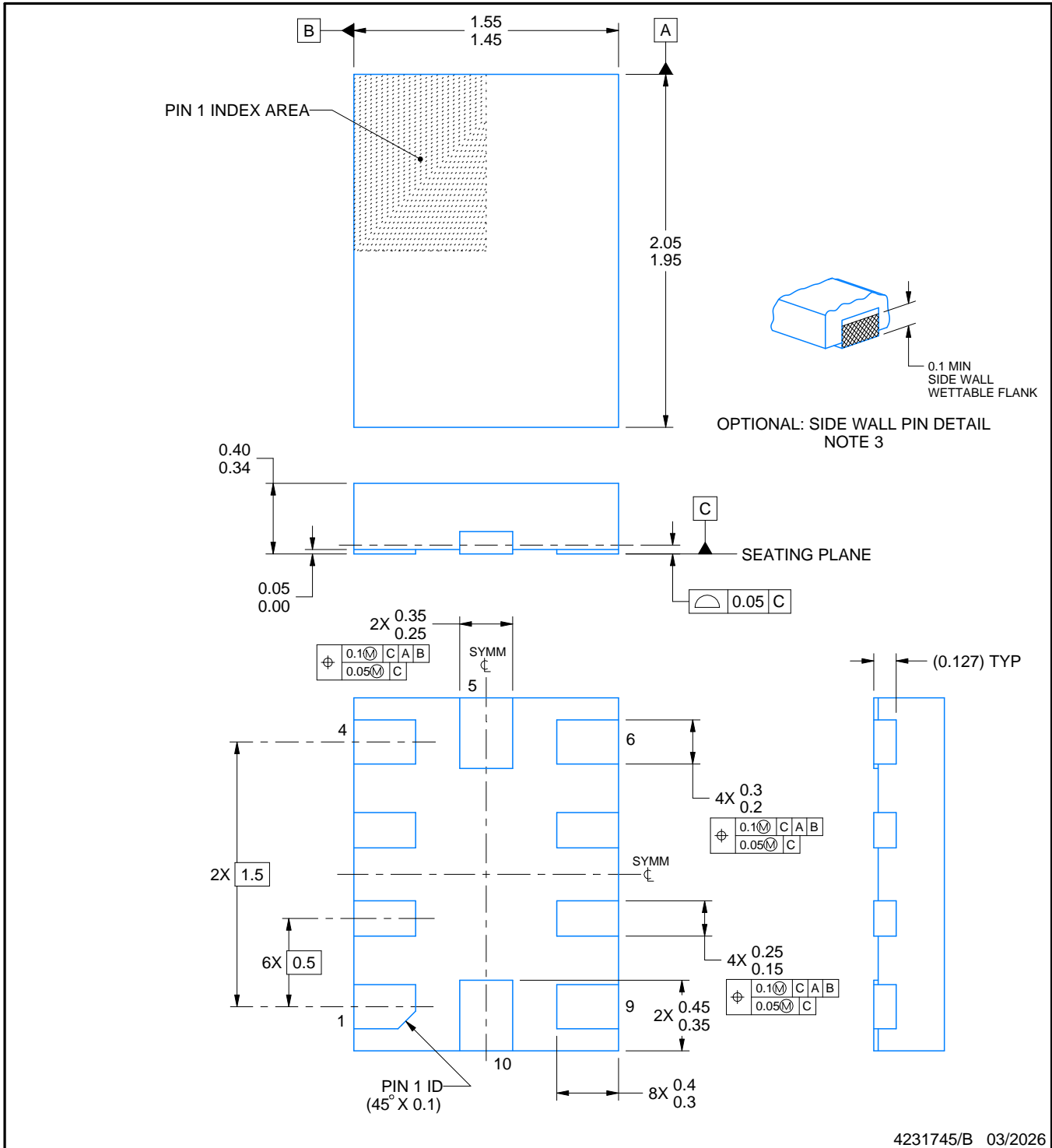

4231745/B 03/2026

### NOTES:

1. All linear dimensions are in millimeters. Any dimensions in parenthesis are for reference only. Dimensioning and tolerancing per ASME Y14.5M.
2. This drawing is subject to change without notice.
3. Minimum 0.1 mm solder wetting on pin side wall. Available for wettable flank version only.

# EXAMPLE BOARD LAYOUT

RUG0010A

X2QFN - 0.4 mm max height

PLASTIC QUAD FLATPACK - NO LEAD

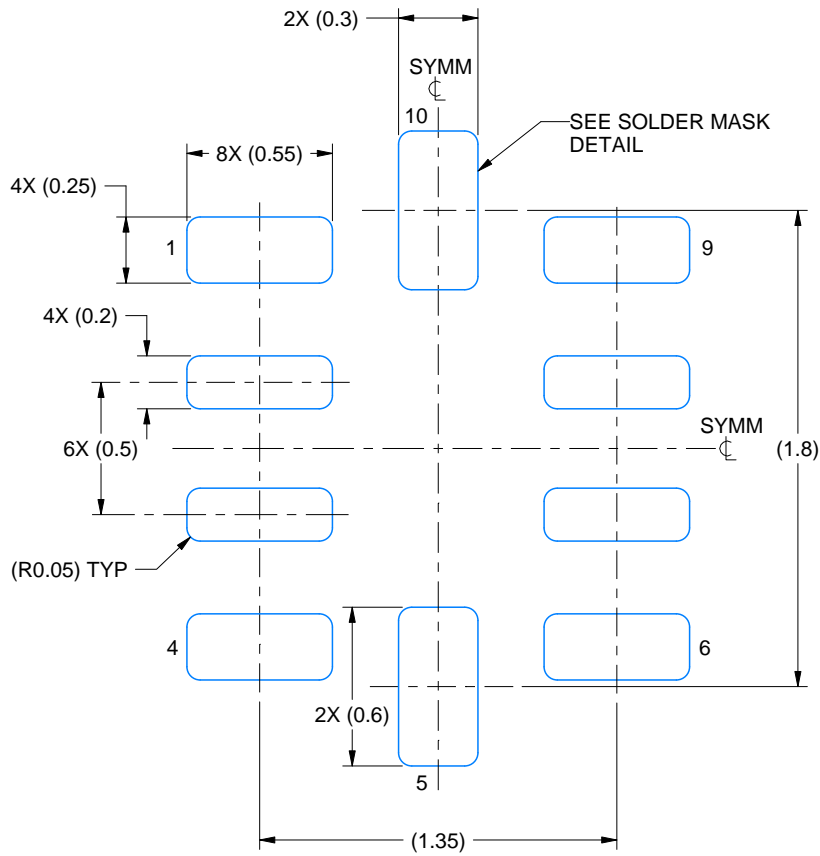

LAND PATTERN EXAMPLE  
EXPOSED METAL SHOWN  
SCALE: 35X

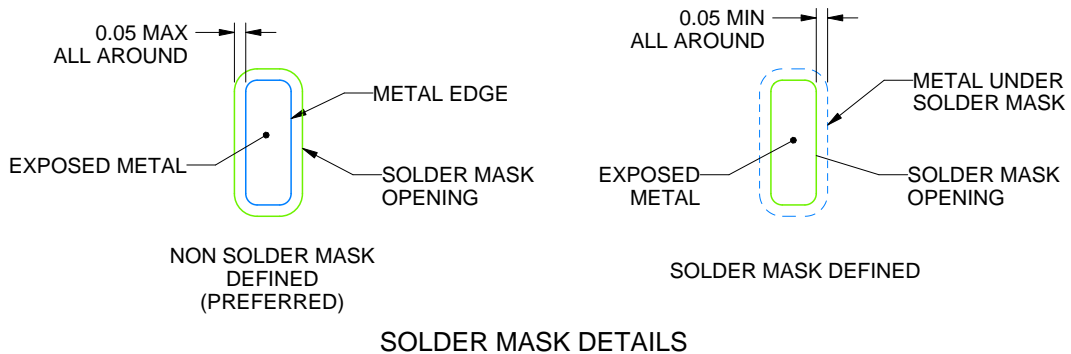

4231745/B 03/2026

NOTES: (continued)

3. For more information, see Texas Instruments literature number SLUA271 ([www.ti.com/lit/sluea271](http://www.ti.com/lit/sluea271)).



# DGS0010A



# PACKAGE OUTLINE

## VSSOP - 1.1 mm max height

SMALL OUTLINE PACKAGE



4221984/A 05/2015

### NOTES:

1. All linear dimensions are in millimeters. Any dimensions in parenthesis are for reference only. Dimensioning and tolerancing per ASME Y14.5M.
2. This drawing is subject to change without notice.
3. This dimension does not include mold flash, protrusions, or gate burrs. Mold flash, protrusions, or gate burrs shall not exceed 0.15 mm per side.
4. This dimension does not include interlead flash. Interlead flash shall not exceed 0.25 mm per side.
5. Reference JEDEC registration MO-187, variation BA.

# EXAMPLE BOARD LAYOUT

DGS0010A

VSSOP - 1.1 mm max height

SMALL OUTLINE PACKAGE



LAND PATTERN EXAMPLE  
SCALE:10X

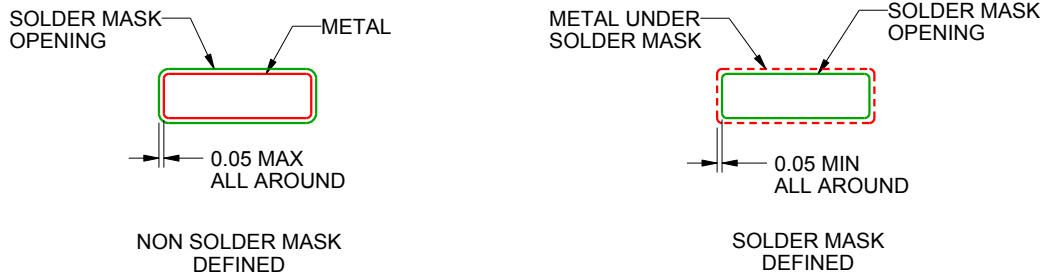

SOLDER MASK DETAILS  
NOT TO SCALE

4221984/A 05/2015

NOTES: (continued)

- 6. Publication IPC-7351 may have alternate designs.
- 7. Solder mask tolerances between and around signal pads can vary based on board fabrication site.

# EXAMPLE STENCIL DESIGN

DGS0010A

VSSOP - 1.1 mm max height

SMALL OUTLINE PACKAGE



SOLDER PASTE EXAMPLE  
BASED ON 0.125 mm THICK STENCIL  
SCALE:10X

4221984/A 05/2015

NOTES: (continued)

8. Laser cutting apertures with trapezoidal walls and rounded corners may offer better paste release. IPC-7525 may have alternate design recommendations.
9. Board assembly site may have different recommendations for stencil design.

## GENERIC PACKAGE VIEW

DPW 5

X2SON - 0.4 mm max height

PLASTIC SMALL OUTLINE - NO LEAD



Images above are just a representation of the package family, actual package may vary.  
Refer to the product data sheet for package details.

4211218-3/D

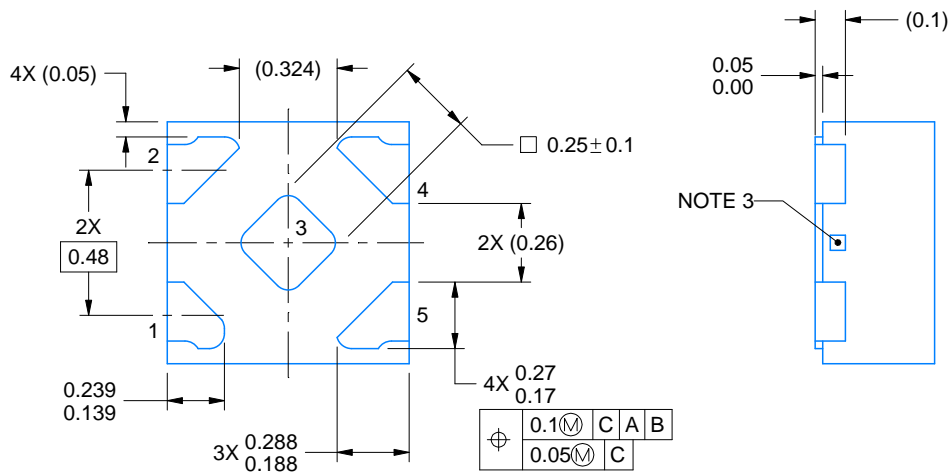
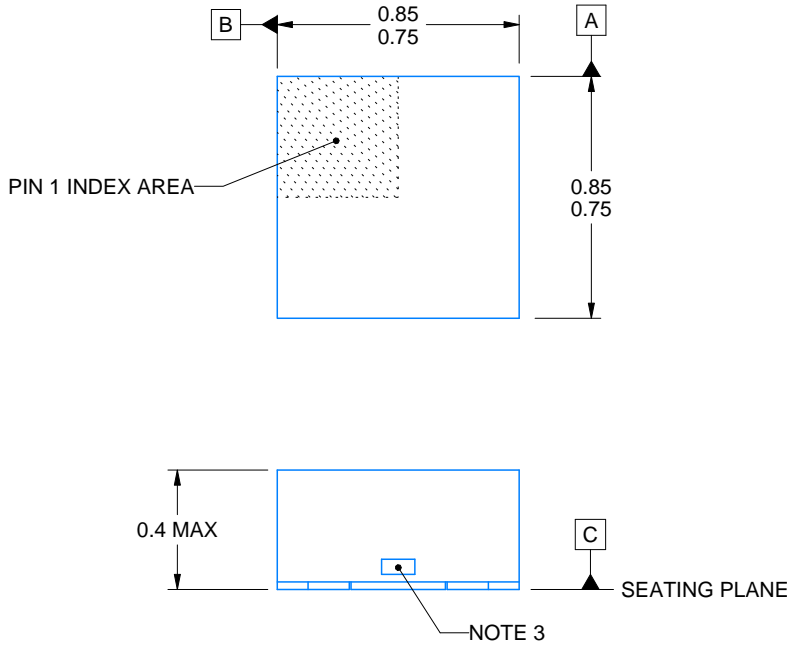

4223102/D 03/2022

NOTES:

1. All linear dimensions are in millimeters. Any dimensions in parenthesis are for reference only. Dimensioning and tolerancing per ASME Y14.5M.
2. This drawing is subject to change without notice.
3. The size and shape of this feature may vary.

# EXAMPLE BOARD LAYOUT

DPW0005A

X2SON - 0.4 mm max height

PLASTIC SMALL OUTLINE - NO LEAD

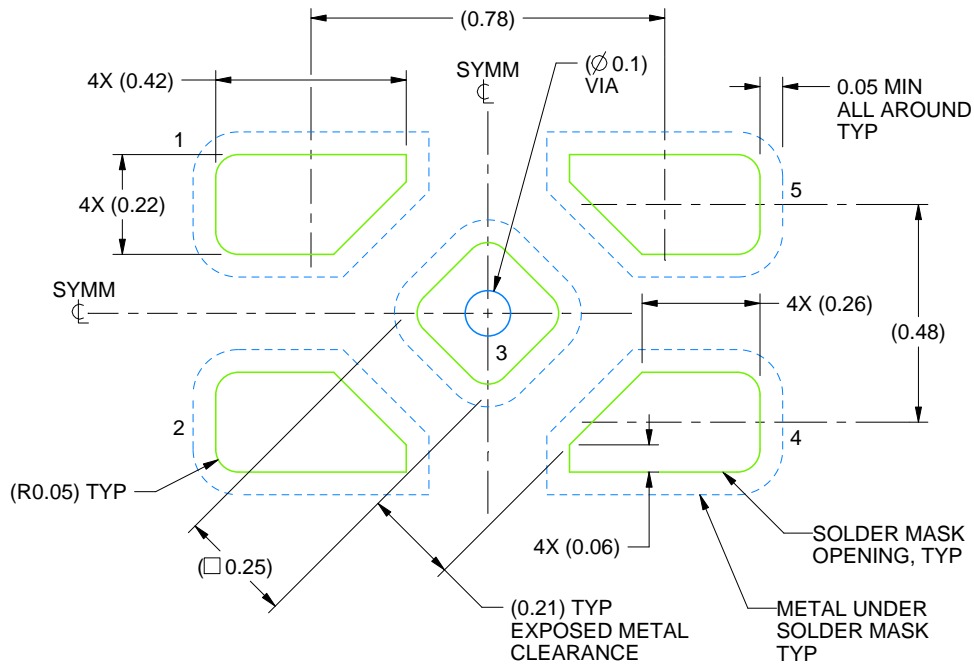

LAND PATTERN EXAMPLE  
SOLDER MASK DEFINED  
SCALE:60X

4223102/D 03/2022

NOTES: (continued)

4. This package is designed to be soldered to a thermal pad on the board. For more information, refer to QFN/SON PCB application note in literature No. SLUA271 ([www.ti.com/lit/slua271](http://www.ti.com/lit/slua271)).

# EXAMPLE STENCIL DESIGN

DPW0005A

X2SON - 0.4 mm max height

PLASTIC SMALL OUTLINE - NO LEAD

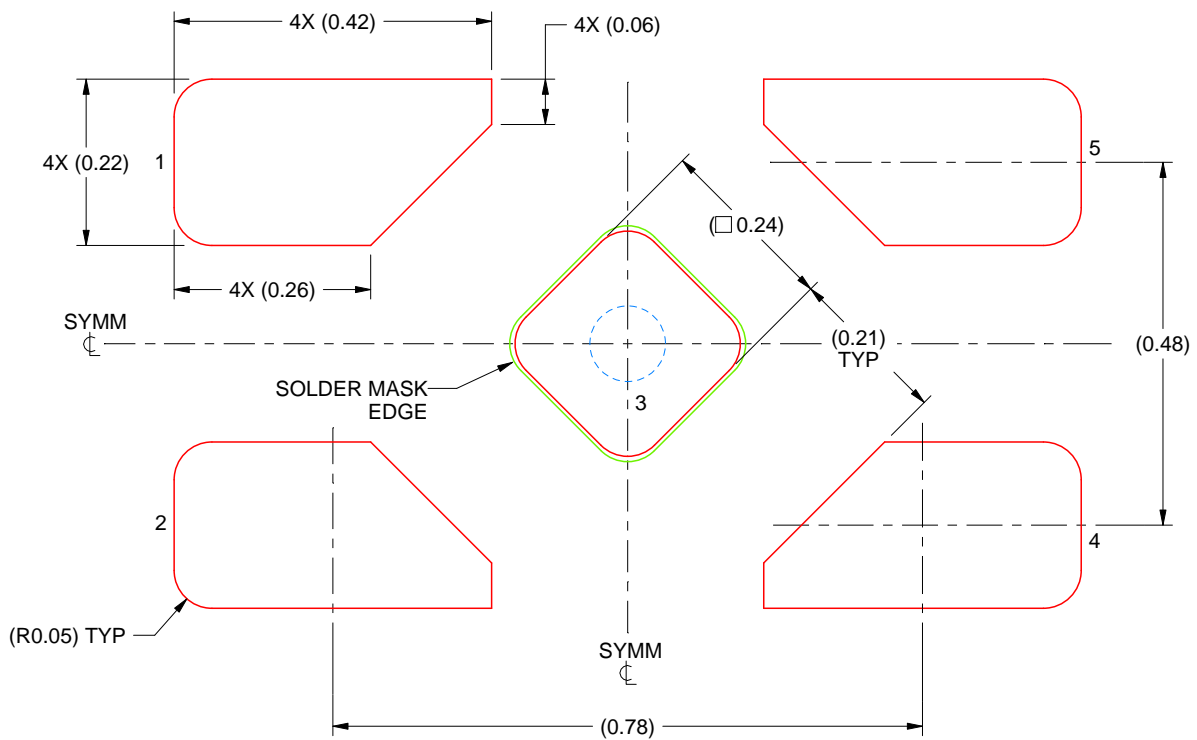

SOLDER PASTE EXAMPLE  
BASED ON 0.1 mm THICK STENCIL

EXPOSED PAD 3  
92% PRINTED SOLDER COVERAGE BY AREA UNDER PACKAGE  
SCALE:100X

4223102/D 03/2022

NOTES: (continued)

5. Laser cutting apertures with trapezoidal walls and rounded corners may offer better paste release. IPC-7525 may have alternate design recommendations.

# DCK0005A



## PACKAGE OUTLINE

SOT - 1.1 max height

SMALL OUTLINE TRANSISTOR

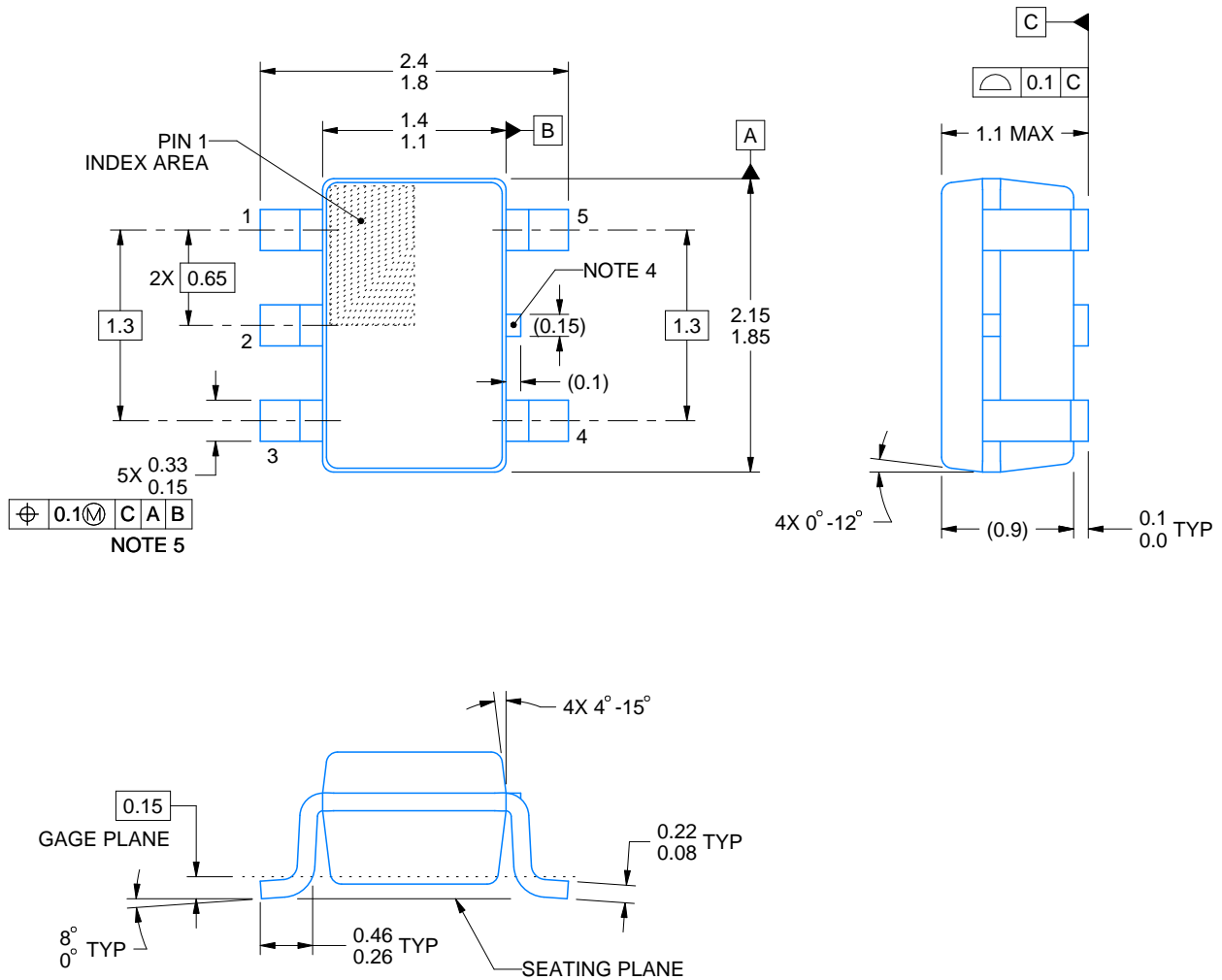

4214834/G 11/2024

### NOTES:

1. All linear dimensions are in millimeters. Any dimensions in parenthesis are for reference only. Dimensioning and tolerancing per ASME Y14.5M.
2. This drawing is subject to change without notice.
3. Reference JEDEC MO-203.
4. Support pin may differ or may not be present.
5. Lead width does not comply with JEDEC.
6. Body dimensions do not include mold flash, protrusions, or gate burrs. Mold flash, protrusions, or gate burrs shall not exceed 0.25mm per side

# EXAMPLE BOARD LAYOUT

DCK0005A

SOT - 1.1 max height

SMALL OUTLINE TRANSISTOR



LAND PATTERN EXAMPLE  
EXPOSED METAL SHOWN  
SCALE:18X

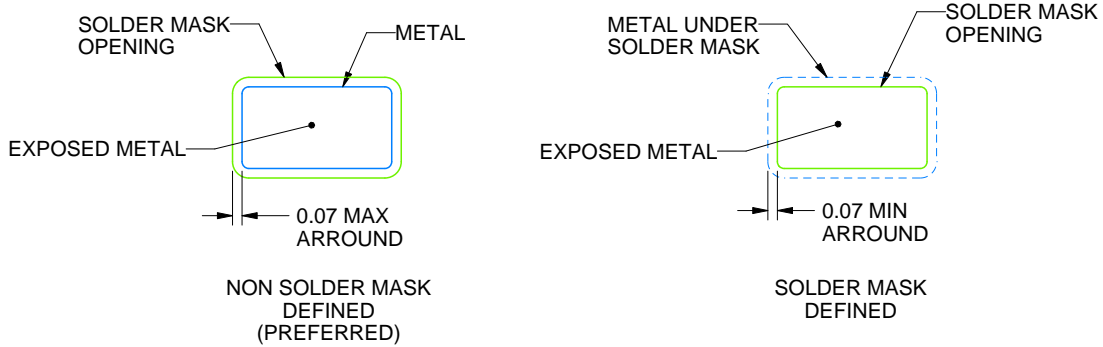

SOLDER MASK DETAILS

4214834/G 11/2024

NOTES: (continued)

- 7. Publication IPC-7351 may have alternate designs.
- 8. Solder mask tolerances between and around signal pads can vary based on board fabrication site.

# EXAMPLE STENCIL DESIGN

DCK0005A

SOT - 1.1 max height

SMALL OUTLINE TRANSISTOR



SOLDER PASTE EXAMPLE  
BASED ON 0.125 THICK STENCIL  
SCALE:18X

4214834/G 11/2024

NOTES: (continued)

9. Laser cutting apertures with trapezoidal walls and rounded corners may offer better paste release. IPC-7525 may have alternate design recommendations.
10. Board assembly site may have different recommendations for stencil design.

# DDF0008A



# PACKAGE OUTLINE

## SOT-23-THIN - 1.1 mm max height

PLASTIC SMALL OUTLINE



4222047/E 07/2024

**NOTES:**

1. All linear dimensions are in millimeters. Any dimensions in parenthesis are for reference only. Dimensioning and tolerancing per ASME Y14.5M.
2. This drawing is subject to change without notice.
3. This dimension does not include mold flash, protrusions, or gate burrs. Mold flash, protrusions, or gate burrs shall not exceed 0.15 mm per side.

# EXAMPLE BOARD LAYOUT

DDF0008A

SOT-23-THIN - 1.1 mm max height

PLASTIC SMALL OUTLINE

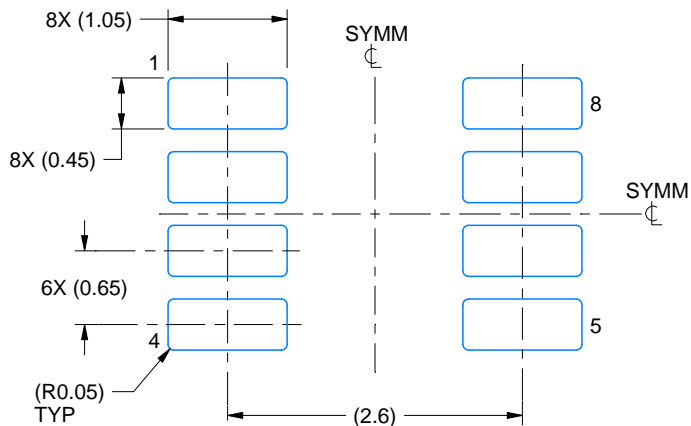

LAND PATTERN EXAMPLE  
EXPOSED METAL SHOWN  
SCALE:15X

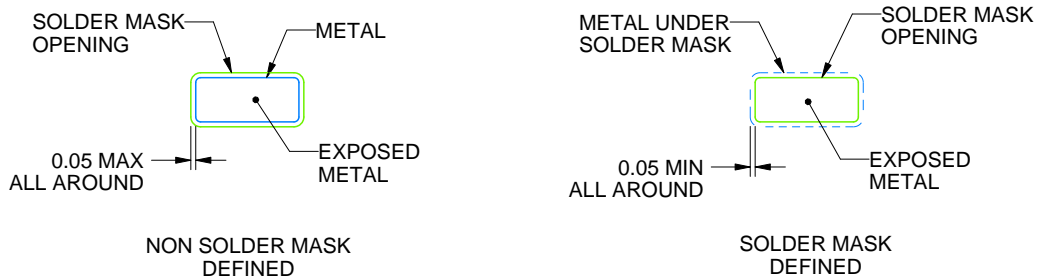

SOLDER MASK DETAILS

4222047/E 07/2024

NOTES: (continued)

- 4. Publication IPC-7351 may have alternate designs.
- 5. Solder mask tolerances between and around signal pads can vary based on board fabrication site.

# EXAMPLE STENCIL DESIGN

DDF0008A

SOT-23-THIN - 1.1 mm max height

PLASTIC SMALL OUTLINE



SOLDER PASTE EXAMPLE  
BASED ON 0.125 mm THICK STENCIL  
SCALE:15X

4222047/E 07/2024

NOTES: (continued)

6. Laser cutting apertures with trapezoidal walls and rounded corners may offer better paste release. IPC-7525 may have alternate design recommendations.
7. Board assembly site may have different recommendations for stencil design.



D0008A

# PACKAGE OUTLINE

SOIC - 1.75 mm max height

SMALL OUTLINE INTEGRATED CIRCUIT



4214825/C 02/2019

### NOTES:

- Linear dimensions are in inches [millimeters]. Dimensions in parenthesis are for reference only. Controlling dimensions are in inches. Dimensioning and tolerancing per ASME Y14.5M.
- This drawing is subject to change without notice.
- This dimension does not include mold flash, protrusions, or gate burrs. Mold flash, protrusions, or gate burrs shall not exceed .006 [0.15] per side.
- This dimension does not include interlead flash.
- Reference JEDEC registration MS-012, variation AA.

# EXAMPLE BOARD LAYOUT

D0008A

SOIC - 1.75 mm max height

SMALL OUTLINE INTEGRATED CIRCUIT



LAND PATTERN EXAMPLE  
 EXPOSED METAL SHOWN  
 SCALE:8X



SOLDER MASK DETAILS

4214825/C 02/2019

NOTES: (continued)

6. Publication IPC-7351 may have alternate designs.

7. Solder mask tolerances between and around signal pads can vary based on board fabrication site.

# EXAMPLE STENCIL DESIGN

D0008A

SOIC - 1.75 mm max height

SMALL OUTLINE INTEGRATED CIRCUIT



SOLDER PASTE EXAMPLE  
BASED ON .005 INCH [0.125 MM] THICK STENCIL  
SCALE:8X

4214825/C 02/2019

NOTES: (continued)

8. Laser cutting apertures with trapezoidal walls and rounded corners may offer better paste release. IPC-7525 may have alternate design recommendations.
9. Board assembly site may have different recommendations for stencil design.

# DBV0006A



# PACKAGE OUTLINE

SOT-23 - 1.45 mm max height

SMALL OUTLINE TRANSISTOR

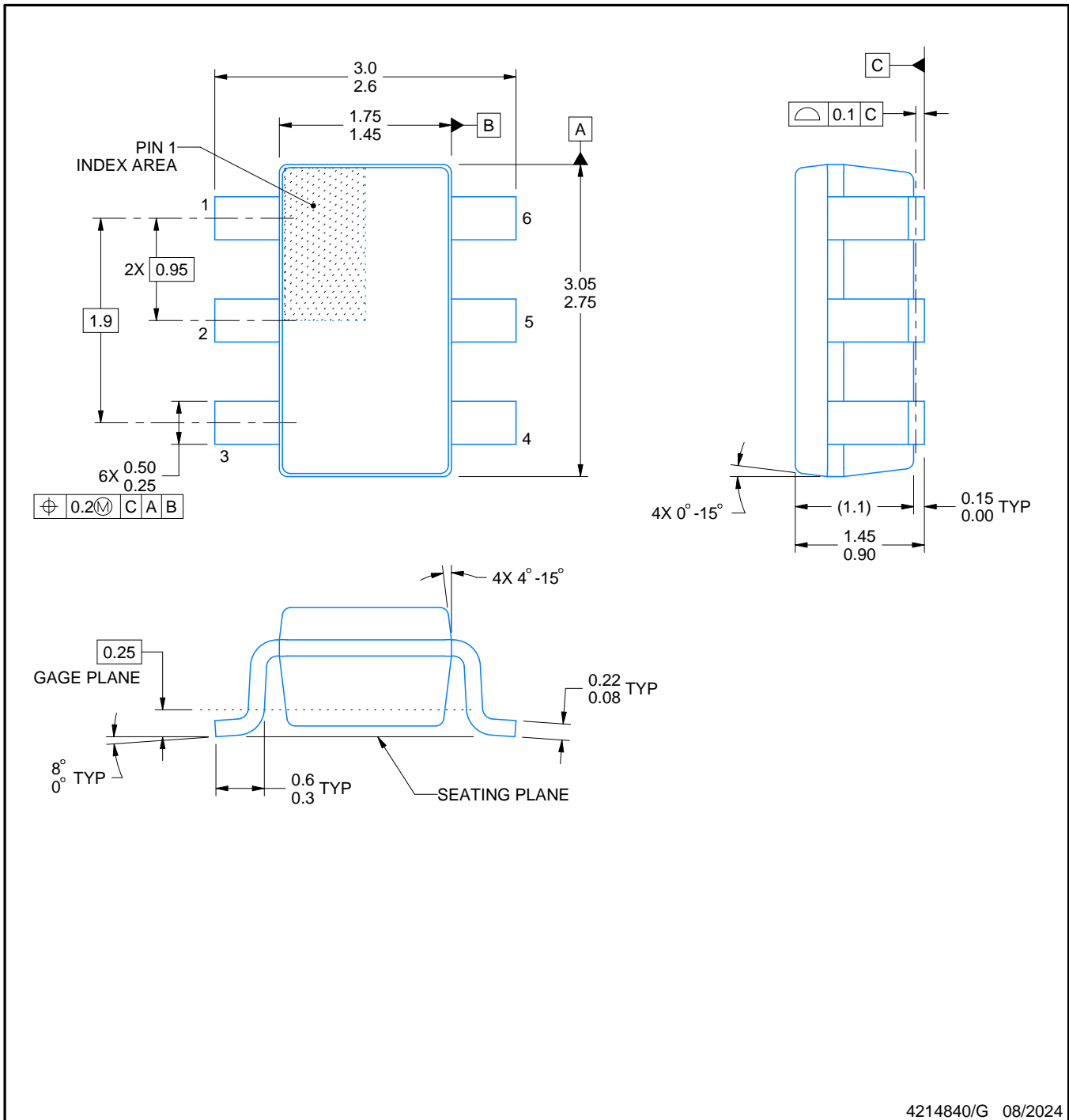

4214840/G 08/2024

## NOTES:

1. All linear dimensions are in millimeters. Any dimensions in parenthesis are for reference only. Dimensioning and tolerancing per ASME Y14.5M.
2. This drawing is subject to change without notice.
3. Body dimensions do not include mold flash or protrusion. Mold flash and protrusion shall not exceed 0.25 per side.
4. Leads 1,2,3 may be wider than leads 4,5,6 for package orientation.
5. Reference JEDEC MO-178.

# EXAMPLE BOARD LAYOUT

DBV0006A

SOT-23 - 1.45 mm max height

SMALL OUTLINE TRANSISTOR



LAND PATTERN EXAMPLE  
EXPOSED METAL SHOWN  
SCALE:15X



SOLDER MASK DETAILS

4214840/G 08/2024

NOTES: (continued)

- 6. Publication IPC-7351 may have alternate designs.
- 7. Solder mask tolerances between and around signal pads can vary based on board fabrication site.

# EXAMPLE STENCIL DESIGN

DBV0006A

SOT-23 - 1.45 mm max height

SMALL OUTLINE TRANSISTOR



SOLDER PASTE EXAMPLE  
BASED ON 0.125 mm THICK STENCIL  
SCALE:15X

4214840/G 08/2024

NOTES: (continued)

8. Laser cutting apertures with trapezoidal walls and rounded corners may offer better paste release. IPC-7525 may have alternate design recommendations.
9. Board assembly site may have different recommendations for stencil design.

## GENERIC PACKAGE VIEW

**DSG 8**

**WSON - 0.8 mm max height**

2 x 2, 0.5 mm pitch

PLASTIC SMALL OUTLINE - NO LEAD

This image is a representation of the package family, actual package may vary.  
Refer to the product data sheet for package details.

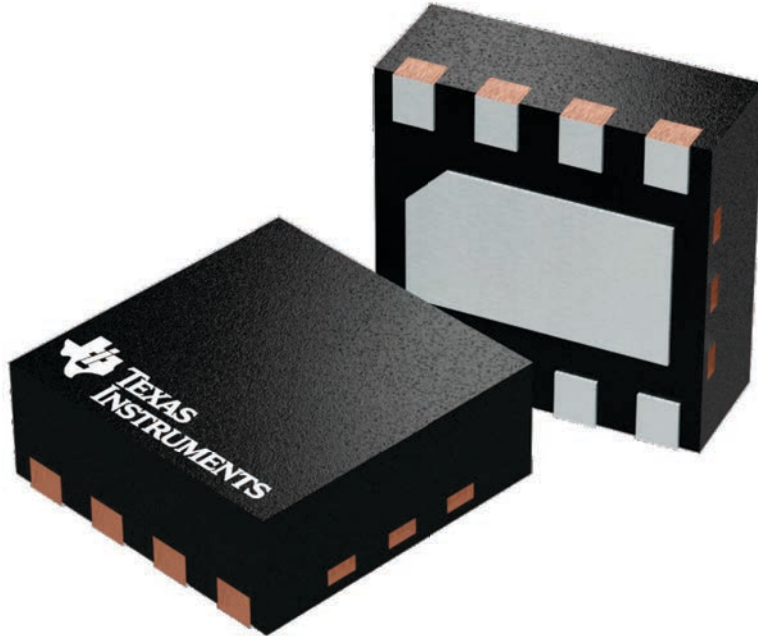

4224783/A

# DSG0008A



# PACKAGE OUTLINE

## WSON - 0.8 mm max height

PLASTIC SMALL OUTLINE - NO LEAD

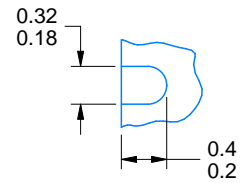
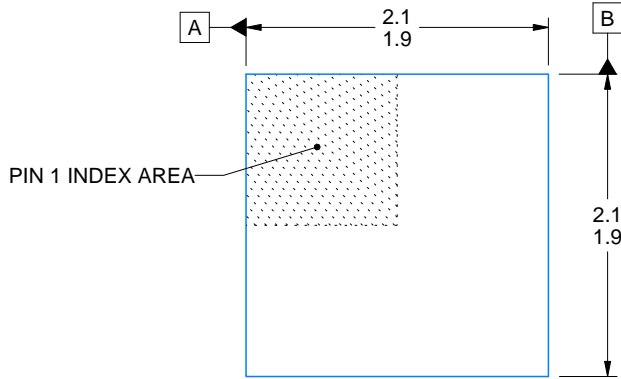

ALTERNATIVE TERMINAL SHAPE TYPICAL

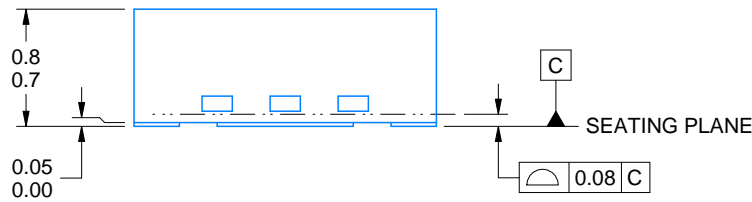

SIDE WALL METAL THICKNESS DIM A	
OPTION 1	OPTION 2
0.1	0.2

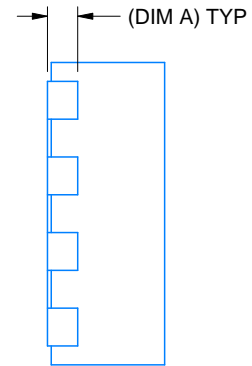
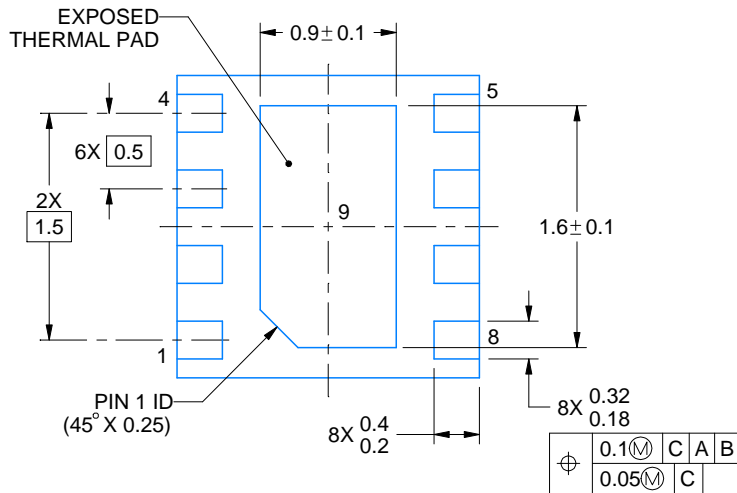

4218900/E 08/2022

### NOTES:

1. All linear dimensions are in millimeters. Any dimensions in parenthesis are for reference only. Dimensioning and tolerancing per ASME Y14.5M.
2. This drawing is subject to change without notice.
3. The package thermal pad must be soldered to the printed circuit board for thermal and mechanical performance.

# EXAMPLE BOARD LAYOUT

DSG0008A

WSON - 0.8 mm max height

PLASTIC SMALL OUTLINE - NO LEAD



LAND PATTERN EXAMPLE  
SCALE:20X



SOLDER MASK DETAILS

4218900/E 08/2022

NOTES: (continued)

4. This package is designed to be soldered to a thermal pad on the board. For more information, see Texas Instruments literature number SLUA271 ([www.ti.com/lit/slua271](http://www.ti.com/lit/slua271)).
5. Vias are optional depending on application, refer to device data sheet. If any vias are implemented, refer to their locations shown on this view. It is recommended that vias under paste be filled, plugged or tented.

# EXAMPLE STENCIL DESIGN

DSG0008A

WSON - 0.8 mm max height

PLASTIC SMALL OUTLINE - NO LEAD

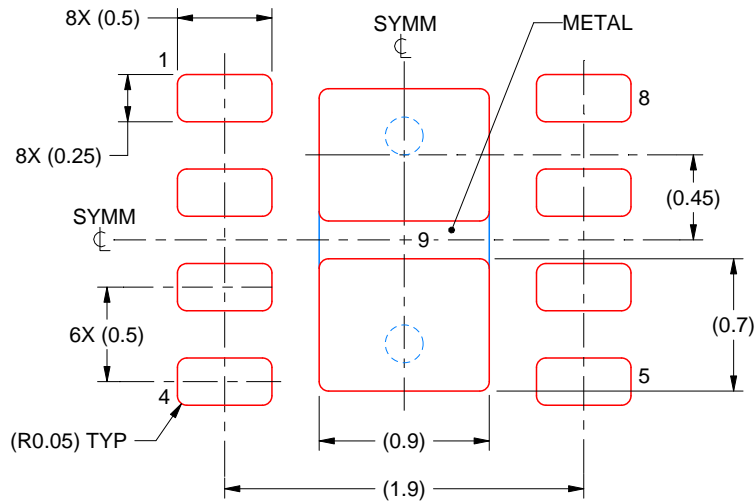

SOLDER PASTE EXAMPLE  
BASED ON 0.125 mm THICK STENCIL

EXPOSED PAD 9:  
87% PRINTED SOLDER COVERAGE BY AREA UNDER PACKAGE  
SCALE:25X

4218900/E 08/2022

NOTES: (continued)

6. Laser cutting apertures with trapezoidal walls and rounded corners may offer better paste release. IPC-7525 may have alternate design recommendations.

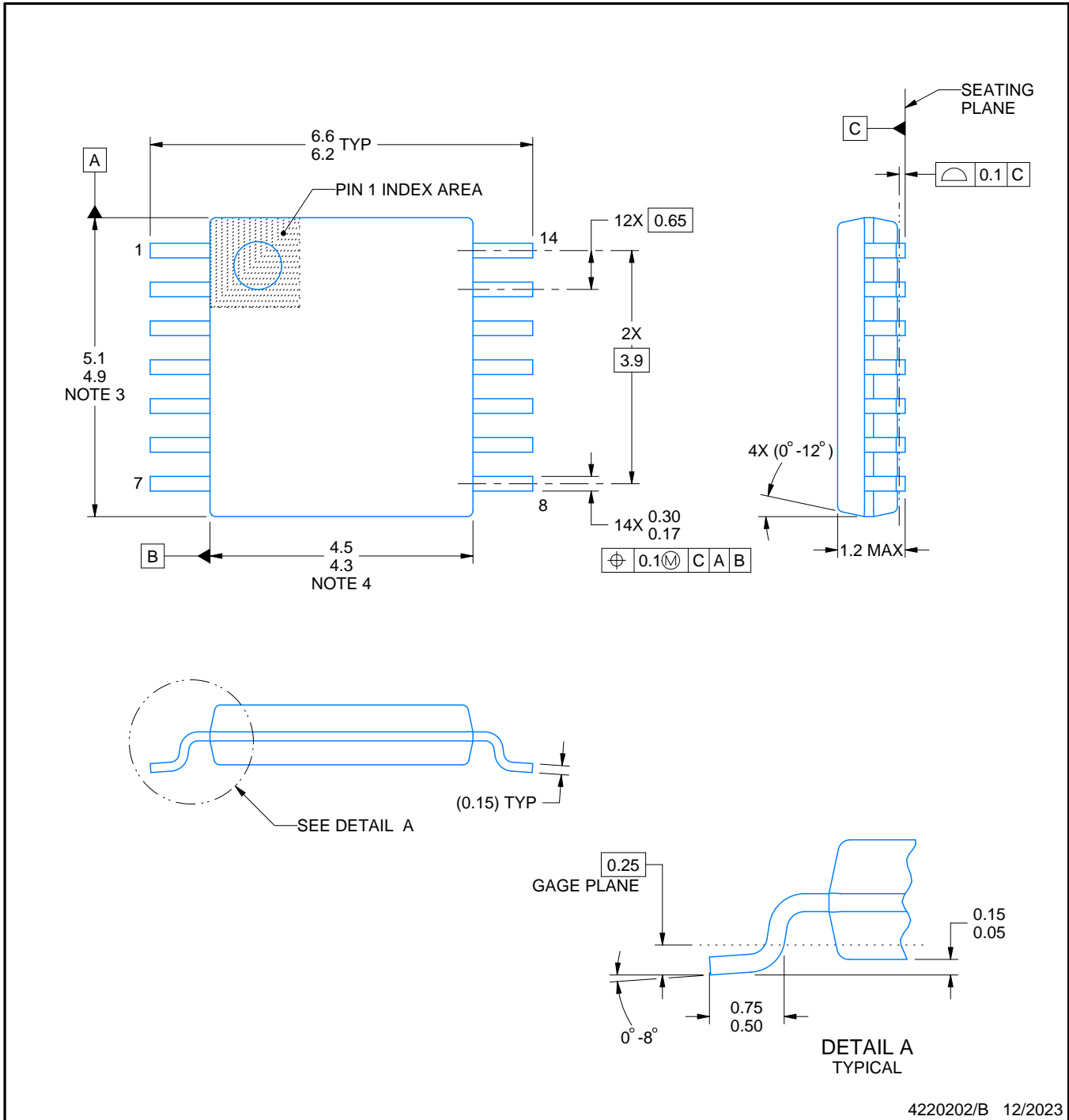
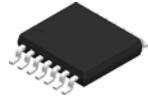

4220202/B 12/2023

NOTES:

1. All linear dimensions are in millimeters. Any dimensions in parenthesis are for reference only. Dimensioning and tolerancing per ASME Y14.5M.
2. This drawing is subject to change without notice.
3. This dimension does not include mold flash, protrusions, or gate burrs. Mold flash, protrusions, or gate burrs shall not exceed 0.15 mm per side.
4. This dimension does not include interlead flash. Interlead flash shall not exceed 0.25 mm per side.
5. Reference JEDEC registration MO-153.

# EXAMPLE BOARD LAYOUT

PW0014A

TSSOP - 1.2 mm max height

SMALL OUTLINE PACKAGE

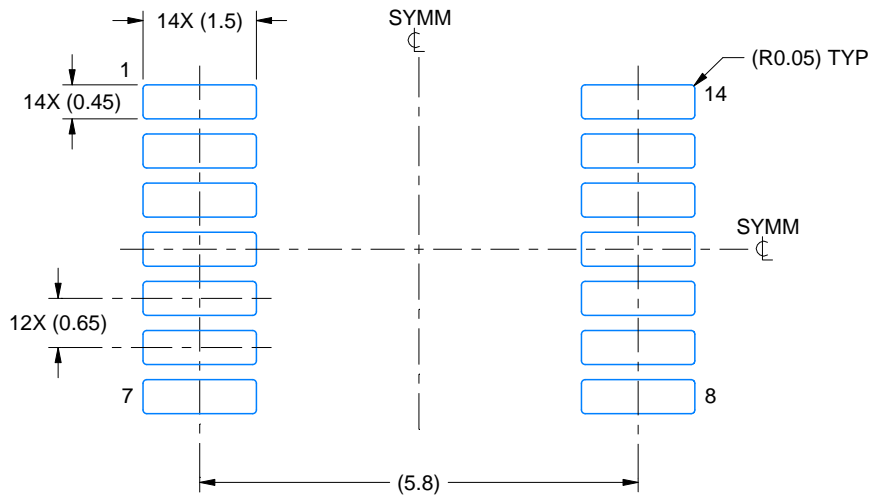

LAND PATTERN EXAMPLE  
EXPOSED METAL SHOWN  
SCALE: 10X



4220202/B 12/2023

NOTES: (continued)

- 6. Publication IPC-7351 may have alternate designs.
- 7. Solder mask tolerances between and around signal pads can vary based on board fabrication site.

# EXAMPLE STENCIL DESIGN

PW0014A

TSSOP - 1.2 mm max height

SMALL OUTLINE PACKAGE



SOLDER PASTE EXAMPLE  
BASED ON 0.125 mm THICK STENCIL  
SCALE: 10X

4220202/B 12/2023

NOTES: (continued)

8. Laser cutting apertures with trapezoidal walls and rounded corners may offer better paste release. IPC-7525 may have alternate design recommendations.
9. Board assembly site may have different recommendations for stencil design.

PW0008A



**PACKAGE OUTLINE**  
**TSSOP - 1.2 mm max height**

SMALL OUTLINE PACKAGE

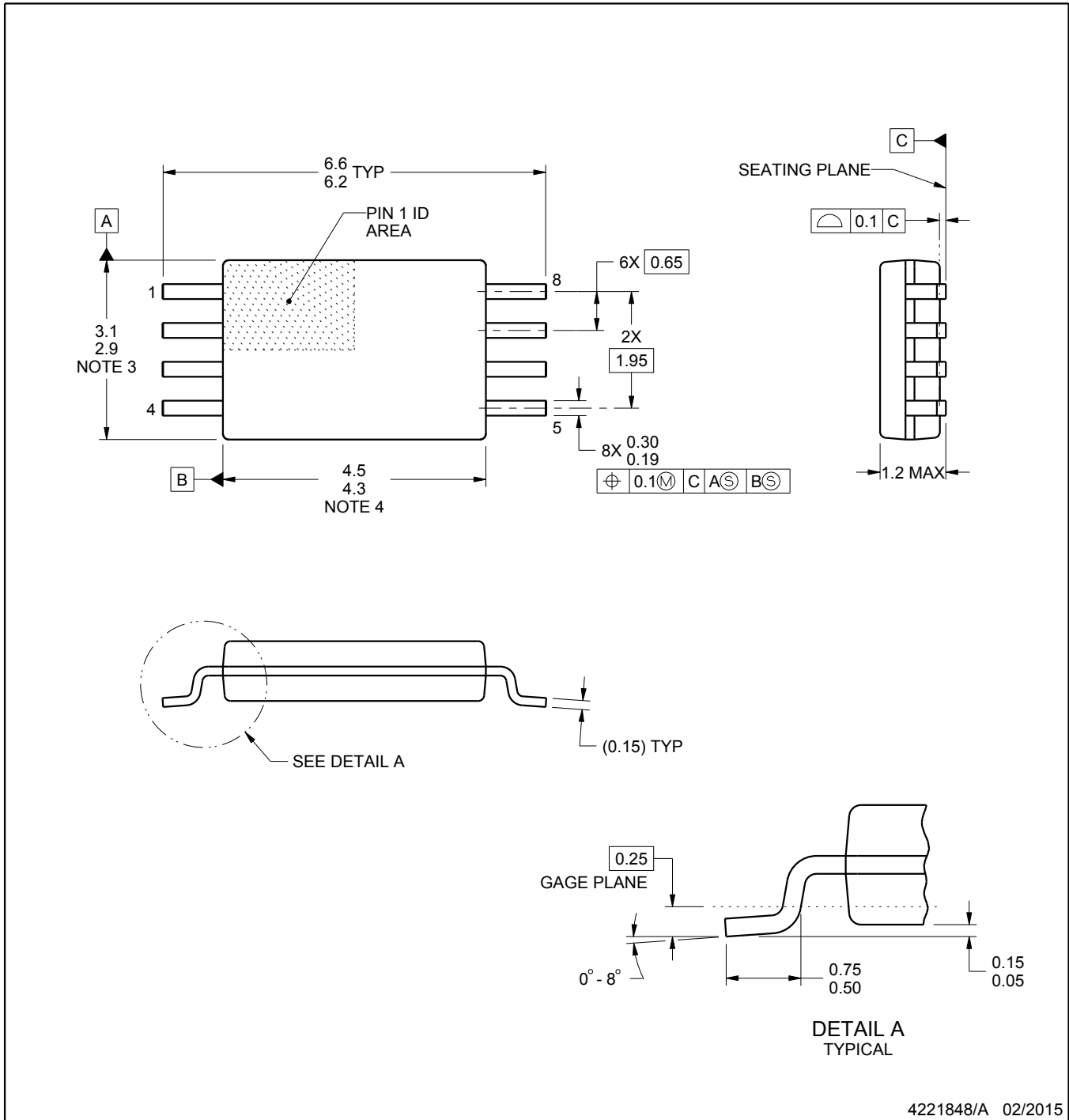

4221848/A 02/2015

NOTES:

1. All linear dimensions are in millimeters. Any dimensions in parenthesis are for reference only. Dimensioning and tolerancing per ASME Y14.5M.
2. This drawing is subject to change without notice.
3. This dimension does not include mold flash, protrusions, or gate burrs. Mold flash, protrusions, or gate burrs shall not exceed 0.15 mm per side.
4. This dimension does not include interlead flash. Interlead flash shall not exceed 0.25 mm per side.
5. Reference JEDEC registration MO-153, variation AA.

# EXAMPLE BOARD LAYOUT

PW0008A

TSSOP - 1.2 mm max height

SMALL OUTLINE PACKAGE



LAND PATTERN EXAMPLE  
SCALE:10X



SOLDER MASK DETAILS  
NOT TO SCALE

4221848/A 02/2015

NOTES: (continued)

- 6. Publication IPC-7351 may have alternate designs.
- 7. Solder mask tolerances between and around signal pads can vary based on board fabrication site.

# EXAMPLE STENCIL DESIGN

PW0008A

TSSOP - 1.2 mm max height

SMALL OUTLINE PACKAGE



SOLDER PASTE EXAMPLE  
BASED ON 0.125 mm THICK STENCIL  
SCALE:10X

4221848/A 02/2015

NOTES: (continued)

8. Laser cutting apertures with trapezoidal walls and rounded corners may offer better paste release. IPC-7525 may have alternate design recommendations.
9. Board assembly site may have different recommendations for stencil design.

## GENERIC PACKAGE VIEW

**RUC 14**

**X2QFN - 0.4 mm max height**

2 x 2, 0.4 mm pitch

PLASTIC QUAD FLATPACK - NO LEAD

This image is a representation of the package family, actual package may vary.  
Refer to the product data sheet for package details.



4229871/A

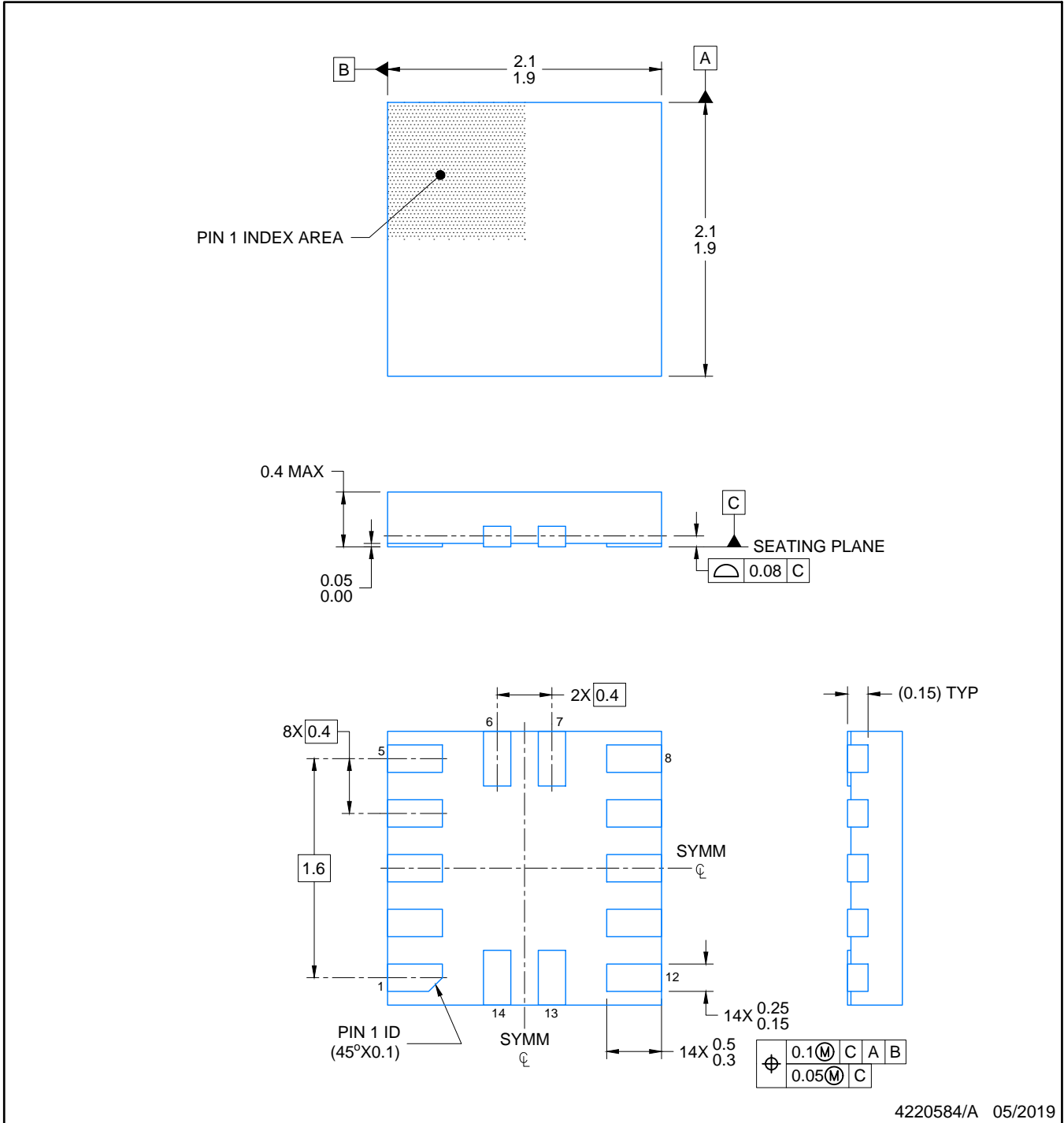

4220584/A 05/2019

NOTES:

1. All linear dimensions are in millimeters. Any dimensions in parenthesis are for reference only. Dimensioning and tolerancing per ASME Y14.5M.
2. This drawing is subject to change without notice.

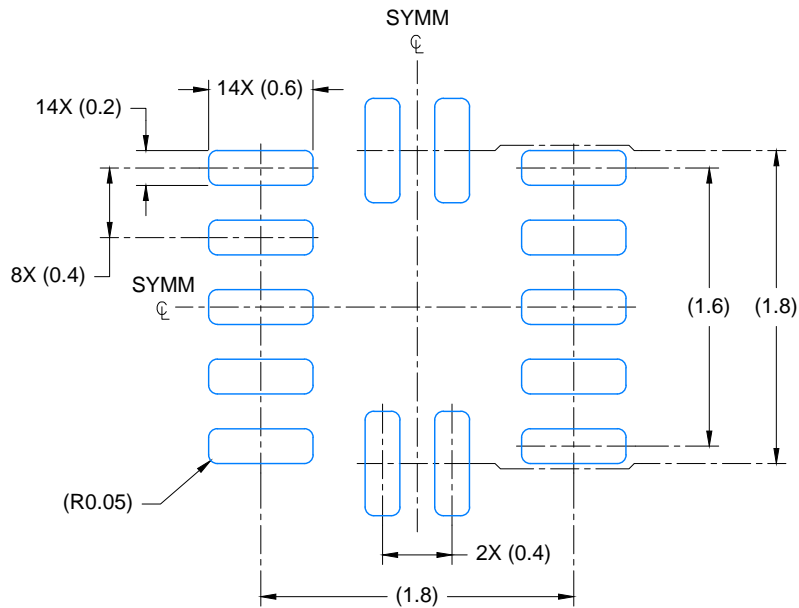

LAND PATTERN EXAMPLE  
EXPOSED METAL SHOWN  
SCALE: 23X

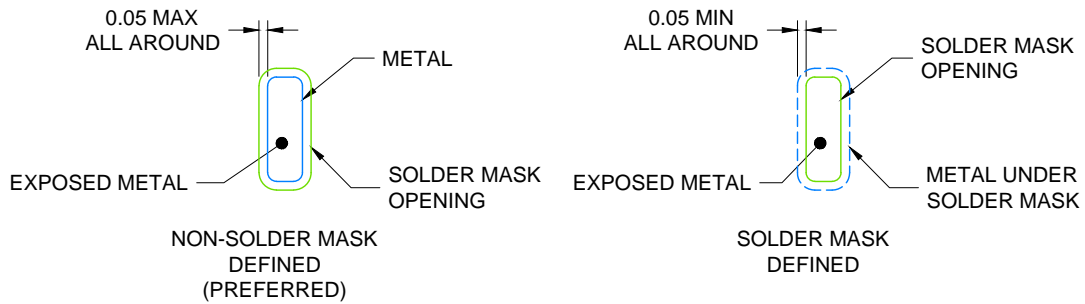

SOLDER MASK DETAILS

4220584/A 05/2019

NOTES: (continued)

- For more information, see Texas Instruments literature number SLUA271 ([www.ti.com/lit/slua271](http://www.ti.com/lit/slua271)).

# EXAMPLE STENCIL DESIGN

RUC0014A

X2QFN - 0.4 mm max height

PLASTIC QUAD FLAT PACK- NO LEAD



SOLDER PASTE EXAMPLE  
BASED ON 0.100mm THICK STENCIL  
SCALE: 23X

4220584/A 05/2019

NOTES: (continued)

4. Laser cutting apertures with trapezoidal walls and rounded corners may offer better paste release. IPC-7525 may have alternate design recommendations.

## IMPORTANT NOTICE AND DISCLAIMER

TI PROVIDES TECHNICAL AND RELIABILITY DATA (INCLUDING DATASHEETS), DESIGN RESOURCES (INCLUDING REFERENCE DESIGNS), APPLICATION OR OTHER DESIGN ADVICE, WEB TOOLS, SAFETY INFORMATION, AND OTHER RESOURCES "AS IS" AND WITH ALL FAULTS, AND DISCLAIMS ALL WARRANTIES, EXPRESS AND IMPLIED, INCLUDING WITHOUT LIMITATION ANY IMPLIED WARRANTIES OF MERCHANTABILITY, FITNESS FOR A PARTICULAR PURPOSE OR NON-INFRINGEMENT OF THIRD PARTY INTELLECTUAL PROPERTY RIGHTS.

These resources are intended for skilled developers designing with TI products. You are solely responsible for (1) selecting the appropriate TI products for your application, (2) designing, validating and testing your application, and (3) ensuring your application meets applicable standards, and any other safety, security, regulatory or other requirements.

These resources are subject to change without notice. TI grants you permission to use these resources only for development of an application that uses the TI products described in the resource. Other reproduction and display of these resources is prohibited. No license is granted to any other TI intellectual property right or to any third party intellectual property right. TI disclaims responsibility for, and you fully indemnify TI and its representatives against any claims, damages, costs, losses, and liabilities arising out of your use of these resources.

TI's products are provided subject to [TI's Terms of Sale](#), [TI's General Quality Guidelines](#), or other applicable terms available either on [ti.com](#) or provided in conjunction with such TI products. TI's provision of these resources does not expand or otherwise alter TI's applicable warranties or warranty disclaimers for TI products. Unless TI explicitly designates a product as custom or customer-specified, TI products are standard, catalog, general purpose devices.

TI objects to and rejects any additional or different terms you may propose.

Copyright © 2026, Texas Instruments Incorporated

Last updated 10/2025