

TLV62085 High Efficiency 3-A Step-Down Converter in 2-mm x 2-mm VSON Package

1 Features

- DCS-Control™ Topology
- Up to 95% Efficiency
- 17- μ A Operating Quiescent Current
- 31m Ω and 23m Ω Power MOSFET Switch
- 2.5-V to 6.0-V Input Voltage Range
- 0.8-V to V_{IN} Adjustable Output Voltage
- Power Save Mode for Light Load Efficiency
- 100% Duty Cycle for Lowest Dropout
- Hiccup Short-Circuit Protection
- Output Discharge
- Power Good Output
- Thermal Shutdown Protection
- Available in 2-mm x 2-mm VSON Package
- For Improved Feature Set, See [TPS62085](#)
- Create a Custom Design using the TLV62085 with the [WEBENCH® Power Designer](#)

2 Applications

- Battery-Powered Applications
- Point-of-Load
- Processor Supplies
- Hard Disk Drives (HDD) / Solid State Drives (SSD)

3 Description

The TLV62085 device is a high-frequency synchronous step-down converter optimized for small solution size and high efficiency. With an input voltage range of 2.5 V to 6.0 V, common battery technologies are supported. The devices focus on high-efficiency step-down conversion over a wide output current range. At medium to heavy loads, the converter operates in PWM mode and automatically enters Power Save Mode operation at light load to maintain high efficiency over the entire load current range.

To address the requirements of system power rails, the internal compensation circuit allows a large selection of external output capacitor values ranging from 10 μ F to 150 μ F and above. Together with its DCS-Control™ architecture, excellent load transient performance and output voltage regulation accuracy are achieved. The device is available in a 2-mm x 2-mm VSON package.

Device Information⁽¹⁾

PART NUMBER	PACKAGE	BODY SIZE (NOM)
TLV62085	VSON (7)	2.00 mm x 2.00 mm

(1) For all available packages, see the orderable addendum at the end of the data sheet.

Typical Application Schematic

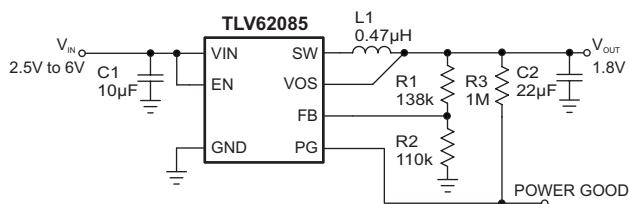

Efficiency at $V_{IN} = 5$ V

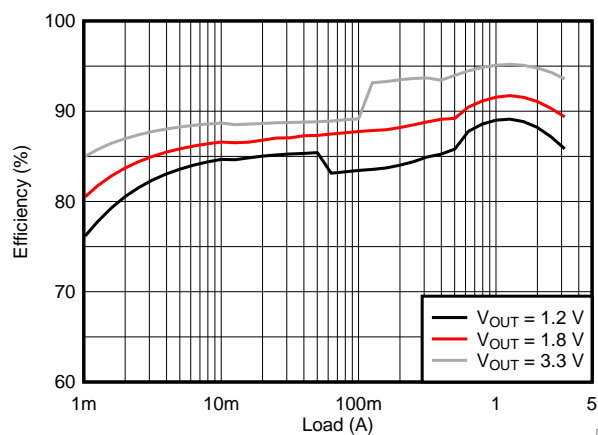

D008



Table of Contents

1 Features	1	8 Application and Implementation	9
2 Applications	1	8.1 Application Information.....	9
3 Description	1	8.2 Typical Application	9
4 Revision History	2	9 Power Supply Recommendations	15
5 Pin Configuration and Functions	3	10 Layout	15
6 Specifications	4	10.1 Layout Guidelines	15
6.1 Absolute Maximum Ratings	4	10.2 Layout Example	15
6.2 ESD Ratings.....	4	10.3 Thermal Considerations	15
6.3 Recommended Operating Conditions.....	4	11 Device and Documentation Support	16
6.4 Thermal Information	4	11.1 Development Support	16
6.5 Electrical Characteristics.....	5	11.2 Documentation Support	16
6.6 Typical Characteristics	5	11.3 Receiving Notification of Documentation Updates	16
7 Detailed Description	6	11.4 Community Resources.....	16
7.1 Overview	6	11.5 Trademarks	16
7.2 Functional Block Diagram	6	11.6 Electrostatic Discharge Caution.....	17
7.3 Feature Description.....	7	11.7 Glossary	17
7.4 Device Functional Modes.....	8	12 Mechanical, Packaging, and Orderable Information	17

4 Revision History

Changes from Revision A (January 2017) to Revision B	Page
• Added Figure 3 to power save mode section	7

Changes from Original (October 2015) to Revision A	Page
• Added WEBENCH™ information and hyperlinks to <i>Features</i> , <i>Detailed Design Procedure</i> , and <i>Device Support</i> sections ..	1
• Added SW (AC) to the <i>Absolute Maximum Rating</i> table	4
• Added Table 1 , PG Pin Logic	8

5 Pin Configuration and Functions

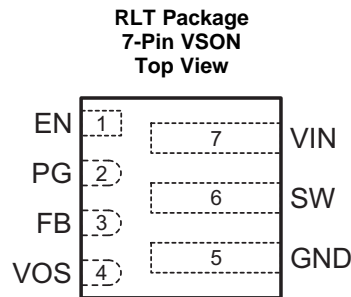

Pin Functions

PIN		I/O	DESCRIPTION
NAME	NO.		
EN	1	IN	Device enable pin. To enable the device, this pin needs to be pulled high. Pulling this pin low disables the device. This pin has a pulldown resistor of typically 400 k Ω when the device is disabled.
FB	3	IN	Feedback pin. Connect a resistor divider to set the output voltage.
GND	5		Ground pin.
PG	2	OUT	Power good open drain output pin. The pullup resistor can not be connected to any voltage higher than 6 V. If unused, leave it floating.
SW	6	PWR	Switch pin of the power stage.
VIN	7	PWR	Input voltage pin.
VOS	4	IN	Output voltage sense pin. This pin must be directly connected to the output capacitor.

6 Specifications

6.1 Absolute Maximum Ratings⁽¹⁾

		MIN	MAX	UNIT
Voltage at Pins ⁽²⁾	VIN, FB, VOS, EN, PG	– 0.3	7	V
	SW (DC)	– 0.3	V _{IN} + 0.3	
	SW (AC, less than 100ns) ⁽³⁾	– 3	11	
Temperature	Operating Junction, T _J	– 40	150	°C
	Storage, T _{stg}	– 65	150	°C

- (1) Stresses beyond those listed under *Absolute Maximum Ratings* may cause permanent damage to the device. These are stress ratings only and functional operation of the device at these or any other conditions beyond those indicated under *Recommended Operating Conditions* is not implied. Exposure to absolute–maximum–rated conditions for extended periods may affect device reliability.
- (2) All voltage values are with respect to network ground terminal.
- (3) While switching.

6.2 ESD Ratings

		VALUE	UNIT
V _(ESD) Electrostatic discharge	Human body model (HBM), per ANSI/ESDA/JEDEC JS-001 ⁽¹⁾	±2000	V
	Charged device model (CDM), per JEDEC specification JESD22-C101 ⁽²⁾	±500	

- (1) JEDEC document JEP155 states that 500-V HBM allows safe manufacturing with a standard ESD control process.
- (2) JEDEC document JEP157 states that 250-V CDM allows safe manufacturing with a standard ESD control process.

6.3 Recommended Operating Conditions⁽¹⁾

		MIN	NOM	MAX	UNIT
V _{IN}	Input voltage range	2.5		6	V
V _{OUT}	Output voltage range	0.8		V _{IN}	V
I _{SINK_PG}	Sink current at PG pin			1	mA
V _{PG}	Pullup resistor voltage			6	V
T _J	Operating junction temperature	–40		125	°C

- (1) Refer to [Application and Implementation](#) for further information.

6.4 Thermal Information

THERMAL METRIC ⁽¹⁾		TLV62085	UNIT
		RLT [VSON]	
		7 PINS	
R _{θJA}	Junction-to-ambient thermal resistance	107.8	°C/W
R _{θJC(top)}	Junction-to-case (top) thermal resistance	66.2	°C/W
R _{θJB}	Junction-to-board thermal resistance	17.1	°C/W
ψ _{JT}	Junction-to-top characterization parameter	2.1	°C/W
ψ _{JB}	Junction-to-board characterization parameter	17.1	°C/W
R _{θJC(bot)}	Junction-to-case (bottom) thermal resistance	N/A	°C/W

- (1) For more information about traditional and new thermal metrics, see the [Semiconductor and IC Package Thermal Metrics](#) application report.

6.5 Electrical Characteristics

T_J = 25 °C, and V_{IN} = 3.6 V, unless otherwise noted.

PARAMETER		TEST CONDITIONS	MIN	TYP	MAX	UNIT
SUPPLY						
I _Q	Quiescent current into VIN	No load, device not switching		17		μA
I _{SD}	Shutdown current into VIN	EN = Low		0.7		μA
V _{UVLO}	Under voltage lock out threshold	V _{IN} falling	2.1	2.2	2.3	V
	Under voltage lock out hysteresis	V _{IN} rising		200		mV
T _{JSD}	Thermal shutdown threshold	T _J rising		150		°C
	Thermal shutdown hysteresis	T _J falling		20		°C
LOGIC INTERFACE EN						
V _{IH}	High-level input voltage	V _{IN} = 2.5 V to 6.0 V	1.0			V
V _{IL}	Low-level input voltage	V _{IN} = 2.5 V to 6.0 V			0.4	V
I _{EN,LKG}	Input leakage current into EN pin	EN = High		0.01		μA
R _{PD}	Pull-down resistance at EN pin	EN = Low		400		kΩ
SOFT START, POWER GOOD						
t _{SS}	Soft start time	Time from EN high to 95% of V _{OUT} nominal		0.8		ms
V _{PG}	Power good threshold	V _{OUT} rising, referenced to V _{OUT} nominal		95%		
		V _{OUT} falling, referenced to V _{OUT} nominal		90%		
V _{PG,OL}	Low-level output voltage	I _{sink} = 1 mA			0.4	V
I _{PG,LKG}	Input leakage current into PG pin	V _{PG} = 5.0 V		0.01		μA
OUTPUT						
V _{FB}	Feedback regulation voltage	PWM mode, 2.5 V ≤ V _{IN} ≤ 6 V T _J = 0°C to 85 °C	792	800	808	mV
I _{FB,LKG}	Feedback input leakage current	V _{FB} = 1 V		0.01		μA
R _{DIS}	Output discharge resistor	EN = LOW, V _{OUT} = 1.8 V		260		Ω
POWER SWITCH						
R _{DS(on)}	High-side FET on-resistance	I _{SW} = 500 mA		31		mΩ
	Low-side FET on-resistance	I _{SW} = 500 mA		23		mΩ
I _{LIM}	High-side FET switch current limit		3.7	4.6	5.5	A
f _{SW}	PWM switching frequency	I _{OUT} = 1 A		2.4		MHz

6.6 Typical Characteristics

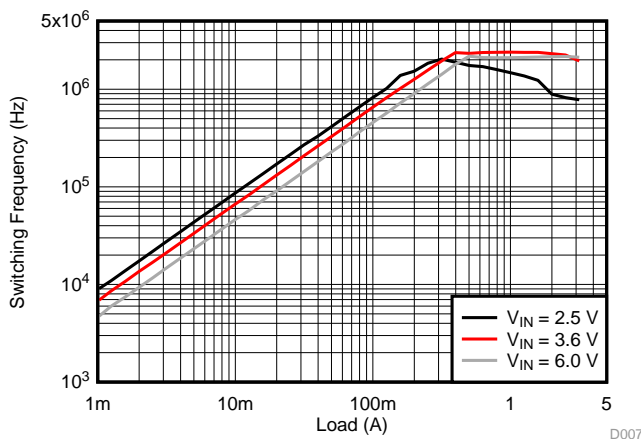

Figure 1. Switching Frequency

7 Detailed Description

7.1 Overview

The TLV62085 synchronous step-down converter is based on the DCS-Control (Direct Control with Seamless transition into Power Save Mode) topology. This is an advanced regulation topology that combines the advantages of hysteretic, voltage, and current mode control schemes.

The DCS-Control topology operates in PWM (pulse width modulation) mode for medium to heavy load conditions and in Power Save Mode at light load currents. In PWM mode, the converter operates with its nominal switching frequency of 2.4 MHz, having a controlled frequency variation over the input voltage range. As the load current decreases, the converter enters Power Save Mode, reducing the switching frequency and minimizing the IC's current consumption to achieve high efficiency over the entire load current range. Because DCS-Control supports both operation modes (PWM and PFM) within a single building block, the transition from PWM mode to Power Save Mode is seamless and without effects on the output voltage. The device offers both excellent DC voltage and superior load transient regulation, combined with very low output voltage ripple, minimizing interference with RF circuits.

7.2 Functional Block Diagram

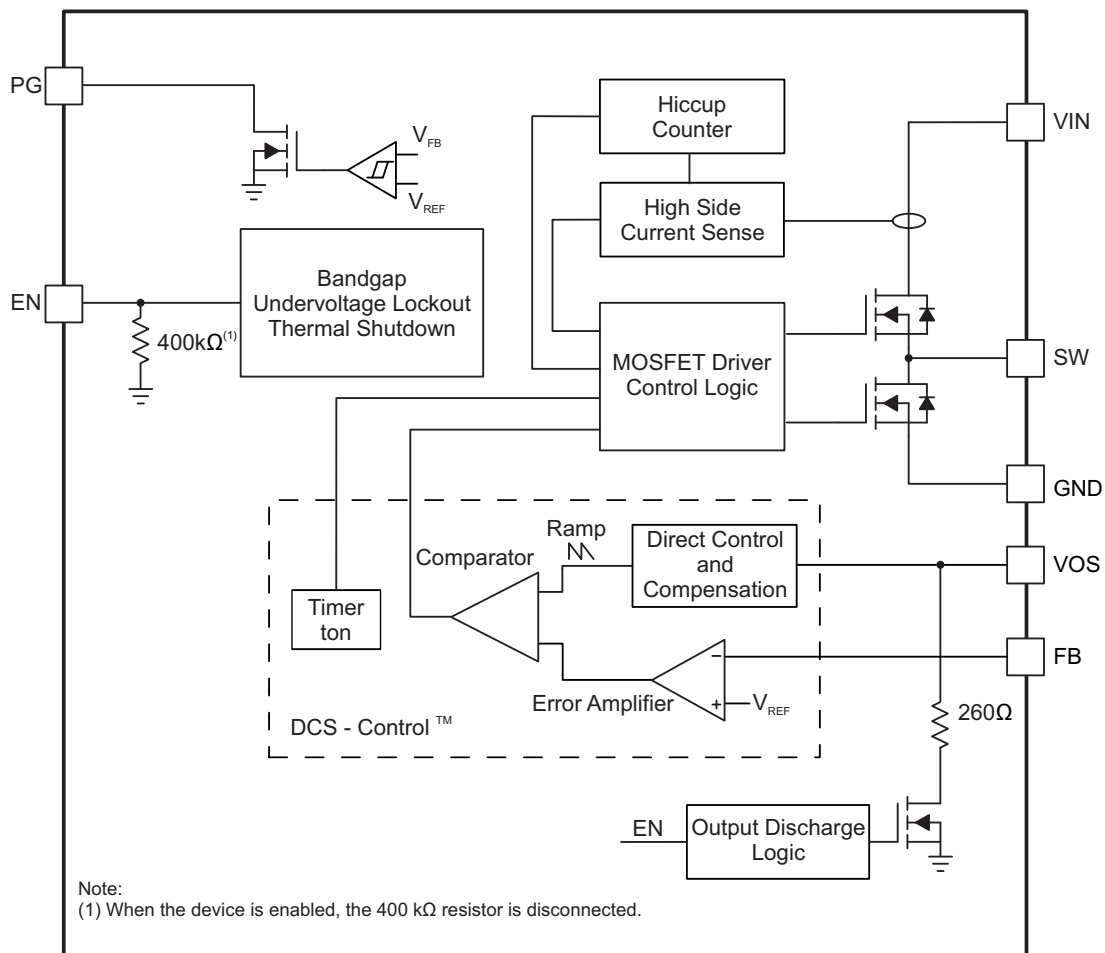

Figure 2. Functional Block Diagram

7.3 Feature Description

7.3.1 Power Save Mode

As the load current decreases, the TLV62085 enters Power Save Mode (PSM) operation. During Power Save Mode, the converter operates with reduced switching frequency and with a minimum quiescent current maintaining high efficiency. Power Save Mode occurs when the inductor current becomes discontinuous. Power Save Mode is based on a fixed on-time architecture, as related in Equation 1. The switching frequency over the whole load current range is also shown in Figure 1 for a shown typical application.

$$t_{ON} = 420 \text{ ns} \times \frac{V_{OUT}}{V_{IN}}$$

$$f_{PFM} = \frac{2 \times I_{OUT}}{t_{ON}^2 \times \frac{V_{IN}}{V_{OUT}} \times \frac{V_{IN} - V_{OUT}}{L}} \quad (1)$$

In PSM, the output voltage rises slightly above the nominal output voltage, as shown in Figure 10. This effect is minimized by increasing the output capacitor or inductor value.

During PAUSE period in PSM (shown in Figure 3), the device does not change the PG pin state nor does it detect an UVLO event, in order to achieve a minimum quiescent current and maintain high efficiency at light loads.

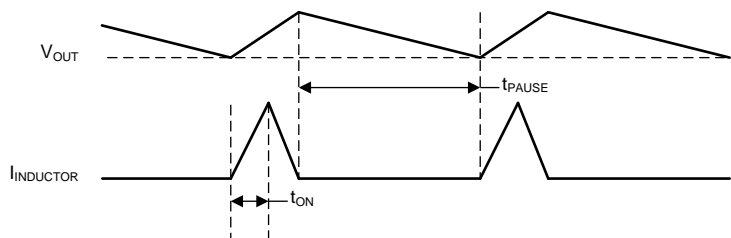

Figure 3. Power Save Mode Waveform Diagram

7.3.2 100% Duty Cycle Low Dropout Operation

The device offers low input-to-output voltage difference by entering 100% duty cycle mode. In this mode, the high-side MOSFET switch is constantly turned on and the low-side MOSFET is switched off. This is particularly useful in battery powered applications to achieve the longest operation time by taking full advantage of the whole battery voltage range. The minimum input voltage to maintain output regulation, depending on the load current and output voltage can be calculated as:

$$V_{IN,MIN} = V_{OUT} + I_{OUT,MAX} \times (R_{DS(on)} + R_L)$$

with

- V_{IN,MIN} = Minimum input voltage to maintain an output voltage
- I_{OUT,MAX} = Maximum output current
- R_{DS(on)} = High-side FET ON-resistance
- R_L = Inductor ohmic resistance (DCR) (2)

7.3.3 Soft Start

The TLV62085 has an internal soft-start circuitry which monotonically ramps up the output voltage and reaches the nominal output voltage during a soft-start time of typically 0.8 ms. This avoids excessive inrush current and creates a smooth output voltage slope. It also prevents excessive voltage drops of primary cells and rechargeable batteries with high internal impedance. The device is able to start into a prebiased output capacitor. The device starts with the applied bias voltage and ramps the output voltage to its nominal value.

Feature Description (continued)

7.3.4 Switch Current Limit and Hiccup Short-Circuit Protection

The switch current limit prevents the device from high inductor current and from drawing excessive current from the battery or input voltage rail. Excessive current might occur with a shorted or saturated inductor or a heavy load or shorted output circuit condition. If the inductor current reaches the threshold I_{LIM} , the high-side MOSFET is turned off and the low-side MOSFET is turned on to ramp down the inductor current. When this switch current limits is triggered 32 times, the device stops switching and enables the output discharge. The device then automatically starts a new start-up after a typical delay time of 66 μ s has passed. This is named HICCUP short-circuit protection. The device repeats this mode until the high load condition disappears.

7.3.5 Undervoltage Lockout

To avoid misoperation of the device at low input voltages, an undervoltage lockout (UVLO) is implemented, which shuts down the device at voltages lower than V_{UVLO} with a hysteresis of 200 mV.

7.3.6 Thermal Shutdown

The device goes into thermal shutdown and stops switching when the junction temperature exceeds T_{JSD} . When the device temperature falls below the threshold by 20°C, the device returns to normal operation automatically.

7.4 Device Functional Modes

7.4.1 Enable and Disable

The device is enabled by setting the EN pin to a logic HIGH. Accordingly, shutdown mode is forced if the EN pin is pulled LOW with a shutdown current of typically 0.7 μ A.

In shutdown mode, the internal power switches as well as the entire control circuitry are turned off. An internal resistor of 260 Ω discharges the output through the VOS pin smoothly. The output discharge function also works when thermal shutdown, UVLO, or short-circuit protection are triggered.

An internal pulldown resistor of 400 k Ω is connected to the EN pin when the EN pin is LOW. The pulldown resistor is disconnected when the EN pin is HIGH.

7.4.2 Power Good

The TLV62085 has a power good output. The power good goes high impedance once the output is above 95% of the nominal voltage, and is driven low once the output voltage falls below typically 90% of the nominal voltage. The PG pin is an open-drain output and is specified to sink up to 1 mA. The power good output requires a pull-up resistor connecting to any voltage rail less than 6 V. The PG signal can be used for sequencing of multiple rails by connecting it to the EN pin of other converters. Leave the PG pin unconnected when not used. [Table 1](#) shows the PG pin logic.

Table 1. PG Pin Logic

DEVICE CONDITIONS		LOGIC STATUS	
		HIGH Z	LOW
Enable	EN = High, $V_{FB} \geq V_{PG}$	√	
	EN = High, $V_{FB} \leq V_{PG}$		√
Shutdown	EN = Low		√
Thermal Shutdown	$T_J > T_{JSD}$		√
UVLO	$0.5 \text{ V} < V_{IN} < V_{UVLO}$		√
Power Supply Removal	$V_{IN} \leq 0.5 \text{ V}$	√	

8 Application and Implementation

NOTE

Information in the following applications sections is not part of the TI component specification, and TI does not warrant its accuracy or completeness. TI's customers are responsible for determining suitability of components for their purposes. Customers should validate and test their design implementation to confirm system functionality.

8.1 Application Information

The TLV62085 is a synchronous step-down converter in which output voltage is adjusted by component selection. The following section discusses the design of the external components to complete the power supply design for several input and output voltage options by using the typical applications as a reference.

8.2 Typical Application

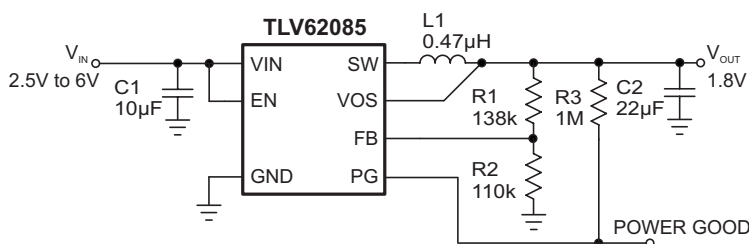

Figure 4. 1.8-V Output Voltage Application

8.2.1 Design Requirements

For this design example, use the parameters listed in Table 2 as the input parameters.

Table 2. Design Parameters

DESIGN PARAMETER	EXAMPLE VALUE
Input voltage	2.5 V to 6 V
Output voltage	1.8 V
Output current	≤ 3 A
Output ripple voltage	<30 mV

Table 3 lists the components used for the example.

Table 3. List of Components⁽¹⁾

REFERENCE	DESCRIPTION	MANUFACTURER
C1	10 µF, Ceramic capacitor, 10 V, X7R, size 0805, GRM21BR71A106ME51L	Murata
C2	22 µF, Ceramic capacitor, 6.3 V, X5R, size 0805, GRM21BR60J226ME39L	Murata
L1	0.47 µH, Power Inductor, size 4 mm × 4 mm × 1.5 mm, XFL4015-471ME	Coilcraft
R1	Depending on the output voltage, 1%, size 0603;	Std
R2	110 kΩ, Chip resistor, 1/16 W, 1%, size 0603;	Std
R3	1 MΩ, Chip resistor, 1/16 W, 1%, size 0603	Std

(1) See [Third-Party Products](#) disclaimer.

8.2.2 Detailed Design Procedure

8.2.2.1 Custom Design with WEBENCH® Tools

[Click here](#) to create a custom design using the TLV62085 device with the WEBENCH® Power Designer.

1. Start by entering your V_{IN} , V_{OUT} , and I_{OUT} requirements.
2. Optimize your design for key parameters like efficiency, footprint and cost using the optimizer dial and compare this design with other possible solutions from Texas Instruments.
3. The WEBENCH Power Designer provides you with a customized schematic along with a list of materials with real time pricing and component availability.
4. In most cases, you will also be able to:
 - Run electrical simulations to see important waveforms and circuit performance
 - Run thermal simulations to understand the thermal performance of your board
 - Export your customized schematic and layout into popular CAD formats
 - Print PDF reports for the design, and share your design with colleagues
5. Get more information about WEBENCH tools at www.ti.com/WEBENCH.

8.2.2.2 Setting The Output Voltage

The output voltage is set by an external resistor divider according to [Equation 3](#):

$$V_{OUT} = V_{FB} \times \left(1 + \frac{R1}{R2}\right) = 0.8 \text{ V} \times \left(1 + \frac{R1}{R2}\right) \quad (3)$$

R2 must not be higher than 180 k Ω to achieve high efficiency at light load while providing acceptable noise sensitivity.

8.2.2.3 Output Filter Design

The inductor and the output capacitor together provide a low-pass filter. To simplify the selection process, [Table 4](#) outlines possible inductor and capacitor value combinations for most applications.

Table 4. Matrix of Output Capacitor and Inductor Combinations

NOMINAL L [μ H] ⁽¹⁾	NOMINAL C _{OUT} [μ F] ⁽²⁾				
	10	22	47	100	150
0.47		+ ⁽³⁾	+	+	+
1	+	+	+	+	+
2.2					

(1) Inductor tolerance and current derating is anticipated. The effective inductance can vary by 20% and –30%.

(2) Capacitance tolerance and bias voltage derating is anticipated. The effective capacitance can vary by 20% and –50%.

(3) Typical application configuration. Other '+' mark indicates recommended filter combinations.

8.2.2.4 Inductor Selection

The main parameter for the inductor selection is the inductor value and then the saturation current of the inductor. To calculate the maximum inductor current under static load conditions, [Equation 4](#) is given.

$$I_{L,MAX} = I_{OUT,MAX} + \frac{\Delta I_L}{2}$$

$$\Delta I_L = V_{OUT} \times \frac{1 - \frac{V_{OUT}}{V_{IN}}}{L \times f_{SW}}$$

where

- $I_{OUT,MAX}$ = Maximum output current
- ΔI_L = Inductor current ripple

- f_{sw} = Switching frequency
 - L = Inductor value
- (4)

TI recommends choosing the saturation current for the inductor 20% to 30% higher than the $I_{L,MAX}$, out of Equation 4. A higher inductor value is also useful to lower ripple current but increases the transient response time as well. The following inductors are recommended to be used in designs.

Table 5. List of Recommended Inductors⁽¹⁾

INDUCTANCE [μ H]	CURRENT RATING [A]	DIMENSIONS L x W x H [mm^3]	DC RESISTANCE [m Ω typical]	PART NUMBER
0.47	6.6	4 x 4 x 1.5	7.6	Coilcraft XFL4015-471
0.47	4.7	3.2 x 2.5 x 1.2	21	TOKO DFE322512-R47N
1	5.1	4 x 4 x 2	10.8	Coilcraft XFL4020-102

(1) See [Third-Party Products](#) disclaimer.

8.2.2.5 Capacitor Selection

The input capacitor is the low-impedance energy source for the converter which helps to provide stable operation. A low ESR multilayer ceramic capacitor is recommended for best filtering and must be placed between VIN and GND as close as possible to those pins. For most applications, 10 μ F is sufficient, though a larger value reduces input current ripple.

The architecture of the TLV62085 allows the use of tiny ceramic output capacitors with low equivalent series resistance (ESR). These capacitors provide low output voltage ripple and are recommended. To keep its low resistance up to high frequencies and to get narrow capacitance variation with temperature, TI recommends using X7R or X5R dielectrics. The recommended typical output capacitor value is 22 μ F; this capacitance can vary over a wide range as outline in the output filter selection table. Output capacitors above 150 μ F may be used with a reduced load current during startup to avoid triggering the short circuit protection.

A feed-forward capacitor is not required for device proper operation.

8.2.3 Application Curves

$V_{IN} = 3.6\text{ V}$, $T_A = 25\text{ }^\circ\text{C}$, unless otherwise noted

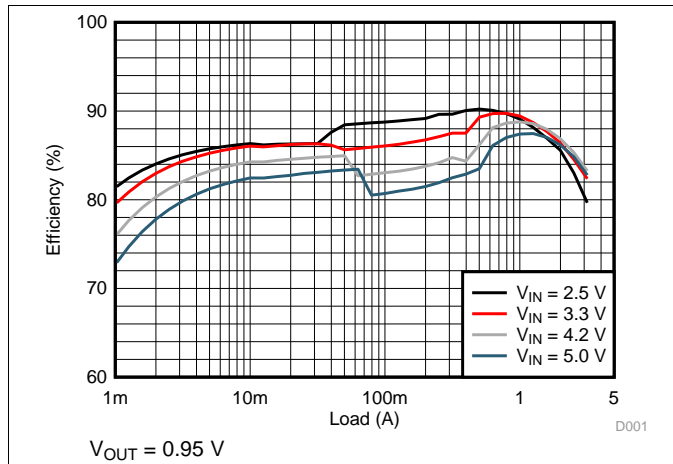

Figure 5. Efficiency

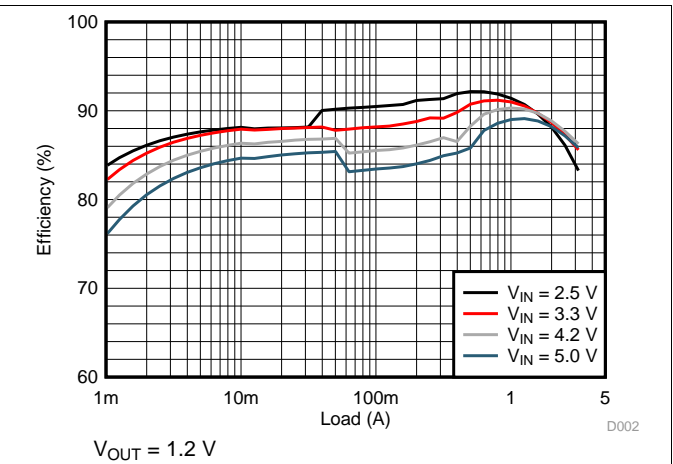

Figure 6. Efficiency

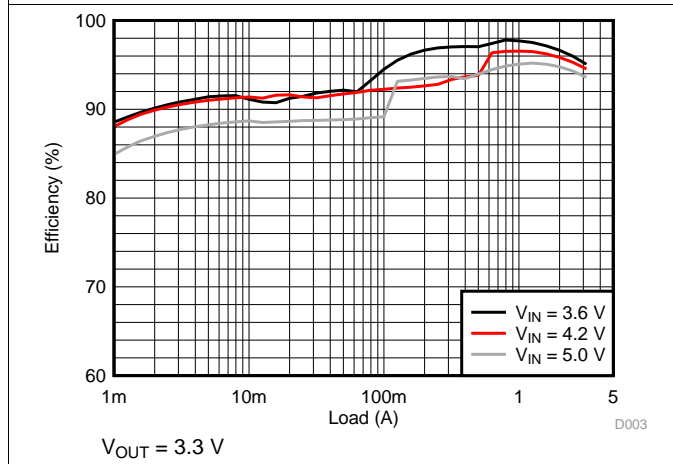

Figure 7. Efficiency

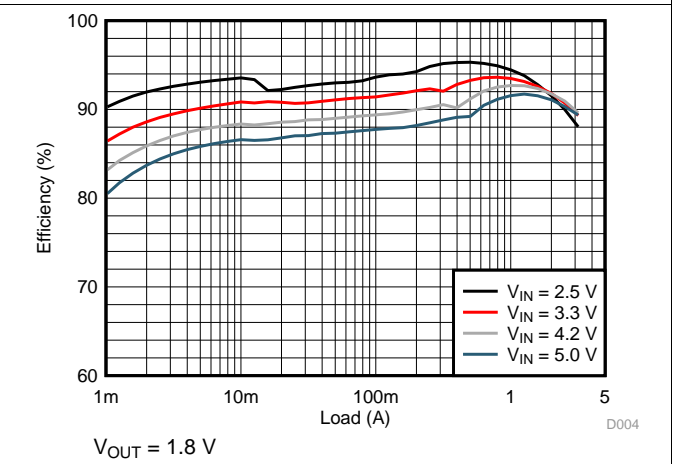

Figure 8. Efficiency

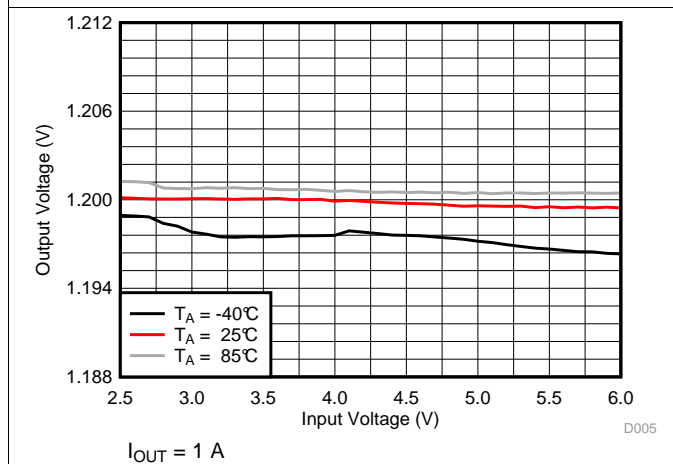

Figure 9. Line Regulation

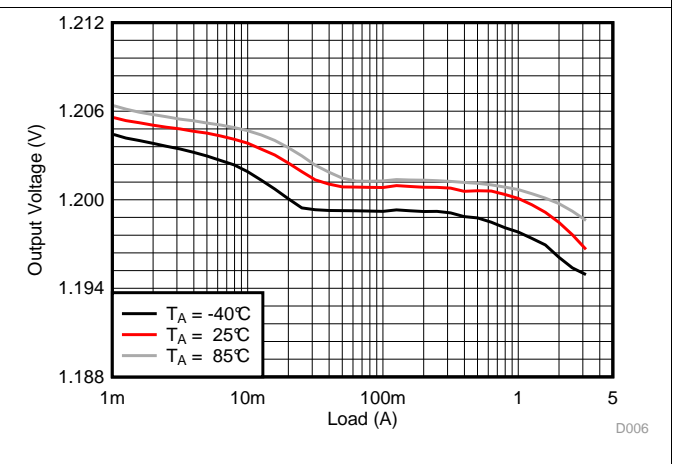

Figure 10. Load Regulation

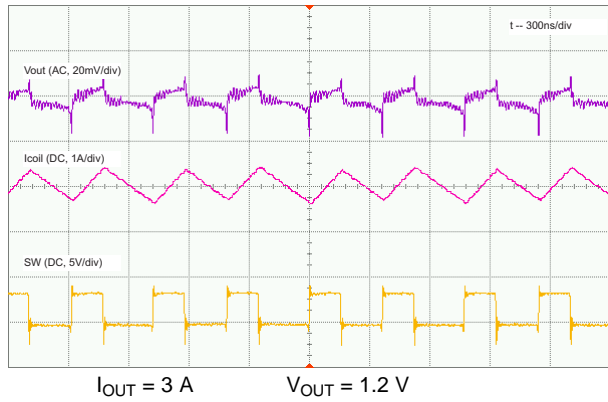

Figure 11. PWM Operation

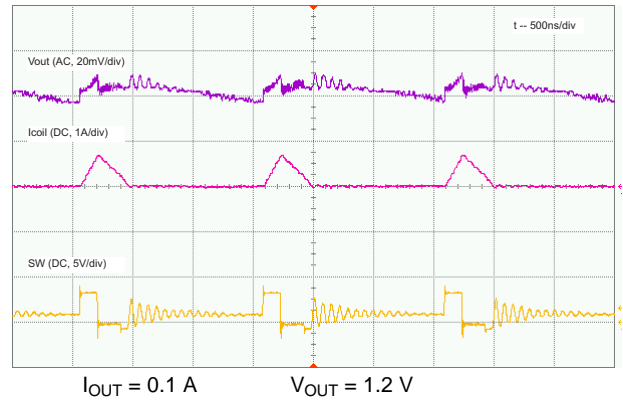

Figure 12. PFM Operation

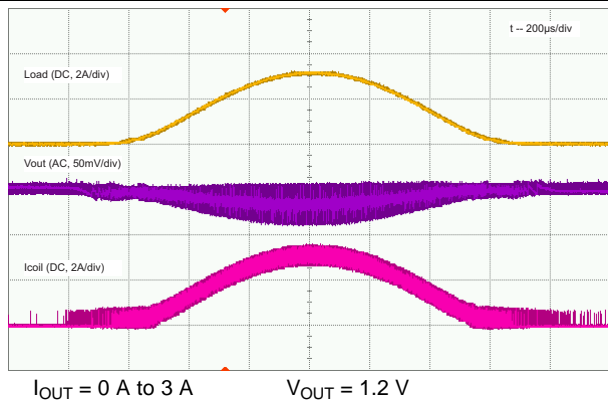

Figure 13. Load Sweep

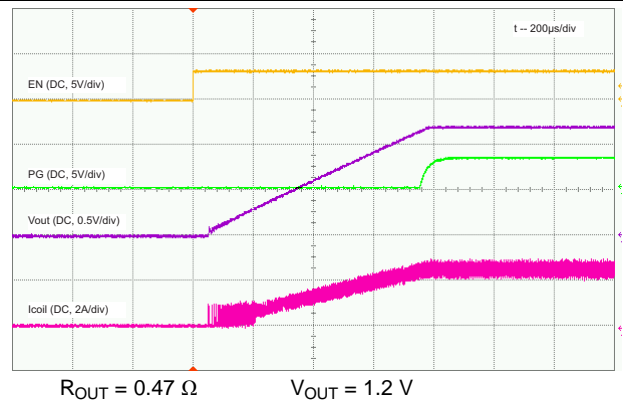

Figure 14. Start-Up with Load

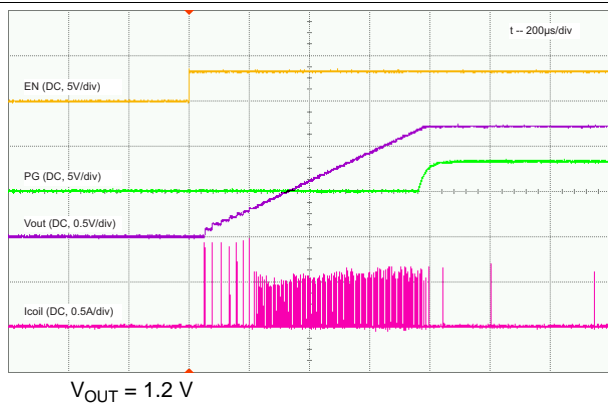

Figure 15. Start-Up without Load

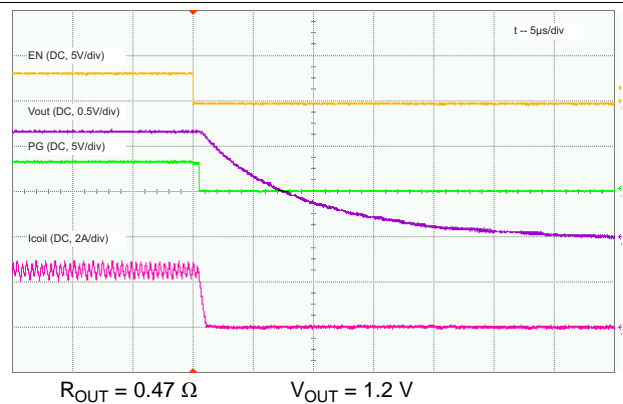

Figure 16. Shutdown with Load

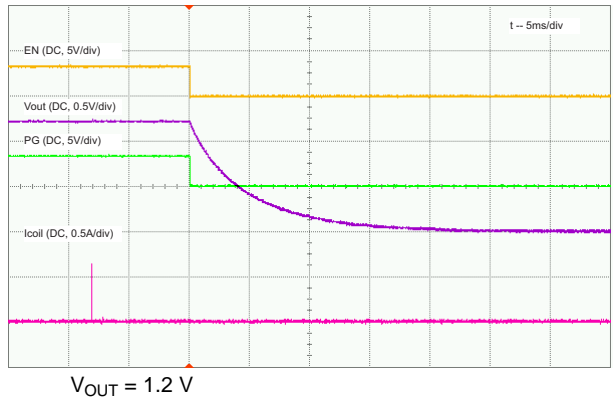

Figure 17. Shutdown without Load

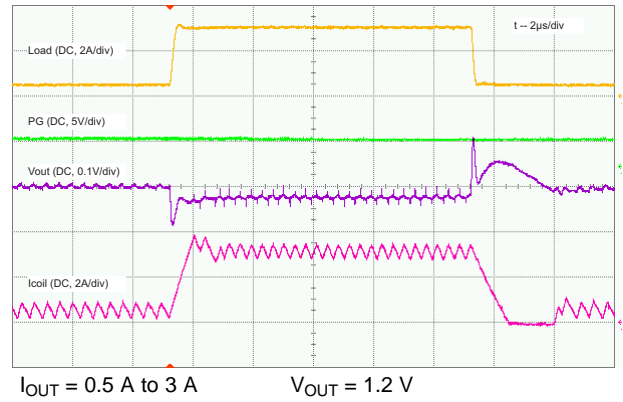

Figure 18. Load Transient

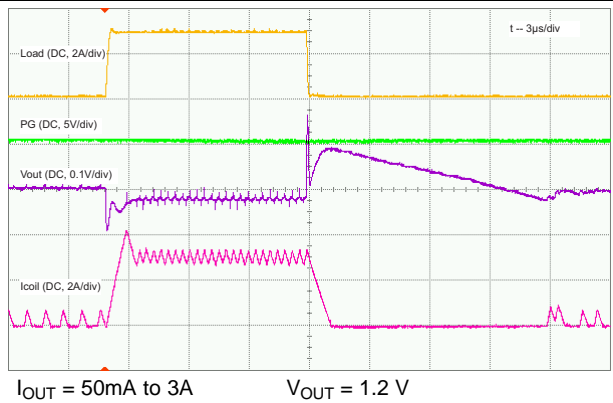

Figure 19. Load Transient

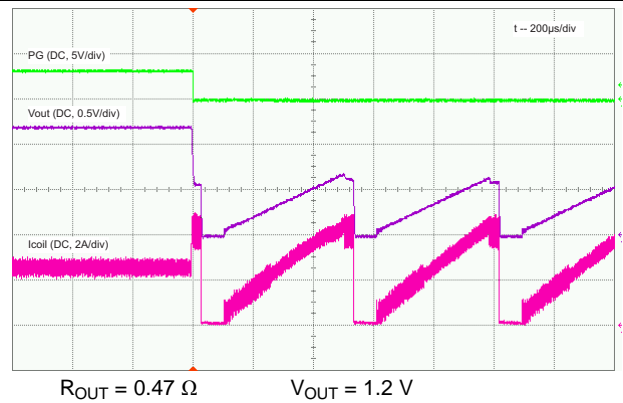

Figure 20. Output Short-Circuit Protection, Entry

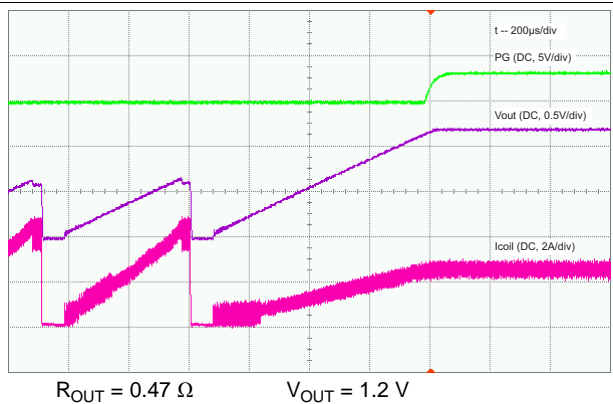

Figure 21. Output Short-Circuit Protection, Recovery

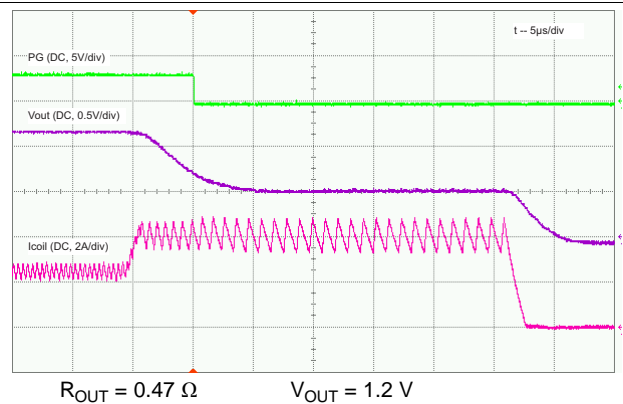

Figure 22. Output Short-Circuit Protection, HICCUP Zoom In

9 Power Supply Recommendations

The device is designed to operate from an input voltage supply range from 2.5 V to 6 V. Ensure that the input power supply has a sufficient current rating for the application.

10 Layout

10.1 Layout Guidelines

The printed-circuit-board (PCB) layout is an important step to maintain the high performance of the TLV62085 device.

The input and output capacitors and the inductor must be placed as close as possible to the IC. This keeps the traces short. Routing these traces direct and wide results in low trace resistance and low parasitic inductance. The low side of the input and output capacitors must be connected directly to the GND pin to avoid a ground potential shift. The sense traces connected to FB and VOS pins are signal traces. Special care must be taken to avoid noise being induced. By a direct routing, parasitic inductance can be kept small. GND layers might be used for shielding. Keep these traces away from SW nodes. See [Figure 23](#) for the recommended PCB layout.

10.2 Layout Example

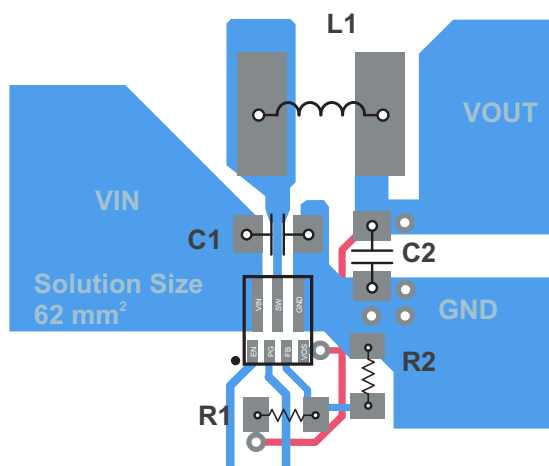

Figure 23. PCB Layout Recommendation

10.3 Thermal Considerations

Implementation of integrated circuits in low-profile and fine-pitch surface-mount packages typically requires special attention to power dissipation. Many system-dependent issues such as thermal coupling, airflow, added heat sinks and convection surfaces, and the presence of other heat-generating components affect the power dissipation limits of a given component.

Two basic approaches for enhancing thermal performance are:

- Improving the power dissipation capability of the PCB design
- Introducing airflow in the system

The big copper planes connecting to the pads of the IC on the PCB improve the thermal performance of the device. For more details on how to use the thermal parameters, see the *Thermal Characteristics Application Notes*, [SZZA017](#) and [SPRA953](#).

11 Device and Documentation Support

11.1 Development Support

11.1.1 Custom Design with WEBENCH® Tools

[Click here](#) to create a custom design using the TLV62085 device with the WEBENCH® Power Designer.

1. Start by entering your V_{IN} , V_{OUT} , and I_{OUT} requirements.
2. Optimize your design for key parameters like efficiency, footprint and cost using the optimizer dial and compare this design with other possible solutions from Texas Instruments.
3. The WEBENCH Power Designer provides you with a customized schematic along with a list of materials with real time pricing and component availability.
4. In most cases, you will also be able to:
 - Run electrical simulations to see important waveforms and circuit performance
 - Run thermal simulations to understand the thermal performance of your board
 - Export your customized schematic and layout into popular CAD formats
 - Print PDF reports for the design, and share your design with colleagues
5. Get more information about WEBENCH tools at www.ti.com/WEBENCH.

11.1.2 Third-Party Products Disclaimer

TI'S PUBLICATION OF INFORMATION REGARDING THIRD-PARTY PRODUCTS OR SERVICES DOES NOT CONSTITUTE AN ENDORSEMENT REGARDING THE SUITABILITY OF SUCH PRODUCTS OR SERVICES OR A WARRANTY, REPRESENTATION OR ENDORSEMENT OF SUCH PRODUCTS OR SERVICES, EITHER ALONE OR IN COMBINATION WITH ANY TI PRODUCT OR SERVICE.

11.2 Documentation Support

11.2.1 Related Documentation

For related documentation, see the following:

- *Thermal Characteristics Application Note*, [SZZA017](#)
- *Thermal Characteristics Application Note*, [SPRA953](#)

11.3 Receiving Notification of Documentation Updates

To receive notification of documentation updates, navigate to the device product folder on ti.com. In the upper right corner, click on *Alert me* to register and receive a weekly digest of any product information that has changed. For change details, review the revision history included in any revised document.

11.4 Community Resources

The following links connect to TI community resources. Linked contents are provided "AS IS" by the respective contributors. They do not constitute TI specifications and do not necessarily reflect TI's views; see TI's [Terms of Use](#).

TI E2E™ Online Community *TI's Engineer-to-Engineer (E2E) Community*. Created to foster collaboration among engineers. At e2e.ti.com, you can ask questions, share knowledge, explore ideas and help solve problems with fellow engineers.

Design Support *TI's Design Support* Quickly find helpful E2E forums along with design support tools and contact information for technical support.

11.5 Trademarks

DCS-Control, WEBENCH, E2E are trademarks of Texas Instruments.
WEBENCH is a registered trademark of Texas Instruments.

11.6 Electrostatic Discharge Caution



These devices have limited built-in ESD protection. The leads should be shorted together or the device placed in conductive foam during storage or handling to prevent electrostatic damage to the MOS gates.

11.7 Glossary

[SLYZ022](#) — *TI Glossary*.

This glossary lists and explains terms, acronyms, and definitions.

12 Mechanical, Packaging, and Orderable Information

The following pages include mechanical, packaging, and orderable information. This information is the most current data available for the designated devices. This data is subject to change without notice and revision of this document. For browser-based versions of this data sheet, refer to the left-hand navigation.

PACKAGING INFORMATION

Orderable part number	Status (1)	Material type (2)	Package Pins	Package qty Carrier	RoHS (3)	Lead finish/ Ball material (4)	MSL rating/ Peak reflow (5)	Op temp (°C)	Part marking (6)
TLV62085RLTR	Active	Production	VSON-HR (RLT) 7	3000 LARGE T&R	Yes	Call TI Sn	Level-1-260C-UNLIM	-40 to 125	12Q5
TLV62085RLTR.A	Active	Production	VSON-HR (RLT) 7	3000 LARGE T&R	Yes	SN	Level-1-260C-UNLIM	-40 to 125	12Q5
TLV62085RLTR.B	Active	Production	VSON-HR (RLT) 7	3000 LARGE T&R	Yes	SN	Level-1-260C-UNLIM	-40 to 125	12Q5
TLV62085RLTT	Active	Production	VSON-HR (RLT) 7	250 SMALL T&R	Yes	Call TI Sn	Level-1-260C-UNLIM	-40 to 125	12Q5
TLV62085RLTT.A	Active	Production	VSON-HR (RLT) 7	250 SMALL T&R	Yes	SN	Level-1-260C-UNLIM	-40 to 125	12Q5
TLV62085RLTT.B	Active	Production	VSON-HR (RLT) 7	250 SMALL T&R	Yes	SN	Level-1-260C-UNLIM	-40 to 125	12Q5

(1) **Status:** For more details on status, see our [product life cycle](#).

(2) **Material type:** When designated, preproduction parts are prototypes/experimental devices, and are not yet approved or released for full production. Testing and final process, including without limitation quality assurance, reliability performance testing, and/or process qualification, may not yet be complete, and this item is subject to further changes or possible discontinuation. If available for ordering, purchases will be subject to an additional waiver at checkout, and are intended for early internal evaluation purposes only. These items are sold without warranties of any kind.

(3) **RoHS values:** Yes, No, RoHS Exempt. See the [TI RoHS Statement](#) for additional information and value definition.

(4) **Lead finish/Ball material:** Parts may have multiple material finish options. Finish options are separated by a vertical ruled line. Lead finish/Ball material values may wrap to two lines if the finish value exceeds the maximum column width.

(5) **MSL rating/Peak reflow:** The moisture sensitivity level ratings and peak solder (reflow) temperatures. In the event that a part has multiple moisture sensitivity ratings, only the lowest level per JEDEC standards is shown. Refer to the shipping label for the actual reflow temperature that will be used to mount the part to the printed circuit board.

(6) **Part marking:** There may be an additional marking, which relates to the logo, the lot trace code information, or the environmental category of the part.

Multiple part markings will be inside parentheses. Only one part marking contained in parentheses and separated by a "~" will appear on a part. If a line is indented then it is a continuation of the previous line and the two combined represent the entire part marking for that device.

Important Information and Disclaimer:The information provided on this page represents TI's knowledge and belief as of the date that it is provided. TI bases its knowledge and belief on information provided by third parties, and makes no representation or warranty as to the accuracy of such information. Efforts are underway to better integrate information from third parties. TI has taken and continues to take reasonable steps to provide representative and accurate information but may not have conducted destructive testing or chemical analysis on incoming materials and chemicals. TI and TI suppliers consider certain information to be proprietary, and thus CAS numbers and other limited information may not be available for release.

In no event shall TI's liability arising out of such information exceed the total purchase price of the TI part(s) at issue in this document sold by TI to Customer on an annual basis.

TAPE AND REEL INFORMATION

QUADRANT ASSIGNMENTS FOR PIN 1 ORIENTATION IN TAPE



*All dimensions are nominal

Device	Package Type	Package Drawing	Pins	SPQ	Reel Diameter (mm)	Reel Width W1 (mm)	A0 (mm)	B0 (mm)	K0 (mm)	P1 (mm)	W (mm)	Pin1 Quadrant
TLV62085RLTR	VSON-HR	RLT	7	3000	180.0	8.4	2.3	2.3	1.15	4.0	8.0	Q2
TLV62085RLTT	VSON-HR	RLT	7	250	180.0	8.4	2.3	2.3	1.15	4.0	8.0	Q2

TAPE AND REEL BOX DIMENSIONS

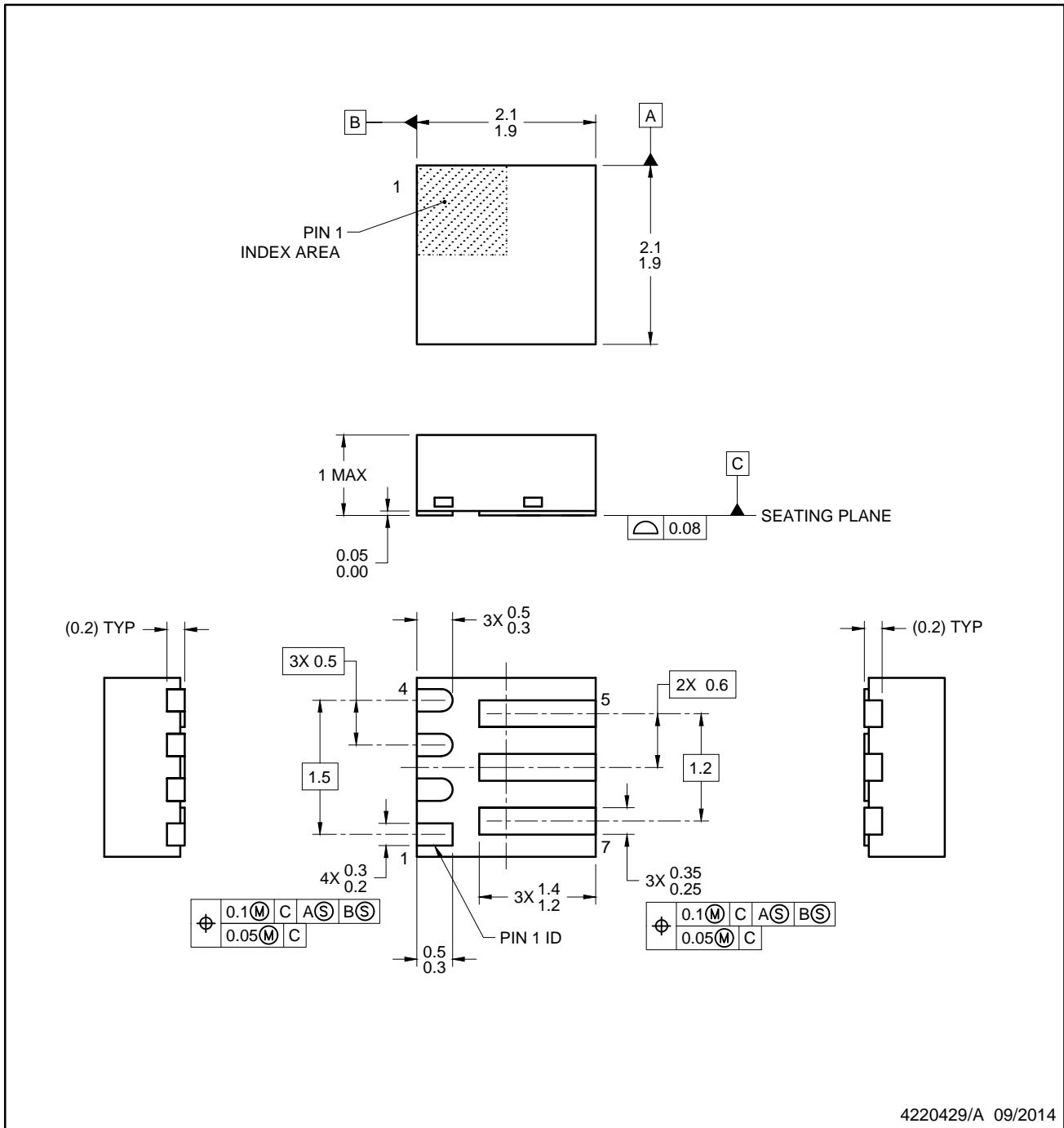

*All dimensions are nominal

Device	Package Type	Package Drawing	Pins	SPQ	Length (mm)	Width (mm)	Height (mm)
TLV62085RLTR	VSON-HR	RLT	7	3000	210.0	185.0	35.0
TLV62085RLTT	VSON-HR	RLT	7	250	210.0	185.0	35.0

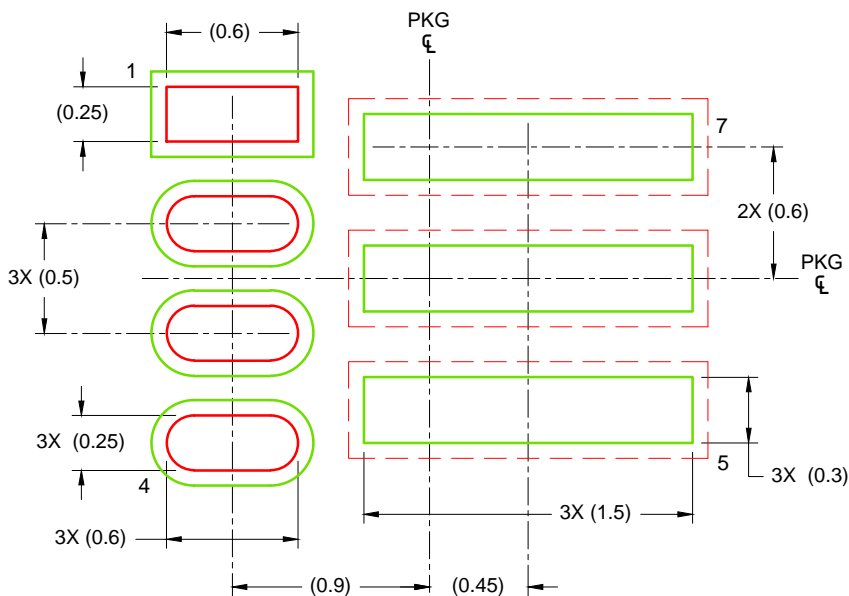

NOTES:

1. All linear dimensions are in millimeters. Any dimensions in parenthesis are for reference only. Dimensioning and tolerancing per ASME Y14.5M.
2. This drawing is subject to change without notice.



LAND PATTERN EXAMPLE
SCALE: 30X

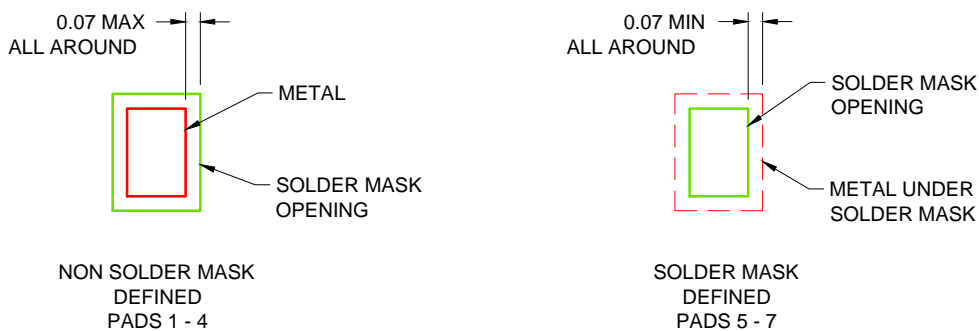

SOLDER MASK DETAILS

4220429/A 09/2014

NOTES: (continued)

3. For more information, see Texas Instruments literature number SLUA271 (www.ti.com/lit/sluea271).
4. Solder mask tolerances between and around signal pads can vary based on board fabrication site.
5. Vias should not be placed on soldering pads unless they are plugged or plated shut.

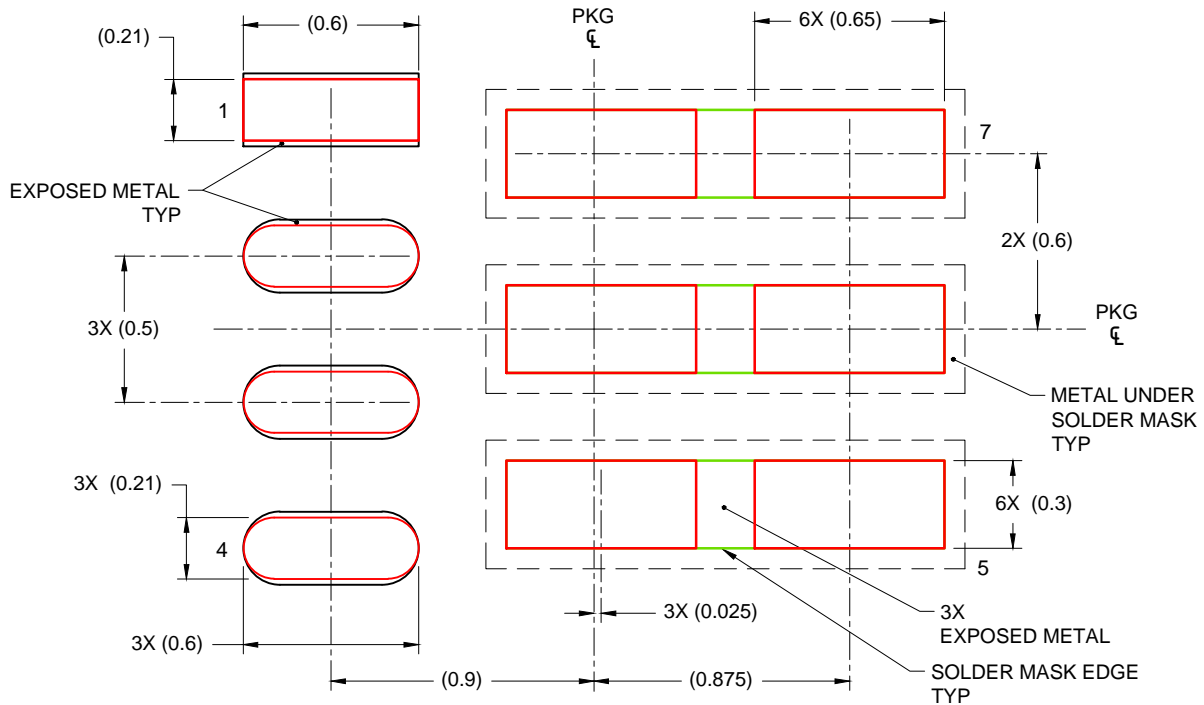

SOLDER PASTE EXAMPLE
 BASED ON 0.125 mm THICK STENCIL

FOR ALL EXPOSED PADS
 85% PRINTED SOLDER COVERAGE BY AREA
 SCALE: 40X

4220429/A 09/2014

NOTES: (continued)

6. Laser cutting apertures with trapezoidal walls and rounded corners may offer better paste release. IPC-7525 may have alternate design recommendations.

IMPORTANT NOTICE AND DISCLAIMER

TI PROVIDES TECHNICAL AND RELIABILITY DATA (INCLUDING DATASHEETS), DESIGN RESOURCES (INCLUDING REFERENCE DESIGNS), APPLICATION OR OTHER DESIGN ADVICE, WEB TOOLS, SAFETY INFORMATION, AND OTHER RESOURCES "AS IS" AND WITH ALL FAULTS, AND DISCLAIMS ALL WARRANTIES, EXPRESS AND IMPLIED, INCLUDING WITHOUT LIMITATION ANY IMPLIED WARRANTIES OF MERCHANTABILITY, FITNESS FOR A PARTICULAR PURPOSE OR NON-INFRINGEMENT OF THIRD PARTY INTELLECTUAL PROPERTY RIGHTS.

These resources are intended for skilled developers designing with TI products. You are solely responsible for (1) selecting the appropriate TI products for your application, (2) designing, validating and testing your application, and (3) ensuring your application meets applicable standards, and any other safety, security, regulatory or other requirements.

These resources are subject to change without notice. TI grants you permission to use these resources only for development of an application that uses the TI products described in the resource. Other reproduction and display of these resources is prohibited. No license is granted to any other TI intellectual property right or to any third party intellectual property right. TI disclaims responsibility for, and you fully indemnify TI and its representatives against any claims, damages, costs, losses, and liabilities arising out of your use of these resources.

TI's products are provided subject to [TI's Terms of Sale](#), [TI's General Quality Guidelines](#), or other applicable terms available either on [ti.com](#) or provided in conjunction with such TI products. TI's provision of these resources does not expand or otherwise alter TI's applicable warranties or warranty disclaimers for TI products. Unless TI explicitly designates a product as custom or customer-specified, TI products are standard, catalog, general purpose devices.

TI objects to and rejects any additional or different terms you may propose.

Copyright © 2025, Texas Instruments Incorporated

Last updated 10/2025