

TLV34xx Low-Voltage Rail-to-Rail Output CMOS Operational Amplifiers With Shutdown

1 Features

- 1.8V and 5V performance
- Low offset (A grade)
 - 1.25mV maximum (25°C)
 - 1.7mV maximum (–40°C to 125°C)
- Rail-to-rail output swing
- Wide common-mode input voltage range: –0.2V to (V₊ – 0.5V)
- Input bias current: 1pA (typical)
- Input offset voltage: 0.3mV (typical)
- Low supply current: 70µA/channel
- Low shutdown current: 10pA (typical) per channel
- Gain bandwidth: 2.3MHz (typical)
- Slew rate: 0.9V/µs (typical)
- Turnon time from shutdown: 5µs (typical)
- Input referred voltage noise (at 10kHz): 20nV/√Hz
- ESD protection exceeds JESD 22:
 - 2000V Human-Body Model (HBM)
 - 750V Charged-device model (CDM)

2 Applications

- Cellular phones
- Consumer electronics (laptops)
- Audio preamplifier for voice
- Portable and battery-powered electronic equipment
- Supply current monitoring
- Battery monitoring
- Buffers
- Filters

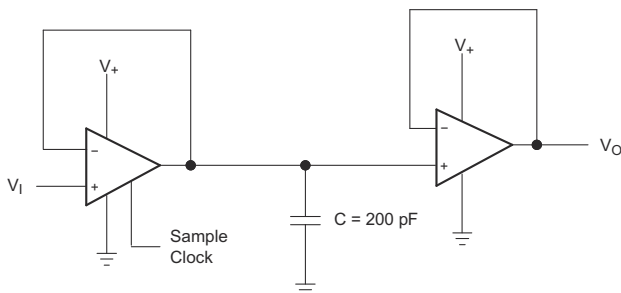

Copyright © 2016, Texas Instruments Incorporated

Sample and Hold Circuit Using Two TLV341

3 Description

The TLV34xx devices are single and dual CMOS operational amplifiers, respectively, with low-voltage, low-power, and rail-to-rail output swing capabilities. The PMOS input stage offers an ultra-low input bias current of 1pA (typical) and an offset voltage of 0.3mV (typical). For applications requiring excellent dc precision, the A grade (TLV34xA) has a low offset voltage of 1.25mV (maximum) at 25°C.

These single-supply amplifiers are designed specifically for ultra-low-voltage (1.5V to 5V) operation, with a common-mode input voltage range that typically extends from –0.2V to 0.5V from the positive supply rail.

The TLV341 (single) and TLV342 (dual) in the RUG package also offer a shutdown (SHDN) pin that can be used to disable the device. In shutdown mode, the supply current is reduced to 45pA (typical). Offered in both the SOT-23 and smaller SC70 packages, the TLV341 is an excellent choice for the most space-constrained applications. The dual TLV342 is offered in the standard SOIC, VSSOP, and X2QFN packages.

An extended industrial temperature range from –40°C to 125°C makes the TLV34xx flexible for use in a wide variety of commercial and industrial applications.

Package Information

PART NUMBER ⁽¹⁾	PACKAGE	BODY SIZE (NOM)
TLV341	(SOT-23, 6)	2.90mm × 1.60mm
	(SC70, 6)	2.00mm × 1.25mm
	(SOT, 6)	1.60mm × 1.20mm
TLV342	(SOIC, 8)	4.90mm × 3.91mm
	(VSSOP, 8)	3.00mm × 3.00mm
	(X2QFN, 10)	1.50mm × 2.00mm
TLV342S	(X2QFN, 10)	1.50mm × 2.00mm

(1) For all available packages, see the orderable addendum at the end of the data sheet.



Table of Contents

1 Features	1	6.2 Functional Block Diagram.....	16
2 Applications	1	6.3 Feature Description.....	16
3 Description	1	6.4 Device Functional Modes.....	16
4 Pin Configuration and Functions	3	7 Application and Implementation	17
5 Specifications	5	7.1 Application Information.....	17
5.1 Absolute Maximum Ratings.....	5	7.2 Typical Application.....	17
5.2 ESD Ratings.....	5	7.3 Power Supply Recommendations.....	18
5.3 Recommended Operating Conditions.....	5	7.4 Layout.....	18
5.4 Thermal Information: TLV341.....	5	8 Device and Documentation Support	20
5.5 Thermal Information: TLV342.....	6	8.1 Receiving Notification of Documentation Updates....	20
5.6 Thermal Information: TLV342S.....	6	8.2 Support Resources.....	20
5.7 Electrical Characteristics: $V_+ = 1.8V$	7	8.3 Trademarks.....	20
5.8 Electrical Characteristics: $V_+ = 5V$	8	8.4 Electrostatic Discharge Caution.....	20
5.9 Shutdown Characteristics: $V_+ = 1.8V$	9	8.5 Glossary.....	20
5.10 Shutdown Characteristics: $V_+ = 5V$	9	9 Revision History	20
5.11 Typical Characteristics.....	10	10 Mechanical, Packaging, and Orderable Information	21
6 Detailed Description	16		
6.1 Overview.....	16		

4 Pin Configuration and Functions

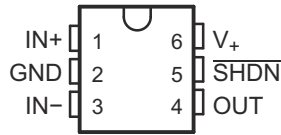

Figure 4-1. TLV341 DBV or DCK Package, 6-Pin SOT-23 or SC70 (Top View)

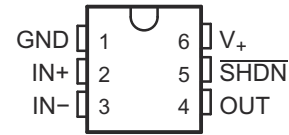

Figure 4-2. TLV341 DRL Package, 6-Pin SOT (Top View)

Table 4-1. Pin Functions: TLV341

NAME	PIN		I/O	DESCRIPTION
	SOT-23, SC70	SOT		
1IN+	1	2	I	Noninverting input on channel 1
1IN-	3	3	I	Inverting input on channel 1
1OUT	4	4	O	Output on channel 1
GND	2	1	—	Ground
SHDN	5	5	I	Shutdown active low
V+	6	6	—	Positive power supply

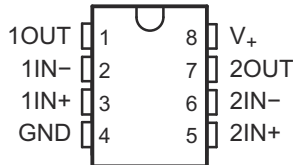

Figure 4-3. TLV342 D or DGK Package, 10-Pin SOIC or VSSOP (Top View)

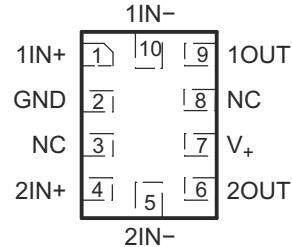

Figure 4-4. TLV342 RUG Package, 10-Pin X2QFN (Top View)

Table 4-2. Pin Functions: TLV342

NAME	PIN		I/O	DESCRIPTION
	SOIC, VSSOP	X2QFN		
1IN+	3	1	I	Noninverting input on channel 1
1IN-	2	10	I	Inverting input on channel 1
1OUT	1	9	O	Output on channel 1
2IN+	5	4	I	Noninverting input on channel 2
2IN-	6	5	I	Inverting input on channel 2
2OUT	7	6	O	Output on channel 2
GND	4	2	—	Ground
NC ⁽¹⁾	—	3, 8	—	Not connected
V+	8	7	—	Positive power supply

(1) NC – No internal connection

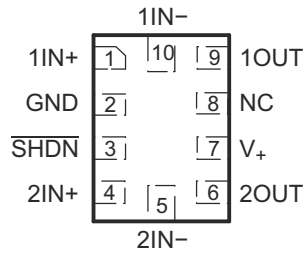

Figure 4-5. TLV342S RUG Package, 10-Pin X2QFN (Top View)

Table 4-3. Pin Functions: TLV342S

PIN		I/O	DESCRIPTION
NAME	NO.		
1IN+	1	I	Noninverting input on channel 1
1IN-	10	I	Inverting input on channel 1
1OUT	9	O	Output on channel 1
2IN+	4	I	Noninverting input on channel 2
2IN-	5	I	Inverting input on channel 2
2OUT	6	O	Output on channel 2
GND	2	—	Ground
NC ⁽¹⁾	8	—	Not connected
SHDN	3	I	Shutdown active low
V+	7	—	Positive power supply

(1) NC – No internal connection

5 Specifications

5.1 Absolute Maximum Ratings

over operating free-air temperature range (unless otherwise noted)⁽¹⁾

		MIN	MAX	UNIT
V ₊	Supply voltage ⁽²⁾	-0.3	5.5	V
V _{ID}	Differential input voltage ⁽³⁾		±5.5	V
V _I	Input voltage (either input or shutdown)	-0.3	5.5	V
V _O	Output voltage	-0.3	V _{CC} + 0.3	V
T _J	Operating virtual-junction temperature		150	°C
T _{stg}	Storage temperature	-65	150	°C

- (1) Stresses beyond those listed under *Absolute Maximum Ratings* can cause permanent damage to the device. These are stress ratings only, and functional operation of the device at these or any other conditions beyond those indicated under *Recommended Operating Conditions* is not implied. Exposure to absolute-maximum-rated conditions for extended periods can affect device reliability.
- (2) All voltage values (except differential voltages) are with respect to the network GND.
- (3) Differential voltages are at IN+ with respect to IN-.

5.2 ESD Ratings

		VALUE	UNIT
V _(ESD)	Electrostatic discharge	Human-body model (HBM), per ANSI/ESDA/JEDEC JS-001 ⁽¹⁾	±2000
		Charged-device model (CDM), per JEDEC specification JESD22-C101 ⁽²⁾	±750

- (1) JEDEC document JEP155 states that 500V HBM allows safe manufacturing with a standard ESD control process.
- (2) JEDEC document JEP157 states that 250V CDM allows safe manufacturing with a standard ESD control process.

5.3 Recommended Operating Conditions

		MIN	MAX	UNIT
V ₊	Supply voltage (single-supply operation)	1.5	5.5	V
T _A	Operating free-air temperature	-40	125	°C

5.4 Thermal Information: TLV341

THERMAL METRIC ⁽¹⁾		TLV341			UNIT
		DBV (SOT-23)	DCK (SC70)	DRL (SOT)	
		6 PINS	6 PINS	6 PINS	
R _{θJA}	Junction-to-ambient thermal resistance	193.4	196.8	221.1	°C/W
R _{θJC(top)}	Junction-to-case (top) thermal resistance	145.6	82.4	109.1	°C/W
R _{θJB}	Junction-to-board thermal resistance	44.1	95.2	111.4	°C/W
ψ _{JT}	Junction-to-top characterization parameter	34.1	1.8	6.2	°C/W
ψ _{JB}	Junction-to-board characterization parameter	43.4	93.2	109.8	°C/W

- (1) For more information about traditional and new thermal metrics, see the *Semiconductor and IC Package Thermal Metrics* application report, [SPRA953](#).

5.5 Thermal Information: TLV342

THERMAL METRIC ⁽¹⁾		TLV342			UNIT
		D (SOIC)	DGK (MSOP)	RUG (X2QFN)	
		8 PINS	8 PINS	10 PINS	
R _{θJA}	Junction-to-ambient thermal resistance	123.6	192.3	167	°C/W
R _{θJC(top)}	Junction-to-case (top) thermal resistance	69.8	78.2	56.5	°C/W
R _{θJB}	Junction-to-board thermal resistance	63.9	112.6	94.3	°C/W
Ψ _{JT}	Junction-to-top characterization parameter	24.4	15.2	4.1	°C/W
Ψ _{JB}	Junction-to-board characterization parameter	63.4	111.2	94	°C/W

(1) For more information about traditional and new thermal metrics, see the *Semiconductor and IC Package Thermal Metrics* application report, [SPRA953](#).

5.6 Thermal Information: TLV342S

THERMAL METRIC ⁽¹⁾		TLV342S	UNIT
		RUG (X2QFN)	
		10 PINS	
R _{θJA}	Junction-to-ambient thermal resistance	158.3	°C/W
R _{θJC(top)}	Junction-to-case (top) thermal resistance	52.6	°C/W
R _{θJB}	Junction-to-board thermal resistance	87.9	°C/W
Ψ _{JT}	Junction-to-top characterization parameter	1	°C/W
Ψ _{JB}	Junction-to-board characterization parameter	87	°C/W

(1) For more information about traditional and new thermal metrics, see the *Semiconductor and IC Package Thermal Metrics* application report, [SPRA953](#).

5.7 Electrical Characteristics: $V_+ = 1.8V$

$V_+ = 1.8V$, $GND = 0V$, $V_{IC} = V_O = V_+/2$, $R_L > 1M\Omega$ (unless otherwise noted). See [Section 5.9](#).

PARAMETER		TEST CONDITIONS		T_A	MIN	TYP ⁽¹⁾	MAX	UNIT	
V_{IO}	Input offset voltage	Standard grade		25°C		0.3	4	mV	
				Full range			4.5		
		A grade		25°C		0.3	1.25		
				0°C to 125°C		0.3	1.5		
				-40°C to 125°C		0.3	1.7		
α_{VIO}	Average temperature coefficient of input offset voltage			Full range		1.9		$\mu V/^\circ C$	
I_{IB}	Input bias current			25°C		1	100	pA	
				-40°C to 85°C			375		
				-40°C to 125°C			3000		
I_{IO}	Input offset current			25°C		6.6		fA	
CMRR	Common-mode rejection ratio	$0 \leq V_{ICR} \leq 1.2V$		25°C	60	85		dB	
				Full range	50				
k_{SVR}	Supply-voltage rejection ratio	$1.8V \leq V_+ \leq 5V$		25°C	75	95		dB	
				Full range	65				
V_{ICR}	Common-mode input voltage range	$CMRR \geq 60dB$		25°C	0		1.2	V	
A_V	Large-signal voltage gain ⁽²⁾	$R_L = 10k\Omega$ to 1.35V		25°C	70	110		dB	
				Full range	60				
		$R_L = 2k\Omega$ to 1.35V		25°C	65	100			
				Full range	55				
V_O	Output swing (delta from supply rails)	$R_L = 2k\Omega$ to 1.35V	Low level	25°C		22	50	mV	
				Full range			75		
			High level	25°C		25	50		
				Full range			75		
		$R_L = 10k\Omega$ to 1.35V	Low level	25°C		14	20		
				Full range			25		
			High level	25°C		7	20		
				Full range			25		
I_{CC}	Supply current (per channel)			25°C		150	200	μA	
				Full range			210		
I_{OS}	Output short-circuit current			25°C	Sourcing		6	12	mA
					Sinking		10	20	
SR	Slew rate	$R_L = 10k\Omega$ ⁽³⁾		25°C		0.9		V/ μs	
GBW	Unity-gain bandwidth	$R_L = 10k\Omega$, $C_L = 200pF$		25°C		2.2		MHz	
ϕ_m	Phase margin	$R_L = 100k\Omega$, $C_L = 200pF$		25°C		55		°	
G_m	Gain margin	$R_L = 100k\Omega$, $C_L = 200pF$		25°C		15		dB	
V_n	Equivalent input noise voltage	$f = 1kHz$		25°C		33		nV/\sqrt{Hz}	
I_n	Equivalent input noise current	$f = 1kHz$		25°C		0.001		pA/\sqrt{Hz}	
THD	Total harmonic distortion	$f = 1kHz$, $A_V = 1$, $R_L = 600\Omega$, $V_I = 1 V_{PP}$		25°C		0.015%			

(1) Typical values represent the most likely parametric norm.

(2) $GND + 0.2V \leq V_O \leq V_+ - 0.2V$

(3) Connected as voltage follower with $2V_{PP}$ step input. Number specified is the slower of the positive and negative slew rates.

5.8 Electrical Characteristics: $V_+ = 5V$

$V_+ = 5V$, GND = 0V, $V_{IC} = V_O = V_+/2$, $R_L > 1M\Omega$ (unless otherwise noted). See [Section 5.10](#).

PARAMETER		TEST CONDITIONS		T_A	MIN	TYP ⁽¹⁾	MAX	UNIT
V_{IO}	Input offset voltage	Standard grade		25°C		0.3	4	mV
				Full range			4.5	
		A grade		25°C		0.3	1.25	
				0°C to 125°C		0.3	1.5	
				-40°C to 125°C		0.3	1.7	
α_{VIO}	Average temperature coefficient of input offset voltage			Full range		1.9		$\mu V/^\circ C$
I_{IB}	Input bias current			25°C		1	200	pA
				-40°C to 85°C			375	
				-40°C to 125°C			3000	
I_{IO}	Input offset current			25°C		6.6		fA
CMRR	Common-mode rejection ratio	$0 \leq V_{ICR} \leq 4.4V$		25°C	75	90		dB
				Full range	70			
k_{SVR}	Supply-voltage rejection ratio	$1.8V \leq V_+ \leq 5V$		25°C	75	95		dB
				Full range	65			
V_{ICR}	Common-mode input voltage range	$CMRR \geq 70dB$		25°C	0		4.4	V
A_V	Large-signal voltage gain ⁽²⁾	$R_L = 10k\Omega$ to 2.5V		25°C	80	110		dB
				Full range	70			
		$R_L = 2k\Omega$ to 2.5V		25°C	75	105		
				Full range	60			
V_O	Output swing (delta from supply rails)	$R_L = 2k\Omega$ to 2.5V	Low level	25°C		40	60	mV
				Full range			85	
			High level	25°C		25	60	
				Full range			85	
		$R_L = 10k\Omega$ to 2.5V	Low level	25°C		18	30	
				Full range			40	
			High level	25°C		7	15	
				Full range			20	
I_{CC}	Supply current (per channel)			25°C		150	200	μA
				Full range			215	
I_{OS}	Output short-circuit current			25°C	Sourcing	60	113	mA
					Sinking	80	115	
SR	Slew rate	$R_L = 10k\Omega$ ⁽³⁾		25°C		1		V/ μs
GBW	Unity-gain bandwidth	$R_L = 10k\Omega$, $C_L = 200pF$		25°C		2.3		MHz
ϕ_m	Phase margin	$R_L = 100k\Omega$, $C_L = 200pF$		25°C		55		°
G_m	Gain margin	$R_L = 100k\Omega$, $C_L = 200pF$		25°C		15		dB
V_n	Equivalent input noise voltage	$f = 1kHz$		25°C		33		nV/\sqrt{Hz}
I_n	Equivalent input noise current	$f = 1kHz$		25°C		0.001		pA/\sqrt{Hz}
THD	Total harmonic distortion	$f = 1kHz$, $A_V = 1$, $R_L = 600\Omega$, $V_I = 1V_{PP}$		25°C		0.012%		

5.9 Shutdown Characteristics: $V_+ = 1.8V$

$V_+ = 1.8V$, GND = 0V, $V_{IC} = V_O = V_+/2$, $R_L > 1M\Omega$ (unless otherwise noted)

PARAMETER		TEST CONDITIONS	T_A	MIN	TYP	MAX	UNIT
$I_{CC(SHDN)}$	Supply current in shutdown mode	$V_{SD} = 0V$	25°C	0.01	1	1.5	μA
			Full range				
$t_{(on)}$	Amplifier turnon time		25°C		5		μs
V_{SD}	Recommended shutdown pin voltage range	On mode	25°C	1.5		1.8	V
		Shutdown mode		0		0.2	

5.10 Shutdown Characteristics: $V_+ = 5V$

$V_+ = 5V$, GND = 0V, $V_{IC} = V_O = V_+/2$, $R_L > 1M\Omega$ (unless otherwise noted)

PARAMETER		TEST CONDITIONS	T_A	MIN	TYP	MAX	UNIT
$I_{CC(SHDN)}$	Supply current in shutdown mode	$V_{SD} = 0V$	25°C	0.01	1	1.5	μA
			Full range				
$t_{(on)}$	Amplifier turnon time		25°C		5		μs
V_{SD}	Recommended shutdown pin voltage range	On mode	25°C	4.5		5	V
		Shutdown mode		0		0.2	

5.11 Typical Characteristics

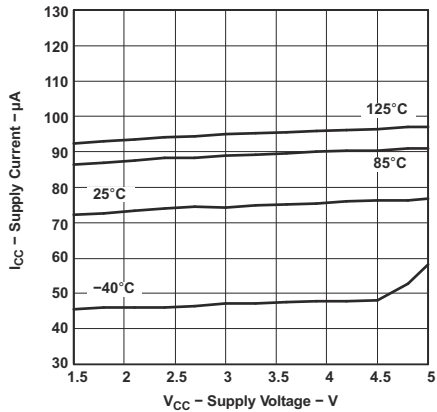

Figure 5-1. Supply Current vs Supply Voltage

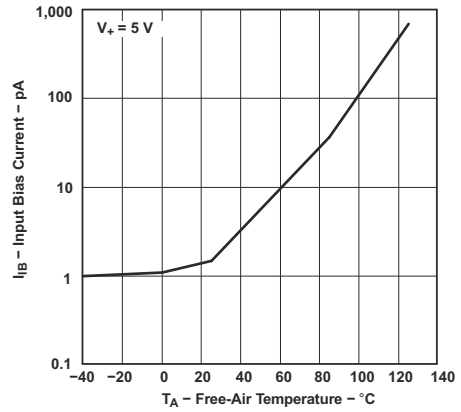

Figure 5-2. Input Bias Current vs Temperature

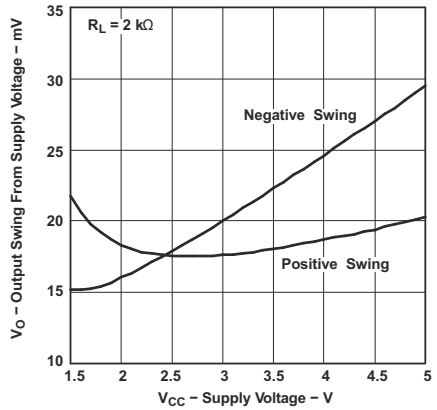

Figure 5-3. Output Voltage Swing vs Supply Voltage

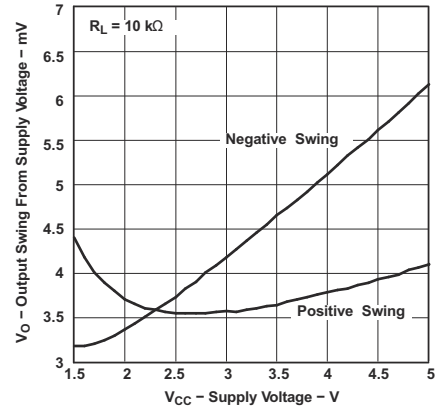

Figure 5-4. Output Voltage Swing vs Supply Voltage

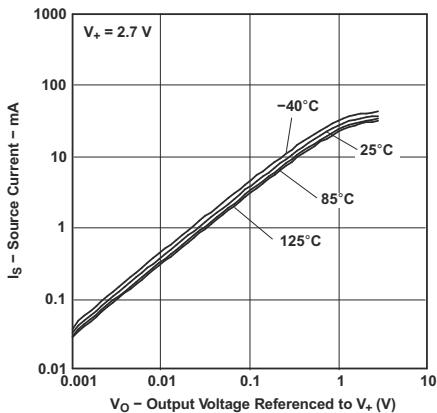

Figure 5-5. Source Current vs Output Voltage

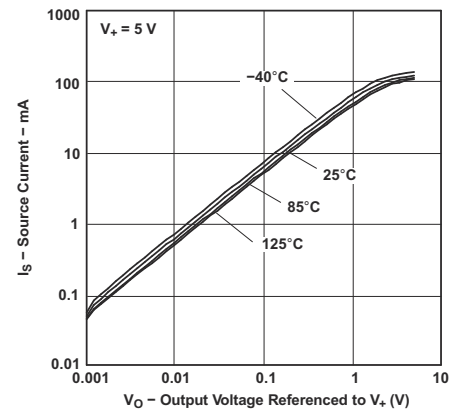

Figure 5-6. Source Current vs Output Voltage

5.11 Typical Characteristics (continued)

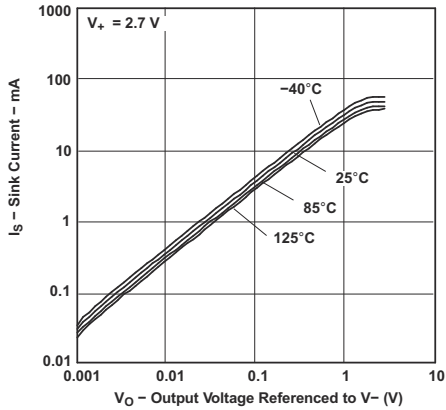

Figure 5-7. Sink Current vs Output Voltage

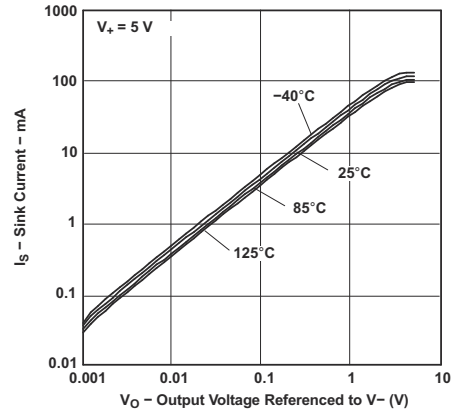

Figure 5-8. Sink Current vs Output Voltage

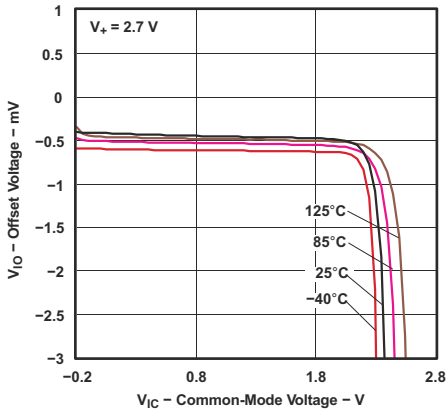

Figure 5-9. Offset Voltage vs Common-Mode Voltage

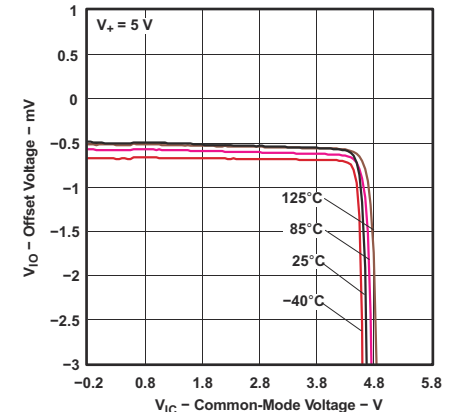

Figure 5-10. Offset Voltage vs Common-Mode Voltage

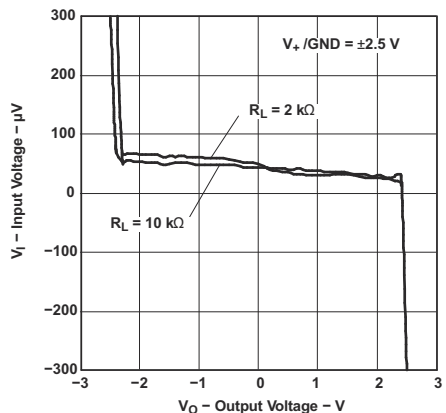

Figure 5-11. Input Voltage vs Output Voltage

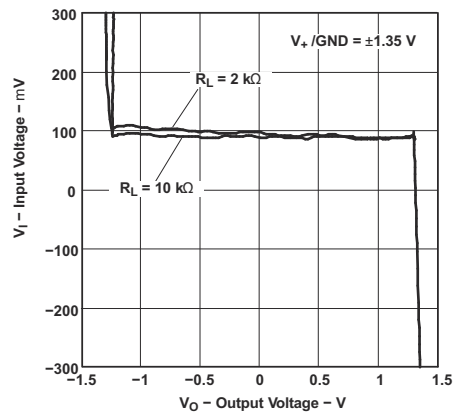

Figure 5-12. Input Voltage vs Output Voltage

5.11 Typical Characteristics (continued)

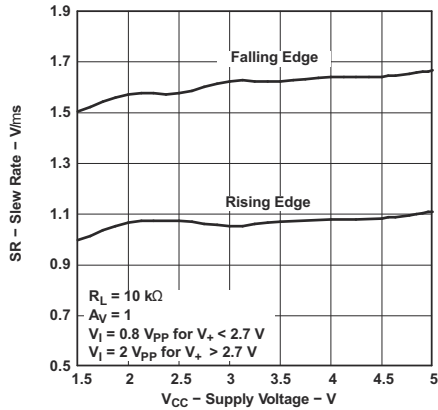

Figure 5-13. Slew Rate vs Supply Voltage

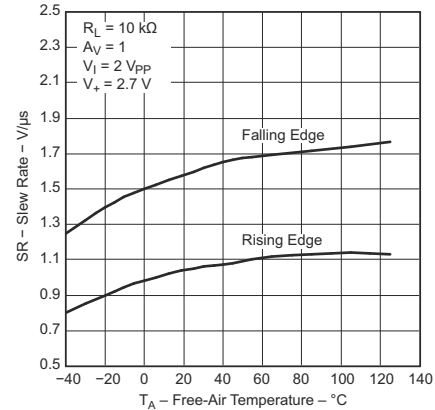

Figure 5-14. Slew Rate vs Temperature

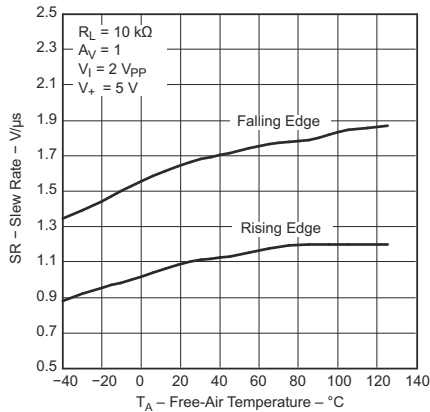

Figure 5-15. Slew Rate vs Temperature

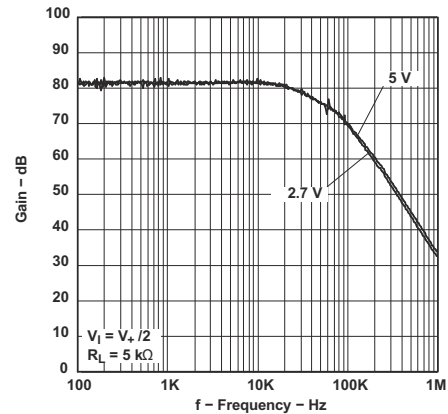

Figure 5-16. CMRR vs Frequency

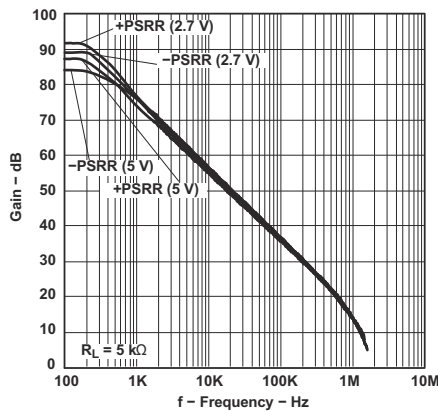

Figure 5-17. PSRR vs Frequency

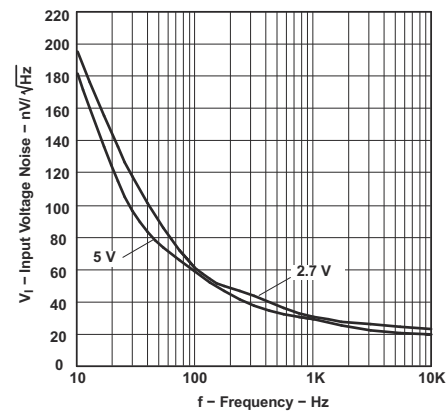

Figure 5-18. Input Voltage Noise vs Frequency

5.11 Typical Characteristics (continued)

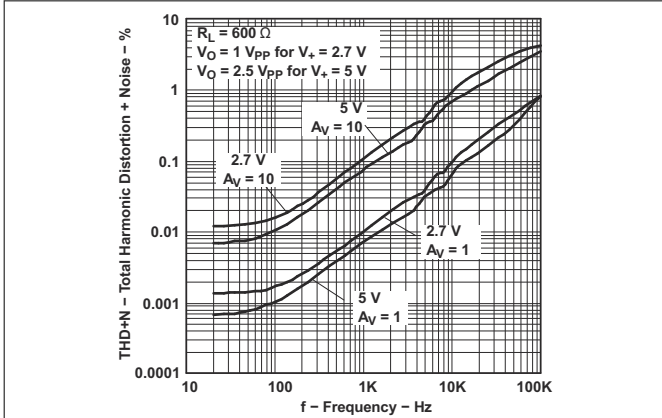

Figure 5-19. Total Harmonic Distortion +Noise vs Frequency

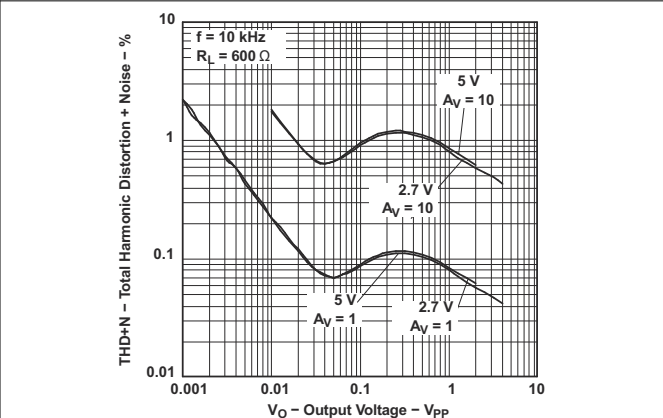

Figure 5-20. Total Harmonic Distortion +Noise vs Output Voltage

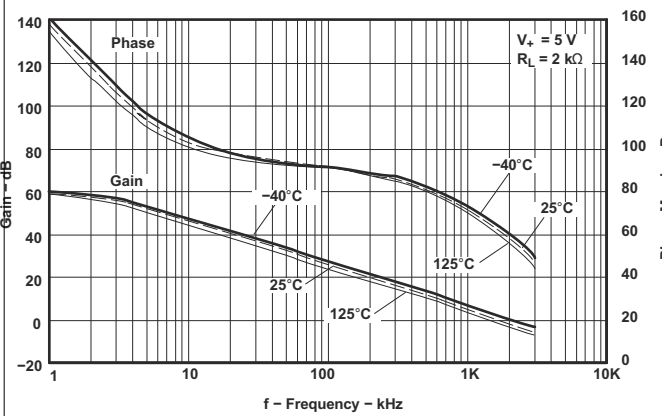

Figure 5-21. Frequency Response vs Temperature

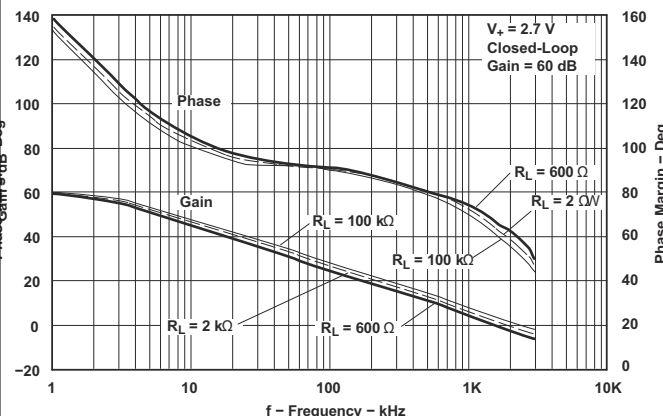

Figure 5-22. Frequency Response vs R_L

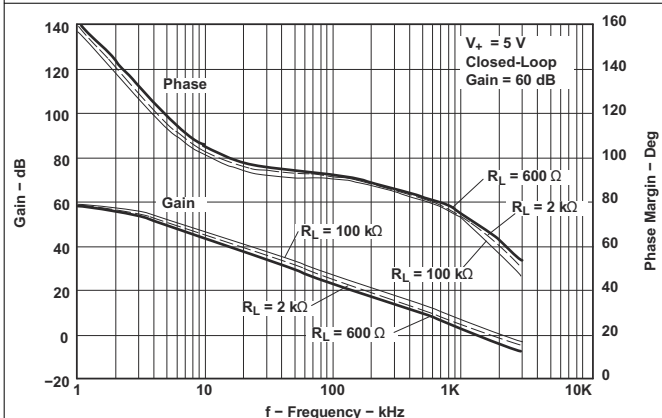

Figure 5-23. Frequency Response vs R_L

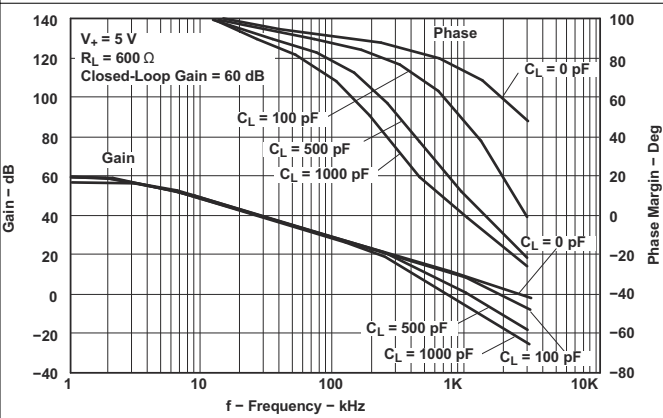

Figure 5-24. Frequency Response vs C_L

5.11 Typical Characteristics (continued)

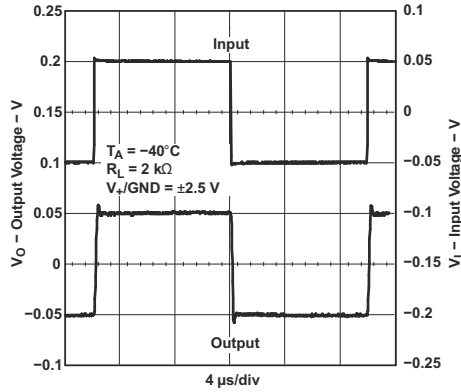

Figure 5-25. Small-Signal Noninverting Response

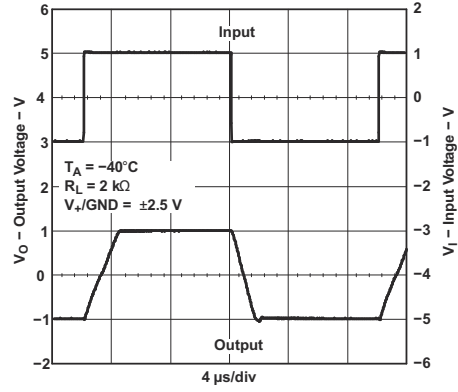

Figure 5-26. Large-Signal Noninverting Response

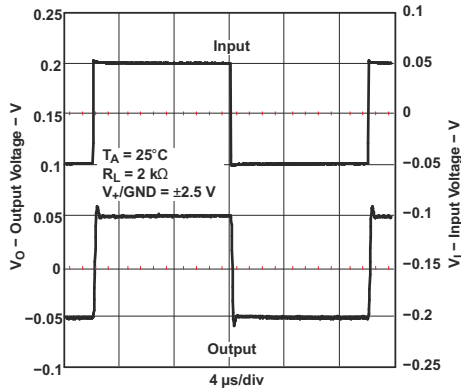

Figure 5-27. Small-Signal Noninverting Response

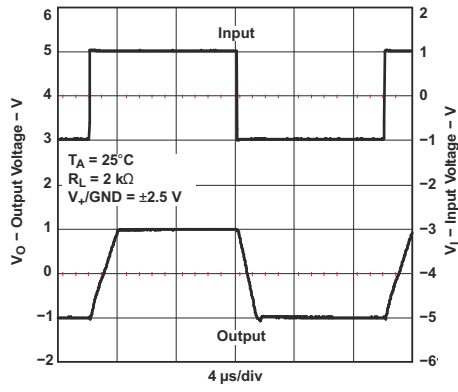

Figure 5-28. Large-Signal Noninverting Response

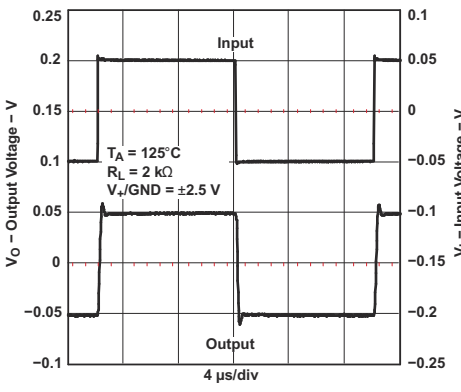

Figure 5-29. Small-Signal Noninverting Response

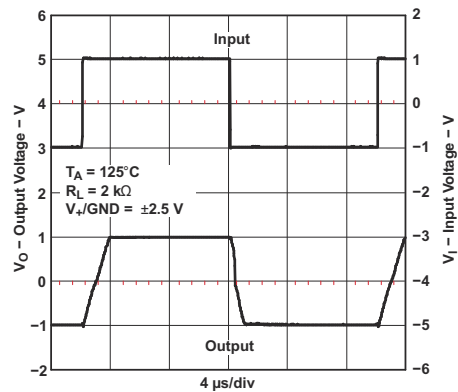

Figure 5-30. Large-Signal Noninverting Response

5.11 Typical Characteristics (continued)

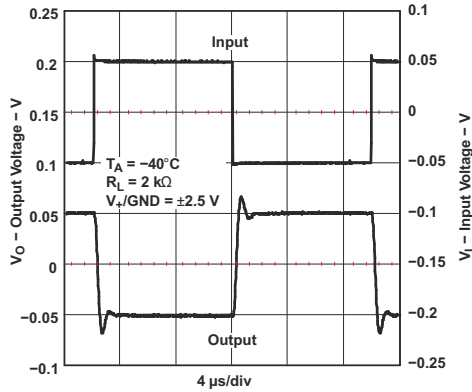

Figure 5-31. Small-Signal Noninverting Response

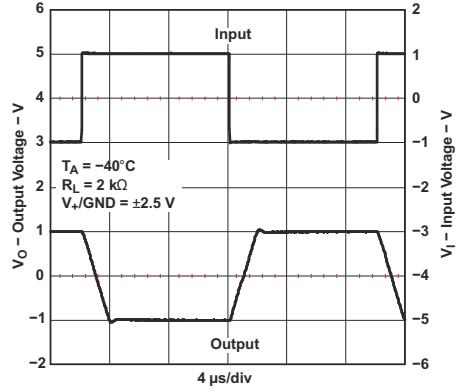

Figure 5-32. Large-Signal Inverting Response

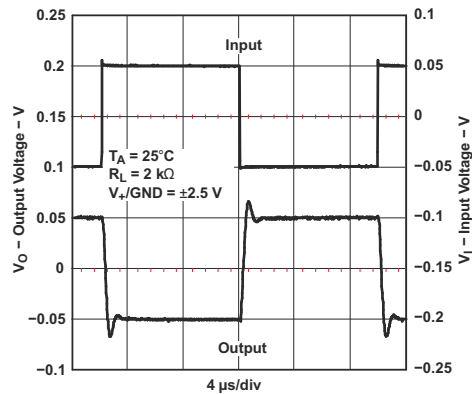

Figure 5-33. Small-Signal Inverting Response

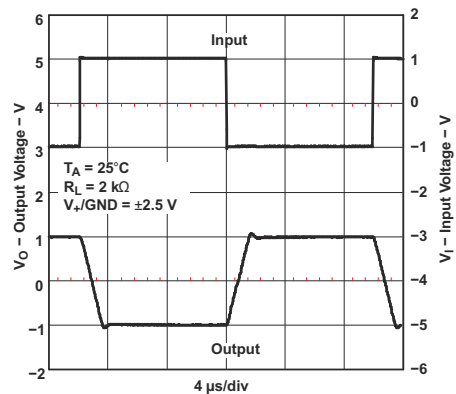

Figure 5-34. Large-Signal Inverting Response

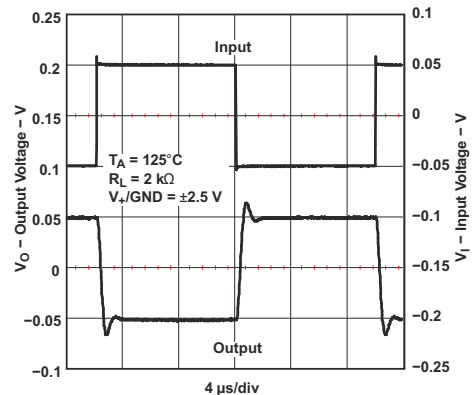

Figure 5-35. Small-Signal Inverting Response

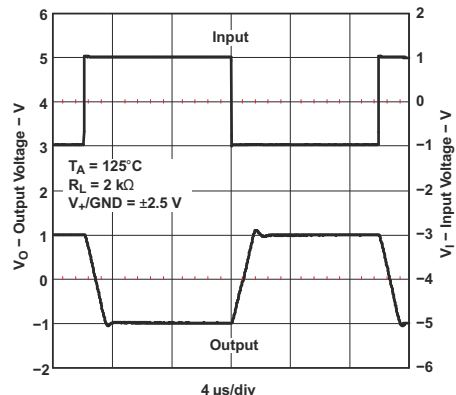

Figure 5-36. Large-Signal Inverting Response

6 Detailed Description

6.1 Overview

The TLV34xx devices are precision operational amplifiers with CMOS inputs for very low input bias current. Grade A devices offer lower V_{IO} for high accuracy in direct-coupled applications. Output is rail to rail and input common mode includes ground. TLV341 and TLV342S have shutdown mode for very low supply current.

6.2 Functional Block Diagram

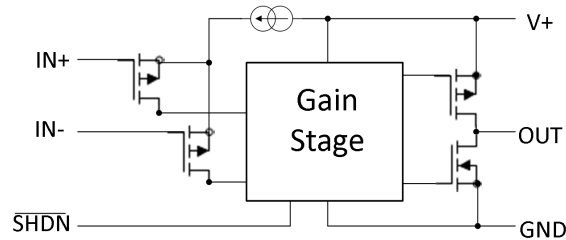

6.3 Feature Description

6.3.1 PMOS Input Stage

PMOS Input Stage supports a lower input range that includes ground. Upper range limit is $V_{CC} - 0.6V$.

6.3.2 CMOS Output Stage

The CMOS drain output topology allows rail-to-rail output swing.

6.3.3 Shutdown

TLV341 and TLV342S include a shutdown pin. During shutdown, I_{CC} is nearly zero and the output becomes high impedance. The typical turnon time coming out of shutdown is $5\mu s$.

6.4 Device Functional Modes

The TLV34xx devices have two operation modes:

- Normal operation when \overline{SHDN} pin is at V_+ level or the \overline{SHDN} pin is not present
- Shutdown mode when \overline{SHDN} is at GND level; I_{CC} is very low and output is high impedance.

7 Application and Implementation

Note

Information in the following applications sections is not part of the TI component specification, and TI does not warrant its accuracy or completeness. TI's customers are responsible for determining suitability of components for their purposes, as well as validating and testing their design implementation to confirm system functionality.

7.1 Application Information

The TLV34xx devices have rail-to-rail output and input range from ground to $V_{CC} - 0.6V$. CMOS inputs provide very low input current. Shutdown capability is an option in dual amplifier version. Operation from 1.5V to 5.5V is possible.

7.2 Typical Application

A typical application for an operational amplifier in an inverting amplifier. This amplifier takes a positive voltage on the input, and makes outputs a negative voltage of the same magnitude. In the same manner, the amplifier also makes negative voltages positive.

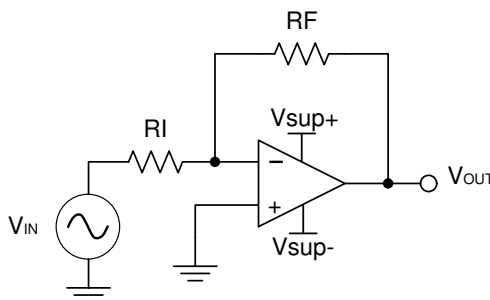

Figure 7-1. Application Schematic

7.2.1 Design Requirements

The supply voltage must be chosen to be larger than the input voltage range and output voltage range. For instance, this application scales a signal of $\pm 0.5V$ to $\pm 1.8V$. Setting the supply at $\pm 2V$ is sufficient to accommodate this application. The supplies can power up in any order; however, neither supply can be of opposite polarity relative to ground at any time; otherwise, a large current can flow through the input ESD diodes. TI highly recommends adding a series resistor to the grounded input to limit current in such an occurrence. V_{sup+} must be more positive than V_{sup-} at all times; otherwise, a large reverse supply current can flow.

7.2.2 Detailed Design Procedure

Determine the gain required by the inverting amplifier using [Equation 1](#) and [Equation 2](#):

$$A_V = \frac{V_{OUT}}{V_{IN}} \quad (1)$$

$$A_V = \frac{1.8}{-0.5} = -3.6 \quad (2)$$

Once the desired gain is determined, choose a value for R_I or R_F . Choosing a value in the $k\Omega$ range is desirable because the amplifier circuit uses currents in the mA range. This maintains that the part does not draw too much current. For this example, choose $10k\Omega$ for R_I , which means $36k\Omega$ is used for R_F . This is determined by [Equation 3](#).

$$A_V = -\frac{R_F}{R_I} \quad (3)$$

7.2.3 Application Curve

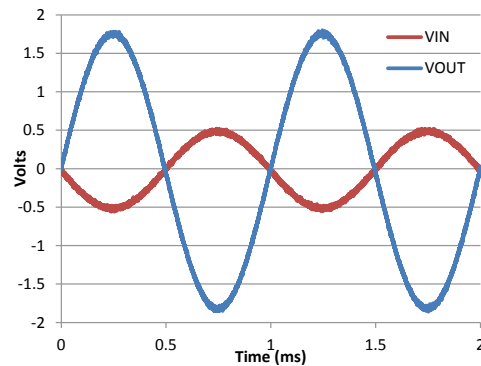

Figure 7-2. Input and Output Voltages of the Inverting Amplifier

7.3 Power Supply Recommendations

CAUTION

Supply voltages larger than 5.5V for a single supply can permanently damage the device (see the [Section 5.1](#)).

Place 0.1 μ F bypass capacitors close to the power-supply pins to reduce errors coupling in from noisy or high-impedance power supplies.

7.4 Layout

7.4.1 Layout Guidelines

For best operational performance of the device, use good PCB layout practices, including:

- Noise can propagate into analog circuitry through the power pins of the circuit as a whole, as well as the operational amplifier. Bypass capacitors are used to reduce the coupled noise by providing low-impedance power sources local to the analog circuitry.
 - Connect low-ESR, 0.1 μ F ceramic bypass capacitors between each supply pin and ground, placed as close to the device as possible. A single bypass capacitor from V_+ to ground is applicable for single-supply applications.
- Separate grounding for analog and digital portions of circuitry is one of the simplest and most effective methods of noise suppression. One or more layers on multilayer PCBs are typically devoted to ground planes. A ground plane helps distribute heat and reduces EMI noise pickup. Make sure to physically separate digital and analog grounds while paying attention to the flow of the ground current.
- To reduce parasitic coupling, run the input traces as far away from the supply or output traces as possible. If not possible to keep them separate, cross the sensitive trace perpendicular as opposed to in parallel with the noisy trace.
- Place the external components as close to the device as possible. Keeping RF and RG close to the inverting input minimizes parasitic capacitance, as shown in [Section 7.4.1](#).
- Keep the length of input traces as short as possible. Always remember that the input traces are the most sensitive part of the circuit.
- Consider a driven, low-impedance guard ring around the critical traces. A guard ring can significantly reduce leakage currents from nearby traces that are at different potentials.

7.4.2 Layout Example

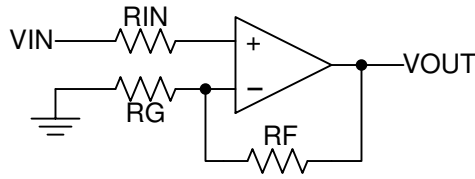

Figure 7-3. Layout Schematic

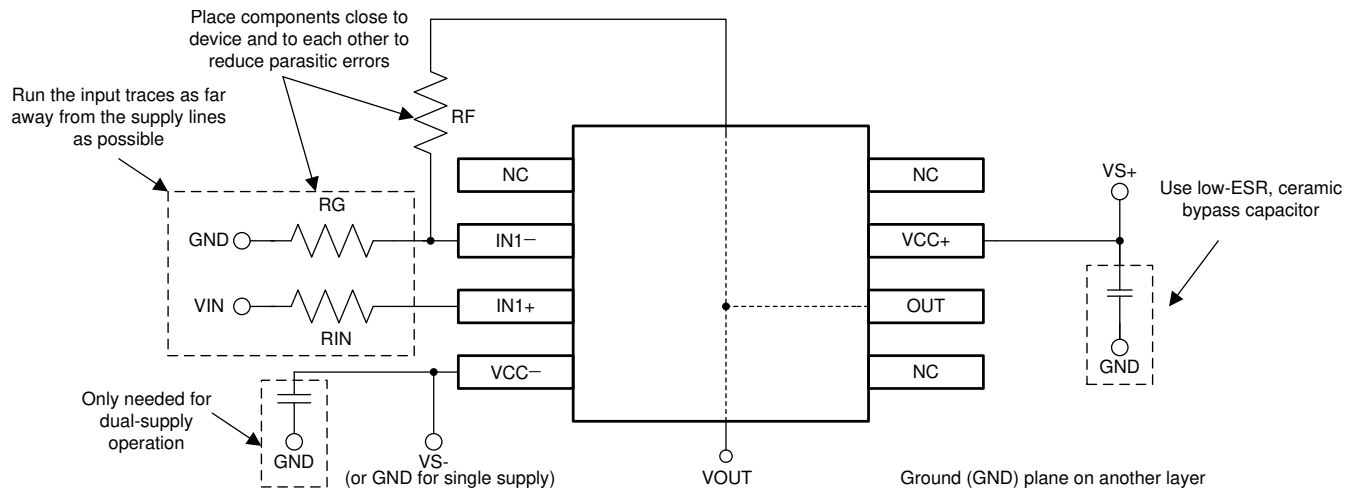

Figure 7-4. Operational Amplifier Schematic for Noninverting Configuration

8 Device and Documentation Support

8.1 Receiving Notification of Documentation Updates

To receive notification of documentation updates, navigate to the device product folder on ti.com. Click on *Notifications* to register and receive a weekly digest of any product information that has changed. For change details, review the revision history included in any revised document.

8.2 Support Resources

[TI E2E™ support forums](#) are an engineer's go-to source for fast, verified answers and design help — straight from the experts. Search existing answers or ask your own question to get the quick design help you need.

Linked content is provided "AS IS" by the respective contributors. They do not constitute TI specifications and do not necessarily reflect TI's views; see TI's [Terms of Use](#).

8.3 Trademarks

TI E2E™ is a trademark of Texas Instruments.
 All trademarks are the property of their respective owners.

8.4 Electrostatic Discharge Caution



This integrated circuit can be damaged by ESD. Texas Instruments recommends that all integrated circuits be handled with appropriate precautions. Failure to observe proper handling and installation procedures can cause damage.

ESD damage can range from subtle performance degradation to complete device failure. Precision integrated circuits may be more susceptible to damage because very small parametric changes could cause the device not to meet its published specifications.

8.5 Glossary

[TI Glossary](#) This glossary lists and explains terms, acronyms, and definitions.

9 Revision History

NOTE: Page numbers for previous revisions may differ from page numbers in the current version.

Changes from Revision D (February 2016) to Revision E (June 2025)	Page
• Updated the numbering format for tables, figures, and cross-references throughout the document.....	1
• Changed typical supply current (per channel) at 25°C from 70µA to 150µA for both V ₊ = 1.8V and V ₊ = 5V supply voltages.....	7
• Changed maximum supply current (per channel) at 25°C from 150µA to 200µA for both V ₊ = 1.8V and V ₊ = 5V supply voltages.....	7
• Changed maximum supply current (per channel) at full temperature range and V ₊ = 1.8V from 200µA to 210µA.....	7
• Changed maximum supply current (per channel) at full temperature range and V ₊ = 5V from 200µA to 215µA.....	8
• Changed maximum recommended shutdown pin voltage from 0.5V to 0.2V for both V ₊ = 1.8V and V ₊ = 5V supply voltages.....	9

Changes from Revision C (November 2007) to Revision D (February 2016)	Page
• Added <i>ESD Ratings</i> table, <i>Feature Description</i> section, <i>Device Functional Modes, Application and Implementation</i> section, <i>Power Supply Recommendations</i> section, <i>Layout</i> section, <i>Device and Documentation Support</i> section, and <i>Mechanical, Packaging, and Orderable Information</i> section	1
• Removed DPK Package, and TLV344 part from the <i>Pin Configuration and Functions</i> table	3

10 Mechanical, Packaging, and Orderable Information

The following pages include mechanical, packaging, and orderable information. This information is the most current data available for the designated devices. This data is subject to change without notice and revision of this document. For browser-based versions of this data sheet, refer to the left-hand navigation.

PACKAGING INFORMATION

Orderable part number	Status (1)	Material type (2)	Package Pins	Package qty Carrier	RoHS (3)	Lead finish/ Ball material (4)	MSL rating/ Peak reflow (5)	Op temp (°C)	Part marking (6)
TLV341AIDBVR	Active	Production	SOT-23 (DBV) 6	3000 LARGE T&R	Yes	NIPDAU	Level-1-260C-UNLIM	-40 to 125	YCGE
TLV341AIDBVR.A	Active	Production	SOT-23 (DBV) 6	3000 LARGE T&R	Yes	NIPDAU	Level-1-260C-UNLIM	-40 to 125	YCGE
TLV341AIDBVT	Obsolete	Production	SOT-23 (DBV) 6	-	-	Call TI	Call TI	-40 to 125	YCGE
TLV341AIDCKR	Active	Production	SC70 (DCK) 6	3000 LARGE T&R	Yes	Call TI	Level-1-260C-UNLIM	-40 to 125	Y5E
TLV341AIDCKR.A	Active	Production	SC70 (DCK) 6	3000 LARGE T&R	Yes	Call TI	Level-1-260C-UNLIM	-40 to 125	Y5E
TLV341AIDCKT	Obsolete	Production	SC70 (DCK) 6	-	-	Call TI	Call TI	-40 to 125	Y5E
TLV341IDBVR	Active	Production	SOT-23 (DBV) 6	3000 LARGE T&R	Yes	NIPDAU	Level-1-260C-UNLIM	-40 to 125	YC9E
TLV341IDBVR.A	Active	Production	SOT-23 (DBV) 6	3000 LARGE T&R	Yes	NIPDAU	Level-1-260C-UNLIM	-40 to 125	YC9E
TLV341IDCKR	Active	Production	SC70 (DCK) 6	3000 LARGE T&R	Yes	SN	Level-1-260C-UNLIM	-40 to 125	Y4E
TLV341IDCKR.A	Active	Production	SC70 (DCK) 6	3000 LARGE T&R	Yes	SN	Level-1-260C-UNLIM	-40 to 125	Y4E
TLV341IDCKRG4	Active	Production	SC70 (DCK) 6	3000 LARGE T&R	Yes	NIPDAU	Level-1-260C-UNLIM	-40 to 125	Y4E
TLV341IDCKRG4.A	Active	Production	SC70 (DCK) 6	3000 LARGE T&R	Yes	NIPDAU	Level-1-260C-UNLIM	-40 to 125	Y4E
TLV341IDCKT	Obsolete	Production	SC70 (DCK) 6	-	-	Call TI	Call TI	-40 to 125	Y4E
TLV341IDRLR	Active	Production	SOT-5X3 (DRL) 6	4000 LARGE T&R	Yes	NIPDAUAG	Level-1-260C-UNLIM	-40 to 125	(Y4A, Y4W)
TLV341IDRLR.A	Active	Production	SOT-5X3 (DRL) 6	4000 LARGE T&R	Yes	NIPDAUAG	Level-1-260C-UNLIM	-40 to 125	(Y4A, Y4W)
TLV342AID	Obsolete	Production	SOIC (D) 8	-	-	Call TI	Call TI	-40 to 125	TY342A
TLV342AIDR	Active	Production	SOIC (D) 8	2500 LARGE T&R	Yes	NIPDAU	Level-1-260C-UNLIM	-40 to 125	TY342A
TLV342AIDR.A	Active	Production	SOIC (D) 8	2500 LARGE T&R	Yes	NIPDAU	Level-1-260C-UNLIM	-40 to 125	TY342A
TLV342ID	Obsolete	Production	SOIC (D) 8	-	-	Call TI	Call TI	-40 to 125	TY342
TLV342IDGKR	Active	Production	VSSOP (DGK) 8	2500 LARGE T&R	Yes	SN	Level-1-260C-UNLIM	-40 to 125	Y6A
TLV342IDGKR.A	Active	Production	VSSOP (DGK) 8	2500 LARGE T&R	Yes	SN	Level-1-260C-UNLIM	-40 to 125	Y6A
TLV342IDR	Active	Production	SOIC (D) 8	2500 LARGE T&R	Yes	NIPDAU	Level-1-260C-UNLIM	-40 to 125	TY342
TLV342IDR.A	Active	Production	SOIC (D) 8	2500 LARGE T&R	Yes	NIPDAU	Level-1-260C-UNLIM	-40 to 125	TY342
TLV342IRUGR	Active	Production	X2QFN (RUG) 10	3000 LARGE T&R	Yes	NIPDAU	Level-1-260C-UNLIM	-40 to 125	(1S8, Y6E)
TLV342IRUGR.A	Active	Production	X2QFN (RUG) 10	3000 LARGE T&R	Yes	NIPDAU	Level-1-260C-UNLIM	-40 to 125	(1S8, Y6E)
TLV342IRUGRG4	Active	Production	X2QFN (RUG) 10	3000 LARGE T&R	Yes	NIPDAU	Level-1-260C-UNLIM	-40 to 125	1S8
TLV342IRUGRG4.A	Active	Production	X2QFN (RUG) 10	3000 LARGE T&R	Yes	NIPDAU	Level-1-260C-UNLIM	-40 to 125	1S8
TLV342SIRUGR	Active	Production	X2QFN (RUG) 10	3000 LARGE T&R	Yes	NIPDAU	Level-1-260C-UNLIM	-40 to 125	(10A, 2YE)
TLV342SIRUGR.A	Active	Production	X2QFN (RUG) 10	3000 LARGE T&R	Yes	NIPDAU	Level-1-260C-UNLIM	-40 to 125	(10A, 2YE)

Orderable part number	Status (1)	Material type (2)	Package Pins	Package qty Carrier	RoHS (3)	Lead finish/ Ball material (4)	MSL rating/ Peak reflow (5)	Op temp (°C)	Part marking (6)
TLV342SIRUGRG4	Active	Production	X2QFN (RUG) 10	3000 LARGE T&R	Yes	NIPDAU	Level-1-260C-UNLIM	-40 to 125	10A
TLV342SIRUGRG4.A	Active	Production	X2QFN (RUG) 10	3000 LARGE T&R	Yes	NIPDAU	Level-1-260C-UNLIM	-40 to 125	10A

(1) **Status:** For more details on status, see our [product life cycle](#).

(2) **Material type:** When designated, preproduction parts are prototypes/experimental devices, and are not yet approved or released for full production. Testing and final process, including without limitation quality assurance, reliability performance testing, and/or process qualification, may not yet be complete, and this item is subject to further changes or possible discontinuation. If available for ordering, purchases will be subject to an additional waiver at checkout, and are intended for early internal evaluation purposes only. These items are sold without warranties of any kind.

(3) **RoHS values:** Yes, No, RoHS Exempt. See the [TI RoHS Statement](#) for additional information and value definition.

(4) **Lead finish/Ball material:** Parts may have multiple material finish options. Finish options are separated by a vertical ruled line. Lead finish/Ball material values may wrap to two lines if the finish value exceeds the maximum column width.

(5) **MSL rating/Peak reflow:** The moisture sensitivity level ratings and peak solder (reflow) temperatures. In the event that a part has multiple moisture sensitivity ratings, only the lowest level per JEDEC standards is shown. Refer to the shipping label for the actual reflow temperature that will be used to mount the part to the printed circuit board.

(6) **Part marking:** There may be an additional marking, which relates to the logo, the lot trace code information, or the environmental category of the part.

Multiple part markings will be inside parentheses. Only one part marking contained in parentheses and separated by a "-" will appear on a part. If a line is indented then it is a continuation of the previous line and the two combined represent the entire part marking for that device.

Important Information and Disclaimer: The information provided on this page represents TI's knowledge and belief as of the date that it is provided. TI bases its knowledge and belief on information provided by third parties, and makes no representation or warranty as to the accuracy of such information. Efforts are underway to better integrate information from third parties. TI has taken and continues to take reasonable steps to provide representative and accurate information but may not have conducted destructive testing or chemical analysis on incoming materials and chemicals. TI and TI suppliers consider certain information to be proprietary, and thus CAS numbers and other limited information may not be available for release.

In no event shall TI's liability arising out of such information exceed the total purchase price of the TI part(s) at issue in this document sold by TI to Customer on an annual basis.

TAPE AND REEL INFORMATION

QUADRANT ASSIGNMENTS FOR PIN 1 ORIENTATION IN TAPE

*All dimensions are nominal

Device	Package Type	Package Drawing	Pins	SPQ	Reel Diameter (mm)	Reel Width W1 (mm)	A0 (mm)	B0 (mm)	K0 (mm)	P1 (mm)	W (mm)	Pin1 Quadrant
TLV341AIDBVR	SOT-23	DBV	6	3000	180.0	8.4	3.2	3.2	1.4	4.0	8.0	Q3
TLV341AIDCKR	SC70	DCK	6	3000	178.0	9.0	2.4	2.5	1.2	4.0	8.0	Q3
TLV341IDBVR	SOT-23	DBV	6	3000	180.0	8.4	3.2	3.2	1.4	4.0	8.0	Q3
TLV341IDCKR	SC70	DCK	6	3000	178.0	9.0	2.4	2.5	1.2	4.0	8.0	Q3
TLV341IDCKRG4	SC70	DCK	6	3000	179.0	8.4	2.2	2.5	1.2	4.0	8.0	Q3
TLV341IDRLR	SOT-5X3	DRL	6	4000	180.0	8.4	1.98	1.78	0.69	4.0	8.0	Q3
TLV342AIDR	SOIC	D	8	2500	330.0	12.4	6.4	5.2	2.1	8.0	12.0	Q1
TLV342AIDR	SOIC	D	8	2500	330.0	12.4	6.4	5.2	2.1	8.0	12.0	Q1
TLV342IDGKR	VSSOP	DGK	8	2500	330.0	12.4	5.25	3.35	1.25	8.0	12.0	Q1
TLV342IDR	SOIC	D	8	2500	330.0	12.4	6.4	5.2	2.1	8.0	12.0	Q1
TLV342IDR	SOIC	D	8	2500	330.0	12.4	6.4	5.2	2.1	8.0	12.0	Q1
TLV342IRUGR	X2QFN	RUG	10	3000	180.0	8.4	1.75	2.25	0.55	4.0	8.0	Q1
TLV342IRUGRG4	X2QFN	RUG	10	3000	180.0	8.4	1.75	2.25	0.55	4.0	8.0	Q1
TLV342SIRUGR	X2QFN	RUG	10	3000	180.0	8.4	1.75	2.25	0.55	4.0	8.0	Q1
TLV342SIRUGRG4	X2QFN	RUG	10	3000	180.0	8.4	1.75	2.25	0.55	4.0	8.0	Q1

TAPE AND REEL BOX DIMENSIONS

*All dimensions are nominal

Device	Package Type	Package Drawing	Pins	SPQ	Length (mm)	Width (mm)	Height (mm)
TLV341AIDBVR	SOT-23	DBV	6	3000	210.0	185.0	35.0
TLV341AIDCKR	SC70	DCK	6	3000	180.0	180.0	18.0
TLV341IDBVR	SOT-23	DBV	6	3000	210.0	185.0	35.0
TLV341IDCKR	SC70	DCK	6	3000	180.0	180.0	18.0
TLV341IDCKRG4	SC70	DCK	6	3000	200.0	183.0	25.0
TLV341IDRLR	SOT-5X3	DRL	6	4000	202.0	201.0	28.0
TLV342AIDR	SOIC	D	8	2500	353.0	353.0	32.0
TLV342AIDR	SOIC	D	8	2500	353.0	353.0	32.0
TLV342IDGKR	VSSOP	DGK	8	2500	366.0	364.0	50.0
TLV342IDR	SOIC	D	8	2500	353.0	353.0	32.0
TLV342IDR	SOIC	D	8	2500	353.0	353.0	32.0
TLV342IRUGR	X2QFN	RUG	10	3000	210.0	185.0	35.0
TLV342IRUGRG4	X2QFN	RUG	10	3000	210.0	185.0	35.0
TLV342SIRUGR	X2QFN	RUG	10	3000	210.0	185.0	35.0
TLV342SIRUGRG4	X2QFN	RUG	10	3000	210.0	185.0	35.0

DRL0006A



PACKAGE OUTLINE

SOT - 0.6 mm max height

PLASTIC SMALL OUTLINE

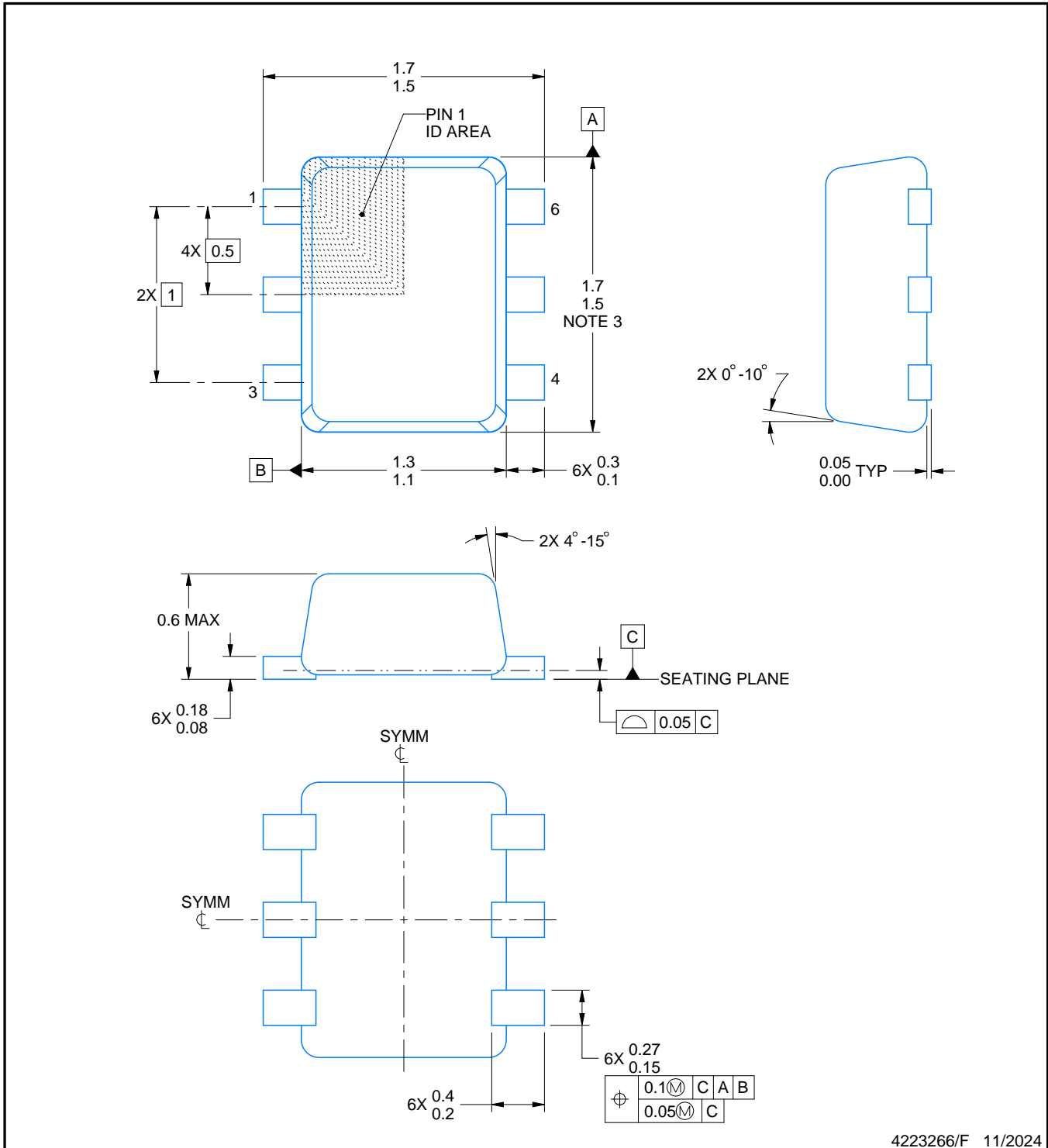

4223266/F 11/2024

NOTES:

1. All linear dimensions are in millimeters. Any dimensions in parenthesis are for reference only. Dimensioning and tolerancing per ASME Y14.5M.
2. This drawing is subject to change without notice.
3. This dimension does not include mold flash, protrusions, or gate burrs. Mold flash, protrusions, or gate burrs shall not exceed 0.15 mm per side.
4. Reference JEDEC registration MO-293 Variation UAAD

EXAMPLE BOARD LAYOUT

DRL0006A

SOT - 0.6 mm max height

PLASTIC SMALL OUTLINE

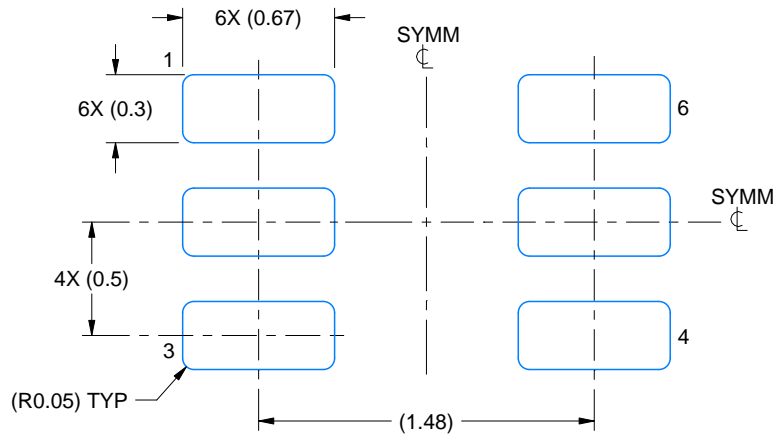

LAND PATTERN EXAMPLE
SCALE:30X

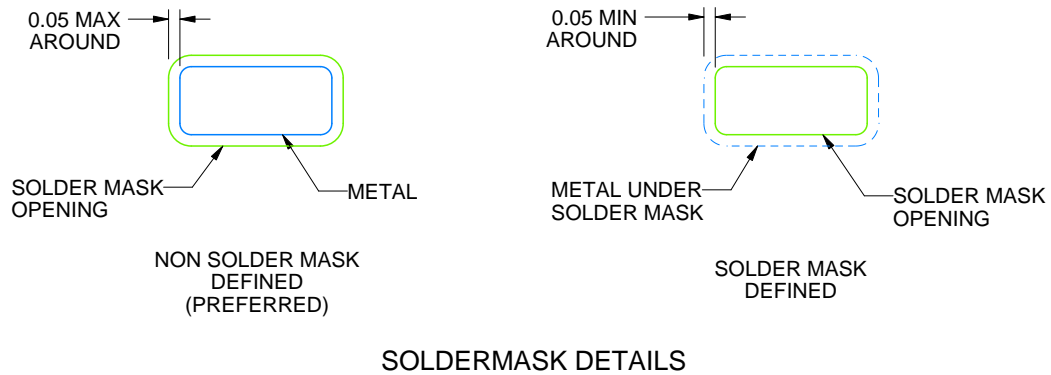

SOLDERMASK DETAILS

4223266/F 11/2024

NOTES: (continued)

5. Publication IPC-7351 may have alternate designs.
6. Solder mask tolerances between and around signal pads can vary based on board fabrication site.
7. Land pattern design aligns to IPC-610, Bottom Termination Component (BTC) solder joint inspection criteria.

EXAMPLE STENCIL DESIGN

DRL0006A

SOT - 0.6 mm max height

PLASTIC SMALL OUTLINE

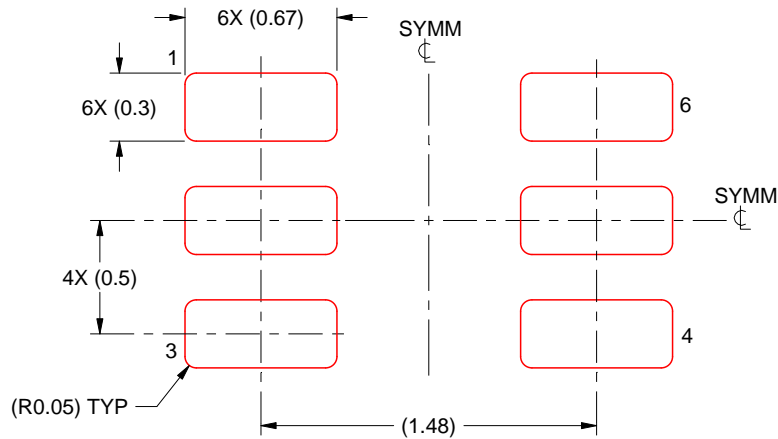

SOLDER PASTE EXAMPLE
BASED ON 0.1 mm THICK STENCIL
SCALE:30X

4223266/F 11/2024

NOTES: (continued)

8. Laser cutting apertures with trapezoidal walls and rounded corners may offer better paste release. IPC-7525 may have alternate design recommendations.
9. Board assembly site may have different recommendations for stencil design.



D0008A

PACKAGE OUTLINE

SOIC - 1.75 mm max height

SMALL OUTLINE INTEGRATED CIRCUIT



4214825/C 02/2019

NOTES:

- Linear dimensions are in inches [millimeters]. Dimensions in parenthesis are for reference only. Controlling dimensions are in inches. Dimensioning and tolerancing per ASME Y14.5M.
- This drawing is subject to change without notice.
- This dimension does not include mold flash, protrusions, or gate burrs. Mold flash, protrusions, or gate burrs shall not exceed $.006$ [0.15] per side.
- This dimension does not include interlead flash.
- Reference JEDEC registration MS-012, variation AA.

EXAMPLE BOARD LAYOUT

D0008A

SOIC - 1.75 mm max height

SMALL OUTLINE INTEGRATED CIRCUIT



LAND PATTERN EXAMPLE
EXPOSED METAL SHOWN
SCALE:8X



SOLDER MASK DETAILS

4214825/C 02/2019

NOTES: (continued)

6. Publication IPC-7351 may have alternate designs.

7. Solder mask tolerances between and around signal pads can vary based on board fabrication site.

EXAMPLE STENCIL DESIGN

D0008A

SOIC - 1.75 mm max height

SMALL OUTLINE INTEGRATED CIRCUIT



SOLDER PASTE EXAMPLE
BASED ON .005 INCH [0.125 MM] THICK STENCIL
SCALE:8X

4214825/C 02/2019

NOTES: (continued)

8. Laser cutting apertures with trapezoidal walls and rounded corners may offer better paste release. IPC-7525 may have alternate design recommendations.
9. Board assembly site may have different recommendations for stencil design.

EXAMPLE BOARD LAYOUT

DBV0006A

SOT-23 - 1.45 mm max height

SMALL OUTLINE TRANSISTOR



LAND PATTERN EXAMPLE
EXPOSED METAL SHOWN
SCALE:15X



SOLDER MASK DETAILS

4214840/G 08/2024

NOTES: (continued)

6. Publication IPC-7351 may have alternate designs.

7. Solder mask tolerances between and around signal pads can vary based on board fabrication site.

EXAMPLE STENCIL DESIGN

DBV0006A

SOT-23 - 1.45 mm max height

SMALL OUTLINE TRANSISTOR



SOLDER PASTE EXAMPLE
BASED ON 0.125 mm THICK STENCIL
SCALE:15X

4214840/G 08/2024

NOTES: (continued)

8. Laser cutting apertures with trapezoidal walls and rounded corners may offer better paste release. IPC-7525 may have alternate design recommendations.
9. Board assembly site may have different recommendations for stencil design.

DGK0008A



PACKAGE OUTLINE

VSSOP - 1.1 mm max height

SMALL OUTLINE PACKAGE

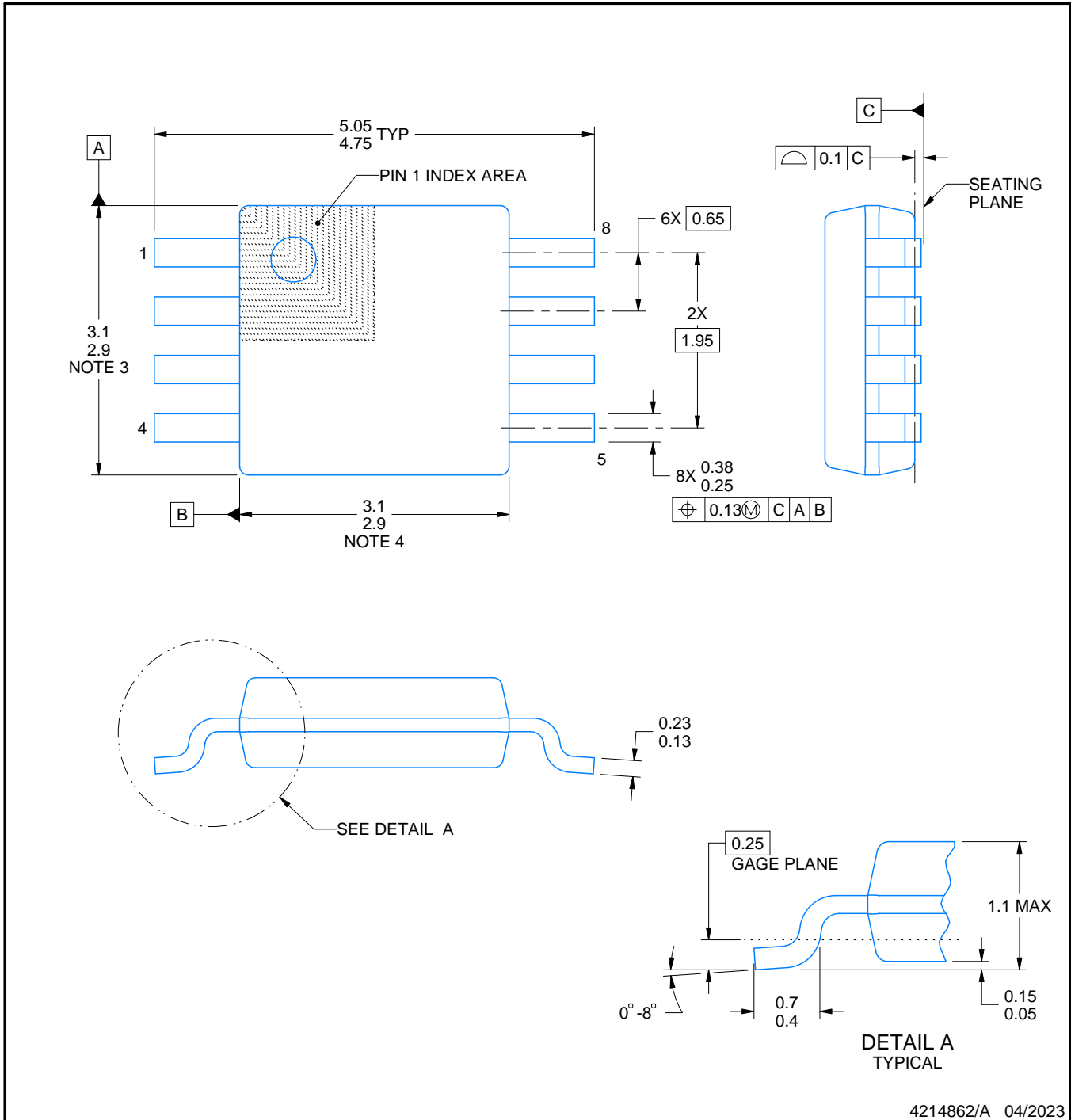

NOTES:

PowerPAD is a trademark of Texas Instruments.

1. All linear dimensions are in millimeters. Any dimensions in parenthesis are for reference only. Dimensioning and tolerancing per ASME Y14.5M.
2. This drawing is subject to change without notice.
3. This dimension does not include mold flash, protrusions, or gate burrs. Mold flash, protrusions, or gate burrs shall not exceed 0.15 mm per side.
4. This dimension does not include interlead flash. Interlead flash shall not exceed 0.25 mm per side.
5. Reference JEDEC registration MO-187.

EXAMPLE BOARD LAYOUT

DGK0008A

™ VSSOP - 1.1 mm max height

SMALL OUTLINE PACKAGE



LAND PATTERN EXAMPLE
EXPOSED METAL SHOWN
SCALE: 15X



4214862/A 04/2023

NOTES: (continued)

6. Publication IPC-7351 may have alternate designs.
7. Solder mask tolerances between and around signal pads can vary based on board fabrication site.
8. Vias are optional depending on application, refer to device data sheet. If any vias are implemented, refer to their locations shown on this view. It is recommended that vias under paste be filled, plugged or tented.
9. Size of metal pad may vary due to creepage requirement.

EXAMPLE STENCIL DESIGN

DGK0008A

™ VSSOP - 1.1 mm max height

SMALL OUTLINE PACKAGE



SOLDER PASTE EXAMPLE
SCALE: 15X

4214862/A 04/2023

NOTES: (continued)

11. Laser cutting apertures with trapezoidal walls and rounded corners may offer better paste release. IPC-7525 may have alternate design recommendations.
12. Board assembly site may have different recommendations for stencil design.

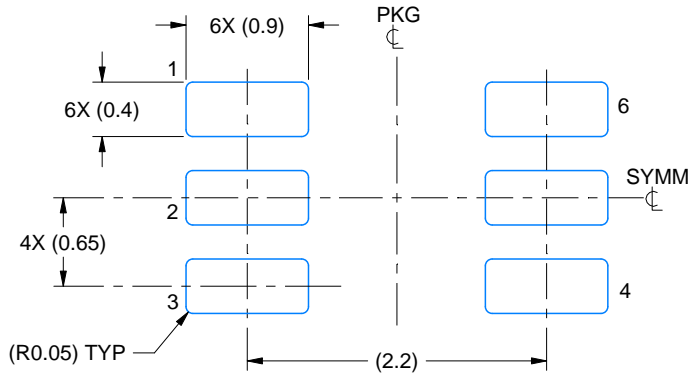

LAND PATTERN EXAMPLE
EXPOSED METAL SHOWN
SCALE:18X

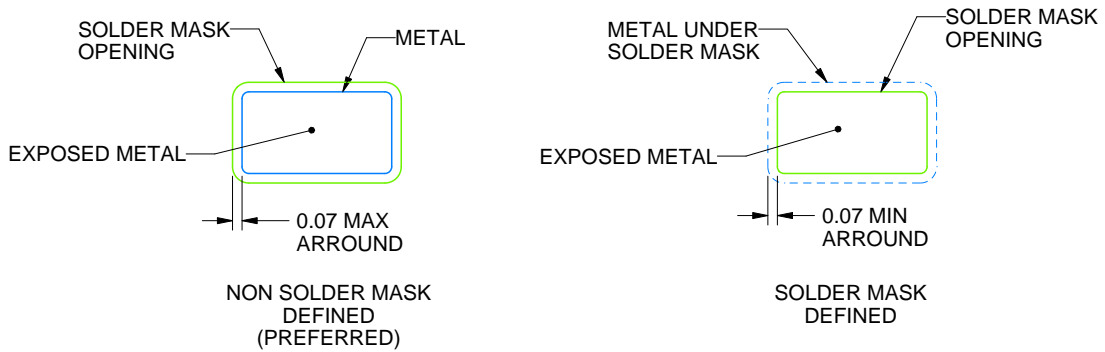

SOLDER MASK DETAILS

4214835/D 11/2024

NOTES: (continued)

- 5. Publication IPC-7351 may have alternate designs.
- 6. Solder mask tolerances between and around signal pads can vary based on board fabrication site.



SOLDER PASTE EXAMPLE
BASED ON 0.125 THICK STENCIL
SCALE:18X

4214835/D 11/2024

NOTES: (continued)

7. Laser cutting apertures with trapezoidal walls and rounded corners may offer better paste release. IPC-7525 may have alternate design recommendations.
8. Board assembly site may have different recommendations for stencil design.

GENERIC PACKAGE VIEW

RUG 10

X2QFN - 0.4 mm max height

1.5 x 2, 0.5 mm pitch

PLASTIC QUAD FLATPACK - NO LEAD

This image is a representation of the package family, actual package may vary.
Refer to the product data sheet for package details.

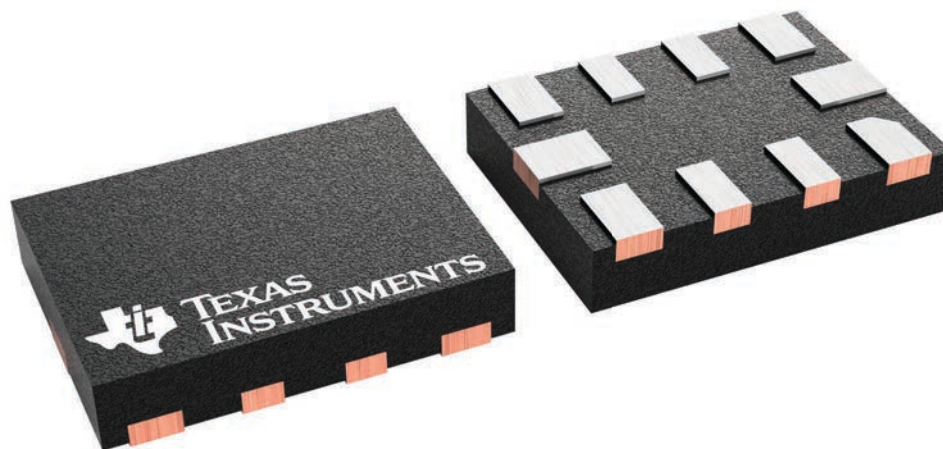

4231768/A

RUG0010A



PACKAGE OUTLINE

X2QFN - 0.4 mm max height

PLASTIC QUAD FLATPACK - NO LEAD

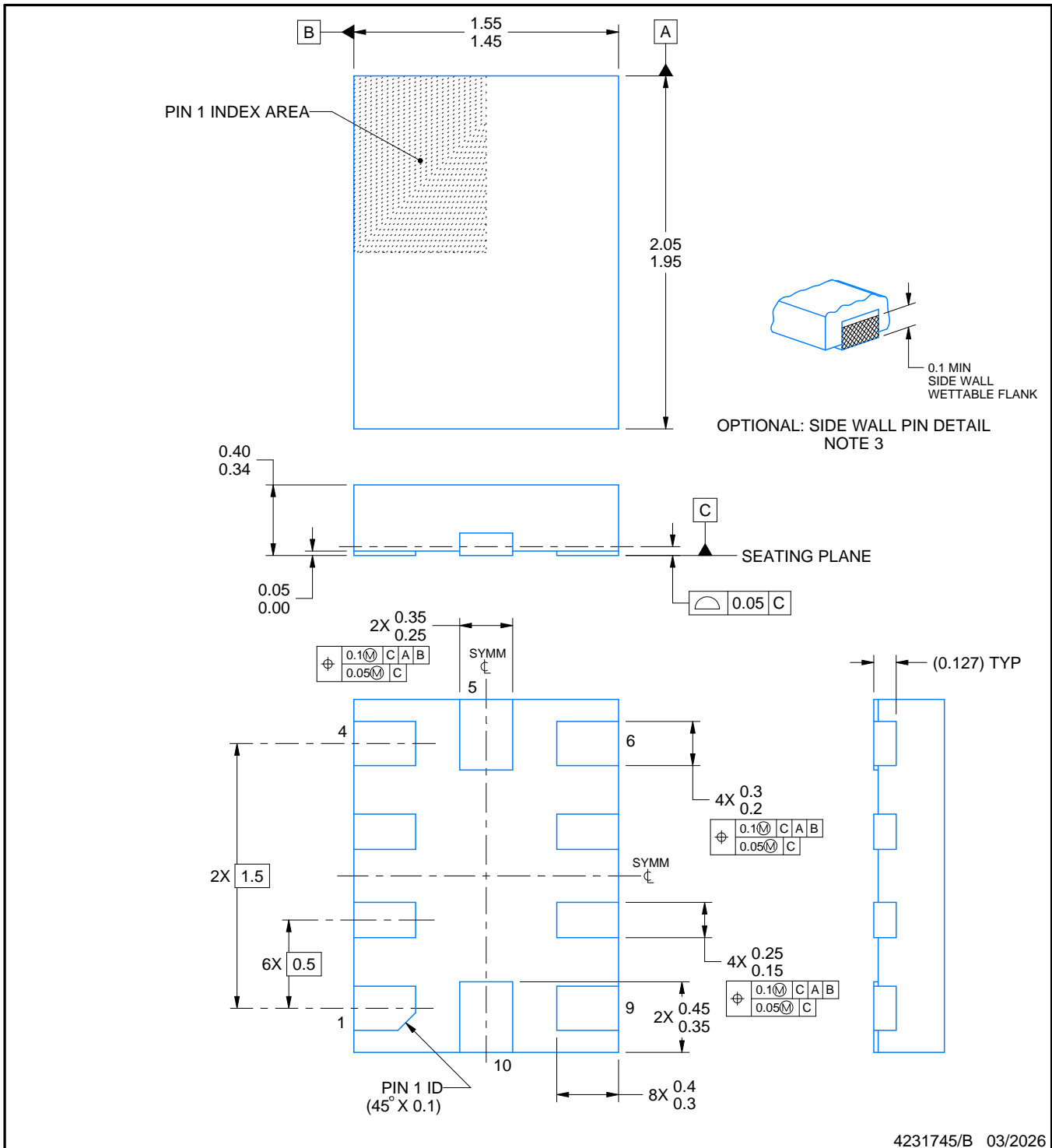

4231745/B 03/2026

NOTES:

1. All linear dimensions are in millimeters. Any dimensions in parenthesis are for reference only. Dimensioning and tolerancing per ASME Y14.5M.
2. This drawing is subject to change without notice.
3. Minimum 0.1 mm solder wetting on pin side wall. Available for wettable flank version only.

EXAMPLE BOARD LAYOUT

RUG0010A

X2QFN - 0.4 mm max height

PLASTIC QUAD FLATPACK - NO LEAD

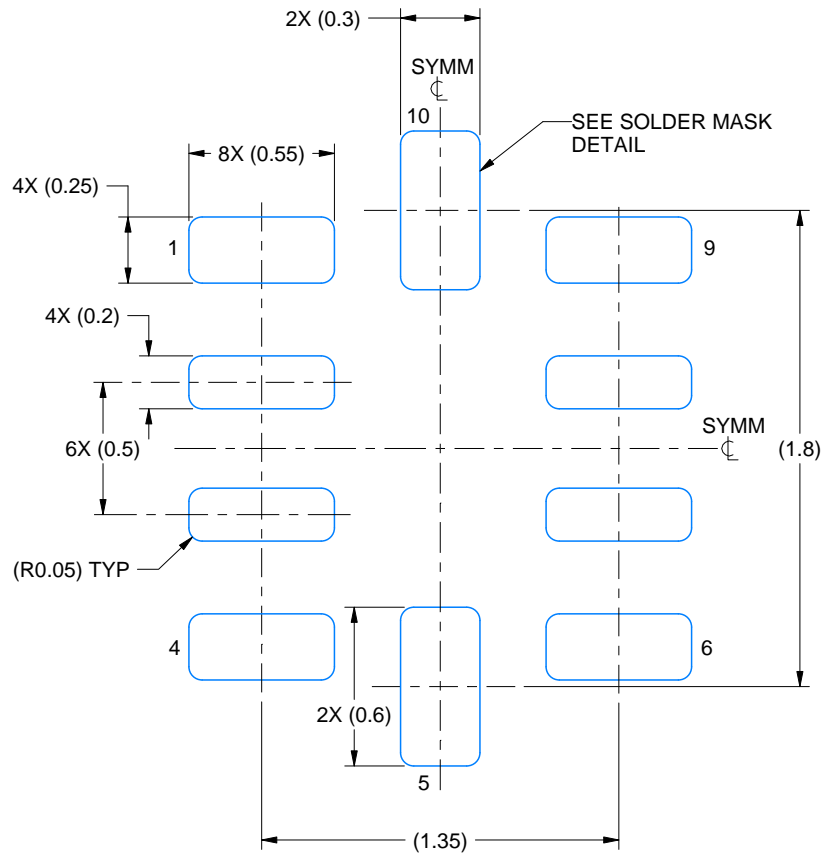

LAND PATTERN EXAMPLE
EXPOSED METAL SHOWN
SCALE: 35X

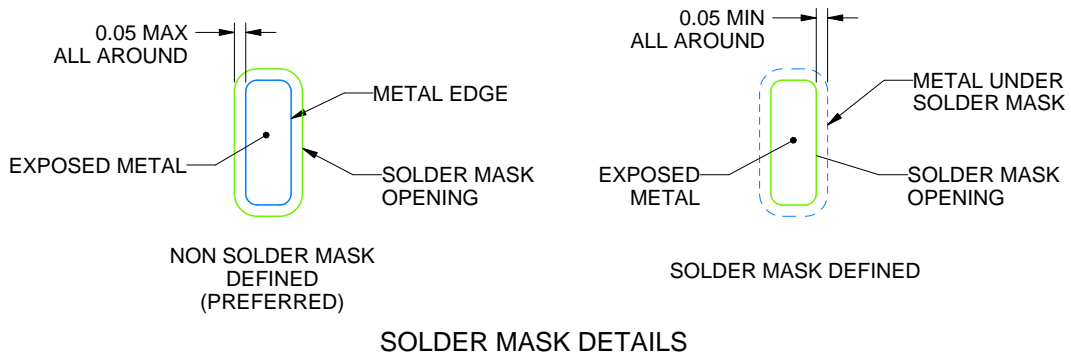

4231745/B 03/2026

NOTES: (continued)

3. For more information, see Texas Instruments literature number SLUA271 (www.ti.com/lit/sluea271).

EXAMPLE STENCIL DESIGN

RUG0010A

X2QFN - 0.4 mm max height

PLASTIC QUAD FLATPACK - NO LEAD

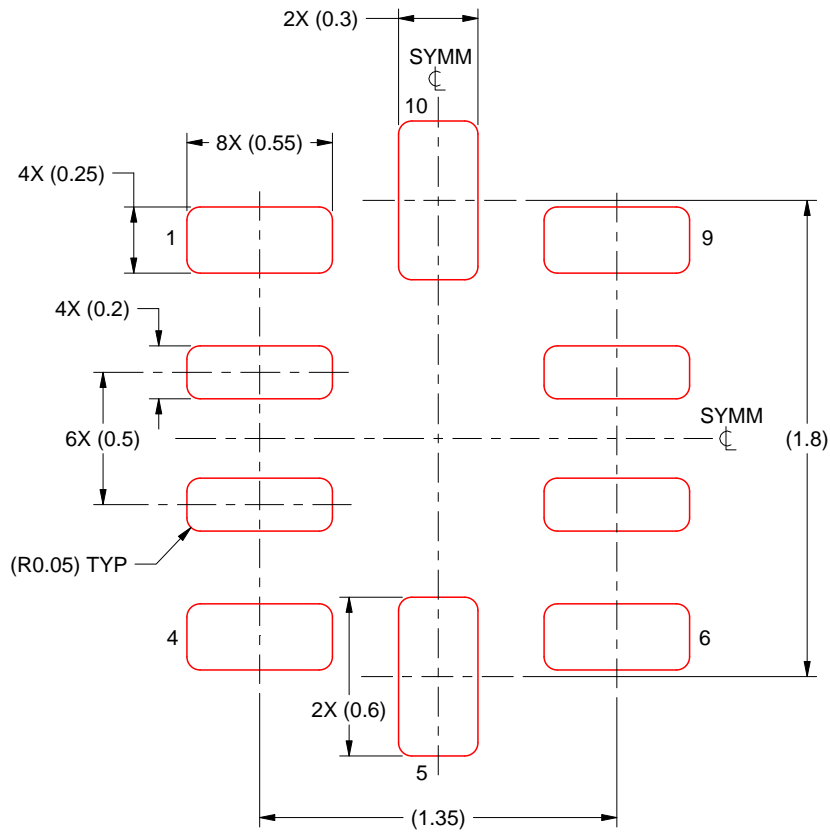

SOLDER PASTE EXAMPLE
BASED ON 0.125 MM THICK STENCIL
SCALE: 35X

4231745/B 03/2026

NOTES: (continued)

4. Laser cutting apertures with trapezoidal walls and rounded corners may offer better paste release. IPC-7525 may have alternate design recommendations.

IMPORTANT NOTICE AND DISCLAIMER

TI PROVIDES TECHNICAL AND RELIABILITY DATA (INCLUDING DATASHEETS), DESIGN RESOURCES (INCLUDING REFERENCE DESIGNS), APPLICATION OR OTHER DESIGN ADVICE, WEB TOOLS, SAFETY INFORMATION, AND OTHER RESOURCES "AS IS" AND WITH ALL FAULTS, AND DISCLAIMS ALL WARRANTIES, EXPRESS AND IMPLIED, INCLUDING WITHOUT LIMITATION ANY IMPLIED WARRANTIES OF MERCHANTABILITY, FITNESS FOR A PARTICULAR PURPOSE OR NON-INFRINGEMENT OF THIRD PARTY INTELLECTUAL PROPERTY RIGHTS.

These resources are intended for skilled developers designing with TI products. You are solely responsible for (1) selecting the appropriate TI products for your application, (2) designing, validating and testing your application, and (3) ensuring your application meets applicable standards, and any other safety, security, regulatory or other requirements.

These resources are subject to change without notice. TI grants you permission to use these resources only for development of an application that uses the TI products described in the resource. Other reproduction and display of these resources is prohibited. No license is granted to any other TI intellectual property right or to any third party intellectual property right. TI disclaims responsibility for, and you fully indemnify TI and its representatives against any claims, damages, costs, losses, and liabilities arising out of your use of these resources.

TI's products are provided subject to [TI's Terms of Sale](#), [TI's General Quality Guidelines](#), or other applicable terms available either on ti.com or provided in conjunction with such TI products. TI's provision of these resources does not expand or otherwise alter TI's applicable warranties or warranty disclaimers for TI products. Unless TI explicitly designates a product as custom or customer-specified, TI products are standard, catalog, general purpose devices.

TI objects to and rejects any additional or different terms you may propose.

Copyright © 2026, Texas Instruments Incorporated

Last updated 10/2025