

# TLE202x High-Speed, Low-Power, Bipolar Precision Operational Amplifiers

## 1 Features

- Supply current: 300 $\mu$ A, max
- High unity-gain bandwidth: 2MHz
- High slew rate: 0.65V/ $\mu$ s
- Specified for both 5V single-supply and  $\pm$ 15V operation
- Phase-reversal protection
- High open-loop gain: 6.5V/ $\mu$ V (136dB)
- Low offset voltage: 100 $\mu$ V, max
- Low input bias current: 50nA, max
- Low noise voltage: 19nV/ $\sqrt{\text{Hz}}$

## 2 Applications

- [Flow transmitter](#)
- [Lab and field instrumentation](#)
- [Analog input module](#)
- [Pressure transmitter](#)

## 3 Description

The TLE2021, TLE2022, and TLE2024 (TLE202x) devices are precision, high-speed, low-power operational amplifiers using a new Texas Instruments state-of-the art bipolar process. These devices combine the best features of the OP21, with a highly improved slew rate and unity-gain bandwidth.

The complementary bipolar process uses isolated vertical pnp transistors that yield dramatic improvement in unity-gain bandwidth and slew rate over similar devices.

The addition of a bias circuit in conjunction with this process results in extremely stable parameters with both time and temperature. Therefore, a precision

device remains a precision device even with changes in temperature and over years of use.

This combination of excellent dc performance with a common-mode input voltage range that includes the negative rail makes these devices an excellent choice for low-level signal conditioning applications in either single-supply or split-supply configurations. In addition, these devices offer phase-reversal protection circuitry that eliminates an unexpected change in output states when one of the inputs is less than the negative supply rail.

A variety of available options includes small-outline and chip-carrier versions for high-density systems applications.

The C-suffix devices are characterized for operation from 0°C to 70°C. The I-suffix devices are characterized for operation from -40°C to +85°C. The M-suffix devices are characterized for operation over the full military temperature range of -55°C to +125°C.

### Device Information

PART NUMBER <sup>(1)</sup>	CHANNEL COUNT	PACKAGE <sup>(2)</sup>
TLE2021	Single	D (SOIC, 8)
		P (PDIP, 8)
TLE2022	Dual	D (SOIC, 8)
		P (PDIP, 8)
TLE2024	Quad	DW (SOIC, 16)
		N (PDIP, 14)

(1) See [Section 4](#).

(2) For more information, see [Section 10](#).

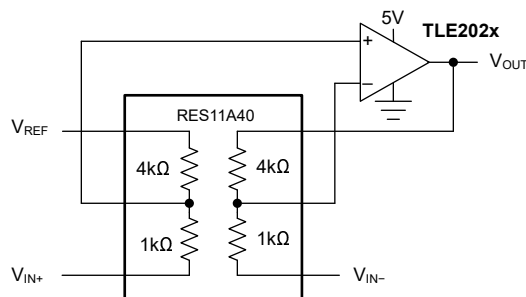

**Difference Amplifier Circuit With the RES11A**



## Table of Contents

<b>1 Features</b> .....	1	6.10 Electrical Characteristics for TLE2024, $V_{CC} = \pm 15V$ .....	21
<b>2 Applications</b> .....	1	6.11 Electrical Characteristics for TLE2024, $V_{CC} = 5V$ ....	24
<b>3 Description</b> .....	1	6.12 Typical Characteristics.....	27
<b>4 Device Comparison Tables</b> .....	2	<b>7 Application and Implementation</b> .....	36
<b>5 Pin Configuration and Functions</b> .....	3	7.1 Application Information.....	36
<b>6 Specifications</b> .....	6	7.2 Layout.....	37
6.1 Absolute Maximum Ratings.....	6	<b>8 Device and Documentation Support</b> .....	38
6.2 Recommended Operating Conditions.....	6	8.1 Device Support.....	38
6.3 Thermal Information for TLE2021.....	7	8.2 Receiving Notification of Documentation Updates....	38
6.4 Thermal Information for TLE2022.....	7	8.3 Support Resources.....	38
6.5 Thermal Information for TLE2024.....	7	8.4 Trademarks.....	38
6.6 Electrical Characteristics for TLE2021, $V_{CC} = \pm 15V$ .....	8	8.5 Electrostatic Discharge Caution.....	38
6.7 Electrical Characteristics for TLE2021, $V_{CC} = 5V$ ....	11	8.6 Glossary.....	38
6.8 Electrical Characteristics for TLE2022, $V_{CC} = \pm 15V$ .....	14	<b>9 Revision History</b> .....	39
6.9 Electrical Characteristics for TLE2022, $V_{CC} = 5V$ ....	18	<b>10 Mechanical, Packaging, and Orderable Information</b> .....	39

## 4 Device Comparison Tables

**Table 4-1. TLE2021 Available Options**

TEMPERATURE RANGE	INPUT OFFSET VOLTAGE	PART NUMBER	PACKAGES
0°C to 70°C	500µV 200µV	TLE2021C TLE2021AC	D (SOIC, 8) P (PDIP, 8)
-40°C to 85°C	500µV 200µV	TLE2021I TLE2021AI	D (SOIC, 8) P (PDIP, 8)
-55°C to 125°C	500µV	TLE2021M	D (SOIC, 8)

**Table 4-2. TLE2022 Available Options**

TEMPERATURE RANGE	INPUT OFFSET VOLTAGE	PART NUMBER	PACKAGES
0°C to 70°C	500µV 300µV	TLE2022C TLE2022AC	D (SOIC, 8) P (PDIP, 8)
-40°C to 85°C	500µV 300µV	TLE2022I TLE2022AI	D (SOIC, 8) P (PDIP, 8)
-55°C to 125°C	500µV 300µV	TLE2022M TLE2022AM	D (SOIC, 8)

**Table 4-3. TLE2024 Available Options**

TEMPERATURE RANGE	INPUT OFFSET VOLTAGE	PART NUMBER	PACKAGES
0°C to 70°C	1000µV 750µV	TLE2024C TLE2024AC	DW (SOIC, 16) N (PDIP, 14)
-40°C to 85°C	1000µV 750µV	TLE2024I TLE2024AI	DW (SOIC, 16) N (PDIP, 14)
-55°C to 125°C	500µV	TLE2024BM	DW (SOIC, 16)

## 5 Pin Configuration and Functions

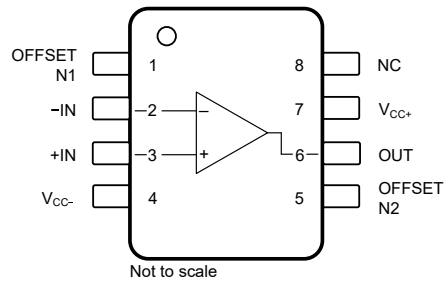

**Figure 5-1. TLE2021: D Package, 8-Pin SOIC, and P Package, 8-Pin PDIP (Top View)**

**Table 5-1. Pin Functions: TLE2021**

NAME	PIN		TYPE	DESCRIPTION
	NO.	D (SOIC), P (PDIP)		
-IN	2		Input	Inverting input
+IN	3		Input	Noninverting input
NC	8		—	No connection
OFFSET N1	1		—	External input offset voltage adjustment
OFFSET N2	2		—	External input offset voltage adjustment
OUT	6		Output	Output
V <sub>CC-</sub>	4		Power	Negative (lowest) power supply
V <sub>CC+</sub>	7		Power	Positive (highest) power supply

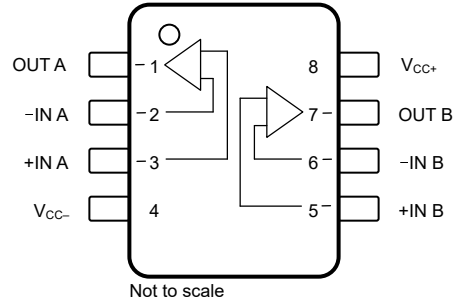

**Figure 5-2. TLE2022: D Package, 8-Pin SOIC and P Package, 8-Pin PDIP (Top View)**

**Table 5-2. Pin Functions: TLE2022**

NAME	PIN		TYPE	DESCRIPTION
	NO.	D (SOIC), P (PDIP)		
-IN A	2		Input	Inverting input channel A
-IN B	6		Input	Inverting input channel B
+IN A	3		Input	Noninverting input channel A
+IN B	5		Input	Noninverting input channel B
NC	—		—	No connection
OUT A	1		Output	Output channel A
OUT B	7		Output	Output channel B
V <sub>CC-</sub>	4		Power	Negative supply
V <sub>CC+</sub>	8		Power	Positive supply

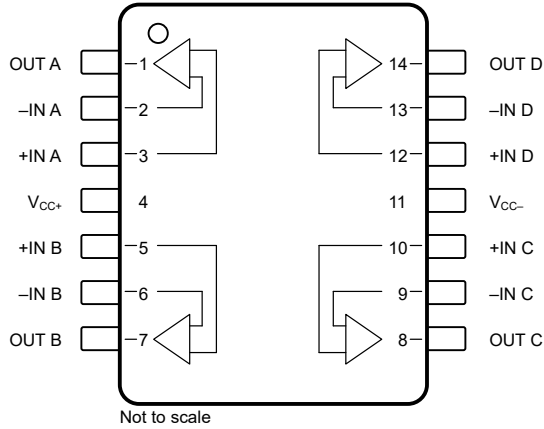

**Figure 5-3. TLE2024: N Package, 14-Pin PDIP (Top View)**

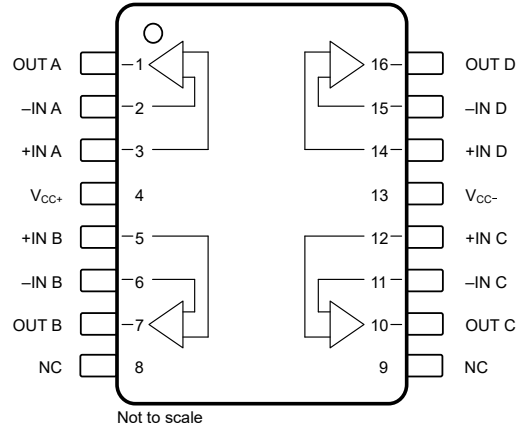

**Figure 5-4. TLE2024: DW Package, 16-Pin (Top View)**

**Table 5-3. Pin Functions: TLE2024**

NAME	PIN NO.		TYPE	DESCRIPTION
	N (PDIP), J (CDIP)	DW (SOIC)		
-IN A	2	2	Input	Inverting input channel A
-IN B	6	6	Input	Inverting input channel B
-IN C	9	11	Input	Inverting input channel C
-IN D	13	15	Input	Inverting input channel D
+IN A	3	3	Input	Noninverting input channel A
+IN B	5	5	Input	Noninverting input channel B
+IN C	10	12	Input	Noninverting input channel C
+IN D	12	14	Input	Noninverting input channel D
NC	—	8, 9	—	No connection
OUT A	1	1	Output	Output channel A
OUT B	7	7	Output	Output channel B
OUT C	8	10	Output	Output channel C
OUT D	14	16	Output	Output channel D
V <sub>CC-</sub>	11	13	Power	Negative supply
V <sub>CC+</sub>	4	4	Power	Positive supply

## 6 Specifications

### 6.1 Absolute Maximum Ratings

over operating free-air temperature range (unless otherwise noted)<sup>(1)</sup>

		MIN	MAX	UNIT
V <sub>CC+</sub>	Supply voltage (positive)		20	V
V <sub>CC-</sub>	Supply voltage (negative)		-20	V
V <sub>ID</sub>	Differential input voltage <sup>(2)</sup>		±0.6	V
V <sub>I</sub>	Input voltage (any input)		±V <sub>CC</sub>	V
I <sub>I</sub>	Input current (each input)		±1	mA
I <sub>O</sub>	Output current (each output)	TLE2021	±20	mA
		TLE2022	±30	
		TLE2024	±40	
Total current into V <sub>CC+</sub>			80	mA
Total current out of V <sub>CC-</sub>			80	mA
Duration of short-circuit current at (or below) 25°C <sup>(4)</sup>			Unlimited	
Lead temperature 1.6mm (1/16in) from case, D and P package (10s)			260	°C
T <sub>A</sub>	Operating free-air temperature	C suffix	0	°C
		I suffix	-40	
		M suffix	-55	
T <sub>stg</sub>	Storage temperature	-65	150	°C

- (1) Operation outside the *Absolute Maximum Ratings* may cause permanent device damage. *Absolute Maximum Ratings* do not imply functional operation of the device at these or any other conditions beyond those listed under *Recommended Operating Conditions*. If used outside the *Recommended Operating Conditions* but within the *Absolute Maximum Ratings*, the device may not be fully functional, and this may affect device reliability, functionality, performance, and shorten the device lifetime.
- (2) Differential voltages are at IN+ with respect to IN-. Excessive current flows if a differential input voltage in excess of approximately ±600mV is applied between the inputs unless some limiting resistance is used.
- (3) Do not short the output to V<sub>CC+</sub>. Limit temperature, supply voltages or both to not exceed maximum dissipation ratings.

### 6.2 Recommended Operating Conditions

over operating free-air temperature range (unless otherwise noted)

		MIN	NOM	MAX	UNIT
V <sub>CC</sub>	Supply voltage, V <sub>CC</sub> = (V <sub>CC+</sub> ) – (V <sub>CC-</sub> )	3		15.5	V
V <sub>IC</sub>	Common mode input voltage	V <sub>CC</sub> = 5V, C suffix	0	3.5	V
		V <sub>CC</sub> = 5V, I and M suffix	0	3.2	
		V <sub>CC±</sub> = ±15V, C suffix	-15	13.5	
		V <sub>CC±</sub> = ±15V, I and M suffix	-15	13.2	
T <sub>A</sub>	Operating free-air temperature	C suffix	0	70	°C
		I suffix	-40	85	
		M suffix	-55	125	

### 6.3 Thermal Information for TLE2021

THERMAL METRIC <sup>(1)</sup>		TLE2021		UNIT
		D (SOIC)	P (PDIP)	
		8 PINS	8 PINS	
R <sub>θJA</sub>	Junction-to-ambient thermal resistance	129.1	84.5	°C/W
R <sub>θJC(top)</sub>	Junction-to-case(top) thermal resistance	68.8	62.9	°C/W
R <sub>θJB</sub>	Junction-to-board thermal resistance	76.8	46.8	°C/W
Ψ <sub>JT</sub>	Junction-to-top characterization parameter	15.7	29.8	°C/W
Ψ <sub>JB</sub>	Junction-to-board characterization parameter	75.8	46.2	°C/W
R <sub>θJC(bot)</sub>	Junction-to-case(bottom) thermal resistance	N/A	N/A	°C/W

(1) For more information about traditional and new thermal metrics, see the [Semiconductor and IC Package Thermal Metrics](#) application report.

### 6.4 Thermal Information for TLE2022

THERMAL METRIC <sup>(1)</sup>		TLE2022		UNIT
		D (SOIC)	P (PDIP)	
		8 PINS	8 PINS	
R <sub>θJA</sub>	Junction-to-ambient thermal resistance	122.4	76.2	°C/W
R <sub>θJC(top)</sub>	Junction-to-case(top) thermal resistance	61.5	55.5	°C/W
R <sub>θJB</sub>	Junction-to-board thermal resistance	70.0	39.7	°C/W
Ψ <sub>JT</sub>	Junction-to-top characterization parameter	11.2	21.7	°C/W
Ψ <sub>JB</sub>	Junction-to-board characterization parameter	69.1	38.9	°C/W
R <sub>θJC(bot)</sub>	Junction-to-case(bottom) thermal resistance	N/A	N/A	°C/W

(1) For more information about traditional and new thermal metrics, see the [Semiconductor and IC Package Thermal Metrics](#) application report.

### 6.5 Thermal Information for TLE2024

THERMAL METRIC <sup>(1)</sup>		TLE2024		UNIT
		DW (SOIC)	N (PDIP)	
		16 PINS	14 PINS	
R <sub>θJA</sub>	Junction-to-ambient thermal resistance	62.7	53.9	°C/W
R <sub>θJC(top)</sub>	Junction-to-case(top) thermal resistance	28.0	30.7	°C/W
R <sub>θJB</sub>	Junction-to-board thermal resistance	31.6	25.2	°C/W
Ψ <sub>JT</sub>	Junction-to-top characterization parameter	4.3	9.0	°C/W
Ψ <sub>JB</sub>	Junction-to-board characterization parameter	31.0	24.7	°C/W
R <sub>θJC(bot)</sub>	Junction-to-case(bottom) thermal resistance	N/A	N/A	°C/W

(1) For more information about traditional and new thermal metrics, see the [Semiconductor and IC Package Thermal Metrics](#) application report.

## 6.6 Electrical Characteristics for TLE2021, $V_{CC} = \pm 15V$

at  $T_A = 25^\circ C$ ,  $V_{CC} = \pm 15V$ , and  $V_{IC} = V_{OUT} = V_{CC} / 2$  (unless otherwise noted)

PARAMETER		TEST CONDITIONS		MIN	TYP	MAX	UNIT
<b>DC SPECS</b>							
$V_{IO}$	Input offset voltage	TLE2021C $R_S = 50\Omega$	$T_A = 0^\circ C$ to $70^\circ C$	$\pm 120$	$\pm 500$		$\mu V$
						$\pm 750$	
		TLE2021AC $R_S = 50\Omega$	$T_A = 0^\circ C$ to $70^\circ C$	$\pm 80$	$\pm 200$		
						$\pm 500$	
		TLE2021I $R_S = 50\Omega$	$T_A = -40^\circ C$ to $+85^\circ C$	$\pm 120$	$\pm 500$		
				$\pm 850$			
		TLE2021AI $R_S = 50\Omega$	$T_A = -40^\circ C$ to $+85^\circ C$	$\pm 80$	$\pm 200$		
						$\pm 500$	
		TLE2021M $R_S = 50\Omega$	$T_A = -55^\circ C$ to $+125^\circ C$	$\pm 120$	$\pm 500$		
						$\pm 1000$	
$dV_{IO}/dT$	Input offset voltage drift	TLE2021C, TLE2021AC $R_S = 50\Omega$ , $T_A = 0^\circ C$ to $70^\circ C$			$\pm 2$		$\mu V/^\circ C$
		TLE2021I, TLE2021AI $R_S = 50\Omega$ , $T_A = -40^\circ C$ to $+85^\circ C$			$\pm 2$		
		TLE2022M $R_S = 50\Omega$ , $T_A = -55^\circ C$ to $+125^\circ C$			$\pm 2$		
$I_{IB}$	Input bias current	TLE2021C, TLE2021AC $R_S = 50\Omega$	$T_A = 0^\circ C$ to $70^\circ C$		25	70	nA
						90	
		TLE2021I, TLE2021AI $R_S = 50\Omega$	$T_A = -40^\circ C$ to $+85^\circ C$		25	70	
						90	
		TLE2021M $R_S = 50\Omega$	$T_A = -55^\circ C$ to $+125^\circ C$		25	70	
						90	
$I_{IO}$	Input offset current	TLE2021C, TLE2021AC $R_S = 50\Omega$	$T_A = 0^\circ C$ to $70^\circ C$		0.2	6	nA
						10	
		TLE2021I, TLE2021AI $R_S = 50\Omega$	$T_A = -40^\circ C$ to $+85^\circ C$		0.2	6	
						10	
		TLE2021M $R_S = 50\Omega$	$T_A = -55^\circ C$ to $+125^\circ C$		0.2	6	
						10	
PSRR	Power-supply rejection ratio	TLE2021C, TLE2021AC $V_{CC\pm} = \pm 2.5$ to $\pm 15V$	$T_A = 0^\circ C$ to $70^\circ C$	105	120		dB
				100			
		TLE2021I, TLE2021AI $V_{CC\pm} = \pm 2.5$ to $\pm 15V$	$T_A = -40^\circ C$ to $+85^\circ C$	105	120		
				100			
		TLE2021M $V_{CC\pm} = \pm 2.5$ to $\pm 15V$	$T_A = -55^\circ C$ to $+125^\circ C$	105	120		
				100			
$A_V$	Large signal voltage gain	TLE2021C, TLE2021AC $R_L = 10k\Omega$ , $-10V \leq V_O \leq 10V$	$T_A = 0^\circ C$ to $70^\circ C$	1	6.5		$V/\mu V$
				1			
		TLE2021I, TLE2021AI $R_L = 10k\Omega$ , $-10V \leq V_O \leq 10V$	$T_A = -40^\circ C$ to $+85^\circ C$	1	6.5		
				0.75			
		TLE2021M $R_L = 10k\Omega$ , $-10V \leq V_O \leq 10V$	$T_A = -55^\circ C$ to $+125^\circ C$	1	6.5		
				0.5			



## 6.6 Electrical Characteristics for TLE2021, $V_{CC} = \pm 15V$ (continued)

at  $T_A = 25^\circ C$ ,  $V_{CC} = \pm 15V$ , and  $V_{IC} = V_{OUT} = V_{CC} / 2$  (unless otherwise noted)

PARAMETER		TEST CONDITIONS	MIN	TYP	MAX	UNIT	
$V_{ICR}$	Common-mode input voltage range	TLE2021C, TLE2021AC To positive rail, $R_S = 50\Omega$		13.5	14	V	
			$T_A = 0^\circ C$ to $70^\circ C$	13.5			
		TLE2021C, TLE2021AC To negative rail, $R_S = 50\Omega$		-15	-15.3		
			$T_A = 0^\circ C$ to $70^\circ C$	-15			
		TLE2021I, TLE2021AI To positive rail, $R_S = 50\Omega$		13.5	14		
			$T_A = -40^\circ C$ to $+85^\circ C$	13.2			
	TLE2021I, TLE2021AI To negative rail, $R_S = 50\Omega$		-15	-15.3			
		$T_A = -40^\circ C$ to $+85^\circ C$	-15				
	TLE2021M To positive rail, $R_S = 50\Omega$		13.5	14			
		$T_A = -55^\circ C$ to $+125^\circ C$	13.2				
	TLE2021M To negative rail, $R_S = 50\Omega$		-15	-15.3			
		$T_A = -55^\circ C$ to $+125^\circ C$	-15				
CMRR	Common-mode rejection ratio	TLE2021C, TLE2021AC $V_{IC} = V_{ICRmin}$ , $R_S = 50\Omega$		100	115	dB	
			$T_A = 0^\circ C$ to $70^\circ C$	96			
		TLE2021I, TLE2021AI $V_{IC} = V_{ICRmin}$ , $R_S = 50\Omega$		100	115		
		$T_A = -40^\circ C$ to $+85^\circ C$	96				
	TLE2021M $V_{IC} = V_{ICRmin}$ , $R_S = 50\Omega$		100	115			
		$T_A = -55^\circ C$ to $+125^\circ C$	96				
$V_O$	Voltage output swing	TLE2021C, TLE2021AC $R_L = 10k\Omega$	Positive	14	14.3	V	
			Positive, $T_A = 0^\circ C$ to $70^\circ C$	13.9			
			Negative		-14.1		-13.7
			Negative, $T_A = 0^\circ C$ to $70^\circ C$		-13.7		
		TLE2021I, TLE2021AI $R_L = 10k\Omega$	Positive	14	14.3		
			Positive, $T_A = -40^\circ C$ to $+85^\circ C$	13.9			
			Negative		-14.1		-13.7
			Negative, $T_A = -40^\circ C$ to $+85^\circ C$		-13.6		
		TLE2021M $R_L = 10k\Omega$	Positive	14	14.3		
			Positive, $T_A = -55^\circ C$ to $+125^\circ C$	13.8			
			Negative		-14.1		-13.7
			Negative, $T_A = -55^\circ C$ to $+125^\circ C$		-13.6		
$I_{CC}$	Supply current	No load TLE2021C, TLE2021AC		240	350	$\mu A$	
				$T_A = 0^\circ C$ to $70^\circ C$			350
		No load TLE2021I, TLE2021AI		240	350		
				$T_A = -40^\circ C$ to $+85^\circ C$			350
		No load TLE2021M		200	300		
				$T_A = -55^\circ C$ to $+125^\circ C$			300

## 6.6 Electrical Characteristics for TLE2021, $V_{CC} = \pm 15V$ (continued)

at  $T_A = 25^\circ C$ ,  $V_{CC} = \pm 15V$ , and  $V_{IC} = V_{OUT} = V_{CC} / 2$  (unless otherwise noted)

PARAMETER		TEST CONDITIONS		MIN	TYP	MAX	UNIT
<b>AC SPECS</b>							
SR	Slew rate	$V_O = \pm 10V$ , $G = 1$			0.65		V/ $\mu s$
$e_N$	Input voltage noise density	f = 10Hz	TLE2021xC, TLE2021xI		19	50	nV/ $\sqrt{Hz}$
			TLE2021M		19		
		f = 1kHz	TLE2021xC, TLE2021xI		15	30	
			TLE2021M		15		
Input voltage noise	f = 0.1Hz to 1Hz			0.16		$\mu V_{PP}$	
	f = 0.1Hz to 10Hz			0.47			
	Input current noise				0.09		pA/ $\sqrt{Hz}$
GBW	Gain bandwidth	G = 1			2		MHz
$\phi_M$	Phase margin				46°		

## 6.7 Electrical Characteristics for TLE2021, $V_{CC} = 5V$

at  $T_A = 25^\circ C$ ,  $V_{CC} = 5V$ , and  $V_{IC} = V_{OUT} = V_{CC} / 2$  (unless otherwise noted)

PARAMETER		TEST CONDITIONS		MIN	TYP	MAX	UNIT
<b>DC SPECS</b>							
$V_{IO}$	Input offset voltage	TLE2021C $R_S = 50\Omega$	$T_A = 0^\circ C$ to $70^\circ C$		$\pm 120$	$\pm 600$	$\mu V$
						$\pm 850$	
		TLE2021AC $R_S = 50\Omega$	$T_A = 0^\circ C$ to $70^\circ C$		$\pm 100$	$\pm 300$	
						$\pm 600$	
		TLE2021I $R_S = 50\Omega$	$T_A = -40^\circ C$ to $+85^\circ C$		$\pm 120$	$\pm 600$	
				$\pm 950$			
		TLE2021AI $R_S = 50\Omega$	$T_A = -40^\circ C$ to $+85^\circ C$		$\pm 100$	$\pm 300$	
						$\pm 600$	
		TLE2021M $R_S = 50\Omega$	$T_A = -55^\circ C$ to $+125^\circ C$		$\pm 120$	$\pm 600$	
						$\pm 1100$	
$dV_{IO}/dT$	Input offset voltage drift	TLE2021C, TLE2021AC $T_A = 0^\circ C$ to $70^\circ C$			$\pm 2$		$\mu V/^\circ C$
		TLE2021I, TLE2021AI $T_A = -40^\circ C$ to $+85^\circ C$			$\pm 2$		
		TLE2021M $T_A = -55^\circ C$ to $+125^\circ C$			$\pm 2$		
$I_{IB}$	Input bias current	TLE2021C, TLE2021AC $R_S = 50\Omega$	$T_A = 0^\circ C$ to $70^\circ C$		25	70	nA
						90	
		TLE2021I, TLE2021AI $R_S = 50\Omega$	$T_A = -40^\circ C$ to $+85^\circ C$		25	70	
						90	
		TLE2021M $R_S = 50\Omega$	$T_A = -55^\circ C$ to $+125^\circ C$		25	70	
						90	
$I_{IO}$	Input offset current	TLE2021C, TLE2021AC $R_S = 50\Omega$	$T_A = 0^\circ C$ to $70^\circ C$		0.2	6	nA
						10	
		TLE2021I, TLE2021AI $R_S = 50\Omega$	$T_A = -40^\circ C$ to $+85^\circ C$		0.2	6	
						10	
		TLE2021M $R_S = 50\Omega$	$T_A = -55^\circ C$ to $+125^\circ C$		0.2	6	
						10	
PSRR	Power-supply rejection ratio	TLE2021C, TLE2021AC $V_{CC} = 5V$ to $30V$	$T_A = 0^\circ C$ to $70^\circ C$	105	120		dB
				100			
		TLE2021I, TLE2021AI $V_{CC} = 5V$ to $30V$	$T_A = -40^\circ C$ to $+85^\circ C$	105	120		
				100			
		TLE2021M $V_{CC} = 5V$ to $30V$	$T_A = -55^\circ C$ to $+125^\circ C$	105	120		
				100			
$A_V$	Large signal voltage gain	TLE2021C, TLE2021AC $R_L = 10k\Omega$ , $1.4V \leq V_O \leq 4V$	$T_A = 0^\circ C$ to $70^\circ C$	0.3	1.5		$V/\mu V$
				0.3			
		TLE2021I, TLE2021AI $R_L = 10k\Omega$ , $1.4V \leq V_O \leq 4V$	$T_A = -40^\circ C$ to $+85^\circ C$	0.3	1.5		
				0.25			
		TLE2021M $R_L = 10k\Omega$ , $1.4V \leq V_O \leq 4V$	$T_A = -55^\circ C$ to $+125^\circ C$	0.3	1.5		
				0.1			

## 6.7 Electrical Characteristics for TLE2021, $V_{CC} = 5V$ (continued)

at  $T_A = 25^\circ C$ ,  $V_{CC} = 5V$ , and  $V_{IC} = V_{OUT} = V_{CC} / 2$  (unless otherwise noted)

PARAMETER		TEST CONDITIONS	MIN	TYP	MAX	UNIT	
$V_{ICR}$	Common-mode input voltage range	TLE2021C, TLE2021AC To positive rail, $R_S = 50\Omega$		3.5	4	V	
			$T_A = 0^\circ C$ to $70^\circ C$	3.5			
		TLE2021C, TLE2021AC To negative rail, $R_S = 50\Omega$		0	-0.3		
			$T_A = 0^\circ C$ to $70^\circ C$	0			
		TLE2021I, TLE2021AI To positive rail, $R_S = 50\Omega$		3.5	4		
			$T_A = -40^\circ C$ to $+85^\circ C$	3.2			
			0	-0.3			
		$T_A = -40^\circ C$ to $+85^\circ C$	0				
		TLE2021M To positive rail, $R_S = 50\Omega$		3.5	4		
			$T_A = -55^\circ C$ to $+125^\circ C$	3.2			
		TLE2021M To negative rail, $R_S = 50\Omega$		0	-0.3		
			$T_A = -55^\circ C$ to $+125^\circ C$	0			
CMRR	Common-mode rejection ratio	TLE2021C, TLE2021AC $V_{IC} = V_{ICRmin}$ , $R_S = 50\Omega$		85	110	dB	
			$T_A = 0^\circ C$ to $70^\circ C$	80			
		TLE2021I, TLE2021AI $V_{IC} = V_{ICRmin}$ , $R_S = 50\Omega$		85	110		
			$T_A = -40^\circ C$ to $+85^\circ C$	80			
		TLE2021M $V_{IC} = V_{ICRmin}$ , $R_S = 50\Omega$		85	110		
			$T_A = -55^\circ C$ to $+125^\circ C$	80			
$V_O$	Voltage output swing	TLE2021C, TLE2021AC $R_L = 10k\Omega$	Positive	4	4.3	V	
			Positive, $T_A = 0^\circ C$ to $70^\circ C$	3.9			
			Negative		0.7		0.8
			Negative, $T_A = 0^\circ C$ to $70^\circ C$				0.85
		TLE2021I, TLE2021AI $R_L = 10k\Omega$	Positive	4	4.3		
			Positive, $T_A = -40^\circ C$ to $+85^\circ C$	3.9			
			Negative		0.7		0.8
			Negative, $T_A = -40^\circ C$ to $+85^\circ C$				0.9
		TLE2021M $R_L = 10k\Omega$	Positive	4	4.3		
			Positive, $T_A = -55^\circ C$ to $+125^\circ C$	3.8			
			Negative		0.7		0.8
			Negative, $T_A = -55^\circ C$ to $+125^\circ C$				0.95
$I_{CC}$	Supply current	No load TLE2021C, TLE2021AC		200	300	$\mu A$	
				$T_A = 0^\circ C$ to $70^\circ C$			300
		No load TLE2021I, TLE2021AI		200	300		
				$T_A = -40^\circ C$ to $+85^\circ C$			300
		No load TLE2021M		170	230		
				$T_A = -55^\circ C$ to $+125^\circ C$			230

## 6.7 Electrical Characteristics for TLE2021, $V_{CC} = 5V$ (continued)

at  $T_A = 25^\circ C$ ,  $V_{CC} = 5V$ , and  $V_{IC} = V_{OUT} = V_{CC} / 2$  (unless otherwise noted)

PARAMETER		TEST CONDITIONS		MIN	TYP	MAX	UNIT
<b>AC SPECS</b>							
SR	Slew rate	$V_O = 1V$ to $3V$ , $G = 1$			0.5		V/ $\mu$ s
$e_N$	Input voltage noise density	f = 10Hz	TLE2021xC, TLE2021xI		21	50	nV/ $\sqrt{Hz}$
			TLE2021xM		21		
		f = 1kHz	TLE2021xC, TLE2021xI		17	30	
			TLE2021xM		17		
	Input voltage noise	f = 0.1Hz to 1Hz			0.16		$\mu$ V
		f = 0.1Hz to 10Hz			0.47		
	Input current noise				0.09		pA/ $\sqrt{Hz}$
GBW	Gain bandwidth	G = 1			1.2		MHz
$\phi_M$	Phase margin				42°		

## 6.8 Electrical Characteristics for TLE2022, $V_{CC} = \pm 15V$

at  $T_A = 25^\circ C$ ,  $V_{CC} = \pm 15V$ , and  $V_{IC} = V_{OUT} = V_{CC} / 2$  (unless otherwise noted)

PARAMETER		TEST CONDITIONS		MIN	TYP	MAX	UNIT
<b>DC SPECS</b>							
$V_{IO}$	Input offset voltage	TLE2022C $R_S = 50\Omega$	$T_A = 0^\circ C$ to $70^\circ C$		$\pm 150$	$\pm 500$	$\mu V$
						$\pm 700$	
		TLE2022AC $R_S = 50\Omega$	$T_A = 0^\circ C$ to $70^\circ C$		$\pm 120$	$\pm 300$	
						$\pm 450$	
		TLE2022I $R_S = 50\Omega$	$T_A = -40^\circ C$ to $+85^\circ C$		$\pm 150$	$\pm 500$	
					$\pm 120$	$\pm 300$	
						$\pm 450$	
		TLE2022AI $R_S = 50\Omega$	$T_A = -40^\circ C$ to $+85^\circ C$		$\pm 150$	$\pm 500$	
						$\pm 700$	
		TLE2022M $R_S = 50\Omega$	$T_A = -55^\circ C$ to $+125^\circ C$		$\pm 120$	$\pm 300$	
						$\pm 450$	
		TLE2022AM $R_S = 50\Omega$	$T_A = -55^\circ C$ to $+125^\circ C$				
$dV_{IO}/dT$	Input offset voltage drift	TLE2022C, TLE2022AC $R_S = 50\Omega$ , $T_A = 0^\circ C$ to $70^\circ C$			$\pm 2$		$\mu V/^\circ C$
		TLE2022I, TLE2022AI $R_S = 50\Omega$ , $T_A = -40^\circ C$ to $+85^\circ C$			$\pm 2$		
		TLE2022M, TLE2022AM $R_S = 50\Omega$ , $T_A = -55^\circ C$ to $+125^\circ C$			$\pm 2$		
$I_{IB}$	Input bias current	TLE2022C $R_S = 50\Omega$	$T_A = 0^\circ C$ to $70^\circ C$		35	70	nA
						90	
		TLE2022AC $R_S = 50\Omega$	$T_A = 0^\circ C$ to $70^\circ C$		33	70	
						90	
		TLE2022I $R_S = 50\Omega$	$T_A = -40^\circ C$ to $+85^\circ C$		35	70	
					33	70	
						90	
		TLE2022AI $R_S = 50\Omega$	$T_A = -40^\circ C$ to $+85^\circ C$		35	70	
						90	
		TLE2022M $R_S = 50\Omega$	$T_A = -55^\circ C$ to $+125^\circ C$		35	70	
						90	
		TLE2022AM $R_S = 50\Omega$	$T_A = -55^\circ C$ to $+125^\circ C$		33	70	
						90	
$I_{IO}$	Input offset current	TLE2022C $R_S = 50\Omega$	$T_A = 0^\circ C$ to $70^\circ C$		0.5	6	nA
						10	
		TLE2022AC $R_S = 50\Omega$	$T_A = 0^\circ C$ to $70^\circ C$		0.4	6	
						10	
		TLE2022I $R_S = 50\Omega$	$T_A = -40^\circ C$ to $+85^\circ C$		0.5	6	
					0.4	6	
						10	
		TLE2022AI $R_S = 50\Omega$	$T_A = -40^\circ C$ to $+85^\circ C$		0.4	6	
						10	
		TLE2022M $R_S = 50\Omega$	$T_A = -55^\circ C$ to $+125^\circ C$		0.5	6	
						10	
		TLE2022AM $R_S = 50\Omega$	$T_A = -55^\circ C$ to $+125^\circ C$		0.4	6	
						10	

## 6.8 Electrical Characteristics for TLE2022, $V_{CC} = \pm 15V$ (continued)

at  $T_A = 25^\circ C$ ,  $V_{CC} = \pm 15V$ , and  $V_{IC} = V_{OUT} = V_{CC} / 2$  (unless otherwise noted)

PARAMETER		TEST CONDITIONS		MIN	TYP	MAX	UNIT
PSRR	Power supply rejection ratio	TLE2022C $V_{CC\pm} = \pm 2.5V$ to $\pm 15V$	$T_A = 0^\circ C$ to $70^\circ C$	100	115		dB
				95			
		TLE2022AC $V_{CC\pm} = \pm 2.5V$ to $\pm 15V$	$T_A = 0^\circ C$ to $70^\circ C$	103	118		
				98			
		TLE2022I $V_{CC\pm} = \pm 2.5V$ to $\pm 15V$	$T_A = -40^\circ C$ to $+85^\circ C$	100	115		
				95			
TLE2022AI $V_{CC\pm} = \pm 2.5V$ to $\pm 15V$	$T_A = -40^\circ C$ to $+85^\circ C$	103	118				
		98					
$A_v$	Large signal voltage gain	TLE2022IC, $R_L = 10k\Omega$ , $V_O = \pm 10V$	$T_A = 0^\circ C$ to $70^\circ C$	0.8	4		V/ $\mu V$
				0.8			
		TLE2022AC $R_L = 10k\Omega$ , $V_O = \pm 10V$	$T_A = 0^\circ C$ to $70^\circ C$	1	7		
				1			
		TLE2022I $R_L = 10k\Omega$ , $V_O = \pm 10V$	$T_A = -40^\circ C$ to $+85^\circ C$	0.8	4		
				0.8			
TLE2022AI, $R_L = 10k\Omega$ , $V_O = \pm 10V$	$T_A = -40^\circ C$ to $+85^\circ C$	1	7				
		1					
$V_{IC}$	Common-mode voltage	To positive rail, $R_S = 50\Omega$ TLE2022C, TLE2022AC	$T_A = 0^\circ C$ to $70^\circ C$	13.5	14		V
				13.2			
		To negative rail, $R_S = 50\Omega$ TLE2022C, TLE2022AC	$T_A = 0^\circ C$ to $70^\circ C$	-15	-15.3		
				-15			
		To positive rail, $R_S = 50\Omega$ TLE2022C, TLE2022AC	$T_A = -40^\circ C$ to $+85^\circ C$	13.5	14		
				13.2			
To negative rail, $R_S = 50\Omega$ TLE2022C, TLE2022AC	$T_A = -40^\circ C$ to $+85^\circ C$	-15	-15.3				
		-15					
$V_{IC}$	Common-mode voltage	To positive rail, $R_S = 50\Omega$ TLE2022C, TLE2022AC	$T_A = -55^\circ C$ to $+125^\circ C$	13.5	14		V
				13.2			
		To negative rail, $R_S = 50\Omega$ TLE2022C, TLE2022AC	$T_A = -55^\circ C$ to $+125^\circ C$	-15	-15.3		
				-15			
		To positive rail, $R_S = 50\Omega$ TLE2022M, TLE2022AM	$T_A = -55^\circ C$ to $+125^\circ C$	13.5	14		
				13.2			
To negative rail, $R_S = 50\Omega$ TLE2022M, TLE2022AM	$T_A = -55^\circ C$ to $+125^\circ C$	-15	-15.3				
		-15					

## 6.8 Electrical Characteristics for TLE2022, $V_{CC} = \pm 15V$ (continued)

at  $T_A = 25^\circ C$ ,  $V_{CC} = \pm 15V$ , and  $V_{IC} = V_{OUT} = V_{CC} / 2$  (unless otherwise noted)

PARAMETER		TEST CONDITIONS		MIN	TYP	MAX	UNIT
CMRR	Common-mode rejection ratio	TLE2022C $V_{IC} = V_{ICRmin}$ , $R_S = 50\Omega$		95	106		dB
			$T_A = 0^\circ C$ to $70^\circ C$	91			
		TLE2022AC $V_{IC} = V_{ICRmin}$ , $R_S = 50\Omega$		97	109		
			$T_A = 0^\circ C$ to $70^\circ C$	93			
		TLE2022BC $V_{IC} = V_{ICRmin}$ , $R_S = 50\Omega$		100	112		
			$T_A = 0^\circ C$ to $70^\circ C$	96			
		TLE2022I $V_{IC} = V_{ICRmin}$ , $R_S = 50\Omega$		95	106		
			$T_A = -40^\circ C$ to $+85^\circ C$	91			
		TLE2022AI $V_{IC} = V_{ICRmin}$ , $R_S = 50\Omega$		97	109		
			$T_A = -40^\circ C$ to $+85^\circ C$	93			
TLE2022BI $V_{IC} = V_{ICRmin}$ , $R_S = 50\Omega$		100	112				
	$T_A = -40^\circ C$ to $+85^\circ C$	96					
TLE2022M $V_{IC} = V_{ICRmin}$ , $R_S = 50\Omega$		95	106				
	$T_A = -55^\circ C$ to $+125^\circ C$	91					
TLE2022AM $V_{IC} = V_{ICRmin}$ , $R_S = 50\Omega$		97	109				
	$T_A = -55^\circ C$ to $+125^\circ C$	93					
TLE2022BM $V_{IC} = V_{ICRmin}$ , $R_S = 50\Omega$		100	112				
	$T_A = -55^\circ C$ to $+125^\circ C$	96					
$V_O$	Voltage output swing	TLE2022C, TLE2022AC $R_L = 10k\Omega$	Positive	14	14.3		V
			Positive $T_A = 0^\circ C$ to $70^\circ C$	13.9			
			Negative		-14.1	-13.7	
			Negative $T_A = 0^\circ C$ to $70^\circ C$			-13.7	
		TLE2022I, TLE2022AI $R_L = 10k\Omega$	Positive	14	14.3		
			Positive $T_A = -40^\circ C$ to $+85^\circ C$	13.9			
			Negative		-14.1	-13.7	
			Negative $T_A = -40^\circ C$ to $+85^\circ C$			-13.7	
		TLE2022M, TLE2022AM $R_L = 10k\Omega$	Positive	14	14.3		
			Positive $T_A = -55^\circ C$ to $+125^\circ C$	13.9			
			Negative		-14.1	-13.7	
			Negative $T_A = -55^\circ C$ to $+125^\circ C$			-13.6	
$I_{CC}$	Supply current	TLE2022C, TLE2022AC No load		550	700		$\mu A$
			$T_A = 0^\circ C$ to $70^\circ C$		700		
		TLE2022I, TLE2022AI No load		550	700		
			$T_A = -40^\circ C$ to $+85^\circ C$		700		
		TLE2022M, TLE2022AM No load		550	700		
			$T_A = -55^\circ C$ to $+125^\circ C$		700		



## 6.8 Electrical Characteristics for TLE2022, $V_{CC} = \pm 15V$ (continued)

at  $T_A = 25^\circ C$ ,  $V_{CC} = \pm 15V$ , and  $V_{IC} = V_{OUT} = V_{CC} / 2$  (unless otherwise noted)

PARAMETER		TEST CONDITIONS		MIN	TYP	MAX	UNIT
<b>AC SPECS</b>							
SR	Slew rate	$V_O = \pm 10V$ , $G = 1$			0.65		V/ $\mu s$
$e_N$	Input voltage noise density	f = 10Hz	TLE2022xC, TLE2022xI		19		nV/ $\sqrt{Hz}$
			TLE2022xM		19		
		f = 1kHz	TLE2022xC, TLE2022xI		15		
			TLE2022xM		15		
Input voltage noise	f = 0.1Hz to 1Hz			0.16		$\mu V$	
	f = 0.1Hz to 10Hz			0.47			
	Input current noise density				0.1		pA/ $\sqrt{Hz}$
GBW	Gain bandwidth	G = 1			2.8		MHz
$\phi_M$	Phase margin				52°		

## 6.9 Electrical Characteristics for TLE2022, $V_{CC} = 5V$

at  $T_A = 25^\circ C$ ,  $V_{CC} = 5V$ , and  $V_{IC} = V_{OUT} = V_{CC} / 2$  (unless otherwise noted)

PARAMETER		TEST CONDITIONS		MIN	TYP	MAX	UNIT
<b>DC SPECS</b>							
$V_{IO}$	Input offset voltage	TLE2022C $R_S = 50\Omega$	$T_A = 0^\circ C$ to $70^\circ C$			$\pm 600$	$\mu V$
						$\pm 800$	
		TLE2022AC $R_S = 50\Omega$	$T_A = 0^\circ C$ to $70^\circ C$			$\pm 400$	
						$\pm 550$	
		TLE2022I $R_S = 50\Omega$	$T_A = -40^\circ C$ to $+85^\circ C$			$\pm 600$	
						$\pm 800$	
		TLE2022AI $R_S = 50\Omega$	$T_A = -40^\circ C$ to $+85^\circ C$			$\pm 400$	
				$\pm 550$			
		TLE2022M $R_S = 50\Omega$	$T_A = -55^\circ C$ to $+125^\circ C$			$\pm 600$	
						$\pm 800$	
		TLE2022AM $R_S = 50\Omega$	$T_A = -55^\circ C$ to $+125^\circ C$			$\pm 400$	
						$\pm 550$	
$dV_{IO}/dT$	Input offset voltage drift	TLE2022C, TLE2022AC $T_A = 0^\circ C$ to $70^\circ C$				$\pm 2$	$\mu V/^\circ C$
		TLE2022I, TLE2022AI $T_A = -40^\circ C$ to $+85^\circ C$				$\pm 2$	
		TLE2022M, TLE2022AM $T_A = -55^\circ C$ to $+125^\circ C$				$\pm 2$	
$I_{IB}$	Input bias current	TLE2022C $R_S = 50\Omega$	$T_A = 0^\circ C$ to $70^\circ C$		35	70	nA
						90	
		TLE2022AC $R_S = 50\Omega$	$T_A = 0^\circ C$ to $70^\circ C$		33	70	
						90	
		TLE2022I $R_S = 50\Omega$	$T_A = -40^\circ C$ to $+85^\circ C$		35	70	
						90	
		TLE2022AI $R_S = 50\Omega$	$T_A = -40^\circ C$ to $+85^\circ C$		33	70	
				90			
		TLE2022M $R_S = 50\Omega$	$T_A = -55^\circ C$ to $+125^\circ C$		35	70	
						90	
		TLE2022AM $R_S = 50\Omega$	$T_A = -55^\circ C$ to $+125^\circ C$		33	70	
						90	
$I_{IO}$	Input offset current	TLE2022C $R_S = 50\Omega$	$T_A = 0^\circ C$ to $70^\circ C$		0.5	6	nA
						10	
		TLE2022AC $R_S = 50\Omega$	$T_A = 0^\circ C$ to $70^\circ C$		0.4	6	
						10	
		TLE2022I $R_S = 50\Omega$	$T_A = -40^\circ C$ to $+85^\circ C$		0.5	6	
						10	
		TLE2022AI $R_S = 50\Omega$	$T_A = -40^\circ C$ to $+85^\circ C$		0.4	6	
				10			
		TLE2022M $R_S = 50\Omega$	$T_A = -55^\circ C$ to $+125^\circ C$		0.5	6	
						10	
		TLE2022AM $R_S = 50\Omega$	$T_A = -55^\circ C$ to $+125^\circ C$		0.4	6	
						10	

### 6.9 Electrical Characteristics for TLE2022, $V_{CC} = 5V$ (continued)

at  $T_A = 25^\circ C$ ,  $V_{CC} = 5V$ , and  $V_{IC} = V_{OUT} = V_{CC} / 2$  (unless otherwise noted)

PARAMETER		TEST CONDITIONS		MIN	TYP	MAX	UNIT
PSRR	Power-supply rejection ratio	TLE2022C $V_{CC} = 5V$ to $30V$	$T_A = 0^\circ C$ to $70^\circ C$	100	115		dB
				95			
		TLE2022AC $V_{CC} = 5V$ to $30V$	$T_A = 0^\circ C$ to $70^\circ C$	103	118		
				98			
		TLE2022I $V_{CC} = 5V$ to $30V$	$T_A = -40^\circ C$ to $+85^\circ C$	100	115		
				95			
TLE2022AI $V_{CC} = 5V$ to $30V$	$T_A = -40^\circ C$ to $+85^\circ C$	103	118				
		98					
$A_v$	Large signal voltage gain	TLE2022C, $R_L = 10k\Omega$ $1.4V \leq V_O \leq 4V$	$T_A = 0^\circ C$ to $70^\circ C$	0.3	1.5		V/ $\mu V$
				0.3			
		TLE2022AC, $R_L = 10k\Omega$ $1.4V \leq V_O \leq 4V$	$T_A = 0^\circ C$ to $70^\circ C$	0.4	1.5		
				0.4			
		TLE2022I, $R_L = 10k\Omega$ $1.4V \leq V_O \leq 4V$	$T_A = -40^\circ C$ to $+85^\circ C$	0.3	1.5		
				0.2			
TLE2022AI, $R_L = 10k\Omega$ $1.4V \leq V_O \leq 4V$	$T_A = -40^\circ C$ to $+85^\circ C$	0.4	1.5				
		0.2					
$V_{ICR}$	Common-mode input voltage range	TLE2022C, TLE2022AC To positive rail, $R_S = 50\Omega$	$T_A = 0^\circ C$ to $70^\circ C$	3.5	4		V
				3.5			
		TLE2022C, TLE2022AC To negative rail, $R_S = 50\Omega$	$T_A = 0^\circ C$ to $70^\circ C$	0	-0.3		
				0			
		TLE2022I, TLE2022AI To positive rail, $R_S = 50\Omega$	$T_A = -40^\circ C$ to $+85^\circ C$	3.5	4		
				3.2			
TLE2022I, TLE2022AI To negative rail, $R_S = 50\Omega$	$T_A = -40^\circ C$ to $+85^\circ C$	0	-0.3				
		0					
CMRR	Common-mode rejection ratio	TLE2021C $V_{IC} = V_{ICRmin}$ , $R_S = 50\Omega$	$T_A = 0^\circ C$ to $70^\circ C$	85	100		dB
				80			
		TLE2021AC $V_{IC} = V_{ICRmin}$ , $R_S = 50\Omega$	$T_A = 0^\circ C$ to $70^\circ C$	87	102		
				82			
		TLE2022I $V_{IC} = V_{ICRmin}$ , $R_S = 50\Omega$	$T_A = -40^\circ C$ to $+85^\circ C$	85	100		
				80			
TLE202AI $V_{IC} = V_{ICRmin}$ , $R_S = 50\Omega$	$T_A = -40^\circ C$ to $+85^\circ C$	87	102				
		82					
TLE2022M $V_{IC} = V_{ICRmin}$ , $R_S = 50\Omega$	$T_A = -55^\circ C$ to $+125^\circ C$	85	100				
		80					
TLE2022AM $V_{IC} = V_{ICRmin}$ , $R_S = 50\Omega$	$T_A = -55^\circ C$ to $+125^\circ C$	87	102				
		82					

## 6.9 Electrical Characteristics for TLE2022, $V_{CC} = 5V$ (continued)

at  $T_A = 25^\circ\text{C}$ ,  $V_{CC} = 5V$ , and  $V_{IC} = V_{OUT} = V_{CC} / 2$  (unless otherwise noted)

PARAMETER		TEST CONDITIONS		MIN	TYP	MAX	UNIT
$V_O$	Voltage output swing	TLE2022C, TLE2022AC $R_L = 10k\Omega$	Positive	4	4.3		V
			Positive, $T_A = 0^\circ\text{C}$ to $70^\circ\text{C}$	3.9			
			Negative		0.7	0.8	
			Negative, $T_A = 0^\circ\text{C}$ to $70^\circ\text{C}$			0.85	
		TLE2022I, TLE2022AI $R_L = 10k\Omega$	Positive	4	4.3		
			Positive, $T_A = -40^\circ\text{C}$ to $+85^\circ\text{C}$	3.9			
			Negative		0.7	0.8	
			Negative, $T_A = -40^\circ\text{C}$ to $+85^\circ\text{C}$			0.9	
		TLE2022M, TLE2022AM $R_L = 10k\Omega$	Positive	4	4.3		
			Positive, $T_A = -55^\circ\text{C}$ to $+125^\circ\text{C}$	3.8			
			Negative		0.7	0.8	
			Negative, $T_A = -55^\circ\text{C}$ to $+125^\circ\text{C}$			0.95	
$I_{CC}$	Supply current	TLE2022C, TLE2022AC			450	600	$\mu\text{A}$
			$T_A = 0^\circ\text{C}$ to $70^\circ\text{C}$			600	
		TLE2022I, TLE2022AI			450	600	
			$T_A = -40^\circ\text{C}$ to $+85^\circ\text{C}$			600	
		TLE2022M, TLE2022AM			450	600	
			$T_A = -55^\circ\text{C}$ to $+125^\circ\text{C}$			600	
<b>AC SPECS</b>							
SR	Slew rate	$V_O = \pm 10V$ , $G = 1$			0.65		$\text{V}/\mu\text{s}$
$e_N$	Input voltage noise density	f = 10Hz	TLE2022xC, TLE2022xI		21		$\text{nV}/\sqrt{\text{Hz}}$
			TLE2022xM		21		
		f = 1kHz	TLE2022xC, TLE2022xI		17		
			TLE2022xM		17		
	Input voltage noise	f = 0.1Hz to 1Hz		0.16		$\mu\text{V}$	
		f = 0.1Hz to 10Hz		0.47			
	Input current noise density				0.1		$\text{pA}/\sqrt{\text{Hz}}$
GBW	Gain bandwidth	G = 1			1.7		MHz
$\Theta_M$	Phase margin				47°		

## 6.10 Electrical Characteristics for TLE2024, $V_{CC} = \pm 15V$

at  $T_A = 25^\circ C$ ,  $V_{CC} = \pm 15V$ , and  $V_{IC} = V_{OUT} = V_{CC} / 2$  (unless otherwise noted)

PARAMETER		TEST CONDITIONS		MIN	TYP	MAX	UNIT
<b>DC SPECS</b>							
$V_{IO}$	Input offset voltage	TLE2024C $R_S = 50\Omega$	$T_A = 0^\circ C$ to $70^\circ C$			$\pm 1000$	$\mu V$
						$\pm 1200$	
		TLE2024AC $R_S = 50\Omega$	$T_A = 0^\circ C$ to $70^\circ C$			$\pm 750$	
						$\pm 950$	
		TLE2024I $R_S = 50\Omega$	$T_A = -40^\circ C$ to $+85^\circ C$			$\pm 1000$	
						$\pm 1200$	
	TLE2024AAI $R_S = 50\Omega$	$T_A = -40^\circ C$ to $+85^\circ C$			$\pm 750$		
					$\pm 950$		
	TLE2024BM $R_S = 50\Omega$	$T_A = -55^\circ C$ to $+125^\circ C$			$\pm 500$		
					$\pm 700$		
$dV_{IO}/dT$	Input offset voltage drift	TLE2024C, TLE2024AC $R_S = 50\Omega$ , $T_A = 0^\circ C$ to $70^\circ C$				$\pm 2$	$\mu V/^\circ C$
		TLE2024I, TLE2024AI $R_S = 50\Omega$ , $T_A = -40^\circ C$ to $+85^\circ C$				$\pm 2$	
		TLE2024BM $R_S = 50\Omega$ , $T_A = -55^\circ C$ to $+125^\circ C$				$\pm 2$	
$I_{IB}$	Input bias current	TLE2024C $R_S = 50\Omega$	$T_A = 0^\circ C$ to $70^\circ C$		50	70	nA
						90	
		TLE2024AC $R_S = 50\Omega$	$T_A = 0^\circ C$ to $70^\circ C$		45	70	
						90	
		TLE2024I $R_S = 50\Omega$	$T_A = -40^\circ C$ to $+85^\circ C$		50	70	
						90	
	TLE2024AI $R_S = 50\Omega$	$T_A = -40^\circ C$ to $+85^\circ C$		45	70		
					90		
	TLE2024BM $R_S = 50\Omega$	$T_A = -55^\circ C$ to $+125^\circ C$		40	70		
					90		
$I_{IO}$	Input offset current	TLE2024C $R_S = 50\Omega$	$T_A = 0^\circ C$ to $70^\circ C$		0.6	6	nA
						10	
		TLE2024AC $R_S = 50\Omega$	$T_A = 0^\circ C$ to $70^\circ C$		0.5	6	
						10	
		TLE2024I $R_S = 50\Omega$	$T_A = -40^\circ C$ to $+85^\circ C$		0.6	6	
						10	
	TLE2024AI $R_S = 50\Omega$	$T_A = -40^\circ C$ to $+85^\circ C$		0.5	6		
					10		
	TLE2024BM $R_S = 50\Omega$	$T_A = -55^\circ C$ to $+125^\circ C$		0.4	6		
					10		
PSRR	Power-supply rejection ratio	TLE2024C $V_{CC\pm} = \pm 2.5V$ to $\pm 15V$	$T_A = 0^\circ C$ to $70^\circ C$	98	112		dB
				93			
		TLE2024AC $V_{CC\pm} = \pm 2.5V$ to $\pm 15V$	$T_A = 0^\circ C$ to $70^\circ C$	100	115		
				95			
		TLE2024I $V_{CC\pm} = \pm 2.5V$ to $\pm 15V$	$T_A = -40^\circ C$ to $+85^\circ C$	98	112		
				93			
	TLE2024AI $V_{CC\pm} = \pm 2.5V$ to $\pm 15V$	$T_A = -40^\circ C$ to $+85^\circ C$	100	115			
				95			
	TLE2024BM $V_{CC\pm} = \pm 2.5V$ to $\pm 15V$	$T_A = -55^\circ C$ to $+125^\circ C$	103	108			
				98			

## 6.10 Electrical Characteristics for TLE2024, $V_{CC} = \pm 15V$ (continued)

at  $T_A = 25^\circ C$ ,  $V_{CC} = \pm 15V$ , and  $V_{IC} = V_{OUT} = V_{CC} / 2$  (unless otherwise noted)

PARAMETER		TEST CONDITIONS		MIN	TYP	MAX	UNIT
$A_v$	Large signal voltage gain	TLE2024C $R_L = 10k\Omega$ , $V_O = \pm 10V$	$T_A = 0^\circ C$ to $70^\circ C$	0.4	2		$V/\mu V$
				0.4			
		TLE2024AC $R_L = 10k\Omega$ , $V_O = \pm 10V$	$T_A = 0^\circ C$ to $70^\circ C$	0.8	4		
				0.8			
		TLE2024I $R_L = 10k\Omega$ , $V_O = \pm 10V$	$T_A = -40^\circ C$ to $+85^\circ C$	0.4	2		
				0.4			
TLE2024AI $R_L = 10k\Omega$ , $V_O = \pm 10V$	$T_A = -40^\circ C$ to $+85^\circ C$	0.8	4				
		0.8					
$V_{ICR}$	Common-mode input voltage range	TLE2024C, TLE2024AC To positive rail, $R_S = 50\Omega$	$T_A = 0^\circ C$ to $70^\circ C$	13.5	14		V
				13.5			
		TLE2024C, TLE2024AC To negative rail, $R_S = 50\Omega$	$T_A = 0^\circ C$ to $70^\circ C$	-15	-15.3		
				-15			
		TLE2024I, TLE2024AI To positive rail, $R_S = 50\Omega$	$T_A = -40^\circ C$ to $+85^\circ C$	13.5	14		
				13.2			
TLE2024I, TLE2024AI To negative rail, $R_S = 50\Omega$	$T_A = -40^\circ C$ to $+85^\circ C$	-15	-15.3				
		-15					
CMRR	Common-mode rejection ratio	TLE2024C $V_{IC} = V_{ICRmin}$	$T_A = 0^\circ C$ to $70^\circ C$	92	102		dB
				88			
		TLE2024AC $V_{IC} = V_{ICRmin}$	$T_A = 0^\circ C$ to $70^\circ C$	94	105		
				90			
		TLE2024I $V_{IC} = V_{ICRmin}$	$T_A = -40^\circ C$ to $+85^\circ C$	92	102		
				88			
TLE2024AI $V_{IC} = V_{ICRmin}$	$T_A = -40^\circ C$ to $+85^\circ C$	94	105				
		90					
TLE2024BM $V_{IC} = V_{ICRmin}$	$T_A = -55^\circ C$ to $+125^\circ C$	97	108				
		93					

## 6.10 Electrical Characteristics for TLE2024, $V_{CC} = \pm 15V$ (continued)

at  $T_A = 25^\circ C$ ,  $V_{CC} = \pm 15V$ , and  $V_{IC} = V_{OUT} = V_{CC} / 2$  (unless otherwise noted)

PARAMETER		TEST CONDITIONS		MIN	TYP	MAX	UNIT
$V_O$	Voltage output swing	TLE2024C $R_L = 10k\Omega$	Positive	13.8	14.1		V
			Positive, $T_A = 0^\circ C$ to $70^\circ C$	13.7			
			Negative	-13.7	-14.1		
			Negative, $T_A = 0^\circ C$ to $70^\circ C$	-13.6			
		TLE2024AC $R_L = 10k\Omega$	Positive	13.9	14.2		
			Positive, $T_A = 0^\circ C$ to $70^\circ C$	13.8			
			Negative	-13.7	-14.1		
			Negative, $T_A = 0^\circ C$ to $70^\circ C$	-13.6			
		TLE2024I $R_L = 10k\Omega$	Positive	13.8	14.1		
			Positive, $T_A = -40^\circ C$ to $+85^\circ C$	13.7			
			Negative	-13.7	-14.1		
			Negative, $T_A = -40^\circ C$ to $+85^\circ C$	-13.6			
		TLE2024AI $R_L = 10k\Omega$	Positive	13.9	14.2		
			Positive, $T_A = -40^\circ C$ to $+85^\circ C$	13.7			
			Negative	-13.7	-14.1		
			Negative, $T_A = -40^\circ C$ to $+85^\circ C$	-13.6			
TLE2024BM $R_L = 10k\Omega$	Positive	14	14.3				
	Positive, $T_A = -55^\circ C$ to $+125^\circ C$	13.8					
	Negative	-13.7	-14.1				
	Negative, $T_A = -55^\circ C$ to $+125^\circ C$	-13.6					
$I_{CC}$	Supply current	TLE2024C, TLE2024AC			1050	1400	$\mu A$
			$T_A = 0^\circ C$ to $70^\circ C$				
		TLE2024I, TLE2024AI			1050	1400	
			$T_A = -40^\circ C$ to $+85^\circ C$				
		TLE2024BM			1050	1400	
			$T_A = -55^\circ C$ to $+125^\circ C$				
<b>AC SPECS</b>							
SR	Slew rate	$V_O = \pm 10V, G = 1$			0.7		V/ $\mu s$
$e_N$	Input voltage noise density	f = 10Hz	TLE2024xC, TLE2024xI		19	50	nV/ $\sqrt{Hz}$
			TLE2024BM		19		
		f = 1kHz	TLE2024xC, TLE2024I		15	30	
			TLE2024BM		15		
	Input voltage noise	f = 0.1Hz to 1Hz			0.16		$\mu V$
		f = 0.1Hz to 10Hz				0.47	
	Input current noise density				0.1		pA/ $\sqrt{Hz}$
GBW	Gain bandwidth	G = 1			2.8		MHz
$\Theta_M$	Phase margin				52°		

## 6.11 Electrical Characteristics for TLE2024, $V_{CC} = 5V$

at  $T_A = 25^\circ C$ ,  $V_{CC} = 5V$ , and  $V_{IC} = V_{OUT} = V_{CC} / 2$  (unless otherwise noted)

PARAMETER		TEST CONDITIONS		MIN	TYP	MAX	UNIT
<b>DC SPECS</b>							
$V_{IO}$	Input offset voltage	TLE2024C $R_S = 50\Omega$	$T_A = 0^\circ C$ to $70^\circ C$			$\pm 1100$	$\mu V$
						$\pm 1300$	
		TLE2024AC $R_S = 50\Omega$	$T_A = 0^\circ C$ to $70^\circ C$			$\pm 850$	
						$\pm 1050$	
		TLE2024I $R_S = 50\Omega$	$T_A = -40^\circ C$ to $+85^\circ C$			1100	
						$\pm 1300$	
		TLE2024AI $R_S = 50\Omega$	$T_A = -40^\circ C$ to $+85^\circ C$			$\pm 850$	
						$\pm 1050$	
		TLE2024BM $R_S = 50\Omega$	$T_A = -55^\circ C$ to $+125^\circ C$			$\pm 600$	
						$\pm 800$	
$dV_{IO}/dT$	Input offset voltage drift	TLE2024C, TLE2024AC $R_S = 50\Omega$ , $T_A = 0^\circ C$ to $70^\circ C$				$\pm 2$	$\mu V/^\circ C$
		TLE2024I, TLE2024AI $R_S = 50\Omega$ , $T_A = -40^\circ C$ to $+85^\circ C$				$\pm 2$	
		TLE2024BM $R_S = 50\Omega$ , $T_A = -55^\circ C$ to $+125^\circ C$				$\pm 2$	
$I_{IB}$	Input bias current	TLE2024C $R_S = 50\Omega$	$T_A = 0^\circ C$ to $70^\circ C$		45	70	nA
						90	
		TLE2024AC $R_S = 50\Omega$	$T_A = 0^\circ C$ to $70^\circ C$		40	70	
						90	
		TLE2024I $R_S = 50\Omega$	$T_A = -40^\circ C$ to $+85^\circ C$		45	70	
						90	
		TLE2024AI $R_S = 50\Omega$	$T_A = -40^\circ C$ to $+85^\circ C$		40	70	
						90	
		TLE2024BM $R_S = 50\Omega$	$T_A = -55^\circ C$ to $+125^\circ C$		35	70	
						90	
$I_{IO}$	Input offset current	TLE2024C $R_S = 50\Omega$	$T_A = 0^\circ C$ to $70^\circ C$		0.6	6	nA
						10	
		TLE2024AC $R_S = 50\Omega$	$T_A = 0^\circ C$ to $70^\circ C$		0.5	6	
						10	
		TLE2024I $R_S = 50\Omega$	$T_A = -40^\circ C$ to $+85^\circ C$		0.6	6	
						10	
		TLE2024AI $R_S = 50\Omega$	$T_A = -40^\circ C$ to $+85^\circ C$		0.5	6	
						10	
		TLE2024BM $R_S = 50\Omega$	$T_A = -55^\circ C$ to $+125^\circ C$		0.4	6	
						10	
PSRR	Power-supply rejection ratio	TLE2024I $V_{CC} = 5V$ to $30V$	$T_A = 0^\circ C$ to $70^\circ C$	98	112		dB
				93			
		TLE2024AC $V_{CC} = 5V$ to $30V$	$T_A = 0^\circ C$ to $70^\circ C$	100	115		
				95			
		TLE2024I $V_{CC} = 5V$ to $30V$	$T_A = -40^\circ C$ to $+85^\circ C$	98	112		
				93			
		TLE2024AI $V_{CC} = 5V$ to $30V$	$T_A = -40^\circ C$ to $+85^\circ C$	100	115		
				95			
		TLE2024BM $V_{CC} = 5V$ to $30V$	$T_A = -55^\circ C$ to $+125^\circ C$	103	117		
				98			



### 6.11 Electrical Characteristics for TLE2024, $V_{CC} = 5V$ (continued)

at  $T_A = 25^\circ C$ ,  $V_{CC} = 5V$ , and  $V_{IC} = V_{OUT} = V_{CC} / 2$  (unless otherwise noted)

PARAMETER		TEST CONDITIONS		MIN	TYP	MAX	UNIT
$A_v$	Large signal voltage gain	TLE2024C $R_L = 10k\Omega$ , $1.4V \leq V_O \leq 4V$	$T_A = 0^\circ C$ to $70^\circ C$	0.2	1.5		V/ $\mu V$
				0.1			
		TLE2024C $R_L = 10k\Omega$ , $1.4V \leq V_O \leq 4V$	$T_A = 0^\circ C$ to $70^\circ C$	0.3	1.5		
				0.1			
		TLE2024I $R_L = 10k\Omega$ , $1.4V \leq V_O \leq 4V$	$T_A = -40^\circ C$ to $+85^\circ C$	0.2	1.5		
				0.1			
TLE2024AI, $R_L = 10k\Omega$ , $1.4V \leq V_O \leq 4V$	$T_A = -40^\circ C$ to $+85^\circ C$	0.3	1.5				
		0.1					
$V_{ICR}$	Common-mode input voltage range	TLE2024C, TLE2024AC To positive rail, $R_S = 50\Omega$	$T_A = 0^\circ C$ to $70^\circ C$	3.5	4		V
				3.5			
		TLE2024C, TLE2024AC To negative rail, $R_S = 50\Omega$	$T_A = 0^\circ C$ to $70^\circ C$	0	-0.3		
				0			
		TLE2024I, TLE2024AI To positive rail, $R_S = 50\Omega$	$T_A = -40^\circ C$ to $+85^\circ C$	3.5	4		
				3.2			
TLE2024I, TLE2024AI To negative rail, $R_S = 50\Omega$	$T_A = -40^\circ C$ to $+85^\circ C$	0	-0.3				
		0					
CMRR	Common-mode rejection ratio	TLE2024C $V_{IC} = V_{ICRmin}$ , $R_S = 50\Omega$	$T_A = 0^\circ C$ to $70^\circ C$	80	90		dB
				80			
		TLE2024AC $V_{IC} = V_{ICRmin}$ , $R_S = 50\Omega$	$T_A = 0^\circ C$ to $70^\circ C$	82	92		
				82			
		TLE2024I $V_{IC} = V_{ICRmin}$ , $R_S = 50\Omega$	$T_A = -40^\circ C$ to $+85^\circ C$	80	90		
				80			
TLE2024AI $V_{IC} = V_{ICRmin}$ , $R_S = 50\Omega$	$T_A = -40^\circ C$ to $+85^\circ C$	82	92				
		82					
TLE2024BM $V_{IC} = V_{ICRmin}$ , $R_S = 50\Omega$	$T_A = -55^\circ C$ to $+125^\circ C$	85	95				
		85					

### 6.11 Electrical Characteristics for TLE2024, $V_{CC} = 5V$ (continued)

at  $T_A = 25^\circ C$ ,  $V_{CC} = 5V$ , and  $V_{IC} = V_{OUT} = V_{CC} / 2$  (unless otherwise noted)

PARAMETER		TEST CONDITIONS		MIN	TYP	MAX	UNIT
$V_O$	Voltage output swing	TLE2024C $R_L = 10k\Omega$	Positive	3.9	4.2		V
			Positive, $T_A = 0^\circ C$ to $70^\circ C$	3.7			
			Negative		0.7	0.8	
			Negative, $T_A = 0^\circ C$ to $70^\circ C$			0.95	
		TLE2024AC $R_L = 10k\Omega$	Positive	3.9	4.2		
			Positive, $T_A = 0^\circ C$ to $70^\circ C$	3.7			
			Negative		0.7	0.8	
			Negative, $T_A = 0^\circ C$ to $70^\circ C$			0.95	
		TLE2024I $R_L = 10k\Omega$	Positive	3.9	4.2		
			Positive, $T_A = -40^\circ C$ to $+85^\circ C$	3.7			
			Negative		0.7	0.8	
			Negative, $T_A = -40^\circ C$ to $+85^\circ C$			0.95	
		TLE2024AI $R_L = 10k\Omega$	Positive	3.9	4.2		
			Positive, $T_A = -40^\circ C$ to $+85^\circ C$	3.7			
			Negative		0.7	0.8	
			Negative, $T_A = -40^\circ C$ to $+85^\circ C$			0.95	
TLE2024BM $R_L = 10k\Omega$	Positive	3.8	4.3				
	Positive, $T_A = -55^\circ C$ to $+125^\circ C$	3.8					
	Negative		0.7	0.8			
	Negative, $T_A = -55^\circ C$ to $+125^\circ C$			0.95			
$I_{CC}$	Supply current	TLE2024C, TLE2024AC			800	1200	$\mu A$
			$T_A = 0^\circ C$ to $70^\circ C$				
		TLE2024I, TLE2024AI			800	1200	
			$T_A = -40^\circ C$ to $+85^\circ C$				
		TLE2024BM			800	1200	
			$T_A = -55^\circ C$ to $+125^\circ C$				
<b>AC SPECS</b>							
SR	Slew rate	$V_O = \pm 10V, G = 1$			0.5		V/ $\mu s$
$e_N$	Input voltage noise density	f = 10Hz	TLE2024xC, TLE2024xI		21		nV/ $\sqrt{Hz}$
			TLE2024BM		21		
		f = 1kHz	TLE2024xC, TLE2024xI		17		
			TLE2024BM		17		
Input voltage noise	f = 0.1Hz to 1Hz			0.16		$\mu V$	
	f = 0.1Hz to 10Hz			0.47			
	Input current noise density				0.1		pA/ $\sqrt{Hz}$
GBW	Gain bandwidth	G = 1			1.7		MHz
$\Theta_M$	Phase margin				47°		

## 6.12 Typical Characteristics

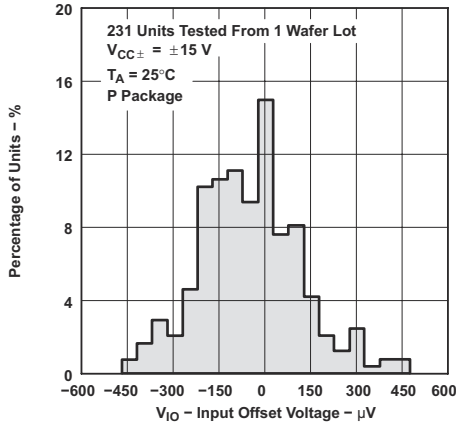

Figure 6-1. Distribution of TLE2021 Input Offset Voltage

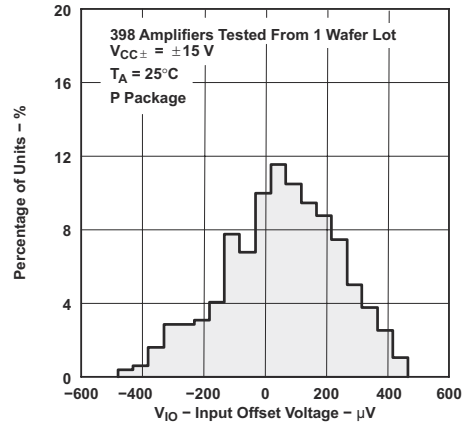

Figure 6-2. Distribution of TLE2022 Input Offset Voltage

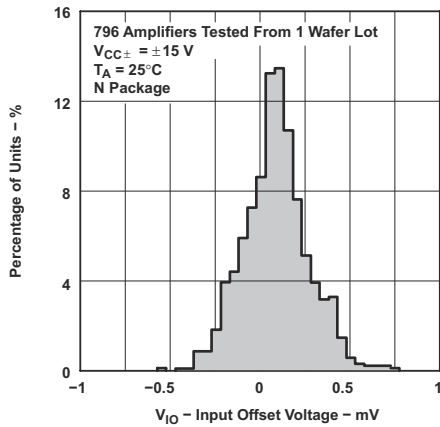

Figure 6-3. Distribution of TLE2024 Input Offset Voltage

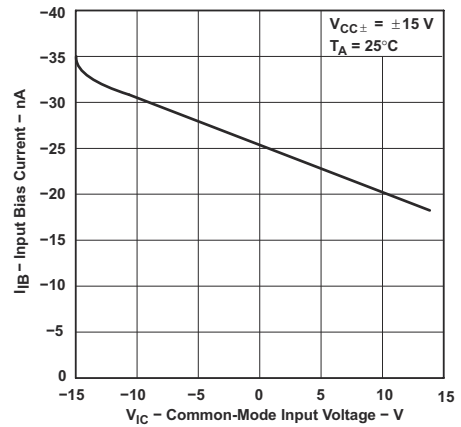

Figure 6-4. TLE2021 Input Bias Current vs Common-Mode Input Voltage

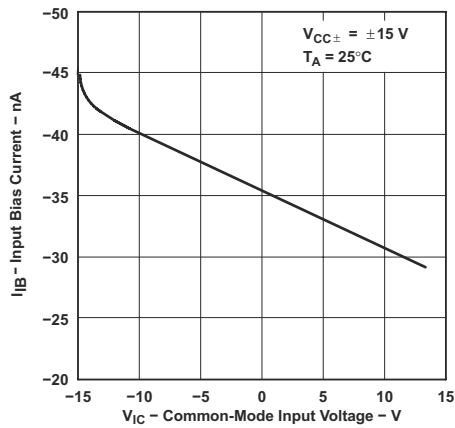

Figure 6-5. TLE2022 Input Bias Current vs Common-Mode Input Voltage

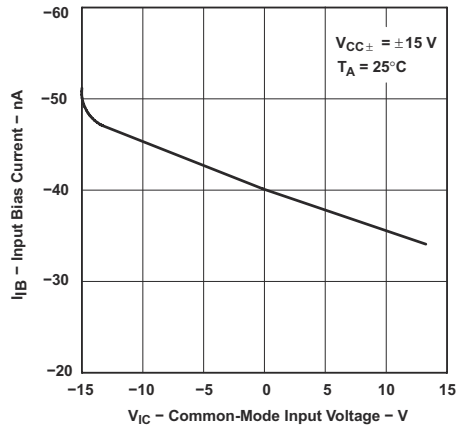
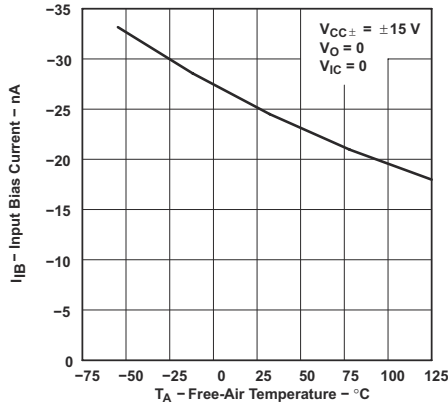

Figure 6-6. TLE2024 Input Bias Current vs Common-Mode Input Voltage

## 6.12 Typical Characteristics (continued)



Data at high and low temperatures applicable only within rated operating free-air temperature ranges of the various devices

Figure 6-7. TLE2021 Input Bias Current vs Free-Air Temperature

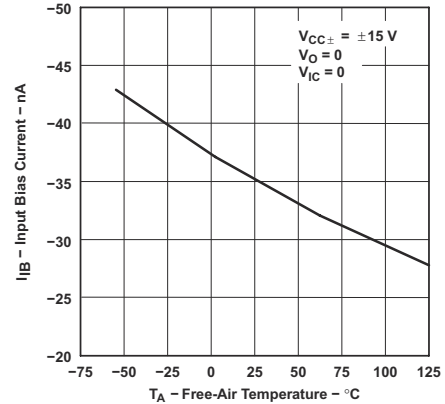

Data at high and low temperatures applicable only within rated operating free-air temperature ranges of the various devices

Figure 6-8. TLE2022 Input Bias Current vs Free-Air Temperature

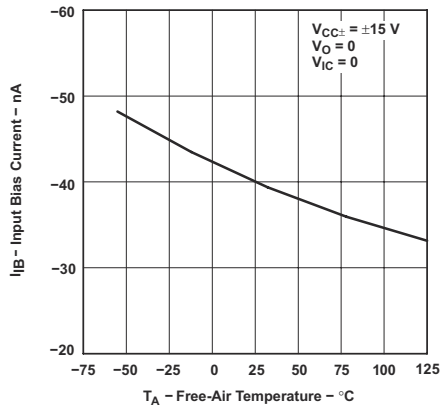

Data at high and low temperatures applicable only within rated operating free-air temperature ranges of the various devices

Figure 6-9. TLE2024 Input Bias Current vs Free-Air Temperature

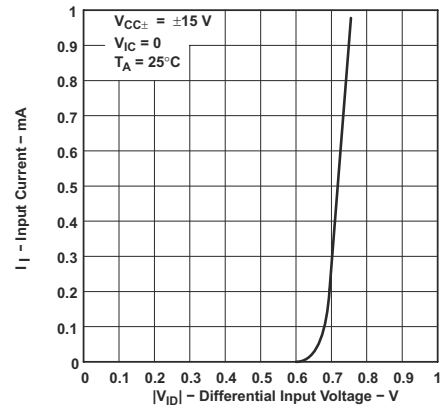

Figure 6-10. Input Current vs Differential Input Voltage

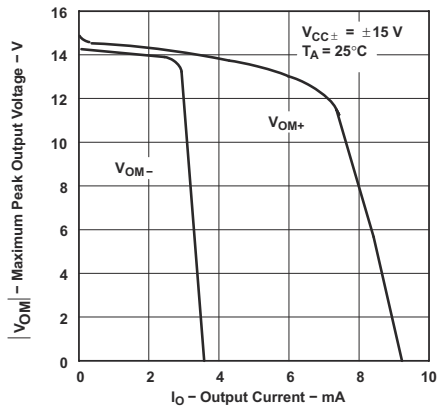

Figure 6-11. TLE2021 Maximum Peak Output Voltage vs Output Current

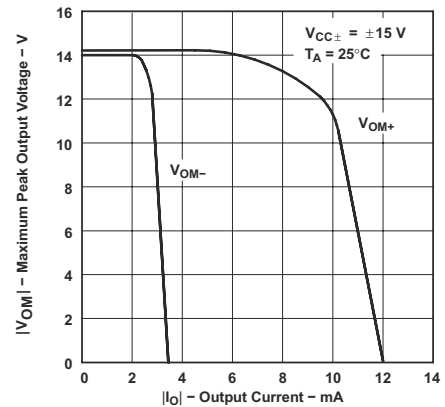

Figure 6-12. TLE2022 Maximum Peak Output Voltage vs Output Current

### 6.12 Typical Characteristics (continued)

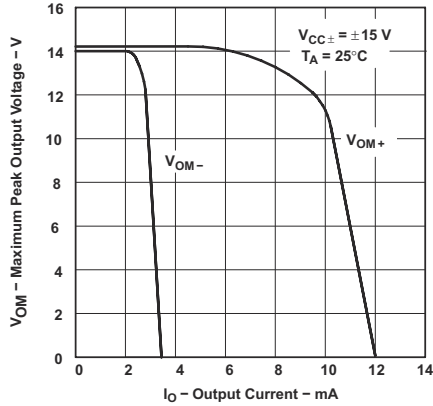
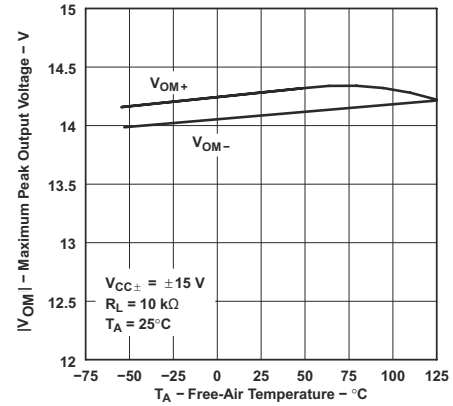

Figure 6-13. TLE2024 Maximum Peak Output Voltage vs Output Current



Data at high and low temperatures applicable only within rated operating free-air temperature ranges of the various devices

Figure 6-14. Maximum Peak Output Voltage vs Free-Air Temperature

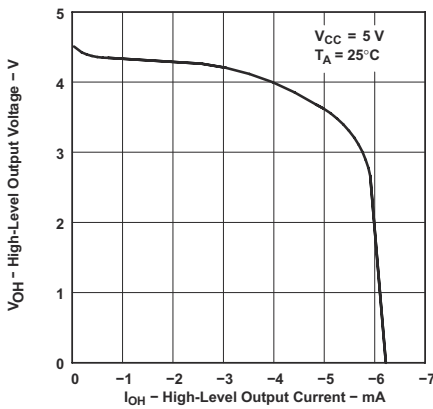

Figure 6-15. TLE2021 High-Level Output Voltage vs High-Level Output Current

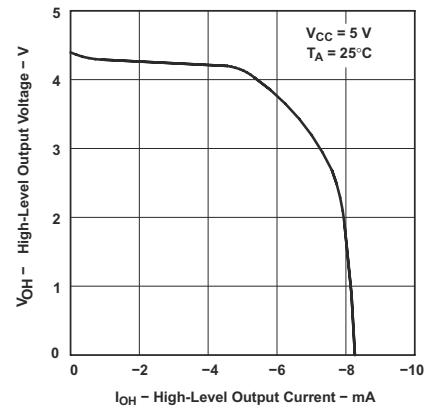
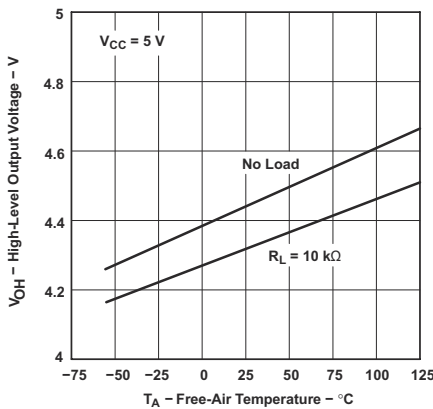

Figure 6-16. TLE2022 and TLE2024 High-Level Output Voltage vs High-Level Output Current



Data at high and low temperatures applicable only within rated operating free-air temperature ranges of the various devices

Figure 6-17. High-Level Output Voltage vs Free-Air Temperature

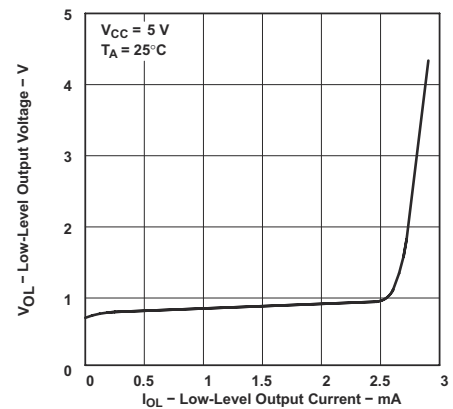
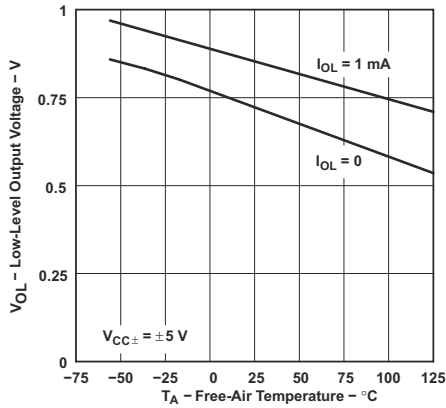

Figure 6-18. Low-Level Output Voltage vs Low-Level Output Current

## 6.12 Typical Characteristics (continued)



Data at high and low temperatures applicable only within rated operating free-air temperature ranges of the various devices

Figure 6-19. Low-Level Output Voltage vs Free-Air Temperature

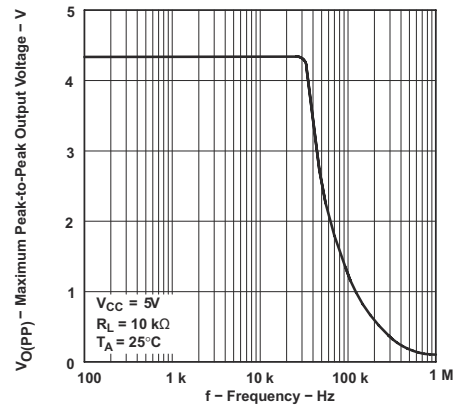

Figure 6-20. Maximum Peak-to-Peak Output Voltage Vs Frequency

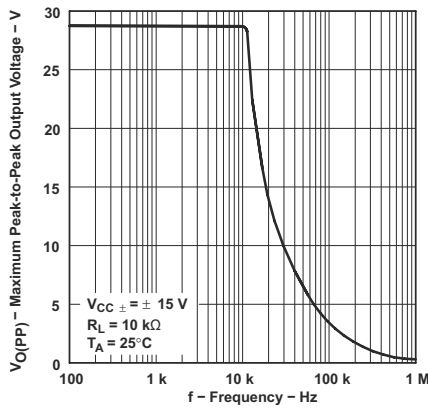

Figure 6-21. Maximum Peak-to-Peak Output Voltage vs Frequency

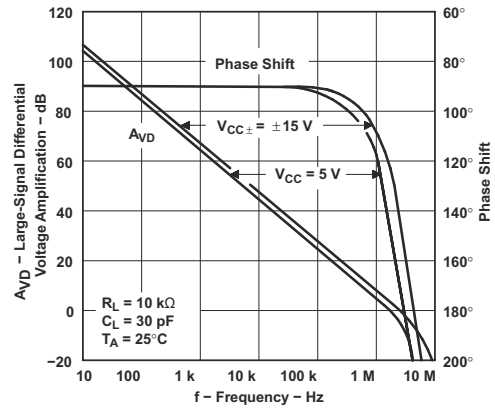

Figure 6-22. Large-Signal Differential Voltage Amplification and Phase Shift vs Frequency

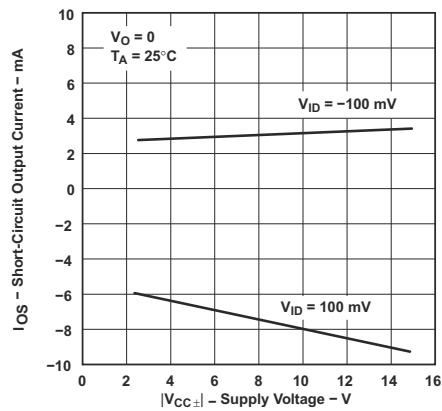

Figure 6-23. TLE2021 Short-Circuit Output Current vs Supply Voltage

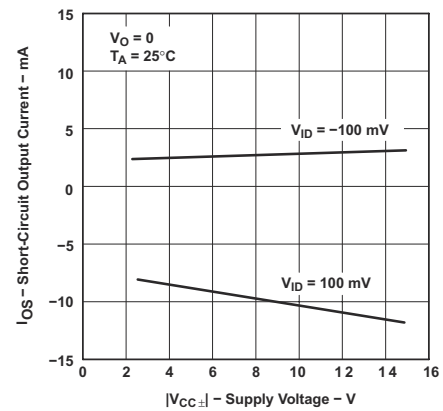

Figure 6-24. TLE2022 and TLE2024 Short-Circuit Output Current vs Supply Voltage

## 6.12 Typical Characteristics (continued)

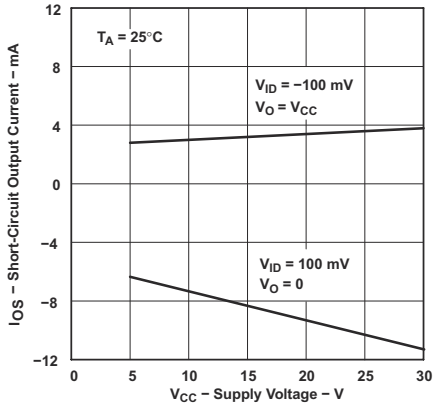
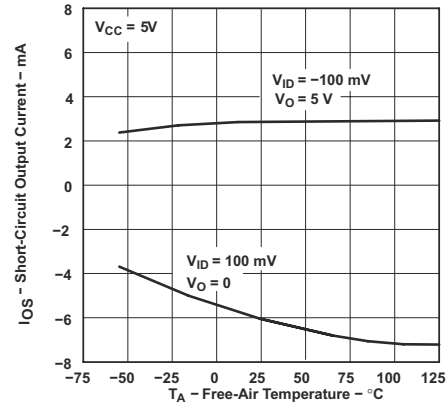

Figure 6-25. TLE2021 Short-Circuit Output Current vs Supply Voltage



Data at high and low temperatures applicable only within rated operating free-air temperature ranges of the various devices

Figure 6-26. TLE2021 Short-Circuit Output Current vs Free-Air Temperature

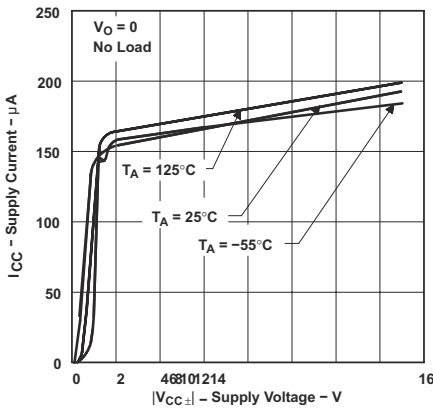

Figure 6-27. TLE2021 Supply Current vs Supply Voltage

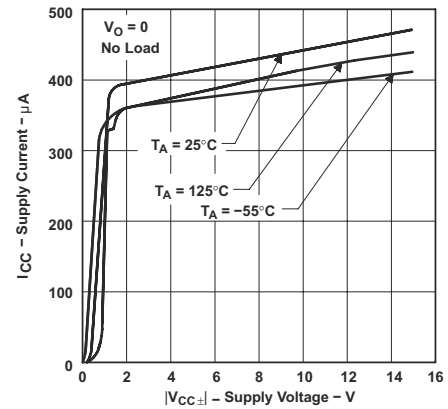

Figure 6-28. TLE2022 Supply Current vs Supply Voltage

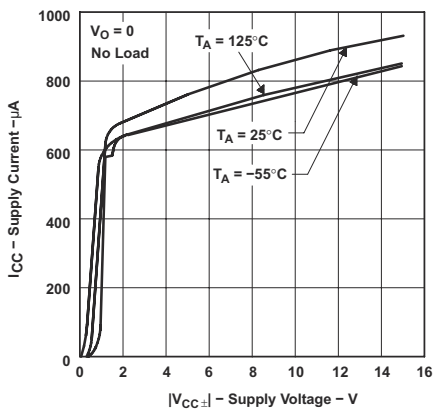
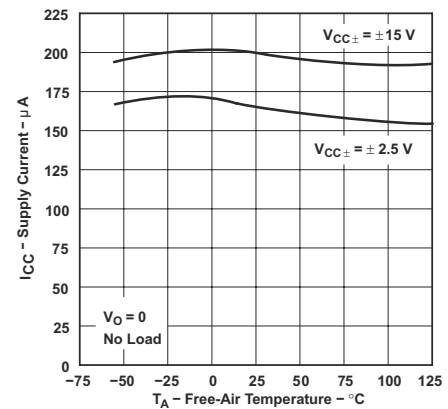

Figure 6-29. TLE2024 Supply Current vs Supply Voltage



Data at high and low temperatures applicable only within rated operating free-air temperature ranges of the various devices

Figure 6-30. TLE2021 Supply Current vs Free-Air Temperature

## 6.12 Typical Characteristics (continued)

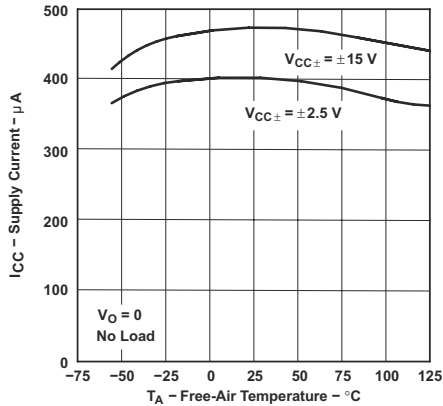

Data at high and low temperatures applicable only within rated operating free-air temperature ranges of the various devices

Figure 6-31. TLE2022 Supply Current vs Free-Air Temperature

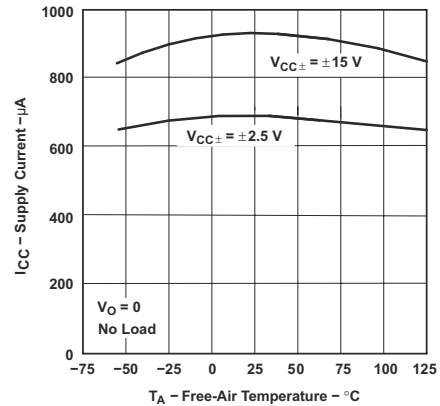

Data at high and low temperatures applicable only within rated operating free-air temperature ranges of the various devices

Figure 6-32. TLE2024 Supply Current vs Free-Air Temperature

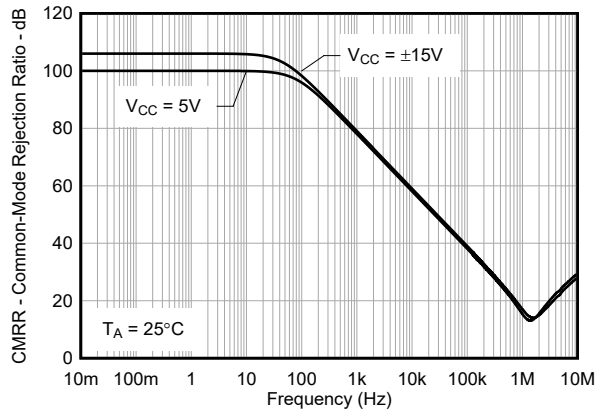

Figure 6-33. TLE202x Common-Mode Rejection Ratio vs Frequency

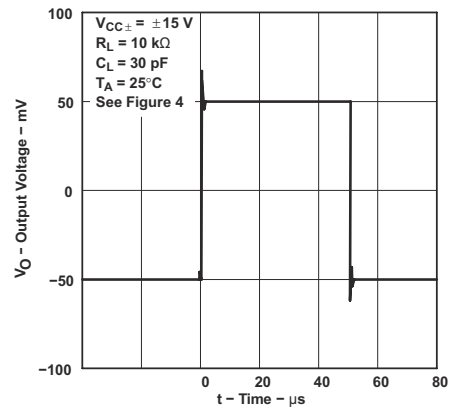

Figure 6-34. Voltage-Follower Small-Signal Pulse Response

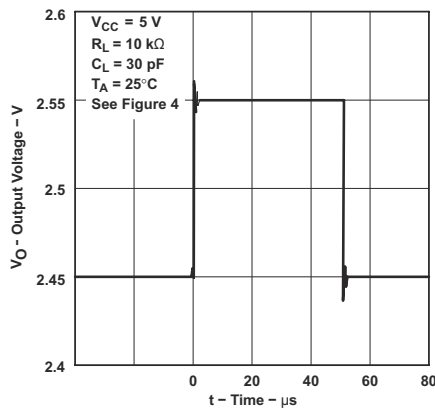

Figure 6-35. Voltage-Follower Small-Signal Pulse Response

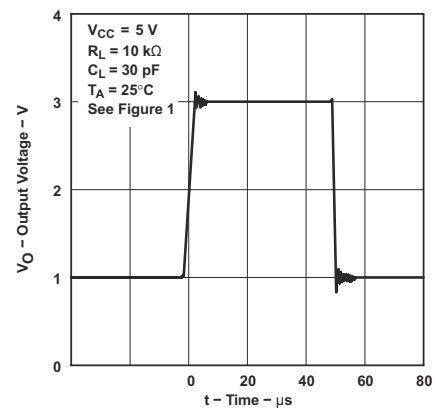

Figure 6-36. TLE2021 Voltage-Follower Large-Signal Pulse Response



## 6.12 Typical Characteristics (continued)

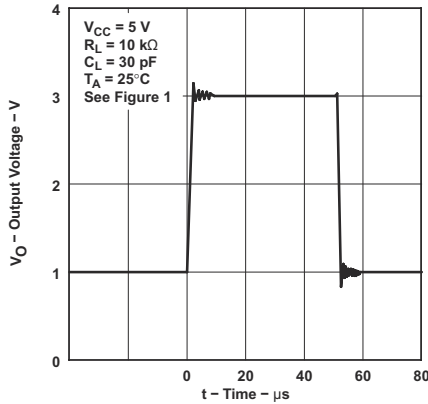

Figure 6-37. TLE2022 Voltage-Follower Large-Signal Pulse Response

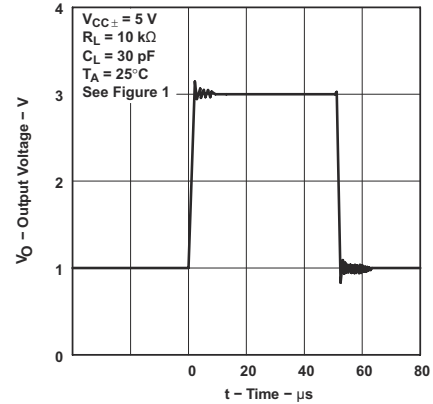

Figure 6-38. TLE2024 Voltage-Follower Large-Scale Pulse Response

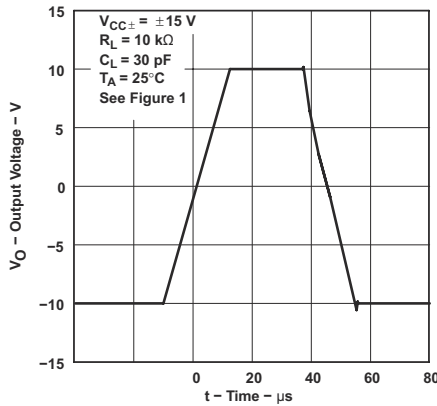

Figure 6-39. TLE2021 Voltage-Follower Large-Signal Pulse Response

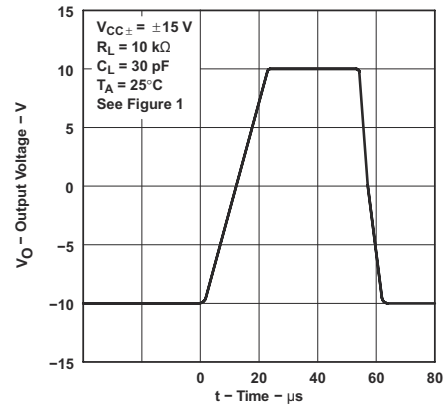

Figure 6-40. TLE2022 Voltage-Follower Large-Signal Pulse Response

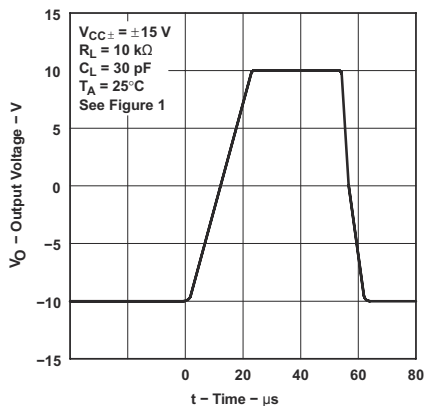

Figure 6-41. TLE2024 Voltage-Follower Large-Signal Pulse Response

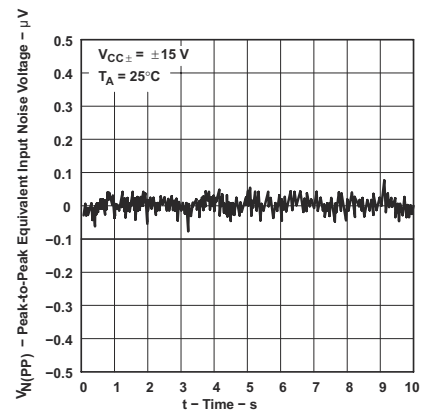
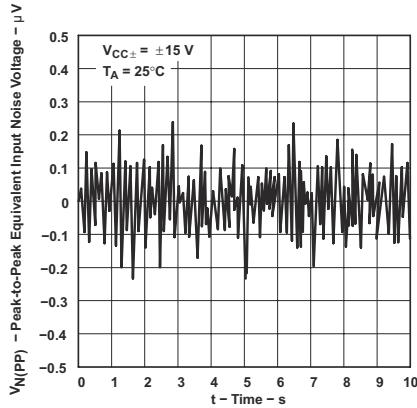
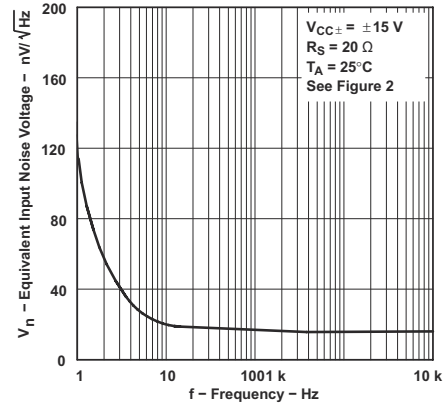

Figure 6-42. Peak-to-Peak Equivalent Input Noise Voltage 0.1Hz to 1Hz

## 6.12 Typical Characteristics (continued)



**Figure 6-43. Peak-to-Peak Equivalent Input Noise Voltage 0.1Hz to 10Hz**



**Figure 6-44. Equivalent Input Noise Voltage vs Frequency**

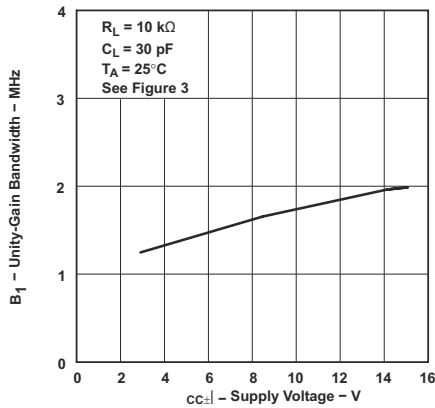

**Figure 6-45. TLE2021 Unity-Gain Bandwidth vs Supply Voltage**

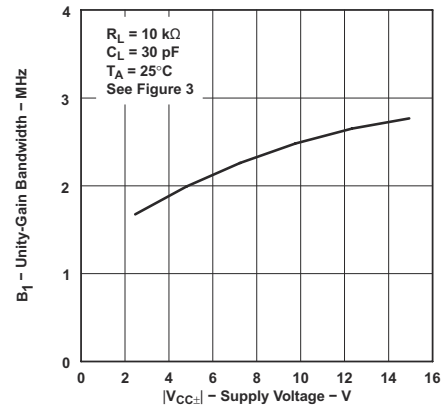

**Figure 6-46. TLE2022 and TLE2024 Unity-Gain Bandwidth vs Supply Voltage**

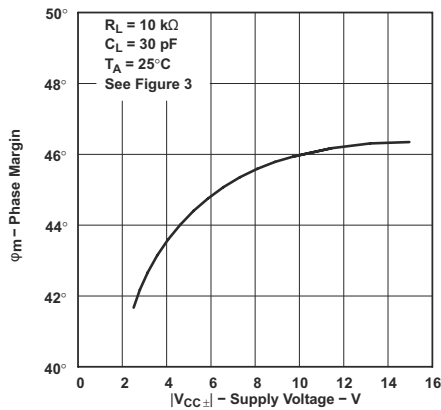

**Figure 6-47. TLE2021 Phase Margin vs Supply Voltage**

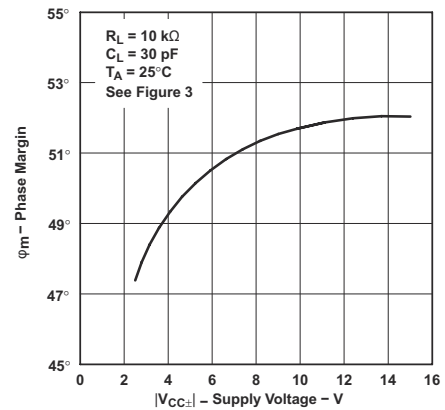

**Figure 6-48. TLE2022 and TLE2024 Phase Margin vs Supply Voltage**

## 6.12 Typical Characteristics (continued)

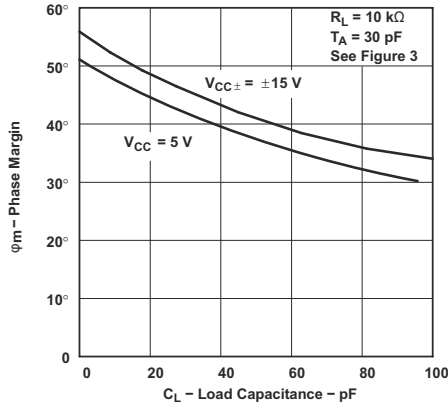

Figure 6-49. TLE2021 Phase Margin vs Load Capacitance

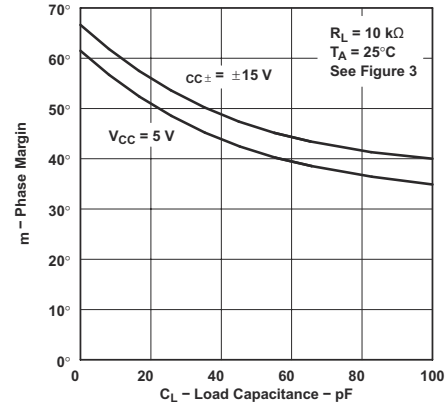

Figure 6-50. TLE2022 and TLE2024 Phase Margin vs Load Capacitance

## 7 Application and Implementation

### Note

Information in the following applications sections is not part of the TI component specification, and TI does not warrant its accuracy or completeness. TI's customers are responsible for determining suitability of components for their purposes, as well as validating and testing their design implementation to confirm system functionality.

### 7.1 Application Information

#### 7.1.1 Voltage-Follower Applications

The TLE202x circuitry includes input-protection diodes to limit the voltage across the input transistors; however, no provision is made in the circuit to limit the current if these diodes are forward biased. This condition sometimes occurs when the device is operated in the voltage-follower configuration and driven with a fast, large-signal pulse. Use a feedback resistor to limit the current to a maximum of 1mA to prevent degradation of the device. This feedback resistor forms a pole with the input capacitance of the device. For feedback resistor values greater than 10kΩ, this pole degrades the amplifier phase margin. Figure 7-1 shows that to alleviate this problem, add a capacitor (20pF to 50pF) in parallel with the feedback resistor.

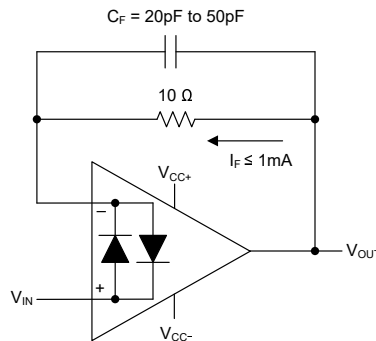

Figure 7-1. Voltage Follower

#### 7.1.2 Input Offset Voltage Null

The TLE202x series offers external null pins that further reduce the input offset voltage. Figure 7-2 shows how to connect the circuit if this feature is desired. Adjust the external resistance value to achieve desired performance. When external null is not needed, leave the null pins disconnected. Only use this adjustment to null the offset of the operational amplifier. Do not use this adjustment to compensate for offsets created elsewhere in a system because of the possible introduction of additional temperature drift.

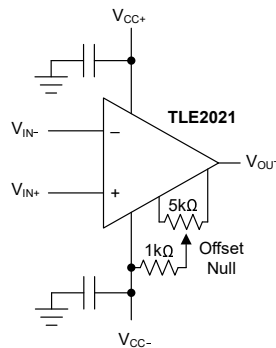

Figure 7-2. Input Offset Voltage Null Circuit

Internal resistances vary; unexpected results are sometimes produced when using fixed resistors to null the offset of the amplifier.

## 7.2 Layout

### 7.2.1 Layout Guidelines

For best operational performance of the device, use good printed circuit board (PCB) layout practices, including:

1. Connect low-ESR, 0.1  $\mu\text{F}$  ceramic bypass capacitors between each supply pin and ground, placed as close to the device as possible. A single bypass capacitor from  $V_{CC+}$  to ground is applicable for single-supply applications. Noise propagates into analog circuitry through the power pins of the circuit as a whole, as well as through the individual op amp. Use bypass capacitors to reduce the coupled noise by providing low-impedance power sources local to the analog circuitry.
2. Physically separate digital and analog grounds, paying special attention to the ground-current flow. Separate grounding for analog and digital portions of circuitry is one of the simplest and most effective methods of noise suppression. One or more layers on multilayer PCBs are typically devoted to ground planes. A ground plane helps distribute heat and reduces EMI noise pickup.
3. To reduce parasitic coupling, run the input traces as far away from the supply or output traces as possible. If these traces cannot be kept separate, crossing the sensitive trace perpendicular is much better as opposed to in parallel with the noisy trace.
4. Place the external components as close to the device as possible. Figure 7-4 shows how to keep  $R_F$  and  $R_G$  close to the inverting input to minimize parasitic capacitance.
5. Keep the length of input traces as short as possible. Always remember that the input traces are the most sensitive part of the circuit.
6. Consider a driven, low-impedance guard ring around the critical traces. Use a guard ring to significantly reduce leakage currents from nearby traces that are at different potentials.
7. Clean the PCB following board assembly for best performance.
8. Any precision integrated circuit can experience performance shifts due to moisture ingress into the plastic package. After any aqueous PCB cleaning process, bake the PCB assembly to remove moisture introduced into the device packaging during the cleaning process. A low-temperature, post-cleaning bake at 85°C for 30 minutes is sufficient for most circumstances.

### 7.2.2 Layout Example

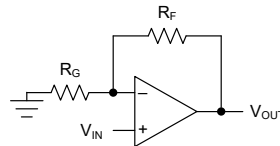

Figure 7-3. Schematic Representation

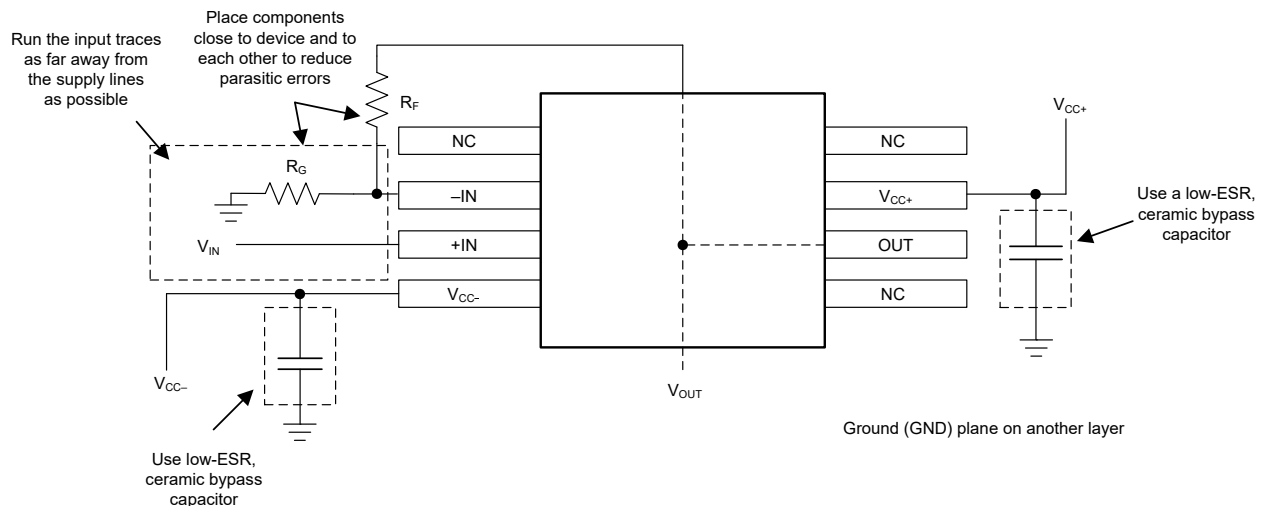

Figure 7-4. Operational Amplifier Board Layout for Noninverting Configuration

## 8 Device and Documentation Support

TI offers an extensive line of development tools. Tools and software to evaluate the performance of the device, generate code, and develop solutions are listed below.

### 8.1 Device Support

#### 8.1.1 Device Nomenclature

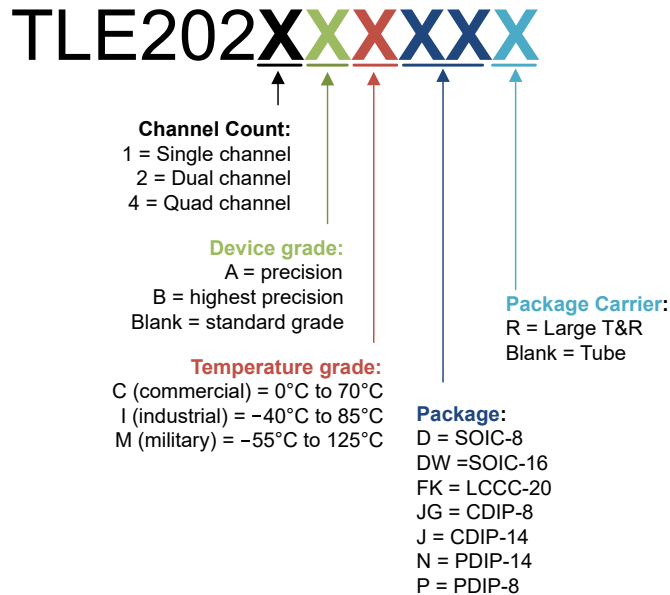

Figure 8-1. Demystifying the TLE202x Orderable Part Numbers

### 8.2 Receiving Notification of Documentation Updates

To receive notification of documentation updates, navigate to the device product folder on [ti.com](https://www.ti.com). Click on *Notifications* to register and receive a weekly digest of any product information that has changed. For change details, review the revision history included in any revised document.

### 8.3 Support Resources

[TI E2E™ support forums](#) are an engineer's go-to source for fast, verified answers and design help — straight from the experts. Search existing answers or ask your own question to get the quick design help you need.

Linked content is provided "AS IS" by the respective contributors. They do not constitute TI specifications and do not necessarily reflect TI's views; see TI's [Terms of Use](#).

### 8.4 Trademarks

TI E2E™ is a trademark of Texas Instruments.  
All trademarks are the property of their respective owners.

### 8.5 Electrostatic Discharge Caution



This integrated circuit can be damaged by ESD. Texas Instruments recommends that all integrated circuits be handled with appropriate precautions. Failure to observe proper handling and installation procedures can cause damage.

ESD damage can range from subtle performance degradation to complete device failure. Precision integrated circuits may be more susceptible to damage because very small parametric changes could cause the device not to meet its published specifications.

### 8.6 Glossary

[TI Glossary](#) This glossary lists and explains terms, acronyms, and definitions.

## 9 Revision History

NOTE: Page numbers for previous revisions may differ from page numbers in the current version.

<b>Changes from Revision SLOS191D (November 2010) to Revision * (July 2025)</b>	<b>Page</b>
• Deleted TLE2021Y, TLE2022Y, and TLE2024Y content from this document.....	1
• Deleted PW (TSSOP), FK (LCCC), JG (CDIP) and J (CDIP) packages and associated content throughout document.....	1
• Deleted all references to Excalibur process.....	1
• Moved TLE202x commercial devices from SLOS191D data sheet into new SLVSDJ7 data sheet.....	1
• Updated the numbering format for tables, figures, and cross-references throughout the document.....	1
• Added <i>Applications, Pin Configuration and Functions, Specifications, Thermal Information, Application and Implementation, Layout, Device and Documentation Support, and Mechanical, Packaging, Orderable Information</i> , and <i>Revision History</i> sections, and associated subsections where applicable.....	1
• Updated <i>Features</i> .....	1
• Updated front page figure.....	1
• Updated available options tables.....	2
• Deleted <i>Equivalent Schematic (Each Amplifier)</i> .....	2
• Updated pin names and images in <i>Pin Configuration and Functions</i> .....	3
• Updated parameter names and symbols in all <i>Electrical Characteristics</i> .....	8
• Added $\pm$ to input offset voltage, input offset voltage drift, and input offset voltage long-term drift in all <i>Electrical Characteristics</i> .....	8
• Deleted input offset voltage long term drift in all <i>Electrical Characteristics</i> .....	8
• Moved voltage output swing (negative) values from MIN to MAX in all <i>Electrical Characteristics</i> .....	8
• Deleted supply-current change over operating temperature range in all <i>Electrical Characteristics</i> .....	8
• Deleted slew rate MIN in all $V_{CC\pm} = \pm 15V$ <i>Electrical Characteristics</i> .....	8
• Deleted slew rate over temperature in all $V_{CC\pm} = \pm 15V$ <i>Electrical Characteristics</i> .....	8
• Deleted <i>Parameter Measurement Information</i> section.....	27
• Deleted Figures 27 to 29, Figures 34 to 37, Figures 47 to 49, Figures 63 to 64, and Figures 69 to 70.....	27
• Updated Figures 44 to 46 ( <i>Common-Mode Rejection Ratio vs Frequency</i> ).....	27
• Deleted <i>Parameter Measurement Information</i> .....	36
• Updated Figure 7-1, <i>Voltage Follower</i> .....	36
• Deleted <i>Macromodel Information</i> .....	36
• Updated <i>Input Offset Voltage Nulling</i> description.....	36
• Updated Figure 7-2, <i>Input Offset Voltage Null Circuit</i> .....	36
• Added <i>Layout</i> and associated figures.....	37

## 10 Mechanical, Packaging, and Orderable Information

The following pages include mechanical, packaging, and orderable information. This information is the most current data available for the designated devices. This data is subject to change without notice and revision of this document. For browser-based versions of this data sheet, refer to the left-hand navigation.

**PACKAGING INFORMATION**

Orderable part number	Status (1)	Material type (2)	Package   Pins	Package qty   Carrier	RoHS (3)	Lead finish/ Ball material (4)	MSL rating/ Peak reflow (5)	Op temp (°C)	Part marking (6)
<a href="#">TLE2021ACD</a>	Obsolete	Production	SOIC (D)   8	-	-	Call TI	Call TI	-	2021AC
<a href="#">TLE2021ACDR</a>	Last Time Buy	Production	SOIC (D)   8	2500   LARGE T&R	Yes	NIPDAU	Level-1-260C-UNLIM	-	2021AC
<a href="#">TLE2021ACP</a>	Active	Production	PDIP (P)   8	50   TUBE	Yes	NIPDAU	N/A for Pkg Type	-	TLE2021AC
<a href="#">TLE2021ACP.A</a>	Active	Production	PDIP (P)   8	50   TUBE	Yes	NIPDAU	N/A for Pkg Type	-40 to 85	TLE2021AC
<a href="#">TLE2021AID</a>	Obsolete	Production	SOIC (D)   8	-	-	Call TI	Call TI	-40 to 85	2021AI
<a href="#">TLE2021AIDR</a>	Active	Production	SOIC (D)   8	2500   LARGE T&R	Yes	NIPDAU	Level-1-260C-UNLIM	-	2021AI
<a href="#">TLE2021AIDR.A</a>	Active	Production	SOIC (D)   8	2500   LARGE T&R	Yes	NIPDAU	Level-1-260C-UNLIM	-40 to 85	2021AI
<a href="#">TLE2021AIP</a>	Active	Production	PDIP (P)   8	50   TUBE	Yes	NIPDAU	N/A for Pkg Type	-	TLE2021AI
<a href="#">TLE2021AIP.A</a>	Active	Production	PDIP (P)   8	50   TUBE	Yes	NIPDAU	N/A for Pkg Type	-40 to 85	TLE2021AI
<a href="#">TLE2021CD</a>	Obsolete	Production	SOIC (D)   8	-	-	Call TI	Call TI	0 to 70	2021C
<a href="#">TLE2021CDR</a>	Last Time Buy	Production	SOIC (D)   8	2500   LARGE T&R	Yes	NIPDAU	Level-1-260C-UNLIM	0 to 70	2021C
<a href="#">TLE2021CP</a>	Active	Production	PDIP (P)   8	50   TUBE	Yes	NIPDAU	N/A for Pkg Type	0 to 70	TLE2021CP
<a href="#">TLE2021CP.A</a>	Active	Production	PDIP (P)   8	50   TUBE	Yes	NIPDAU	N/A for Pkg Type	0 to 70	TLE2021CP
<a href="#">TLE2021CPE4</a>	Active	Production	PDIP (P)   8	50   TUBE	Yes	NIPDAU	N/A for Pkg Type	0 to 70	TLE2021CP
<a href="#">TLE2021ID</a>	Obsolete	Production	SOIC (D)   8	-	-	Call TI	Call TI	-40 to 85	2021I
<a href="#">TLE2021IDR</a>	Active	Production	SOIC (D)   8	2500   LARGE T&R	Yes	NIPDAU	Level-1-260C-UNLIM	-40 to 85	2021I
<a href="#">TLE2021IDR.A</a>	Active	Production	SOIC (D)   8	2500   LARGE T&R	Yes	NIPDAU	Level-1-260C-UNLIM	-40 to 85	2021I
<a href="#">TLE2021IP</a>	Active	Production	PDIP (P)   8	50   TUBE	Yes	NIPDAU	N/A for Pkg Type	-40 to 85	TLE2021IP
<a href="#">TLE2021IP.A</a>	Active	Production	PDIP (P)   8	50   TUBE	Yes	NIPDAU	N/A for Pkg Type	-40 to 85	TLE2021IP
<a href="#">TLE2021MD</a>	Active	Production	SOIC (D)   8	75   TUBE	Yes	NIPDAU	Level-1-260C-UNLIM	-55 to 125	2021M
<a href="#">TLE2021MD.A</a>	Active	Production	SOIC (D)   8	75   TUBE	Yes	NIPDAU	Level-1-260C-UNLIM	-55 to 125	2021M
<a href="#">TLE2021MDG4</a>	Active	Production	SOIC (D)   8	75   TUBE	Yes	NIPDAU	Level-1-260C-UNLIM	-	2021M
<a href="#">TLE2021MDG4.A</a>	Active	Production	SOIC (D)   8	75   TUBE	Yes	NIPDAU	Level-1-260C-UNLIM	-55 to 125	2021M
<a href="#">TLE2022ACD</a>	Obsolete	Production	SOIC (D)   8	-	-	Call TI	Call TI	0 to 70	2022AC
<a href="#">TLE2022ACDR</a>	Active	Production	SOIC (D)   8	2500   LARGE T&R	Yes	NIPDAU	Level-1-260C-UNLIM	-	2022AC
<a href="#">TLE2022ACDR.A</a>	Active	Production	SOIC (D)   8	2500   LARGE T&R	Yes	NIPDAU	Level-1-260C-UNLIM	-40 to 85	2022AC
<a href="#">TLE2022ACP</a>	Active	Production	PDIP (P)   8	50   TUBE	Yes	NIPDAU	N/A for Pkg Type	-	TLE2022AC
<a href="#">TLE2022ACP.A</a>	Active	Production	PDIP (P)   8	50   TUBE	Yes	NIPDAU	N/A for Pkg Type	-40 to 85	TLE2022AC



Orderable part number	Status (1)	Material type (2)	Package   Pins	Package qty   Carrier	RoHS (3)	Lead finish/ Ball material (4)	MSL rating/ Peak reflow (5)	Op temp (°C)	Part marking (6)
<a href="#">TLE2022AID</a>	Obsolete	Production	SOIC (D)   8	-	-	Call TI	Call TI	-40 to 85	2022AI
<a href="#">TLE2022AIDR</a>	Active	Production	SOIC (D)   8	2500   LARGE T&R	Yes	NIPDAU	Level-1-260C-UNLIM	-	2022AI
<a href="#">TLE2022AIDR.A</a>	Active	Production	SOIC (D)   8	2500   LARGE T&R	Yes	NIPDAU	Level-1-260C-UNLIM	-40 to 85	2022AI
<a href="#">TLE2022AIP</a>	Active	Production	PDIP (P)   8	50   TUBE	Yes	NIPDAU	N/A for Pkg Type	-	TLE2022AI
<a href="#">TLE2022AIP.A</a>	Active	Production	PDIP (P)   8	50   TUBE	Yes	NIPDAU	N/A for Pkg Type	-40 to 85	TLE2022AI
<a href="#">TLE2022AMD</a>	Obsolete	Production	SOIC (D)   8	-	-	Call TI	Call TI	-55 to 125	2022AM
<a href="#">TLE2022AMDG4</a>	Active	Production	SOIC (D)   8	75   TUBE	Yes	NIPDAU	Level-1-260C-UNLIM	-	2022AM
<a href="#">TLE2022AMDG4.A</a>	Active	Production	SOIC (D)   8	75   TUBE	Yes	NIPDAU	Level-1-260C-UNLIM	-55 to 125	2022AM
<a href="#">TLE2022AMDR</a>	Active	Production	SOIC (D)   8	2500   LARGE T&R	Yes	NIPDAU	Level-1-260C-UNLIM	-55 to 125	2022AM
<a href="#">TLE2022AMDR.A</a>	Active	Production	SOIC (D)   8	2500   LARGE T&R	Yes	NIPDAU	Level-1-260C-UNLIM	-55 to 125	2022AM
<a href="#">TLE2022AMDRG4</a>	Active	Production	SOIC (D)   8	2500   LARGE T&R	Yes	NIPDAU	Level-1-260C-UNLIM	-	2022AM
<a href="#">TLE2022AMDRG4.A</a>	Active	Production	SOIC (D)   8	2500   LARGE T&R	Yes	NIPDAU	Level-1-260C-UNLIM	-55 to 125	2022AM
<a href="#">TLE2022CD</a>	Obsolete	Production	SOIC (D)   8	-	-	Call TI	Call TI	-	2022C
<a href="#">TLE2022CDR</a>	Active	Production	SOIC (D)   8	2500   LARGE T&R	Yes	NIPDAU	Level-1-260C-UNLIM	0 to 70	2022C
<a href="#">TLE2022CDR.A</a>	Active	Production	SOIC (D)   8	2500   LARGE T&R	Yes	NIPDAU	Level-1-260C-UNLIM	0 to 70	2022C
<a href="#">TLE2022CP</a>	Active	Production	PDIP (P)   8	50   TUBE	Yes	NIPDAU	N/A for Pkg Type	-	TLE2022CP
<a href="#">TLE2022CP.A</a>	Active	Production	PDIP (P)   8	50   TUBE	Yes	NIPDAU	N/A for Pkg Type	-40 to 85	TLE2022CP
<a href="#">TLE2022CPE4</a>	Active	Production	PDIP (P)   8	50   TUBE	Yes	NIPDAU	N/A for Pkg Type	See TLE2022CP	TLE2022CP
<a href="#">TLE2022ID</a>	Obsolete	Production	SOIC (D)   8	-	-	Call TI	Call TI	-40 to 85	2022I
<a href="#">TLE2022IDR</a>	Active	Production	SOIC (D)   8	2500   LARGE T&R	Yes	NIPDAU	Level-1-260C-UNLIM	-40 to 85	2022I
<a href="#">TLE2022IDR.A</a>	Active	Production	SOIC (D)   8	2500   LARGE T&R	Yes	NIPDAU	Level-1-260C-UNLIM	-40 to 85	2022I
<a href="#">TLE2022IP</a>	Active	Production	PDIP (P)   8	50   TUBE	Yes	NIPDAU	N/A for Pkg Type	-	TLE2022IP
<a href="#">TLE2022IP.A</a>	Active	Production	PDIP (P)   8	50   TUBE	Yes	NIPDAU	N/A for Pkg Type	-40 to 85	TLE2022IP
<a href="#">TLE2022IPE4</a>	Active	Production	PDIP (P)   8	50   TUBE	Yes	NIPDAU	N/A for Pkg Type	See TLE2022IP	TLE2022IP
<a href="#">TLE2022MD</a>	Obsolete	Production	SOIC (D)   8	-	-	Call TI	Call TI	-55 to 125	2022M
<a href="#">TLE2022MDR</a>	Active	Production	SOIC (D)   8	2500   LARGE T&R	Yes	NIPDAU	Level-1-260C-UNLIM	-55 to 125	2022M
<a href="#">TLE2022MDR.A</a>	Active	Production	SOIC (D)   8	2500   LARGE T&R	Yes	NIPDAU	Level-1-260C-UNLIM	-55 to 125	2022M
<a href="#">TLE2022MDRG4</a>	Active	Production	SOIC (D)   8	2500   LARGE T&R	Yes	NIPDAU	Level-1-260C-UNLIM	-	2022M
<a href="#">TLE2022MDRG4.A</a>	Active	Production	SOIC (D)   8	2500   LARGE T&R	Yes	NIPDAU	Level-1-260C-UNLIM	-55 to 125	2022M
<a href="#">TLE2024ACDW</a>	Obsolete	Production	SOIC (DW)   16	-	-	Call TI	Call TI	-	TLE2024AC
<a href="#">TLE2024ACDWR</a>	Active	Production	SOIC (DW)   16	2000   LARGE T&R	Yes	NIPDAU	Level-1-260C-UNLIM	-	TLE2024AC

Orderable part number	Status (1)	Material type (2)	Package   Pins	Package qty   Carrier	RoHS (3)	Lead finish/ Ball material (4)	MSL rating/ Peak reflow (5)	Op temp (°C)	Part marking (6)
TLE2024ACDWR.A	Active	Production	SOIC (DW)   16	2000   LARGE T&R	Yes	NIPDAU	Level-1-260C-UNLIM	-40 to 85	TLE2024AC
<a href="#">TLE2024ACN</a>	Active	Production	PDIP (N)   14	25   TUBE	Yes	NIPDAU	N/A for Pkg Type	-	TLE2024ACN
TLE2024ACN.A	Active	Production	PDIP (N)   14	25   TUBE	Yes	NIPDAU	N/A for Pkg Type	-40 to 85	TLE2024ACN
<a href="#">TLE2024AIDW</a>	Active	Production	SOIC (DW)   16	40   TUBE	Yes	NIPDAU	Level-1-260C-UNLIM	-40 to 85	TLE2024AI
TLE2024AIDW.A	Active	Production	SOIC (DW)   16	40   TUBE	Yes	NIPDAU	Level-1-260C-UNLIM	-40 to 85	TLE2024AI
<a href="#">TLE2024AIN</a>	Active	Production	PDIP (N)   14	25   TUBE	Yes	NIPDAU	N/A for Pkg Type	-	TLE2024AIN
TLE2024AIN.A	Active	Production	PDIP (N)   14	25   TUBE	Yes	NIPDAU	N/A for Pkg Type	-40 to 85	TLE2024AIN
<a href="#">TLE2024BMDW</a>	Obsolete	Production	SOIC (DW)   16	-	-	Call TI	Call TI	-55 to 125	
TLE2024BMDWG4	Obsolete	Production	SOIC (DW)   16	-	-	Call TI	Call TI	-55 to 125	TLE2024BM
<a href="#">TLE2024BMDWR</a>	Active	Production	SOIC (DW)   16	2000   LARGE T&R	Yes	Call TI	Call TI	-55 to 125	TLE2024BM
TLE2024BMDWR.A	Active	Production	SOIC (DW)   16	2000   LARGE T&R	Yes	Call TI	Call TI	-55 to 125	TLE2024BM
<a href="#">TLE2024CDW</a>	Obsolete	Production	SOIC (DW)   16	-	-	Call TI	Call TI	-	TLE2024C
<a href="#">TLE2024CDWR</a>	Active	Production	SOIC (DW)   16	2000   LARGE T&R	Yes	NIPDAU	Level-1-260C-UNLIM	-	TLE2024C
TLE2024CDWR.A	Active	Production	SOIC (DW)   16	2000   LARGE T&R	Yes	NIPDAU	Level-1-260C-UNLIM	See TLE2024CDWR	TLE2024C
<a href="#">TLE2024CN</a>	Active	Production	PDIP (N)   14	25   TUBE	Yes	NIPDAU	N/A for Pkg Type	-	TLE2024CN
TLE2024CN.A	Active	Production	PDIP (N)   14	25   TUBE	Yes	NIPDAU	N/A for Pkg Type	See TLE2024CN	TLE2024CN
TLE2024CNE4	Active	Production	PDIP (N)   14	25   TUBE	Yes	NIPDAU	N/A for Pkg Type	See TLE2024CN	TLE2024CN
<a href="#">TLE2024IDW</a>	Obsolete	Production	SOIC (DW)   16	-	-	Call TI	Call TI	-	TLE2024I
<a href="#">TLE2024IN</a>	Active	Production	PDIP (N)   14	25   TUBE	Yes	NIPDAU	N/A for Pkg Type	-	TLE2024IN
TLE2024IN.A	Active	Production	PDIP (N)   14	25   TUBE	Yes	NIPDAU	N/A for Pkg Type	See TLE2024IN	TLE2024IN

(1) **Status:** For more details on status, see our [product life cycle](#).

(2) **Material type:** When designated, preproduction parts are prototypes/experimental devices, and are not yet approved or released for full production. Testing and final process, including without limitation quality assurance, reliability performance testing, and/or process qualification, may not yet be complete, and this item is subject to further changes or possible discontinuation. If available for ordering, purchases will be subject to an additional waiver at checkout, and are intended for early internal evaluation purposes only. These items are sold without warranties of any kind.

(3) **RoHS values:** Yes, No, RoHS Exempt. See the [TI RoHS Statement](#) for additional information and value definition.

(4) **Lead finish/Ball material:** Parts may have multiple material finish options. Finish options are separated by a vertical ruled line. Lead finish/Ball material values may wrap to two lines if the finish value exceeds the maximum column width.

(5) **MSL rating/Peak reflow:** The moisture sensitivity level ratings and peak solder (reflow) temperatures. In the event that a part has multiple moisture sensitivity ratings, only the lowest level per JEDEC standards is shown. Refer to the shipping label for the actual reflow temperature that will be used to mount the part to the printed circuit board.

(6) **Part marking:** There may be an additional marking, which relates to the logo, the lot trace code information, or the environmental category of the part.

Multiple part markings will be inside parentheses. Only one part marking contained in parentheses and separated by a "~" will appear on a part. If a line is indented then it is a continuation of the previous line and the two combined represent the entire part marking for that device.

**Important Information and Disclaimer:**The information provided on this page represents TI's knowledge and belief as of the date that it is provided. TI bases its knowledge and belief on information provided by third parties, and makes no representation or warranty as to the accuracy of such information. Efforts are underway to better integrate information from third parties. TI has taken and continues to take reasonable steps to provide representative and accurate information but may not have conducted destructive testing or chemical analysis on incoming materials and chemicals. TI and TI suppliers consider certain information to be proprietary, and thus CAS numbers and other limited information may not be available for release.

In no event shall TI's liability arising out of such information exceed the total purchase price of the TI part(s) at issue in this document sold by TI to Customer on an annual basis.

**OTHER QUALIFIED VERSIONS OF TLE2021, TLE2021A, TLE2021M, TLE2022, TLE2022A, TLE2022AM, TLE2022M, TLE2024, TLE2024A, TLE2024B, TLE2024BM :**

- Catalog : [TLE2021](#), [TLE2022A](#), [TLE2022](#), [TLE2024B](#)
- Automotive : [TLE2021-Q1](#), [TLE2021A-Q1](#), [TLE2021-Q1](#), [TLE2022-Q1](#), [TLE2022A-Q1](#), [TLE2022A-Q1](#), [TLE2022-Q1](#), [TLE2024-Q1](#)
- Enhanced Product : [TLE2021-EP](#), [TLE2021A-EP](#), [TLE2021-EP](#), [TLE2022-EP](#), [TLE2022A-EP](#), [TLE2022A-EP](#), [TLE2022-EP](#), [TLE2024-EP](#), [TLE2024A-EP](#)
- Military : [TLE2021M](#), [TLE2021AM](#), [TLE2022M](#), [TLE2022AM](#), [TLE2024M](#), [TLE2024AM](#), [TLE2024BM](#)

NOTE: Qualified Version Definitions:

- Catalog - TI's standard catalog product
- Automotive - Q100 devices qualified for high-reliability automotive applications targeting zero defects
- Enhanced Product - Supports Defense, Aerospace and Medical Applications
- Military - QML certified for Military and Defense Applications

**TAPE AND REEL INFORMATION**

**QUADRANT ASSIGNMENTS FOR PIN 1 ORIENTATION IN TAPE**

\*All dimensions are nominal

Device	Package Type	Package Drawing	Pins	SPQ	Reel Diameter (mm)	Reel Width W1 (mm)	A0 (mm)	B0 (mm)	K0 (mm)	P1 (mm)	W (mm)	Pin1 Quadrant
TLE2021ACDR	SOIC	D	8	2500	330.0	12.4	6.4	5.2	2.1	8.0	12.0	Q1
TLE2021AIDR	SOIC	D	8	2500	330.0	12.4	6.4	5.2	2.1	8.0	12.0	Q1
TLE2021CDR	SOIC	D	8	2500	330.0	12.4	6.4	5.2	2.1	8.0	12.0	Q1
TLE2021IDR	SOIC	D	8	2500	330.0	12.4	6.4	5.2	2.1	8.0	12.0	Q1
TLE2022ACDR	SOIC	D	8	2500	330.0	12.4	6.4	5.2	2.1	8.0	12.0	Q1
TLE2022AIDR	SOIC	D	8	2500	330.0	12.4	6.4	5.2	2.1	8.0	12.0	Q1
TLE2022AMDR	SOIC	D	8	2500	330.0	12.4	6.4	5.2	2.1	8.0	12.0	Q1
TLE2022AMDRG4	SOIC	D	8	2500	330.0	12.5	6.4	5.2	2.1	8.0	12.0	Q1
TLE2022CDR	SOIC	D	8	2500	330.0	12.4	6.4	5.2	2.1	8.0	12.0	Q1
TLE2022IDR	SOIC	D	8	2500	330.0	12.4	6.4	5.2	2.1	8.0	12.0	Q1
TLE2022MDR	SOIC	D	8	2500	330.0	12.4	6.4	5.2	2.1	8.0	12.0	Q1
TLE2024ACDWR	SOIC	DW	16	2000	330.0	16.4	10.75	10.7	2.7	12.0	16.0	Q1
TLE2024CDWR	SOIC	DW	16	2000	330.0	16.4	10.75	10.7	2.7	12.0	16.0	Q1

**TAPE AND REEL BOX DIMENSIONS**

\*All dimensions are nominal

Device	Package Type	Package Drawing	Pins	SPQ	Length (mm)	Width (mm)	Height (mm)
TLE2021ACDR	SOIC	D	8	2500	353.0	353.0	32.0
TLE2021AIDR	SOIC	D	8	2500	353.0	353.0	32.0
TLE2021CDR	SOIC	D	8	2500	340.5	338.1	20.6
TLE2021IDR	SOIC	D	8	2500	353.0	353.0	32.0
TLE2022ACDR	SOIC	D	8	2500	353.0	353.0	32.0
TLE2022AIDR	SOIC	D	8	2500	353.0	353.0	32.0
TLE2022AMDR	SOIC	D	8	2500	350.0	350.0	43.0
TLE2022AMDRG4	SOIC	D	8	2500	353.0	353.0	32.0
TLE2022CDR	SOIC	D	8	2500	353.0	353.0	32.0
TLE2022IDR	SOIC	D	8	2500	353.0	353.0	32.0
TLE2022MDR	SOIC	D	8	2500	350.0	350.0	43.0
TLE2024ACDWR	SOIC	DW	16	2000	350.0	350.0	43.0
TLE2024CDWR	SOIC	DW	16	2000	350.0	350.0	43.0

**TUBE**

\*All dimensions are nominal

Device	Package Name	Package Type	Pins	SPQ	L (mm)	W (mm)	T (µm)	B (mm)
TLE2021ACP	P	PDIP	8	50	506	13.97	11230	4.32
TLE2021ACP.A	P	PDIP	8	50	506	13.97	11230	4.32
TLE2021AIP	P	PDIP	8	50	506	13.97	11230	4.32
TLE2021AIP.A	P	PDIP	8	50	506	13.97	11230	4.32
TLE2021CP	P	PDIP	8	50	506	13.97	11230	4.32
TLE2021CP.A	P	PDIP	8	50	506	13.97	11230	4.32
TLE2021CPE4	P	PDIP	8	50	506	13.97	11230	4.32
TLE2021IP	P	PDIP	8	50	506	13.97	11230	4.32
TLE2021IP.A	P	PDIP	8	50	506	13.97	11230	4.32
TLE2021MD	D	SOIC	8	75	505.46	6.76	3810	4
TLE2021MD.A	D	SOIC	8	75	505.46	6.76	3810	4
TLE2021MDG4	D	SOIC	8	75	505.46	6.76	3810	4
TLE2021MDG4.A	D	SOIC	8	75	505.46	6.76	3810	4
TLE2022ACP	P	PDIP	8	50	506	13.97	11230	4.32
TLE2022ACP.A	P	PDIP	8	50	506	13.97	11230	4.32
TLE2022AIP	P	PDIP	8	50	506	13.97	11230	4.32
TLE2022AIP.A	P	PDIP	8	50	506	13.97	11230	4.32
TLE2022AMDG4	D	SOIC	8	75	505.46	6.76	3810	4
TLE2022AMDG4.A	D	SOIC	8	75	505.46	6.76	3810	4
TLE2022CP	P	PDIP	8	50	506	13.97	11230	4.32
TLE2022CP.A	P	PDIP	8	50	506	13.97	11230	4.32
TLE2022CPE4	P	PDIP	8	50	506	13.97	11230	4.32
TLE2022IP	P	PDIP	8	50	506	13.97	11230	4.32
TLE2022IP.A	P	PDIP	8	50	506	13.97	11230	4.32
TLE2022IPE4	P	PDIP	8	50	506	13.97	11230	4.32
TLE2024ACN	N	PDIP	14	25	506	13.97	11230	4.32
TLE2024ACN.A	N	PDIP	14	25	506	13.97	11230	4.32
TLE2024AIDW	DW	SOIC	16	40	506.98	12.7	4826	6.6
TLE2024AIDW.A	DW	SOIC	16	40	506.98	12.7	4826	6.6

---

Device	Package Name	Package Type	Pins	SPQ	L (mm)	W (mm)	T (µm)	B (mm)
TLE2024AIN	N	PDIP	14	25	506	13.97	11230	4.32
TLE2024AIN.A	N	PDIP	14	25	506	13.97	11230	4.32
TLE2024CN	N	PDIP	14	25	506	13.97	11230	4.32
TLE2024CN.A	N	PDIP	14	25	506	13.97	11230	4.32
TLE2024CNE4	N	PDIP	14	25	506	13.97	11230	4.32
TLE2024IN	N	PDIP	14	25	506	13.97	11230	4.32
TLE2024IN.A	N	PDIP	14	25	506	13.97	11230	4.32

## GENERIC PACKAGE VIEW

**DW 16**

**SOIC - 2.65 mm max height**

7.5 x 10.3, 1.27 mm pitch

SMALL OUTLINE INTEGRATED CIRCUIT

This image is a representation of the package family, actual package may vary.  
Refer to the product data sheet for package details.



4224780/A





# DW0016A

# PACKAGE OUTLINE SOIC - 2.65 mm max height

SOIC

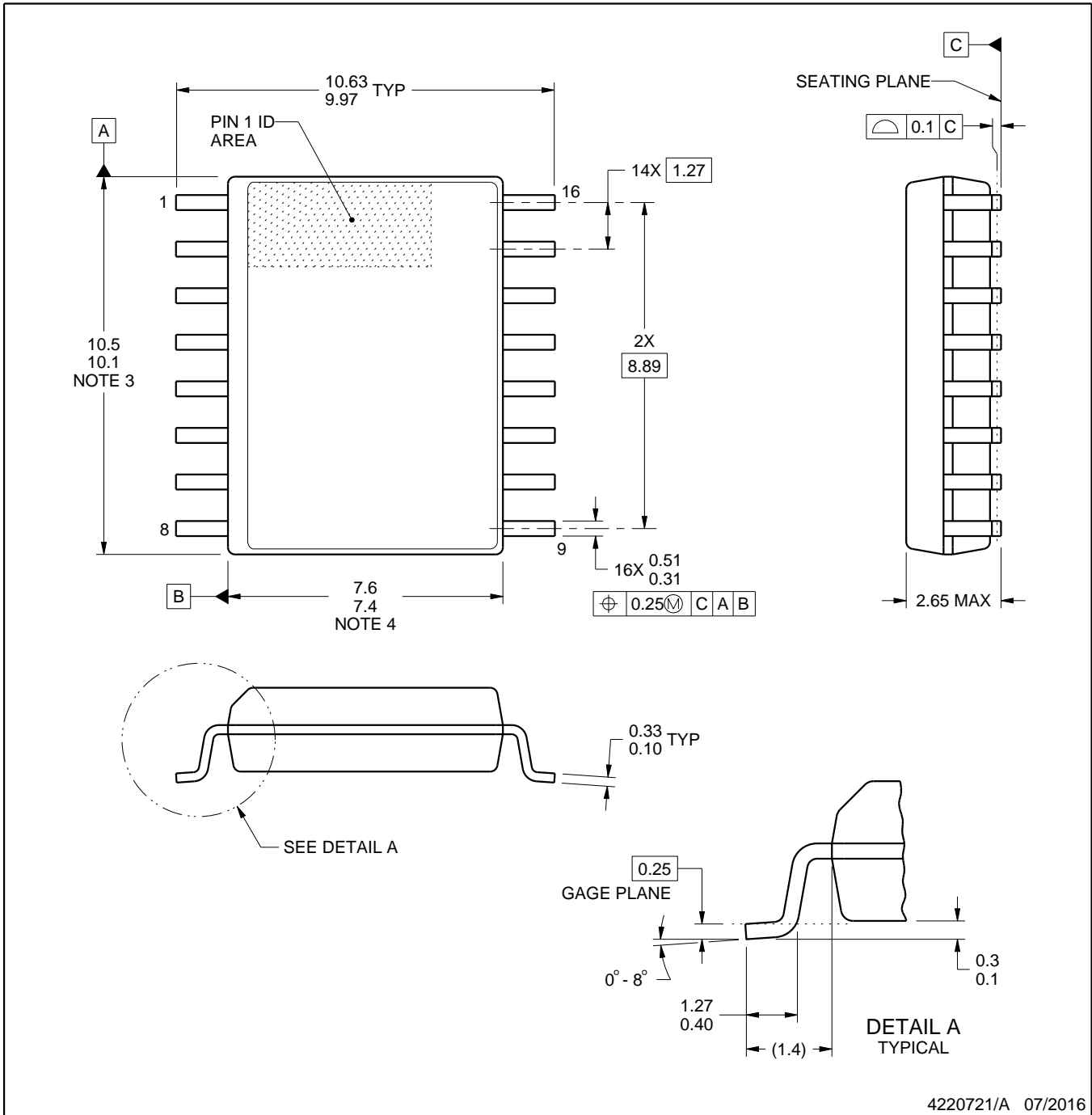

4220721/A 07/2016

### NOTES:

1. All linear dimensions are in millimeters. Dimensions in parenthesis are for reference only. Dimensioning and tolerancing per ASME Y14.5M.
2. This drawing is subject to change without notice.
3. This dimension does not include mold flash, protrusions, or gate burrs. Mold flash, protrusions, or gate burrs shall not exceed 0.15 mm, per side.
4. This dimension does not include interlead flash. Interlead flash shall not exceed 0.25 mm, per side.
5. Reference JEDEC registration MS-013.

# EXAMPLE BOARD LAYOUT

DW0016A

SOIC - 2.65 mm max height

SOIC

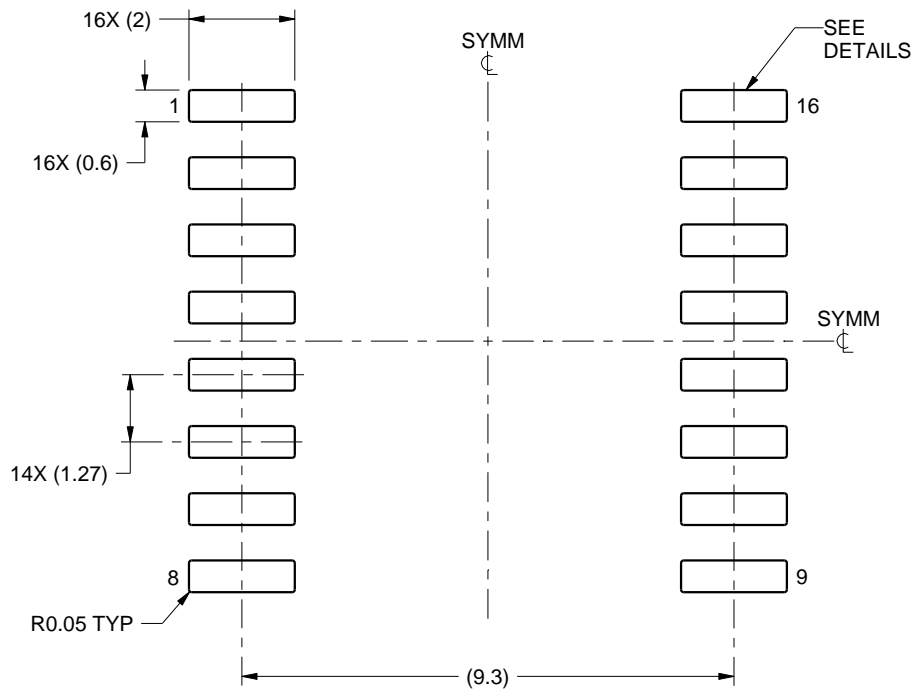

LAND PATTERN EXAMPLE  
SCALE:7X



SOLDER MASK DETAILS

4220721/A 07/2016

NOTES: (continued)

6. Publication IPC-7351 may have alternate designs.

7. Solder mask tolerances between and around signal pads can vary based on board fabrication site.

# EXAMPLE STENCIL DESIGN

DW0016A

SOIC - 2.65 mm max height

SOIC



SOLDER PASTE EXAMPLE  
BASED ON 0.125 mm THICK STENCIL  
SCALE:7X

4220721/A 07/2016

NOTES: (continued)

8. Laser cutting apertures with trapezoidal walls and rounded corners may offer better paste release. IPC-7525 may have alternate design recommendations.
9. Board assembly site may have different recommendations for stencil design.



D0008A

# PACKAGE OUTLINE

SOIC - 1.75 mm max height

SMALL OUTLINE INTEGRATED CIRCUIT



4214825/C 02/2019

NOTES:

- Linear dimensions are in inches [millimeters]. Dimensions in parenthesis are for reference only. Controlling dimensions are in inches. Dimensioning and tolerancing per ASME Y14.5M.
- This drawing is subject to change without notice.
- This dimension does not include mold flash, protrusions, or gate burrs. Mold flash, protrusions, or gate burrs shall not exceed  $.006$  [0.15] per side.
- This dimension does not include interlead flash.
- Reference JEDEC registration MS-012, variation AA.

# EXAMPLE BOARD LAYOUT

D0008A

SOIC - 1.75 mm max height

SMALL OUTLINE INTEGRATED CIRCUIT



LAND PATTERN EXAMPLE  
 EXPOSED METAL SHOWN  
 SCALE:8X



SOLDER MASK DETAILS

4214825/C 02/2019

NOTES: (continued)

- 6. Publication IPC-7351 may have alternate designs.
- 7. Solder mask tolerances between and around signal pads can vary based on board fabrication site.

# EXAMPLE STENCIL DESIGN

D0008A

SOIC - 1.75 mm max height

SMALL OUTLINE INTEGRATED CIRCUIT



SOLDER PASTE EXAMPLE  
BASED ON .005 INCH [0.125 MM] THICK STENCIL  
SCALE:8X

4214825/C 02/2019

NOTES: (continued)

8. Laser cutting apertures with trapezoidal walls and rounded corners may offer better paste release. IPC-7525 may have alternate design recommendations.
9. Board assembly site may have different recommendations for stencil design.

P (R-PDIP-T8)

PLASTIC DUAL-IN-LINE PACKAGE



4040082/E 04/2010

- NOTES:
- A. All linear dimensions are in inches (millimeters).
  - B. This drawing is subject to change without notice.
  - C. Falls within JEDEC MS-001 variation BA.

N (R-PDIP-T\*\*)

PLASTIC DUAL-IN-LINE PACKAGE

16 PINS SHOWN



- NOTES:
- A. All linear dimensions are in inches (millimeters).
  - B. This drawing is subject to change without notice.
  - Falls within JEDEC MS-001, except 18 and 20 pin minimum body length (Dim A).
  - The 20 pin end lead shoulder width is a vendor option, either half or full width.



## IMPORTANT NOTICE AND DISCLAIMER

TI PROVIDES TECHNICAL AND RELIABILITY DATA (INCLUDING DATASHEETS), DESIGN RESOURCES (INCLUDING REFERENCE DESIGNS), APPLICATION OR OTHER DESIGN ADVICE, WEB TOOLS, SAFETY INFORMATION, AND OTHER RESOURCES "AS IS" AND WITH ALL FAULTS, AND DISCLAIMS ALL WARRANTIES, EXPRESS AND IMPLIED, INCLUDING WITHOUT LIMITATION ANY IMPLIED WARRANTIES OF MERCHANTABILITY, FITNESS FOR A PARTICULAR PURPOSE OR NON-INFRINGEMENT OF THIRD PARTY INTELLECTUAL PROPERTY RIGHTS.

These resources are intended for skilled developers designing with TI products. You are solely responsible for (1) selecting the appropriate TI products for your application, (2) designing, validating and testing your application, and (3) ensuring your application meets applicable standards, and any other safety, security, regulatory or other requirements.

These resources are subject to change without notice. TI grants you permission to use these resources only for development of an application that uses the TI products described in the resource. Other reproduction and display of these resources is prohibited. No license is granted to any other TI intellectual property right or to any third party intellectual property right. TI disclaims responsibility for, and you fully indemnify TI and its representatives against any claims, damages, costs, losses, and liabilities arising out of your use of these resources.

TI's products are provided subject to [TI's Terms of Sale](#), [TI's General Quality Guidelines](#), or other applicable terms available either on [ti.com](http://ti.com) or provided in conjunction with such TI products. TI's provision of these resources does not expand or otherwise alter TI's applicable warranties or warranty disclaimers for TI products. Unless TI explicitly designates a product as custom or customer-specified, TI products are standard, catalog, general purpose devices.

TI objects to and rejects any additional or different terms you may propose.

Copyright © 2026, Texas Instruments Incorporated

Last updated 10/2025