

OPA858-Q1 5.5-GHz Gain Bandwidth Product, Gain of 7-V/V Stable, FET Input Amplifier

1 Features

- AEC-Q100 Qualified for Automotive Applications:
 - Temperature grade 1: -40°C to $+125^{\circ}\text{C}$, T_A
- High Gain Bandwidth Product: 5.5 GHz
- Decompensated, Gain ≥ 7 V/V (Stable)
- Ultra-Low Bias Current MOSFET Inputs: 10 pA
- Low Input Voltage Noise: 2.5 nV/ $\sqrt{\text{Hz}}$
- Slew rate: 2000 V/ μs
- Low Input Capacitance:
 - Common-Mode: 0.6 pF
 - Differential: 0.2 pF
- Wide Input Common-Mode Range:
 - 1.4 V from Positive Supply
 - Includes Negative Supply
- 2.5 V_{PP} Output Swing in TIA Configuration
- Supply Voltage Range: 3.3 V to 5.25 V
- Quiescent Current: 20.5 mA
- Package: 8-Pin WSON
- Temperature Range: -40°C to $+125^{\circ}\text{C}$

2 Applications

- [Automotive LIDAR](#)
- [Time of flight \(ToF\) Camera](#)
- [Optical Time Domain Reflectometry \(OTDR\)](#)
- [3D Scanner](#)
- [Laser Distance Measurement](#)
- [Solid-State Scanning LIDAR](#)
- [Optical ToF Position Sensor](#)
- [Drone Vision](#)
- [Silicon Photomultiplier \(SiPM\) Buffer Amplifier](#)
- [Photomultiplier Tube Post Amplifier](#)

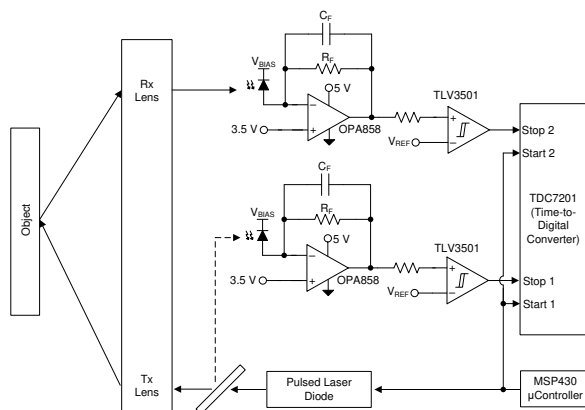

High-Speed Time-of-Flight Receiver

3 Description

The OPA858-Q1 is a wideband, low-noise operational amplifier with CMOS inputs for wideband transimpedance and voltage amplifier applications. When the device is configured as a transimpedance amplifier (TIA), the 5.5-GHz gain bandwidth product (GBWP) enables high closed-loop bandwidths at transimpedance gains in the range of tens to hundreds of k Ω s.

The graph below shows the bandwidth and noise performance of the OPA858-Q1 as a function of the photodiode capacitance when the amplifier is configured as a TIA. The total noise is calculated along a bandwidth range extending from DC to the calculated frequency (f) on the left scale. The OPA858-Q1 package has a feedback pin (FB) that simplifies the feedback network connection between the input and the output.

The OPA858-Q1 is optimized to operate in optical time-of-flight (ToF) systems where the OPA858-Q1 is used with time-to-digital converters, such as the [TDC7201](#). Use the OPA858-Q1 to drive a high-speed analog-to-digital converter (ADC) in high-resolution LIDAR systems with a differential output amplifier, such as the [THS4541-Q1](#).

Device Information

PART NUMBER ⁽¹⁾	PACKAGE	BODY SIZE (NOM)
OPA858-Q1	WSON (8)	2.00 mm \times 2.00 mm

- (1) For all available packages, see the package option addendum at the end of the data sheet.

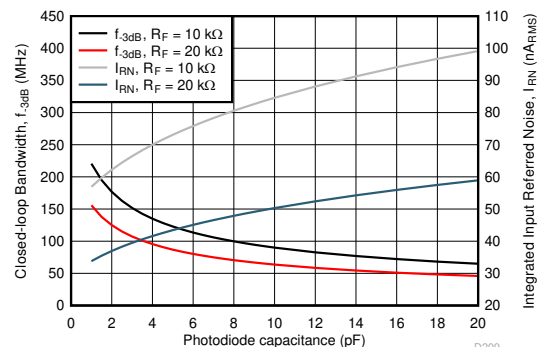

Photodiode Capacitance vs Bandwidth and Noise



Table of Contents

1 Features	1	9 Application and Implementation	21
2 Applications	1	9.1 Application Information.....	21
3 Description	1	9.2 Typical Application.....	22
4 Revision History	2	10 Power Supply Recommendations	25
5 Pin Configuration and Functions	4	11 Layout	26
6 Specifications	5	11.1 Layout Guidelines.....	26
6.1 Absolute Maximum Ratings	5	11.2 Layout Example.....	26
6.2 ESD Ratings	5	12 Device and Documentation Support	28
6.3 Recommended Operating Conditions	5	12.1 Device Support.....	28
6.4 Thermal Information	5	12.2 Documentation Support.....	28
6.5 Electrical Characteristics	6	12.3 Receiving Notification of Documentation Updates..	28
6.6 Typical Characteristics.....	8	12.4 Support Resources.....	28
7 Parameter Measurement Information	15	12.5 Trademarks.....	28
8 Detailed Description	16	12.6 Electrostatic Discharge Caution.....	28
8.1 Overview.....	16	12.7 Glossary.....	28
8.2 Functional Block Diagram.....	16	13 Mechanical, Packaging, and Orderable	
8.3 Feature Description.....	17	Information	28
8.4 Device Functional Modes.....	20		

4 Revision History

NOTE: Page numbers for previous revisions may differ from page numbers in the current version.

DATE	REVISION	NOTES
February 2021	*	Initial Release

Device Comparison Table

DEVICE	INPUT TYPE	MINIMUM STABLE GAIN	VOLTAGE NOISE (nV/\sqrt{Hz})	INPUT CAPACITANCE (pF)	GAIN BANDWIDTH (GHz)
OPA855-Q1	Bipolar	7 V/V	0.98	0.8	8
OPA858-Q1	CMOS	7 V/V	2.5	0.8	5.5
OPA859-Q1	CMOS	1 V/V	3.3	0.8	0.9

5 Pin Configuration and Functions

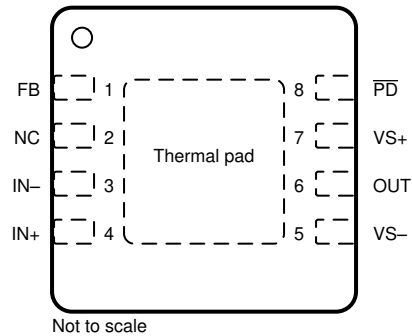

**Figure 5-1. DSG Package
8-Pin WSON With Exposed Thermal Pad
Top View**

Table 5-1. Pin Functions

PIN		I/O	DESCRIPTION
NAME	NO.		
FB	1	I	Feedback connection to output of amplifier
IN-	3	I	Inverting input
IN+	4	I	Noninverting input
NC	2	—	Do not connect
OUT	6	O	Amplifier output
PD	8	I	Power down connection. \overline{PD} = logic low = power off mode; \overline{PD} = logic high = normal operation.
VS-	5	—	Negative voltage supply
VS+	7	—	Positive voltage supply
Thermal pad		—	Connect the thermal pad to VS-

6 Specifications

6.1 Absolute Maximum Ratings

over operating free-air temperature range (unless otherwise noted)⁽¹⁾

		MIN	MAX	UNIT
V_S	Total supply voltage ($V_{S+} - V_{S-}$)		5.5	V
V_{IN+}, V_{IN-}	Input voltage	$(V_{S-}) - 0.5$	$(V_{S+}) + 0.5$	V
V_{ID}	Differential input voltage		1	V
V_{OUT}	Output voltage	$(V_{S-}) - 0.5$	$(V_{S+}) + 0.5$	V
I_{IN}	Continuous input current		± 10	mA
I_{OUT}	Continuous output current ⁽²⁾		± 100	mA
T_J	Junction temperature		150	°C
T_A	Operating free-air temperature	-40	125	°C
T_{stg}	Storage temperature	-65	150	°C

- (1) Stresses beyond those listed under *Absolute Maximum Rating* may cause permanent damage to the device. These are stress ratings only, which do not imply functional operation of the device at these or any other conditions beyond those indicated under *Recommended Operating Condition*. Exposure to absolute-maximum-rated conditions for extended periods may affect device reliability.
- (2) Long-term continuous output current for electromigration limits.

6.2 ESD Ratings

			VALUE	UNIT
$V_{(ESD)}$	Electrostatic discharge	Human-body model (HBM), per AEC Q100-002 ⁽¹⁾	± 1500	V
		Charged-device model (CDM), per AEC Q100-011	± 1000	

- (1) AEC Q100-002 indicates that HBM stressing shall be in accordance with the ANSI/ESDA/JEDEC JS-001 specification.

6.3 Recommended Operating Conditions

over operating free-air temperature range (unless otherwise noted)

		MIN	NOM	MAX	UNIT
V_S	Total supply voltage ($V_{S+} - V_{S-}$)	3.3	5	5.25	V
T_A	Operating free-air temperature	-40		125	°C

6.4 Thermal Information

THERMAL METRIC ⁽¹⁾		OPA858-Q1	UNIT
		DSG (WSON)	
		8 PINS	
$R_{\theta JA}$	Junction-to-ambient thermal resistance	80.1	°C/W
$R_{\theta JC(top)}$	Junction-to-case (top) thermal resistance	100	°C/W
$R_{\theta JB}$	Junction-to-board thermal resistance	45	°C/W
Ψ_{JT}	Junction-to-top characterization parameter	6.8	°C/W
Ψ_{JB}	Junction-to-board characterization parameter	45.2	°C/W
$R_{\theta JC(bot)}$	Junction-to-case (bottom) thermal resistance	22.7	°C/W

- (1) For more information about traditional and new thermal metrics, see the [Semiconductor and IC Package Thermal Metrics](#) application report.

6.5 Electrical Characteristics

$V_{S+} = 5\text{ V}$, $V_{S-} = 0\text{ V}$, $G = 7\text{ V/V}$, $R_F = 453\ \Omega$, input common-mode biased at midsupply, $R_L = 200\ \Omega$, output load is referenced to midsupply, and $T_A = 25^\circ\text{C}$ (unless otherwise noted)

PARAMETER		TEST CONDITIONS	MIN	TYP	MAX	UNIT
AC PERFORMANCE						
SSBW	Small-signal bandwidth	$V_{OUT} = 100\text{ mV}_{PP}$		1.2		GHz
LSBW	Large-signal bandwidth	$V_{OUT} = 2\text{ V}_{PP}$		600		MHz
GBWP	Gain-bandwidth product			5.5		GHz
	Bandwidth for 0.1-dB flatness			130		MHz
SR	Slew rate (10% - 90%)	$V_{OUT} = 2\text{-V step}$		2000		V/ μs
t_r	Rise time	$V_{OUT} = 100\text{-mV step}$		0.3		ns
t_f	Fall time	$V_{OUT} = 100\text{-mV step}$		0.3		ns
	Settling time to 0.1%	$V_{OUT} = 2\text{-V step}$		8		ns
	Settling time to 0.001%	$V_{OUT} = 2\text{-V step}$		3000		ns
	Overshoot or undershoot	$V_{OUT} = 2\text{-V step}$		7%		
	Overdrive recovery	2x output overdrive (0.1% recovery)		200		ns
HD2	Second-order harmonic distortion	$f = 10\text{ MHz}$, $V_{OUT} = 2\text{ V}_{PP}$		88		dBc
		$f = 100\text{ MHz}$, $V_{OUT} = 2\text{ V}_{PP}$		64		
HD3	Third-order harmonic distortion	$f = 10\text{ MHz}$, $V_{OUT} = 2\text{ V}_{PP}$		86		dBc
		$f = 100\text{ MHz}$, $V_{OUT} = 2\text{ V}_{PP}$		68		
e_n	Input-referred voltage noise	$f = 1\text{ MHz}$		2.5		nV/ $\sqrt{\text{Hz}}$
Z_{OUT}	Closed-loop output impedance	$f = 1\text{ MHz}$		0.15		Ω
DC PERFORMANCE						
A_{OL}	Open-loop voltage gain		72	75		dB
V_{OS}	Input offset voltage	$T_A = 25^\circ\text{C}$	-5	± 0.8	5	mV
$\Delta V_{OS}/\Delta T$	Input offset voltage drift	$T_A = -40^\circ\text{C to } +125^\circ\text{C}$		± 2		$\mu\text{V}/^\circ\text{C}$
I_{BN} , I_{BI}	Input bias current	$T_A = 25^\circ\text{C}$		± 0.4	5	μA
I_{BOS}	Input offset current	$T_A = 25^\circ\text{C}$		± 0.01	5	μA
CMRR	Common-mode rejection ratio	$V_{CM} = \pm 0.5\text{ V}$, referenced to midsupply	70	90		dB
INPUT						
	Common-mode input resistance			1		G Ω
C_{CM}	Common-mode input capacitance			0.62		pF
	Differential input resistance			1		G Ω
C_{DIFF}	Differential input capacitance			0.2		pF
V_{IH}	Common-mode input range (high)	CMRR > 66 dB, $V_{S+} = 3.3\text{ V}$	1.7	1.9		V
V_{IL}	Common-mode input range (low)	CMRR > 66 dB, $V_{S+} = 3.3\text{ V}$		0	0.4	V
V_{IH}	Common-mode input range (high)	CMRR > 66 dB	3.4	3.6		V
		$T_A = -40^\circ\text{C to } +125^\circ\text{C}$, CMRR > 66 dB		3.3		
V_{IL}	Common-mode input range (low)	CMRR > 66 dB		0	0.4	V
		$T_A = -40^\circ\text{C to } +125^\circ\text{C}$, CMRR > 66 dB		0.35		
OUTPUT						
V_{OH}	Output voltage (high)	$T_A = 25^\circ\text{C}$, $V_{S+} = 3.3\text{ V}$	2.3	2.4		V
V_{OH}	Output voltage (high)	$T_A = 25^\circ\text{C}$	3.95	4.1		V
		$T_A = -40^\circ\text{C to } +125^\circ\text{C}$		3.9		
V_{OL}	Output voltage (low)	$T_A = 25^\circ\text{C}$, $V_{S+} = 3.3\text{ V}$		1.05	1.15	V
V_{OL}	Output voltage (low)	$T_A = 25^\circ\text{C}$		1.05	1.15	V
		$T_A = -40^\circ\text{C to } +125^\circ\text{C}$		1.2		

6.5 Electrical Characteristics (continued)

$V_{S+} = 5\text{ V}$, $V_{S-} = 0\text{ V}$, $G = 7\text{ V/V}$, $R_F = 453\ \Omega$, input common-mode biased at midsupply, $R_L = 200\ \Omega$, output load is referenced to midsupply, and $T_A = 25^\circ\text{C}$ (unless otherwise noted)

PARAMETER		TEST CONDITIONS	MIN	TYP	MAX	UNIT
	Linear output drive (sink and source)	$R_L = 10\ \Omega$, $A_{OL} > 60\text{ dB}$	65	80		mA
		$T_A = -40^\circ\text{C}$ to $+125^\circ\text{C}$, $R_L = 10\ \Omega$, $A_{OL} > 60\text{ dB}$		64		
I_{SC}	Output short-circuit current		85	105		mA
POWER SUPPLY						
V_S	Operating voltage		3.3		5.25	V
I_Q	Quiescent current	$V_{S+} = 5\text{ V}$	18	20.5	24	mA
I_Q	Quiescent current	$V_{S+} = 3.3\text{ V}$	17.5	20	23.5	mA
I_Q	Quiescent current	$V_{S+} = 5.25\text{ V}$	18	21	24	mA
I_Q	Quiescent current	$T_A = 125^\circ\text{C}$		24.5		mA
I_Q	Quiescent current	$T_A = -40^\circ\text{C}$		18.5		mA
PSRR+	Positive power-supply rejection ratio		74	84		dB
PSRR-	Negative power-supply rejection ratio		70	80		
POWER DOWN						
	Disable voltage threshold	Amplifier OFF below this voltage	0.65	1		V
	Enable voltage threshold	Amplifier ON above this voltage		1.5	1.8	V
	Power-down quiescent current			70	140	μA
	$\overline{\text{PD}}$ bias current			70	200	μA
	Turnon time delay	Time to $V_{OUT} = 90\%$ of final value		13		ns
	Turnoff time delay			120		ns

6.6 Typical Characteristics

at $V_{S+} = 2.5\text{ V}$, $V_{S-} = -2.5\text{ V}$, $V_{IN+} = 0\text{ V}$, $R_F = 453\ \Omega$, Gain = 7 V/V, $R_L = 200\ \Omega$, output load referenced to midsupply, and $T_A = 25^\circ\text{C}$ (unless otherwise noted)

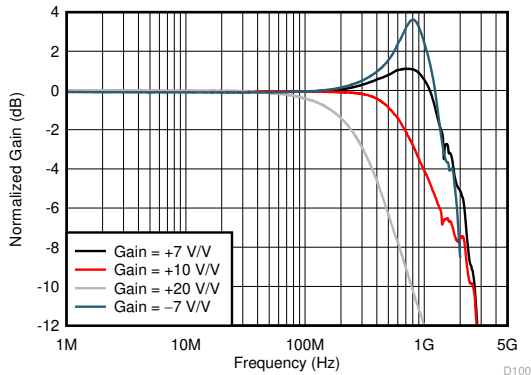

$V_{OUT} = 100\text{ mV}_{PP}$; see Figure 7-1 and Figure 7-2 for circuit configuration

Figure 6-1. Small-Signal Frequency Response vs Gain

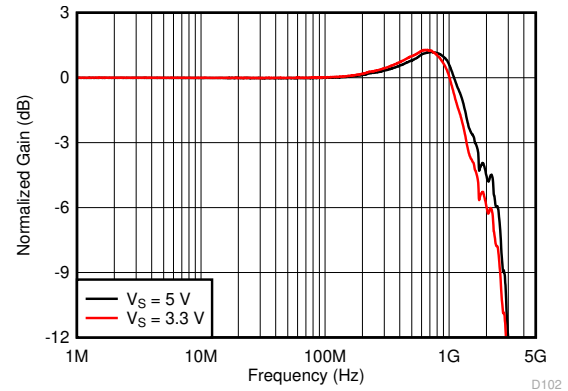

$V_{OUT} = 100\text{ mV}_{PP}$

Figure 6-2. Small-Signal Frequency Response vs Supply Voltage

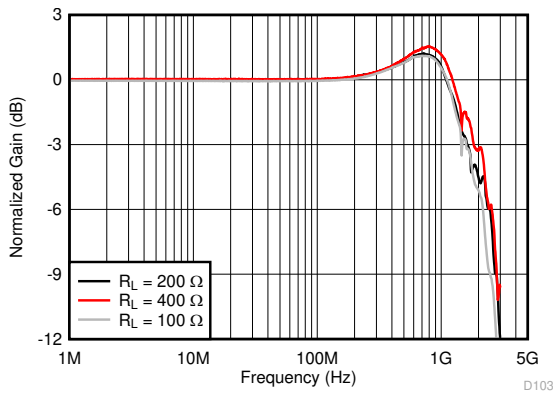

$V_{OUT} = 100\text{ mV}_{PP}$

Figure 6-3. Small-Signal Frequency Response vs Output Load

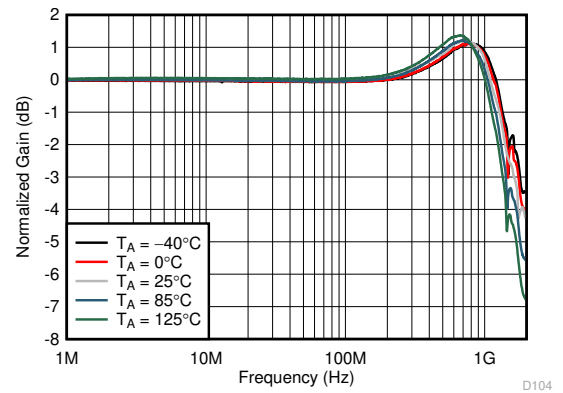

$V_{OUT} = 100\text{ mV}_{PP}$

Figure 6-4. Small-Signal Frequency Response vs Ambient Temperature

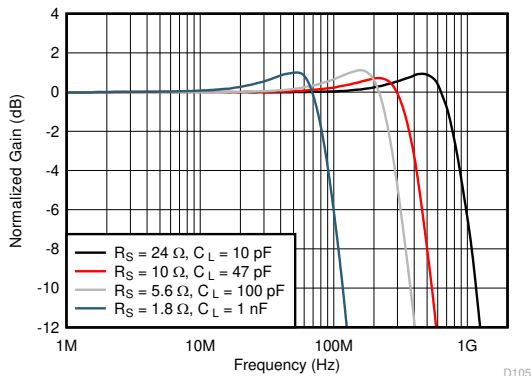

$V_{OUT} = 100\text{ mV}_{PP}$; see Figure 7-3 for circuit configuration

Figure 6-5. Small-Signal Frequency Response vs Capacitive Load

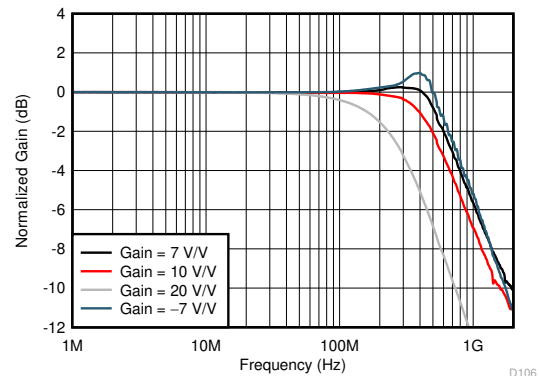

$V_{OUT} = 2\text{ V}_{PP}$

Figure 6-6. Large-Signal Frequency Response vs Gain

6.6 Typical Characteristics (continued)

at $V_{S+} = 2.5\text{ V}$, $V_{S-} = -2.5\text{ V}$, $V_{IN+} = 0\text{ V}$, $R_F = 453\ \Omega$, Gain = 7 V/V, $R_L = 200\ \Omega$, output load referenced to midsupply, and $T_A = 25^\circ\text{C}$ (unless otherwise noted)

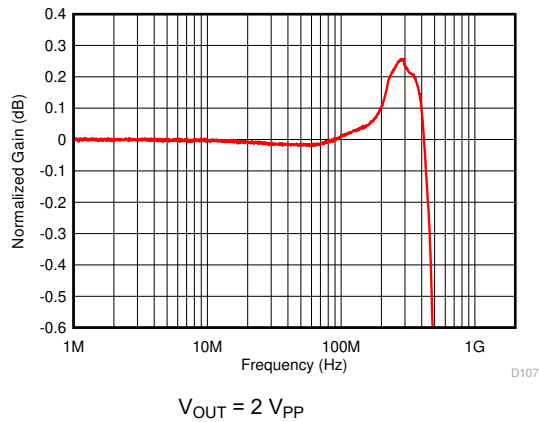

Figure 6-7. Large-Signal Response for 0.1-dB Gain Flatness

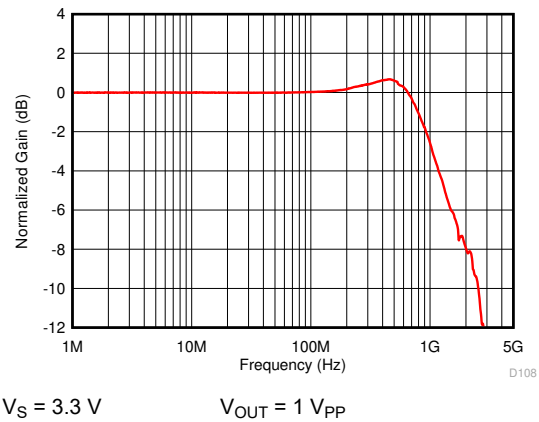

Figure 6-8. Large-Signal Frequency Response

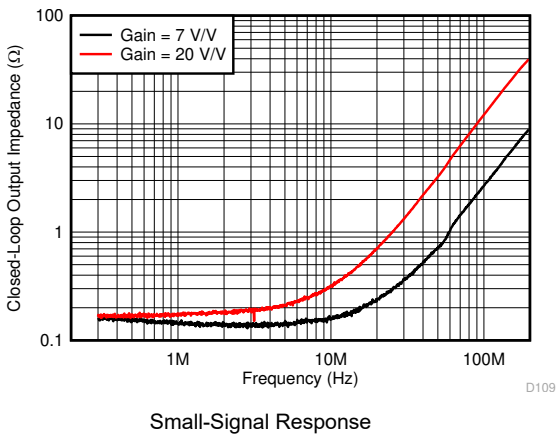

Figure 6-9. Closed-Loop Output Impedance vs Frequency

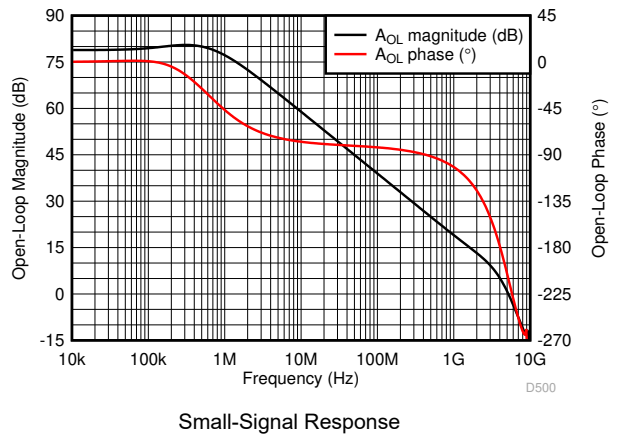

Figure 6-10. Open-Loop Magnitude and Phase vs Frequency

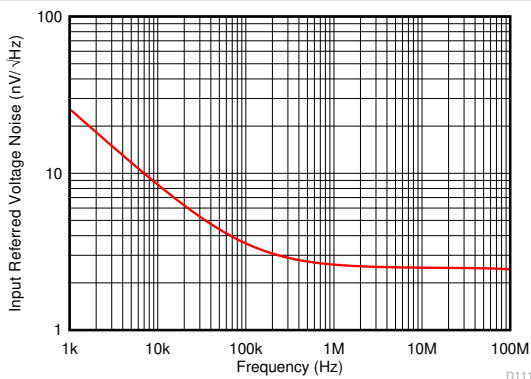

Figure 6-11. Voltage Noise Density vs Frequency

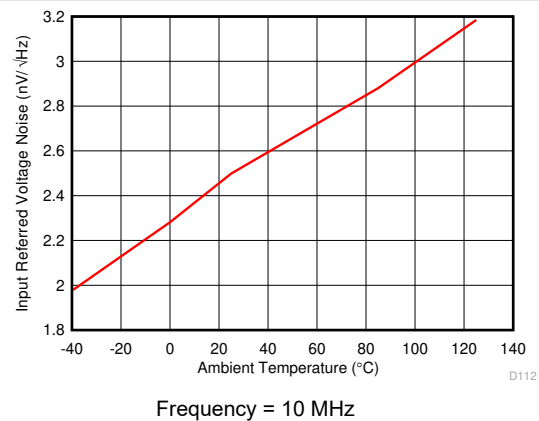

Figure 6-12. Voltage Noise Density vs Ambient Temperature

6.6 Typical Characteristics (continued)

at $V_{S+} = 2.5\text{ V}$, $V_{S-} = -2.5\text{ V}$, $V_{IN+} = 0\text{ V}$, $R_F = 453\ \Omega$, Gain = 7 V/V , $R_L = 200\ \Omega$, output load referenced to midsupply, and $T_A = 25^\circ\text{C}$ (unless otherwise noted)

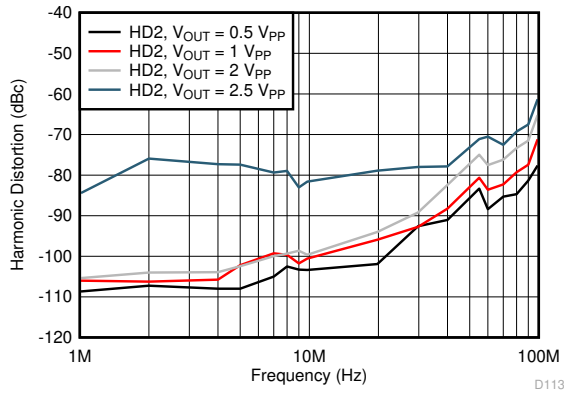

Figure 6-13. Harmonic Distortion (HD2) vs Output Swing

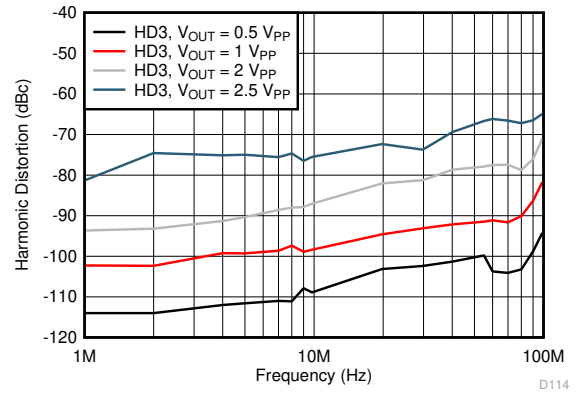

Figure 6-14. Harmonic Distortion (HD3) vs Output Swing

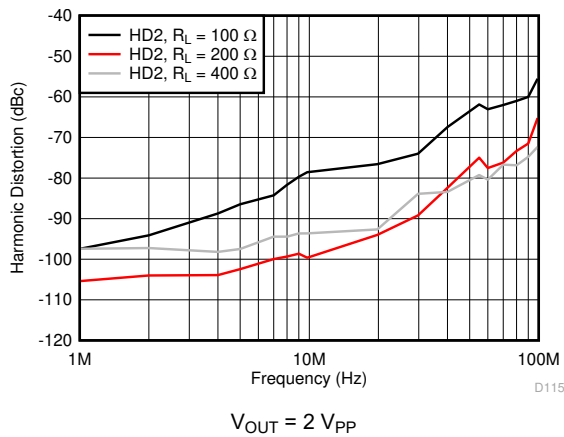

Figure 6-15. Harmonic Distortion (HD2) vs Output Load

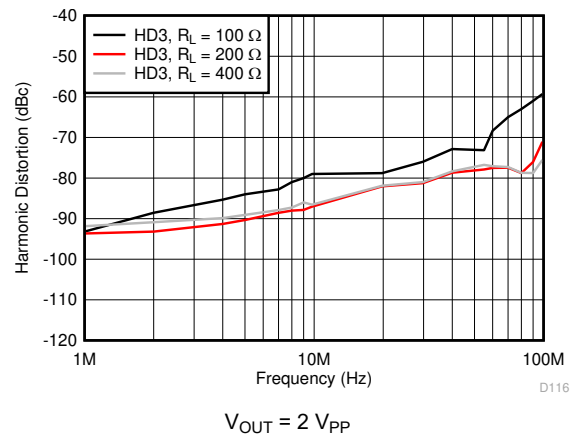

Figure 6-16. Harmonic Distortion (HD3) vs Output Load

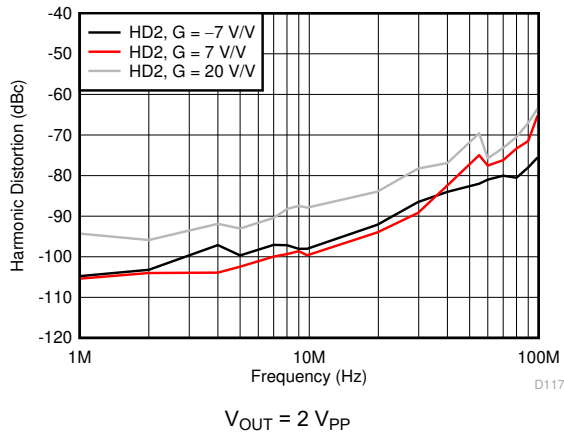

Figure 6-17. Harmonic Distortion (HD2) vs Gain

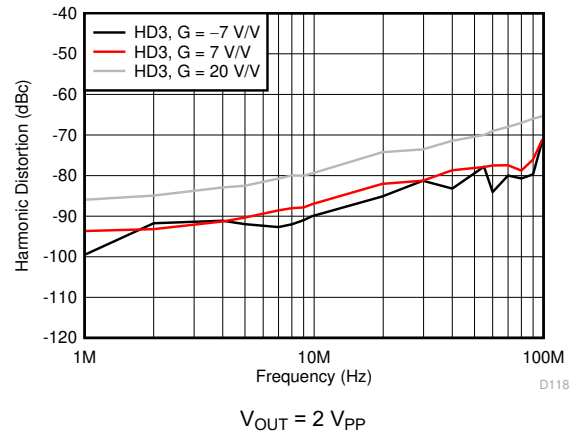
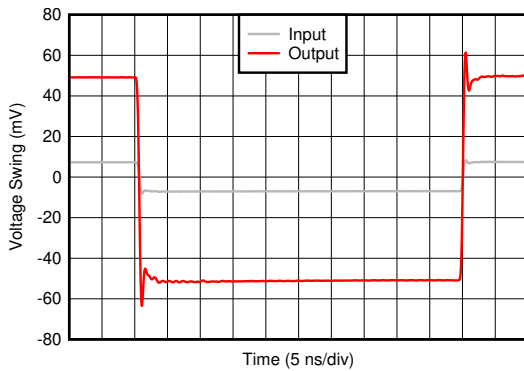

Figure 6-18. Harmonic Distortion (HD3) vs Gain

6.6 Typical Characteristics (continued)

at $V_{S+} = 2.5\text{ V}$, $V_{S-} = -2.5\text{ V}$, $V_{IN+} = 0\text{ V}$, $R_F = 453\ \Omega$, Gain = 7 V/V , $R_L = 200\ \Omega$, output load referenced to midsupply, and $T_A = 25^\circ\text{C}$ (unless otherwise noted)



D119

Average Rise and Fall Time (10% - 90%) = 450 ps

Figure 6-19. Small-Signal Transient Response

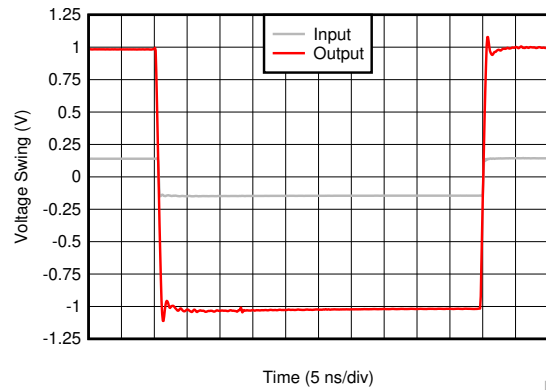

D120

Average Rise and Fall Time (10% - 90%) = 750 ps

Figure 6-20. Large-Signal Transient Response

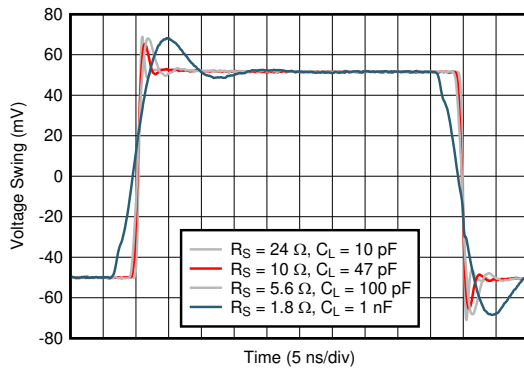

D121

Figure 6-21. Small-Signal Transient Response vs Capacitive Load

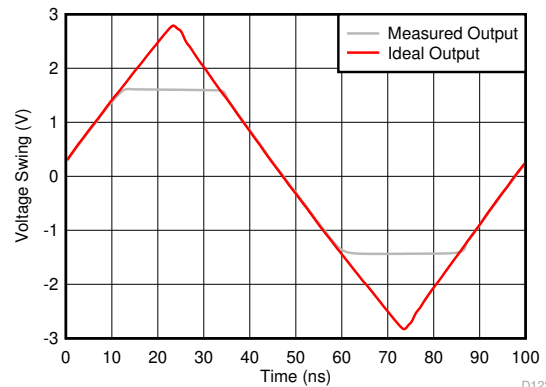

D122

2x Output Overdrive

Figure 6-22. Output Overload Response

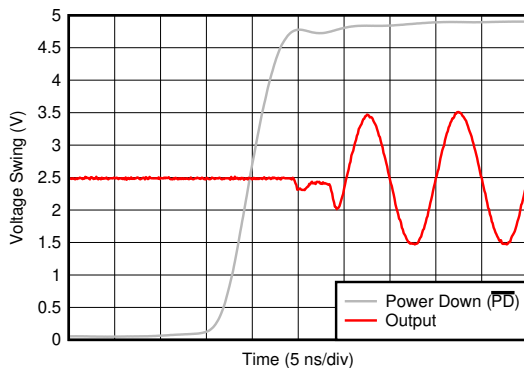

D123

$V_{S+} = 5\text{ V}$, $V_{S-} = \text{Ground}$

Figure 6-23. Turnon Transient Response

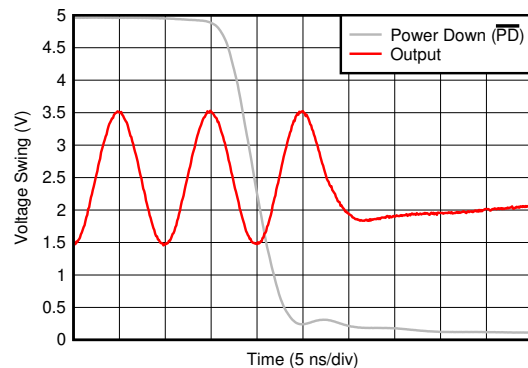

D124

$V_{S+} = 5\text{ V}$, $V_{S-} = \text{Ground}$

Figure 6-24. Turnoff Transient Response

6.6 Typical Characteristics (continued)

at $V_{S+} = 2.5\text{ V}$, $V_{S-} = -2.5\text{ V}$, $V_{IN+} = 0\text{ V}$, $R_F = 453\ \Omega$, Gain = 7 V/V , $R_L = 200\ \Omega$, output load referenced to midsupply, and $T_A = 25^\circ\text{C}$ (unless otherwise noted)

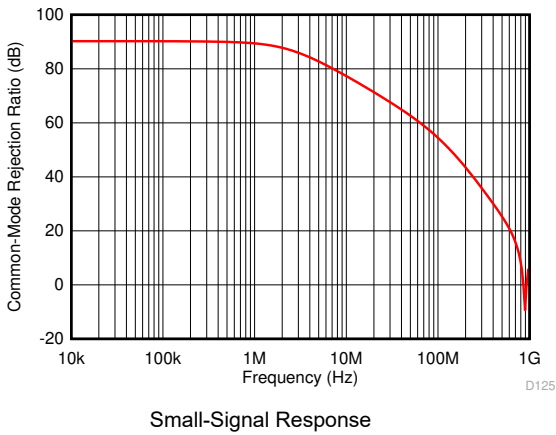

Figure 6-25. Common-Mode Rejection Ratio vs Frequency

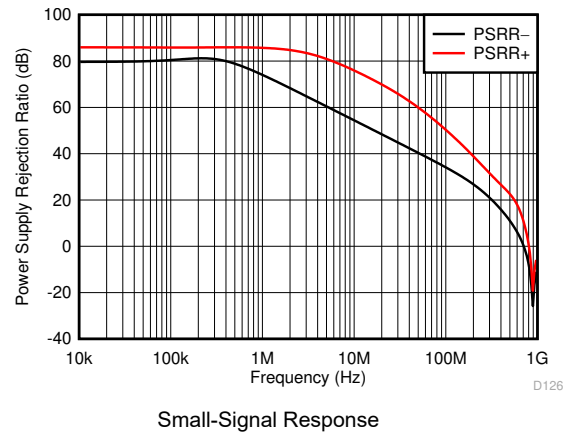

Figure 6-26. Power Supply Rejection Ratio vs Frequency

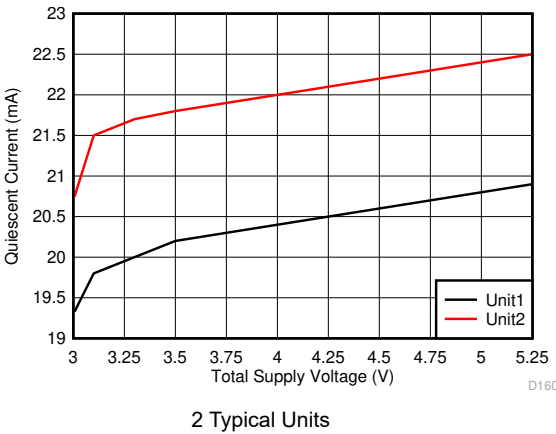

Figure 6-27. Quiescent Current vs Supply Voltage

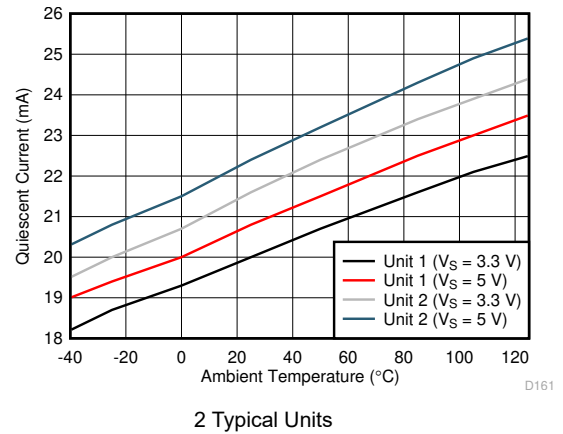

Figure 6-28. Quiescent Current vs Ambient Temperature

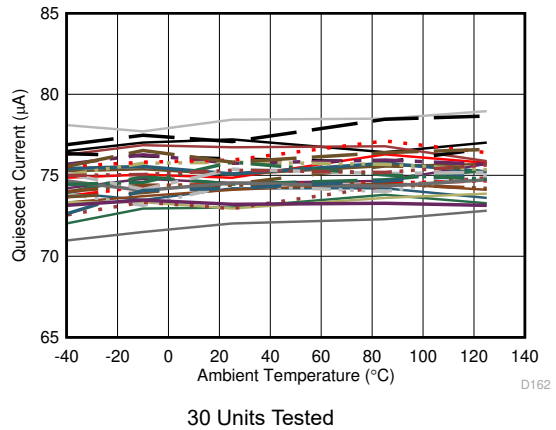

Figure 6-29. Quiescent Current (Amplifier Disabled) vs Ambient Temperature

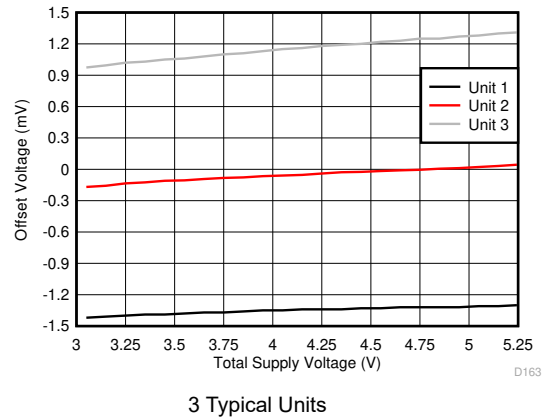
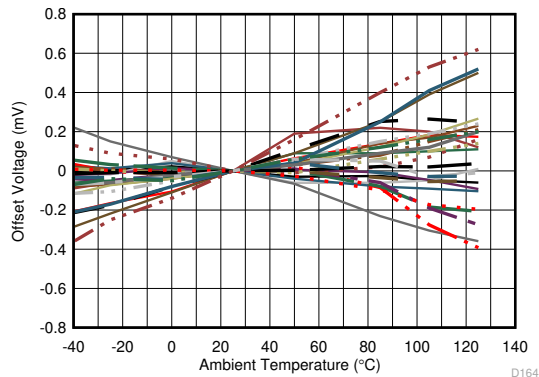

Figure 6-30. Offset Voltage vs Supply Voltage

6.6 Typical Characteristics (continued)

at $V_{S+} = 2.5\text{ V}$, $V_{S-} = -2.5\text{ V}$, $V_{IN+} = 0\text{ V}$, $R_F = 453\ \Omega$, Gain = 7 V/V , $R_L = 200\ \Omega$, output load referenced to midsupply, and $T_A = 25^\circ\text{C}$ (unless otherwise noted)



$\mu = 1\ \mu\text{V}/^\circ\text{C}$ $\sigma = 2.2\ \mu\text{V}/^\circ\text{C}$ 28 Units Tested

Figure 6-31. Offset Voltage vs Ambient Temperature

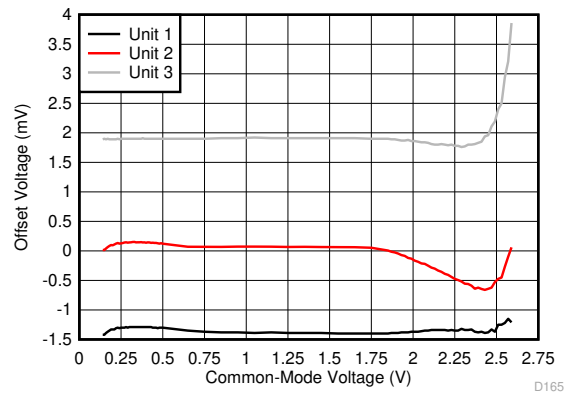

$V_S = 3.3\text{ V}$ 3 Typical Units

Figure 6-32. Offset Voltage vs Input Common-Mode Voltage

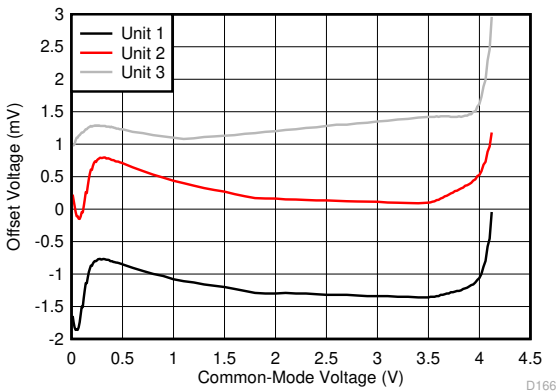

$V_S = 5\text{ V}$ 3 Typical Units

Figure 6-33. Offset Voltage vs Input Common-Mode Voltage

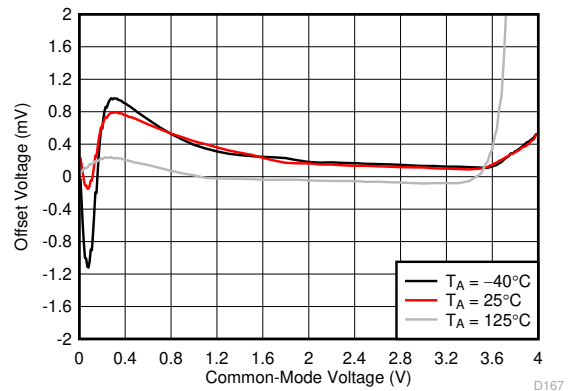
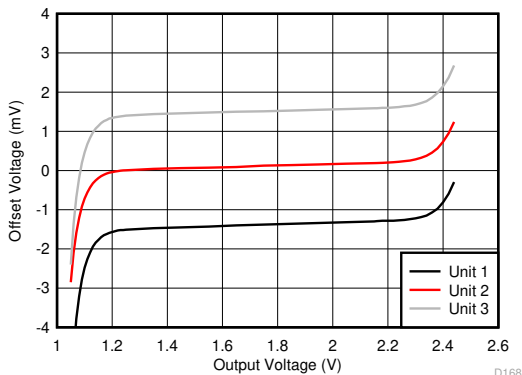
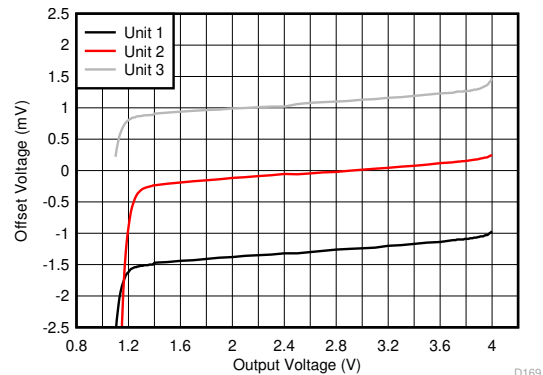

Figure 6-34. Offset Voltage vs Input Common-Mode Voltage vs Ambient Temperature



$V_S = 3.3\text{ V}$ 3 Typical Units

Figure 6-35. Offset Voltage vs Output Swing



$V_S = 5\text{ V}$ 3 Typical Units

Figure 6-36. Offset Voltage vs Output Swing

6.6 Typical Characteristics (continued)

at $V_{S+} = 2.5\text{ V}$, $V_{S-} = -2.5\text{ V}$, $V_{IN+} = 0\text{ V}$, $R_F = 453\ \Omega$, Gain = 7 V/V, $R_L = 200\ \Omega$, output load referenced to midsupply, and $T_A = 25^\circ\text{C}$ (unless otherwise noted)

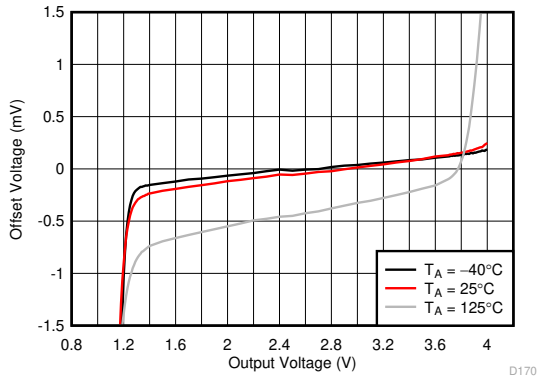
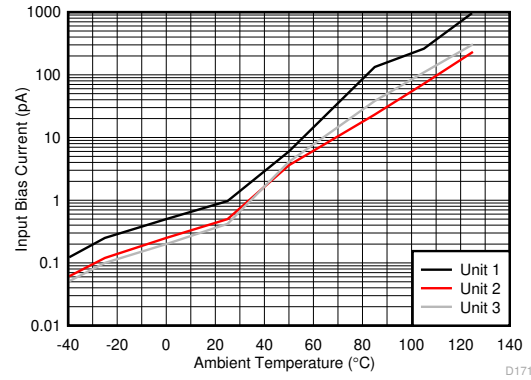

Figure 6-37. Offset Voltage vs Output Swing vs Ambient Temperature



3 Typical Units

Figure 6-38. Input Bias Current vs Ambient Temperature

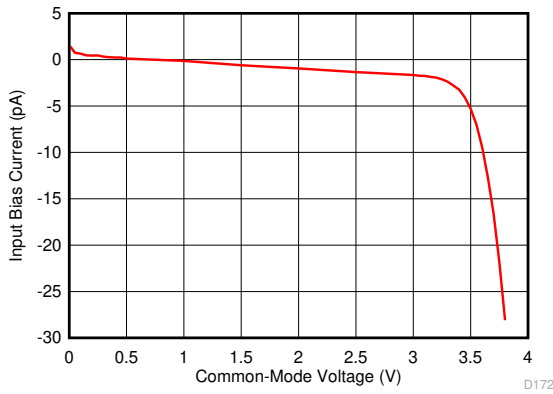

Figure 6-39. Input Bias Current vs Input Common-Mode Voltage

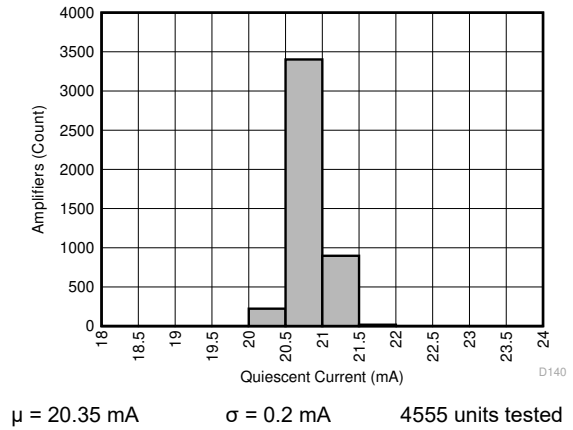

Figure 6-40. Quiescent Current Distribution

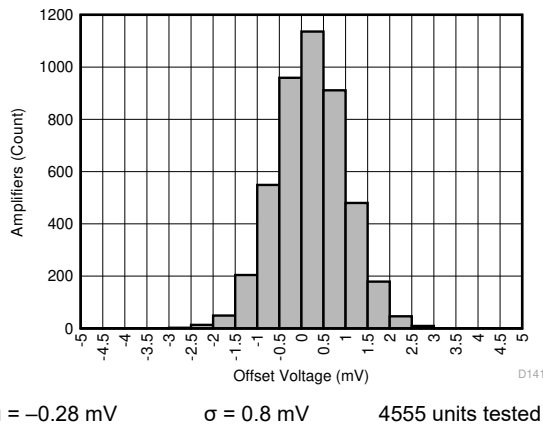

Figure 6-41. Offset Voltage Distribution

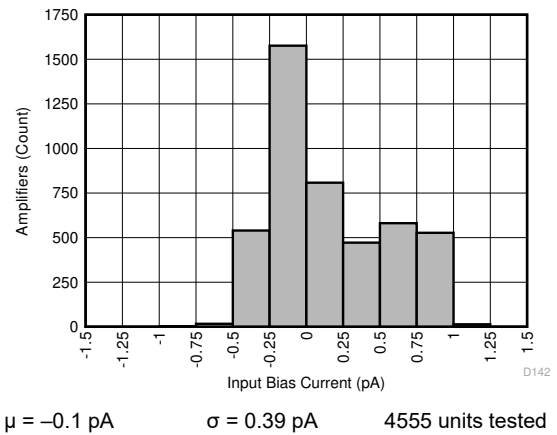
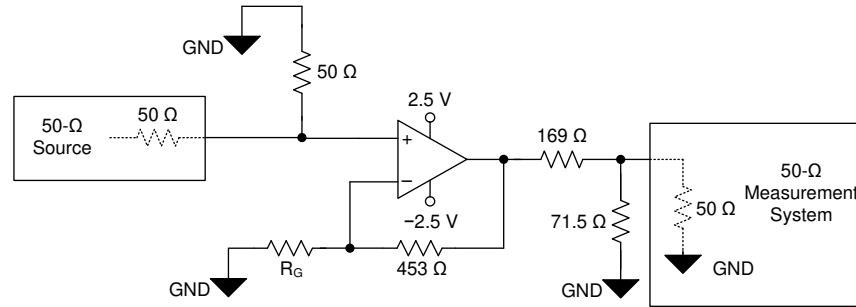

Figure 6-42. Input Bias Current Distribution

7 Parameter Measurement Information

The various test setup configurations for the OPA858-Q1 are shown in [Figure 7-1](#), [Figure 7-2](#), and [Figure 7-3](#). When configuring the OPA858-Q1 in a gain of +39.2 V/V, feedback resistor R_F was set to 953 Ω .

[Figure 6-1](#) shows 5-dB of peaking with the amplifier in an inverting configuration of -7 V/V with the amplifier configured as shown in [Figure 7-2](#). The 50- Ω matched termination of this circuit configuration results in the amplifier being configured in a noise gain of 5.3 V/V, which is lower than the recommended +7 V/V.



R_G values depend on gain configuration

Figure 7-1. Noninverting Configuration

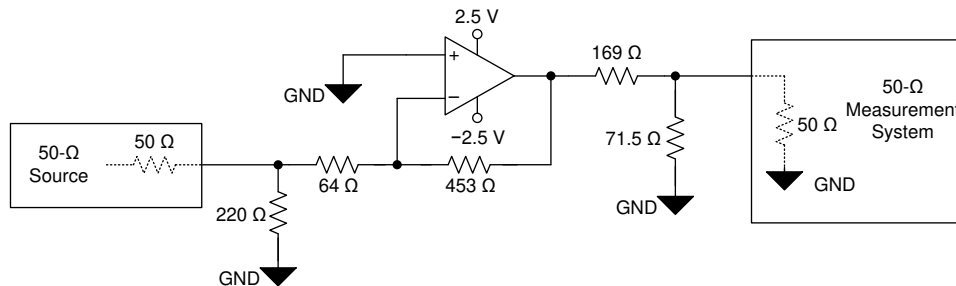

Figure 7-2. Inverting Configuration (Gain = -7 V/V)

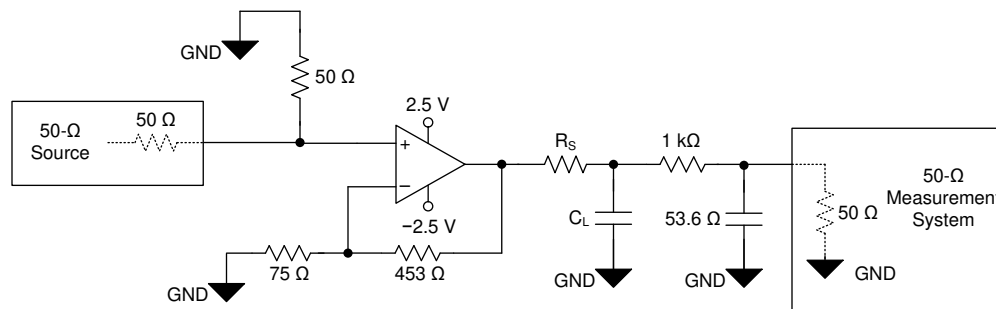

Figure 7-3. Capacitive Load Driver Configuration

8 Detailed Description

8.1 Overview

The ultra-wide, 5.5-GHz gain bandwidth product (GBWP) of the OPA858-Q1, combined with the broadband voltage noise of 2.5 nV/ $\sqrt{\text{Hz}}$, produces a viable amplifier for wideband transimpedance applications, high-speed data acquisition systems, and applications with weak signal inputs that require low-noise and high-gain front ends. The OPA858-Q1 combines multiple features to optimize dynamic performance. In addition to the wide, small-signal bandwidth, the OPA858-Q1 has 600 MHz of large-signal bandwidth ($V_{\text{OUT}} = 2 V_{\text{PP}}$), and a slew rate of 2000 V/ μs .

The OPA858-Q1 is offered in a 2-mm \times 2-mm, 8-pin WSON package that features a feedback (FB) pin for a simple feedback network connection between the amplifiers output and inverting input. Excess capacitance on an amplifiers input pin can reduce phase margin causing instability. This problem is exacerbated in the case of very wideband amplifiers like the OPA858-Q1. To reduce the effects of stray capacitance on the input node, the OPA858-Q1 pinout features an isolation pin (NC) between the feedback and inverting input pins that increases the physical spacing between them thereby reducing parasitic coupling at high frequencies. The OPA858-Q1 also features a very low capacitance input stage with only 0.8-pF of total input capacitance.

8.2 Functional Block Diagram

The OPA858-Q1 is a classic voltage feedback operational amplifier (op amp) with two high-impedance inputs and a low-impedance output. Standard application circuits are supported, like the two basic options shown in [Figure 8-1](#) and [Figure 8-2](#). The DC operating point for each configuration is level-shifted by the reference voltage (V_{REF}), which is typically set to midsupply in single-supply operation. V_{REF} is typically connected to ground in split-supply applications.

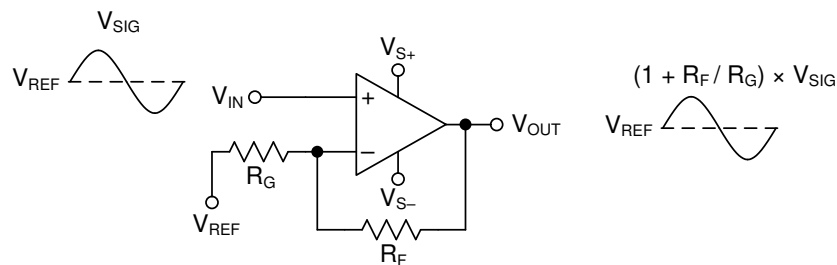

Figure 8-1. Noninverting Amplifier

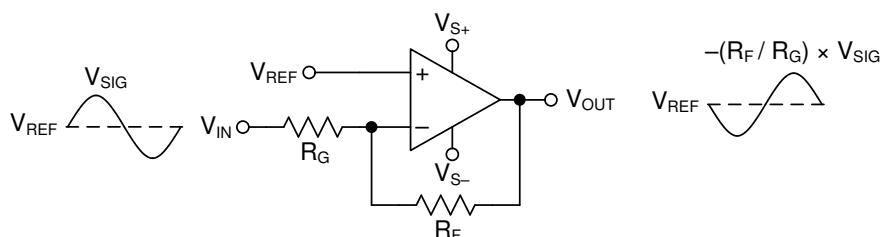

Figure 8-2. Inverting Amplifier

8.3 Feature Description

8.3.1 Input and ESD Protection

The OPA858-Q1 is fabricated on a low-voltage, high-speed, BiCMOS process. The internal, junction breakdown voltages are low for these small geometry devices, and as a result, all device pins are protected with internal ESD protection diodes to the power supplies as Figure 8-3 shows. There are two antiparallel diodes between the inputs of the amplifier that clamp the inputs during an overrange or fault condition.

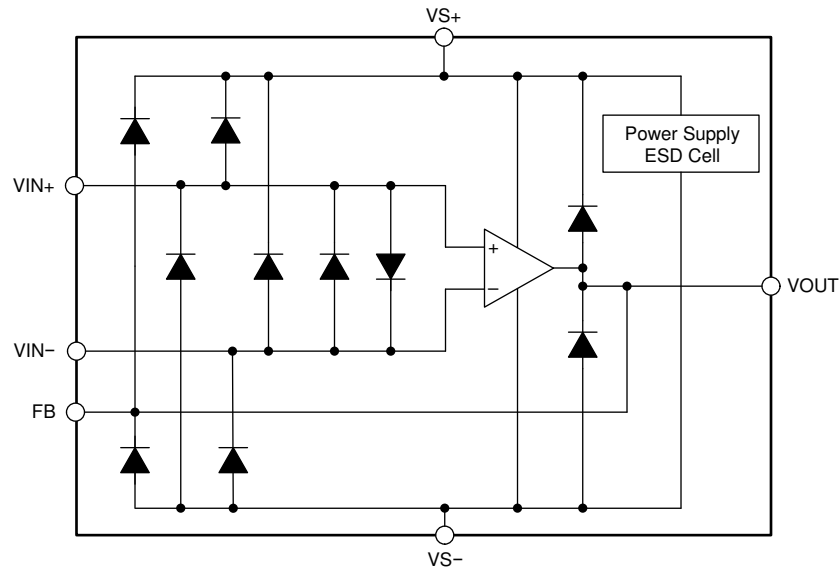

Figure 8-3. Internal ESD Structure

8.3.2 Feedback Pin

The OPA858-Q1 pin layout is optimized to minimize parasitic inductance and capacitance, which is a critical care about in high-speed analog design. The FB pin (pin 1) is internally connected to the output of the amplifier. The FB pin is separated from the inverting input of the amplifier (pin 3) by a no connect (NC) pin (pin 2). The NC pin must be left floating. There are two advantages to this pin layout:

1. A feedback resistor (R_F) can connect between the FB and IN- pin on the same side of the package (see Figure 8-4) rather than going around the package.
2. The isolation created by the NC pin minimizes the capacitive coupling between the FB and IN- pins by increasing the physical separation between the pins.

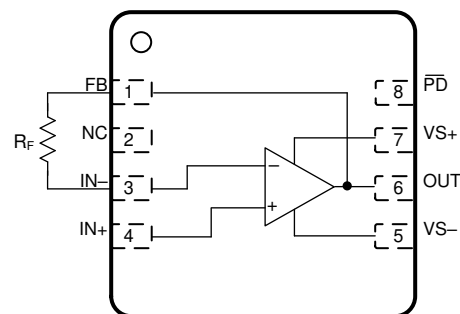

Figure 8-4. R_F Connection Between FB and IN- Pins

8.3.3 Wide Gain-Bandwidth Product

Figure 6-10 shows the open-loop magnitude and phase response of the OPA858-Q1. Calculate the gain bandwidth product of any op amp by determining the frequency at which the A_{OL} is 60 dB and multiplying that frequency by a factor of 1000. The second pole in the A_{OL} response occurs before the magnitude crosses 0 dB, and the resultant phase margin is less than 0° . This indicates instability at a gain of 0 dB (1 V/V). Amplifiers that are not unity-gain stable are known as decompensated amplifiers. Decompensated amplifiers typically have higher gain-bandwidth product, higher slew rate, and lower voltage noise, compared to a unity-gain stable amplifier with the same amount of quiescent power consumption.

Figure 8-5 shows the open-loop magnitude (A_{OL}) of the OPA858-Q1 as a function of temperature. The results show minimal variation over temperature. The phase margin of the OPA858-Q1 configured in a noise gain of 7 V/V (16.9 dB) is close to 55° across temperature. Similarly Figure 8-6 shows the A_{OL} magnitude of the OPA858-Q1 as a function of process variation. The results show the A_{OL} curve for the nominal process corner and the variation one standard deviation from the nominal. The simulated results suggest less than 1° of phase margin difference within a standard deviation of process variation when the amplifier is configured in a gain of 7 V/V.

One of the primary applications for the OPA858-Q1 is as a high-speed transimpedance amplifier (TIA), as Figure 9-4 shows. The low-frequency noise gain of a TIA is 0 dB (1 V/V). At high frequencies the ratio of the total input capacitance and the feedback capacitance set the noise gain. To maximize the TIA closed-loop bandwidth, the feedback capacitance is typically smaller than the input capacitance, which implies that the high-frequency noise gain is greater than 0 dB. As a result, op amps configured as TIAs are not required to be unity-gain stable, which makes a decompensated amplifier a viable option for a TIA. [What You Need To Know About Transimpedance Amplifiers – Part 1](#) and [What You Need To Know About Transimpedance Amplifiers – Part 2](#) describe transimpedance amplifier compensation in greater detail.

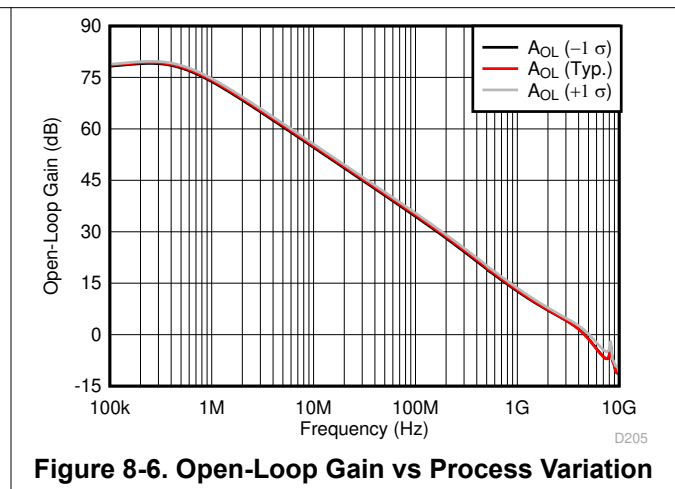
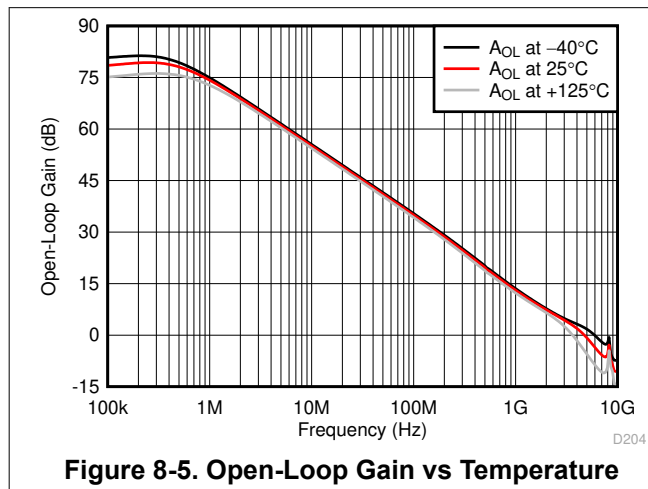

8.3.4 Slew Rate and Output Stage

In addition to wide bandwidth, the OPA858-Q1 features a high slew rate of 2000 V/ μ s. The slew rate is a critical parameter in high-speed pulse applications with narrow sub-10-ns pulses, such as optical time-domain reflectometry (OTDR) and LIDAR. The high slew rate of the OPA858-Q1 implies that the device accurately reproduces a 2-V, sub-ns pulse edge, as seen in [Figure 6-20](#). The wide bandwidth and slew rate of the OPA858-Q1 make it an excellent amplifier for high-speed signal-chain front ends.

[Figure 8-7](#) shows the open-loop output impedance of the OPA858-Q1 as a function of frequency. To achieve high slew rates and low output impedance across frequency, the output swing of the OPA858-Q1 is limited to approximately 3 V. The OPA858-Q1 is typically used in conjunction with high-speed pipeline ADCs and flash ADCs that have limited input ranges. Therefore, the OPA858-Q1 output swing range coupled with the class-leading voltage noise specification for a CMOS amplifier maximizes the overall dynamic range of the signal chain.

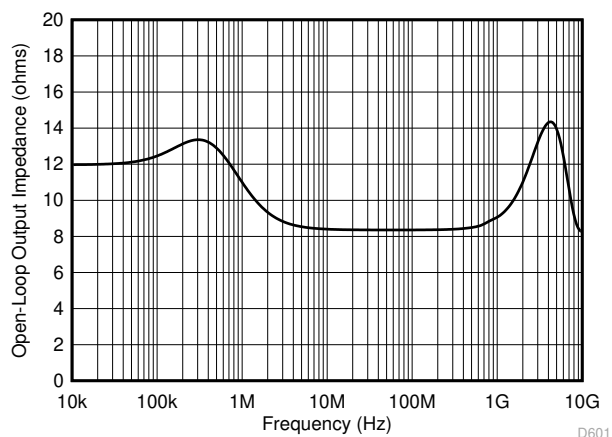

Figure 8-7. Open-Loop Output Impedance (Z_{OL}) vs Frequency

8.3.5 Current Noise

The input impedance of CMOS and JFET input amplifiers at low frequencies exceed several G Ω s. However, at higher frequencies, the transistors parasitic capacitance to the drain, source, and substrate reduces the impedance. The high impedance at low frequencies eliminates any bias current and the associated shot noise. At higher frequencies, the input current noise increases (see [Figure 8-8](#)) as a result of capacitive coupling between the CMOS gate oxide and the underlying transistor channel. This phenomenon is a natural artifact of the construction of the transistor and is unavoidable.

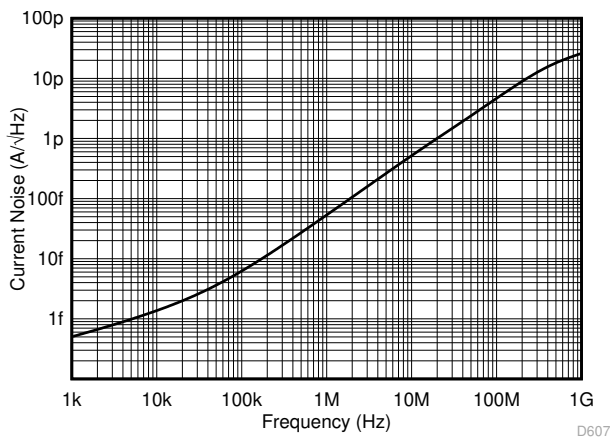

Figure 8-8. Input Current Noise (I_{BN} and I_{BI}) vs Frequency

8.4 Device Functional Modes

8.4.1 Split-Supply and Single-Supply Operation

The OPA858-Q1 can be configured with single-sided supplies or split-supplies as shown in [Figure 10-1](#). Split-supply operation using balanced supplies with the input common-mode set to ground eases lab testing because most signal generators, network analyzers, spectrum analyzers, and other lab equipment typically reference inputs and outputs to ground. In split-supply operation, the thermal pad must be connected to the negative supply.

Newer systems use a single power supply to improve efficiency and reduce the cost of the extra power supply. The OPA858-Q1 can be used with a single positive supply (negative supply at ground) with no change in performance if the input common-mode and output swing are biased within the linear operation of the device. In single-supply operation, level shift the DC input and output reference voltages by half the difference between the power supply rails. This configuration maintains the input common-mode and output load reference at midsupply. To eliminate gain errors, the source driving the reference input common-mode voltage must have low output impedance across the frequency range of interest. In this case, the thermal pad must be connected to ground.

8.4.2 Power-Down Mode

The OPA858-Q1 features a power-down mode to reduce the quiescent current to conserve power. [Figure 6-23](#) and [Figure 6-24](#) show the transient response of the OPA858-Q1 as the $\overline{\text{PD}}$ pin toggles between the disabled and enabled states.

The $\overline{\text{PD}}$ disable and enable threshold voltages are with reference to the negative supply. If the amplifier is configured with the positive supply at 3.3 V and the negative supply at ground, then the disable and enable threshold voltages are 0.65 V and 1.8 V, respectively. If the amplifier is configured with ± 1.65 V supplies, then the threshold voltages are at -1 V and 0.15 V. If the amplifier is configured with ± 2.5 V supplies, then the threshold voltages are at -1.85 V and -0.7 V.

[Figure 8-9](#) shows the switching behavior of a typical amplifier as the $\overline{\text{PD}}$ pin is swept down from the enabled state to the disabled state. Similarly, [Figure 8-10](#) shows the switching behavior of a typical amplifier as the $\overline{\text{PD}}$ pin is swept up from the disabled state to the enabled state. The small difference in the switching thresholds between the down sweep and the up sweep is caused by the hysteresis designed into the amplifier to increase immunity to noise on the $\overline{\text{PD}}$ pin.

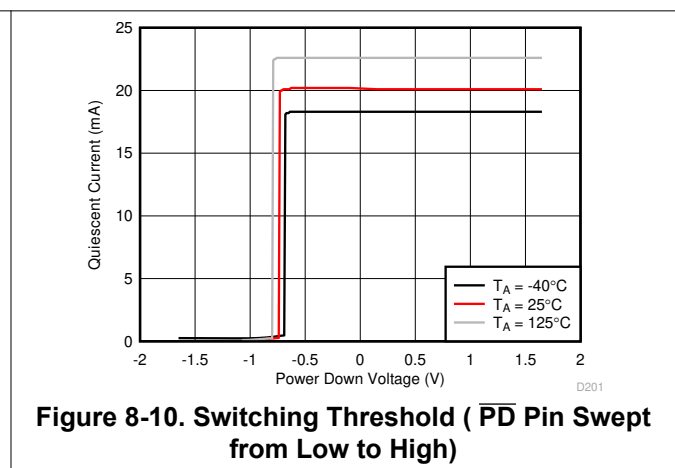
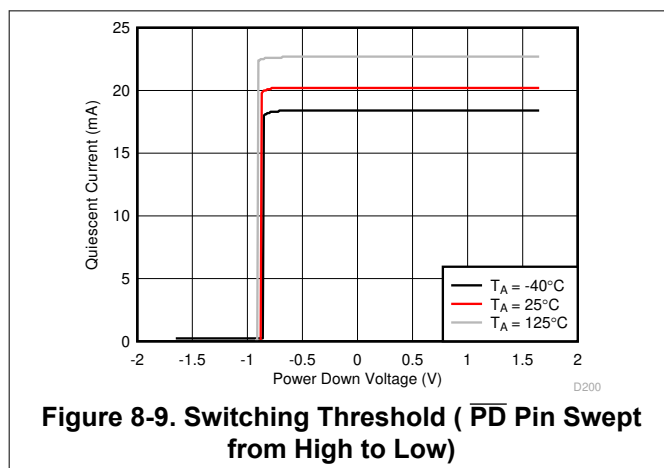

Connecting the $\overline{\text{PD}}$ pin low disables the amplifier and places the output in a high-impedance state. When the amplifier is configured as a noninverting amplifier, the feedback (R_F) and gain (R_G) resistor network form a parallel load to the output of the amplifier. To protect the input stage of the amplifier, the OPA858-Q1 uses internal, back-to-back protection diodes between the inverting and noninverting input pins as [Figure 8-3](#) shows. In the power-down state, if the differential voltage between the input pins of the amplifier exceeds a diode voltage drop, an additional low-impedance path is created between the noninverting input pin and the output pin.

9 Application and Implementation

Note

Information in the following applications sections is not part of the TI component specification, and TI does not warrant its accuracy or completeness. TI's customers are responsible for determining suitability of components for their purposes, as well as validating and testing their design implementation to confirm system functionality.

9.1 Application Information

9.1.1 Using the OPA858-Q1 as a Transimpedance Amplifier

The OPA858-Q1 design has been optimized to meet the industry's growing demand for wideband, low-noise photodiode amplifiers. The closed-loop bandwidth of a transimpedance amplifier is a function of the following:

1. The total input capacitance. This includes the photodiode capacitance, input capacitance of the amplifier (common-mode and differential capacitance) and any stray capacitance from the PCB.
2. The op amp gain bandwidth product (GBWP), and,
3. The transimpedance gain R_F .

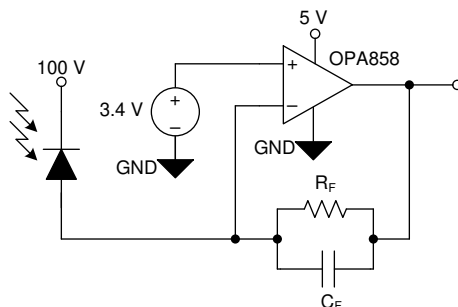
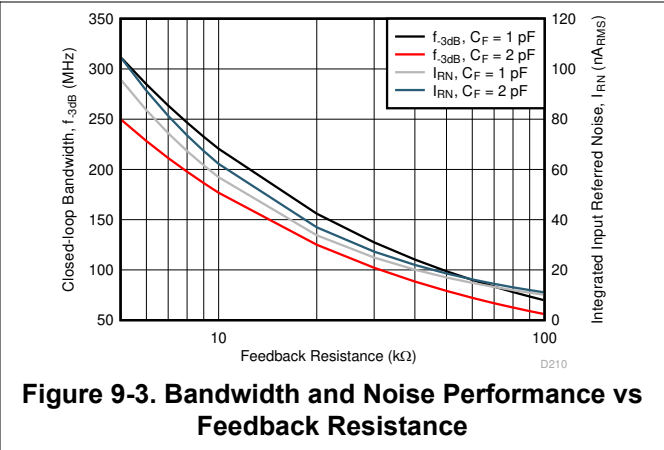
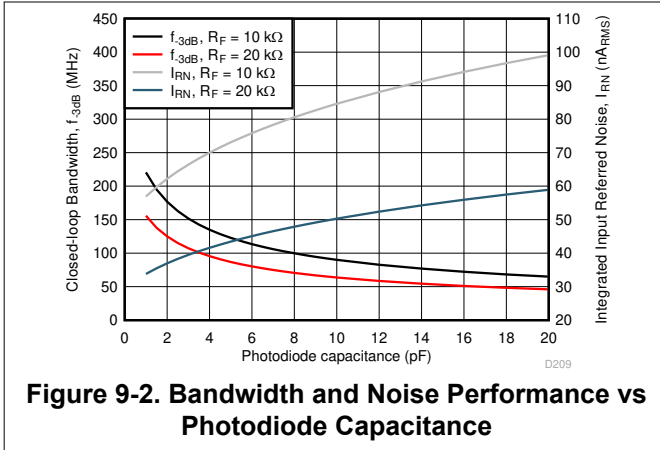

Figure 9-1. Transimpedance Amplifier Circuit

Figure 9-1 shows the OPA858-Q1 configured as a TIA with the avalanche photodiode (APD) reverse biased such that the APD cathode is tied to a large positive bias voltage. In this configuration the APD sources current into the op amp feedback loop so that the output swings in a negative direction relative to the input common-mode voltage. To maximize the output swing in the negative direction, the OPA858-Q1 common-mode is set close to the positive limit, 1.6 V from the positive supply rail.

The feedback resistance R_F and the input capacitance form a zero in the noise gain that results in instability if left unchecked. To counteract the effect of the zero, a pole is inserted by adding the feedback capacitor (C_F) into the noise gain transfer function. The [Transimpedance Considerations for High-Speed Amplifiers](#) application report discusses theories and equations that show how to compensate a transimpedance amplifier for a particular gain and input capacitance. The bandwidth and compensation equations from the application report are available in a Microsoft Excel® calculator. [What You Need To Know About Transimpedance Amplifiers – Part 1](#) provides a link to the calculator.



The equations and calculators in the application report and blog posts referenced above are used to model the bandwidth (f_{-3dB}) and noise (I_{RN}) performance of the OPA858-Q1 configured as a TIA. The resultant performance is shown in [Figure 9-2](#) and [Figure 9-3](#). The left side Y-axis shows the closed-loop bandwidth performance, while the right side of the graph shows the integrated input referred noise. The noise bandwidth to calculate I_{RN} , for a fixed R_F and C_{PD} is set equal to the f_{-3dB} frequency.

[Figure 9-2](#) shows the amplifier performance as a function of photodiode capacitance (C_{PD}) for $R_F = 10\text{ k}\Omega$ and $20\text{ k}\Omega$. Increasing C_{PD} decreases the closed-loop bandwidth. It is vital to reduce any stray parasitic capacitance from the PCB to maximize bandwidth. The OPA858-Q1 is designed with 0.8 pF of total input capacitance to minimize the effect on system performance.

[Figure 9-3](#) shows the amplifier performance as a function of R_F for $C_{PD} = 1\text{ pF}$ and 2 pF . Increasing R_F results in lower bandwidth. To maximize the signal-to-noise ratio (SNR) in an optical front-end system, maximize the gain in the TIA stage. Increasing R_F by a factor of X increases the signal level by X , but only increases the resistor noise contribution by \sqrt{X} , thereby improving SNR.

9.2 Typical Application

The high GBWP, low input voltage noise and high slew rate of the OPA858-Q1 makes the device a viable wideband, high input impedance voltage amplifier.

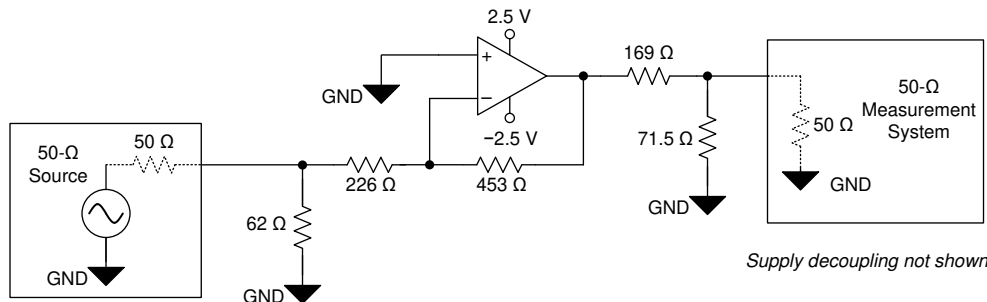

Figure 9-4. OPA858-Q1 in a Gain of $-2V/V$ (No Noise Gain Shaping)

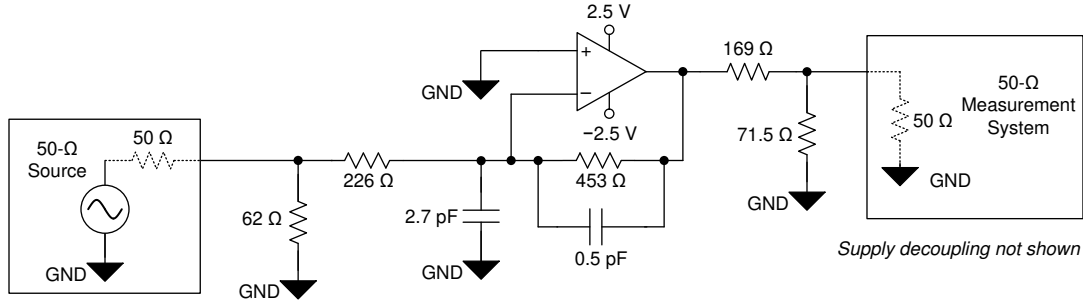

Figure 9-5. OPA858-Q1 in a Gain of $-2V/V$ (With Noise Gain Shaping)

9.2.1 Design Requirements

Design a high-bandwidth, high-gain, voltage amplifier with the design requirements listed in Table 9-1. An inverting amplifier configuration is chosen here; however, the theory is applicable to a noninverting configuration as well. In an inverting configuration the signal gain and noise gain transfer functions are not equal, unlike the noninverting configuration.

Table 9-1. Design Requirements

TARGET BANDWIDTH (MHz)	SIGNAL GAIN (V/V)	FEEDBACK RESISTANCE (Ω)	FREQUENCY PEAKING (dB)
> 750	-2	453	< 2

9.2.2 Detailed Design Procedure

The OPA858-Q1 is compensated to have less than 1 dB of peaking in a gain of 7 V/V. Using the device in lower gains results in increased peaking and potential instability. Figure 9-4 shows the OPA858-Q1 configured in a signal gain of -2 V/V. The DC noise gain ($1/\beta$) of the amplifier is affected by the 62- Ω termination resistor and the 50- Ω source resistor and is given by Equation 1. At higher frequencies the noise gain is affected by reactive elements such as inductors and capacitors. These include both discrete board components as well as printed circuit board (PCB) parasitics.

$$\text{Noise Gain} = \frac{1}{\beta} = \left(1 + \frac{453 \Omega}{226 \Omega + (62 \Omega \parallel 50 \Omega)} \right) = 2.79 \text{ V/V} = 5.04 \text{ dB} \quad (1)$$

The stability and phase margin of the amplifier depend on the loop gain of the amplifier, which is the product of the A_{OL} and the feedback factor (β) of the amplifier. The β of a negative-feedback loop system is the portion of the output signal that is fed back to the input, and in the case of an amplifier is the inverse of the noise gain. The noise gain of the amplifier at high frequencies can be increased by adding an input capacitor and a feedback capacitor as Figure 9-5 shows. If done carefully, increasing $1/\beta$ improves the phase margin just as any amplifier is more stable in a high gain configuration versus a unity-gain buffer configuration. The modified network with the added capacitors alters the high-frequency noise gain, but does not alter the signal gain. The *AN-1604 Decompensated Operational Amplifiers* application report provides a detailed analysis of noise gain-shaping techniques for decompensated amplifiers and shows how to choose external resistors and capacitor values.

Figure 9-6 shows the uncompensated frequency response of the OPA858-Q1 configured as shown in Figure 9-4. Without any added noise gain shaping components, the OPA858-Q1 shows approximately 13 dB of peaking.

Figure 9-7 shows the noise gain compensated frequency response of the OPA858-Q1 configured as shown in Figure 9-5. The noise gain shaping elements reduce the peaking to less than 1.5 dB. The 2.7-pF input capacitor, the input capacitance of the amplifier, the gain resistor, and the feedback resistor create a zero in the noise gain at a frequency f , as Equation 2 shows.

$$f = \frac{1}{2\pi(R_F \parallel R_G)C_{IN}} \quad (2)$$

where

- R_F is the feedback resistor
- R_G is the input or gain resistor (includes the effect of the source and termination resistor)
- C_{IN} is the total input capacitance, which includes the external 2.7-pF capacitor, the amplifier input capacitance, and any parasitic PCB capacitance.

The zero in [Equation 2](#) increases the noise gain at higher frequencies, which is important when compensating a decompensated amplifier. However, the noise gain zero reduces the loop gain phase which results in a lower phase margin. To counteract the phase reduction due to the noise gain zero, add a pole to the noise gain curve by inserting the 0.5-pF feedback capacitor. The pole occurs at a frequency shown in [Equation 3](#). The noise gain pole and zero locations must be selected so that the rate-of-closure between the magnitude curves of A_{OL} and $1/\beta$ is approximately 20 dB. To ensure this, the noise gain pole must occur before the $1/\beta$ magnitude curve intersects the A_{OL} magnitude curve. In other words, the noise gain pole must occur before $|A_{OL}| = |1/\beta|$. The point at which the two curves intersect is known as the loop gain crossover frequency.

$$f = \frac{1}{2\pi R_F C_F} \quad (3)$$

where

- C_F is the feedback capacitor (includes any added PCB parasitic)

For more information on op amp stability, watch the [TI Precision Lab series on stability](#) video.

9.2.3 Application Curves

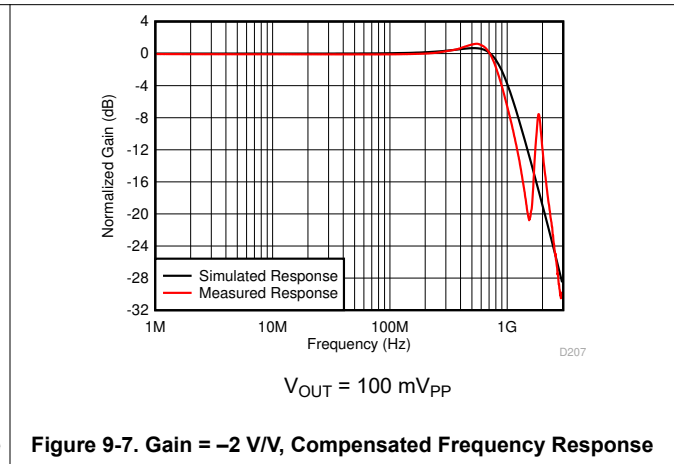
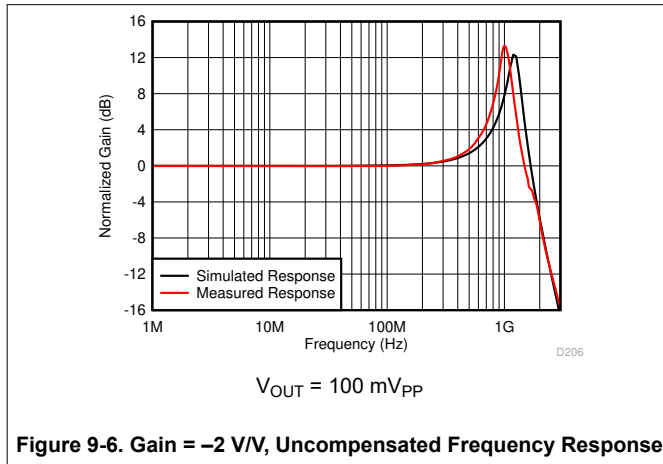

10 Power Supply Recommendations

The OPA858-Q1 operates on supplies from 3.3 V to 5.25 V. The OPA858-Q1 operates on single-sided supplies, split and balanced bipolar supplies, and unbalanced bipolar supplies. Because the OPA858-Q1 does not feature rail-to-rail inputs or outputs, the input common-mode and output swing ranges are limited at 3.3-V supplies.

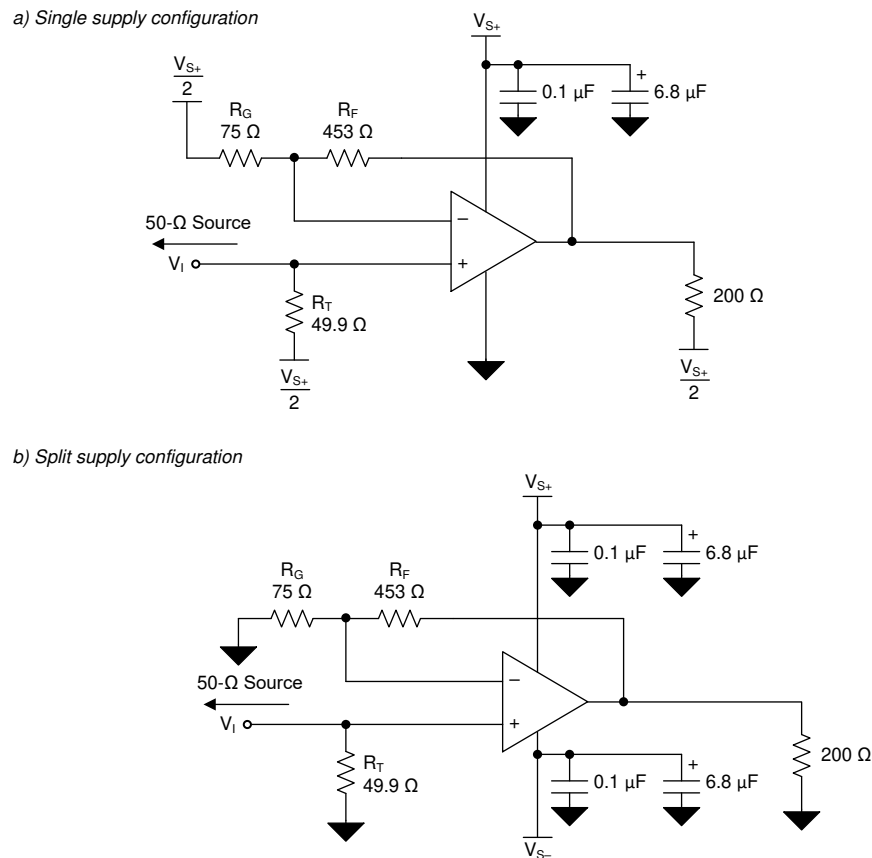

Figure 10-1. Split and Single Supply Circuit Configuration

11 Layout

11.1 Layout Guidelines

Achieving optimum performance with a high-frequency amplifier like the OPA858-Q1 requires careful attention to board layout parasitics and external component types. Recommendations that optimize performance include:

- **Minimize parasitic capacitance from the signal I/O pins to ac ground.** Parasitic capacitance on the output and inverting input pins can cause instability. To reduce unwanted capacitance, cut out the power and ground traces under the signal input and output pins. Otherwise, ground and power planes must be unbroken elsewhere on the board. When configuring the amplifier as a TIA, if the required feedback capacitor is less than 0.15 pF, consider using two series resistors, each of half the value of a single resistor in the feedback loop to minimize the parasitic capacitance from the resistor.
- **Minimize the distance (less than 0.25-in) from the power-supply pins to high-frequency bypass capacitors.** Use high-quality, 100-pF to 0.1- μ F, C0G and NPO-type decoupling capacitors with voltage ratings at least three times greater than the amplifiers maximum power supplies. This configuration makes sure that there is a low-impedance path to the amplifiers power-supply pins across the amplifiers gain bandwidth specification. At the device pins, do not allow the ground and power plane layout to be in close proximity to the signal I/O pins. Avoid narrow power and ground traces to minimize inductance between the pins and the decoupling capacitors. The power-supply connections must always be decoupled with these capacitors. Larger (2.2- μ F to 6.8- μ F) decoupling capacitors that are effective at lower frequency must be used on the supply pins. Place these decoupling capacitors further from the device. Share the decoupling capacitors among several devices in the same area of the printed circuit board (PCB).
- **Careful selection and placement of external components preserves the high-frequency performance of the OPA858-Q1.** Use low-reactance resistors. Surface-mount resistors work best and allow a tighter overall layout. Never use wirewound resistors in a high-frequency application. Because the output pin and inverting input pin are the most sensitive to parasitic capacitance, always position the feedback and series output resistor, if any, as close to the output pin as possible. Place other network components (such as noninverting input termination resistors) close to the package. Even with a low parasitic capacitance shunting the external resistors, high resistor values create significant time constants that can degrade performance. When configuring the OPA858-Q1 as a voltage amplifier, keep resistor values as low as possible and consistent with load driving considerations. Decreasing the resistor values keeps the resistor noise terms low and minimizes the effect of the parasitic capacitance. However, lower resistor values increase the dynamic power consumption because R_F and R_G become part of the output load network of the amplifier.

11.2 Layout Example

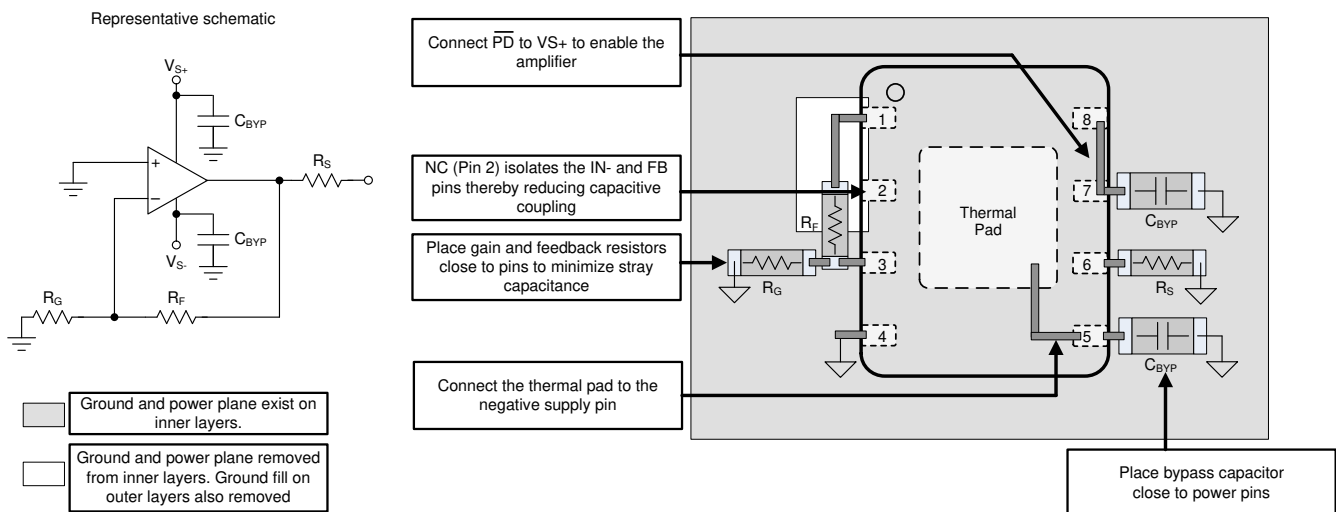

Figure 11-1. Layout Recommendation

When configuring the OPA858-Q1 as a transimpedance amplifier additional care must be taken to minimize the inductance between the avalanche photodiode (APD) and the amplifier. Always place the photodiode on the same side of the PCB as the amplifier. Placing the amplifier and the APD on opposite sides of the PCB increases the parasitic effects due to via inductance. APD packaging can be quite large which often requires the APD to be placed further away from the amplifier than ideal. The added distance between the two device results in increased inductance between the APD and op amp feedback network as shown in Figure 11-2. The added inductance is detrimental to a decompensated amplifiers stability since it isolates the APD capacitance from the noise gain transfer function. The noise gain is given by Equation 4. The added PCB trace inductance between the feedback network increases the denominator in Equation 4 thereby reducing the noise gain and the phase margin. In cases where a leaded APD in a TO can is used inductance should be further minimized by cutting the leads of the TO can as short as possible.

The layout shown in Figure 11-2 can be improved by following some of the guidelines shown in Figure 11-3. The two key rules to follow are:

- Add an isolation resistor R_{ISO} as close as possible to the inverting input of the amplifier. Select the value of R_{ISO} to be between $10\ \Omega$ and $20\ \Omega$. The resistor dampens the potential resonance caused by the trace inductance and the amplifiers internal capacitance.
- Close the loop between the feedback elements (R_F and C_F) and R_{ISO} as close to the APD pins as possible. This ensures a more balanced layout and reduces the inductive isolation between the APD and the feedback network.

$$\text{Noise Gain} = \left(1 + \frac{Z_F}{Z_{IN}} \right) \quad (4)$$

where

- Z_F is the total impedance of the feedback network.
- Z_{IN} is the total impedance of the input network.

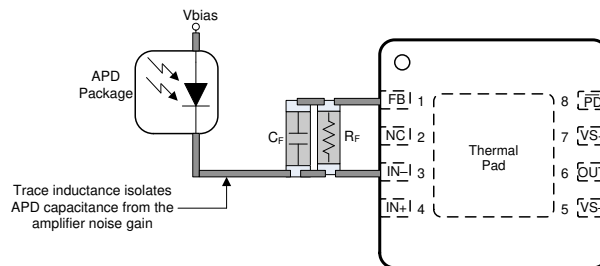

Figure 11-2. Non-Ideal TIA Layout

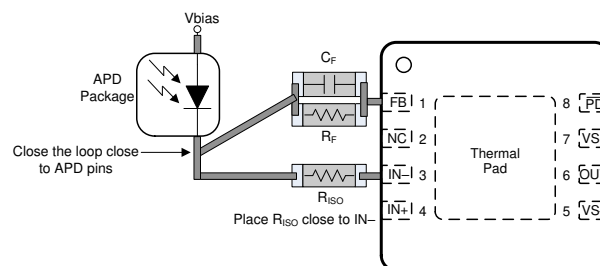

Figure 11-3. Improved TIA Layout

12 Device and Documentation Support

12.1 Device Support

12.1.1 Development Support

- [LIDAR Pulsed Time of Flight Reference Design](#)
- [LIDAR-Pulsed Time-of-Flight Reference Design Using High-Speed Data Converters](#)
- [Wide Bandwidth Optical Front-end Reference Design](#)

12.2 Documentation Support

12.2.1 Related Documentation

For related documentation see the following:

- Texas Instruments, [OPA858EVM user's guide](#)
- Texas Instruments, [Training Video: High-Speed Transimpedance Amplifier Design Flow](#)
- Texas Instruments, [Training Video: How to Design Transimpedance Amplifier Circuits](#)
- Texas Instruments, [Training Video: How to Convert a TINA-TI Model into a Generic SPICE Model](#)
- Texas Instruments, [Transimpedance Considerations for High-Speed Amplifiers application report](#)
- Texas Instruments, [What You Need To Know About Transimpedance Amplifiers – Part 1](#)
- Texas Instruments [What You Need To Know About Transimpedance Amplifiers – Part 2](#)

12.3 Receiving Notification of Documentation Updates

To receive notification of documentation updates, navigate to the device product folder on ti.com. In the upper right corner, click on *Alert me* to register and receive a weekly digest of any product information that has changed. For change details, review the revision history included in any revised document.

12.4 Support Resources

TI E2E™ support forums are an engineer's go-to source for fast, verified answers and design help — straight from the experts. Search existing answers or ask your own question to get the quick design help you need.

Linked content is provided "AS IS" by the respective contributors. They do not constitute TI specifications and do not necessarily reflect TI's views; see TI's [Terms of Use](#).

12.5 Trademarks

TI E2E™ is a trademark of Texas Instruments.

® is a registered trademark of Microsoft Corporation.

All trademarks are the property of their respective owners.

12.6 Electrostatic Discharge Caution



This integrated circuit can be damaged by ESD. Texas Instruments recommends that all integrated circuits be handled with appropriate precautions. Failure to observe proper handling and installation procedures can cause damage.

ESD damage can range from subtle performance degradation to complete device failure. Precision integrated circuits may be more susceptible to damage because very small parametric changes could cause the device not to meet its published specifications.

12.7 Glossary

[TI Glossary](#) This glossary lists and explains terms, acronyms, and definitions.

13 Mechanical, Packaging, and Orderable Information

The following pages include mechanical, packaging, and orderable information. This information is the most current data available for the designated devices. This data is subject to change without notice and revision of this document. For browser-based versions of this data sheet, refer to the left-hand navigation.

PACKAGING INFORMATION

Orderable part number	Status (1)	Material type (2)	Package Pins	Package qty Carrier	RoHS (3)	Lead finish/ Ball material (4)	MSL rating/ Peak reflow (5)	Op temp (°C)	Part marking (6)
OPA858QDSGRQ1	Active	Production	WSON (DSG) 8	3000 LARGE T&R	Yes	NIPDAU	Level-2-260C-1 YEAR	-40 to 125	858Q
OPA858QDSGRQ1.B	Active	Production	WSON (DSG) 8	3000 LARGE T&R	Yes	NIPDAU	Level-2-260C-1 YEAR	-40 to 125	858Q

(1) **Status:** For more details on status, see our [product life cycle](#).

(2) **Material type:** When designated, preproduction parts are prototypes/experimental devices, and are not yet approved or released for full production. Testing and final process, including without limitation quality assurance, reliability performance testing, and/or process qualification, may not yet be complete, and this item is subject to further changes or possible discontinuation. If available for ordering, purchases will be subject to an additional waiver at checkout, and are intended for early internal evaluation purposes only. These items are sold without warranties of any kind.

(3) **RoHS values:** Yes, No, RoHS Exempt. See the [TI RoHS Statement](#) for additional information and value definition.

(4) **Lead finish/Ball material:** Parts may have multiple material finish options. Finish options are separated by a vertical ruled line. Lead finish/Ball material values may wrap to two lines if the finish value exceeds the maximum column width.

(5) **MSL rating/Peak reflow:** The moisture sensitivity level ratings and peak solder (reflow) temperatures. In the event that a part has multiple moisture sensitivity ratings, only the lowest level per JEDEC standards is shown. Refer to the shipping label for the actual reflow temperature that will be used to mount the part to the printed circuit board.

(6) **Part marking:** There may be an additional marking, which relates to the logo, the lot trace code information, or the environmental category of the part.

Multiple part markings will be inside parentheses. Only one part marking contained in parentheses and separated by a "-" will appear on a part. If a line is indented then it is a continuation of the previous line and the two combined represent the entire part marking for that device.

Important Information and Disclaimer:The information provided on this page represents TI's knowledge and belief as of the date that it is provided. TI bases its knowledge and belief on information provided by third parties, and makes no representation or warranty as to the accuracy of such information. Efforts are underway to better integrate information from third parties. TI has taken and continues to take reasonable steps to provide representative and accurate information but may not have conducted destructive testing or chemical analysis on incoming materials and chemicals. TI and TI suppliers consider certain information to be proprietary, and thus CAS numbers and other limited information may not be available for release.

In no event shall TI's liability arising out of such information exceed the total purchase price of the TI part(s) at issue in this document sold by TI to Customer on an annual basis.

OTHER QUALIFIED VERSIONS OF OPA858-Q1 :

- Catalog : [OPA858](#)

NOTE: Qualified Version Definitions:

- Catalog - TI's standard catalog product

TAPE AND REEL INFORMATION



QUADRANT ASSIGNMENTS FOR PIN 1 ORIENTATION IN TAPE



*All dimensions are nominal

Device	Package Type	Package Drawing	Pins	SPQ	Reel Diameter (mm)	Reel Width W1 (mm)	A0 (mm)	B0 (mm)	K0 (mm)	P1 (mm)	W (mm)	Pin1 Quadrant
OPA858QDSGRQ1	WSON	DSG	8	3000	180.0	8.4	2.3	2.3	1.15	4.0	8.0	Q2

TAPE AND REEL BOX DIMENSIONS



*All dimensions are nominal

Device	Package Type	Package Drawing	Pins	SPQ	Length (mm)	Width (mm)	Height (mm)
OPA858QDSGRQ1	WSON	DSG	8	3000	210.0	185.0	35.0

GENERIC PACKAGE VIEW

DSG 8

WSON - 0.8 mm max height

2 x 2, 0.5 mm pitch

PLASTIC SMALL OUTLINE - NO LEAD

This image is a representation of the package family, actual package may vary.
Refer to the product data sheet for package details.



4224783/A

DSG0008A



PACKAGE OUTLINE

WSON - 0.8 mm max height

PLASTIC SMALL OUTLINE - NO LEAD



ALTERNATIVE TERMINAL SHAPE TYPICAL



SIDE WALL METAL THICKNESS DIM A	
OPTION 1	OPTION 2
0.1	0.2



4218900/E 08/2022

NOTES:

1. All linear dimensions are in millimeters. Any dimensions in parenthesis are for reference only. Dimensioning and tolerancing per ASME Y14.5M.
2. This drawing is subject to change without notice.
3. The package thermal pad must be soldered to the printed circuit board for thermal and mechanical performance.

EXAMPLE BOARD LAYOUT

DSG0008A

WSON - 0.8 mm max height

PLASTIC SMALL OUTLINE - NO LEAD



LAND PATTERN EXAMPLE
SCALE:20X



SOLDER MASK DETAILS

4218900/E 08/2022

NOTES: (continued)

4. This package is designed to be soldered to a thermal pad on the board. For more information, see Texas Instruments literature number SLUA271 (www.ti.com/lit/slua271).
5. Vias are optional depending on application, refer to device data sheet. If any vias are implemented, refer to their locations shown on this view. It is recommended that vias under paste be filled, plugged or tented.

EXAMPLE STENCIL DESIGN

DSG0008A

WSON - 0.8 mm max height

PLASTIC SMALL OUTLINE - NO LEAD



SOLDER PASTE EXAMPLE
BASED ON 0.125 mm THICK STENCIL

EXPOSED PAD 9:
87% PRINTED SOLDER COVERAGE BY AREA UNDER PACKAGE
SCALE:25X

4218900/E 08/2022

NOTES: (continued)

6. Laser cutting apertures with trapezoidal walls and rounded corners may offer better paste release. IPC-7525 may have alternate design recommendations.

IMPORTANT NOTICE AND DISCLAIMER

TI PROVIDES TECHNICAL AND RELIABILITY DATA (INCLUDING DATASHEETS), DESIGN RESOURCES (INCLUDING REFERENCE DESIGNS), APPLICATION OR OTHER DESIGN ADVICE, WEB TOOLS, SAFETY INFORMATION, AND OTHER RESOURCES "AS IS" AND WITH ALL FAULTS, AND DISCLAIMS ALL WARRANTIES, EXPRESS AND IMPLIED, INCLUDING WITHOUT LIMITATION ANY IMPLIED WARRANTIES OF MERCHANTABILITY, FITNESS FOR A PARTICULAR PURPOSE OR NON-INFRINGEMENT OF THIRD PARTY INTELLECTUAL PROPERTY RIGHTS.

These resources are intended for skilled developers designing with TI products. You are solely responsible for (1) selecting the appropriate TI products for your application, (2) designing, validating and testing your application, and (3) ensuring your application meets applicable standards, and any other safety, security, regulatory or other requirements.

These resources are subject to change without notice. TI grants you permission to use these resources only for development of an application that uses the TI products described in the resource. Other reproduction and display of these resources is prohibited. No license is granted to any other TI intellectual property right or to any third party intellectual property right. TI disclaims responsibility for, and you fully indemnify TI and its representatives against any claims, damages, costs, losses, and liabilities arising out of your use of these resources.

TI's products are provided subject to [TI's Terms of Sale](#), [TI's General Quality Guidelines](#), or other applicable terms available either on ti.com or provided in conjunction with such TI products. TI's provision of these resources does not expand or otherwise alter TI's applicable warranties or warranty disclaimers for TI products. Unless TI explicitly designates a product as custom or customer-specified, TI products are standard, catalog, general purpose devices.

TI objects to and rejects any additional or different terms you may propose.

Copyright © 2025, Texas Instruments Incorporated

Last updated 10/2025