

OPAx383 Low-Power, High-Precision, 2.5MHz, Zero-Drift Op Amp

1 Features

- Ultra-low offset voltage: $\pm 5\mu\text{V}$ (maximum)
- Zero drift: $\pm 0.025\mu\text{V}/^\circ\text{C}$
- Low-input bias current: 62pA (maximum)
- Low noise: $32\text{nV}/\sqrt{\text{Hz}}$ at 1kHz
- No 1/f noise: 650nV_{PP} (0.1Hz to 10Hz)
- Common-mode input range $\pm 100\text{mV}$ beyond supply rails
- Gain bandwidth: 2.5MHz
- Quiescent current: $65\mu\text{A}$ per amplifier
- Single supply: 1.7V to 5.5V
- Dual supply: $\pm 0.85\text{V}$ to $\pm 2.75\text{V}$
- EMI and RFI filtered inputs

2 Applications

- [Electronic thermometer](#)
- [Weigh scale](#)
- [Temperature transmitter](#)
- [Ventilators](#)
- [Data acquisition \(DAQ\)](#)
- [Semiconductor test](#)
- [Lab and field instrumentation](#)
- [Merchant network and server PSU](#)
- [Analog input module](#)
- [Pressure transmitter](#)

3 Description

The OPA383, OPA2383, and OPA4383 (OPAx383) family of precision amplifiers offers state-of-the-art performance. With zero-drift technology, the OPAx383 offset voltage and offset drift provide unparalleled long-term stability. With an ultra-low $65\mu\text{A}$ of quiescent current, the OPAx383 are able to achieve 2.5MHz of bandwidth, a broadband noise of $32\text{nV}/\sqrt{\text{Hz}}$, and a 1/f noise at 650nV_{PP} . These specifications are crucial to achieve extremely-high precision and no degradation of linearity in 16-bit to 24-bit analog to digital converters (ADCs). The OPAx383 feature flat bias current over temperature; therefore, little to no calibration is needed in high input impedance applications over temperature.

All versions are specified over the industrial temperature range of -40°C to $+125^\circ\text{C}$.

Device Information

PART NUMBER	CHANNEL COUNT	PACKAGE ⁽¹⁾	PACKAGE SIZE
OPA383	Single	DBV (SOT-23, 5)	2.9mm × 2.8mm
		DCK (SC70, 5) ⁽²⁾	2.0mm × 2.1mm
OPA383, Shutdown	Single	YCH (DSBGA, 6)	1.01mm × 0.69mm
OPA2383	Dual	D (SOIC, 8) ⁽²⁾	4.9mm × 6.0mm
		DGK (VSSOP, 8)	3.0mm × 4.9mm
OPA4383	Quad	PW (TSSOP, 14)	5.0mm × 6.4mm

- (1) For more information, see [Section 10](#).
- (2) Preview information (not Production Data).

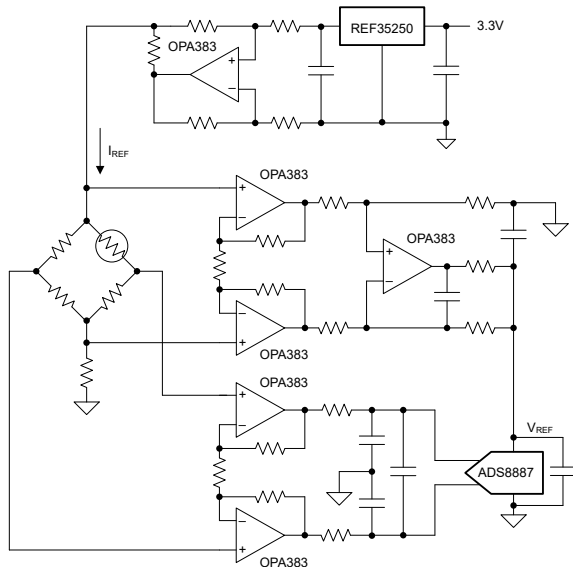

The OPA383 as a Bridge Sensor Front End

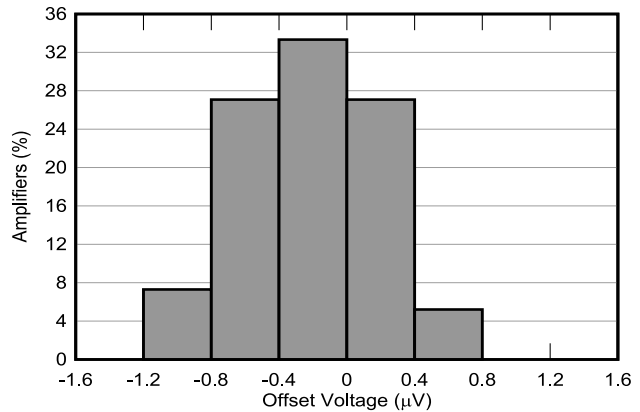

Ultra-Low Input Offset Voltage



Table of Contents

1 Features	1	6.4 Device Functional Modes.....	19
2 Applications	1	7 Application and Implementation	20
3 Description	1	7.1 Application Information.....	20
4 Pin Configuration and Functions	3	7.2 Typical Applications.....	20
5 Specifications	6	7.3 Power Supply Recommendations.....	23
5.1 Absolute Maximum Ratings.....	6	7.4 Layout.....	23
5.2 ESD Ratings.....	6	8 Device and Documentation Support	24
5.3 Recommended Operating Conditions.....	6	8.1 Device Support.....	24
5.4 Thermal Information OPA383.....	7	8.2 Receiving Notification of Documentation Updates....	24
5.5 Thermal Information OPA2383.....	7	8.3 Support Resources.....	24
5.6 Thermal Information OPA4383.....	7	8.4 Trademarks.....	24
5.7 Electrical Characteristics.....	8	8.5 Electrostatic Discharge Caution.....	24
5.8 Typical Characteristics.....	11	8.6 Glossary.....	24
6 Detailed Description	18	9 Revision History	25
6.1 Overview.....	18	10 Mechanical, Packaging, and Orderable Information	25
6.2 Functional Block Diagram.....	18		
6.3 Feature Description.....	19		

4 Pin Configuration and Functions

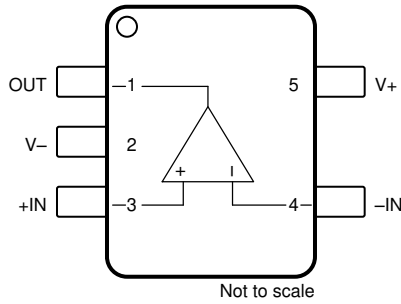

Figure 4-1. OPA383: DBV (Preview) Package, 5-Pin SOT-23 (Top View)

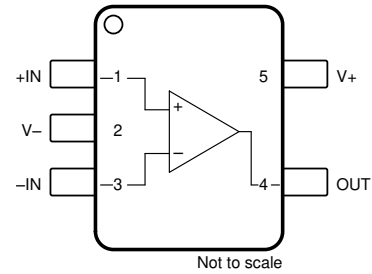

Figure 4-2. OPA383: DCK (Preview) Package, 5-Pin SC70 (Top View)

Table 4-1. Pin Functions: OPA383

NAME	PIN		TYPE	DESCRIPTION
	NO.			
	DBV (SOT-23)	DCK (SC70)		
-IN	4	3	Input	Inverting input
+IN	3	1	Input	Noninverting input
OUT	1	4	Output	Output
V-	2	2	Power	Negative (lowest) power supply
V+	5	5	Power	Positive (highest) power supply

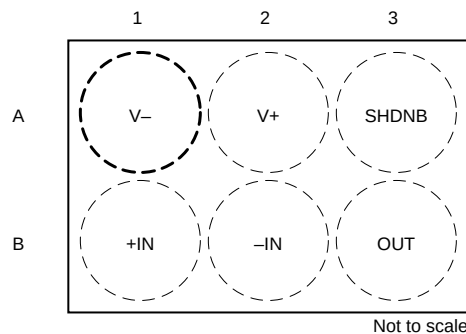

Figure 4-3. OPA383: YCH Package, 6-Pin DSBGA (Top View)

Table 4-2. Pin Functions: OPA383 DSBGA

NAME	PIN		TYPE	DESCRIPTION
	NO.			
	YBJ (DSBGA)			
+IN	B1	Input	Inverting input	
-IN	B2	Input	Noninverting input	
OUT	B3	Output	Output	
V-	A1	Power	Negative (lowest) power supply	
V+	A2	Power	Positive (highest) power supply	
SHDN / SHDNB	A3	Input	Shutdown logic: Low = amp disabled, High = amp enabled	

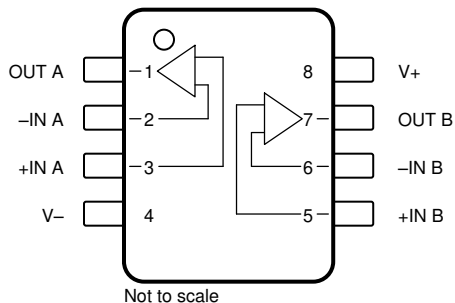

Figure 4-4. OPA2383: DDF (Preview) Package, 8-Pin SOT-23, and DGK Package, 8-Pin VSSOP (Top View)

Table 4-3. Pin Functions: OPA2383

NAME	PIN NO.		TYPE	DESCRIPTION
	DDF (SOT-23)	DGK (VSSOP)		
-IN A	2	2	Input	Inverting input, channel A
-IN B	6	6	Input	Inverting input, channel B
+IN A	3	3	Input	Noninverting input, channel A
+IN B	5	5	Input	Noninverting input, channel B
OUT A	1	1	Output	Output, channel A
OUT B	7	7	Output	Output, channel B
V-	4	4	Power	Negative (lowest) power supply
V+	8	8	Power	Positive (highest) power supply

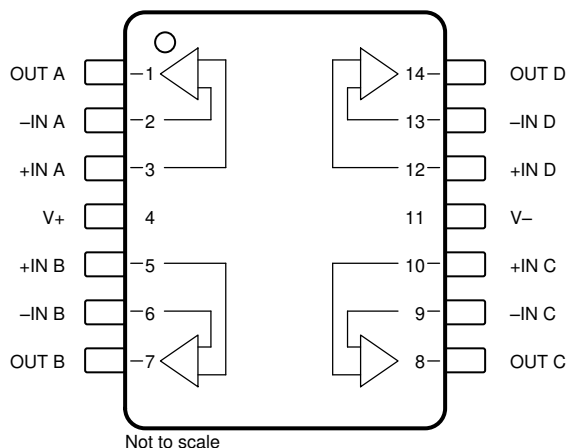

Figure 4-5. OPA4383: PW (Preview) Package, 14-Pin TSSOP (Top View)

Table 4-4. Pin Functions: OPA4383

NAME	PIN NO.		TYPE	DESCRIPTION
-IN A	2		Input	Inverting input, channel A
-IN B	6		Input	Inverting input, channel B
-IN C	9		Input	Inverting input, channel C
-IN D	13		Input	Inverting input, channel D
+IN A	3		Input	Noninverting input, channel A
+IN B	5		Input	Noninverting input, channel B
+IN C	10		Input	Noninverting input, channel C

Table 4-4. Pin Functions: OPA4383 (continued)

PIN		TYPE	DESCRIPTION
NAME	NO.		
+IN D	12	Input	Noninverting input, channel D
OUT A	1	Output	Output, channel A
OUT B	7	Output	Output, channel B
OUT C	8	Output	Output, channel C
OUT D	14	Output	Output, channel D
V-	11	Power	Negative (lowest) power supply
V+	4	Power	Positive (highest) power supply

5 Specifications

5.1 Absolute Maximum Ratings

over operating free-air temperature range (unless otherwise noted)⁽¹⁾

			MIN	MAX	UNIT
V _S	Supply voltage, V _S = (V+) – (V–)	Single-supply		6	V
		Dual-supply		±3	
	Input voltage, all pins (OPA383YCHR) ⁽²⁾ ⁽³⁾	Common-mode	(V–) – 0.5	(V–) + 6	V
	Input voltage, all pins	Common-mode	(V–) – 0.5	(V+) + 0.5	V
		Differential		(V+) – (V–) + 0.2	
	Input current, all pins			±10	mA
	Output short circuit ⁽⁴⁾		Continuous	Continuous	
T _A	Operating temperature		–55	150	°C
T _J	Junction temperature		–55	150	°C
T _{stg}	Storage temperature		–65	150	°C

- (1) Operation outside the *Absolute Maximum Ratings* may cause permanent device damage. *Absolute Maximum Ratings* do not imply functional operation of the device at these or any other conditions beyond those listed under *Recommended Operating Conditions*. If used outside the *Recommended Operating Conditions* but within the *Absolute Maximum Ratings*, the device may not be fully functional, and this may affect device reliability, functionality, performance, and shorten the device lifetime.
- (2) Input pins can swing beyond (V+) as long as they stay within 6.0V. No diode structure from input pins to (V+).
- (3) Input pins are diode-clamped to (V–). Input signals that 0.3V below (V–) must be current-limited to 10mA or less.
- (4) Short-circuit to ground, one amplifier per package.

5.2 ESD Ratings

				VALUE	UNIT
OPA383 PACKAGES					
V _(ESD)	Electrostatic discharge	Human-body model (HBM), per ANSI/ESDA/JEDEC JS-001 ⁽¹⁾		±2000	V
		Charged-device model (CDM), per ANSI/ESDA/JEDEC JS-002 ⁽²⁾		±1000	V
ALL OTHER PACKAGES					
V _(ESD)	Electrostatic discharge	Human-body model (HBM), per ANSI/ESDA/JEDEC JS-001 ⁽¹⁾		±3000	V
		Charged-device model (CDM), per ANSI/ESDA/JEDEC JS-002 ⁽²⁾		±1000	

- (1) JEDEC document JEP155 states that 500V HBM allows safe manufacturing with a standard ESD control process.
- (2) JEDEC document JEP157 states that 250V CDM allows safe manufacturing with a standard ESD control process.

5.3 Recommended Operating Conditions

over operating free-air temperature range (unless otherwise noted)

			MIN	NOM	MAX	UNIT
V _S	Supply voltage, V _S = (V+) – (V–)	Single-supply	1.7		5.5	V
		Dual-supply	±0.85		±2.75	
T _A	Specified temperature		–40		125	°C

5.4 Thermal Information OPA383

THERMAL METRIC ⁽¹⁾		OPA383		UNIT
		DBV (SOT-23)	YCH (DSBGA)	
		5 PINS	6 PINS	
$R_{\theta JA}$	Junction-to-ambient thermal resistance	183.4	136.5	°C/W
$R_{\theta JC(top)}$	Junction-to-case(top) thermal resistance	110.7	1.15	°C/W
$R_{\theta JB}$	Junction-to-board thermal resistance	49.2	39.5	°C/W
Ψ_{JT}	Junction-to-top characterization parameter	29.5	0.4	°C/W
Ψ_{JB}	Junction-to-board characterization parameter	49.1	39.5	°C/W
$R_{\theta JC(bot)}$	Junction-to-case(bottom) thermal resistance	N/A	N/A	°C/W

(1) For more information about traditional and new thermal metrics, see the [Semiconductor and IC Package Thermal Metrics](#) application report.

5.5 Thermal Information OPA2383

THERMAL METRIC ⁽¹⁾		OPA2383	UNIT
		DGK (VSSOP)	
		8 PINS	
$R_{\theta JA}$	Junction-to-ambient thermal resistance	165	°C/W
$R_{\theta JC(top)}$	Junction-to-case (top) thermal resistance	53	°C/W
$R_{\theta JB}$	Junction-to-board thermal resistance	87	°C/W
Ψ_{JT}	Junction-to-top characterization parameter	4.9	°C/W
Ψ_{JB}	Junction-to-board characterization parameter	85	°C/W
$R_{\theta JC(bot)}$	Junction-to-case (bottom) thermal resistance	N/A	°C/W

(1) For more information about traditional and new thermal metrics, see the [Semiconductor and IC Package Thermal Metrics](#) application report.

5.6 Thermal Information OPA4383

THERMAL METRIC ⁽¹⁾		OPA4383	UNIT
		PW (TSSOP)	
		14 PINS	
$R_{\theta JA}$	Junction-to-ambient thermal resistance	113.9	°C/W
$R_{\theta JC(top)}$	Junction-to-case (top) thermal resistance	42.9	°C/W
$R_{\theta JB}$	Junction-to-board thermal resistance	69.1	°C/W
Ψ_{JT}	Junction-to-top characterization parameter	2.2	°C/W
Ψ_{JB}	Junction-to-board characterization parameter	68.4	°C/W
$R_{\theta JC(bot)}$	Junction-to-case (bottom) thermal resistance	N/A	°C/W

(1) For more information about traditional and new thermal metrics, see the [Semiconductor and IC Package Thermal Metrics](#) application report.

5.7 Electrical Characteristics

at $T_A = 25^\circ\text{C}$, $R_L = 10\text{k}\Omega$ connected to $V_S / 2$, $V_S = 1.7\text{V}$ to 5.5V , $V_{CM} = V_S / 2$, $V_{OUT} = V_S / 2$, and min and max specification established from manufacturing final test (unless otherwise noted)

PARAMETER		TEST CONDITIONS		MIN	TYP	MAX	UNIT
OFFSET VOLTAGE							
V_{OS}	Input offset voltage ⁽¹⁾	$V_S = 5.5\text{V}$			± 0.4	± 5	μV
		$T_A = -40^\circ\text{C}$ to $+125^\circ\text{C}$			± 0.5		
dV_{OS}/dT	Input offset voltage drift	$T_A = -40^\circ\text{C}$ to $+125^\circ\text{C}$ ⁽¹⁾			± 0.004	± 0.025	$\mu\text{V}/^\circ\text{C}$
PSRR	Power supply rejection ratio				± 0.05	± 0.9	$\mu\text{V}/\text{V}$
		$T_A = -40^\circ\text{C}$ to $+125^\circ\text{C}$ ⁽¹⁾				± 0.9	
INPUT BIAS CURRENT							
I_B	Input bias current ⁽¹⁾				± 10	± 62	pA
		$T_A = -40^\circ\text{C}$ to $+85^\circ\text{C}$				± 76	
		$T_A = -40^\circ\text{C}$ to $+125^\circ\text{C}$					
I_B	Input bias current ⁽¹⁾	OPA383YCHR			± 85	± 140	pA
		OPA383YCHR, $T_A = -40^\circ\text{C}$ to $+85^\circ\text{C}$				± 3.3	nA
		OPA383YCHR, $T_A = -40^\circ\text{C}$ to $+125^\circ\text{C}$					± 20.5
I_{OS}	Input offset current ⁽¹⁾				± 20	± 123	pA
		$T_A = -40^\circ\text{C}$ to $+125^\circ\text{C}$					
I_{OS}	Input offset current ⁽¹⁾	OPA383YCHR			± 20	± 150	pA
		OPA383YCHR, $T_A = -40^\circ\text{C}$ to $+125^\circ\text{C}$					
NOISE							
	Input voltage noise	$f = 0.1\text{Hz}$ to 10Hz			650		nV_{PP}
					100		nV_{RMS}
e_N	Input voltage noise density	$f = 1\text{Hz}$			32		$\text{nV}/\sqrt{\text{Hz}}$
		$f = 10\text{Hz}$			32		
		$f = 100\text{Hz}$			32		
		$f = 1\text{kHz}$			32		
i_N	Input current noise	$f = 1\text{kHz}$			100		$\text{fA}/\sqrt{\text{Hz}}$
V_{CM}	Common-mode voltage range	$V_S = 5.5\text{V}$		$(V-) - 0.1$		$(V+) + 0.1$	V
		$V_S = 1.7\text{V}$		$(V-) - 0.1$		$(V+)$	
INPUT VOLTAGE							
CMRR	Common-mode rejection ratio	$(V-) - 0.1\text{V} < V_{CM} < (V+) + 0.1\text{V}$, $V_S = 5.5\text{V}$		122	135		dB
			$T_A = -40^\circ\text{C}$ to $+125^\circ\text{C}$ ⁽¹⁾	120			
		$(V-) - 0.1\text{V} < V_{CM} < (V+)$, $V_S = 1.7\text{V}$ ⁽¹⁾		116	130		
			$T_A = -40^\circ\text{C}$ to $+125^\circ\text{C}$	114			
INPUT CAPACITANCE							
Z_{ID}	Differential				100 6		$\text{M}\Omega$ pF
Z_{ICM}	Common-mode				60 1.5		$\text{G}\Omega$ pF
OPEN-LOOP GAIN							
A_{OL}	Open-loop voltage gain	$(V-) + 100\text{mV} < V_{OUT} < (V+) - 100\text{mV}$	$V_S = 5.5\text{V}$	120	145		dB
			$V_S = 1.7\text{V}$ ⁽¹⁾	120			
			$T_A = -40^\circ\text{C}$ to $+125^\circ\text{C}$ ⁽¹⁾	119			
		$(V-) + 150\text{mV} < V_{OUT} < (V+) - 150\text{mV}$, $R_L = 2\text{k}\Omega$	$V_S = 5.5\text{V}$	119	140		
			$V_S = 1.7\text{V}$ ⁽¹⁾	119			
			$T_A = -40^\circ\text{C}$ to $+125^\circ\text{C}$ ⁽¹⁾	118			

5.7 Electrical Characteristics (continued)

at $T_A = 25^\circ\text{C}$, $R_L = 10\text{k}\Omega$ connected to $V_S / 2$, $V_S = 1.7\text{V}$ to 5.5V , $V_{CM} = V_S / 2$, $V_{OUT} = V_S / 2$, and min and max specification established from manufacturing final test (unless otherwise noted)

PARAMETER		TEST CONDITIONS		MIN	TYP	MAX	UNIT
FREQUENCY RESPONSE							
GBW	Gain-bandwidth product			2.5			MHz
SR	Slew rate	4V step, $G = +1$		1			V/ μs
t_S	Settling time	To 0.1%, 1V step, $G = +1$		5.4			μs
		To 0.01%, 1V step, $G = +1$		48			
	Overload recovery time	$V_{IN} \times G > V_S$		2200			ns
	Chopping clock frequency ⁽¹⁾			130			kHz
THD+N	Total harmonic distortion + noise	$V_{OUT} = 1V_{RMS}$, $G = +1$, $f = 1\text{kHz}$		0.0012 %			
OUTPUT							
	Voltage output swing from rail	No load		1	10		mV
				5	30		
		$R_L = 2\text{k}\Omega$		60	150		
		$T_A = -40^\circ\text{C}$ to $+125^\circ\text{C}$ ⁽¹⁾		155			
	Voltage output swing from rail	OPA383YCHR, No load (Positive rail headroom)		1	25		mV
		OPA383YCHR, No load (Negative rail headroom)		1	10		
		OPA383YCHR		20	30		
		OPA383YCHR, $R_L = 2\text{k}\Omega$		100	150		
		OPA383YCHR, $T_A = -40^\circ\text{C}$ to $+125^\circ\text{C}$ ⁽¹⁾		155			
	High linearity output swing range ⁽¹⁾	$A_{OL} > 119\text{dB}$		$(V-) + 0.075$	$(V+) - 0.075$		V
			$R_L = 2\text{k}\Omega$	$(V-) + 0.150$	$(V+) - 0.150$		
I_{SC}	Short-circuit current	$V_S = 5.5\text{V}$		± 28			mA
		$V_S = 1.7\text{V}$		± 2.5			
C_{LOAD}	Capacitive load drive			See the typical characteristic curve			
R_O	Open-loop output impedance	$f = 1\text{MHz}$		2.5			k Ω
POWER SUPPLY							
I_Q	Quiescent current per amplifier	$I_O = 0\text{mA}$		65	100		μA
			$T_A = -40^\circ\text{C}$ to 125°C ⁽¹⁾	110			
	Turn-on time	At $V_S = 5.5\text{V}$, V_S ramp rate $> 0.05\text{V}/\mu\text{s}$, settle to 1%		180			μs
SHUTDOWN							
I_{QSD}	Quiescent current per amplifier ⁽¹⁾	$V_S = 5\text{V}$, $\overline{\text{SHDN}} = V-$ (Amplifiers disabled)		90	130		nA
			$T_A = -40^\circ\text{C}$ to 85°C	200			
			$T_A = -40^\circ\text{C}$ to 125°C	455			
		$V_S = 3.3\text{V}$, $\overline{\text{SHDN}} = V-$ (Amplifiers disabled)		80	120		
			$T_A = -40^\circ\text{C}$ to 85°C	180			
			$T_A = -40^\circ\text{C}$ to 125°C	395			
Z_{SHDN}	Output impedance during shutdown	Amplifier disabled, $\overline{\text{SHDN}} = V-$		12 7			G Ω pF
V_{IH}	Logic high threshold voltage (amplifier enabled)			$(V-) + 0.85\text{V}$			V
V_{IL}	Logic low threshold voltage (amplifier disabled)			$(V-) + 0.35\text{V}$			V
t_{ON}	Amplifier enable ⁽²⁾	$V_S = 3.3\text{V}$, $G = +1$, $V_{CM} = V_S / 2$, $V_O = 0.9 \times V_S / 2$, R_L connected to $V-$		158			μs
t_{OFF}	Amplifier disable time ⁽²⁾	$V_S = 3.3\text{V}$, $G = +1$, $V_{CM} = V_S / 2$, $V_O = 0.1 \times V_S / 2$, R_L connected to $V-$		18			μs

5.7 Electrical Characteristics (continued)

at $T_A = 25^\circ\text{C}$, $R_L = 10\text{k}\Omega$ connected to $V_S / 2$, $V_S = 1.7\text{V}$ to 5.5V , $V_{CM} = V_S / 2$, $V_{OUT} = V_S / 2$, and min and max specification established from manufacturing final test (unless otherwise noted)

PARAMETER		TEST CONDITIONS	MIN	TYP	MAX	UNIT
I_{BSD}	SHDN pin input bias current ⁽¹⁾	$V_S = 5\text{V}$, SHDN = V– (Amplifiers disabled)		31	200	pA
			$T_A = -40^\circ\text{C}$ to 85°C		210	
			$T_A = -40^\circ\text{C}$ to 125°C		610	
		$V_S = 3.3\text{V}$, SHDN = V– (Amplifiers disabled)		13	210	
			$T_A = -40^\circ\text{C}$ to 85°C		220	
			$T_A = -40^\circ\text{C}$ to 125°C		580	
		$V_S = 5\text{V}$, SHDN = V+ (Amplifiers enabled)		105	200	pA
			$T_A = -40^\circ\text{C}$ to 85°C		2.35	nA
			$T_A = -40^\circ\text{C}$ to 125°C		16.5	
		$V_S = 3.3\text{V}$, SHDN = V+ (Amplifiers enabled)		63	130	pA
			$T_A = -40^\circ\text{C}$ to 85°C		3.1	nA
			$T_A = -40^\circ\text{C}$ to 125°C		21.2	

(1) Specification established from device population bench system measurements across multiple lots.

(2) Disable time (t_{OFF}) and enable time (t_{ON}) are defined as the time interval between the 50% point of the signal applied to the SHDN pin and the point at which the output voltage reaches the 10% (disable) or 90% (enable) level.

5.8 Typical Characteristics

at $T_A = 25^\circ\text{C}$, $V_S = \pm 2.75\text{V}$, $V_{CM} = V_S / 2$, $R_{LOAD} = 10\text{k}\Omega$ connected to $V_S / 2$, and $C_L = 50\text{pF}$ (unless otherwise noted)

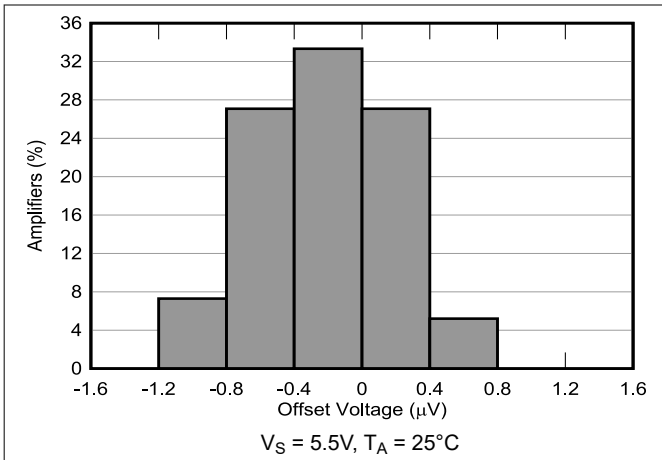

Figure 5-1. Offset Voltage Distribution

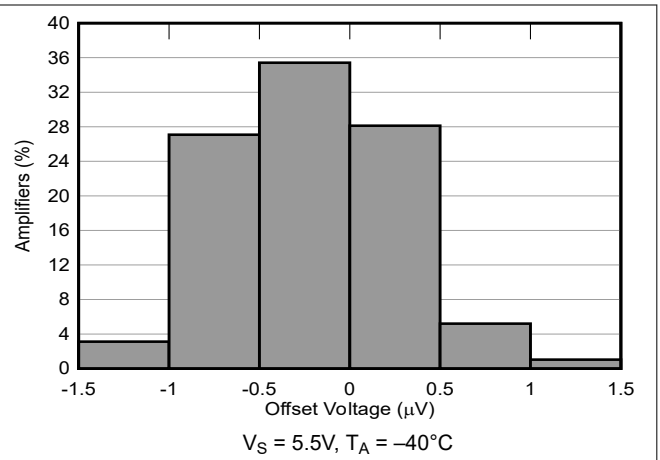

Figure 5-2. Offset Voltage Distribution

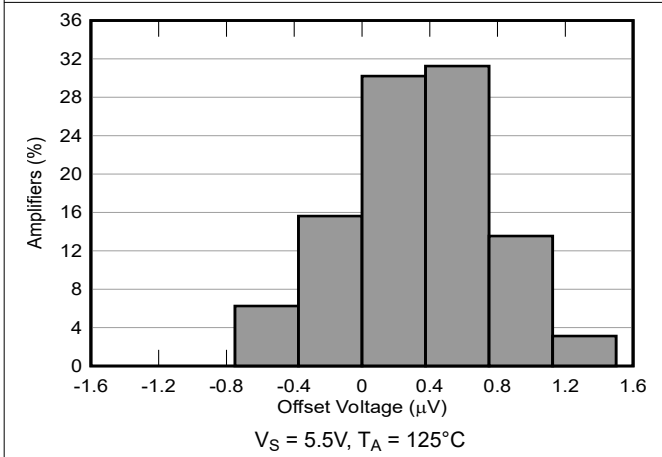

Figure 5-3. Offset Voltage Distribution

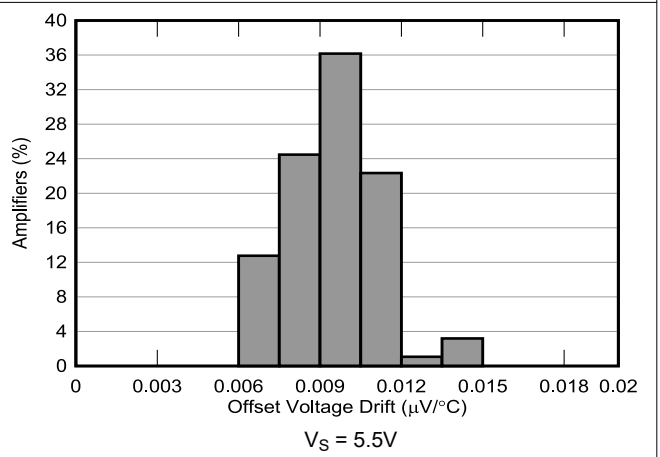

Figure 5-4. Offset Voltage Drift Distribution

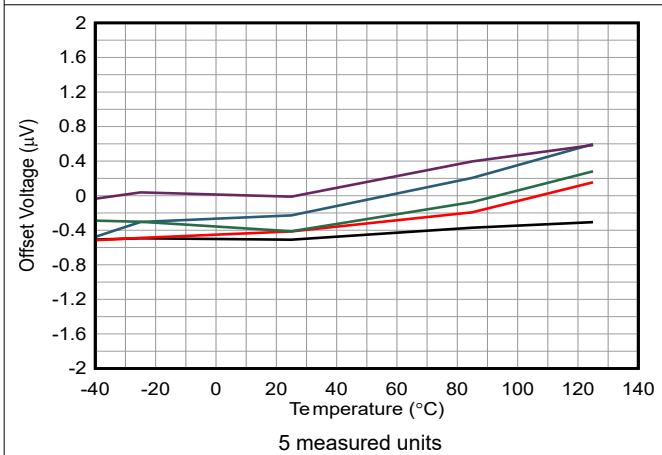

Figure 5-5. Offset Voltage vs Temperature

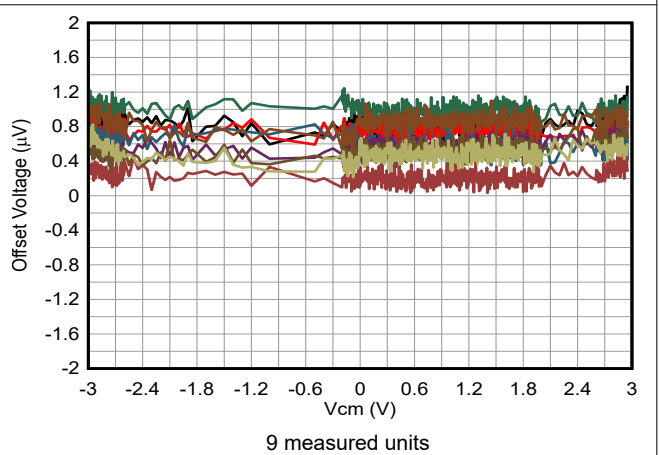
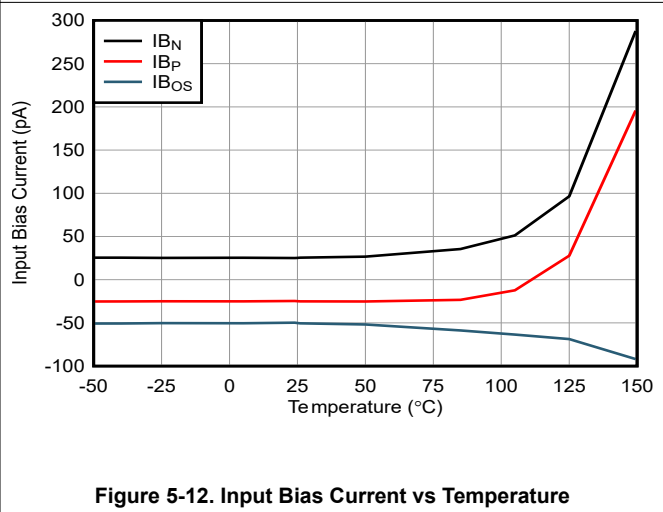
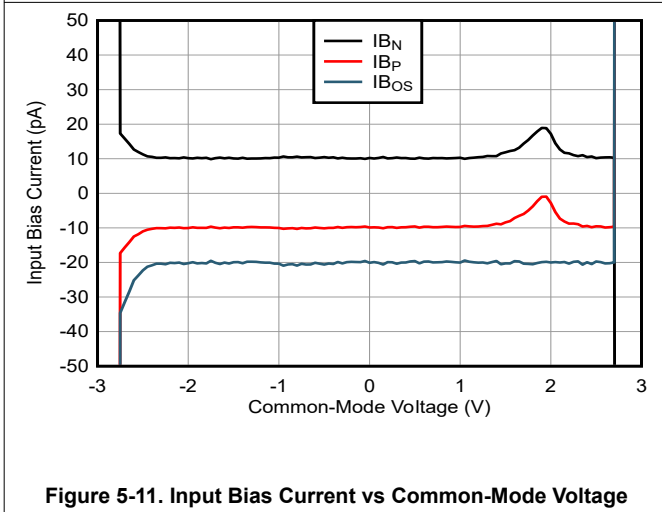
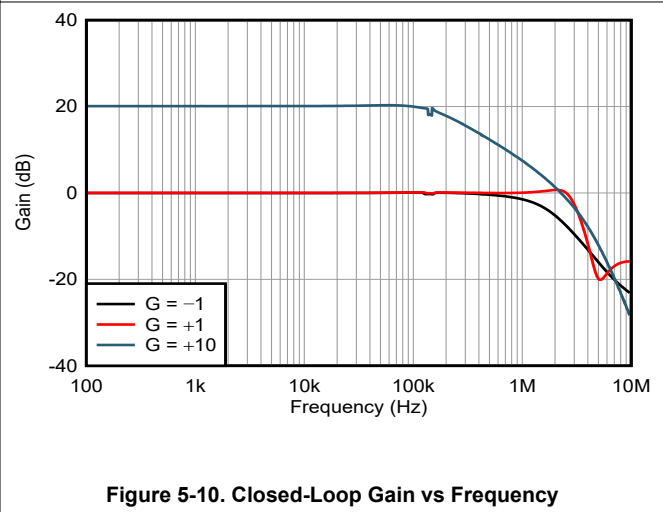
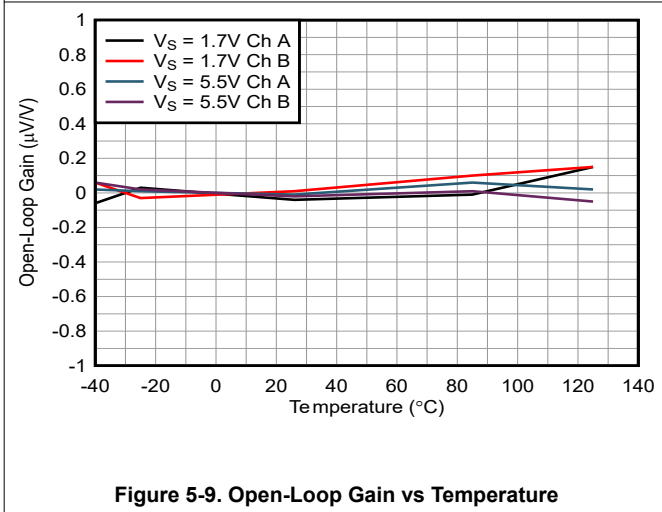
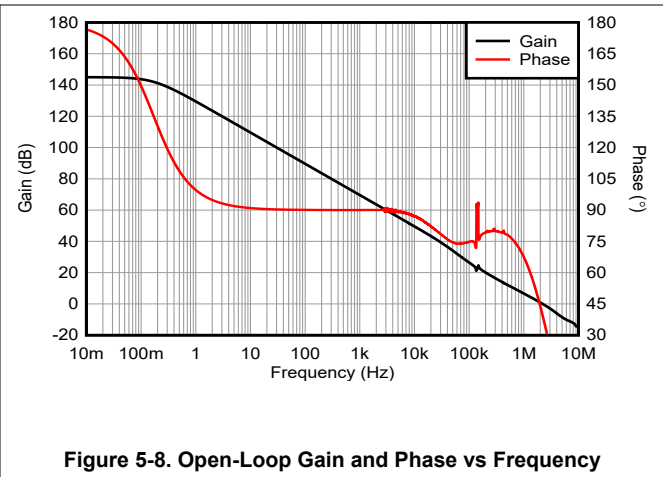
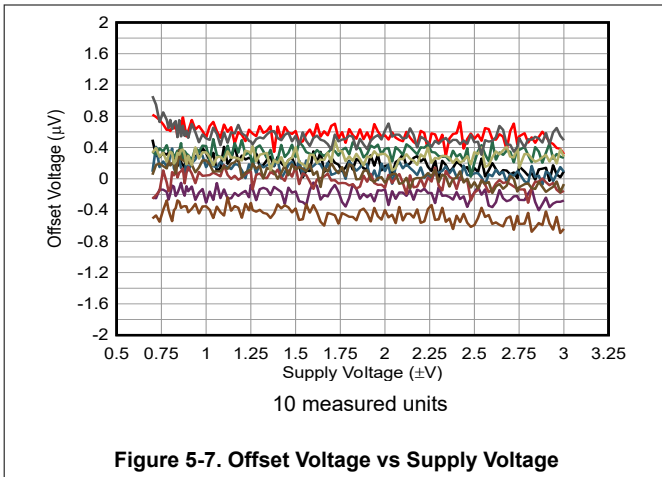

Figure 5-6. Offset Voltage vs Common-Mode Voltage

5.8 Typical Characteristics (continued)

at $T_A = 25^\circ\text{C}$, $V_S = \pm 2.75\text{V}$, $V_{CM} = V_S / 2$, $R_{LOAD} = 10\text{k}\Omega$ connected to $V_S / 2$, and $C_L = 50\text{pF}$ (unless otherwise noted)



5.8 Typical Characteristics (continued)

at $T_A = 25^\circ\text{C}$, $V_S = \pm 2.75\text{V}$, $V_{CM} = V_S / 2$, $R_{LOAD} = 10\text{k}\Omega$ connected to $V_S / 2$, and $C_L = 50\text{pF}$ (unless otherwise noted)

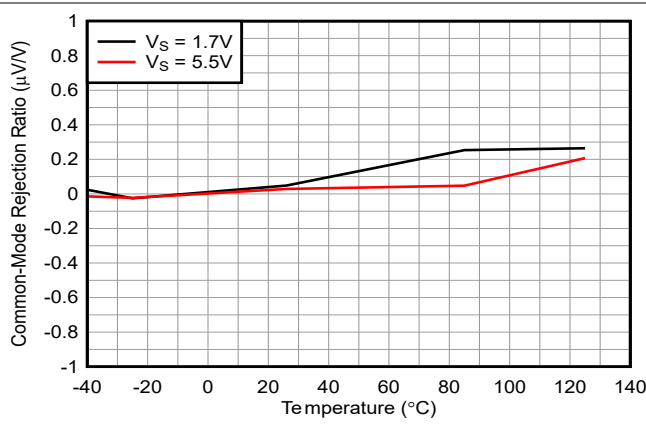

Figure 5-13. CMRR vs Temperature

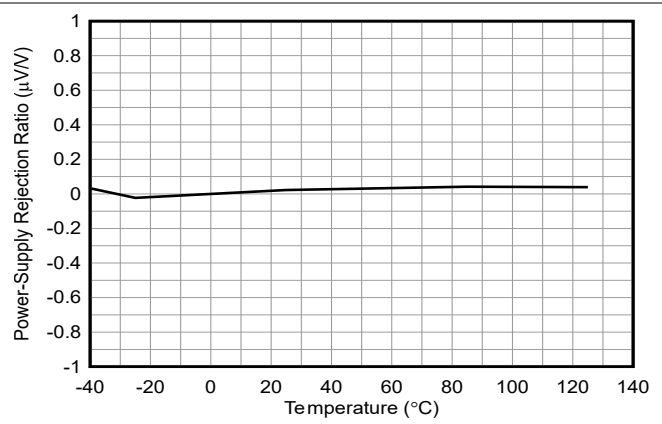

Figure 5-14. PSRR vs Temperature

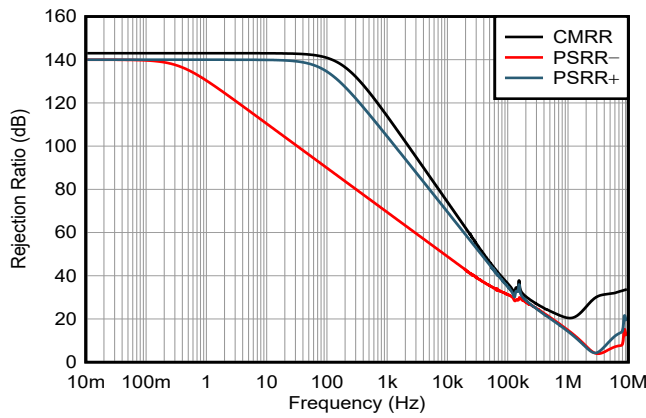

Figure 5-15. PSRR and CMRR vs Frequency

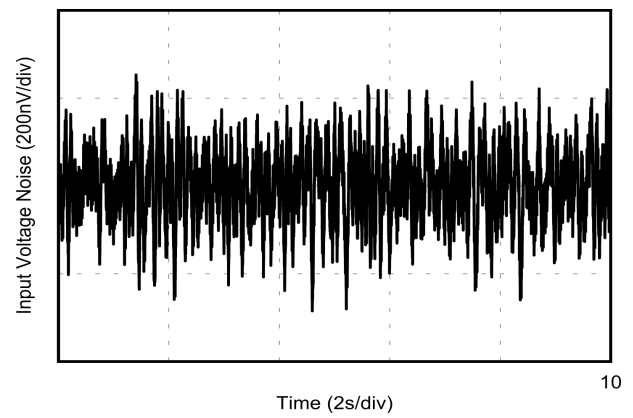

Figure 5-16. 0.1Hz to 10Hz Noise

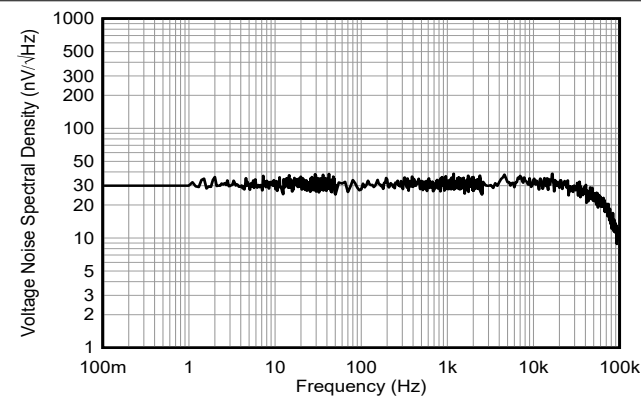

Figure 5-17. Input Voltage Noise Spectral Density vs Frequency

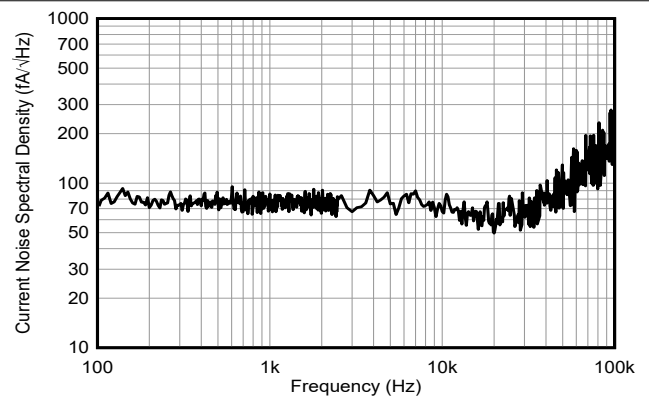

Figure 5-18. Input Current Noise Spectral Density vs Frequency

5.8 Typical Characteristics (continued)

at $T_A = 25^\circ\text{C}$, $V_S = \pm 2.75\text{V}$, $V_{CM} = V_S / 2$, $R_{LOAD} = 10\text{k}\Omega$ connected to $V_S / 2$, and $C_L = 50\text{pF}$ (unless otherwise noted)

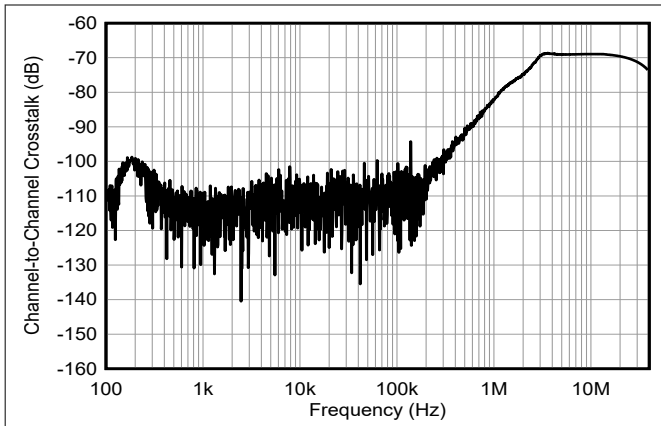

Figure 5-19. Channel-to-Channel Crosstalk

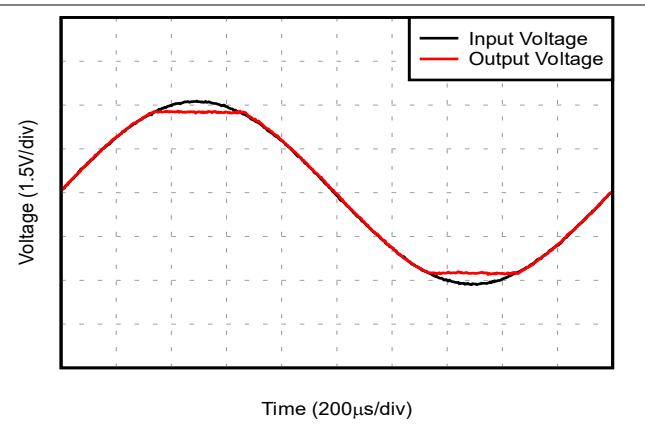
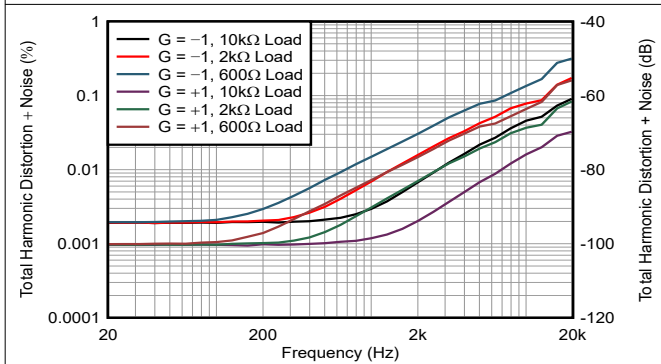
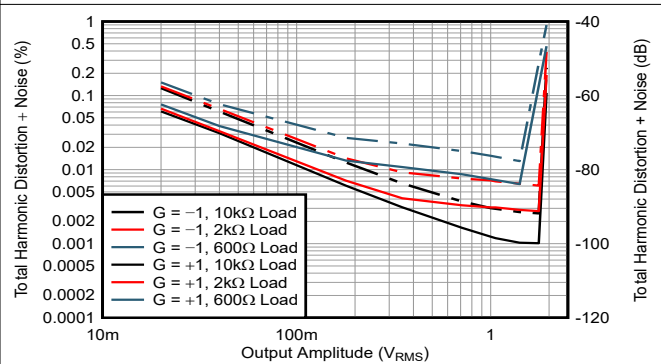

Figure 5-20. No Phase Reversal



$V_S = 5.5\text{V}$, $V_{OUT} = 3V_{RMS}$, $BW = 80\text{kHz}$

Figure 5-21. THD+N Ratio vs Frequency



$V_S = 5.5\text{V}$, $f = 1\text{kHz}$, $BW = 80\text{kHz}$

Figure 5-22. THD+N vs Output Amplitude

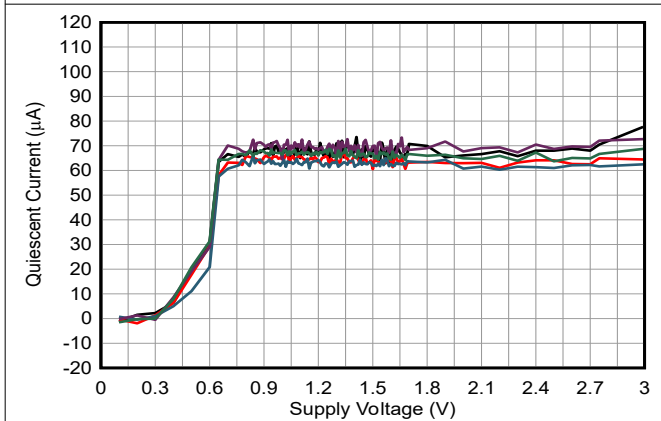

Figure 5-23. Quiescent Current vs Supply Voltage

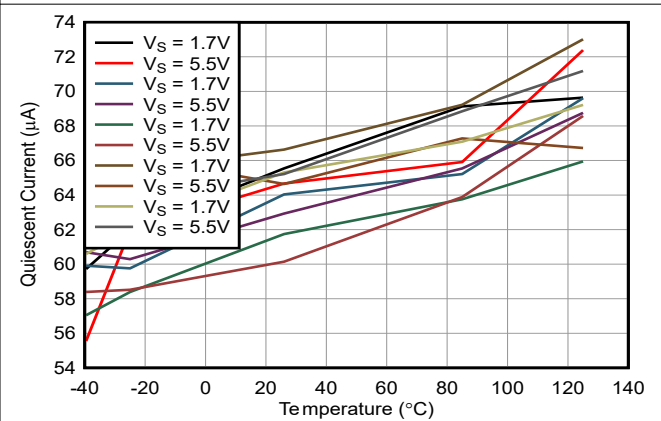

Figure 5-24. Quiescent Current vs Temperature

5.8 Typical Characteristics (continued)

at $T_A = 25^\circ\text{C}$, $V_S = \pm 2.75\text{V}$, $V_{CM} = V_S / 2$, $R_{LOAD} = 10\text{k}\Omega$ connected to $V_S / 2$, and $C_L = 50\text{pF}$ (unless otherwise noted)

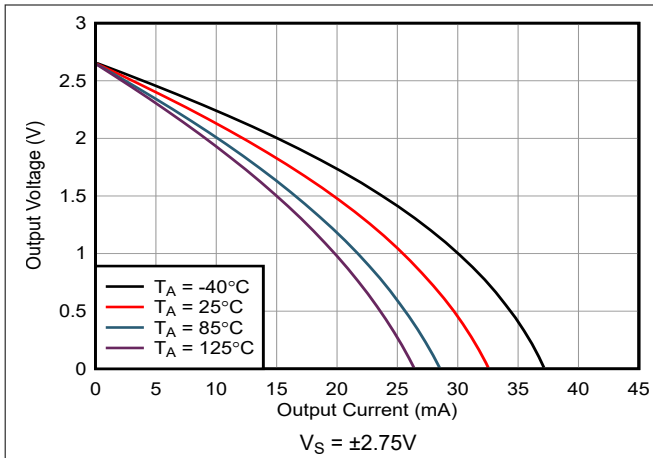

Figure 5-25. Output Voltage vs Output Current (Sourcing)

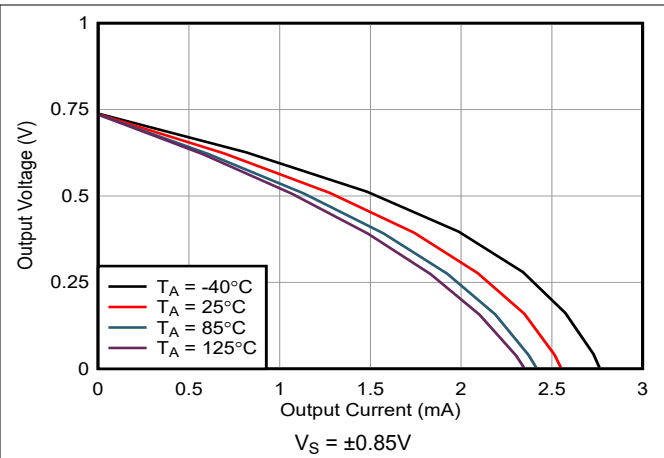

Figure 5-26. Output Voltage vs Output Current (Sourcing)

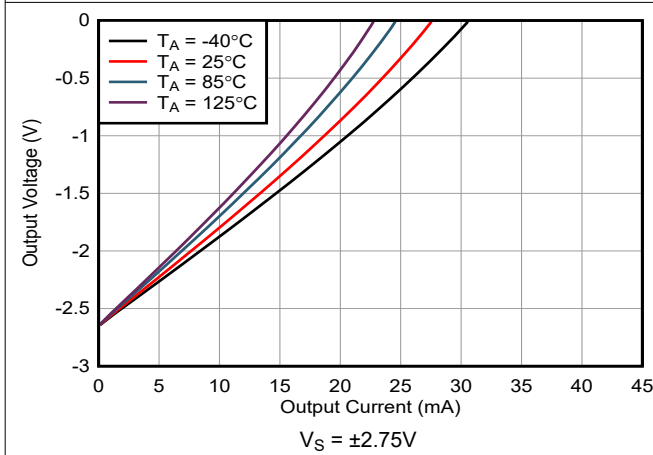

Figure 5-27. Output Voltage vs Output Current (Sinking)

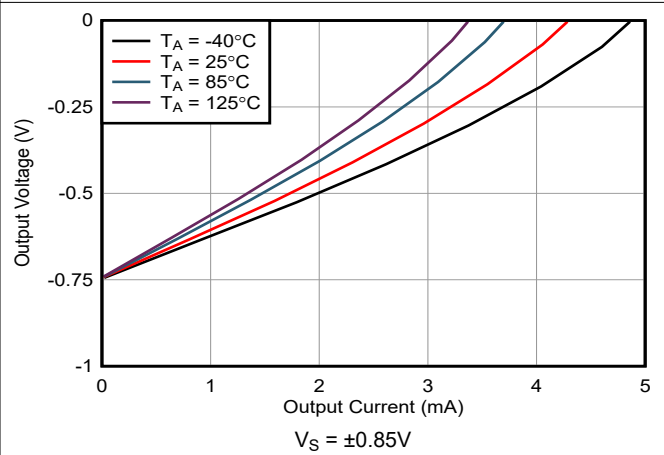

Figure 5-28. Output Voltage vs Output Current (Sinking)

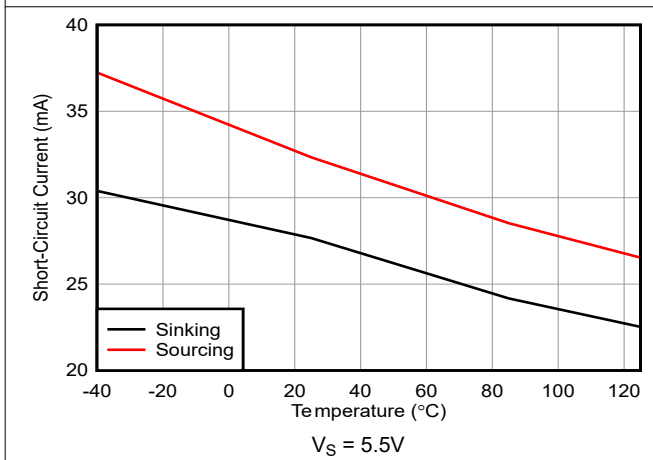

Figure 5-29. Short Circuit Current vs Temperature

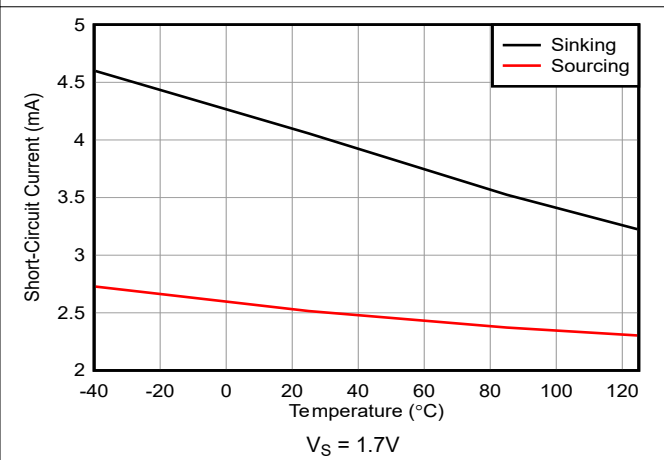

Figure 5-30. Short Circuit Current vs Temperature

5.8 Typical Characteristics (continued)

at $T_A = 25^\circ\text{C}$, $V_S = \pm 2.75\text{V}$, $V_{CM} = V_S / 2$, $R_{LOAD} = 10\text{k}\Omega$ connected to $V_S / 2$, and $C_L = 50\text{pF}$ (unless otherwise noted)

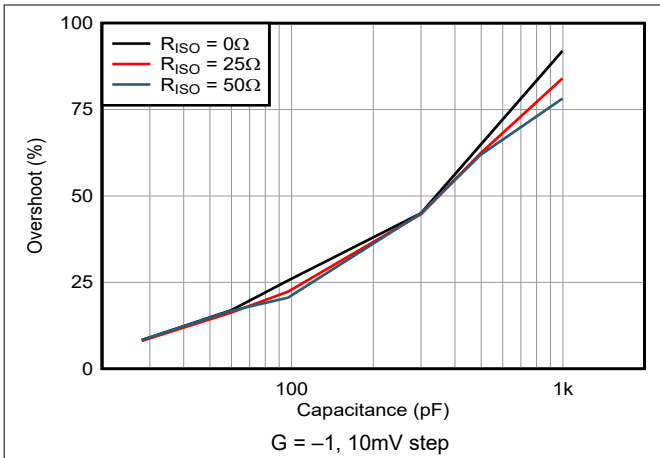

Figure 5-31. Small-Signal Overshoot vs Capacitive Load

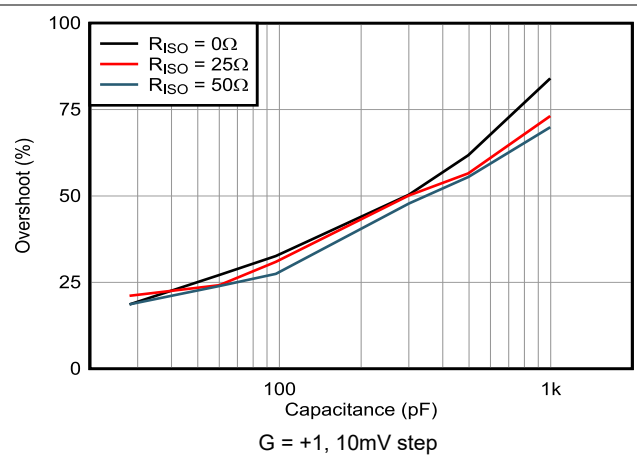

Figure 5-32. Small-Signal Overshoot vs Capacitive Load

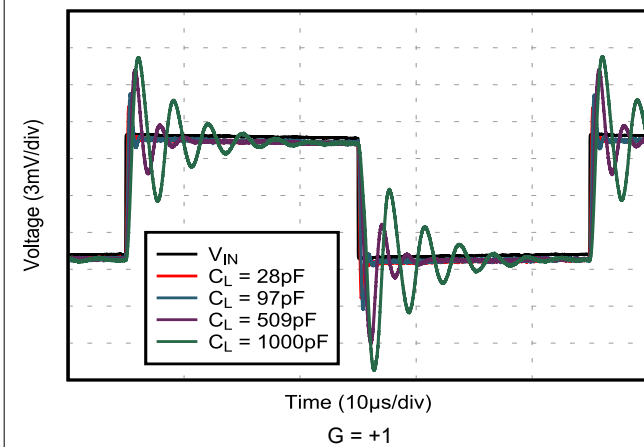

Figure 5-33. Small-Signal Voltage Transient Response vs Capacitive Load (C_L)

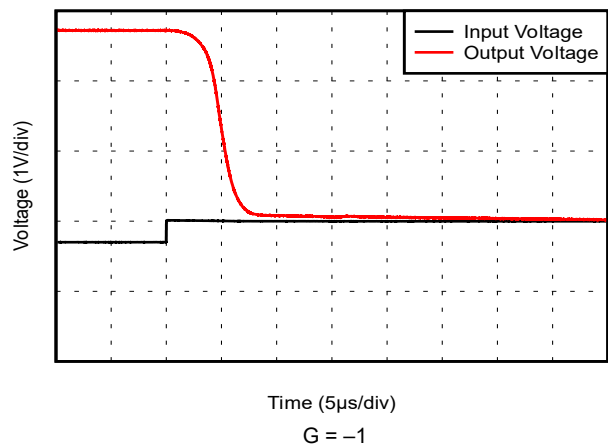

Figure 5-34. Overload Recovery

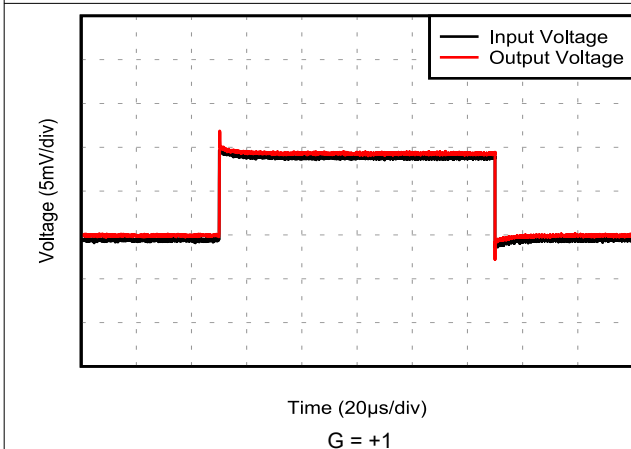

Figure 5-35. Small-Signal Step Response

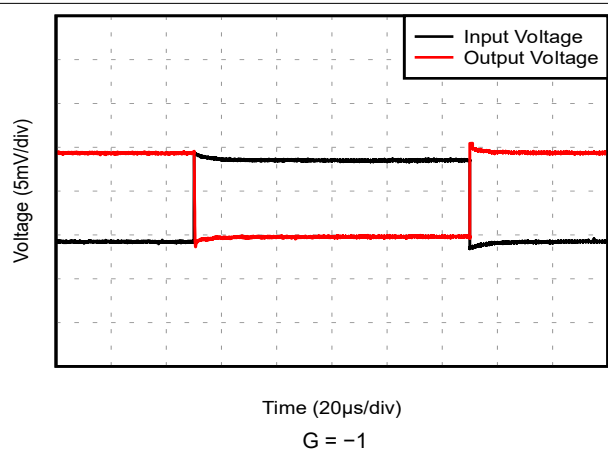
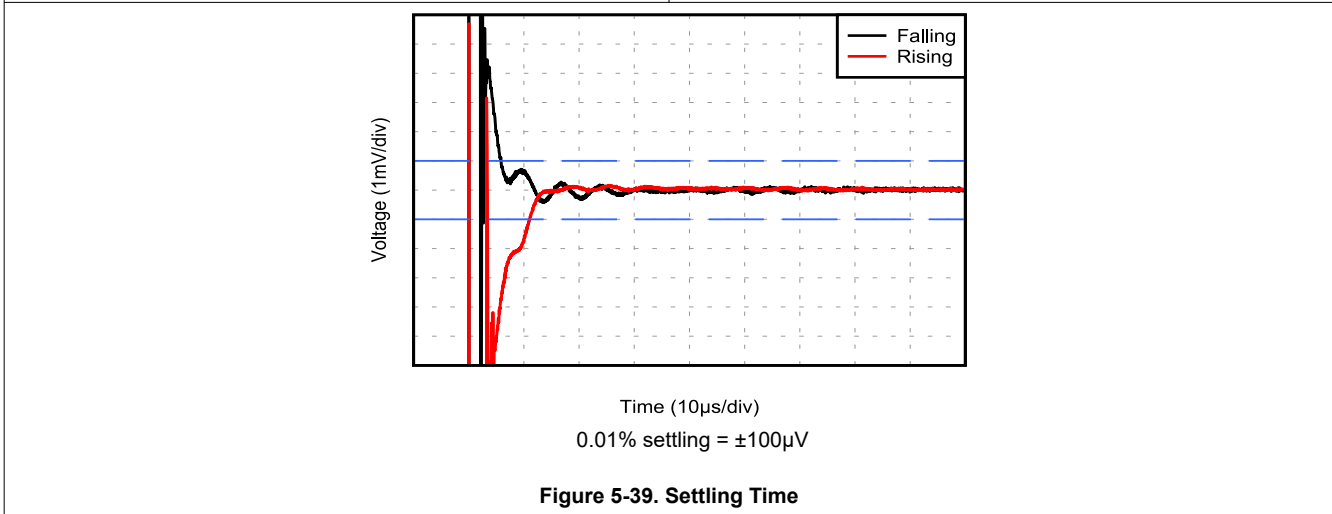
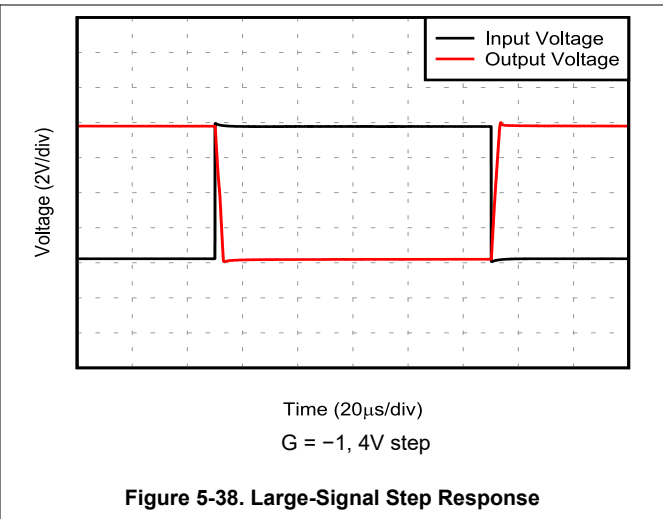
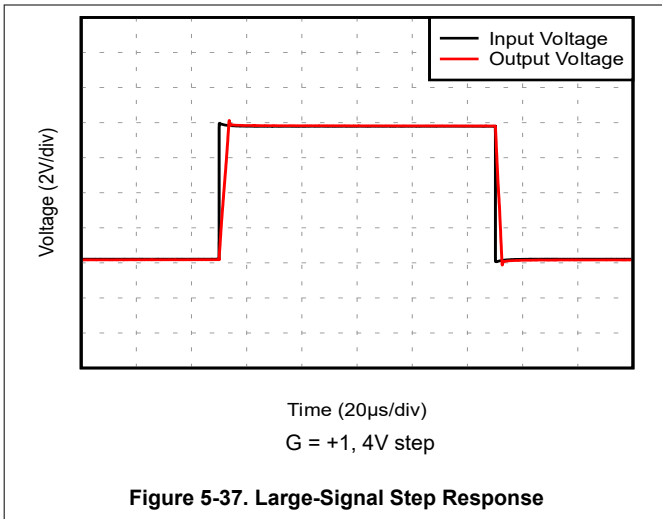

Figure 5-36. Small-Signal Step Response

5.8 Typical Characteristics (continued)

at $T_A = 25^\circ\text{C}$, $V_S = \pm 2.75\text{V}$, $V_{CM} = V_S / 2$, $R_{LOAD} = 10\text{k}\Omega$ connected to $V_S / 2$, and $C_L = 50\text{pF}$ (unless otherwise noted)



6.3 Feature Description

6.3.1 Input Bias Current

During normal operation, the typical input bias current of the OPAx383 is 10pA. The device exhibits low drift over the full temperature range of -40°C to $+125^{\circ}\text{C}$. There are no antiparallel diodes between the input pins (+IN and -IN); therefore, the differential input maximum voltage is limited only by diodes connected to the supply voltage pins. However, use caution in cases where the input differential voltage exceeds the nominal operating input differential voltage. When inputs are separated, the switching offset-cancellation path internal to the amplifier exceeds normal operating conditions, and can potentially create long settling behavior upon return to normal operation. [Figure 6-1](#) shows the equivalent input circuit of OPAx383.

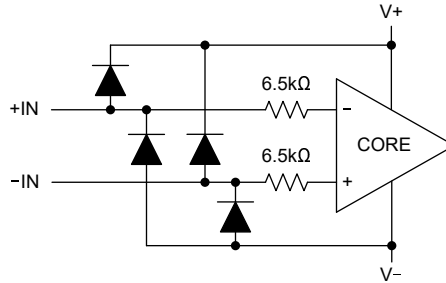

Figure 6-1. Equivalent Input Circuit

6.3.2 EMI Susceptibility and Input Filtering

Operational amplifiers can exhibit sensitivity to electromagnetic interference (EMI). Typically, conducted EMI (that is, EMI that enters the device through conduction) is more commonly observed than radiated EMI (that is, EMI that enters the device through radiation). When conducted EMI enters the operational amplifier, the dc offset at the amplifier output can shift from the nominal value. This shift is a result of signal rectification associated with the internal semiconductor junctions. Although all operational amplifier pin functions can be affected by EMI, the input pins are likely to be the most susceptible. The OPAx383 operational amplifier family incorporates an internal input low-pass filter that reduces the amplifier response to EMI. Both common-mode and differential-mode filtering are provided by the input filter. The conducted EMI rejection of the OPAx383 is seen in [Figure 6-2](#).

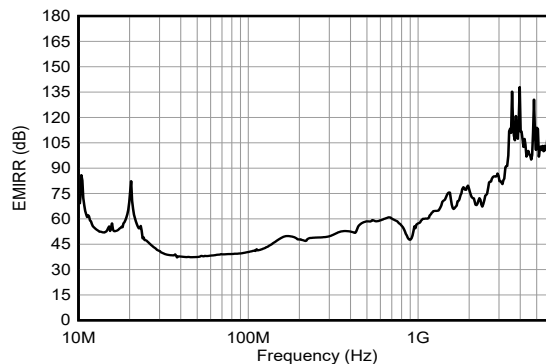

Figure 6-2. EMI Rejection Ratio

6.4 Device Functional Modes

The OPAx383 have a single functional mode and are operational when the power-supply voltage is greater than 1.7V ($\pm 0.85\text{V}$). The maximum specified power-supply voltage for the OPAx383 is 5.5V ($\pm 2.75\text{V}$). The OPA383S features a shutdown pin, which can be used to place the op amp into a low-power mode.

7 Application and Implementation

Note

Information in the following applications sections is not part of the TI component specification, and TI does not warrant its accuracy or completeness. TI's customers are responsible for determining suitability of components for their purposes, as well as validating and testing their design implementation to confirm system functionality.

7.1 Application Information

The OPAx383 are unity-gain stable, precision, operational amplifiers featuring state-of-the-art, zero-drift technology. The use of proprietary zero-drift circuitry gives the benefit of low input offset voltage over time and temperature, as well as lower $1/f$ noise component. As a result of the high PSRR, the devices work well in applications that run directly from battery power without regulation. The OPAx383 family is optimized for full rail-to-rail input, allowing for low-voltage, single-supply operation or split-supply use. These miniature, high-precision, low-noise amplifiers offer high-impedance inputs that have a common-mode range 100mV beyond the supplies without input crossover distortion, and a rail-to-rail output that swings within 5mV of the supplies under normal test conditions. The OPAx383 precision amplifiers are designed for upstream analog signal-chain applications in low or high gains, as well as downstream signal-chain functions, such as DAC buffering.

7.1.1 Zero-Drift Clocking

The OPAx383 use an advanced zero-drift architecture to achieve ultra-low offset and offset drift. This architecture uses a clock and switches internally to create a dc error-correction path. The clocking is filtered internally, and typically not observable for most configurations. Take the following precautions to minimize clock noise in the signal chain. The clocking creates a small charge-injection pulse at the input of the amplifier; therefore, do not use high-value resistors ($> 100\text{k}\Omega$) in series with the inputs to avoid higher clock voltage noise at the output. The charge injection pulses are minimized when the impedance to the input pins is matched. If higher value resistors are used, then use matching impedances on both amplifier input pins.

7.2 Typical Applications

7.2.1 Bidirectional Current Sensing

This single-supply, low-side, bidirectional current-sensing design example detects load currents from -1A to $+1\text{A}$. The single-ended output spans from 110mV to 3.19V. This design uses the OPAx383 because of the device low offset voltage and rail-to-rail input and output. One of the amplifiers is configured as a difference amplifier and the other amplifier provides the reference voltage. [Figure 7-1](#) shows the design example schematic.

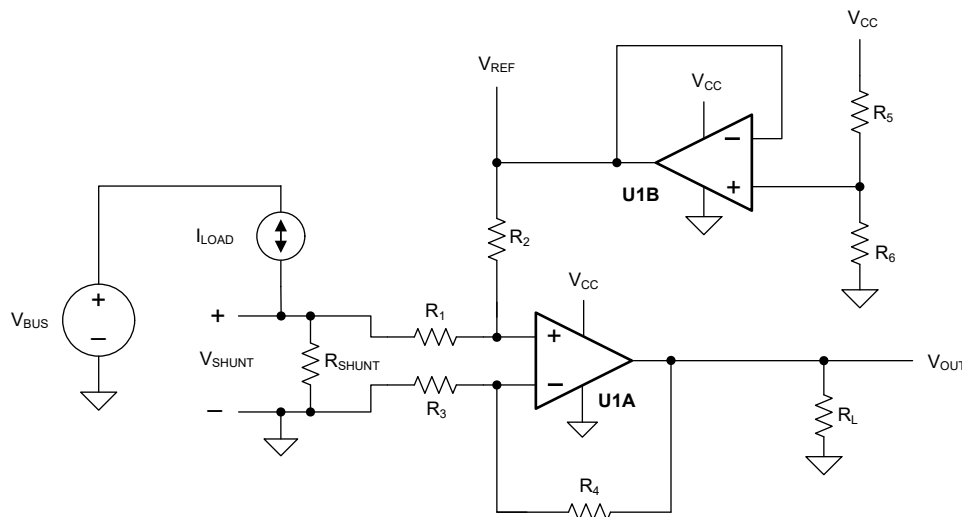

Figure 7-1. Bidirectional Current-Sensing Schematic

7.2.1.1 Design Requirements

This design has the following requirements:

- Supply voltage: 3.3V
- Input: –1A to +1A
- Output: 1.65V ±1.54V (110mV to 3.19V)

7.2.1.2 Detailed Design Procedure

The load current, I_{LOAD} , flows through the shunt resistor, R_{SHUNT} , to develop the shunt voltage, V_{SHUNT} . The shunt voltage is then amplified by the difference amplifier consisting of U1A and R_1 through R_4 . The gain of the difference amplifier is set by the ratio of R_4 to R_3 . To minimize errors, set $R_2 = R_4$ and $R_1 = R_3$. The reference voltage, V_{REF} , is supplied by buffering a resistor divider using U1B. The transfer function is given by [Equation 1](#):

$$V_{OUT} = V_{SHUNT} \times \text{Gain}_{\text{Diff-Amp}} + V_{REF} \quad (1)$$

where

- $V_{SHUNT} = I_{LOAD} \times R_{SHUNT}$
- $\text{Gain}_{\text{Diff-Amp}} = \frac{R_4}{R_3}$
- $V_{REF} = V_{CC} \times \left(\frac{R_6}{R_5 + R_6} \right)$

There are two types of errors in this design: gain and offset. Gain errors are introduced by the tolerance of the shunt resistor and the ratios of R_4 to R_3 and, similarly, R_2 to R_1 . Offset errors are introduced by the voltage divider (R_5 and R_6) and how closely the ratio of R_4 / R_3 matches R_2 / R_1 . The latter value affects the CMRR of the difference amplifier, ultimately translating to an offset error.

The value of V_{SHUNT} is the ground potential for the system load because V_{SHUNT} is a low-side measurement. Therefore, a maximum value must be placed on V_{SHUNT} . In this design, the maximum value for V_{SHUNT} is set to 100mV. [Equation 2](#) calculates the maximum value of the shunt resistor given a maximum shunt voltage of 100mV and maximum load current of 1A.

$$R_{SHUNT(\text{MAX})} = \frac{V_{SHUNT(\text{MAX})}}{I_{LOAD(\text{MAX})}} = \frac{100\text{mV}}{1\text{A}} = 100\text{m}\Omega \quad (2)$$

The tolerance of R_{SHUNT} is directly proportional to cost. For this design, a shunt resistor with a tolerance of 0.5% is selected. If greater accuracy is required, select a 0.1% resistor or better.

The load current is bidirectional; therefore, the shunt voltage range is –100mV to +100mV. This voltage is divided down by R_1 and R_2 before reaching the operational amplifier, U1A. Make sure that the voltage present at the noninverting node of U1A is within the common-mode range of the device. Use an operational amplifier, such as the OPAx383, that has a common-mode range that extends below the negative supply voltage. The offset error is minimal because the OPAx383 has a typical offset voltage of merely ±0.5μV (±5μV, maximum).

Given a symmetric load current of –1A to +1A, the voltage divider resistors, R_5 and R_6 , must be equal. To be consistent with the shunt resistor, a tolerance of 0.5% is selected. To minimize power consumption, 10kΩ resistors are used.

To set the gain of the difference amplifier, the common-mode range and output swing of the OPAx383 must be considered. [Equation 3](#) and [Equation 4](#) depict the typical common-mode range and maximum output swing, respectively, of the OPAx383 given a 3.3V supply.

$$-100\text{mV} < V_{CM} < 3.4\text{V} \quad (3)$$

$$100\text{mV} < V_{OUT} < 3.2\text{V} \quad (4)$$

The gain of the difference amplifier is now calculated using [Equation 5](#).

$$\text{Gain}_{\text{Diff-Amp}} = \frac{V_{\text{OUT(MAX)}} - V_{\text{OUT(MIN)}}}{R_{\text{SHUNT}} \times (I_{\text{MAX}} - I_{\text{MIN}})} = \frac{3.2\text{V} - 100\text{mV}}{100\text{m}\Omega \times (1\text{A} - (-1\text{A}))} = 15.5 \frac{\text{V}}{\text{V}} \quad (5)$$

The resistor value selected for R₁ and R₃ is 1kΩ. 15.4kΩ is selected for R₂ and R₄ because this number is the nearest standard value. Therefore, the calculated gain of the difference amplifier is 15.4V/V.

The gain error of the circuit primarily depends on R₁ through R₄. As a result of this dependence, select 0.1% resistors. This configuration reduces the likelihood that the design requires a two-point calibration. A simple one-point calibration, if desired, removes the offset errors introduced by the 0.5% resistors.

7.2.1.3 Application Curve

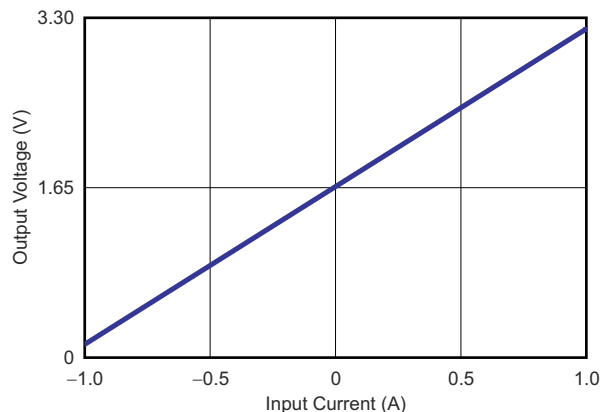

Figure 7-2. Bidirectional Current-Sensing Circuit Performance: Output Voltage vs Input Current

7.2.2 Bridge Sensor Measurement

Figure 7-3 shows the OPAx383 in a high-CMRR dual-op-amp instrumentation amplifier with a trim resistor and six-wire bridge sensor for ratio metric precision measurement.

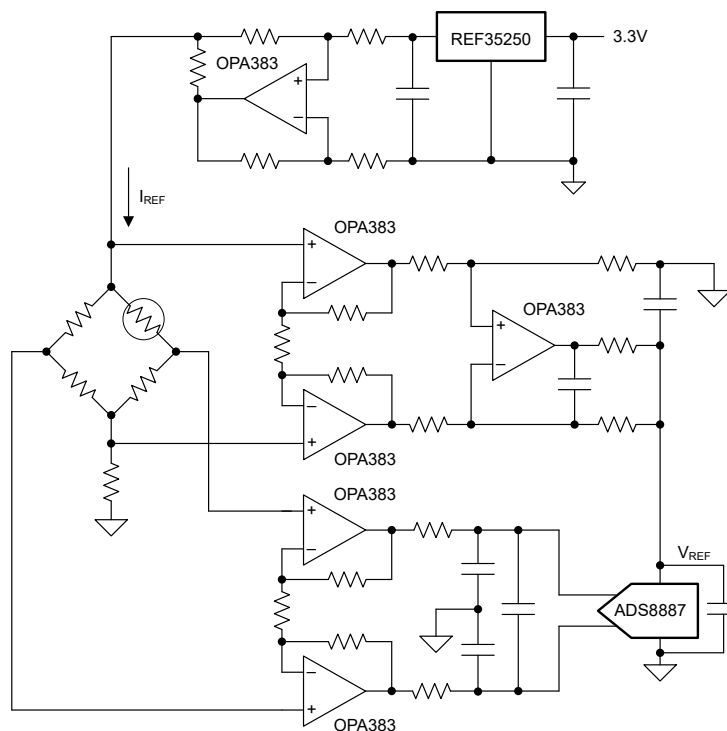

Figure 7-3. Bridge-Sensor Measurement Schematic

7.3 Power Supply Recommendations

The OPAx383 family of devices is specified for operation from 1.7V to 5.5V for single supplies, and $\pm 0.85V$ to $\pm 2.75V$ for dual supplies. Key parameters that can exhibit significant variance with regard to operating voltage are presented in [Section 5](#).

CAUTION
Supply voltages greater than 6V can permanently damage the device (see [Section 5.1](#)).

7.4 Layout

7.4.1 Layout Guidelines

Pay attention to good layout practice. Keep traces short and, when possible, use a printed-circuit board (PCB) ground plane with surface-mount components placed as close to the device pins as possible. Place a 0.1 μF capacitor close to the supply pins. These guidelines must be applied throughout the analog circuit to improve performance, and provide benefits such as reducing the electromagnetic interference (EMI) susceptibility.

For lowest offset voltage and precision performance, optimize circuit layout and mechanical conditions. Avoid temperature gradients that create thermoelectric (Seebeck) effects in the thermocouple junctions formed from connecting dissimilar conductors. Cancel these thermally-generated potentials by making sure that the potentials are equal on both input pins. Other layout and design considerations include:

- Use low thermoelectric-coefficient conditions (avoid dissimilar metals).
- Thermally isolate components from power supplies or other heat sources.
- Shield operational amplifier and input circuitry from air currents, such as cooling fans.

Follow these guidelines to reduce the likelihood of junctions being at different temperatures, which can cause thermoelectric voltage drift of 0.1 $\mu V/^\circ C$ or greater depending on materials used.

7.4.2 Layout Example

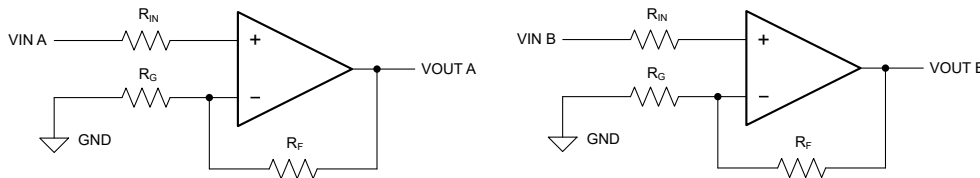

Figure 7-4. Schematic Representation

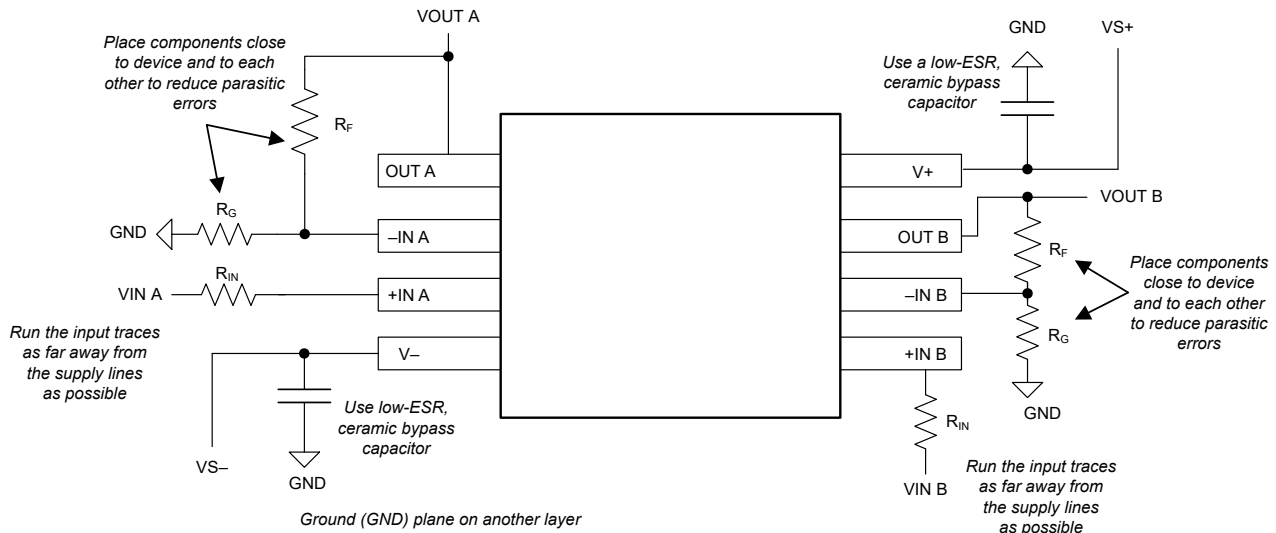

Figure 7-5. Layout Example

8 Device and Documentation Support

8.1 Device Support

8.1.1 Development Support

8.1.1.1 PSpice® for TI

PSpice® for TI is a design and simulation environment that helps evaluate performance of analog circuits. Create subsystem designs and prototype designs before committing to layout and fabrication, reducing development cost and time to market.

8.1.1.2 TINA-TI™ Simulation Software (Free Download)

TINA-TI™ simulation software is a simple, powerful, and easy-to-use circuit simulation program based on a SPICE engine. TINA-TI simulation software is a free, fully-functional version of the TINA™ software, preloaded with a library of macromodels, in addition to a range of both passive and active models. TINA-TI simulation software provides all the conventional dc, transient, and frequency domain analysis of SPICE, as well as additional design capabilities.

Available as a [free download](#) from the [Design and simulation tools](#) web page, TINA-TI simulation software offers extensive post-processing capability that allows users to format results in a variety of ways. Virtual instruments offer the ability to select input waveforms and probe circuit nodes, voltages, and waveforms, creating a dynamic quick-start tool.

Note

These files require that either the TINA software or TINA-TI software be installed. Download the free TINA-TI simulation software from the [TINA-TI™ software folder](#).

8.2 Receiving Notification of Documentation Updates

To receive notification of documentation updates, navigate to the device product folder on [ti.com](#). Click on *Notifications* to register and receive a weekly digest of any product information that has changed. For change details, review the revision history included in any revised document.

8.3 Support Resources

TI E2E™ [support forums](#) are an engineer's go-to source for fast, verified answers and design help — straight from the experts. Search existing answers or ask your own question to get the quick design help you need.

Linked content is provided "AS IS" by the respective contributors. They do not constitute TI specifications and do not necessarily reflect TI's views; see TI's [Terms of Use](#).

8.4 Trademarks

TINA-TI™ and TI E2E™ are trademarks of Texas Instruments.

TINA™ is a trademark of DesignSoft, Inc.

PSpice® is a registered trademark of Cadence Design Systems, Inc.

All trademarks are the property of their respective owners.

8.5 Electrostatic Discharge Caution



This integrated circuit can be damaged by ESD. Texas Instruments recommends that all integrated circuits be handled with appropriate precautions. Failure to observe proper handling and installation procedures can cause damage.

ESD damage can range from subtle performance degradation to complete device failure. Precision integrated circuits may be more susceptible to damage because very small parametric changes could cause the device not to meet its published specifications.

8.6 Glossary

[TI Glossary](#) This glossary lists and explains terms, acronyms, and definitions.

9 Revision History

NOTE: Page numbers for previous revisions may differ from page numbers in the current version.

Changes from Revision C (November 2025) to Revision D (April 2026)	Page
• Adding OPA383, Shutdown YCH package to <i>production</i>	1
• Added shutdown specifications to <i>Electrical Characteristics table</i>	6

Changes from Revision B (June 2025) to Revision C (November 2025)	Page
• Updated the status of OPA4383PWR from <i>preview</i> to <i>production</i>	1

Changes from Revision A (May 2025) to Revision B (June 2025)	Page
• Updated the status of OPA383DBVR from <i>preview</i> to <i>production</i>	1
• Added the following footnote to the room temperature maximum for input offset voltage: "Specification established from device population bench system measurements across multiple lots."	8
• Added the following footnote to the room temperature maximum for input bias current: "Specification established from device population bench system measurements across multiple lots."	8
• Changed the room temperature maximum input bias current from 50pA to 62pA.....	8
• Changed the -40°C to +85°C maximum input bias current from 60pA to 76pA.....	8
• Changed the -40°C to +125°C maximum input bias current from 150pA to 212pA.....	8
• Added the following footnote to the room temperature maximum for input offset current: "Specification established from device population bench system measurements across multiple lots."	8
• Changed the room temperature maximum input offset current from 100pA to 123pA.....	8
• Changed the room temperature minimum CMRR when $V_S = 5.5V$ from 125dB to 122dB.....	8
• Changed the -40°C to +125°C minimum CMRR when $V_S = 5.5V$ from 122dB to 120dB.....	8
• Added the following footnote to the room temperature minimum for CMRR where $V_S = 1.7V$: "Specification established from device population bench system measurements across multiple lots."	8
• Changed the room temperature minimum CMRR when $V_S = 1.7V$ from 122dB to 116dB.....	8
• Changed the -40°C to +125°C minimum CMRR when $V_S = 1.7V$ from 120dB to 114dB.....	8
• Changed the room temperature minimum A_{OL} when $V_S = 5.5V$ and $R_L = 10k\Omega$ from 130dB to 120dB.....	8
• Added a room temperature minimum A_{OL} for $V_S = 1.7V$ and $R_L = 10k\Omega$	8
• Changed the -40°C to +125°C minimum A_{OL} when $V_S = 5.5V$ and $R_L = 10k\Omega$ from 124dB to 119dB.....	8
• Changed the room temperature minimum A_{OL} when $V_S = 5.5V$ and $R_L = 2k\Omega$ from 125dB to 119dB.....	8
• Added a room temperature minimum A_{OL} for $V_S = 1.7V$ and $R_L = 2k\Omega$	8
• Changed the -40°C to +125°C minimum A_{OL} when $V_S = 5.5V$ and $R_L = 2k\Omega$ from 122dB to 118dB.....	8
• Changed overload recovery time from 1500ns to 2200ns.....	8

Changes from Revision * (December 2024) to Revision A (May 2025)	Page
• Update to APL the OPA383 and OPA4383.....	1

10 Mechanical, Packaging, and Orderable Information

The following pages include mechanical packaging and orderable information. This information is the most current data available for the designated devices. This data is subject to change without notice and revision of this document. For browser-based versions of this data sheet, refer to the left-hand navigation.

OPA383YCHx
 YCH0006-C01

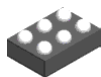

PACKAGE OUTLINE
 DSBGA - 0.4 mm max height

DIE SIZE BALL GRID ARRAY

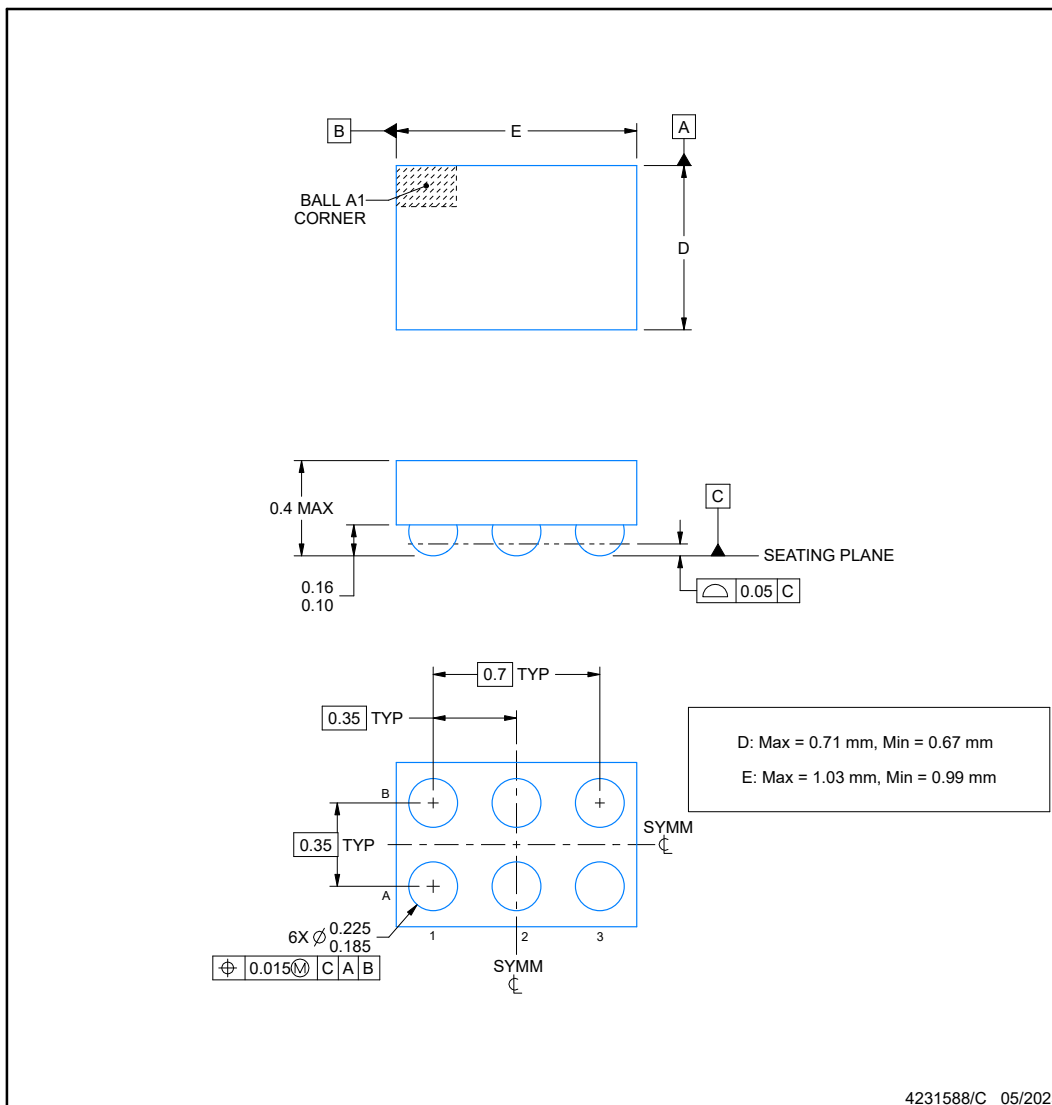

NOTES:

1. All linear dimensions are in millimeters. Any dimensions in parenthesis are for reference only. Dimensioning and tolerancing per ASME Y14.5M.
2. This drawing is subject to change without notice.

EXAMPLE BOARD LAYOUT

YCH0006-C01

DSBGA - 0.4 mm max height

DIE SIZE BALL GRID ARRAY

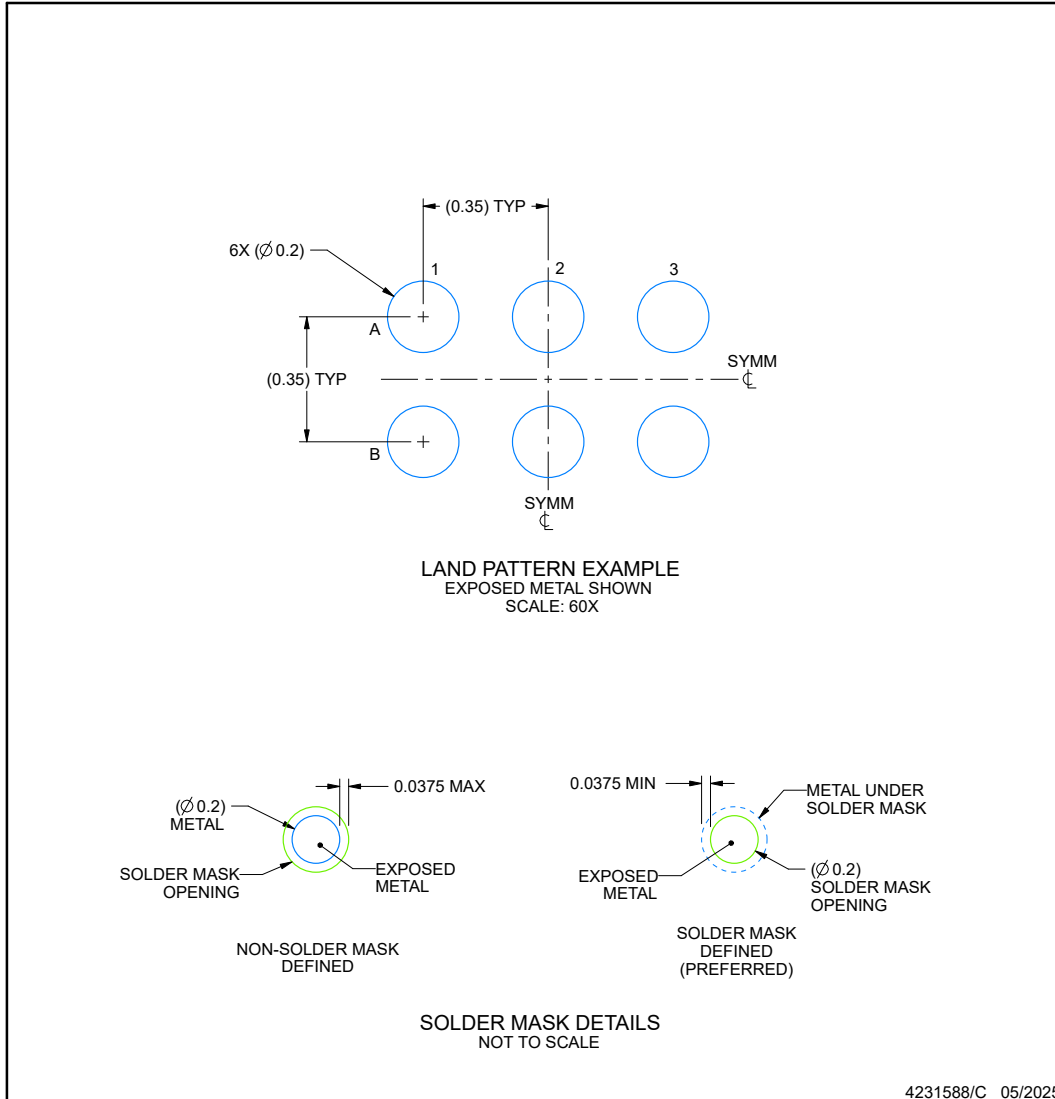

NOTES: (continued)

- Final dimensions may vary due to manufacturing tolerance considerations and also routing constraints. See Texas Instruments Literature No. SNVA009 (www.ti.com/lit/snva009).

EXAMPLE STENCIL DESIGN

YCH0006-C01

DSBGA - 0.4 mm max height

DIE SIZE BALL GRID ARRAY

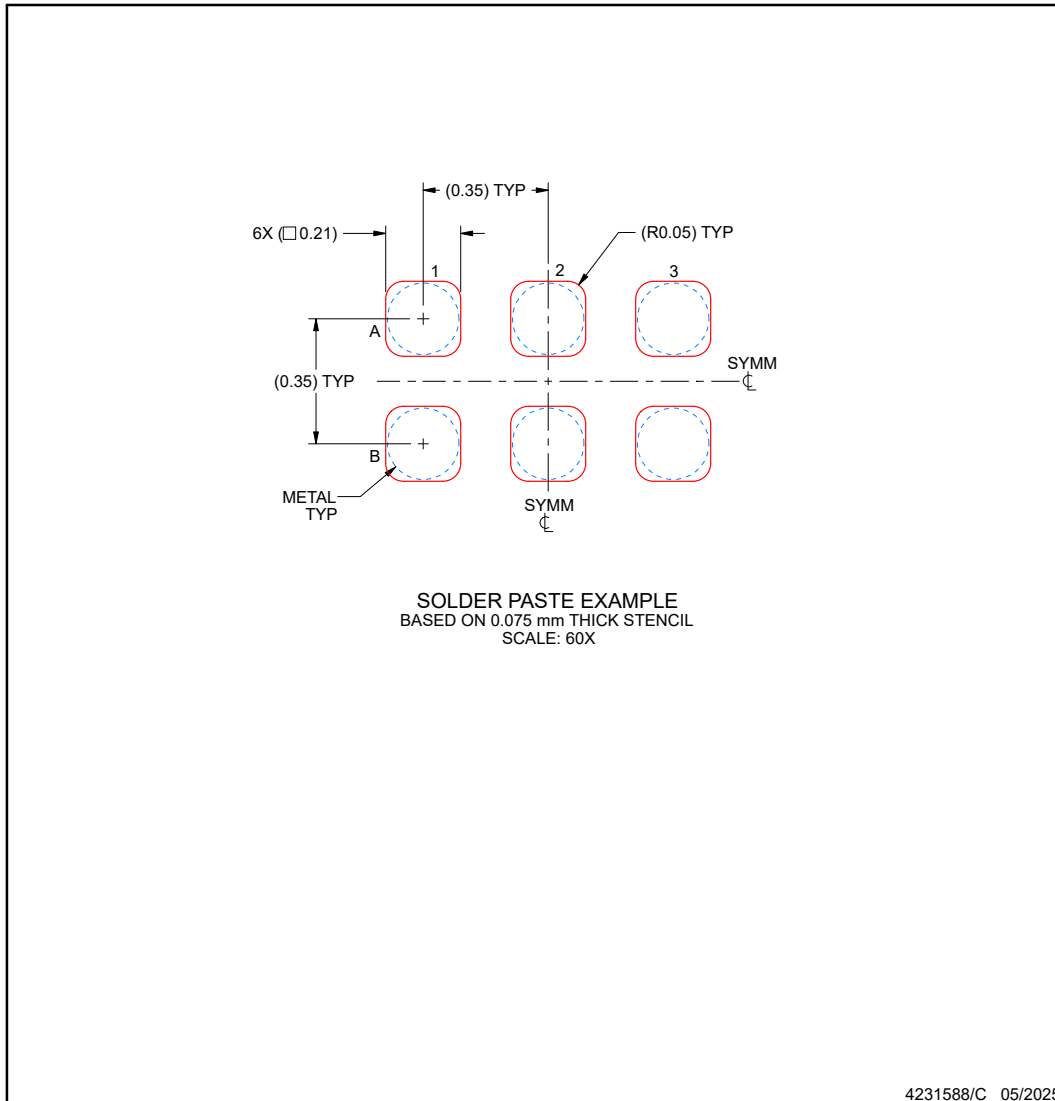

NOTES: (continued)

4. Laser cutting apertures with trapezoidal walls and rounded corners may offer better paste release.

PACKAGING INFORMATION

Orderable part number	Status (1)	Material type (2)	Package Pins	Package qty Carrier	RoHS (3)	Lead finish/ Ball material (4)	MSL rating/ Peak reflow (5)	Op temp (°C)	Part marking (6)
OPA2383DGKR	Active	Production	VSSOP (DGK) 8	2500 LARGE T&R	Yes	SN	Level-1-260C-UNLIM	-40 to 125	O2383
OPA2383DGKR.A	Active	Production	VSSOP (DGK) 8	2500 LARGE T&R	Yes	SN	Level-1-260C-UNLIM	-40 to 125	O2383
OPA383DBVR	Active	Production	SOT-23 (DBV) 5	3000 LARGE T&R	Yes	SN	Level-1-260C-UNLIM	-40 to 125	3PMF
OPA383YCHR	Active	Production	DSBGA (YCH) 6	3000 LARGE T&R	Yes	SNAGCU	Level-1-260C-UNLIM	-40 to 125	X
OPA4383PWR	Active	Production	TSSOP (PW) 14	3000 LARGE T&R	Yes	NIPDAU	Level-1-260C-UNLIM	-40 to 125	O4383PW

(1) **Status:** For more details on status, see our [product life cycle](#).

(2) **Material type:** When designated, preproduction parts are prototypes/experimental devices, and are not yet approved or released for full production. Testing and final process, including without limitation quality assurance, reliability performance testing, and/or process qualification, may not yet be complete, and this item is subject to further changes or possible discontinuation. If available for ordering, purchases will be subject to an additional waiver at checkout, and are intended for early internal evaluation purposes only. These items are sold without warranties of any kind.

(3) **RoHS values:** Yes, No, RoHS Exempt. See the [TI RoHS Statement](#) for additional information and value definition.

(4) **Lead finish/Ball material:** Parts may have multiple material finish options. Finish options are separated by a vertical ruled line. Lead finish/Ball material values may wrap to two lines if the finish value exceeds the maximum column width.

(5) **MSL rating/Peak reflow:** The moisture sensitivity level ratings and peak solder (reflow) temperatures. In the event that a part has multiple moisture sensitivity ratings, only the lowest level per JEDEC standards is shown. Refer to the shipping label for the actual reflow temperature that will be used to mount the part to the printed circuit board.

(6) **Part marking:** There may be an additional marking, which relates to the logo, the lot trace code information, or the environmental category of the part.

Multiple part markings will be inside parentheses. Only one part marking contained in parentheses and separated by a "-" will appear on a part. If a line is indented then it is a continuation of the previous line and the two combined represent the entire part marking for that device.

Important Information and Disclaimer: The information provided on this page represents TI's knowledge and belief as of the date that it is provided. TI bases its knowledge and belief on information provided by third parties, and makes no representation or warranty as to the accuracy of such information. Efforts are underway to better integrate information from third parties. TI has taken and continues to take reasonable steps to provide representative and accurate information but may not have conducted destructive testing or chemical analysis on incoming materials and chemicals. TI and TI suppliers consider certain information to be proprietary, and thus CAS numbers and other limited information may not be available for release.

In no event shall TI's liability arising out of such information exceed the total purchase price of the TI part(s) at issue in this document sold by TI to Customer on an annual basis.

TAPE AND REEL INFORMATION



QUADRANT ASSIGNMENTS FOR PIN 1 ORIENTATION IN TAPE

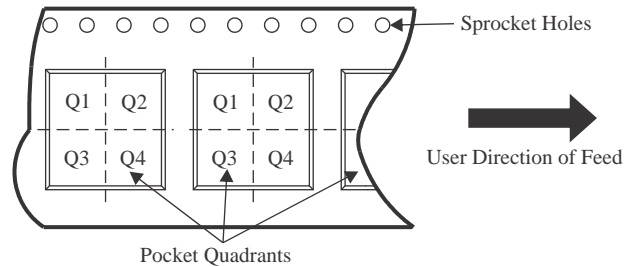

*All dimensions are nominal

Device	Package Type	Package Drawing	Pins	SPQ	Reel Diameter (mm)	Reel Width W1 (mm)	A0 (mm)	B0 (mm)	K0 (mm)	P1 (mm)	W (mm)	Pin1 Quadrant
OPA2383DGKR	VSSOP	DGK	8	2500	330.0	12.4	5.25	3.35	1.25	8.0	12.0	Q1
OPA383DBVR	SOT-23	DBV	5	3000	180.0	8.4	3.2	3.2	1.4	4.0	8.0	Q3
OPA383YCHR	DSBGA	YCH	6	3000	180.0	8.4	0.74	1.06	0.53	2.0	8.0	Q2
OPA4383PWR	TSSOP	PW	14	3000	330.0	12.4	6.9	5.6	1.6	8.0	12.0	Q1

TAPE AND REEL BOX DIMENSIONS



*All dimensions are nominal

Device	Package Type	Package Drawing	Pins	SPQ	Length (mm)	Width (mm)	Height (mm)
OPA2383DGKR	VSSOP	DGK	8	2500	366.0	364.0	50.0
OPA383DBVR	SOT-23	DBV	5	3000	210.0	185.0	35.0
OPA383YCHR	DSBGA	YCH	6	3000	182.0	182.0	20.0
OPA4383PWR	TSSOP	PW	14	3000	353.0	353.0	32.0



4220202/B 12/2023

NOTES:

1. All linear dimensions are in millimeters. Any dimensions in parenthesis are for reference only. Dimensioning and tolerancing per ASME Y14.5M.
2. This drawing is subject to change without notice.
3. This dimension does not include mold flash, protrusions, or gate burrs. Mold flash, protrusions, or gate burrs shall not exceed 0.15 mm per side.
4. This dimension does not include interlead flash. Interlead flash shall not exceed 0.25 mm per side.
5. Reference JEDEC registration MO-153.

EXAMPLE BOARD LAYOUT

PW0014A

TSSOP - 1.2 mm max height

SMALL OUTLINE PACKAGE



LAND PATTERN EXAMPLE
EXPOSED METAL SHOWN
SCALE: 10X

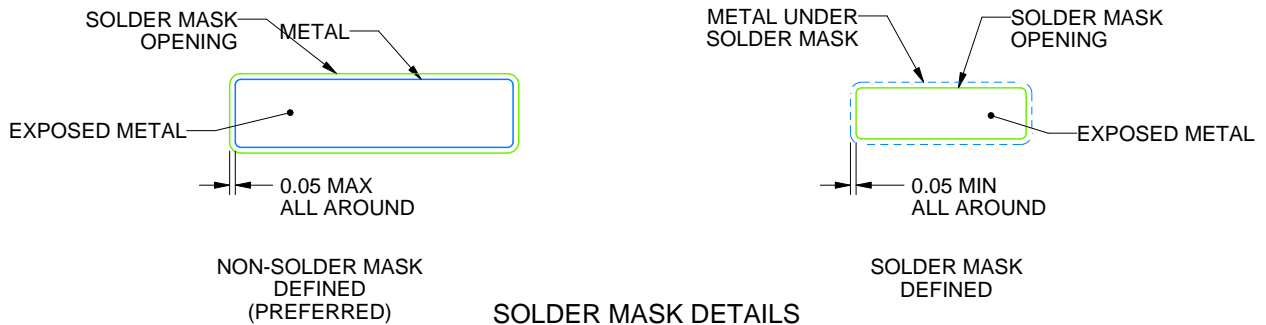

4220202/B 12/2023

NOTES: (continued)

- 6. Publication IPC-7351 may have alternate designs.
- 7. Solder mask tolerances between and around signal pads can vary based on board fabrication site.

EXAMPLE STENCIL DESIGN

PW0014A

TSSOP - 1.2 mm max height

SMALL OUTLINE PACKAGE



SOLDER PASTE EXAMPLE
BASED ON 0.125 mm THICK STENCIL
SCALE: 10X

4220202/B 12/2023

NOTES: (continued)

8. Laser cutting apertures with trapezoidal walls and rounded corners may offer better paste release. IPC-7525 may have alternate design recommendations.
9. Board assembly site may have different recommendations for stencil design.

EXAMPLE BOARD LAYOUT

DBV0005A

SOT-23 - 1.45 mm max height

SMALL OUTLINE TRANSISTOR



LAND PATTERN EXAMPLE
EXPOSED METAL SHOWN
SCALE:15X



SOLDER MASK DETAILS

4214839/K 08/2024

NOTES: (continued)

- 6. Publication IPC-7351 may have alternate designs.
- 7. Solder mask tolerances between and around signal pads can vary based on board fabrication site.

EXAMPLE STENCIL DESIGN

DBV0005A

SOT-23 - 1.45 mm max height

SMALL OUTLINE TRANSISTOR



SOLDER PASTE EXAMPLE
BASED ON 0.125 mm THICK STENCIL
SCALE:15X

4214839/K 08/2024

NOTES: (continued)

8. Laser cutting apertures with trapezoidal walls and rounded corners may offer better paste release. IPC-7525 may have alternate design recommendations.
9. Board assembly site may have different recommendations for stencil design.

DGK0008A

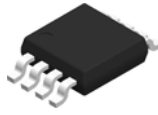

PACKAGE OUTLINE
VSSOP - 1.1 mm max height

SMALL OUTLINE PACKAGE

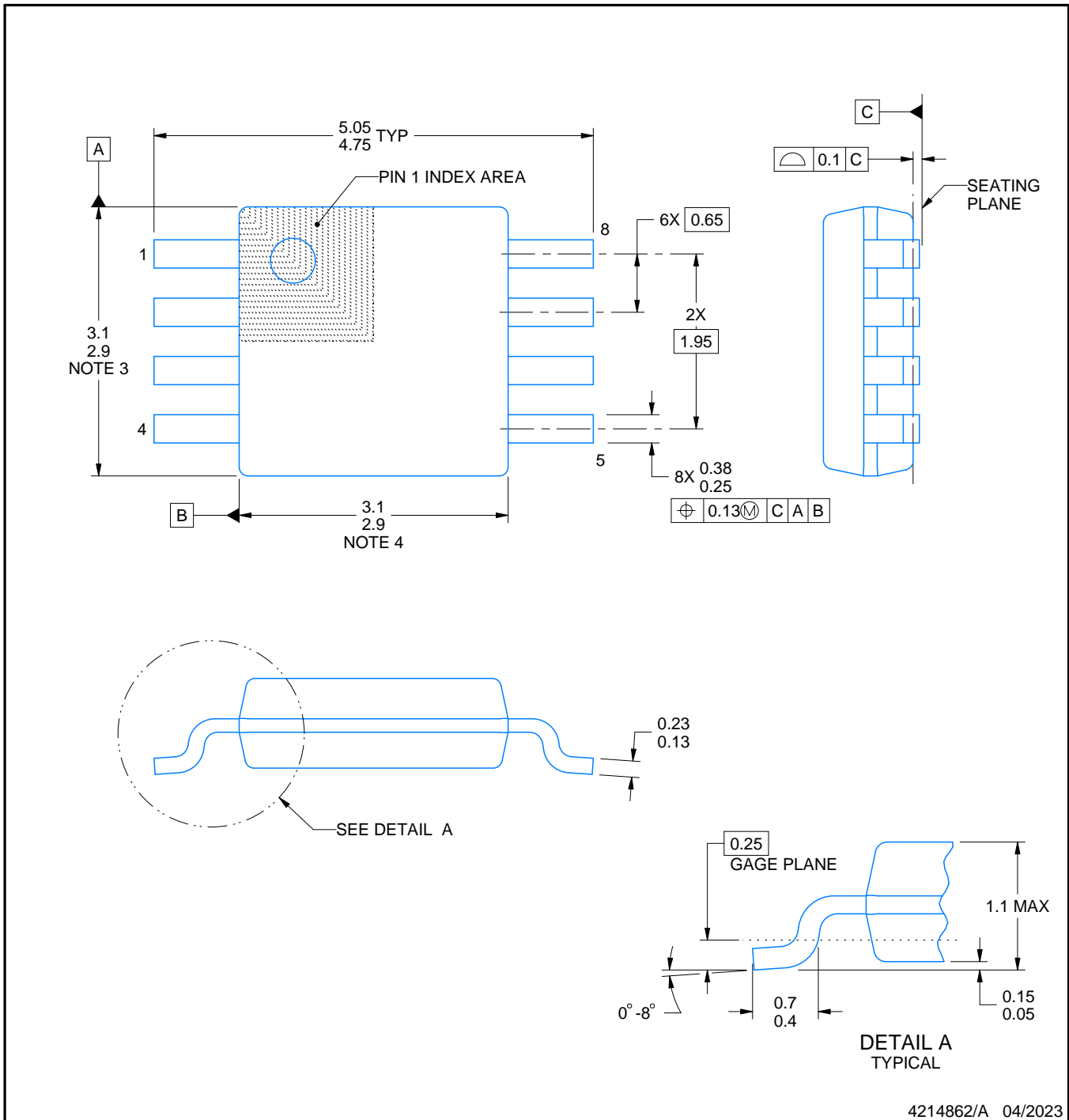

4214862/A 04/2023

NOTES:

PowerPAD is a trademark of Texas Instruments.

1. All linear dimensions are in millimeters. Any dimensions in parenthesis are for reference only. Dimensioning and tolerancing per ASME Y14.5M.
2. This drawing is subject to change without notice.
3. This dimension does not include mold flash, protrusions, or gate burrs. Mold flash, protrusions, or gate burrs shall not exceed 0.15 mm per side.
4. This dimension does not include interlead flash. Interlead flash shall not exceed 0.25 mm per side.
5. Reference JEDEC registration MO-187.

EXAMPLE BOARD LAYOUT

DGK0008A

™ VSSOP - 1.1 mm max height

SMALL OUTLINE PACKAGE



LAND PATTERN EXAMPLE
EXPOSED METAL SHOWN
SCALE: 15X



SOLDER MASK DETAILS

4214862/A 04/2023

NOTES: (continued)

6. Publication IPC-7351 may have alternate designs.
7. Solder mask tolerances between and around signal pads can vary based on board fabrication site.
8. Vias are optional depending on application, refer to device data sheet. If any vias are implemented, refer to their locations shown on this view. It is recommended that vias under paste be filled, plugged or tented.
9. Size of metal pad may vary due to creepage requirement.

EXAMPLE STENCIL DESIGN

DGK0008A

™ VSSOP - 1.1 mm max height

SMALL OUTLINE PACKAGE



SOLDER PASTE EXAMPLE
SCALE: 15X

4214862/A 04/2023

NOTES: (continued)

11. Laser cutting apertures with trapezoidal walls and rounded corners may offer better paste release. IPC-7525 may have alternate design recommendations.
12. Board assembly site may have different recommendations for stencil design.

IMPORTANT NOTICE AND DISCLAIMER

TI PROVIDES TECHNICAL AND RELIABILITY DATA (INCLUDING DATASHEETS), DESIGN RESOURCES (INCLUDING REFERENCE DESIGNS), APPLICATION OR OTHER DESIGN ADVICE, WEB TOOLS, SAFETY INFORMATION, AND OTHER RESOURCES "AS IS" AND WITH ALL FAULTS, AND DISCLAIMS ALL WARRANTIES, EXPRESS AND IMPLIED, INCLUDING WITHOUT LIMITATION ANY IMPLIED WARRANTIES OF MERCHANTABILITY, FITNESS FOR A PARTICULAR PURPOSE OR NON-INFRINGEMENT OF THIRD PARTY INTELLECTUAL PROPERTY RIGHTS.

These resources are intended for skilled developers designing with TI products. You are solely responsible for (1) selecting the appropriate TI products for your application, (2) designing, validating and testing your application, and (3) ensuring your application meets applicable standards, and any other safety, security, regulatory or other requirements.

These resources are subject to change without notice. TI grants you permission to use these resources only for development of an application that uses the TI products described in the resource. Other reproduction and display of these resources is prohibited. No license is granted to any other TI intellectual property right or to any third party intellectual property right. TI disclaims responsibility for, and you fully indemnify TI and its representatives against any claims, damages, costs, losses, and liabilities arising out of your use of these resources.

TI's products are provided subject to [TI's Terms of Sale](#), [TI's General Quality Guidelines](#), or other applicable terms available either on [ti.com](#) or provided in conjunction with such TI products. TI's provision of these resources does not expand or otherwise alter TI's applicable warranties or warranty disclaimers for TI products. Unless TI explicitly designates a product as custom or customer-specified, TI products are standard, catalog, general purpose devices.

TI objects to and rejects any additional or different terms you may propose.

Copyright © 2026, Texas Instruments Incorporated

Last updated 10/2025