

## OPAx180 0.1- $\mu\text{V}/^\circ\text{C}$ Drift, Low-Noise, Rail-to-Rail Output, 36-V, Zero-Drift Operational Amplifiers

### 1 Features

- Low Offset Voltage: 75  $\mu\text{V}$  (Maximum)
- Zero-Drift: 0.1  $\mu\text{V}/^\circ\text{C}$
- Low Noise: 10  $\text{nV}/\sqrt{\text{Hz}}$
- Very Low 1/f Noise
- Excellent DC Precision:
  - PSRR: 126 dB
  - CMRR: 114 dB
  - Open-Loop Gain ( $A_{\text{OL}}$ ): 120 dB
- Quiescent Current: 525  $\mu\text{A}$  (Maximum)
- Wide Supply Range:  $\pm 2\text{ V}$  to  $\pm 18\text{ V}$
- Rail-to-Rail Output:  
Input Includes Negative Rail
- Low Bias Current: 250 pA (Typical)
- RFI Filtered Inputs
- *MicroSIZE* Packages

### 2 Applications

- Bridge Amplifiers
- Strain Gauges
- Test Equipment
- Transducer Applications
- Temperature Measurement
- Electronic Scales
- Medical Instrumentation
- Resistor Thermal Detectors
- Precision Active Filters

### 3 Description

The OPA180, OPA2180 and OPA4180 operational amplifiers (op amps) use TI's proprietary [zero-drift](#) techniques to simultaneously provide low offset voltage (75  $\mu\text{V}$ ), and near zero-drift over time and temperature. These miniature, high-precision, low-quiescent-current op amps offer high input impedance and rail-to-rail output swing within 18 mV of the rails. The input common-mode range includes the negative rail. Single- or dual-supplies ranging from 4 V to 36 V ( $\pm 2\text{ V}$  to  $\pm 18\text{ V}$ ) can be used.

The dual-channel version is offered in VSSOP-8 packages and SOIC-8 packages. The quad-channel version is offered in SOIC-14 and TSSOP-14 packages. The single and quad package offerings (OPA180 and OPA4180) are specified from  $-40^\circ\text{C}$  to  $+125^\circ\text{C}$ , and the dual package (OPA2180) is specified from  $-40^\circ\text{C}$  to  $+105^\circ\text{C}$ .

#### Device Information<sup>(1)</sup>

DEVICE NAME	PACKAGE	BODY SIZE (NOM)
OPA180	SOT-23 (5)	1.60 mm x 2.90 mm
	VSSOP, MSOP (8)	3.00 mm x 3.00 mm
	SOIC (8)	4.90 mm x 3.91 mm
OPA2180	VSSOP, MSOP (8)	3.00 mm x 3.00 mm
	SOIC (8)	4.90 mm x 3.91 mm
OPA4180	TSSOP (14)	5.00 mm x 4.40 mm
	SOIC (14)	8.65 mm x 3.91 mm

(1) For all available packages, see the orderable addendum at the end of the data sheet.

#### Low Noise (Peak-to-Peak Noise = 250 nV)

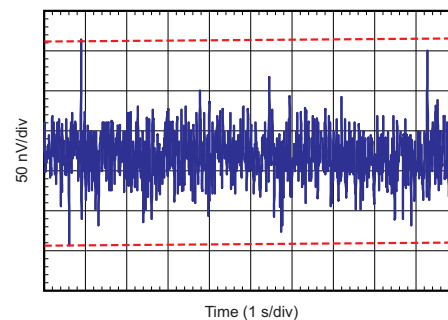

## Table of Contents

<b>1 Features</b> .....	<b>1</b>	8.1 Overview .....	<b>17</b>
<b>2 Applications</b> .....	<b>1</b>	8.2 Functional Block Diagram .....	<b>17</b>
<b>3 Description</b> .....	<b>1</b>	8.3 Feature Description .....	<b>18</b>
<b>4 Revision History</b> .....	<b>2</b>	8.4 Device Functional Modes .....	<b>20</b>
<b>5 Device Comparison Table</b> .....	<b>4</b>	<b>9 Application and Implementation</b> .....	<b>21</b>
<b>6 Pin Configuration and Functions</b> .....	<b>5</b>	9.1 Application Information .....	<b>21</b>
<b>7 Specifications</b> .....	<b>8</b>	9.2 Typical Applications .....	<b>21</b>
7.1 Absolute Maximum Ratings .....	<b>8</b>	<b>10 Power Supply Recommendations</b> .....	<b>25</b>
7.2 ESD Ratings .....	<b>8</b>	<b>11 Layout</b> .....	<b>26</b>
7.3 Recommended Operating Conditions .....	<b>8</b>	11.1 Layout Guidelines .....	<b>26</b>
7.4 Thermal Information: OPA180 .....	<b>9</b>	11.2 Layout Example .....	<b>26</b>
7.5 Thermal Information: OPA2180 .....	<b>9</b>	<b>12 Device and Documentation Support</b> .....	<b>27</b>
7.6 Thermal Information: OPA4180 .....	<b>9</b>	12.1 Related Links .....	<b>27</b>
7.7 Electrical Characteristics: $V_S = \pm 2\text{ V to } \pm 18\text{ V}$ ( $V_S = 4\text{ V to } 36\text{ V}$ ) .....	<b>10</b>	12.2 Trademarks .....	<b>27</b>
7.8 Typical Characteristics: Table of Graphs .....	<b>12</b>	12.3 Electrostatic Discharge Caution .....	<b>27</b>
7.9 Typical Characteristics .....	<b>13</b>	12.4 Glossary .....	<b>27</b>
<b>8 Detailed Description</b> .....	<b>17</b>	<b>13 Mechanical, Packaging, and Orderable Information</b> .....	<b>27</b>

## 4 Revision History

NOTE: Page numbers for previous revisions may differ from page numbers in the current version.

<b>Changes from Revision D (May 2014) to Revision E</b>	<b>Page</b>
• Changed OPA180 and OPA4180 operating temperature from "–40°C to +105°C" to "–40°C to +125°C" in <i>Description</i> section .....	<b>1</b>
• Added storage temperature parameter as the last row in the <i>Absolute Maximum Ratings</i> table .....	<b>8</b>
• Changed maximum operating temperature value from 105°C to 125°C in <i>Absolute Maximum Ratings</i> table .....	<b>8</b>
• Changed maximum operating temperature value from 105°C to 125°C in <i>Recommended Operating Conditions</i> table .....	<b>8</b>
• Changed input offset voltage drift temperature range from $T_A = -40^\circ\text{C to } 105^\circ\text{C}$ to $T_A = -40^\circ\text{C to } +125^\circ\text{C}$ in <i>Electrical Characteristics</i> table .....	<b>10</b>
• Changed power supply rejection ratio temperature range from $T_A = -40^\circ\text{C to } 105^\circ\text{C}$ to $T_A = -40^\circ\text{C to } +125^\circ\text{C}$ in <i>Electrical Characteristics</i> table .....	<b>10</b>
• Changed OPA180 input bias current temperature range from $T_A = -40^\circ\text{C to } 105^\circ\text{C}$ to $T_A = -40^\circ\text{C to } +125^\circ\text{C}$ in <i>Electrical Characteristics</i> table .....	<b>10</b>
• Added minimum OPA2180 input bias current value of 18 nA in <i>Electrical Characteristics</i> table .....	<b>10</b>
• Added minimum OPA180 input bias current value of 18 nA in <i>Electrical Characteristics</i> table .....	<b>10</b>
• Changed OPA180 input offset current temperature range from $T_A = -40^\circ\text{C to } 105^\circ\text{C}$ to $T_A = -40^\circ\text{C to } +125^\circ\text{C}$ in <i>Electrical Characteristics</i> table .....	<b>10</b>
• Added minimum OPA2180 input offset current value of 6 nA in <i>Electrical Characteristics</i> table .....	<b>10</b>
• Added minimum OPA180 input offset current value of 6 nA in <i>Electrical Characteristics</i> table .....	<b>10</b>
• Changed common-mode rejection ratio temperature range from $T_A = -40^\circ\text{C to } 105^\circ\text{C}$ to $T_A = -40^\circ\text{C to } +125^\circ\text{C}$ in <i>Electrical Characteristics</i> table .....	<b>10</b>
• Changed open-loop voltage gain temperature range from $T_A = -40^\circ\text{C to } 105^\circ\text{C}$ to $T_A = -40^\circ\text{C to } +125^\circ\text{C}$ in <i>Electrical Characteristics</i> table .....	<b>10</b>
• Changed voltage output swing from rail temperature range from $T_A = -40^\circ\text{C to } 105^\circ\text{C}$ to $T_A = -40^\circ\text{C to } +125^\circ\text{C}$ in <i>Electrical Characteristics</i> table .....	<b>11</b>
• Changed quiescent current temperature range from $T_A = -40^\circ\text{C to } 105^\circ\text{C}$ to $T_A = -40^\circ\text{C to } +125^\circ\text{C}$ in <i>Electrical Characteristics</i> table .....	<b>11</b>
• Changed operating temperature from "–40°C to +105°C" to "–40°C to +125°C" in <i>Feature Description</i> section .....	<b>18</b>
• Updated <a href="#">Figure 34</a> .....	<b>24</b>

**Revision History (continued)**

- Changed operating temperature from "–40°C to +105°C" to "–40°C to +125°C" in *Power Supply Recommendations* section ..... 25

**Changes from Revision C (December 2012) to Revision D** **Page**

- Changed format to meet latest data sheet standards; added *Device Functional Modes, Application and Implementation*, and *Power Supply Recommendations* sections, and moved existing sections ..... 1
- Added OPA180 to document..... 1
- Added Device Information table ..... 1
- Deleted Package Information table ..... 5
- OPA180 pinout drawings ..... 5
- Added Pin Functions table ..... 5
- Added Pin Functions table ..... 6
- Added Pin Functions table ..... 7
- Added Recommended Operating Conditions table ..... 8
- Added Thermal Information: OPA180 table..... 9
- Changed Offset Voltage, *Long-term stability* parameter typical specification in Electrical Characteristics table..... 10
- Changed last sentence of *EMI Rejection* section..... 18

**Changes from Revision B (December 2011) to Revision C** **Page**

- Changed product status from Mixed Status to Production Data ..... 1
- Changed OPA4180 status to Production Data..... 1
- Added package marking to OPA2180 VSSOP-8 row in Package Information table..... 5
- Deleted ordering number and transport media columns from Package Information table..... 5
- Changed Input Bias Current section in Electrical Characteristics ( $V_S = +4\text{ V to }+36\text{ V}$ ) table ..... 10

**Changes from Revision A (November 2011) to Revision B** **Page**

- Changed footnote 1 of Electrical Characteristics table..... 10
- Updated [Figure 7](#) ..... 13

## 5 Device Comparison Table

**Table 1. Zero-Drift Amplifier Portfolio**

VERSION	PRODUCT	OFFSET VOLTAGE ( $\mu\text{V}$ )	OFFSET VOLTAGE DRIFT ( $\mu\text{V}/^\circ\text{C}$ )	BANDWIDTH (MHz)
Single	<a href="#">OPA188</a> (4 V to 36 V)	25	0.085	2
	<a href="#">OPA180</a> (4 V to 36 V)	75	0.35	2
	<a href="#">OPA333</a> (5 V)	10	0.05	0.35
	<a href="#">OPA378</a> (5 V)	50	0.25	0.9
	<a href="#">OPA735</a> (12 V)	5	0.05	1.6
Dual	<a href="#">OPA2188</a> (4 V to 36 V)	25	0.085	2
	<a href="#">OPA2180</a> (4 V to 36 V)	75	0.35	2
	<a href="#">OPA2333</a> (5 V)	10	0.05	0.35
	<a href="#">OPA2378</a> (5 V)	50	0.25	0.9
	<a href="#">OPA2735</a> (12 V)	5	0.05	1.6
Quad	<a href="#">OPA4188</a> (4 V to 36 V)	25	0.085	2
	<a href="#">OPA4180</a> (4 V to 36 V)	75	0.35	2
	<a href="#">OPA4330</a> (5 V)	50	0.25	0.35

## 6 Pin Configuration and Functions

**OPA180 DBV Package  
5-Pin SOT-23  
(Top View)**

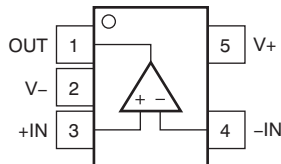

**Pin Functions**

PIN		I/O	DESCRIPTION
NAME	NO.		
-IN	4	I	Inverting input
+IN	3	I	Noninverting input
OUT	1	O	Output
V-	2	—	Negative supply or ground (for single-supply operation)
V+	5	—	Positive supply or ground (for single-supply operation)

**OPA180 D, DGK Packages  
8-Pin SO, MSOP  
Top View**

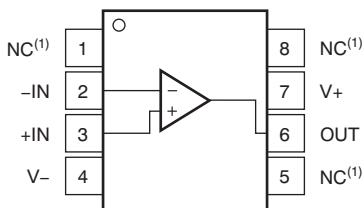

(1) NC- no internal connection

**Pin Functions: OPA180**

PIN		DESCRIPTION
NAME	NO.	
-IN	2	Inverting input
+IN	3	Noninverting input
NC	1, 5, 8	No connection
OUT	6	Output
V-	4	Negative power supply
V+	7	Positive power supply

**OPA2180 D, DGK Packages  
8-Pin SOIC, VSSOP  
Top View**

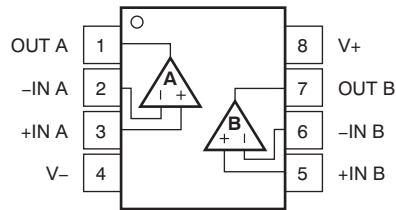

**Pin Functions: OPA2180**

PIN		DESCRIPTION
NAME	NO.	
-IN A	2	Inverting input, channel A
+IN A	3	Noninverting input, channel A
-IN B	6	Inverting input, channel B
+IN B	5	Noninverting input, channel B
OUT A	1	Output, channel A
OUT B	7	Output, channel B
V-	4	Negative power supply
V+	8	Positive power supply

**OPA4180 D, PW Packages  
14-Pin SOIC, TSSOP  
(Top View)**

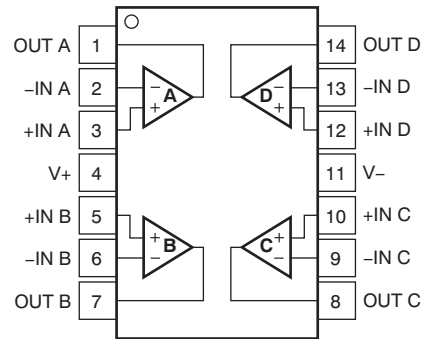

**Pin Functions: OPA4180**

PIN		DESCRIPTION
NAME	NO.	
-IN A	2	Inverting input, channel A
+IN A	3	Noninverting input, channel A
-IN B	6	Inverting input, channel B
+IN B	5	Noninverting input, channel B
-IN C	9	Inverting input, channel C
+IN C	10	Noninverting input, channel C
-IN D	13	Inverting input, channel D
+IN D	12	Noninverting input, channel D
OUT A	1	Output, channel A
OUT B	7	Output, channel B
OUT C	8	Output, channel C
OUT D	14	Output, channel D
V-	11	Negative supply or ground (for single-supply operation)
V+	4	Positive supply or ground (for single-supply operation)

## 7 Specifications

### 7.1 Absolute Maximum Ratings

over operating free-air temperature range (unless otherwise noted)<sup>(1)</sup>

		MIN	MAX	UNIT
	Supply voltage		±20, ±40 (single-supply)	V
	Signal input terminals	Voltage	(V–) – 0.5      (V+) + 0.5	V
		Current	±10	mA
	Output short-circuit <sup>(2)</sup>	Continuous		
	Operating temperature	–55	125	°C
T <sub>J</sub>	Junction temperature		150	°C
T <sub>stg</sub>	Storage temperature	–65	150	°C

- (1) Stresses beyond those listed under *Absolute Maximum Ratings* may cause permanent damage to the device. These are stress ratings only, which do not imply functional operation of the device at these or any other conditions beyond those indicated under *Recommended Operating Conditions*. Exposure to absolute-maximum-rated conditions for extended periods may affect device reliability.
- (2) Short-circuit to ground, one amplifier per package.

### 7.2 ESD Ratings

		MIN	MAX	UNIT
T <sub>stg</sub>	Storage temperature range	–65	150	°C
V <sub>(ESD)</sub>	Electrostatic discharge	Human body model (HBM), per ANSI/ESDA/JEDEC JS-001, all pins <sup>(1)</sup>	–1.5      1.5	kV
		Charged device model (CDM), per JEDEC specification JESD22-C101, all pins <sup>(2)</sup>	–1      1	

- (1) JEDEC document JEP155 states that 500-V HBM allows safe manufacturing with a standard ESD control process.
- (2) JEDEC document JEP157 states that 250-V CDM allows safe manufacturing with a standard ESD control process.

### 7.3 Recommended Operating Conditions

over operating free-air temperature range (unless otherwise noted), R<sub>L</sub> = 10 kΩ connected to V<sub>S</sub> / 2, and V<sub>COM</sub> = V<sub>OUT</sub> = V<sub>S</sub> / 2, (unless otherwise noted)

		MIN	NOM	MAX	UNIT
Supply voltage [(V+) – (V–)]	Single-supply	4.5		36	V
	Bipolar-supply	±2.25		±18	V
Operating temperature		–40		125	°C

## 7.4 Thermal Information: OPA180

THERMAL METRIC <sup>(1)</sup>		OPA180			UNIT
		D (SOIC)	DBV (SOT-23)	DGK (MSOP)	
		8 PINS	5 PINS	8 PINS	
$R_{\theta JA}$	Junction-to-ambient thermal resistance	115.8	158.8	180.4	°C/W
$R_{\theta JC(top)}$	Junction-to-case(top) thermal resistance	60.1	60.7	67.9	°C/W
$R_{\theta JB}$	Junction-to-board thermal resistance	56.4	44.8	102.1	°C/W
$\Psi_{JT}$	Junction-to-top characterization parameter	12.8	1.6	10.4	°C/W
$\Psi_{JB}$	Junction-to-board characterization parameter	55.9	4.2	100.3	°C/W
$R_{\theta JC(bot)}$	Junction-to-case(bottom) thermal resistance	N/A	N/A	N/A	°C/W

- (1) For more information about traditional and new thermal metrics, see the [Semiconductor and IC Package Thermal Metrics](#) application report.

## 7.5 Thermal Information: OPA2180

THERMAL METRIC <sup>(1)</sup>		OPA2180		UNIT
		D (SOIC)	DGK (MSOP)	
		8 PINS	8 PINS	
$R_{\theta JA}$	Junction-to-ambient thermal resistance	111	159.3	°C/W
$R_{\theta JC(top)}$	Junction-to-case (top) thermal resistance	54.9	37.4	°C/W
$R_{\theta JB}$	Junction-to-board thermal resistance	51.7	48.5	°C/W
$\Psi_{JT}$	Junction-to-top characterization parameter	9.3	1.2	°C/W
$\Psi_{JB}$	Junction-to-board characterization parameter	51.1	77.1	°C/W
$R_{\theta JC(bot)}$	Junction-to-case (bottom) thermal resistance	N/A	N/A	°C/W

- (1) For more information about traditional and new thermal metrics, see the [Semiconductor and IC Package Thermal Metrics](#) application report.

## 7.6 Thermal Information: OPA4180

THERMAL METRIC <sup>(1)</sup>		OPA4180		UNIT
		D (SOIC)	PW (TSSOP)	
		14 PINS	14 PINS	
$R_{\theta JA}$	Junction-to-ambient thermal resistance	93.2	106.9	°C/W
$R_{\theta JC(top)}$	Junction-to-case (top) thermal resistance	51.8	24.4	°C/W
$R_{\theta JB}$	Junction-to-board thermal resistance	49.4	59.3	°C/W
$\Psi_{JT}$	Junction-to-top characterization parameter	13.5	0.6	°C/W
$\Psi_{JB}$	Junction-to-board characterization parameter	42.2	54.3	°C/W
$R_{\theta JC(bot)}$	Junction-to-case (bottom) thermal resistance	N/A	N/A	°C/W

- (1) For more information about traditional and new thermal metrics, see the [Semiconductor and IC Package Thermal Metrics](#) application report.

## 7.7 Electrical Characteristics: $V_S = \pm 2\text{ V to } \pm 18\text{ V}$ ( $V_S = 4\text{ V to } 36\text{ V}$ )

 at  $T_A = 25^\circ\text{C}$ ,  $R_L = 10\text{ k}\Omega$  connected to  $V_S / 2$ , and  $V_{\text{COM}} = V_{\text{OUT}} = V_S / 2$ , unless otherwise noted.

PARAMETER		CONDITIONS	MIN	TYP	MAX	UNIT
<b>OFFSET VOLTAGE</b>						
$V_{\text{IO}}$	Input offset voltage			15	75	$\mu\text{V}$
$dV_{\text{IO}}/dT$	Input offset voltage drift	$T_A = -40^\circ\text{C to } +125^\circ\text{C}$		0.1	0.35	$\mu\text{V}/^\circ\text{C}$
PSRR	Power supply rejection ratio	$V_S = 4\text{ V to } 36\text{ V}$ , $V_{\text{CM}} = V_S / 2$		0.1	0.5	$\mu\text{V}/\text{V}$
		$T_A = -40^\circ\text{C to } +125^\circ\text{C}$ , $V_S = 4\text{ V to } 36\text{ V}$ , $V_{\text{CM}} = V_S / 2$			0.5	$\mu\text{V}/\text{V}$
	Long-term stability			4 <sup>(1)</sup>		$\mu\text{V}$
	Channel separation, DC			1		$\mu\text{V}/\text{V}$
<b>INPUT BIAS CURRENT</b>						
$I_{\text{IB}}$	Input bias current	OPA2180		$\pm 0.25$	$\pm 1$	nA
		OPA2180: $T_A = -40^\circ\text{C to } +105^\circ\text{C}$	18		$\pm 5$	nA
		OPA180, OPA4180		$\pm 0.25$	$\pm 1.7$	nA
		OPA180, OPA4180: $T_A = -40^\circ\text{C to } +125^\circ\text{C}$	18		$\pm 6$	nA
$I_{\text{IO}}$	Input offset current	OPA2180		$\pm 0.5$	$\pm 2$	nA
		OPA2180: $T_A = -40^\circ\text{C to } +105^\circ\text{C}$	6		$\pm 2.5$	nA
		OPA180, OPA4180			$\pm 3.4$	nA
		OPA180, OPA4180: $T_A = -40^\circ\text{C to } +125^\circ\text{C}$	6		$\pm 3$	nA
<b>NOISE</b>						
	Input voltage noise	$f = 0.1\text{ Hz to } 10\text{ Hz}$		0.25		$\mu\text{V}_{\text{PP}}$
$e_n$	Input voltage noise density	$f = 1\text{ kHz}$		10		$\text{nV}/\sqrt{\text{Hz}}$
$i_n$	Input current noise density	$f = 1\text{ kHz}$		10		$\text{fA}/\sqrt{\text{Hz}}$
<b>INPUT VOLTAGE RANGE</b>						
$V_{\text{CM}}$	Common-mode voltage range		$V^-$		$(V^+) - 1.5$	V
CMRR	Common-mode rejection ratio	$(V^-) < V_{\text{CM}} < (V^+) - 1.5\text{ V}$	104	114		dB
		$T_A = -40^\circ\text{C to } +125^\circ\text{C}$ , $(V^-) + 0.5\text{ V} < V_{\text{CM}} < (V^+) - 1.5\text{ V}$	100	104		dB
<b>INPUT IMPEDANCE</b>						
$Z_{\text{id}}$	Differential			100    6		$\text{M}\Omega \parallel \text{pF}$
$Z_{\text{ic}}$	Common-mode			6    9.5		$10^{12}\ \Omega \parallel \text{pF}$
<b>OPEN-LOOP GAIN</b>						
$A_{\text{OL}}$	Open-loop voltage gain	$(V^-) + 500\text{ mV} < V_{\text{O}} < (V^+) - 500\text{ mV}$ $R_L = 10\text{ k}\Omega$	110	120		dB
		$T_A = -40^\circ\text{C to } +125^\circ\text{C}$ $(V^-) + 500\text{ mV} < V_{\text{O}} < (V^+) - 500\text{ mV}$ , $R_L = 10\text{ k}\Omega$	104	114		dB
<b>FREQUENCY RESPONSE</b>						
GBW	Gain bandwidth product			2		MHz
SR	Slew rate	$G = 1$		0.8		$\text{V}/\mu\text{s}$
$t_s$	Settling time	0.1%	$V_S = \pm 18\text{ V}$ , $G = 1$ , 10-V step	22		$\mu\text{s}$
		0.01%	$V_S = \pm 18\text{ V}$ , $G = 1$ , 10-V step	30		$\mu\text{s}$
$t_{\text{or}}$	Overload recovery time	$V_{\text{IN}} \times G = V_S$		1		$\mu\text{s}$
THD+N	Total harmonic distortion + noise	$f = 1\text{ kHz}$ , $G = 1$ , $V_{\text{OUT}} = 1\text{ V}_{\text{RMS}}$		0.0001%		

 (1) 1000-hour life test at  $125^\circ\text{C}$  demonstrated randomly distributed variation in the range of measurement limits, or approximately  $4\ \mu\text{V}$ .

**Electrical Characteristics:  $V_S = \pm 2\text{ V}$  to  $\pm 18\text{ V}$  ( $V_S = 4\text{ V}$  to  $36\text{ V}$ ) (continued)**

 at  $T_A = 25^\circ\text{C}$ ,  $R_L = 10\text{ k}\Omega$  connected to  $V_S / 2$ , and  $V_{\text{COM}} = V_{\text{OUT}} = V_S / 2$ , unless otherwise noted.

PARAMETER	CONDITIONS	MIN	TYP	MAX	UNIT
<b>OUTPUT</b>					
Voltage output swing from rail	No load		8	18	mV
	$R_L = 10\text{ k}\Omega$		250	300	mV
	$T_A = -40^\circ\text{C}$ to $+125^\circ\text{C}$ $R_L = 10\text{ k}\Omega$		325	360	mV
$I_{\text{OS}}$	Short-circuit current		$\pm 18$		mA
$r_o$	Output resistance (open loop)	$f = 2\text{ MHz}$ , $I_O = 0\text{ mA}$	120		$\Omega$
$C_{\text{LOAD}}$	Capacitive load drive		1		nF
<b>POWER SUPPLY</b>					
$V_S$	Operating voltage range	$\pm 2$ (or 4)		$\pm 18$ (or 36)	V
$I_Q$	Quiescent current (per amplifier)	$T_A = -40^\circ\text{C}$ to $+125^\circ\text{C}$ $I_O = 0\text{ mA}$	450	525	$\mu\text{A}$
				600	$\mu\text{A}$
<b>TEMPERATURE</b>					
	Specified range		-40	105	$^\circ\text{C}$
	Operating range		-40	105	$^\circ\text{C}$

## 7.8 Typical Characteristics: Table of Graphs

**Table 2. Characteristic Performance Measurements**

DESCRIPTION	FIGURE
$I_B$ and $I_{OS}$ vs Common-Mode Voltage	<a href="#">Figure 1</a>
Input Bias Current vs Temperature	<a href="#">Figure 2</a>
Output Voltage Swing vs Output Current (Maximum Supply)	<a href="#">Figure 3</a>
CMRR vs Temperature	<a href="#">Figure 4</a>
0.1-Hz to 10-Hz Noise	<a href="#">Figure 5</a>
Input Voltage Noise Spectral Density vs Frequency	<a href="#">Figure 6</a>
Open-Loop Gain and Phase vs Frequency	<a href="#">Figure 7</a>
Open-Loop Gain vs Temperature	<a href="#">Figure 8</a>
Open-Loop Output Impedance vs Frequency	<a href="#">Figure 9</a>
Small-Signal Overshoot vs Capacitive Load (100-mV Output Step)	<a href="#">Figure 10</a> , <a href="#">Figure 11</a>
No Phase Reversal	<a href="#">Figure 12</a>
Positive Overload Recovery	<a href="#">Figure 13</a>
Negative Overload Recovery	<a href="#">Figure 14</a>
Small-Signal Step Response (100 mV)	<a href="#">Figure 15</a> , <a href="#">Figure 16</a>
Large-Signal Step Response	<a href="#">Figure 17</a> , <a href="#">Figure 18</a>
Large-Signal Settling Time (10-V Positive Step)	<a href="#">Figure 19</a>
Large-Signal Settling Time (10-V Negative Step)	<a href="#">Figure 20</a>
Short-Circuit Current vs Temperature	<a href="#">Figure 21</a>
Maximum Output Voltage vs Frequency	<a href="#">Figure 22</a>
Channel Separation vs Frequency	<a href="#">Figure 23</a>
EMIRR IN+ vs Frequency	<a href="#">Figure 24</a>

### 7.9 Typical Characteristics

$V_S = \pm 18\text{ V}$ ,  $V_{CM} = V_S / 2$ ,  $R_{LOAD} = 10\text{ k}\Omega$  connected to  $V_S / 2$ , and  $C_L = 100\text{ pF}$ , unless otherwise noted.

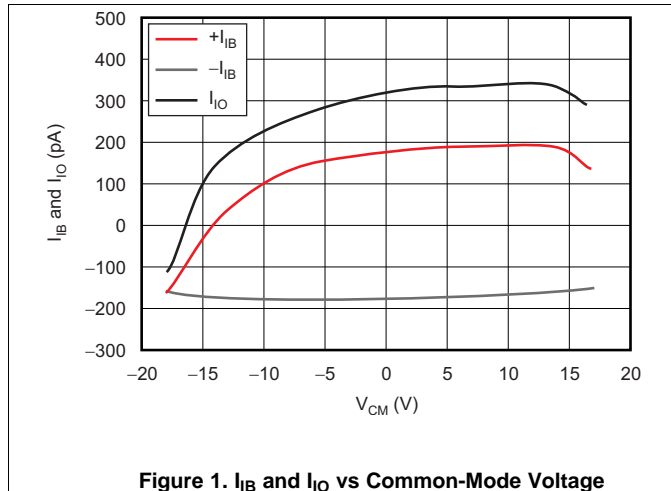

Figure 1.  $I_{IB}$  and  $I_{IO}$  vs Common-Mode Voltage

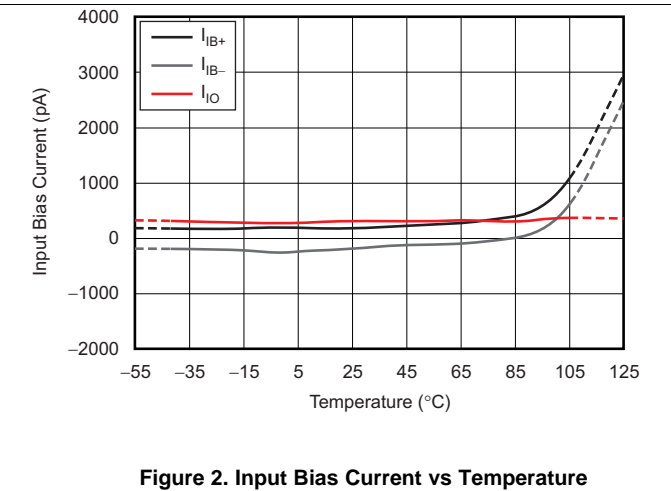

Figure 2. Input Bias Current vs Temperature

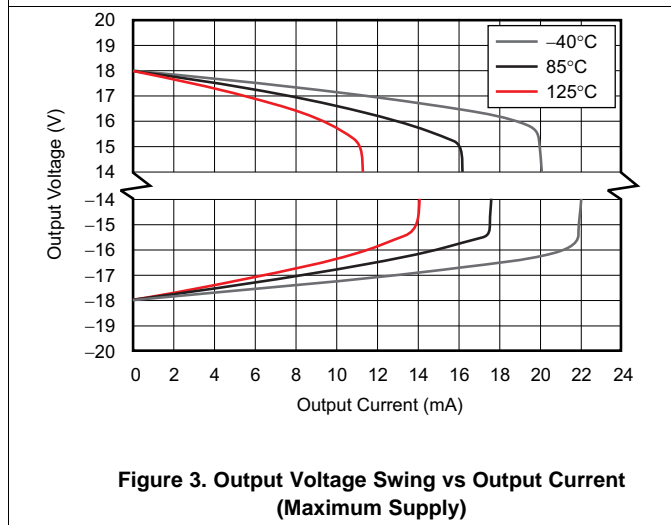
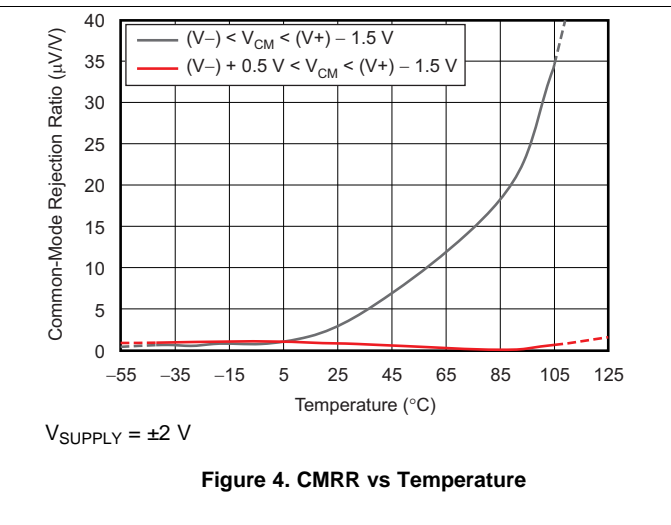

Figure 3. Output Voltage Swing vs Output Current (Maximum Supply)



$V_{SUPPLY} = \pm 2\text{ V}$

Figure 4. CMRR vs Temperature

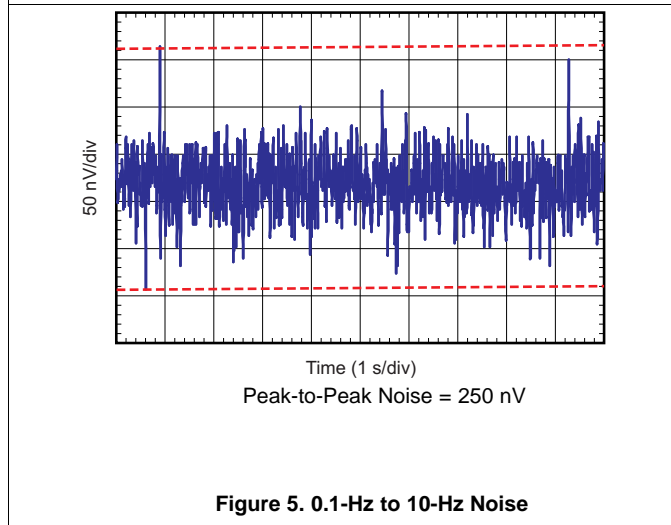

Figure 5. 0.1-Hz to 10-Hz Noise

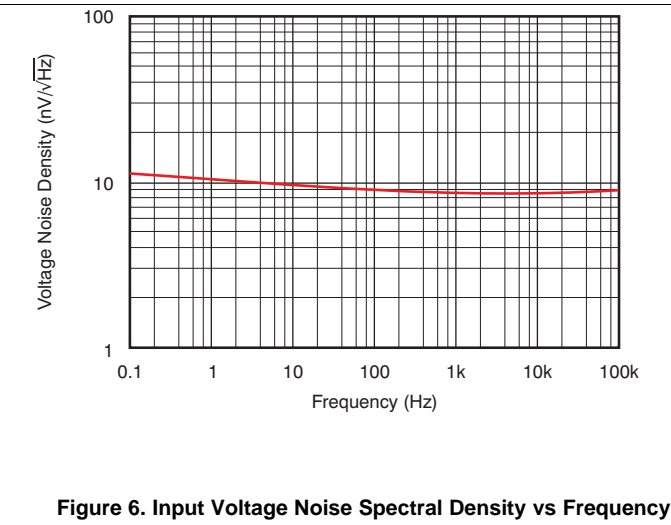

Figure 6. Input Voltage Noise Spectral Density vs Frequency

Typical Characteristics (continued)

$V_S = \pm 18\text{ V}$ ,  $V_{CM} = V_S / 2$ ,  $R_{LOAD} = 10\text{ k}\Omega$  connected to  $V_S / 2$ , and  $C_L = 100\text{ pF}$ , unless otherwise noted.

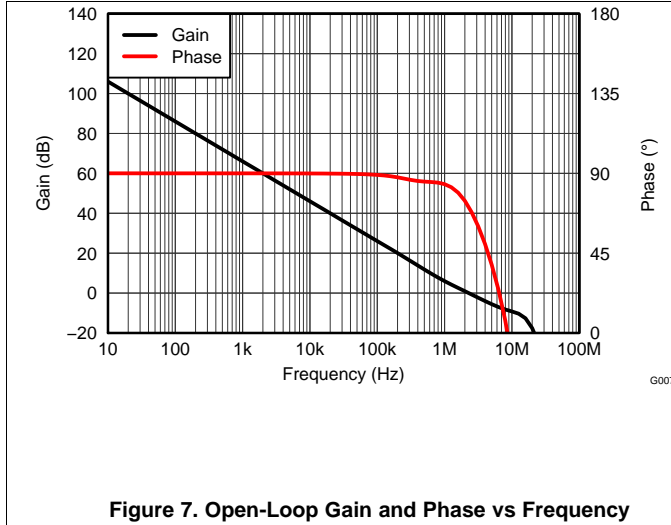

Figure 7. Open-Loop Gain and Phase vs Frequency

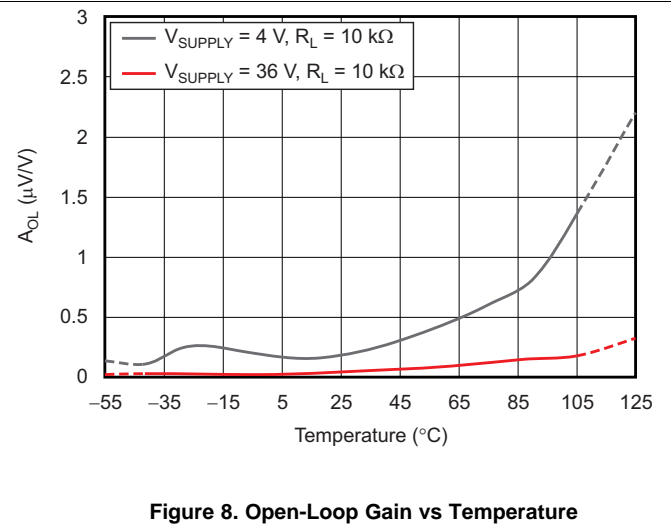

Figure 8. Open-Loop Gain vs Temperature

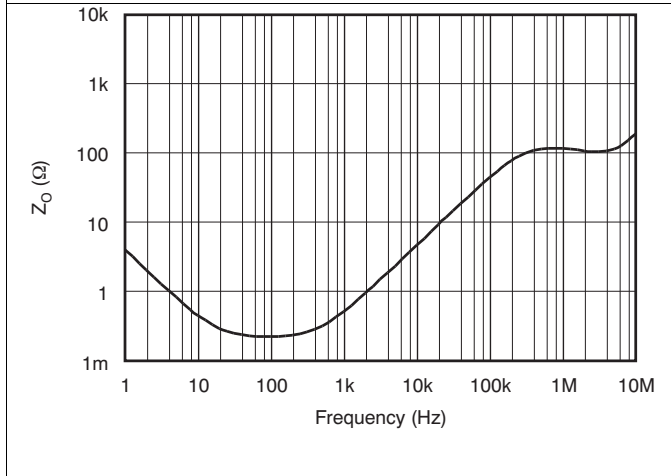

Figure 9. Open-Loop Output Impedance vs Frequency

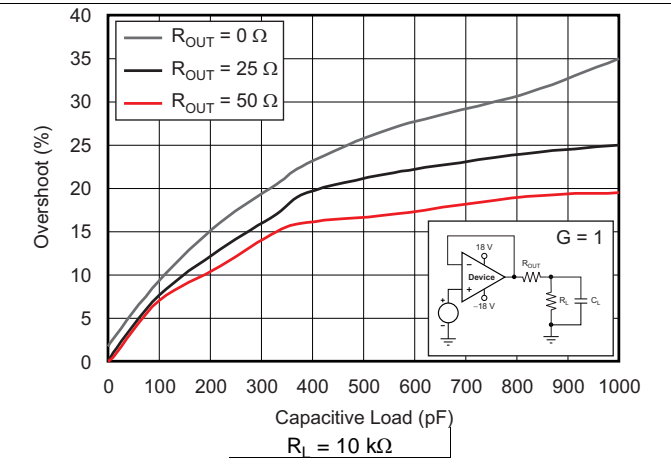
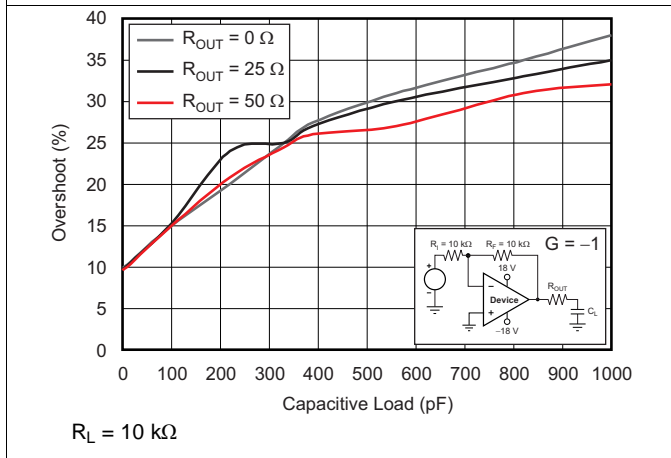

Figure 10. Small-Signal Overshoot vs Capacitive Load (100-mV Output Step)



$R_L = 10\text{ k}\Omega$

Figure 11. Small-Signal Overshoot vs Capacitive Load (100-mV Output Step)

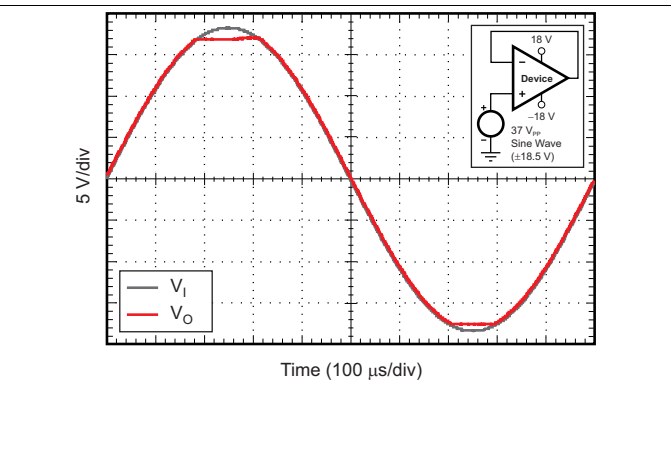

Figure 12. No Phase Reversal

Typical Characteristics (continued)

$V_S = \pm 18\text{ V}$ ,  $V_{CM} = V_S / 2$ ,  $R_{LOAD} = 10\text{ k}\Omega$  connected to  $V_S / 2$ , and  $C_L = 100\text{ pF}$ , unless otherwise noted.

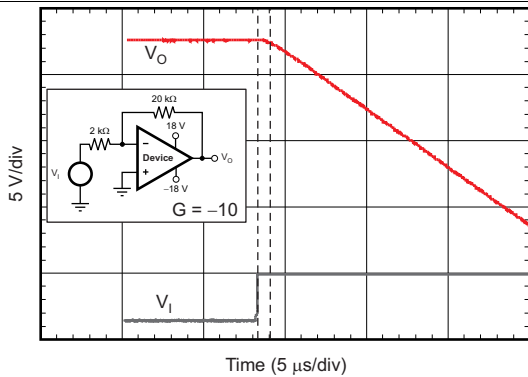

Figure 13. Positive Overload Recovery

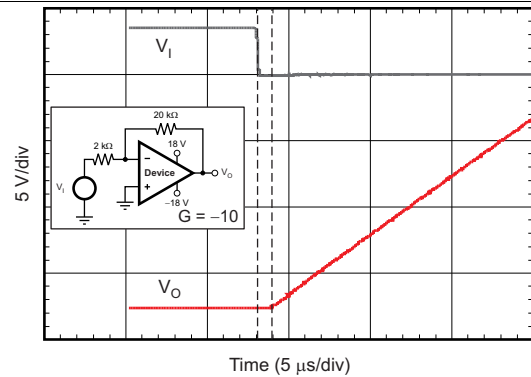

Figure 14. Negative Overload Recovery

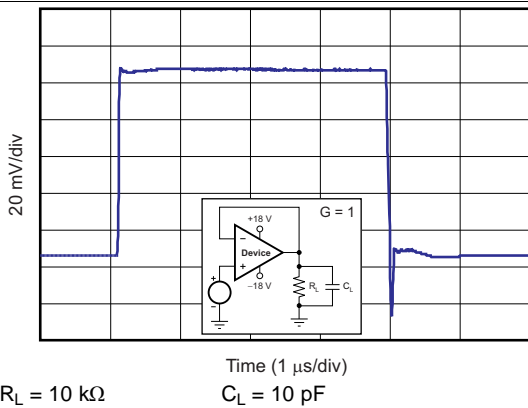

Figure 15. Small-Signal Step Response (100 mV)

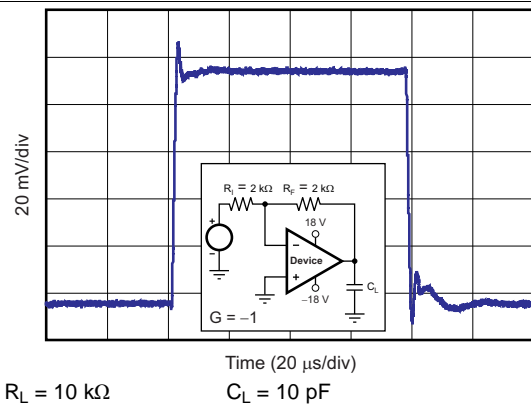

Figure 16. Small-Signal Step Response (100 mV)

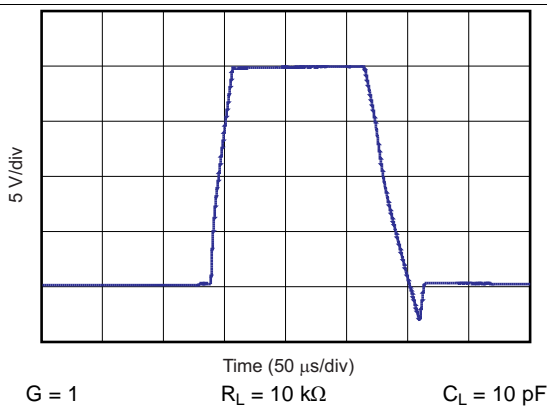

Figure 17. Large-Signal Step Response

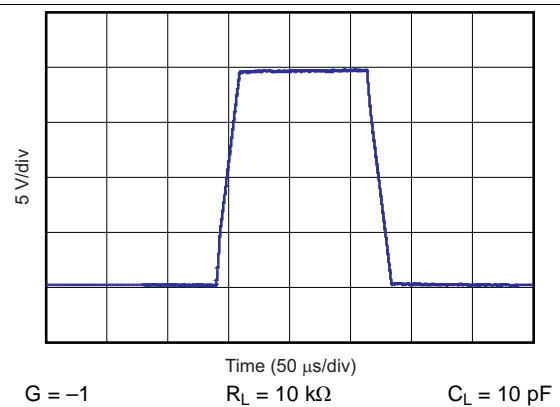

Figure 18. Large-Signal Step Response

Typical Characteristics (continued)

$V_S = \pm 18\text{ V}$ ,  $V_{CM} = V_S / 2$ ,  $R_{LOAD} = 10\text{ k}\Omega$  connected to  $V_S / 2$ , and  $C_L = 100\text{ pF}$ , unless otherwise noted.

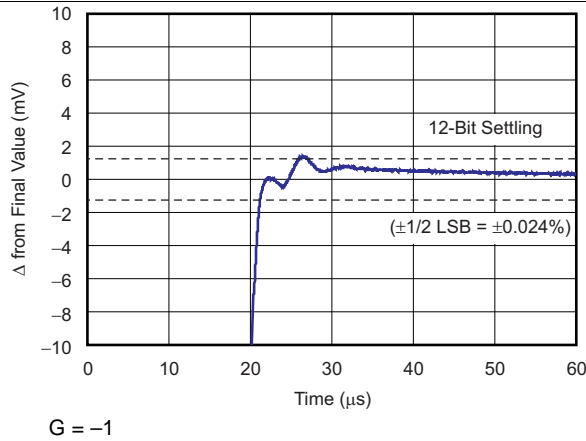

Figure 19. Large-Signal Settling Time (10-V Positive Step)

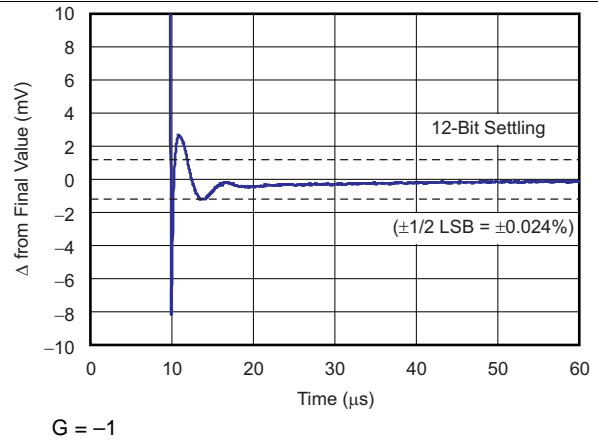

Figure 20. Large-Signal Settling Time (10-V Negative Step)

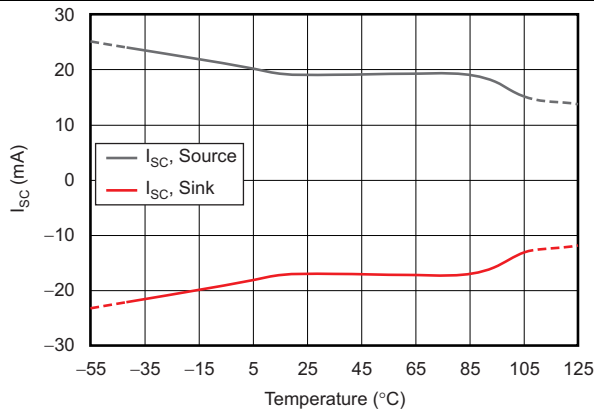

Figure 21. Short-Circuit Current vs Temperature

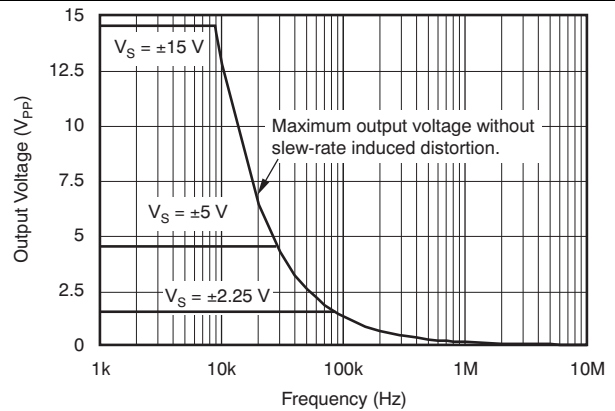

Figure 22. Maximum Output Voltage vs Frequency

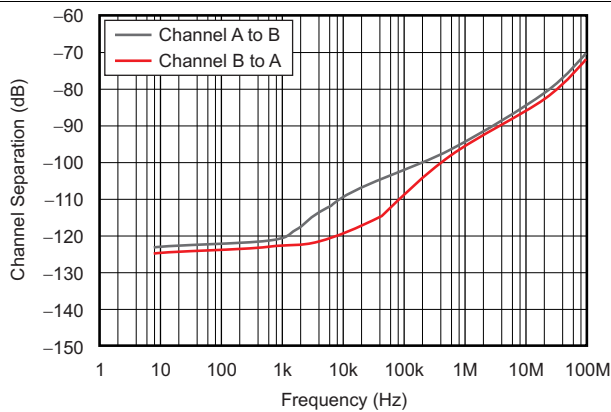

Figure 23. Channel Separation vs Frequency

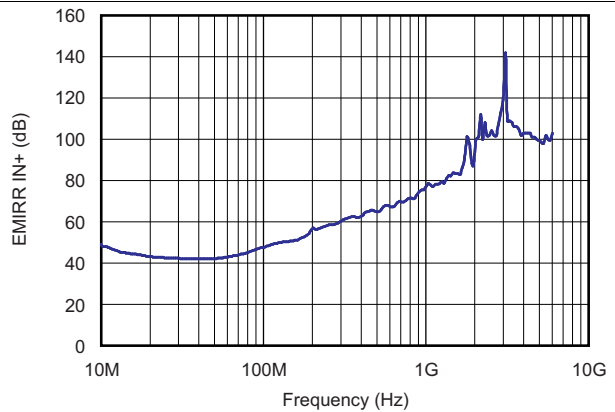

Figure 24. EMIRR IN+ vs Frequency

## 8 Detailed Description

### 8.1 Overview

The OPAx180 family of operational amplifiers combine precision offset and drift with excellent overall performance, making them designed for many precision applications. The precision offset drift of only  $0.1 \mu\text{V}/^\circ\text{C}$  provides stability over the entire temperature range. In addition, the devices offer excellent overall performance with high CMRR, PSRR, and  $A_{OL}$ . As with all amplifiers, applications with noisy or high-impedance power supplies require decoupling capacitors close to the device pins. In most cases,  $0.1\text{-}\mu\text{F}$  capacitors are adequate.

### 8.2 Functional Block Diagram

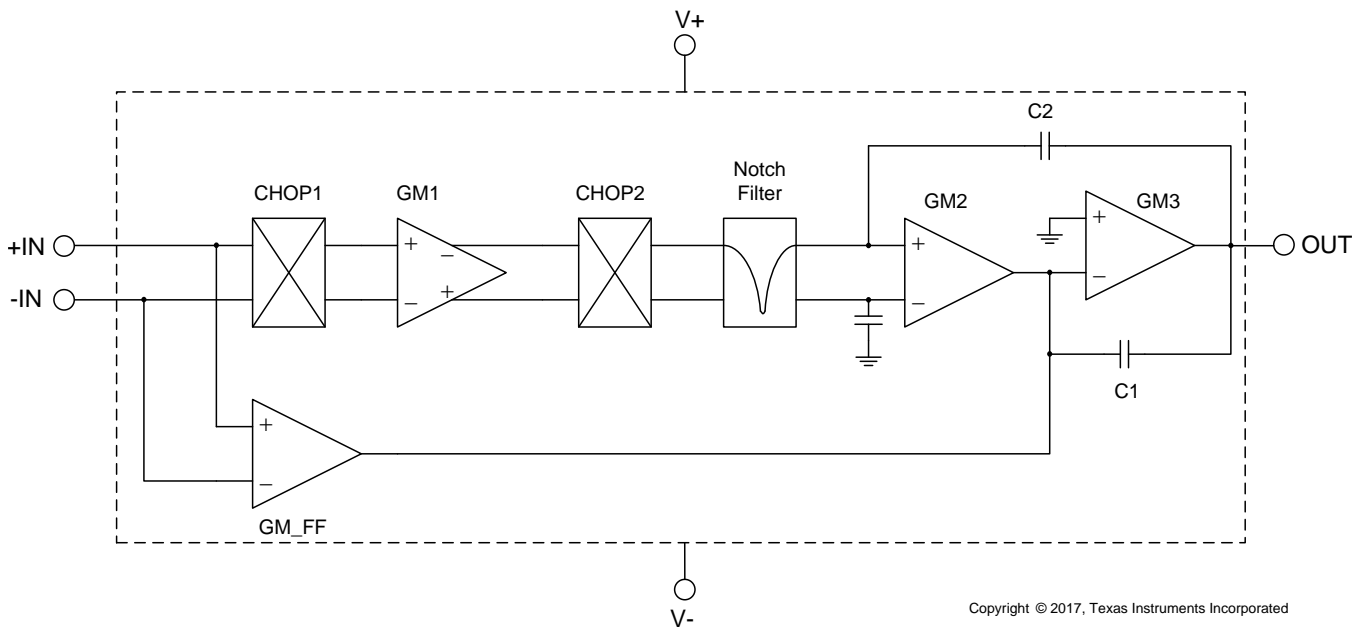

Copyright © 2017, Texas Instruments Incorporated

## 8.3 Feature Description

### 8.3.1 Operating Characteristics

The OPAx180 family of amplifiers is specified for operation from 4 V to 36 V ( $\pm 2$  V to  $\pm 18$  V). Many of the specifications apply from  $-40^{\circ}\text{C}$  to  $+125^{\circ}\text{C}$ . Parameters that can exhibit significant variance with regard to operating voltage or temperature are presented in the [Typical Characteristics](#).

### 8.3.2 EMI Rejection

The OPAx180 family uses integrated electromagnetic interference (EMI) filtering to reduce the effects of EMI interference from sources such as wireless communications and densely populated boards with a mix of analog signal chain and digital components. EMI immunity can improve with circuit design techniques; the OPAx180 family benefits from these design improvements. Texas Instruments has developed the ability to accurately measure and quantify the immunity of an operational amplifier over a broad frequency spectrum extending from 10 MHz to 6 GHz. [Figure 25](#) shows the results of this testing on the OPAx180 family. For more detailed information, see the [EMI Rejection Ratio of Operational Amplifiers](#) application report, available for download from [www.ti.com](http://www.ti.com).

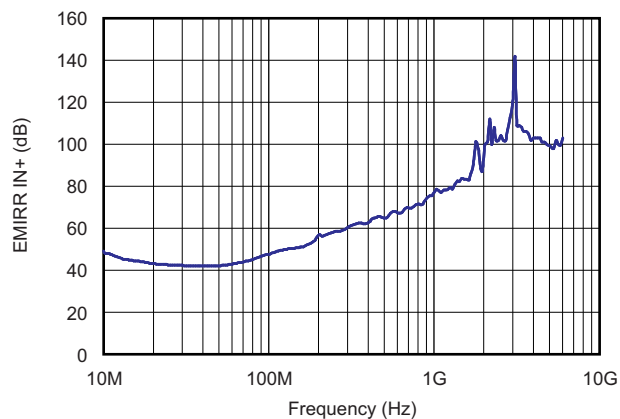

**Figure 25. OPAx180 EMIRR Testing**

### 8.3.3 Phase-Reversal Protection

The OPAx180 family has an internal phase-reversal protection. Many op amps exhibit a phase reversal when the input is driven beyond the linear common-mode range. This condition is most often encountered in noninverting circuits when the input is driven beyond the specified common-mode voltage range, causing the output to reverse into the opposite rail. The input of the OPAx180 prevents phase reversal with excessive common-mode voltage. Instead, the output limits into the appropriate rail. This performance is shown in [Figure 26](#).

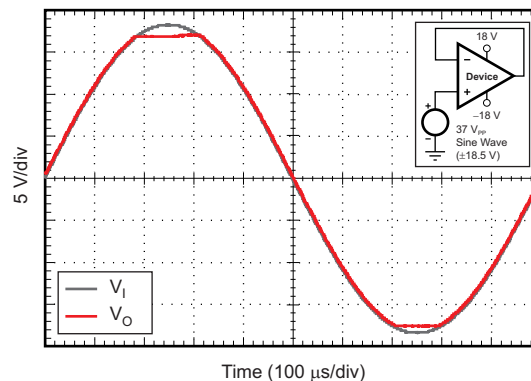
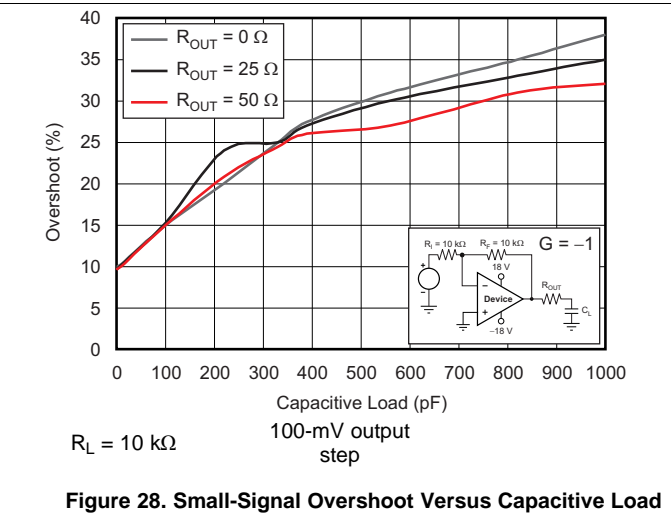
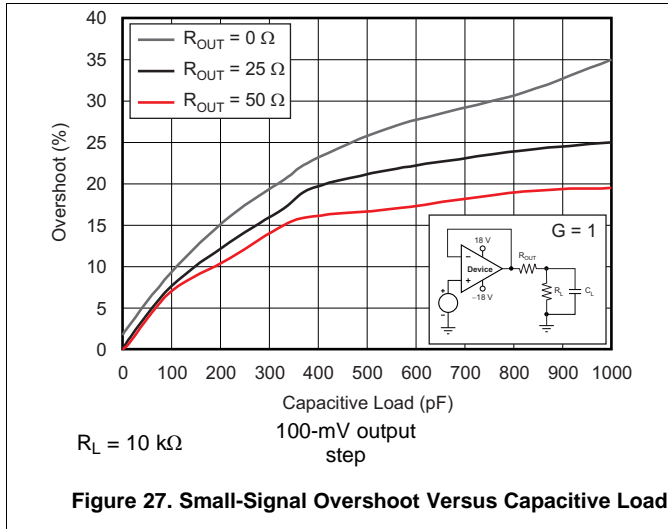

**Figure 26. No Phase Reversal**

## Feature Description (continued)

### 8.3.4 Capacitive Load and Stability

The dynamic characteristics of the OPAx180 are optimized for a range of common operating conditions. The combination of low closed-loop gain and high capacitive loads decreases the phase margin of the amplifier and can lead to gain peaking or oscillations. As a result, heavier capacitive loads must be isolated from the output. The simplest way to achieve this isolation is to add a small resistor (for example,  $R_{OUT}$  equal to  $50\ \Omega$ ) in series with the output. Figure 27 and Figure 28 illustrate graphs of small-signal overshoot versus capacitive load for several values of  $R_{OUT}$ . See the [Feedback Plots Define Op Amp AC Performance](#), application report, available for download from the TI website, for details of analysis techniques and application circuits.



### 8.3.5 Electrical Overstress

Designers often ask questions about the capability of an operational amplifier to withstand electrical overstress. These questions tend to focus on the device inputs, but may involve the supply voltage pins or even the output pin. Each of these different pin functions have electrical stress limits determined by the voltage breakdown characteristics of the particular semiconductor fabrication process and specific circuits connected to the pin. Additionally, internal electrostatic discharge (ESD) protection is built into these circuits to protect them from accidental ESD events both before and during product assembly.

These ESD protection diodes also provide in-circuit, input overdrive protection, as long as the current is limited to 10 mA as stated in the [Absolute Maximum Ratings](#) table. Figure 29 shows how a series input resistor may be added to the driven input to limit the input current. The added resistor contributes thermal noise at the amplifier input and the value must be kept to a minimum in noise-sensitive applications.

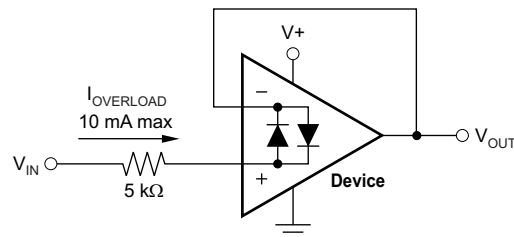

**Figure 29. Input Current Protection**

An ESD event produces a short duration, high-voltage pulse that is transformed into a short duration, high-current pulse as the pulse discharges through a semiconductor device. The ESD protection circuits are designed to provide a current path around the operational amplifier core to protect the core from damage. The energy absorbed by the protection circuitry is then dissipated as heat.

## Feature Description (continued)

When the operational amplifier connects into a circuit, the ESD protection components are intended to remain inactive and not become involved in the application circuit operation. However, circumstances may arise when an applied voltage exceeds the operating voltage range of a given pin. If this condition occurs, there is a risk that some of the internal ESD protection circuits may be biased on, and conduct current. Any such current flow occurs through ESD cells and rarely involves the absorption device.

If there is an uncertainty about the ability of the supply to absorb this current, external zener diodes may be added to the supply pins. The zener voltage must be selected so the diode does not turn on during normal operation.

However, the zener voltage must be low enough so that the zener diode conducts if the supply pin begins to rise above the safe operating supply voltage level.

## 8.4 Device Functional Modes

The OPAx180, OPA2180, and OPA4180 devices are powered on when the supply is connected. These devices can operate as a single-supply operational amplifier or dual-supply amplifier depending on the application. In single-supply operation with  $V_-$  at ground (0 V),  $V_+$  can be any value between 4 V and 36 V. In dual-supply operation, the supply voltage difference between  $V_-$  and  $V_+$  is from 4 V to 36 V. Typical examples of dual-supply configuration are  $\pm 5$  V,  $\pm 10$  V,  $\pm 15$  V, and  $\pm 18$  V. However, the supplies must not be symmetrical. Less common examples are  $V_-$  at  $-3$  V and  $V_+$  at 9 V, or  $V_-$  at  $-16$  V and  $V_+$  at 5 V. Any combination where the difference between  $V_-$  and  $V_+$  is at least 4 V and no greater than 36 V is within the normal operating capabilities of these devices.

## 9 Application and Implementation

### 9.1 Application Information

The OPAx180 family offers excellent DC precision and AC performance. These devices operate up to 36-V supply rails and offer rail-to-rail output, ultra-low offset voltage, offset voltage drift and 2-MHz bandwidth. These features make the OPAx180 a robust, high-performance amplifier for high-voltage industrial applications.

### 9.2 Typical Applications

These application examples highlight a few of the circuits where the OPAx180 family can be used.

#### 9.2.1 Bipolar $\pm 10$ -V Analog Output from a Unipolar Voltage Output DAC

This design is used for conditioning a unipolar digital-to-analog converter (DAC) into an accurate bipolar signal source using the OPAx180 family and three resistors. The circuit is designed with reactive load stability in mind, and is compensated to drive nearly any conventional capacitive load associated with long cable lengths.

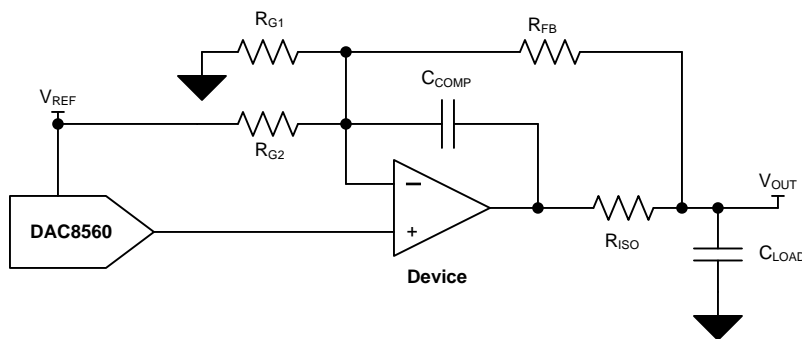

Copyright © 2017, Texas Instruments Incorporated

**Figure 30. Circuit Schematic**

#### 9.2.1.1 Design Requirements

The design requirements are as follows:

- DAC supply voltage: +5-V dc
- Amplifier supply voltage:  $\pm 15$ -V dc
- Input: 3-wire, 24-bit SPI
- Output:  $\pm 10$ -V dc

## Typical Applications (continued)

### 9.2.1.2 Detailed Design Procedure

#### 9.2.1.2.1 Component Selection

**DAC:** For convenience, devices with an external reference option or devices with accessible internal references are desirable in this application because the reference creates an offset. The DAC selection in this design must primarily be based on DC error contributions typically described by offset error, gain error, and integral nonlinearity error. Occasionally, additional specifications are provided that summarize end-point errors of the DAC typically called zero-code and full-scale errors. For AC applications, slew rate and settling time may require additional consideration.

**Amplifier:** Amplifier input offset voltage ( $V_{IO}$ ) is a key consideration for this design.  $V_{IO}$  of an operational amplifier is a typical data sheet specification, but in-circuit performance is also affected by drift over temperature, the common-mode rejection ratio (CMRR), and power-supply rejection ratio (PSRR); thus consideration should be given to these parameters as well. For ac operation, additional considerations should be made concerning slew rate and settling time. Input bias current ( $I_{IB}$ ) can also be a factor, but typically the resistor network is implemented with sufficiently small resistor values that the effects of input bias current are negligible.

**Passive:** Resistor matching for the op-amp resistor network is critical for the success of this design; components with tight tolerances must be selected. For this design, 0.1% resistor values are implemented, but this constraint may be adjusted based on application-specific design goals. Resistor matching contributes to offset error and gain error in this design; see [Bipolar  \$\pm 10V\$  Analog Output from a Unipolar Voltage Output DAC](#) for further details. The tolerance of the  $R_{ISO}$  and  $C_{COMP}$  stability components is not critical, and 1% components are acceptable.

#### 9.2.1.3 Application Curves

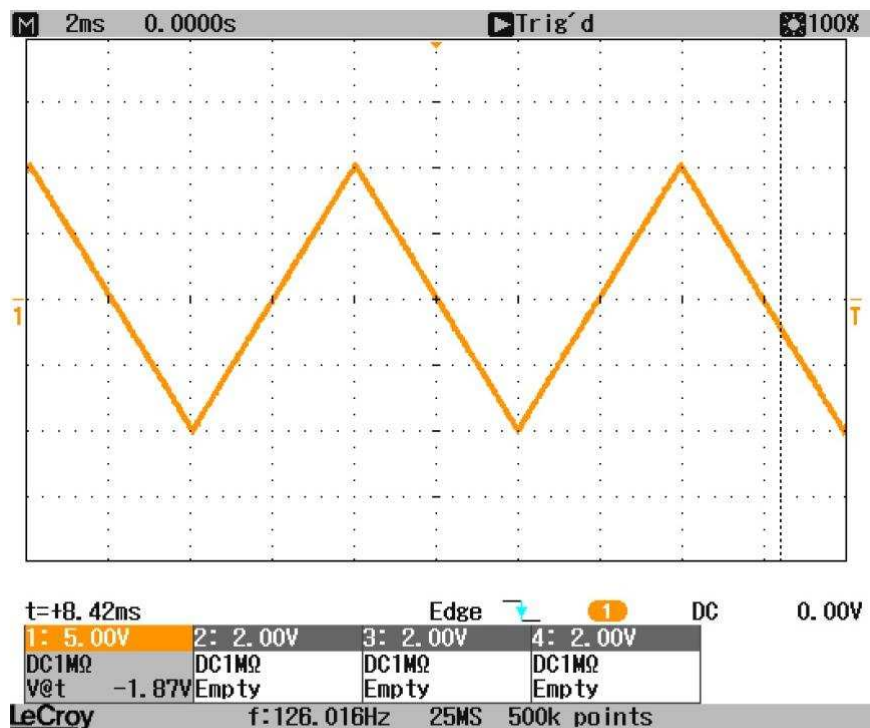

**Figure 31. Full-Scale Output Waveform**

**Typical Applications (continued)**

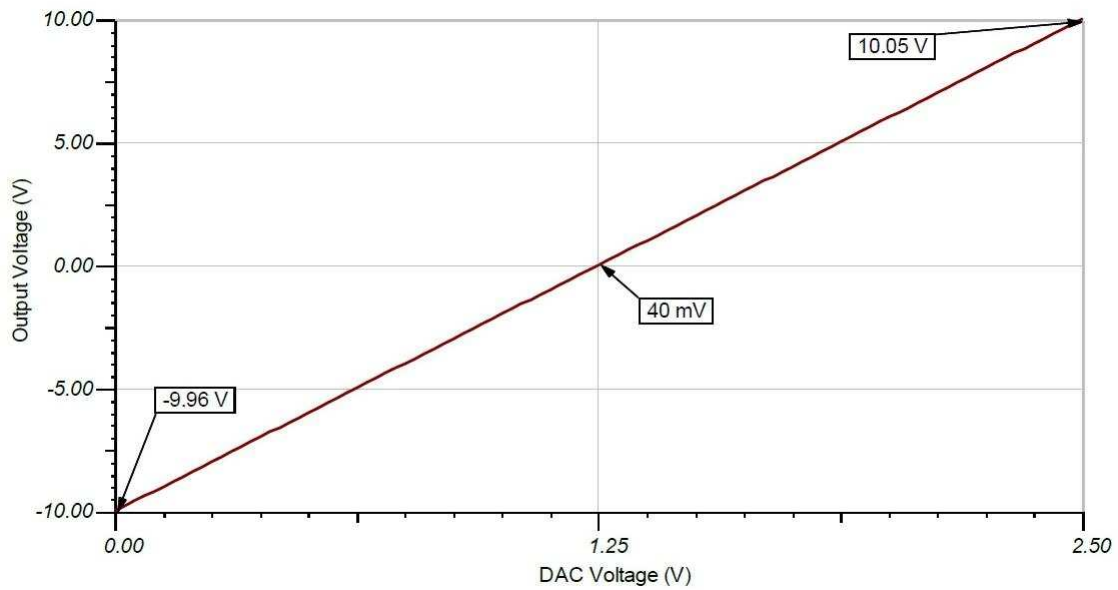

**Figure 32. DC Transfer Characteristic**



For step-by-step design procedure, circuit schematics, bill of materials, PCB files, simulation results, and test results, refer to [TI Precision Design TIPD125, Bipolar ±10V Analog Output from a Unipolar Voltage Output DAC](#)

### 9.2.2 Discrete INA + Attenuation

The OPAx180 family can be used as a high-voltage, high-impedance front-end for a precision, discrete instrumentation amplifier with attenuation. The INA159 in Figure 33 provides the attenuation that allows this circuit to simply interface with 3.3-V or 5-V analog-to-digital converters (ADCs).

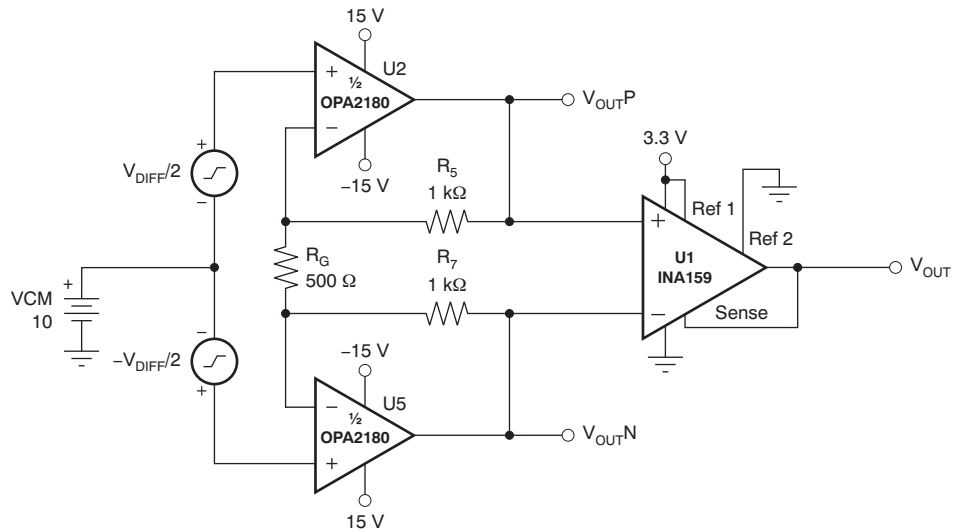

**Figure 33. Discrete INA + Attenuation for ADC With a 3.3-V Supply**

### 9.2.3 RTD Amplifier

The OPAx180 is excellent for use in analog linearization of resistance temperature detectors (RTDs). The circuit below (Figure 34) combines the precision of the OPAx180 amplifier and the precision reference of the REF5050 to linearize a Pt100 RTD.

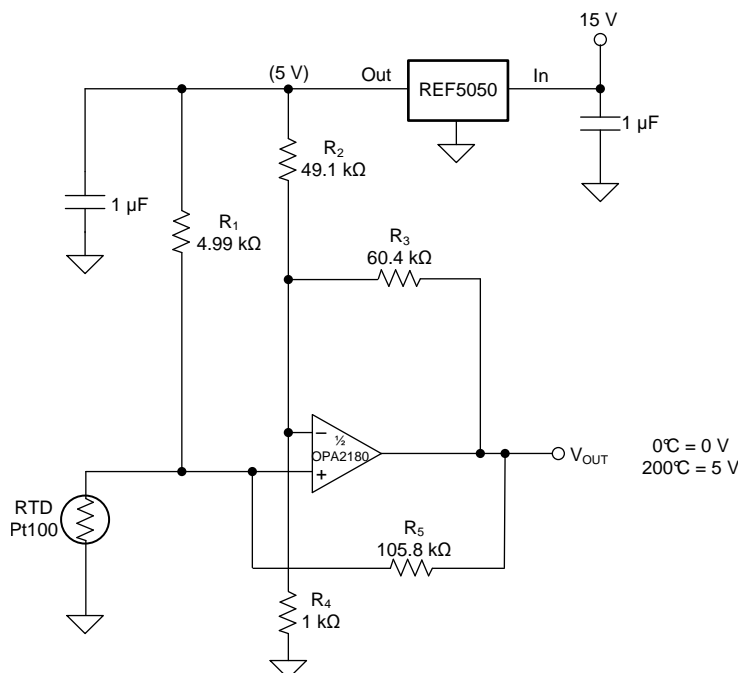

Copyright © 2017, Texas Instruments Incorporated

(1) R<sub>5</sub> provides positive-varying excitation to linearize output.

**Figure 34. RTD Amplifier with Linearization**

## 10 Power Supply Recommendations

The OPAx180 family is specified for operation from 4 V to 36 V ( $\pm 2$  V to  $\pm 18$  V); many specifications apply from  $-40^{\circ}\text{C}$  to  $+125^{\circ}\text{C}$ . Parameters that can exhibit significant variance with regard to operating voltage or temperature are presented in [Layout](#)

### CAUTION

Supply voltages larger than 40 V can permanently damage the device; see the [Absolute Maximum Ratings](#).

Place 0.1- $\mu\text{F}$  bypass capacitors close to the power-supply pins to reduce errors coupling in from noisy or high-impedance power supplies. For more detailed information on bypass capacitor placement, see [Layout](#).

## 11 Layout

### 11.1 Layout Guidelines

For best operational performance of the device, use good printed circuit board (PCB) layout practices, including:

- Noise can propagate into analog circuitry through the power pins of the circuit as a whole and op amp itself. Bypass capacitors are used to reduce the coupled noise by providing low-impedance power sources local to the analog circuitry.
  - Connect low-ESR, 0.1- $\mu$ F ceramic bypass capacitors between each supply pin and ground, placed as close to the device as possible. A single bypass capacitor from V+ to ground is applicable for single-supply applications.
- Separate grounding for analog and digital portions of circuitry is one of the simplest and most-effective methods of noise suppression. One or more layers on multilayer PCBs are typically devoted to ground planes. A ground plane helps distribute heat and reduces EMI noise pickup. Take care to physically separate digital and analog grounds, paying attention to the flow of the ground current.
- In order to reduce parasitic coupling, run the input traces as far away from the supply or output traces as possible. If it is not possible to keep the input traces separate, it is much better to cross the sensitive trace perpendicular as opposed to in parallel with the noisy trace.
- Place the external components as close to the device as possible. As shown in [Figure 35](#), keeping RF and RG close to the inverting input minimizes parasitic capacitance.
- Keep the length of input traces as short as possible. Always remember that the input traces are the most sensitive part of the circuit.
- Consider a driven, low-impedance guard ring around the critical traces. A guard ring can significantly reduce leakage currents from nearby traces that are at different potentials.

### 11.2 Layout Example

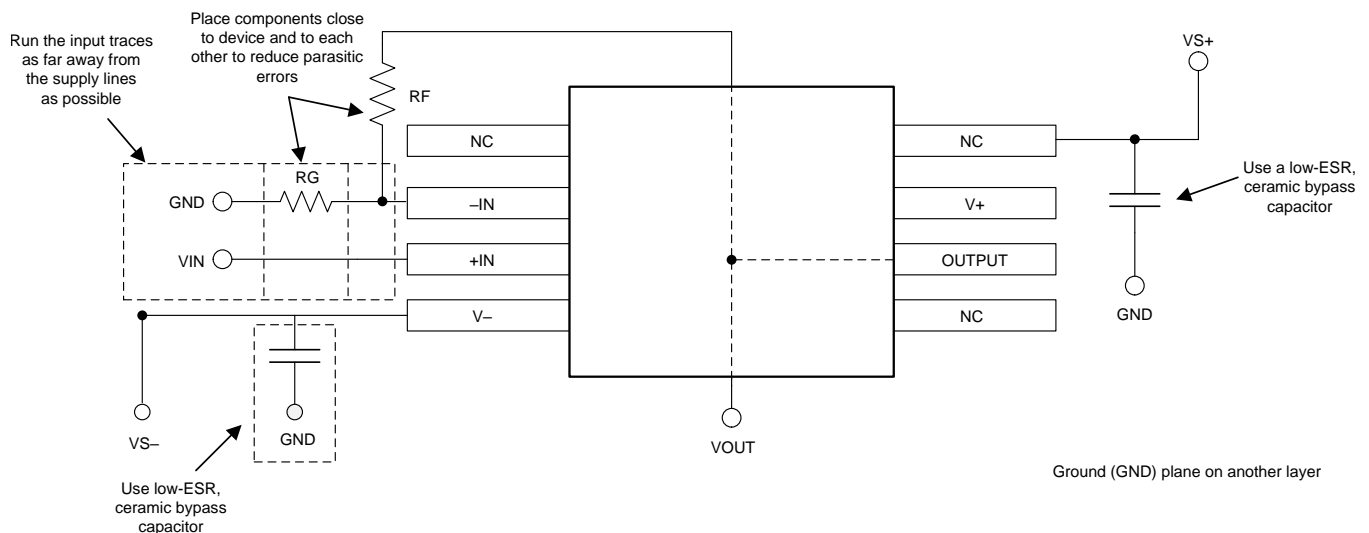

**Figure 35. Operational Amplifier Board Layout for Noninverting Configuration**

## 12 Device and Documentation Support

### 12.1 Related Links

[Table 3](#) lists quick access links. Categories include technical documents, support and community resources, tools and software, and quick access to sample or buy.

**Table 3. Related Links**

PARTS	PRODUCT FOLDER	ORDER NOW	TECHNICAL DOCUMENTS	TOOLS & SOFTWARE	SUPPORT & COMMUNITY
OPA180	<a href="#">Click here</a>	<a href="#">Click here</a>	<a href="#">Click here</a>	<a href="#">Click here</a>	<a href="#">Click here</a>
OPA2180	<a href="#">Click here</a>	<a href="#">Click here</a>	<a href="#">Click here</a>	<a href="#">Click here</a>	<a href="#">Click here</a>
OPA4180	<a href="#">Click here</a>	<a href="#">Click here</a>	<a href="#">Click here</a>	<a href="#">Click here</a>	<a href="#">Click here</a>

### 12.2 Trademarks

All trademarks are the property of their respective owners.

### 12.3 Electrostatic Discharge Caution



These devices have limited built-in ESD protection. The leads should be shorted together or the device placed in conductive foam during storage or handling to prevent electrostatic damage to the MOS gates.

### 12.4 Glossary

[SLYZ022](#) — *TI Glossary*.

This glossary lists and explains terms, acronyms, and definitions.

## 13 Mechanical, Packaging, and Orderable Information

The following pages include mechanical, packaging, and orderable information. This information is the most current data available for the designated devices. This data is subject to change without notice and revision of this document. For browser-based versions of this data sheet, refer to the left-hand navigation.

**PACKAGING INFORMATION**

Orderable part number	Status (1)	Material type (2)	Package   Pins	Package qty   Carrier	RoHS (3)	Lead finish/ Ball material (4)	MSL rating/ Peak reflow (5)	Op temp (°C)	Part marking (6)
<a href="#">OPA180ID</a>	Active	Production	SOIC (D)   8	75   TUBE	Yes	NIPDAU	Level-2-260C-1 YEAR	-40 to 125	OPA180
OPA180ID.B	Active	Production	SOIC (D)   8	75   TUBE	Yes	NIPDAU	Level-2-260C-1 YEAR	-40 to 125	OPA180
<a href="#">OPA180IDBVR</a>	Active	Production	SOT-23 (DBV)   5	3000   LARGE T&R	Yes	NIPDAU	Level-2-260C-1 YEAR	-40 to 125	SHJ
OPA180IDBVR.B	Active	Production	SOT-23 (DBV)   5	3000   LARGE T&R	Yes	NIPDAU	Level-2-260C-1 YEAR	-40 to 125	SHJ
<a href="#">OPA180IDBVT</a>	Active	Production	SOT-23 (DBV)   5	250   SMALL T&R	Yes	NIPDAU	Level-2-260C-1 YEAR	-40 to 125	SHJ
OPA180IDBVT.B	Active	Production	SOT-23 (DBV)   5	250   SMALL T&R	Yes	NIPDAU	Level-2-260C-1 YEAR	-40 to 125	SHJ
OPA180IDBVTG4	Active	Production	SOT-23 (DBV)   5	250   SMALL T&R	Yes	NIPDAU	Level-2-260C-1 YEAR	-40 to 125	SHJ
OPA180IDBVTG4.B	Active	Production	SOT-23 (DBV)   5	250   SMALL T&R	Yes	NIPDAU	Level-2-260C-1 YEAR	-40 to 125	SHJ
<a href="#">OPA180IDGKR</a>	Active	Production	VSSOP (DGK)   8	2500   LARGE T&R	Yes	NIPDAU	Level-2-260C-1 YEAR	-40 to 125	SHK
OPA180IDGKR.B	Active	Production	VSSOP (DGK)   8	2500   LARGE T&R	Yes	NIPDAU	Level-2-260C-1 YEAR	-40 to 125	SHK
<a href="#">OPA180IDGKT</a>	Active	Production	VSSOP (DGK)   8	250   SMALL T&R	Yes	NIPDAU	Level-2-260C-1 YEAR	-40 to 125	SHK
OPA180IDGKT.B	Active	Production	VSSOP (DGK)   8	250   SMALL T&R	Yes	NIPDAU	Level-2-260C-1 YEAR	-40 to 125	SHK
<a href="#">OPA180IDR</a>	Active	Production	SOIC (D)   8	2500   LARGE T&R	Yes	NIPDAU	Level-2-260C-1 YEAR	-40 to 125	OPA180
OPA180IDR.B	Active	Production	SOIC (D)   8	2500   LARGE T&R	Yes	NIPDAU	Level-2-260C-1 YEAR	-40 to 125	OPA180
OPA180IDRG4	Active	Production	SOIC (D)   8	2500   LARGE T&R	Yes	NIPDAU	Level-2-260C-1 YEAR	-40 to 125	OPA180
OPA180IDRG4.B	Active	Production	SOIC (D)   8	2500   LARGE T&R	Yes	NIPDAU	Level-2-260C-1 YEAR	-40 to 125	OPA180
<a href="#">OPA2180ID</a>	Active	Production	SOIC (D)   8	75   TUBE	Yes	NIPDAU	Level-2-260C-1 YEAR	-40 to 125	2180
OPA2180ID.A	Active	Production	SOIC (D)   8	75   TUBE	Yes	NIPDAU	Level-2-260C-1 YEAR	-40 to 125	2180
OPA2180ID.B	Active	Production	SOIC (D)   8	75   TUBE	Yes	NIPDAU	Level-2-260C-1 YEAR	-40 to 125	2180
<a href="#">OPA2180IDGK</a>	Active	Production	VSSOP (DGK)   8	80   TUBE	Yes	NIPDAUAG	Level-2-260C-1 YEAR	-40 to 125	2180
OPA2180IDGK.A	Active	Production	VSSOP (DGK)   8	80   TUBE	Yes	NIPDAUAG	Level-2-260C-1 YEAR	-40 to 125	2180
OPA2180IDGK.B	Active	Production	VSSOP (DGK)   8	80   TUBE	Yes	NIPDAUAG	Level-2-260C-1 YEAR	-40 to 125	2180
<a href="#">OPA2180IDGKR</a>	Active	Production	VSSOP (DGK)   8	2500   LARGE T&R	Yes	NIPDAU   SN	Level-2-260C-1 YEAR	-40 to 125	2180
OPA2180IDGKR.A	Active	Production	VSSOP (DGK)   8	2500   LARGE T&R	Yes	NIPDAU	Level-2-260C-1 YEAR	-40 to 125	2180
OPA2180IDGKR.B	Active	Production	VSSOP (DGK)   8	2500   LARGE T&R	Yes	NIPDAU	Level-2-260C-1 YEAR	-40 to 125	2180
OPA2180IDGKRG4	Active	Production	VSSOP (DGK)   8	2500   LARGE T&R	Yes	NIPDAU	Level-2-260C-1 YEAR	-40 to 125	2180
OPA2180IDGKRG4.A	Active	Production	VSSOP (DGK)   8	2500   LARGE T&R	Yes	NIPDAU	Level-2-260C-1 YEAR	-40 to 125	2180
OPA2180IDGKRG4.B	Active	Production	VSSOP (DGK)   8	2500   LARGE T&R	Yes	NIPDAU	Level-2-260C-1 YEAR	-40 to 125	2180
<a href="#">OPA2180IDR</a>	Active	Production	SOIC (D)   8	2500   LARGE T&R	Yes	NIPDAU	Level-2-260C-1 YEAR	-40 to 125	2180

Orderable part number	Status (1)	Material type (2)	Package   Pins	Package qty   Carrier	RoHS (3)	Lead finish/ Ball material (4)	MSL rating/ Peak reflow (5)	Op temp (°C)	Part marking (6)
OPA2180IDR.A	Active	Production	SOIC (D)   8	2500   LARGE T&R	Yes	NIPDAU	Level-2-260C-1 YEAR	-40 to 125	2180
OPA2180IDR.B	Active	Production	SOIC (D)   8	2500   LARGE T&R	Yes	NIPDAU	Level-2-260C-1 YEAR	-40 to 125	2180
OPA2180IDRG4	Active	Production	SOIC (D)   8	2500   LARGE T&R	Yes	NIPDAU	Level-2-260C-1 YEAR	-40 to 125	2180
OPA2180IDRG4.A	Active	Production	SOIC (D)   8	2500   LARGE T&R	Yes	NIPDAU	Level-2-260C-1 YEAR	-40 to 125	2180
OPA2180IDRG4.B	Active	Production	SOIC (D)   8	2500   LARGE T&R	Yes	NIPDAU	Level-2-260C-1 YEAR	-40 to 125	2180
<a href="#">OPA4180ID</a>	Active	Production	SOIC (D)   14	50   TUBE	Yes	NIPDAU	Level-2-260C-1 YEAR	-40 to 125	OPA4180
OPA4180ID.B	Active	Production	SOIC (D)   14	50   TUBE	Yes	NIPDAU	Level-2-260C-1 YEAR	-40 to 125	OPA4180
<a href="#">OPA4180IDR</a>	Active	Production	SOIC (D)   14	2500   LARGE T&R	Yes	NIPDAU	Level-2-260C-1 YEAR	-40 to 125	OPA4180
OPA4180IDR.B	Active	Production	SOIC (D)   14	2500   LARGE T&R	Yes	NIPDAU	Level-2-260C-1 YEAR	-40 to 125	OPA4180
<a href="#">OPA4180IPW</a>	Active	Production	TSSOP (PW)   14	90   TUBE	Yes	NIPDAU	Level-2-260C-1 YEAR	-40 to 125	OPA4180
OPA4180IPW.B	Active	Production	TSSOP (PW)   14	90   TUBE	Yes	NIPDAU	Level-2-260C-1 YEAR	-40 to 125	OPA4180
<a href="#">OPA4180IPWR</a>	Active	Production	TSSOP (PW)   14	2000   LARGE T&R	Yes	NIPDAU	Level-2-260C-1 YEAR	-40 to 125	OPA4180
OPA4180IPWR.B	Active	Production	TSSOP (PW)   14	2000   LARGE T&R	Yes	NIPDAU	Level-2-260C-1 YEAR	-40 to 125	OPA4180
OPA4180IPWRG4	Active	Production	TSSOP (PW)   14	2000   LARGE T&R	Yes	NIPDAU	Level-2-260C-1 YEAR	-40 to 125	OPA4180
OPA4180IPWRG4.B	Active	Production	TSSOP (PW)   14	2000   LARGE T&R	Yes	NIPDAU	Level-2-260C-1 YEAR	-40 to 125	OPA4180

(1) **Status:** For more details on status, see our [product life cycle](#).

(2) **Material type:** When designated, preproduction parts are prototypes/experimental devices, and are not yet approved or released for full production. Testing and final process, including without limitation quality assurance, reliability performance testing, and/or process qualification, may not yet be complete, and this item is subject to further changes or possible discontinuation. If available for ordering, purchases will be subject to an additional waiver at checkout, and are intended for early internal evaluation purposes only. These items are sold without warranties of any kind.

(3) **RoHS values:** Yes, No, RoHS Exempt. See the [TI RoHS Statement](#) for additional information and value definition.

(4) **Lead finish/Ball material:** Parts may have multiple material finish options. Finish options are separated by a vertical ruled line. Lead finish/Ball material values may wrap to two lines if the finish value exceeds the maximum column width.

(5) **MSL rating/Peak reflow:** The moisture sensitivity level ratings and peak solder (reflow) temperatures. In the event that a part has multiple moisture sensitivity ratings, only the lowest level per JEDEC standards is shown. Refer to the shipping label for the actual reflow temperature that will be used to mount the part to the printed circuit board.

(6) **Part marking:** There may be an additional marking, which relates to the logo, the lot trace code information, or the environmental category of the part.

Multiple part markings will be inside parentheses. Only one part marking contained in parentheses and separated by a "~" will appear on a part. If a line is indented then it is a continuation of the previous line and the two combined represent the entire part marking for that device.

**Important Information and Disclaimer:** The information provided on this page represents TI's knowledge and belief as of the date that it is provided. TI bases its knowledge and belief on information provided by third parties, and makes no representation or warranty as to the accuracy of such information. Efforts are underway to better integrate information from third parties. TI has taken and continues to take reasonable steps to provide representative and accurate information but may not have conducted destructive testing or chemical analysis on incoming materials and chemicals. TI and TI suppliers consider certain information to be proprietary, and thus CAS numbers and other limited information may not be available for release.

In no event shall TI's liability arising out of such information exceed the total purchase price of the TI part(s) at issue in this document sold by TI to Customer on an annual basis.

**OTHER QUALIFIED VERSIONS OF OPA180, OPA2180 :**

- Automotive : [OPA180-Q1](#), [OPA2180-Q1](#)

NOTE: Qualified Version Definitions:

- Automotive - Q100 devices qualified for high-reliability automotive applications targeting zero defects

**TAPE AND REEL INFORMATION**

**QUADRANT ASSIGNMENTS FOR PIN 1 ORIENTATION IN TAPE**



\*All dimensions are nominal

Device	Package Type	Package Drawing	Pins	SPQ	Reel Diameter (mm)	Reel Width W1 (mm)	A0 (mm)	B0 (mm)	K0 (mm)	P1 (mm)	W (mm)	Pin1 Quadrant
OPA180IDBVR	SOT-23	DBV	5	3000	178.0	9.0	3.3	3.2	1.4	4.0	8.0	Q3
OPA180IDBVR	SOT-23	DBV	5	3000	180.0	8.4	3.23	3.17	1.37	4.0	8.0	Q3
OPA180IDBVT	SOT-23	DBV	5	250	180.0	8.4	3.23	3.17	1.37	4.0	8.0	Q3
OPA180IDBVTG4	SOT-23	DBV	5	250	180.0	8.4	3.23	3.17	1.37	4.0	8.0	Q3
OPA180IDGKR	VSSOP	DGK	8	2500	330.0	12.4	5.3	3.4	1.4	8.0	12.0	Q1
OPA180IDGKT	VSSOP	DGK	8	250	177.8	12.4	5.3	3.4	1.4	8.0	12.0	Q1
OPA180IDR	SOIC	D	8	2500	330.0	12.4	6.4	5.2	2.1	8.0	12.0	Q1
OPA180IDRG4	SOIC	D	8	2500	330.0	12.4	6.4	5.2	2.1	8.0	12.0	Q1
OPA2180IDGKR	VSSOP	DGK	8	2500	330.0	12.4	5.25	3.35	1.25	8.0	12.0	Q1
OPA2180IDGKR	VSSOP	DGK	8	2500	330.0	12.4	5.3	3.4	1.4	8.0	12.0	Q1
OPA2180IDGKRG4	VSSOP	DGK	8	2500	330.0	12.4	5.3	3.4	1.4	8.0	12.0	Q1
OPA2180IDR	SOIC	D	8	2500	330.0	12.4	6.4	5.2	2.1	8.0	12.0	Q1
OPA2180IDRG4	SOIC	D	8	2500	330.0	12.4	6.4	5.2	2.1	8.0	12.0	Q1
OPA4180IDR	SOIC	D	14	2500	330.0	16.4	6.5	9.0	2.1	8.0	16.0	Q1
OPA4180IPWR	TSSOP	PW	14	2000	330.0	12.4	6.9	5.6	1.6	8.0	12.0	Q1
OPA4180IPWRG4	TSSOP	PW	14	2000	330.0	12.4	6.9	5.6	1.6	8.0	12.0	Q1

**TAPE AND REEL BOX DIMENSIONS**

\*All dimensions are nominal

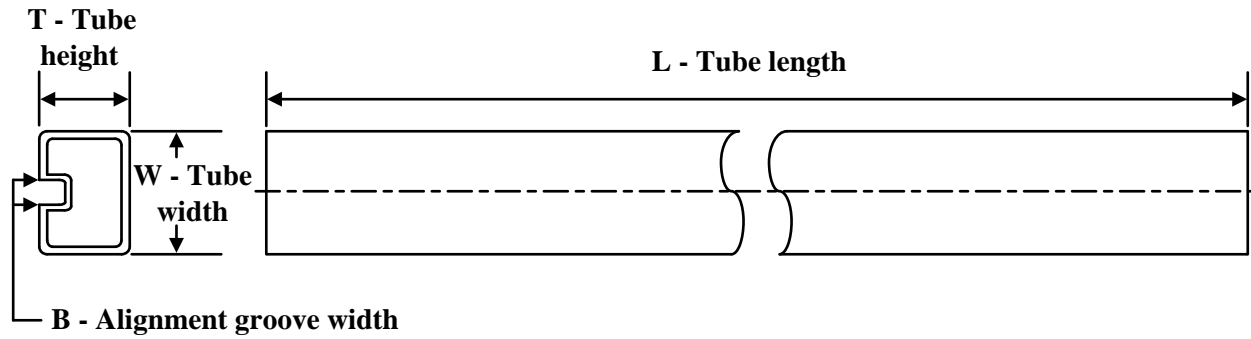
Device	Package Type	Package Drawing	Pins	SPQ	Length (mm)	Width (mm)	Height (mm)
OPA180IDBVR	SOT-23	DBV	5	3000	190.0	190.0	30.0
OPA180IDBVR	SOT-23	DBV	5	3000	223.0	270.0	35.0
OPA180IDBVT	SOT-23	DBV	5	250	223.0	270.0	35.0
OPA180IDBVTG4	SOT-23	DBV	5	250	223.0	270.0	35.0
OPA180IDGKR	VSSOP	DGK	8	2500	346.0	346.0	29.0
OPA180IDGKT	VSSOP	DGK	8	250	223.0	270.0	35.0
OPA180IDR	SOIC	D	8	2500	353.0	353.0	32.0
OPA180IDRG4	SOIC	D	8	2500	353.0	353.0	32.0
OPA2180IDGKR	VSSOP	DGK	8	2500	366.0	364.0	50.0
OPA2180IDGKR	VSSOP	DGK	8	2500	353.0	353.0	32.0
OPA2180IDGKRG4	VSSOP	DGK	8	2500	353.0	353.0	32.0
OPA2180IDR	SOIC	D	8	2500	353.0	353.0	32.0
OPA2180IDRG4	SOIC	D	8	2500	353.0	353.0	32.0
OPA4180IDR	SOIC	D	14	2500	353.0	353.0	32.0
OPA4180IPWR	TSSOP	PW	14	2000	353.0	353.0	32.0
OPA4180IPWRG4	TSSOP	PW	14	2000	353.0	353.0	32.0

**TUBE**

\*All dimensions are nominal

Device	Package Name	Package Type	Pins	SPQ	L (mm)	W (mm)	T (μm)	B (mm)
OPA180ID	D	SOIC	8	75	506.6	8	3940	4.32
OPA180ID.B	D	SOIC	8	75	506.6	8	3940	4.32
OPA2180ID	D	SOIC	8	75	506.6	8	3940	4.32
OPA2180ID.A	D	SOIC	8	75	506.6	8	3940	4.32
OPA2180ID.B	D	SOIC	8	75	506.6	8	3940	4.32
OPA2180IDGK	DGK	VSSOP	8	80	330	6.55	500	2.88
OPA2180IDGK.A	DGK	VSSOP	8	80	330	6.55	500	2.88
OPA2180IDGK.B	DGK	VSSOP	8	80	330	6.55	500	2.88
OPA4180ID	D	SOIC	14	50	506.6	8	3940	4.32
OPA4180ID.B	D	SOIC	14	50	506.6	8	3940	4.32
OPA4180IPW	PW	TSSOP	14	90	508	8.5	3250	2.8
OPA4180IPW.B	PW	TSSOP	14	90	508	8.5	3250	2.8



D0008A

# PACKAGE OUTLINE

SOIC - 1.75 mm max height

SMALL OUTLINE INTEGRATED CIRCUIT



4214825/C 02/2019

### NOTES:

1. Linear dimensions are in inches [millimeters]. Dimensions in parenthesis are for reference only. Controlling dimensions are in inches. Dimensioning and tolerancing per ASME Y14.5M.
2. This drawing is subject to change without notice.
3. This dimension does not include mold flash, protrusions, or gate burrs. Mold flash, protrusions, or gate burrs shall not exceed  $.006$  [0.15] per side.
4. This dimension does not include interlead flash.
5. Reference JEDEC registration MS-012, variation AA.

# EXAMPLE BOARD LAYOUT

D0008A

SOIC - 1.75 mm max height

SMALL OUTLINE INTEGRATED CIRCUIT



LAND PATTERN EXAMPLE  
 EXPOSED METAL SHOWN  
 SCALE:8X



SOLDER MASK DETAILS

4214825/C 02/2019

NOTES: (continued)

- 6. Publication IPC-7351 may have alternate designs.
- 7. Solder mask tolerances between and around signal pads can vary based on board fabrication site.

# EXAMPLE STENCIL DESIGN

D0008A

SOIC - 1.75 mm max height

SMALL OUTLINE INTEGRATED CIRCUIT



SOLDER PASTE EXAMPLE  
BASED ON .005 INCH [0.125 MM] THICK STENCIL  
SCALE:8X

4214825/C 02/2019

NOTES: (continued)

8. Laser cutting apertures with trapezoidal walls and rounded corners may offer better paste release. IPC-7525 may have alternate design recommendations.
9. Board assembly site may have different recommendations for stencil design.



4220202/B 12/2023

NOTES:

1. All linear dimensions are in millimeters. Any dimensions in parenthesis are for reference only. Dimensioning and tolerancing per ASME Y14.5M.
2. This drawing is subject to change without notice.
3. This dimension does not include mold flash, protrusions, or gate burrs. Mold flash, protrusions, or gate burrs shall not exceed 0.15 mm per side.
4. This dimension does not include interlead flash. Interlead flash shall not exceed 0.25 mm per side.
5. Reference JEDEC registration MO-153.

# EXAMPLE BOARD LAYOUT

PW0014A

TSSOP - 1.2 mm max height

SMALL OUTLINE PACKAGE



LAND PATTERN EXAMPLE  
EXPOSED METAL SHOWN  
SCALE: 10X



4220202/B 12/2023

NOTES: (continued)

- 6. Publication IPC-7351 may have alternate designs.
- 7. Solder mask tolerances between and around signal pads can vary based on board fabrication site.

# EXAMPLE STENCIL DESIGN

PW0014A

TSSOP - 1.2 mm max height

SMALL OUTLINE PACKAGE



SOLDER PASTE EXAMPLE  
BASED ON 0.125 mm THICK STENCIL  
SCALE: 10X

4220202/B 12/2023

NOTES: (continued)

8. Laser cutting apertures with trapezoidal walls and rounded corners may offer better paste release. IPC-7525 may have alternate design recommendations.
9. Board assembly site may have different recommendations for stencil design.



# EXAMPLE BOARD LAYOUT

DBV0005A

SOT-23 - 1.45 mm max height

SMALL OUTLINE TRANSISTOR



LAND PATTERN EXAMPLE  
EXPOSED METAL SHOWN  
SCALE:15X



SOLDER MASK DETAILS

4214839/K 08/2024

NOTES: (continued)

- 6. Publication IPC-7351 may have alternate designs.
- 7. Solder mask tolerances between and around signal pads can vary based on board fabrication site.

# EXAMPLE STENCIL DESIGN

DBV0005A

SOT-23 - 1.45 mm max height

SMALL OUTLINE TRANSISTOR



SOLDER PASTE EXAMPLE  
BASED ON 0.125 mm THICK STENCIL  
SCALE:15X

4214839/K 08/2024

NOTES: (continued)

8. Laser cutting apertures with trapezoidal walls and rounded corners may offer better paste release. IPC-7525 may have alternate design recommendations.
9. Board assembly site may have different recommendations for stencil design.

# DGK0008A



# PACKAGE OUTLINE

VSSOP - 1.1 mm max height

SMALL OUTLINE PACKAGE



4214862/A 04/2023

**NOTES:**

PowerPAD is a trademark of Texas Instruments.

1. All linear dimensions are in millimeters. Any dimensions in parenthesis are for reference only. Dimensioning and tolerancing per ASME Y14.5M.
2. This drawing is subject to change without notice.
3. This dimension does not include mold flash, protrusions, or gate burrs. Mold flash, protrusions, or gate burrs shall not exceed 0.15 mm per side.
4. This dimension does not include interlead flash. Interlead flash shall not exceed 0.25 mm per side.
5. Reference JEDEC registration MO-187.

# EXAMPLE BOARD LAYOUT

DGK0008A

™ VSSOP - 1.1 mm max height

SMALL OUTLINE PACKAGE



LAND PATTERN EXAMPLE  
EXPOSED METAL SHOWN  
SCALE: 15X



SOLDER MASK DETAILS

4214862/A 04/2023

NOTES: (continued)

6. Publication IPC-7351 may have alternate designs.
7. Solder mask tolerances between and around signal pads can vary based on board fabrication site.
8. Vias are optional depending on application, refer to device data sheet. If any vias are implemented, refer to their locations shown on this view. It is recommended that vias under paste be filled, plugged or tented.
9. Size of metal pad may vary due to creepage requirement.

# EXAMPLE STENCIL DESIGN

DGK0008A

™ VSSOP - 1.1 mm max height

SMALL OUTLINE PACKAGE



SOLDER PASTE EXAMPLE  
SCALE: 15X

4214862/A 04/2023

NOTES: (continued)

11. Laser cutting apertures with trapezoidal walls and rounded corners may offer better paste release. IPC-7525 may have alternate design recommendations.
12. Board assembly site may have different recommendations for stencil design.



# D0014A

# PACKAGE OUTLINE

## SOIC - 1.75 mm max height

SMALL OUTLINE INTEGRATED CIRCUIT



4220718/A 09/2016

### NOTES:

1. All linear dimensions are in millimeters. Dimensions in parenthesis are for reference only. Dimensioning and tolerancing per ASME Y14.5M.
2. This drawing is subject to change without notice.
3. This dimension does not include mold flash, protrusions, or gate burrs. Mold flash, protrusions, or gate burrs shall not exceed 0.15 mm, per side.
4. This dimension does not include interlead flash. Interlead flash shall not exceed 0.43 mm, per side.
5. Reference JEDEC registration MS-012, variation AB.

# EXAMPLE BOARD LAYOUT

D0014A

SOIC - 1.75 mm max height

SMALL OUTLINE INTEGRATED CIRCUIT



LAND PATTERN EXAMPLE  
SCALE:8X



SOLDER MASK DETAILS

4220718/A 09/2016

NOTES: (continued)

- 6. Publication IPC-7351 may have alternate designs.
- 7. Solder mask tolerances between and around signal pads can vary based on board fabrication site.

# EXAMPLE STENCIL DESIGN

D0014A

SOIC - 1.75 mm max height

SMALL OUTLINE INTEGRATED CIRCUIT



SOLDER PASTE EXAMPLE  
BASED ON 0.125 mm THICK STENCIL  
SCALE:8X

4220718/A 09/2016

NOTES: (continued)

8. Laser cutting apertures with trapezoidal walls and rounded corners may offer better paste release. IPC-7525 may have alternate design recommendations.
9. Board assembly site may have different recommendations for stencil design.

## IMPORTANT NOTICE AND DISCLAIMER

TI PROVIDES TECHNICAL AND RELIABILITY DATA (INCLUDING DATASHEETS), DESIGN RESOURCES (INCLUDING REFERENCE DESIGNS), APPLICATION OR OTHER DESIGN ADVICE, WEB TOOLS, SAFETY INFORMATION, AND OTHER RESOURCES "AS IS" AND WITH ALL FAULTS, AND DISCLAIMS ALL WARRANTIES, EXPRESS AND IMPLIED, INCLUDING WITHOUT LIMITATION ANY IMPLIED WARRANTIES OF MERCHANTABILITY, FITNESS FOR A PARTICULAR PURPOSE OR NON-INFRINGEMENT OF THIRD PARTY INTELLECTUAL PROPERTY RIGHTS.

These resources are intended for skilled developers designing with TI products. You are solely responsible for (1) selecting the appropriate TI products for your application, (2) designing, validating and testing your application, and (3) ensuring your application meets applicable standards, and any other safety, security, regulatory or other requirements.

These resources are subject to change without notice. TI grants you permission to use these resources only for development of an application that uses the TI products described in the resource. Other reproduction and display of these resources is prohibited. No license is granted to any other TI intellectual property right or to any third party intellectual property right. TI disclaims responsibility for, and you fully indemnify TI and its representatives against any claims, damages, costs, losses, and liabilities arising out of your use of these resources.

TI's products are provided subject to [TI's Terms of Sale](#), [TI's General Quality Guidelines](#), or other applicable terms available either on [ti.com](#) or provided in conjunction with such TI products. TI's provision of these resources does not expand or otherwise alter TI's applicable warranties or warranty disclaimers for TI products. Unless TI explicitly designates a product as custom or customer-specified, TI products are standard, catalog, general purpose devices.

TI objects to and rejects any additional or different terms you may propose.

Copyright © 2026, Texas Instruments Incorporated

Last updated 10/2025