

BQ34Z100 Wide Range Fuel Gauge with Impedance Track™ Technology

1 Features

- Supports Li-ion and LiFePO₄ chemistries
- Capacity estimation using patented Impedance Track™ technology for batteries from 3 V to 65 V
 - Aging compensation
 - Self-discharge compensation
- Supports battery capacities above 65 Ah
- Supports charge and discharge currents above 32 A
- External NTC thermistor support
- Supports two-wire I²C and HDQ single-wire communication interfaces with host system
- SHA-1/HMAC Authentication
- One- or four-LED direct display control
- Five-LED and higher display through port expander
- Reduced power modes (typical battery pack operating range conditions)
 - NORMAL operation: < 140- μ A average
 - SLEEP: < 64- μ A average
 - FULL SLEEP: < 19 - μ A average
- Package: 14-pin TSSOP

2 Applications

- [Light electric vehicles](#)
- [Medical instrumentation](#)
- [Mobile radios](#)
- [Power tools](#)
- [Uninterruptible power supplies \(UPS\)](#)

3 Description

The Texas Instruments BQ34Z100 is a fuel gauge solution that works independently of battery series-cell configurations, and supports a wide range of Li-ion and LiFePO₄ battery chemistries. Batteries from 3 V to 65 V can be supported through an external voltage translation circuit that can be controlled automatically to reduce system power consumption.

The BQ34Z100 device provides several interface options, including an I²C slave, an HDQ slave, one or four direct LEDs, and an $\overline{\text{ALERT}}$ output pin. Additionally, the BQ34Z100 provides support for an external port expander for more than four LEDs.

Device Information

PART NUMBER (1)	PACKAGE	BODY SIZE (NOM)
BQ34Z100	TSSOP (14)	5.00 mm × 4.40 mm

(1) For all available packages, see the orderable addendum at the end of the data sheet.

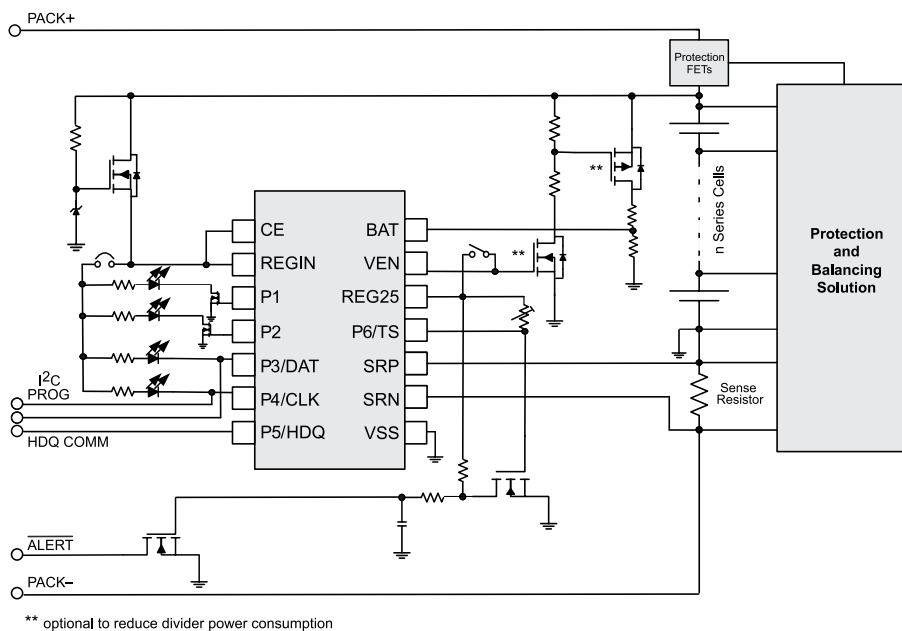

Simplified Schematic



Table of Contents

1 Features	1	6.13 Timing Requirements: HDQ Communication.....	7
2 Applications	1	6.14 Timing Requirements: I ² C-Compatible Interface.....	8
3 Description	1	6.15 Typical Characteristics.....	9
4 Revision History	2	7 Detailed Description	10
5 Pin Configuration and Functions	3	7.1 Overview.....	10
6 Specifications	4	7.2 Feature Description.....	11
6.1 Absolute Maximum Ratings.....	4	7.3 Device Functional Modes.....	39
6.2 ESD Ratings.....	4	8 Application and Implementation	40
6.3 Recommended Operating Conditions.....	4	8.1 Typical Applications.....	40
6.4 Thermal Information.....	5	9 Power Supply Recommendations	49
6.5 Electrical Characteristics: Power-On Reset.....	5	10 Layout	50
6.6 Electrical Characteristics: LDO Regulator.....	5	10.1 Layout Guidelines.....	50
6.7 Electrical Characteristics: Internal Temperature Sensor Characteristics.....	5	10.2 Layout Example.....	50
6.8 Electrical Characteristics: Low-Frequency Oscillator.....	6	11 Device and Documentation Support	53
6.9 Electrical Characteristics: High-Frequency Oscillator.....	6	11.1 Documentation Support.....	53
6.10 Electrical Characteristics: Integrating ADC (Coulomb Counter) Characteristics.....	6	11.2 Receiving Notification of Documentation Updates..	53
6.11 Electrical Characteristics: ADC (Temperature and Cell Measurement) Characteristics.....	6	11.3 Support Resources.....	53
6.12 Electrical Characteristics: Data Flash Memory Characteristics.....	7	11.4 Trademarks.....	53
		11.5 Electrostatic Discharge Caution.....	53
		11.6 Glossary.....	53
		12 Mechanical, Packaging, and Orderable Information	53

4 Revision History

NOTE: Page numbers for previous revisions may differ from page numbers in the current version.

Changes from Revision B (December 2012) to Revision C (May 2021)	Page
• Changed document format per updated Texas Instruments standards, as well as updated SRP and SRN pins throughout the document.....	1
• Changed <i>Ground System</i>	50
• Changed <i>Board Offset Considerations</i>	51

Changes from Revision A (September 2012) to Revision B (December 2012)	Page
• Changed <i>Absolute Maximum Ratings</i>	4
• Changed <i>Section 6.3</i>	4
• Changed <i>Section 7.2.15.3</i>	38
• Changed <i>SLEEP Mode</i>	39
• Changed <i>FULL SLEEP Mode</i>	39
• Changed STEP 3.....	44

5 Pin Configuration and Functions

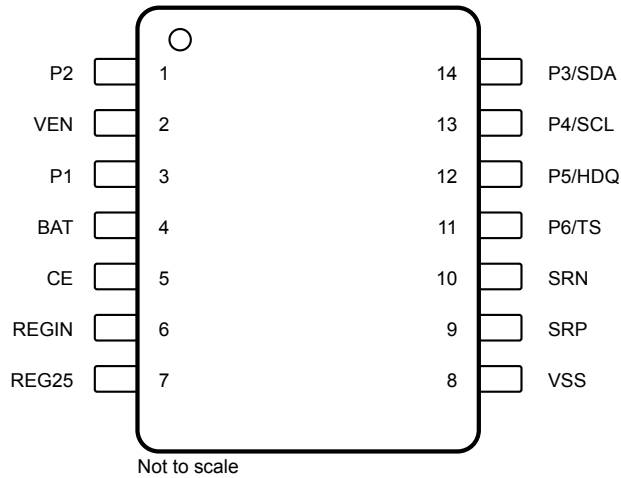

Table 5-1. Pin Functions

PIN		I/O	DESCRIPTION
NAME	NUMBER		
P2	1	O	LED 2 or Not Used (connect to Vss)
VEN	2	O	Active High Voltage Translation Enable. This signal is optionally used to switch the input voltage divider on/off to reduce the power consumption (typ 45 μ A) of the divider network. If not used, then this pin can be left floating or tied to Vss.
P1	3	O	LED 1 or Not Used (connect to Vss). This pin is also used to drive an LED for single-LED mode. Use a small signal N-FET (Q1) in series with the LED as shown on Figure 8-4 .
BAT	4	I	Translated Battery Voltage Input
CE	5	I	Chip Enable. Internal LDO is disconnected from REGIN when driven low.
REGIN	6	P	Internal integrated LDO input. Decouple with a 0.1- μ F ceramic capacitor to Vss.
REG25	7	P	2.5-V Output voltage of the internal integrated LDO. Decouple with 1- μ F ceramic capacitor to Vss.
VSS	8	P	Device ground
SRP	9	I	Analog input pin connected to the internal coulomb-counter peripheral for integrating a small voltage between SRP and SRN where SRP is nearest the BAT– connection.
SRN	10	I	Analog input pin connected to the internal coulomb-counter peripheral for integrating a small voltage between SRP and SRN where SRN is nearest the PACK– connection.
P6/TS	11	I	Pack thermistor voltage sense (use 103AT-type thermistor)
P5/HDQ	12	I/O	Open drain HDQ Serial communication line (slave). If not used, then this pin can be left floating or tied to Vss.
P4/SCL	13	I	Slave I ² C serial communication clock input. Use with a 10-K Ω pull-up resistor (typical). This pin is also used for LED 4 in the four-LED mode. If not used, then this pin can be left floating or tied to Vss.
P3/SDA	14	I/O	Open drain slave I ² C serial communication data line. Use with a 10-k Ω pull-up resistor (typical). This pin is also used for LED 3 in the four-LED mode. If not used, then this pin can be left floating or tied to Vss.

6 Specifications

6.1 Absolute Maximum Ratings

Over operating free-air temperature range (unless otherwise noted)⁽¹⁾

		MIN	MAX	UNIT
V _{REGIN}	Regulator Input Range	-0.3	5.5	V
V _{CC}	Supply Voltage Range	-0.3	2.75	V
V _{IOD}	Open-drain I/O pins (SDA, SCL, HDQ, VEN)	-0.3	5.5	V
V _{BAT}	Bat Input pin	-0.3	5.5	V
V _I	Input Voltage range to all other pins (P1, P2, SRP, SRN)	-0.3	V _{CC} + 0.3	V
ESD	Human-body model (HBM), BAT pin		1.5	kV
	Human-body model (HBM), all other pins		2	kV
T _A	Operating free-air temperature range	-40	85	°C
T _F	Functional temperature range	-40	100	°C
T _{STG}	Storage temperature range	-65	150	°C
	Lead temperature (soldering, 10 s)	-40	100	°C

(1) Stresses beyond those listed under *absolute maximum ratings* may cause permanent damage to the device. These are stress ratings only, and functional operation of the device at these or any other conditions beyond those indicated under *recommended operating conditions* is not implied. Exposure to absolute-maximum-rated conditions for extended periods may affect device reliability.

6.2 ESD Ratings

			VALUE	UNIT
V _(ESD)	Electrostatic discharge	Human body model (HBM), per ANSI/ESDA/JEDEC JS-001 ⁽¹⁾	±2000	V
		Charged device model (CDM), per JEDEC specification JESD22-C101 ⁽²⁾	±500	

(1) JEDEC document JEP155 states that 500-V HBM allows safe manufacturing with a standard ESD control process.

(2) JEDEC document JEP157 states that 250-V CDM allows safe manufacturing with a standard ESD control process.

6.3 Recommended Operating Conditions

T_A = -40°C to 85°C; Typical Values at T_A = 25°C C_{LDO25} = 1.0 µF, and V_{REGIN} = 3.6 V (unless otherwise noted)

		MIN	NOM	MAX	UNIT
V _{REGIN}	Supply Voltage	No operating restrictions	2.7	4.5	V
		No FLASH writes	2.45	2.7	V
C _{REGIN}	External input capacitor for internal LDO between REGIN and VSS	Nominal capacitor values specified. Recommend a 10% ceramic X5R type capacitor located close to the device.		0.1	µF
C _{LDO25}	External output capacitor for internal LDO between VCC and VSS	0.47	1		µF
I _{CC}	NORMAL operating-mode current	Gas Gauge in NORMAL mode, I _{LOAD} > Sleep Current		140	µA
I _{SLP}	SLEEP operating-mode current	Gas Gauge in SLEEP mode, I _{LOAD} < Sleep Current		64	µA
I _{SLP+}	FULLSLEEP operating-mode current	Gas Gauge in FULL SLEEP mode, I _{LOAD} < Sleep Current		19	µA
V _{OL}	Output voltage, low (SCL, SDA, HDQ, VEN)	I _{OL} = 3 mA		0.4	V
V _{OH(PP)}	Output voltage, high	I _{OH} = -1 mA		V _{CC} - 0.5	V
V _{OH(OD)}	Output voltage, high (SDA, SCL, HDQ, VEN)	External pull-up resistor connected to V _{CC}		V _{CC} - 0.5	V
V _{IL}	Input voltage, low	-0.3		0.6	V

6.3 Recommended Operating Conditions (continued)

$T_A = -40^\circ\text{C}$ to 85°C ; Typical Values at $T_A = 25^\circ\text{C}$ $C_{LDO25} = 1.0\ \mu\text{F}$, and $V_{\text{REGIN}} = 3.6\ \text{V}$ (unless otherwise noted)

		MIN	NOM	MAX	UNIT
$V_{\text{IH(OD)}}$	Input voltage, high (SDA, SCL, HDQ)	1.2		6	V
V_{A1}	Input voltage range (TS)	$V_{\text{SS}} - 0.05$		1	V
V_{A2}	Input voltage range (BAT)	$V_{\text{SS}} - 0.125$		5	V
V_{A3}	Input voltage range (SRP, SRN)	$V_{\text{SS}} - 0.125$		0.125	V
I_{LKG}	Input leakage current (I/O pins)			0.3	μA
t_{PUCD}	Power-up communication delay		250		ms

6.4 Thermal Information

THERMAL METRIC ⁽¹⁾		BQ34Z100			UNIT
		TSSOP (PW)			
		14 PINS			
$R_{\theta\text{JA, High K}}$	Junction-to-ambient thermal resistance	103.8			$^\circ\text{C}/\text{W}$
$R_{\theta\text{JC(top)}}$	Junction-to-case(top) thermal resistance	31.9			
$R_{\theta\text{JB}}$	Junction-to-board thermal resistance	46.6			
Ψ_{JT}	Junction-to-top characterization parameter	2.0			
Ψ_{JB}	Junction-to-board characterization parameter	45.9			
$R_{\theta\text{JC(bottom)}}$	Junction-to-case(bottom) thermal resistance	N/A			

(1) For more information about traditional and new thermal metrics, see the *Semiconductor and IC Package Thermal Metrics Application Report*, [SPRA953](#).

6.5 Electrical Characteristics: Power-On Reset

$T_A = -40^\circ\text{C}$ to 85°C ; Typical Values at $T_A = 25^\circ\text{C}$ and $V_{\text{REGIN}} = 3.6\ \text{V}$ (unless otherwise noted)

PARAMETER	TEST CONDITIONS	MIN	TYP	MAX	UNIT
$V_{\text{IT+}}$	Positive-going battery voltage input at REG25	2.05	2.20	2.31	V
V_{HYS}	Power-on reset hysteresis	45	115	185	mV

6.6 Electrical Characteristics: LDO Regulator

$T_A = 25^\circ\text{C}$, $C_{LDO25} = 1.0\ \mu\text{F}$, $V_{\text{REGIN}} = 3.6\ \text{V}$ (unless otherwise noted)⁽¹⁾

PARAMETER	TEST CONDITIONS	MIN	TYP	MAX	UNIT	
V_{REG25}	$2.7\ \text{V} \leq V_{\text{REGIN}} \leq 4.5\ \text{V}$, $I_{\text{OUT}} \leq 16\ \text{mA}$	$T_A = -40^\circ\text{C}$ to 85°C	2.3	2.5	2.7	V
	$2.45\ \text{V} \leq V_{\text{REGIN}} < 2.7\ \text{V}$ (low battery), $I_{\text{OUT}} \leq 3\ \text{mA}$	$T_A = -40^\circ\text{C}$ to 85°C	2.3			
$I_{\text{SHORT}}^{(2)}$	Short Circuit Current Limit $V_{\text{REG25}} = 0\ \text{V}$	$T_A = -40^\circ\text{C}$ to 85°C		250	mA	

(1) LDO output current, I_{OUT} , is the sum of internal and external load currents.

(2) Specified by design. Not production tested.

6.7 Electrical Characteristics: Internal Temperature Sensor Characteristics

$T_A = -40^\circ\text{C}$ to 85°C , $2.4\ \text{V} < \text{REG25} < 2.6\ \text{V}$; Typical Values at $T_A = 25^\circ\text{C}$ and $\text{REG25} = 2.5\ \text{V}$ (unless otherwise noted)

PARAMETER	TEST CONDITIONS	MIN	TYP	MAX	UNIT
G_{TEMP}	Temperature sensor voltage gain		-2		mV/ $^\circ\text{C}$

6.8 Electrical Characteristics: Low-Frequency Oscillator

$T_A = -40^\circ\text{C}$ to 85°C , $2.4\text{ V} < \text{REG25} < 2.6\text{ V}$; Typical Values at $T_A = 25^\circ\text{C}$ and $\text{REG25} = 2.5\text{ V}$ (unless otherwise noted)

PARAMETER	TEST CONDITIONS	MIN	TYP	MAX	UNIT
$f_{(\text{LOSC})}$	Operating frequency		32.768		kHz
$f_{(\text{LEIO})}$	Frequency error ^{(1) (2)}	$T_A = 0^\circ\text{C}$ to 60°C	-1.5%	0.25%	1.5%
		$T_A = -20^\circ\text{C}$ to 70°C	-2.5%	0.25%	2.5%
		$T_A = -40^\circ\text{C}$ to 85°C	-4%	0.25%	4%
$t_{(\text{LSXO})}$	Start-up time ⁽³⁾		500		μs

(1) The frequency drift is included and measured from the trimmed frequency at $V_{\text{CC}} = 2.5\text{ V}$, $T_A = 25^\circ\text{C}$.

(2) The frequency error is measured from 32.768 kHz.

(3) The startup time is defined as the time it takes for the oscillator output frequency to be $\pm 3\%$.

6.9 Electrical Characteristics: High-Frequency Oscillator

$T_A = -40^\circ\text{C}$ to 85°C , $2.4\text{ V} < \text{REG25} < 2.6\text{ V}$; Typical Values at $T_A = 25^\circ\text{C}$ and $\text{REG25} = 2.5\text{ V}$ (unless otherwise noted)

PARAMETER	TEST CONDITIONS	MIN	TYP	MAX	UNIT
$f_{(\text{OSC})}$	Operating frequency		8.389		MHz
$f_{(\text{EIO})}$	Frequency error ^{(1) (2)}	$T_A = 0^\circ\text{C}$ to 60°C	-2%	0.38%	2%
		$T_A = -20^\circ\text{C}$ to 70°C	-3%	0.38%	3%
		$T_A = -40^\circ\text{C}$ to 85°C	-4.5%	0.38%	4.5%
$t_{(\text{SXO})}$	Start-up time ⁽²⁾		2.5	5	ms

(1) The frequency error is measured from 2.097 MHz.

(2) The startup time is defined as the time it takes for the oscillator output frequency to be $\pm 3\%$.

6.10 Electrical Characteristics: Integrating ADC (Coulomb Counter) Characteristics

$T_A = -40^\circ\text{C}$ to 85°C , $2.4\text{ V} < \text{REG25} < 2.6\text{ V}$; Typical Values at $T_A = 25^\circ\text{C}$ and $\text{REG25} = 2.5\text{ V}$ (unless otherwise noted)

PARAMETER	TEST CONDITIONS	MIN	TYP	MAX	UNIT	
$V_{(\text{SR})}$	Input voltage range, $V_{(\text{SRN})}$ and $V_{(\text{SRP})}$	$V_{(\text{SR})} = V_{(\text{SRN})} - V_{(\text{SRP})}$		-0.125	0.125	V
$t_{\text{SR_CONV}}$	Conversion time	Single conversion			1	s
	Resolution	14		15	bits	
$V_{\text{OS}(\text{SR})}$	Input offset		10		μV	
I_{NL}	Integral nonlinearity error		$\pm 0.007\%$	$\pm 0.034\%$	FSR ⁽²⁾	
$Z_{\text{IN}(\text{SR})}$	Effective input resistance ⁽¹⁾	2.5			M Ω	
$I_{\text{kg}(\text{SR})}$	Input leakage current ⁽¹⁾			0.3	μA	

(1) Specified by design. Not tested in production.

(2) Full-scale reference

6.11 Electrical Characteristics: ADC (Temperature and Cell Measurement) Characteristics

$T_A = -40^\circ\text{C}$ to 85°C , $2.4\text{ V} < \text{REG25} < 2.6\text{ V}$; Typical Values at $T_A = 25^\circ\text{C}$ and $\text{REG25} = 2.5\text{ V}$ (unless otherwise noted)

PARAMETER	TEST CONDITIONS	MIN	TYP	MAX	UNIT
$V_{\text{IN}(\text{ADC})}$	Input voltage range	0.05		1	V
$t_{\text{ADC_CONV}}$	Conversion time			125	ms
	Resolution	14		15	bits
$V_{\text{OS}(\text{ADC})}$	Input offset		1		mV
Z_{ADC1}	Effective input resistance (TS) ⁽¹⁾	8			M Ω
Z_{ADC2}	Effective input resistance (BAT) ⁽¹⁾	BQ34Z100 not measuring cell voltage	8		M Ω
		BQ34Z100 measuring cell voltage		100	K Ω

6.11 Electrical Characteristics: ADC (Temperature and Cell Measurement) Characteristics (continued)

$T_A = -40^\circ\text{C}$ to 85°C , $2.4\text{ V} < \text{REG25} < 2.6\text{ V}$; Typical Values at $T_A = 25^\circ\text{C}$ and $\text{REG25} = 2.5\text{ V}$ (unless otherwise noted)

PARAMETER	TEST CONDITIONS	MIN	TYP	MAX	UNIT
$I_{\text{kg(ADC)}}$	Input leakage current ⁽¹⁾			0.3	μA

(1) Specified by design. Not tested in production.

6.12 Electrical Characteristics: Data Flash Memory Characteristics

$T_A = -40^\circ\text{C}$ to 85°C , $2.4\text{ V} < \text{REG25} < 2.6\text{ V}$; Typical Values at $T_A = 25^\circ\text{C}$ and $\text{REG25} = 2.5\text{ V}$ (unless otherwise noted)

PARAMETER	TEST CONDITIONS	MIN	TYP	MAX	UNIT
t_{DR}	Data retention ⁽¹⁾		10		Years
	Flash-programming write cycles ⁽¹⁾		20,000		Cycles
t_{WORDPROG}	Word programming time ⁽¹⁾			2	ms
I_{CCPROG}	Flash-write supply current ⁽¹⁾		5	10	mA

(1) Specified by design. Not tested in production.

6.13 Timing Requirements: HDQ Communication

$T_A = -40^\circ\text{C}$ to 85°C , $C_{\text{REG}} = 1.0\ \mu\text{F}$, $2.45\text{ V} < V_{\text{REGIN}} = V_{\text{BAT}} < 5.5\text{ V}$; typical values at $T_A = 25^\circ\text{C}$ and $V_{\text{REGIN}} = V_{\text{BAT}} = 3.6\text{ V}$ (unless otherwise noted)

PARAMETER	TEST CONDITIONS	MIN	NOM	MAX	UNIT
$t_{\text{(CYCH)}}$	Cycle time, host to BQ34Z100	190			μs
$t_{\text{(CYCD)}}$	Cycle time, BQ34Z100 to host	190	205	250	μs
$t_{\text{(HW1)}}$	Host sends 1 to BQ34Z100	0.5		50	μs
$t_{\text{(DW1)}}$	BQ34Z100 sends 1 to host	32		50	μs
$t_{\text{(HW0)}}$	Host sends 0 to BQ34Z100	86		145	μs
$t_{\text{(DW0)}}$	BQ34Z100 sends 0 to host	80		145	μs
$t_{\text{(RSPS)}}$	Response time, BQ34Z100 to host	190		950	μs
$t_{\text{(B)}}$	Break time	190			μs
$t_{\text{(BR)}}$	Break recovery time	40			μs
$t_{\text{(RISE)}}$	HDQ line rising time to logic 1 (1.2 V)			950	ns
$t_{\text{(RST)}}$	HDQ Reset	1.8		2.2	s

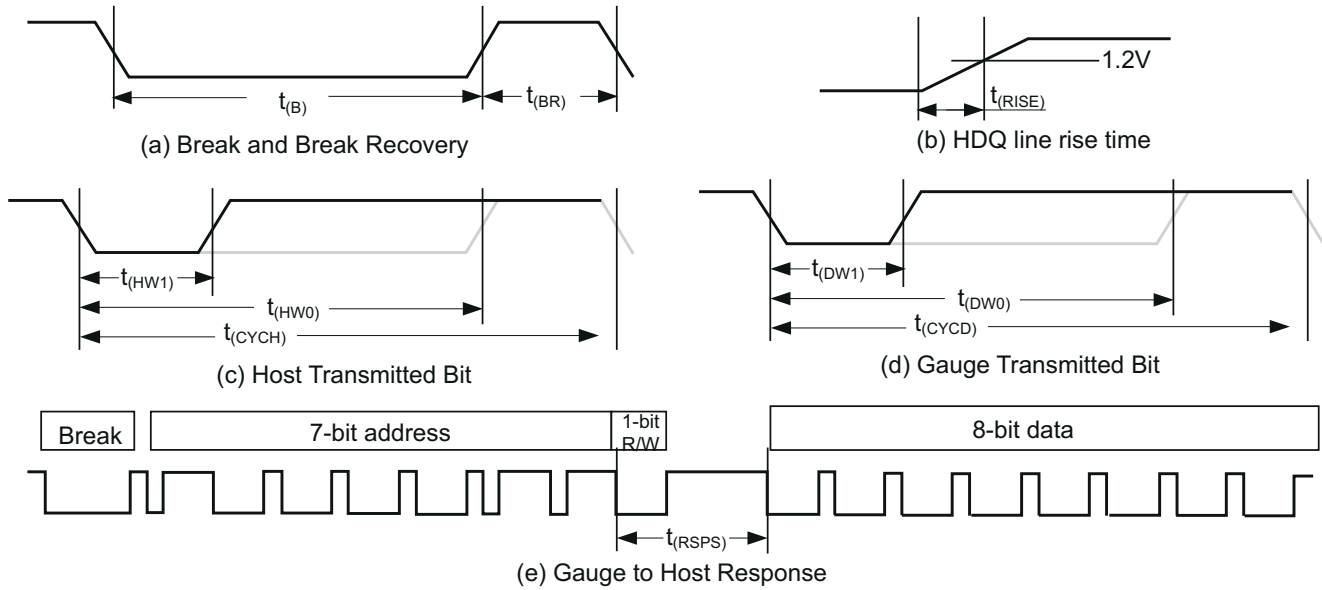

Figure 6-1. Timing Diagrams

6.14 Timing Requirements: I²C-Compatible Interface

T_A = -40°C to 85°C, C_{REG} = 0.47 µF, 2.45 V < V_{REGIN} = V_{BAT} < 5.5 V; typical values at T_A = 25°C and V_{REGIN} = V_{BAT} = 3.6 V (unless otherwise noted)

PARAMETER		TEST CONDITIONS	MIN	NOM	MAX	UNIT
t _r	SCL/SDA rise time				300	ns
t _f	SCL/SDA fall time				300	ns
t _{w(H)}	SCL pulse width (high)		600			ns
t _{w(L)}	SCL pulse width (low)		1.3			µs
t _{su(STA)}	Setup for repeated start		600			ns
t _{d(STA)}	Start to first falling edge of SCL		600			ns
t _{su(DAT)}	Data setup time		100			ns
t _{h(DAT)}	Data hold time		0			ns
t _{su(STOP)}	Setup time for stop		600			ns
t _{BUF}	Bus free time between stop and start		66			µs
f _{SCL}	Clock frequency				400	kHz

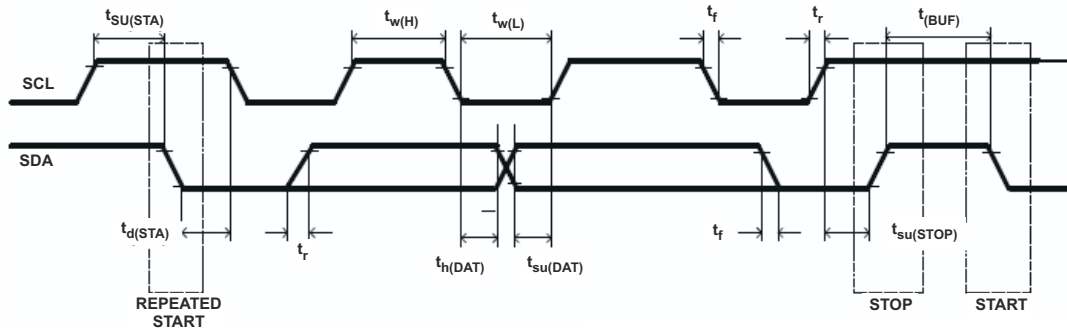
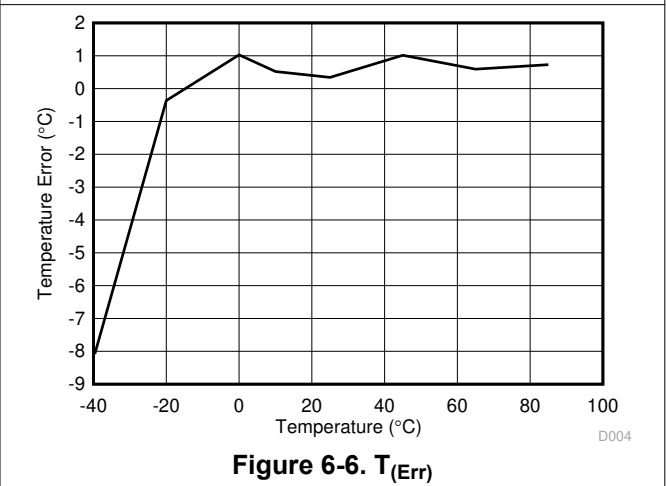
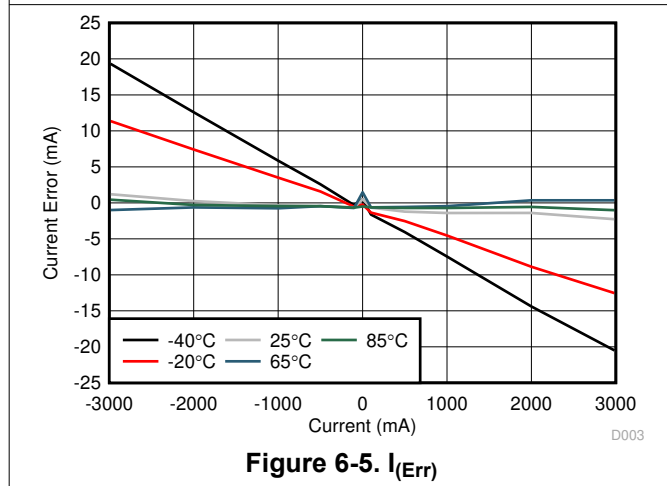
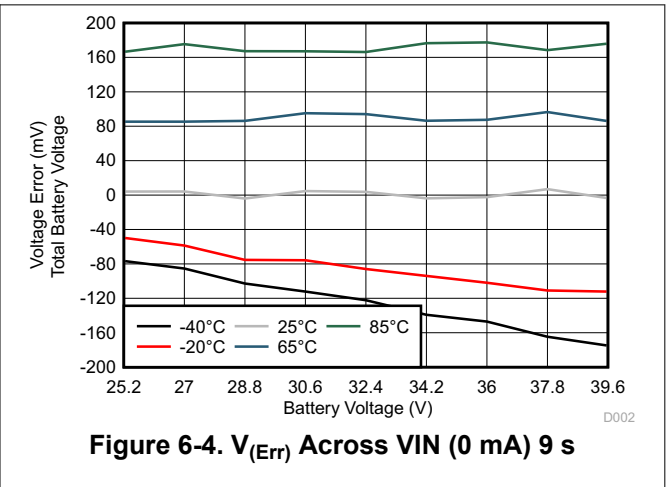
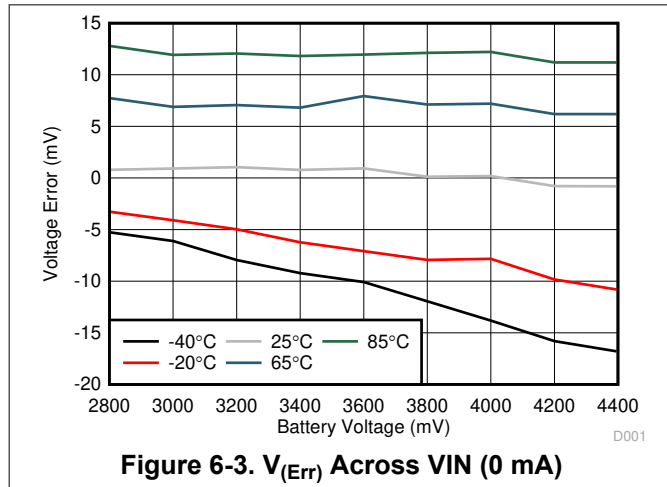

Figure 6-2. I²C-Compatible Interface Timing Diagrams

6.15 Typical Characteristics



7 Detailed Description

7.1 Overview

The BQ34Z100 device accurately predicts the battery capacity and other operational characteristics of a single cell or multiple rechargeable cell blocks, which are voltage balanced when resting. The device supports various Li-ion and LiFePO₄ chemistries, and can be interrogated by a host processor to provide cell information, such as remaining capacity, full charge capacity, and average current.

Information is accessed through a series of commands called Standard Data Commands (see [Section 7.2.1.1](#)). Further capabilities are provided by the additional Extended Data Commands set (see [Section 7.2.2](#)). Both sets of commands, indicated by the general format *Command()*, are used to read and write information contained within the BQ34Z100 device's control and status registers, as well as its data flash locations. Commands are sent from host to gauge using the BQ34Z100 serial communications engines, HDQ and I²C, and can be executed during application development, pack manufacture, or end-equipment operation.

Cell information is stored in the BQ34Z100 in non-volatile flash memory. Many of these data flash locations are accessible during application development and pack manufacture. They cannot, generally, be accessed directly during end-equipment operation. Access to these locations is achieved by using the BQ34Z100 device's companion evaluation software, through individual commands, or through a sequence of data-flash-access commands. To access a desired data flash location, the correct data flash subclass and offset must be known.

The BQ34Z100 provides 32 bytes of user-programmable data flash memory. This data space is accessed through a data flash interface. For specifics on accessing the data flash, refer to [Section 7.2.3](#).

The key to the BQ34Z100 device's high-accuracy gas gauging prediction is Texas Instrument's proprietary Impedance Track algorithm. This algorithm uses voltage measurements, characteristics, and properties to create state-of-charge predictions that can achieve accuracy with as little as 1% error across a wide variety of operating conditions.

The BQ34Z100 measures charge/discharge activity by monitoring the voltage across a small-value series sense resistor connected in the low side of the battery circuit. When an application's load is applied, cell impedance is measured by comparing its Open Circuit Voltage (OCV) with its measured voltage under loading conditions.

The BQ34Z100 can use an NTC thermistor (default is Semitec 103AT or Mitsubishi BN35-3H103FB-50) for temperature measurement, or can also be configured to use its internal temperature sensor. The BQ34Z100 uses temperature to monitor the battery-pack environment, which is used for fuel gauging and cell protection functionality.

To minimize power consumption, the BQ34Z100 has three power modes: NORMAL, SLEEP, and FULL SLEEP. The BQ34Z100 passes automatically between these modes, depending upon the occurrence of specific events.

Multiple modes are available for configuring from one to 16 LEDs as an indicator of remaining state of charge. More than four LEDs require the use of one or two inexpensive SN74HC164 shift register expanders.

A SHA-1/HMAC-based battery pack authentication feature is also implemented on the BQ34Z100. When the IC is in UNSEALED mode, authentication keys can be (re)assigned. A scratch pad area is used to receive challenge information from a host and to export SHA-1/HMAC encrypted responses. See [Section 7.2.14.1](#) for further details.

Note

Formatting conventions in this document:

Commands: italics with parentheses and no breaking spaces; for example, *RemainingCapacity()*.

Data Flash: *italics*, **bold**, and breaking spaces; for example, ***Design Capacity***.

Register Bits and Flags: brackets only; for example, [TDA] Data

Flash Bits: *italic* and **bold**; for example, **[LED1]**

Modes and states: ALL CAPITALS; for example, UNSEALED mode.

7.2 Feature Description

7.2.1 Data Commands

7.2.1.1 Standard Data Commands

The BQ34Z100 uses a series of 2-byte standard commands to enable host reading and writing of battery information. Each standard command has an associated command-code pair, as indicated in [Table 7-1](#). Because each command consists of two bytes of data, two consecutive HDQ/I²C transmissions must be executed to initiate the command function and to read or write the corresponding two bytes of data. Standard commands are accessible in NORMAL operation. Also, two block commands are available to read Manufacturer Name and Device Chemistry. Read/Write permissions depend on the active access mode.

Table 7-1. Commands

NAME		COMMAND CODE	UNIT	SEALED ACCESS	UNSEALED ACCESS
<i>Control()</i>	CNTL	0x00/0x01	N/A	R/W	R/W
<i>StateOfCharge()</i>	SOC	0x02/0x03	%	R	R
<i>RemainingCapacity()</i>	RM	0x04/0x05	mAh	R	R
<i>FullChargeCapacity()</i>	FCC	0x06/0x07	mAh	R	R
<i>Voltage()</i>	VOLT	0x08/0x09	mV	R	R
<i>AverageCurrent()</i>	AI	0x0A/0x0B	mA	R	R
<i>Temperature()</i>	TEMP	0x0C/0x0D	0.1 K	R	R
<i>Flags()</i>	FLAGS	0x0E/0x0F	N/A	R	R
<i>Mfr Date</i>	DATE	0x6B/0x6C	N/A	R	R
<i>Mfr Name Length</i>	NAMEL	0x6D	N/A	R	R
<i>Mfr Name</i>	NAME	0x6E – 0x78	N/A	R	R
<i>Device Chemistry Length</i>	CHEML	0x79	N/A	R	R
<i>Device Chemistry</i>	CHEM	0x7A – 0x7D	N/A	R	R
<i>Serial Number</i>	SERNUM	0x7E/0x7F	N/A	R	R

7.2.1.2 Control(): 0x00/0x01

Issuing a *Control()* command requires a subsequent two-byte subcommand. These additional bytes specify the particular control function desired. The *Control()* command allows the host to control specific features of the BQ34Z100 during normal operation, and additional features when the BQ34Z100 is in different access modes, as described in [Table 7-2](#).

Table 7-2. Control() Subcommands

CNTL FUNCTION	CNTL DATA	SEALED ACCESS	DESCRIPTION
CONTROL_STATUS	0x0000	Yes	Reports the status of DF Checksum, IT, for example.
DEVICE_TYPE	0x0001	Yes	Reports the device type of 0x0541 (indicating BQ34Z100)
FW_VERSION	0x0002	Yes	Reports the firmware version on the device type

Table 7-2. Control() Subcommands (continued)

CNTL FUNCTION	CNTL DATA	SEALED ACCESS	DESCRIPTION
HW_VERSION	0x0003	Yes	Reports the hardware version of the device type
RESET_DATA	0x0005	No	Returns reset data
PREV_MACWRITE	0x0007	No	Returns previous MAC command code
CHEM_ID	0x0008	Yes	Reports the chemical identifier of the Impedance Track configuration
BOARD_OFFSET	0x0009	No	Forces the device to measure and store the board offset
CC_OFFSET	0x000A	No	Forces the device to measure the internal CC offset
CC_OFFSET_SAVE	0x000B	No	Forces the device to store the internal CC offset
DF_VERSION	0x000C	Yes	Reports the data flash version on the device
SET_FULLSLEEP	0x0010	No	Set the [FULLSLEEP] bit in the control register to 1
STATIC_CHEM_CHKSUM	0x0017	Yes	Calculates chemistry checksum
CURRENT	0x0018	Yes	Returns the instantaneous current measured by the gauge
SEALED	0x0020	No	Places the device in SEALED access mode
IT_ENABLE	0x0021	No	Enables the Impedance Track algorithm
CAL_ENABLE	0x002D	No	Toggle CALIBRATION mode
RESET	0x0041	No	Forces a full reset of the BQ34Z100
EXIT_CAL	0x0080	No	Exit CALIBRATION mode
ENTER_CAL	0x0081	No	Enter CALIBRATION mode
OFFSET_CAL	0x0082	No	Reports internal CC offset in CALIBRATION mode

7.2.1.2.1 CONTROL_STATUS: 0x0000

Instructs the fuel gauge to return status information to Control addresses 0x00/0x01. The status word includes the following information.

Table 7-3. CONTROL_STATUS Flags

	Bit 7	Bit 6	Bit 5	Bit 4	Bit 3	Bit 2	Bit 1	Bit 0
High Byte	—	FAS	SS	CALMODE	CCA	BCA	CSV	—
Low Byte	—	—	FULLSLEEP	SLEEP	LDMD	RUP_DIS	VOK	QEN

Legend: **RSVD** = Reserved

FAS: Status bit that indicates the BQ34Z100 is in FULL ACCESS SEALED state. Active when set.

SS: Status bit that indicates the BQ34Z100 is in the SEALED state. Active when set.

CALMODE: Status bit that indicates the BQ34Z100 calibration function is active. True when set. Default is 0.

CCA: Status bit that indicates the BQ34Z100 Coulomb Counter Calibration routine is active. Active when set.

BCA: Status bit that indicates the BQ34Z100 Board Calibration routine is active. Active when set.

CSV: Status bit that indicates a valid data flash checksum has been generated. Active when set.

FULLSLEEP: Status bit that indicates the BQ34Z100 is in FULL SLEEP mode. True when set. The state can only be detected by monitoring the power used by the BQ34Z100 because any communication will automatically clear it.

SLEEP: Status bit that indicates the BQ34Z100 is in SLEEP mode. True when set.

LDMD: Status bit that indicates the BQ34Z100 Impedance Track algorithm using constant-power mode. True when set. Default is 0 (CONSTANT CURRENT mode).

RUP_DIS: Status bit that indicates the BQ34Z100 Ra table updates are disabled. True when set.

VOK: Status bit that indicates cell voltages are OK for Qmax updates. True when set.

QEN: Status bit that indicates the BQ34Z100 Qmax updates are enabled. True when set.

7.2.1.2.2 DEVICE TYPE: 0x0001

Instructs the fuel gauge to return the device type to addresses 0x00/0x01.

7.2.1.2.3 FW_VERSION: 0x0002

Instructs the fuel gauge to return the firmware version to addresses 0x00/0x01.

7.2.1.2.4 HW_VERSION: 0x0003

Instructs the fuel gauge to return the hardware version to addresses 0x00/0x01.

7.2.1.2.5 RESET_DATA: 0x0005

Instructs the fuel gauge to return the number of resets performed to addresses 0x00/0x01.

7.2.1.2.6 PREV_MACWRITE: 0x0007

Instructs the fuel gauge to return the previous command written to addresses 0x00/0x01. The value returned is limited to less than 0x0020.

7.2.1.2.7 CHEM ID: 0x0008

Instructs the fuel gauge to return the chemical identifier for the Impedance Track configuration to addresses 0x00/0x01.

7.2.1.2.8 BOARD_OFFSET: 0x0009

Instructs the fuel gauge to calibrate board offset. During board offset calibration the [BCA] bit is set.

7.2.1.2.9 CC_OFFSET: 0x000A

Instructs the fuel gauge to calibrate the coulomb counter offset. During calibration the [CCA] bit is set.

7.2.1.2.10 CC_OFFSET_SAVE: 0x000B

Instructs the fuel gauge to save the coulomb counter offset after calibration.

7.2.1.2.11 DF_VERSION: 0x000C

Instructs the fuel gauge to return the data flash version to addresses 0x00/0x01.

7.2.1.2.12 SET_FULLSLEEP: 0x0010

Instructs the fuel gauge to set the FULLSLEEP bit in the Control Status register to 1. This allows the gauge to enter the FULL SLEEP power mode after the transition to SLEEP power state is detected. In FULL SLEEP mode, less power is consumed by disabling an oscillator circuit used by the communication engines. For HDQ communication, one host message will be dropped. For I²C communications, the first I²C message will incur a 6-ms–8-ms clock stretch while the oscillator is started and stabilized. A communication to the device in FULL SLEEP will force the part back to the SLEEP mode.

7.2.1.2.13 STATIC_CHEM_DF_CHKSUM: 0x0017

Instructs the fuel gauge to calculate chemistry checksum as a 16-bit unsigned integer sum of all static chemistry data. The most significant bit (MSB) of the checksum is masked yielding a 15-bit checksum. This checksum is compared with the value stored in the data flash Static Chem DF Checksum. If the value matches, the MSB will be cleared to indicate a pass. If it does not match, the MSB will be set to indicate a failure.

7.2.1.2.14 SEALED: 0x0020

Instructs the fuel gauge to transition from UNSEALED state to SEALED state. The fuel gauge should always be set to SEALED state for use in customer's end equipment.

7.2.1.2.15 IT_ENABLE: 0x0021

Forces the fuel gauge to begin the Impedance Track algorithm, sets Bit 2 of **UpdateStatus** and causes the [VOK] and [QEN] flags to be set in the CONTROL STATUS register. [VOK] is cleared if the voltages are not suitable for a Qmax update. Once set, [QEN] cannot be cleared. This command is only available when the fuel gauge is UNSEALED and is typically enabled at the last step of production after the system test is completed.

7.2.1.2.16 RESET: 0x0041

Instructs the fuel gauge to perform a full reset. This command is only available when the fuel gauge is UNSEALED.

7.2.1.2.17 EXIT_CAL: 0x0080

Instructs the fuel gauge to exit CALIBRATION mode.

7.2.1.2.18 ENTER_CAL: 0x0081

Instructs the fuel gauge to enter CALIBRATION mode.

7.2.1.2.19 OFFSET_CAL: 0x0082

Instructs the fuel gauge to perform offset calibration.

7.2.1.3 StateOfCharge(): 0x02/0x03

This read-only function returns an unsigned integer value of the predicted remaining battery capacity expressed as a percentage of *FullChargeCapacity()* with a range of 0 to 100%.

7.2.1.4 RemainingCapacity(): 0x04/0x05

This read-only command pair returns the compensated battery capacity remaining. Unit is 1 mAh per bit.

7.2.1.5 FullChargeCapacity(): 0x06/07

This read-only command pair returns the compensated capacity of the battery when fully charged. Unit is 1 mAh per bit except if X10 mode is selected. In X10 mode, units are 10 mAh per bit. with units of 1 mAh per bit. *FullChargeCapacity()* is updated at regular intervals, as specified by the Impedance Track algorithm.

7.2.1.6 Voltage(): 0x08/0x09

This read-word function returns an unsigned integer value of the measured cell-pack voltage in mV with a range of 0 V to 65535 mV.

7.2.1.7 AverageCurrent(): 0x0A/0x0B

This read-only command pair returns a signed integer value that is the average current flowing through the sense resistor. It is updated every 1 second. Unit is 1 mA per bit except if X10 mode is selected. In X10 mode, units are 10 mA per bit. with units of 1 mA per bit.

7.2.1.8 Temperature(): 0x0C/0x0D

This read-word function returns an unsigned integer value of the temperature, in units of 0.1 K, measured by the gas gauge and has a range of 0 to 6553.5 K. The source of the measured temperature is configured by the [TEMPS] bit in the **Pack Configuration** register (see [Section 7.2.2](#)).

Table 7-4. Temperature Sensor Selection

TEMPS	TEMPERATURE() SOURCE
0	Internal Temperature Sensor
1	TS Input (default)

7.2.1.9 Flags(): 0x0E/0x0F

This read-word function returns the contents of the Gas Gauge Status register, depicting current operation status.

Table 7-5. Flags Bit Definitions

	Bit 7	Bit 6	Bit 5	Bit 4	Bit 3	Bit 2	Bit 1	Bit 0
High Byte	OTC	OTD	BATHI	BATLOW	CHG_INH	RSVD	FC	CHG
Low Byte	OCVTAKEN	ISD	TDD	RSVD	RSVD	SOC1	SOCF	DSG

Legend: **RSVD** = Reserved

OTC: Overtemperature in Charge condition is detected. True when set

OTD: Overtemperature in Discharge condition is detected. True when set

- BATHI:** Battery High bit that indicates a high battery voltage condition. Refer to the data flash **BATTERY HIGH** parameters for threshold settings.
- BATLOW:** Battery Low bit that indicates a low battery voltage condition. Refer to the data flash **BATTERY LOW** parameters for threshold settings.
- CHG_INH:** Charge Inhibit: unable to begin charging. Refer to the data flash [**Charge Inhibit Temp Low, Charge Inhibit Temp High**]. True when set
- XCHG:** Charging not allowed
- RSVD:** Reserved
 - FC:** Full charge is detected. FC is set when charge termination is reached and **FC Set%** = -1 (see [Section 7.2.10](#) for details) or **StateOfCharge()** is larger than **FC Set%** and **FC Set%** is not -1. True when set
 - CHG:** (Fast) charging allowed. True when set
- OCVTAKEN:** Cleared on entry to RELAX mode and set to 1 when OCV measurement is performed in RELAX mode.
 - ISD:** Internal Short is detected. True when set. TDD = Tab Disconnect is detected. True when set
 - SOC1:** State-of-Charge Threshold 1 reached. True when set
 - SOCF:** State-of-Charge Threshold Final reached. True when set
 - DSG:** Discharging detected. True when set

7.2.2 Extended Data Commands

Extended commands offer additional functionality beyond the standard set of commands. They are used in the same manner; however, unlike standard commands, extended commands are not limited to 2-byte words. The number of command bytes for a given extended command ranges in size from single to multiple bytes, as specified in [Table 7-6](#). For details on the SEALED and UNSEALED states, refer to [Section 7.2.3.3](#).

Table 7-6. Extended Commands

NAME		COMMAND CODE	UNIT	SEALED ACCESS ^{(1) (2)}	UNSEALED ACCESS ^{(1) (2)}
<i>AtRate()</i>	AR	0X10/0x11	mA	R/W	R/W
<i>Current()</i>	I	0X10/0x11	mA	R	R
<i>AtRateTimeToEmpty()</i>	ARTTE	0x12/0x13	Minutes	R	R
<i>NominalAvailableCapacity()</i>	NAC	0x14/0x15	mAh	R	R
<i>FullAvailableCapacity()</i>	FAC	0x16/0x17	mAh	R	R
<i>TimeToEmpty()</i>	TTE	0x18/0x19	Minutes	R	R
<i>TimeToFull()</i>	TTF	0x1A/0x1B	Minutes	R	R
<i>StandbyCurrent()</i>	SI	0x1C/0x1D	mA	R	R
<i>StandbyTimeToEmpty()</i>	STTE	0x1E/0x1F	Minutes	R	R
<i>MaxLoadCurrent()</i>	MLI	0x20/0x21	mA	R	R
<i>MaxLoadTimeToEmpty()</i>	MLTTE	0x22/0x23	Minutes	R	R
<i>AvailableEnergy()</i>	AE	0x24/0x25	10 mW/h	R	R
<i>AveragePower()</i>	AP	0x26/0x27	10 mW	R	R
<i>TTEatConstantPower()</i>	TTECP	0x28/0x29	Minutes	R	R
<i>Internal_Temp()</i>	INTTEMP	0x2A/0x2B	0.1 K	R	R
<i>CycleCount()</i>	CC	0x2C/0x2D	Counts	R	R
<i>StateOfHealth()</i>	SOH	0x2E/0x2F	%	R	R
<i>ChargeVoltage()</i>	CHGV	0x30/0x31	mV	R	R
<i>ChargeCurrent()</i>	CHGI	0x32/0x33	mA	R	R
<i>PassedCharge()</i>	PCHG	0x34/0x35	mAh	R	R
<i>DOD0()</i>	DOD0	0x36/0x37	HEX#	R	R
<i>SelfDischargeCurrent</i>	SDSG	0x38/0x39	mA	R	R
<i>PackConfiguration()</i>	PKCFG	0x3A/0x3B	N/A	R	R
<i>DesignCapacity()</i>	DCAP	0x3C/0x3D	mAh	R	R

Table 7-6. Extended Commands (continued)

NAME	COMMAND CODE	UNIT	SEALED ACCESS ^{(1) (2)}	UNSEALED ACCESS ^{(1) (2)}
<i>DataFlashClass()</i> (2)	DFCLS	0x3E	N/A	R/W
<i>DataFlashBlock()</i> (2)	DFBLK	0x3F	N/A	R/W
<i>Authenticate()/BlockData()</i>	A/DF	0x40...0x53	N/A	R/W
<i>AuthenticateChecksum()/BlockData()</i>	ACKS/DFD	0x54	N/A	R/W
<i>BlockData()</i>	DFD	0x55...0x5F	N/A	R
<i>BlockDataChecksum()</i>	DFDCKS	0x60	N/A	R/W
<i>BlockDataControl()</i>	DFDCNTL	0x61	N/A	R/W
<i>DeviceNameLength()</i>	DNAMELEN	0x62	N/A	R
<i>DeviceName()</i>	DNAME	0x63...0x69	N/A	R
Reserved	RSVD	0x6A...0x7F	N/A	R

(1) SEALED and UNSEALED states are entered via commands to CNTL 0x00/0x01.

(2) In SEALED mode, data flash *cannot* be accessed through commands 0x3E and 0x3F.

7.2.2.1 *AtRate()*: 0X10/0x11

The *AtRate()* read-/write-word function is the first half of a two-function call-set used to set the *AtRate* value used in calculations made by the *AtRateTimeToEmpty()* function. The *AtRate()* units are in mA.

The *AtRate()* value is a signed integer and both positive and negative values will be interpreted as a discharge current value. The *AtRateTimeToEmpty()* function returns the predicted operating time at the *AtRate* value of discharge. The default value for *AtRate()* is zero and will force *AtRate()* to return 65535.

7.2.2.2 *AtRateTimeToEmpty()*: 0x12/0x13

This read-word function returns an unsigned integer value of the predicted remaining operating time if the battery is discharged at the *AtRate()* value in minutes with a range of 0 to 65534. A value of 65535 indicates *AtRate()* = 0.

The gas gauge updates *AtRateTimeToEmpty()* within 1s after the host sets the *AtRate()* value. The gas gauge automatically updates *AtRateTimeToEmpty()* based on the *AtRate()* value every 1 s.

7.2.2.3 *Current()*: 0x10/0x11

This read-only command pair returns a signed integer value that is the current flow through the sense resistor. It is updated every 1 second. Units are 1 mA per bit except if X10 mode is selected. In X10 mode, units are 10 mA per bit with units of 1mA. However, if **PackConfiguration [SCALED]** is set then the units have been scaled through the calibration process. The actual scale is not set in the device and **SCALED** is just an indicator flag.

7.2.2.4 *NominalAvailableCapacity()*: 0x14/0x15

This read-only command pair returns the uncompensated (no or light load) battery capacity remaining. Unit is 1 mAh per bit.

7.2.2.5 *FullAvailableCapacity()*: 0x16/0x17

This read-only command pair returns the uncompensated (no or light load) capacity of the battery when fully charged. Unit is 1 mAh per bit. *FullAvailableCapacity()* is updated at regular intervals, as specified by the Impedance Track algorithm.

7.2.2.6 *TimeToEmpty()*: 0x18/0x19

This read-only function returns an unsigned integer value of the predicted remaining battery life at the present rate of discharge, in minutes. A value of 65535 indicates that the battery is not being discharged.

7.2.2.7 *TimeToFull()*: 0x1A/0x1B

This read-only function returns an unsigned integer value of predicted remaining time until the battery reaches full charge, in minutes, based upon *AverageCurrent()*. The computation should account for the taper current time

extension from the linear TTF computation based on a fixed *AverageCurrent()* rate of charge accumulation. A value of 65535 indicates the battery is not being charged.

7.2.2.8 StandbyCurrent(): 0x1C/0x1D

This read-only function returns a signed integer value of the measured standby current through the sense resistor. The *StandbyCurrent()* is an adaptive measurement. Initially, it reports the standby current programmed in Initial Standby, and after spending some time in standby, reports the measured standby current.

The register value is updated every 1 second when the measured current is above the Deadband (3 mA default) and is less than or equal to 2 x Initial Standby. The first and last values that meet this criterion should not be averaged in, since they may not be stable values. To approximate a 1 minute time constant, each new *StandbyCurrent()* value is computed as follows:

$$\text{StandbyCurrent()}_{NEW} = (239/256) \times \text{StandbyCurrent()}_{OLD} + (17/256) \times \text{AverageCurrent()}$$

7.2.2.9 StandbyTimeToEmpty(): 0x1E/0x1F

This read-only function returns an unsigned integer value of the predicted remaining battery life at the standby rate of discharge, in minutes. The computation should use Nominal Available Capacity (NAC), the uncompensated remaining capacity, for this computation. A value of 65535 indicates battery is not being discharged.

7.2.2.10 MaxLoadCurrent(): 0x20/0x21

This read-only function returns a signed integer value, in units of mA, of the maximum load conditions. The *MaxLoadCurrent()* is an adaptive measurement which is initially it reports the maximum load current programmed in Initial Max Load Current. If the measured current is ever greater than Initial Max Load Current, then *MaxLoadCurrent()* updates to the new current. *MaxLoadCurrent()* is reduced to the average of the previous value and Initial Max Load Current whenever the battery is charged to full after a previous discharge to an SOC less than 50%. This prevents the reported value from maintaining an unusually high value.

7.2.2.11 MaxLoadTimeToEmpty(): 0x22/0x23

This read-only function returns an unsigned integer value of the predicted remaining battery life at the maximum load current discharge rate, in minutes. A value of 65535 indicates that the battery is not being discharged.

7.2.2.12 AvailableEnergy(): 0x24/0x25

This read-only function returns an unsigned integer value of the predicted charge or energy remaining in the battery. The value is reported in units of mWh.

7.2.2.13 AveragePower(): 0x26/0x27

This read-word function returns an unsigned integer value of the average power of the current discharge. A value of 0 indicates that the battery is not being discharged. The value is reported in units of mW.

7.2.2.14 TimeToEmptyAtConstantPower(): 0x28/0x29

This read-only function returns an unsigned integer value of the predicted remaining operating time if the battery is discharged at the *AveragePower()* value in minutes. A value of 65535 indicates *AveragePower()* = 0. The gas gauge automatically updates *TimeToEmptyatContantPower()* based on the *AveragePower()* value every 1s.

7.2.2.15 InternalTemp(): 0x2A/0x2B

This read-only function returns an unsigned integer value of the measured internal temperature of the device, in units of 0.1 K, measured by the fuel gauge.

7.2.2.16 CycleCount(): 0x2C/0x2D

This read-only function returns an unsigned integer value of the number of cycles the battery has experienced with a range of 0 to 65535. One cycle occurs when accumulated discharge \geq *CC Threshold*.

7.2.2.17 StateOfHealth(): 0x2E/0x2F

This read-only function returns an unsigned integer value, expressed as a percentage of the ratio of predicted FCC (25°C, SOH current rate) over the *DesignCapacity()*. The FCC (25°C, SOH current rate) is the calculated full charge capacity at 25°C and the SOH current rate that is specified in the data flash (State of Health Load). The range of the returned SOH percentage is 0x00 to 0x64, indicating 0% to 100%, correspondingly.

7.2.2.18 ChargeVoltage(): 0x30/0x31

This unsigned integer indicates the recommended charging voltage.

7.2.2.19 ChargeCurrent(): 0x32/0x33

This signed integer indicates the recommended charging current.

7.2.2.20 PassedCharge(): 0x34/0x35

This signed integer indicates the amount of charge passed through the sense resistor since the last IT simulation in mAh.

7.2.2.21 DOD0(): 0x36/0x37

This unsigned integer indicates the depth of discharge during the most recent OCV reading.

7.2.2.22 SelfDischargeCurrent(): 0x38/0x39

This read-only command pair returns a signed integer value that estimates the battery self discharge current.

7.2.2.23 PackConfiguration(): 0x3A/0x3B

This read-word function allows the host to read the configuration of selected features of the device pertaining to various features. Refer to [Section 7.2.6.15](#).

7.2.2.24 DesignCapacity(): 0x3C/0x3D

SEALED and UNSEALED Access: This command returns theoretical or nominal capacity of a new pack. The value is stored in **Design Capacity** and is expressed in mAh.

7.2.2.25 DataFlashClass(): 0x3E

UNSEALED Access: This command sets the data flash class to be accessed. The class to be accessed should be entered in hexadecimal.

SEALED Access: This command is not available in SEALED mode.

7.2.2.26 DataFlashBlock(): 0x3F

UNSEALED Access: If **BlockDataControl** has been set to 0x00, this command directs which data flash block will be accessed by the *BlockData()* command. Writing a 0x00 to *DataFlashBlock()* specifies the *BlockData()* command will transfer authentication data. Issuing a 0x01 instructs the *BlockData()* command to transfer **Manufacturer Data**.

SEALED Access: This command directs which data flash block will be accessed by the *BlockData()* command. Writing a 0x00 to *DataFlashBlock()* specifies that the *BlockData()* command will transfer authentication data. Issuing a 0x01 instructs the *BlockData()* command to transfer **Manufacturer Data**.

7.2.2.27 AuthenticateData/BlockData(): 0x40...0x53

UNSEALED Access: This data block has a dual function: It is used for the authentication challenge and response and is part of the 32-byte data block when accessing data flash.

SEALED Access: This data block has a dual function: It is used for authentication challenge and response, and is part of the 32-byte data block when accessing the **Manufacturer Data**.

7.2.2.28 AuthenticateChecksum/BlockData(): 0x54

UNSEALED Access: This byte holds the authentication checksum when writing the authentication challenge to the device, and is part of the 32-byte data block when accessing data flash.

SEALED Access: This byte holds the authentication checksum when writing the authentication challenge to the device, and is part of the 32-byte data block when accessing **Manufacturer Data**.

7.2.2.29 *BlockData()*: 0x55...0x5F

UNSEALED Access: This data block is the remainder of the 32-byte data block when accessing data flash.

SEALED Access: This data block is the remainder of the 32-byte data block when accessing **Manufacturer Data**.

7.2.2.30 *BlockDataChecksum()*: 0x60

UNSEALED Access: This byte contains the checksum on the 32 bytes of block data read or written to data flash.

SEALED Access: This byte contains the checksum for the 32 bytes of block data written to **Manufacturer Data**.

7.2.2.31 *BlockDataControl()*: 0x61

UNSEALED Access: This command is used to control data flash ACCESS mode. Writing 0x00 to this command enables *BlockData()* to access general data flash. Writing a 0x01 to this command enables the SEALED mode operation of *DataFlashBlock()*.

7.2.2.32 *DeviceNameLength()*: 0x62

UNSEALED and SEALED Access: This byte contains the length of the **Device Name**.

7.2.2.33 *DeviceName()*: 0x63...0x6A

UNSEALED and SEALED Access: This block contains the device name that is programmed in **Device Name**.

7.2.3 Data Flash Interface

7.2.3.1 Accessing Data Flash

The BQ34Z100 data flash is a non-volatile memory that contains BQ34Z100 initialization, default, cell status, calibration, configuration, and user information. The data flash can be accessed in several different ways, depending on in what mode the BQ34Z100 is operating and what data is being accessed.

Commonly accessed data flash memory locations, frequently read by a host, are conveniently accessed through specific instructions described in [Section 7.2.1](#). These commands are available when the BQ34Z100 is either in UNSEALED or SEALED modes.

Most data flash locations, however, can only be accessible in UNSEALED mode by use of the BQ34Z100 evaluation software or by data flash block transfers. These locations should be optimized and/or fixed during the development and manufacture processes. They become part of a Golden Image File and can then be written to multiple battery packs. Once established, the values generally remain unchanged during end-equipment operation.

To access data flash locations individually, the block containing the desired data flash location(s) must be transferred to the command register locations where they can be read to the host or changed directly. This is accomplished by sending the set-up command *BlockDataControl()* (code 0x61) with data 0x00. Up to 32 bytes of data can be read directly from the *BlockData()* command locations 0x40...0x5F, externally altered, then re-written to the *BlockData()* command space. Alternatively, specific locations can be read, altered, and re-written if their corresponding offsets are used to index into the *BlockData()* command space. Finally, the data residing in the command space is transferred to data flash, once the correct checksum for the whole block is written to *BlockDataChecksum()* (command number 0x60).

Occasionally, a data flash CLASS will be larger than the 32-byte block size. In this case, the *DataFlashBlock()* command is used to designate which 32-byte block in which the desired locations reside. The correct command address is then given by $0x40 + \text{offset modulo } 32$. For example, to access **Terminate Voltage** in the Gas Gauging class, *DataFlashClass()* is issued 80 (0x50) to set the class. Because the offset is 48, it must reside in the second 32-byte block. Hence, *DataFlashBlock()* is issued 0x01 to set the block offset, and the offset used to index into the *BlockData()* memory area is $0x40 + 48 \text{ modulo } 32 = 0x40 + 16 = 0x40 + 0x10 = 0x50$. For example to modify **[VOLTSEL]** in **Pack Configuration** from 0 to 1 to enable the external voltage measurement option.

Reading and writing subclass data are block operations 32 bytes in length. Data can be written in shorter block sizes, however. Blocks can be shorter than 32 bytes in length. Writing these blocks back to data flash will not overwrite data that extend beyond the actual block length.

Note

None of the data written to memory is bounded by the BQ34Z100: The values are not rejected by the gas gauge. Writing an incorrect value may result in hardware failure due to firmware program interpretation of the invalid data. The data written is persistent, so a power-on reset resolves the fault.

7.2.3.2 Manufacturer Information Block

The BQ34Z100 contains 32 bytes of user-programmable data flash storage: **Manufacturer Info Block**. The method for accessing these memory locations is slightly different, depending on if the device is in UNSEALED or SEALED modes.

When in UNSEALED mode and when an “0x00” has been written to *BlockDataControl()*, accessing the Manufacturer Info Block is identical to accessing general data flash locations. First, a *DataFlashClass()* command is used to set the subclass, then a *DataFlashBlock()* command sets the offset for the first data flash address within the subclass. The *BlockData()* command codes contain the referenced data flash data. When writing the data flash, a checksum is expected to be received by *BlockDataChecksum()*. Only when the checksum is received and verified is the data actually written to data flash.

As an example, the data flash location for **Manufacturer Info Block** is defined as having a Subclass = 58 and an Offset = 0 through 31 (32 byte block). The specification of Class = System Data is not needed to address **Manufacturer Info Block**, but is used instead for grouping purposes when viewing data flash info in the BQ34Z100 evaluation software.

When in SEALED mode or when “0x01” *BlockDataControl()* does not contain “0x00”, data flash is no longer available in the manner used in UNSEALED mode. Rather than issuing subclass information, a designated **Manufacturer Information Block** is selected with the *DataFlashBlock()* command. Issuing a 0x01, 0x02, or 0x03 with this command causes the corresponding information block (A, B, or C, respectively) to be transferred to the command space 0x40...0x5F for editing or reading by the host. Upon successful writing of checksum information to *BlockDataChecksum()*, the modified block is returned to data flash.

Note

Manufacturer Info Block A is “read only” when in SEALED mode.

7.2.3.3 Access Modes

The BQ34Z100 provides three security modes that control data flash access permissions according to [Table 7-7](#). Public Access refers to those data flash locations specified in [Table 7-8](#) that are accessible to the user. Private Access refers to reserved data flash locations used by the BQ34Z100 system. Care should be taken to avoid writing to Private data flash locations when performing block writes in FULL ACCESS mode by following the procedure outlined in [Section 7.2.3.1](#).

Table 7-7. Data Flash Access

SECURITY MODE	DF—PUBLIC ACCESS	DF—PRIVATE ACCESS
BOOTROM	N/A	N/A
FULL ACCESS	R/W	R/W
UNSEALED	R/W	R/W
SEALED	R	N/A

Although FULL ACCESS and UNSEALED modes appear identical, FULL ACCESS mode allows the BQ34Z100 to directly transition to BOOTROM mode and also write access keys. UNSEALED mode does not have these abilities.

7.2.3.4 Sealing/Unsealing Data Flash Access

The BQ34Z100 implements a key-access scheme to transition between SEALED, UNSEALED, and FULL ACCESS modes. Each transition requires that a unique set of two keys be sent to the BQ34Z100 via the *Control()* command (these keys are unrelated to the keys used for SHA-1/HMAC authentication). The keys must be sent consecutively, with no other data being written to the *Control()* register in between. Note that to avoid conflict, the keys must be different from the codes presented in the CNTL DATA column of [Table 7-2](#) subcommands.

When in SEALED mode, the [SS] bit of *Control Status()* is set, but when the UNSEAL keys are correctly received by the BQ34Z100, the [SS] bit is cleared. When the full access keys are correctly received, then the *Flags()* [FAS] bit is cleared.

Both sets of keys for each level are 2 bytes each in length and are stored in data flash. The UNSEAL key (stored at **Unseal Key 0** and **Unseal Key 1**) and the FULL ACCESS key (stored at **Full Access Key 0** and **Full Access Key 1**) can only be updated when in FULL ACCESS mode. The order of the bytes entered through the *Control()* command is the reverse of what is read from the part. For example, if the 1st and 2nd word of the `UnSeal Key 0` returns 0x1234 and 0x5678, then *Control()* should supply 0x3412 and 0x7856 to unseal the part.

7.2.4 Data Flash Summary

Table 7-8 summarizes the data flash locations available to the user, including the default, minimum, and maximum values.

Table 7-8. Data Flash Summary

CLASS	SUBCLASS	SUBCLASS ID	OFFSET	TYPE	NAME	MIN	MAX	DEFAULT	UNIT
Configuration	Safety	2	0	I2	OT Chg	0	1200	550	0.1°C
Configuration	Safety	2	2	U1	OT Chg Time	0	60	2	s
Configuration	Safety	2	3	I2	OT Chg Recovery	0	1200	500	0.1°C
Configuration	Safety	2	5	I2	OT Dsg	0	1200	600	0.1°C
Configuration	Safety	2	7	U1	OT Dsg Time	0	60	2	s
Configuration	Safety	2	8	I2	OT Dsg Recovery	0	1200	550	0.1°C
Configuration	Charge Inhibit Cfg	32	0	I2	Chg Inhibit Temp Low	-400	1200	0	0.1°C
Configuration	Charge Inhibit Cfg	32	2	I2	Chg Inhibit Temp High	-400	1200	450	0.1°C
Configuration	Charge Inhibit Cfg	32	4	I2	Temp Hys	0	100	50	0.1°C
Configuration	Charge	34	0	I2	Suspend Low Temp	-400	1200	-50	0.1°C
Configuration	Charge	34	2	I2	Suspend High Temp	-400	1200	550	0.1°C
Configuration	Charge	34	4	U1	Pb EFF Efficiency	0	100	100	%
Configuration	Charge	34	5	F4	Pb Temp Comp	0	0.078125	0.01953125	%
Configuration	Charge	34	9	U1	Pb Drop Off Percent	0	100	96	%
Configuration	Charge	34	10	F4	Pb Reduction Rate	0	1.25	0.125	%
Configuration	Charge Termination	36	0	I2	Taper Current	0	1000	100	mA
Configuration	Charge Termination	36	2	I2	Min Taper Capacity	0	1000	25	mAh
Configuration	Charge Termination	36	4	I2	Cell Taper Voltage	0	1000	100	mV
Configuration	Charge Termination	36	6	U1	Current Taper Window	0	60	40	s
Configuration	Charge Termination	36	7	I1	TCA Set %	-1	100	99	%
Configuration	Charge Termination	36	8	I1	TCA Clear %	-1	100	95	%
Configuration	Charge Termination	36	9	I1	FC Set %	-1	100	100	%
Configuration	Charge Termination	36	10	I1	FC Clear %	-1	100	98	%
Configuration	Charge Termination	36	11	I2	DODatEOC Delta T	0	1000	100	0.1°C
Configuration	Charge Termination	36	13	I2	NiMH Delta Temp	0	255	30	0.1°C
Configuration	Charge Termination	36	15	U2	NiMH Delta Temp Time	0	1000	180	s
Configuration	Charge Termination	36	17	U2	NiMH Hold Off Time	0	1000	100	s
Configuration	Charge Termination	36	19	I2	NiMH Hold Off Current	0	32000	240	mA
Configuration	Charge Termination	36	21	I2	NiMH Hold Off Temp	0	1000	250	0.1°C
Configuration	Charge Termination	36	23	U1	NiMH Cell Negative Delta Volt	0	100	17	mV
Configuration	Charge Termination	36	24	U1	NiMH Cell Negative Delta Time	0	255	16	s

Table 7-8. Data Flash Summary (continued)

CLASS	SUBCLASS	SUBCLASS ID	OFFSET	TYPE	NAME	MIN	MAX	DEFAULT	UNIT
Configuration	Charge Termination	36	25	I2	NiMH Cell Neg Delta Qual Volt	0	32767	4200	mV
Configuration	Data	48	2	U2	Manufacture Date	0	65535	0	Day + Mo*32 + (Yr -1980)*256
Configuration	Data	48	4	H2	Serial Number	0	ffff	1	hex
Configuration	Data	48	6	U2	Cycle Count	0	65535	0	Counts
Configuration	Data	48	8	I2	CC Threshold	100	32767	900	mAh
Configuration	Data	48	10	U1	Max Error Limit	0	100	100	%
Configuration	Data	48	11	I2	Design Capacity	0	32767	1000	mAh
Configuration	Data	48	13	I2	Design Energy	0	32767	5400	mWh
Configuration	Data	48	15	I2	SOH Load I	-32767	0	-400	mA
Configuration	Data	48	17	U2	Cell Charge Voltage T1-T2	0	4600	4200	mV
Configuration	Data	48	19	U2	Cell Charge Voltage T2-T3	0	4600	4200	mV
Configuration	Data	48	21	U2	Cell Charge Voltage T3-T4	0	4600	4100	mV
Configuration	Data	48	23	U1	Charge Current T1-T2	0	100	10	%
Configuration	Data	48	24	U1	Charge Current T2-T3	0	100	50	%
Configuration	Data	48	25	U1	Charge Current T3-T4	0	100	30	%
Configuration	Data	48	26	I1	JEITA T1	-128	127	-10	°C
Configuration	Data	48	27	I1	JEITA T2	-128	127	10	°C
Configuration	Data	48	28	I1	JEITA T3	-128	127	45	°C
Configuration	Data	48	29	I1	JEITA T4	-128	127	55	°C
Configuration	Data	48	30	U1	Design Energy Scale	0	255	1	Num
Configuration	Data	48	31	S12	Device Name	x	x	BQ34Z100	—
Configuration	Data	48	43	S12	Manufacturer Name	x	x	Texas Inst.	—
Configuration	Data	48	55	S5	Device Chemistry	x	x	LION	—
Configuration	Discharge	49	0	U2	SOC1 Set Threshold	0	65535	150	mAh
Configuration	Discharge	49	2	U2	SOC1 Clear Threshold	0	65535	175	mAh
Configuration	Discharge	49	4	U2	SOCF Set Threshold	0	65535	75	mAh
Configuration	Discharge	49	6	U2	SOCF Clear Threshold	0	65535	100	mAh
Configuration	Discharge	49	8	I2	Cell BL Set Volt Threshold	0	5000	0	mV
Configuration	Discharge	49	10	U1	Cell BL Set Volt Time	0	60	0	s
Configuration	Discharge	49	11	I2	Cell BL Clear Volt Threshold	0	5000	5	mV
Configuration	Discharge	49	13	I2	Cell BH Set Volt Threshold	0	5000	4300	mV
Configuration	Discharge	49	15	U1	Cell BH Volt Time	0	60	2	s
Configuration	Discharge	49	16	I2	Cell BH Clear Volt Threshold	0	5000	5	mV
Configuration	Discharge	49	21	U1	Cycle Delta	0	255	5	0.01%
Configuration	Manufacturer Data	56	0	H2	Pack Lot Code	0	ffff	0	hex
Configuration	Manufacturer Data	56	2	H2	PCB Lot Code	0	ffff	0	hex
Configuration	Manufacturer Data	56	4	H2	Firmware Version	0	ffff	0	hex
Configuration	Manufacturer Data	56	6	H2	Hardware Revision	0	ffff	0	hex
Configuration	Manufacturer Data	56	8	H2	Cell Revision	0	ffff	0	hex
Configuration	Manufacturer Data	56	10	H2	DF Config Version	0	ffff	0	hex
Configuration	Lifetime Data	59	0	I2	Lifetime Max Temp	0	1400	300	0.1°C
Configuration	Lifetime Data	59	2	I2	Lifetime Min Temp	-600	1400	200	0.1°C
Configuration	Lifetime Data	59	4	I2	Lifetime Max Chg Current	-32767	32767	0	mA

Table 7-8. Data Flash Summary (continued)

CLASS	SUBCLASS	SUBCLASS ID	OFFSET	TYPE	NAME	MIN	MAX	DEFAULT	UNIT
Configuration	Lifetime Data	59	6	I2	Lifetime Max Dsg Current	-32767	32767	0	mA
Configuration	Lifetime Data	59	8	U2	Lifetime Max Pack Voltage	0	65535	320	20 mV
Configuration	Lifetime Data	59	10	U2	Lifetime Min Pack Voltage	0	65535	350	20 mV
Configuration	Lifetime Temp Samples	60	0	U2	LT Flash Cnt	0	65535	0	Counts
Configuration	Registers	64	0	H2	Pack Configuration	0	fff	161	flags
Configuration	Registers	64	2	H1	Pack Configuration B	0	ff	ff	flags
Configuration	Registers	64	3	H1	Pack Configuration C	0	ff	30	flags
Configuration	Registers	64	4	H1	LED_Comm Configuration	0	ff	0	flags
Configuration	Registers	64	5	H2	Alert Configuration	0	fff	0	flags
Configuration	Registers	64	7	U1	Number of series cell	0	100	1	Num
Configuration	Lifetime Resolution	66	0	U1	LT Temp Res	0	255	10	0.1°C
Configuration	Lifetime Resolution	66	1	U1	LT Cur Res	0	255	100	mA
Configuration	Lifetime Resolution	66	2	U1	LT V Res	0	255	1	20 mV
Configuration	Lifetime Resolution	66	3	U2	LT Update Time	0	65535	60	s
Configuration	LED Display	67	0	U1	LED Hold Time	0	255	4	Num
Configuration	Power	68	0	I2	Flash Update OK Cell Volt	0	4200	2800	mV
Configuration	Power	68	2	I2	Sleep Current	0	100	10	mA
Configuration	Power	68	11	U1	FS Wait	0	255	0	s
System Data	Manufacturer Info	58	0	H1	Block A 0	0	ff	0	hex
System Data	Manufacturer Info	58	1	H1	Block A 1	0	ff	0	hex
System Data	Manufacturer Info	58	2	H1	Block A 2	0	ff	0	hex
System Data	Manufacturer Info	58	3	H1	Block A 3	0	ff	0	hex
System Data	Manufacturer Info	58	4	H1	Block A 4	0	ff	0	hex
System Data	Manufacturer Info	58	5	H1	Block A 5	0	ff	0	hex
System Data	Manufacturer Info	58	6	H1	Block A 6	0	ff	0	hex
System Data	Manufacturer Info	58	7	H1	Block A 7	0	ff	0	hex
System Data	Manufacturer Info	58	8	H1	Block A 8	0	ff	0	hex
System Data	Manufacturer Info	58	9	H1	Block A 9	0	ff	0	hex
System Data	Manufacturer Info	58	10	H1	Block A 10	0	ff	0	hex
System Data	Manufacturer Info	58	11	H1	Block A 11	0	ff	0	hex
System Data	Manufacturer Info	58	12	H1	Block A 12	0	ff	0	hex
System Data	Manufacturer Info	58	13	H1	Block A 13	0	ff	0	hex
System Data	Manufacturer Info	58	14	H1	Block A 14	0	ff	0	hex
System Data	Manufacturer Info	58	15	H1	Block A 15	0	ff	0	hex
System Data	Manufacturer Info	58	16	H1	Block A 16	0	ff	0	hex

Table 7-8. Data Flash Summary (continued)

CLASS	SUBCLASS	SUBCLASS ID	OFFSET	TYPE	NAME	MIN	MAX	DEFAULT	UNIT
System Data	Manufacturer Info	58	17	H1	Block A 17	0	ff	0	hex
System Data	Manufacturer Info	58	18	H1	Block A 18	0	ff	0	hex
System Data	Manufacturer Info	58	19	H1	Block A 19	0	ff	0	hex
System Data	Manufacturer Info	58	20	H1	Block A 20	0	ff	0	hex
System Data	Manufacturer Info	58	21	H1	Block A 21	0	ff	0	hex
System Data	Manufacturer Info	58	22	H1	Block A 22	0	ff	0	hex
System Data	Manufacturer Info	58	23	H1	Block A 23	0	ff	0	hex
System Data	Manufacturer Info	58	24	H1	Block A 24	0	ff	0	hex
System Data	Manufacturer Info	58	25	H1	Block A 25	0	ff	0	hex
System Data	Manufacturer Info	58	26	H1	Block A 26	0	ff	0	hex
System Data	Manufacturer Info	58	27	H1	Block A 27	0	ff	0	hex
System Data	Manufacturer Info	58	28	H1	Block A 28	0	ff	0	hex
System Data	Manufacturer Info	58	29	H1	Block A 29	0	ff	0	hex
System Data	Manufacturer Info	58	30	H1	Block A 30	0	ff	0	hex
System Data	Manufacturer Info	58	31	H1	Block A 31	0	ff	0	hex
Gas Gauging	IT Cfg	80	0	U1	Load Select	0	255	1	Num
Gas Gauging	IT Cfg	80	1	U1	Load Mode	0	255	0	Num
Gas Gauging	IT Cfg	80	10	I2	Res Current	0	1000	10	mA
Gas Gauging	IT Cfg	80	14	U1	Max Res Factor	0	255	50	Num
Gas Gauging	IT Cfg	80	15	U1	Min Res Factor	0	255	1	Num
Gas Gauging	IT Cfg	80	17	U2	Ra Filter	0	1000	500	Num
Gas Gauging	IT Cfg	80	47	U1	Min PassedChg NiMH-LA 1st Qmax	1	100	50	%
Gas Gauging	IT Cfg	80	49	U1	Maximum Qmax Change	0	255	100	%
Gas Gauging	IT Cfg	80	53	I2	Cell Terminate Voltage	1000	3700	3000	mV
Gas Gauging	IT Cfg	80	55	I2	Cell Term V Delta	0	4200	200	mV
Gas Gauging	IT Cfg	80	58	U2	ResRelax Time	0	65534	500	s
Gas Gauging	IT Cfg	80	62	I2	User Rate-mA	-32767	32767	0	mA
Gas Gauging	IT Cfg	80	64	I2	User Rate-Pwr	-32767	32767	0	mW/cW
Gas Gauging	IT Cfg	80	66	I2	Reserve Cap-mAh	0	9000	0	mAh
Gas Gauging	IT Cfg	80	68	I2	Reserve Energy	0	14000	0	mWh/cWh
Gas Gauging	IT Cfg	80	72	U1	Max Scale Back Grid	0	15	4	Num
Gas Gauging	IT Cfg	80	73	U2	Cell Min DeltaV	0	65535	0	mV
Gas Gauging	IT Cfg	80	75	U1	Ra Max Delta	0	255	15	%
Gas Gauging	IT Cfg	80	76	I2	Design Resistance	1	32767	42	mΩ
Gas Gauging	IT Cfg	80	78	U1	Reference Grid	0	14	4	—
Gas Gauging	IT Cfg	80	79	U1	Qmax Max Delta %	0	100	10	mAh
Gas Gauging	IT Cfg	80	80	U2	Max Res Scale	0	32767	32000	Num
Gas Gauging	IT Cfg	80	82	U2	Min Res Scale	0	32767	1	Num
Gas Gauging	IT Cfg	80	84	U1	Fast Scale Start SOC	0	100	10	%

Table 7-8. Data Flash Summary (continued)

CLASS	SUBCLASS	SUBCLASS ID	OFFSET	TYPE	NAME	MIN	MAX	DEFAULT	UNIT
Gas Gauging	IT Cfg	80	89	I2	Charge Hys V Shift	0	2000	40	mV
Gas Gauging	IT Cfg	80	91	I2	Smooth Relax Time	1	32767	1000	s
Gas Gauging	Current Thresholds	81	0	I2	Dsg Current Threshold	0	2000	60	mA
Gas Gauging	Current Thresholds	81	2	I2	Chg Current Threshold	0	2000	75	mA
Gas Gauging	Current Thresholds	81	4	I2	Quit Current	0	1000	40	mA
Gas Gauging	Current Thresholds	81	6	U2	Dsg Relax Time	0	8191	60	s
Gas Gauging	Current Thresholds	81	8	U1	Chg Relax Time	0	255	60	s
Gas Gauging	Current Thresholds	81	9	U2	Cell Max IR Correct	0	1000	400	mV
Gas Gauging	State	82	0	I2	Qmax Cell 0	0	32767	1000	mAh
Gas Gauging	State	82	2	U2	Cycle Count	0	65535	0	Num
Gas Gauging	State	82	4	H1	Update Status	0	6	0	Num
Gas Gauging	State	82	5	I2	Cell V at Chg Term	0	5000	4200	mV
Gas Gauging	State	82	7	I2	Avg I Last Run	-32768	32767	-299	mA
Gas Gauging	State	82	9	I2	Avg P Last Run	-32768	32767	-1131	mWh
Gas Gauging	State	82	11	I2	Cell Delta Voltage	-32768	32767	2	mV
Gas Gauging	State	82	13	I2	T Rise	0	32767	20	Num
Gas Gauging	State	82	15	I2	T Time Constant	0	32767	1000	Num
Ra Table	R_a0	88	0	H2	R_a0 Flag	0	ffff	ff55	Hex
Ra Table	R_a0	88	2	I2	R_a0 0	0	32767	105	Num
Ra Table	R_a0	88	4	I2	R_a0 1	0	32767	100	Num
Ra Table	R_a0	88	6	I2	R_a0 2	0	32767	113	Num
Ra Table	R_a0	88	8	I2	R_a0 3	0	32767	143	Num
Ra Table	R_a0	88	10	I2	R_a0 4	0	32767	98	Num
Ra Table	R_a0	88	12	I2	R_a0 5	0	32767	97	Num
Ra Table	R_a0	88	14	I2	R_a0 6	0	32767	108	Num
Ra Table	R_a0	88	16	I2	R_a0 7	0	32767	89	Num
Ra Table	R_a0	88	18	I2	R_a0 8	0	32767	86	Num
Ra Table	R_a0	88	20	I2	R_a0 9	0	32767	85	Num
Ra Table	R_a0	88	22	I2	R_a0 10	0	32767	87	Num
Ra Table	R_a0	88	24	I2	R_a0 11	0	32767	90	Num
Ra Table	R_a0	88	26	I2	R_a0 12	0	32767	110	Num
Ra Table	R_a0	88	28	I2	R_a0 13	0	32767	647	Num
Ra Table	R_a0	88	30	I2	R_a0 14	0	32767	1500	Num
Ra Table	R_a0x	89	0	H2	R_a0x Flag	0	ffff	ffff	Hex
Ra Table	R_a0x	89	2	I2	R_a0x 0	0	32767	105	Num
Ra Table	R_a0x	89	4	I2	R_a0x 1	0	32767	100	Num
Ra Table	R_a0x	89	6	I2	R_a0x 2	0	32767	113	Num
Ra Table	R_a0x	89	8	I2	R_a0x 3	0	32767	143	Num
Ra Table	R_a0x	89	10	I2	R_a0x 4	0	32767	98	Num
Ra Table	R_a0x	89	12	I2	R_a0x 5	0	32767	97	Num
Ra Table	R_a0x	89	14	I2	R_a0x 6	0	32767	108	Num
Ra Table	R_a0x	89	16	I2	R_a0x 7	0	32767	89	Num
Ra Table	R_a0x	89	18	I2	R_a0x 8	0	32767	86	Num
Ra Table	R_a0x	89	20	I2	R_a0x 9	0	32767	85	Num
Ra Table	R_a0x	89	22	I2	R_a0x 10	0	32767	87	Num

Table 7-8. Data Flash Summary (continued)

CLASS	SUBCLASS	SUBCLASS ID	OFFSET	TYPE	NAME	MIN	MAX	DEFAULT	UNIT
Ra Table	R_a0x	89	24	I2	R_a0x 11	0	32767	90	Num
Ra Table	R_a0x	89	26	I2	R_a0x 12	0	32767	110	Num
Ra Table	R_a0x	89	28	I2	R_a0x 13	0	32767	647	Num
Ra Table	R_a0x	89	30	I2	R_a0x 14	0	32767	1500	Num
Calibration	Data	104	0	F4	CC Gain	1.00E-01	4.00E+01	0.4768	mΩ
Calibration	Data	104	4	F4	CC Delta	2.98E+04	1.19E+06	567744.56	mΩ
Calibration	Data	104	8	I2	CC Offset	-32768	32767	-1200	Num
Calibration	Data	104	10	I1	Board Offset	-128	127	0	Num
Calibration	Data	104	11	I1	Int Temp Offset	-128	127	0	0.1°C
Calibration	Data	104	12	I1	Ext Temp Offset	-128	127	0	0.1°C
Calibration	Data	104	14	U2	Voltage Divider	0	65535	5000	mV
Calibration	Current	107	1	U1	Deadband	0	255	5	mA
Security	Codes	112	0	H4	Sealed to Unsealed	0	ffffff	36720414	hex
Security	Codes	112	4	H4	Unsealed to Full	0	ffffff	ffffff	hex
Security	Codes	112	8	H4	Authen Key3	0	ffffff	1234567	hex
Security	Codes	112	12	H4	Authen Key2	0	ffffff	89abcdef	hex
Security	Codes	112	16	H4	Authen Key1	0	ffffff	fedcba98	hex
Security	Codes	112	20	H4	Authen Key0	0	ffffff	76543210	hex

Table 7-9. Data Flash (DF) to EVSW Conversion

CLASS	SUBCLASS ID	SUBCLASS	OFFSET	NAME	DATA TYPE	DATA FLASH DEFAULT	DATA FLASH UNIT	EVSW DEFAULT	EVSW UNIT	DF to EVSW CONVERSION
Data	48	Data	13	Manufacture Date	U2	0	code	1-Jan-1980		Day+Mo*32+(Yr-1980)*256
Gas Gauging	80	IT Cfg	59	User Rate-mW	I2	0	cW	0	mW	DF × 10
Gas Gauging	80	IT Cfg	63	Reserve Cap-mWh	I2	0	cWh	0	mWh	DF × 10
Calibration	104	Data	0	CC Gain	F4	0.47095	Num	10.124	mΩ	4.768/DF
Calibration	104	Data	4	CC Delta	F4	5.595E5	Num	10.147	mΩ	5677445/DF

7.2.5 Fuel Gauging

The BQ34Z100 measures the cell voltage, temperature, and current to determine the battery SOC based in the Impedance Track algorithm (refer to *Theory and Implementation of Impedance Track Battery Fuel-Gauging Algorithm Application Report* [SLUA450] for more information). The BQ34Z100 monitors charge and discharge activity by sensing the voltage across a small-value resistor (5 mΩ to 20 mΩ typ.) between the SRP and SRN pins and in-series with the cell. By integrating charge passing through the battery, the cell's SOC is adjusted during battery charge or discharge.

The total battery capacity is found by comparing states of charge before and after applying the load with the amount of charge passed. When an application load is applied, the impedance of the cell is measured by comparing the OCV obtained from a predefined function for the present SOC with the measured voltage under load. Measurements of OCV and charge integration determine chemical state-of-charge and Chemical Capacity (Q_{max}). The initial Q_{max} value is taken from a cell manufacturers' data sheet multiplied by the number of parallel cells. The parallel value is also used for the value programmed in **Design Capacity**. The BQ34Z100 acquires and updates the battery-impedance profile during normal battery usage. It uses this profile, along with SOC and the Q_{max} value, to determine *FullChargeCapacity()* and *StateOfCharge()* specifically for the present load and temperature. *FullChargeCapacity()* is reported as capacity available from a fully charged battery under the present load and temperature until *Voltage()* reaches the **Terminate Voltage**. *NominalAvailableCapacity()* and *FullAvailableCapacity()* are the uncompensated (no or light load) versions of *RemainingCapacity()* and *FullChargeCapacity()*, respectively.

The BQ34Z100 has two flags accessed by the *Flags()* function that warn when the battery's SOC has fallen to critical levels. When *RemainingCapacity()* falls below the first capacity threshold, specified in **SOC1 Set Threshold**, the [SOC1] (State of Charge Initial) flag is set. The flag is cleared once *RemainingCapacity()* rises above **SOC1 Clear Threshold**. All units are in mAh.

When *RemainingCapacity()* falls below the second capacity threshold, **SOCF Set Threshold**, the [SOCF] (State of Charge Final) flag is set, serving as a final discharge warning. If **SOCF Set Threshold** = -1, the flag is inoperative during discharge. Similarly, when *RemainingCapacity()* rises above **SOCF Clear Threshold** and the [SOCF] flag has already been set, the [SOCF] flag is cleared. All units are in mAh.

The BQ34Z100 has two additional flags accessed by the *Flags()* function that warn of internal battery conditions. The fuel gauge monitors the cell voltage during relaxed conditions to determine if an internal short has been detected. When this condition occurs, [ISD] will be set. The BQ34Z100 also has the capability of detecting when a tab has been disconnected in a 2-cell parallel system by actively monitoring the state of health. When this condition occurs, [TDD] will be set.

7.2.6 Impedance Track Variables

The BQ34Z100 has several data flash variables that permit the user to customize the Impedance Track algorithm for optimized performance. These variables are dependent upon the power characteristics of the application as well as the cell itself.

7.2.6.1 Load Mode

Load Mode is used to select either the constant current or constant power model for the Impedance Track algorithm as used in **Load Select**. See the [Section 7.2.6.2](#) section. When **Load Mode** is 0, the *Constant Current Model* is used (default). When **Load Mode** is 1, the *Constant Power Model* is used. The [LDMD] bit of CONTROL_STATUS reflects the status of Load Mode.

7.2.6.2 Load Select

Load Select defines the type of power or current model to be used to compute load-compensated capacity in the Impedance Track algorithm. If **Load Mode** = 0 (Constant Current), then the options presented in [Table 7-10](#) are available.

Table 7-10. Current Model Used When Load Mode = 0

LOAD SELECT VALUE	CURRENT MODEL USED
0	Average discharge current from previous cycle: There is an internal register that records the average discharge current through each entire discharge cycle. The previous average is stored in this register.
1 (default)	Present average discharge current: This is the average discharge current from the beginning of this discharge cycle until present time.
2	Average Current: based on the <i>AverageCurrent()</i>
3	Current: based on a low-pass-filtered version of <i>AverageCurrent()</i> ($\tau=14s$)
4	Design Capacity/5: C Rate based off of Design Capacity /5 or a C/5 rate in mA.
5	Use the value specified by <i>AtRate()</i>
6	Use the value in User_Rate-mA : This gives a completely user configurable method.

If **Load Mode** = 1 (*Constant Power*), then the following options are available:

Table 7-11. Constant-Power Model Used When Load Mode = 1

LOAD SELECT VALUE	POWER MODEL USED
0 (default)	Average discharge power from previous cycle: There is an internal register that records the average discharge power through each entire discharge cycle. The previous average is stored in this register.
1	Present average discharge power: This is the average discharge power from the beginning of this discharge cycle until present time.
2	Average Current × Voltage: based off the <i>AverageCurrent()</i> and <i>Voltage()</i> .
3	Current × Voltage: based on a low-pass-filtered version of <i>AverageCurrent()</i> ($\tau=14s$) and <i>Voltage()</i>
4	Design Energy/5: C Rate based off of Design Energy /5 or a C/5 rate in mA.

Table 7-11. Constant-Power Model Used When Load Mode = 1 (continued)

LOAD SELECT VALUE	POWER MODEL USED
5	Use whatever value specified by <i>AtRate()</i> .
6	Use the value in <i>User_Rate-mW/cW</i> . This gives a completely user-configurable method.

7.2.6.3 Reserve Cap-mAh

Reserve Cap-mAh determines how much actual remaining capacity exists after reaching 0 *RemainingCapacity()* before **Terminate Voltage** is reached. A loaded rate or no-load rate of compensation can be selected for Reserve Cap by setting the [RESCAP] bit in the Pack Configuration register.

7.2.6.4 Reserve Cap-mWh/cWh

Reserve Cap-mWh determines how much actual remaining capacity exists after reaching 0 *AvailableEnergy()* before **Terminate Voltage** is reached. A loaded rate or no-load rate of compensation can be selected for Reserve Cap by setting the [RESCAP] bit in the Pack Configuration register.

7.2.6.5 Design Energy Scale

Design Energy Scale is used to select the scale/unit of a set of data flash parameters. The value of **Design Energy Scale** can be either 1 or 10 only.

When using Design Energy Scale = 10, the value for each of the parameters in [Table 7-12](#) must be adjusted to reflect the new units. See [Section 7.2.11](#).

Table 7-12. Data Flash Parameter Scale/Unit-Based on Design Energy Scale

DATA FLASH PARAMETER	DESIGN ENERGY SCALE = 1 (default)	DESIGN ENERGY SCALE = 10
Design Energy	mWh	cWh
Reserve Energy-mWh/cWh	mWh	cWh
Avg Power Last Run	mW	cW
User Rate-mW/cW	mWh	cWh
T Rise	No Scale	Scaled by [SCALED]

7.2.6.6 Dsg Current Threshold

This register is used as a threshold by many functions in the BQ34Z100 to determine if actual discharge current is flowing into or out of the cell. The default for this register should be sufficient for most applications. This threshold should be set low enough to be below any normal application load current but high enough to prevent noise or drift from affecting the measurement.

7.2.6.7 Chg Current Threshold

This register is used as a threshold by many functions in the BQ34Z100 to determine if actual charge current is flowing into or out of the cell. The default for this register should be sufficient for most applications. This threshold should be set low enough to be below any normal charge current but high enough to prevent noise or drift from affecting the measurement.

7.2.6.8 Quit Current, Dsg Relax Time, Chg Relax Time, and Quit Relax Time

The **Quit Current** is used as part of the Impedance Track algorithm to determine when the BQ34Z100 enters RELAX mode from a current flowing mode in either the charge direction or the discharge direction. The value of **Quit Current** is set to a default value that should be above the standby current of the host system.

Either of the following criteria must be met to enter RELAX mode:

1. $|AverageCurrent()| < |Quit Current|$ for **Dsg Relax Time**
2. $|AverageCurrent()| > |Quit Current|$ for **Chg Relax Time**

After about 6 minutes in RELAX mode, the device attempts to take accurate OCV readings. An additional requirement of $dV/dt < 4 \mu V/s$ is required for the device to perform Qmax updates. These updates are used in

the Impedance Track algorithms. It is critical that the battery voltage be relaxed during OCV readings, and that the current is not higher than C/20 when attempting to go into RELAX mode.

Quit Relax Time specifies the minimum time required for *AverageCurrent()* to remain above the **Quit Current** threshold before exiting RELAX mode.

7.2.6.9 Qmax

Qmax Cell 0 contains the maximum chemical capacity of the cell and is determined by comparing states of charge before and after applying the load with the amount of charge passed. It also corresponds to capacity at low rate of discharge, such as C/20 rate. For high accuracy, this value is periodically updated by the device during operation.

Based on the battery cell capacity information, the initial value of chemical capacity should be entered in the **Qmax Cell 0** data flash parameter. The Impedance Track algorithm will update this value and maintain it internally in the gauge.

7.2.6.10 Update Status

The Update Status register indicates the status of the Impedance Track algorithm.

Table 7-13. Update Status Definitions

UPDATE STATUS	STATUS
0x02	Qmax and Ra data are learned, but Impedance Track is not enabled. This should be the standard setting for a Golden Image File.
0x04	Impedance Track is enabled but Qmax and Ra data are not yet learned.
0x05	Impedance Track is enabled and only Qmax has been updated during a learning cycle.
0x06	Impedance Track is enabled. Qmax and Ra data are learned after a successful learning cycle. This should be the operation setting for end equipment.

This register should only be updated by the device during a learning cycle or when the *IT_ENABLE()* subcommand is received. Refer to the *Preparing Optimized Default Flash Constants for Specific Battery Types Application Report (SLUA334B)*.

7.2.6.11 Avg I Last Run

The device logs the current averaged from the beginning to the end of each discharge cycle. It stores this average current from the previous discharge cycle in this register. This register should never be modified. It is only updated by the device when required.

7.2.6.12 Avg P Last Run

The device logs the power averaged from the beginning to the end of each discharge cycle. It stores this average power from the previous discharge cycle in this register. To get a correct average power reading, the device continuously multiplies instantaneous current times *Voltage()* to get power. It then logs this data to derive the average power. This register should never need to be modified. It is only updated by the device when the required.

7.2.6.13 Delta Voltage

The device stores the maximum difference of *Voltage()* during short load spikes and normal load, so the Impedance Track algorithm can calculate remaining capacity for pulsed loads. It is not recommended to change this value.

7.2.6.14 Ra Tables

This data is automatically updated during device operation. No user changes should be made except for reading the values from another pre-learned pack for creating Golden Image Files. Profiles have format *Cell0 R_a M*, where M is the number that indicates state-of-charge to which the value corresponds.

7.2.6.15 Pack Configuration Register

Some BQ34Z100 pins are configured via the **Pack Configuration** data flash register, as indicated in [Table 7-14](#). This register is programmed/read via the methods described in [Section 7.2.3.1](#). The register is located at subclass = 64, offset = 0.

Table 7-14. Pack Configuration Register Bits

	Bit 7	Bit 6	Bit 5	Bit 4	Bit 3	Bit 2	Bit 1	Bit 0
High Byte	RESCAP	CAL_EN	RSVD	RSVD	VOLTSEL	IWAKE	RSNS1	RSNS0
Low Byte	X10	RESFACTST EP	SLEEP	RMFCC	RSVD	RSVD	RSVD	TEMPS

Legend: **RSVD** = Reserved

RESCAP: No-load rate of compensation is applied to the reserve capacity calculation. True when set. Default is 0.

CAL_EN: When enabled, entering CALIBRATION mode is permitted. For special use only. Default = 0.

VOLTSEL: This bit selects between use of internal or external battery voltage divider. The internal divider is for single cell use only. 1 = external. 0 = internal. Default is 0.

IWAKE/RSNS1/RSNS0: These bits configure the current wake function (see [Table 7-20](#)). Default is 0/0/1.

X10: X10 Capacity and/or Current bit. The mA, mAh, and cWh settings and reports will take on a value of ten times normal. This setting has no actual effect within the gauge. It is the responsibility of the host to reinterpret the reported values. X10 current measurement is achieved by calibrating the current measurement to a value X10 lower than actual.

SLEEP: The fuel gauge can enter sleep, if operating conditions allow. True when set. Default is 1.

RMFCC: RM is updated with the value from FCC, on valid charge termination. True when set. Default is 1.

RSVD: Reserved. Do not use.

TEMPS: Selects external thermistor for *Temperature()* measurements. True when set. Uses internal temp when clear. Default is 1

7.2.6.15.1 Pack Configuration B Register

Some BQ34Z100 pins are configured via the **Pack Configuration** data flash register, as indicated in [Table 7-14](#). This register is programmed/read via the methods described in [Section 7.2.3.1](#). The register is located at subclass = 64, offset = 0.

Table 7-15. Pack Configuration B Register Bits

Bit 7	Bit 6	Bit 5	Bit 4	Bit 3	Bit 2	Bit 1	Bit 0
CHGDoDEoC	RSVD	VconsEN	RSVD	JEITA	LFPRelax	DoDWT	FConvEN

CHGDoDEoC: Enable DoD at EoC during charging only. True when set. Default is 1. Default setting is recommended.

VconsEN: Enable voltage consistency check. True when set. Default is 1. Default setting is recommended.

LFPRelax: Enables Lithium Iron Phosphate Relax

DoDWT: Enable Dod weighting for LiFePO₄ support when chemical ID 400 series is selected. True when set. Default is 1

FConvEN: Enable fast convergence algorithm. Default is 1. Default setting is recommended.

RMFCC: TBD

7.2.6.15.2 Pack Configuration C Register

Some BQ34Z100 pins are configured via the **Pack Configuration** data flash register, as indicated in [Table 7-14](#). This register is programmed/read via the methods described in [Section 7.2.3.1](#). The register is located at subclass = 64, offset = 0.

Table 7-16. Pack Configuration C Register Bits

Bit 7	Bit 6	Bit 5	Bit 4	Bit 3	Bit 2	Bit 1	Bit 0
SOH_DISP	RSOC_HOLD	FF_NEAR_EDV	SleepWakeCHG	LOCK_0	RELAX_JUMP_OK	RELAX_SMOOTH_OK	SMOOTH

SOH_DISP: Enables State-of-Health Display

RSOC_HOLD: Enables RSOC Hold Feature preventing RSOC from increasing during discharge

SleepWakeCHG: Enable for faster sampling in SLEEP mode. Default setting is recommended.

LOCK_0: Keep *RemainingCapacity()* and *RelativeStateOfCharge()* jumping back during relaxation after 0 was reached during discharge.

RELAX_JUMP_OK: Allows RSOC jump during RELAX mode

RELAX_SMOOTH_OK: Smooth RSOC during RELAX mode

SMOOTH: Enabled RSOC Smoothing

7.2.7 Voltage Division and Calibration

The device is shipped with a factory configuration for the default case of the 1-series Li-ion cell. This can be changed by setting the VOLTSEL bit in the Pack Configuration register and by setting the number of series cells in the data flash configuration section.

Multi-cell applications, with voltages up to 65535 mV, may be gauged by using the appropriate input scaling resistors such that the maximum battery voltage, under all conditions, appears at the BAT input as approximately 900 mV. The actual gain function is determined by a calibration process and the resulting voltage calibration factor is stored in the data flash location **Voltage Divider**.

For single-cell applications, an external divider network is not required. Inside the IC, behind the BAT pin is a nominal 5:1 voltage divider with 88 KΩ in the top leg and 22 KΩ in the bottom leg. This internal divider network is enabled by clearing the VOLTSEL bit in the Pack Configuration register. This ratio is optimum for directly measuring a single Li-ion cell where charge voltage is limited to 4.5 V.

For higher voltage applications, an external resistor divider network should be implemented as per the reference designs in this document. The quality of the divider resistors is very important to avoid gauging errors over time and temperature. It is recommended to use 0.1% resistors with 25-ppm temperature coefficient. Alternately, a matched network could be used that tracks its dividing ratio with temperature and age due to the similar geometry of each element. Calculation of the series resistor can be made per the equation below.

Note

Exceeding **Vin max mV** results in a measurement with degraded linearity.

The bottom leg of the divider resistor should be in the range of 15 KΩ to 25 K, using 16.5 KΩ:

$$R_{series} = 16500 \Omega (V_{in \max \text{ mV}} - 900 \text{ mV})/900 \text{ mV}$$

For all applications, the **Voltage Divider** value in data flash will be used by the firmware to calibrate the total divider ratio. The nominal value for this parameter is the maximum expected value for the stack voltage. The calibration routine adjusts the value to force the reported voltage to equal the actual applied voltage.

7.2.7.1 1S Example

For stack voltages under 4.5 V max, it is not necessary to provide an external voltage divider network. The internal 5:1 divider should be selected by clearing the VOLTSEL bit in the Pack Configuration register. The default value for **Voltage Divider** is 5000 (representing the internal 5000:1000 mV divider) when no external divider resistor is used, and the default number of series cells = 1. In the 1-S case, there is usually no requirement to calibrate the voltage measurement, since the internal divider is calibrated during factory test to within 2 mV.

7.2.7.2 7S Example

In the multi-cell case, the hardware configuration is different. An external voltage divider network is calculated using the Rseries formula above. The bottom leg of the divider should be in the range of 15 K Ω to 25 K Ω . For more details on configuration, see [Section 8.1.2.1](#).

7.2.7.3 Autocalibration

The device provides an autocalibration feature that will measure the voltage offset error across SRP and SRN from time-to-time as operating conditions change. It subtracts the resulting offset error from normal sense resistor voltage, V_{SR} , for maximum measurement accuracy.

The gas gauge performs a single offset calibration when:

1. The interface lines stay low for a minimum of **Bus Low Time** and
2. $V_{SR} > \text{Deadband}$.

The gas gauge also performs a single offset when:

1. The condition of $\text{AverageCurrent}() \leq \text{Autocal Min Current}$ and
2. {Voltage change since last offset calibration $\geq \text{Delta Voltage}$ } or {temperature change since last offset calibration is greater than **Delta Temperature** for $\geq \text{Autocal Time}$ }.

Capacity and current measurements should continue at the last measured rate during the offset calibration when these measurements cannot be performed. If the battery voltage drops more than **Cal Abort** during the offset calibration, the load current has likely increased considerably; hence, the offset calibration will be aborted.

7.2.8 Temperature Measurement

The BQ34Z100 can measure temperature via the on-chip temperature sensor or via the TS input, depending on the setting of the [TEMPS] bit $\text{PackConfiguration}()$. The bit is set by using the $\text{PackConfiguration}()$ function, described in [Section 7.2.2](#).

Temperature measurements are made by calling the $\text{Temperature}()$ function (see [Section 7.2.1.1](#) for specific information).

When an external thermistor is used, REG25 (pin 7) is used to bias the thermistor and TS (pin 11) is used to measure the thermistor voltage (a pull-down circuit is implemented inside the device). The device then correlates the voltage to temperature, assuming the thermistor is a Semitec 103AT or similar device.

7.2.9 Overtemperature Indication

7.2.9.1 Overtemperature: Charge

If during charging, $\text{Temperature}()$ reaches the threshold of **DF:OT Chg** for a period of **OT Chg Time** and $\text{AverageCurrent}() > \text{Chg Current Threshold}$, then the [OTC] bit of $\text{Flags}()$ is set. Note: If **OT Chg Time** = 0, then the feature is completely disabled.

When $\text{Temperature}()$ falls to **OT Chg Recovery**, the [OTC] of $\text{Flags}()$ is reset.

7.2.9.2 Overtemperature: Discharge

If during discharging $\text{Temperature}()$ reaches the threshold of **OT Dsg** for a period of **OT Dsg Time**, and $\text{AverageCurrent}() \leq -\text{Dsg Current Threshold}$, then the [OTD] bit of $\text{Flags}()$ is set. If **OT Dsg Time** = 0, then the feature is completely disabled.

When $\text{Temperature}()$ falls to **OT Dsg Recovery**, the [OTD] bit of $\text{Flags}()$ is reset.

7.2.10 Charging and Charge Termination Indication

For proper BQ34Z100 operation, the battery per cell charging voltage must be specified by the user. The default value for this variable is **Charging Voltage** = 4200 mV. This parameter should be set to the recommended charging voltage for the entire battery stack.

The device detects charge termination when (1) during two consecutive periods of **Current Taper Window**, the $\text{AverageCurrent}()$ is $< \text{Taper Current}$ and (2) during the same periods, the accumulated change in capacity $> 0.25 \text{ mAh} / \text{Taper Current Window}$ and (3) $\text{Voltage}() > \text{Charging Voltage} - \text{Charging Taper Voltage}$. When

this occurs, the [CHG] bit of *Flags()* is cleared. Also, if the [RMFCC] bit of Pack Configuration is set, and *RemainingCapacity()* is set equal to *FullChargeCapacity()*.

7.2.11 X10 Mode

The device supports high current and high capacity batteries above 32.76 Amperes and 32.76 Ampere-Hours by switching to a times-ten mode where currents and capacities are internally handled correctly, but various reported units and configuration quantities are rescaled to tens of milliamps and tens of milliamp-hours. The need for this is due to the standardization of a two byte data command having a maximum representation of +/-32767. When the X10 bit (Bit 7) is set in the Pack Configuration register, all of the mAh, cWh, and mWh settings will take on a value of ten times normal. When this bit is set, the actual units for all capacity and energy parameters will be 10 mAh or Wh. This includes reporting of Remaining Capacity. This bit will also be used to rescale the current reporting to 10 times normal, up to +/-327 A. The actual resolution in that case becomes 10 mA.

It is important to know that setting the X10 flag does not actually change anything in the operation of the gauge. It serves as a notice to the host that the various reported values should be reinterpreted ten times higher. X10 Current measurement is achieved by calibrating the current gain to a value X10 lower than actually applied. Because the flag has no actual effect, it can be used to represent other scaling values. See [Section 7.2.6.5](#).

7.2.12 Remaining State of Charge LED Indication

The device supports multiple options for using one to 16 LEDs as an output device to display the remaining state of charge. The LED/COMM Configuration register determines the behavior.

Table 7-17. LED/COMM Configuration Bits

Bit 7	Bit 6	Bit 5	Bit 4	Bit 3	Bit 2	Bit 1	Bit 0
XLED3	XLED2	XLED1	XLED0	LEDON	Mode2	Mode1	Mode0

Bits 0, 1, 2 are a code for one of five modes. 0 = No LED, 1 = Single LED, 2 = Four LEDs, 3 = External LEDs with I²C comm, 4 = External LEDs with HDQ comm.

Setting Bit 3, LEDON, will cause the LED display to be always on, except in Single LED mode. When clear (default), the LED pattern will only be displayed after holding an LED display button for one to two seconds. The button applies 2.5 V from REG25 pin 7 to VEN pin 2 (refer to [Section 8.1](#)). The **LED Hold Time** parameter may be used to configure how long the LED display remains on if LEDON is clear. **LED Hold Time** configures the update interval for the LED display if LEDON is set.

Bits 4, 5, 6, and 7 are a binary code for number of external LEDs. Code 0 is reserved. Codes 1 through 15 represents 2~16 external LEDs. So, number of External LEDs is 1 + Value of the 4-bit binary code. Display of Remaining Capacity will be evenly divided among the selected number of LEDs.

Single LED mode—Upon detecting an A/D value representing 2.5 V on the VEN pin, Single LED mode will toggle the LED as duty cycle on within a period of 1 s. So, for example, 10% RSOC will have the LED on for 100 ms and off for 900 ms. 90% RSOC will have the LED on for 900 ms and off for 100 ms. Any value > 90% will display as 90%.

Four-LED mode—Upon detecting an A/D value representing 2.5 V on the VEN pin, Four-LED mode will display the RSOC by driving pins RC2(LED1), RC0(LED2), RA1(LED3), RA2(LED4) in a proportional manner where each LED represents 25% of the remaining state-of-charge. For example, if RSOC = 67%, three LEDs will be illuminated.

External LED mode—Upon detecting an A/D value representing 2.5 V on the VEN pin, External LED mode will transmit the RSOC into an SN74HC164 (for 2–8 LEDs) or two SN74HC164 devices (for 9–16 LEDs) using a bit-banged approach with RC2 as Clock and RC0 as Data (see [Figure 8-4](#)). LEDs will be lit for a number of seconds as defined in a data flash parameter. Refer to the *SN54HC164, SN74HC164 8-Bit Parallel-Out Serial Shift Registers Data Sheet (SCLS115E)* for details on these devices.

Extended commands are available to turn the LEDs on and off for test purposes.

7.2.13 Alert Signal

Based on the selected LED mode, various options are available for the hardware implementation of an Alert signal. Software configuration of the Alert Configuration register determines which alert conditions will assert the $\overline{\text{ALERT}}$ pin.

Table 7-18. $\overline{\text{ALERT}}$ Signal Pins

MODE	DESCRIPTION	ALERT PIN	ALERT PIN NAME	CONFIG REGISTER HEX CODE	COMMENT
0	No LED	1	P2	0	
1	Single LED	1	P2	1	
2	4 LED	11	P6	2	Filter and FETs are required to eliminate temperature sense pulses. See Section 8.1 .
3	5-LED Expander with I ² C Host Comm	12	P5	43	
3	10-LED Expander with I ² C Host Comm	12	P5	93	
4	5-LED Expander with HDQ Host Comm	13	P4	44	
4	10-LED Expander with HDQ Host Comm	13	P4	94	

The port used for the Alert output will depend on the mode setting in **LED/Comm Configuration** as defined in [Table 7-18](#). The default mode is 0. The $\overline{\text{ALERT}}$ pin will be asserted by driving LOW. However, note that in LED/COM mode 2, pin TS/P6, which has a dual purpose as temperature sense pin, will be driven low except when temperature measurements are made each second. See the reference schematic ([Figure 8-4](#)) for filter implementation details if host alert sensing requires a continuous signal.

The $\overline{\text{ALERT}}$ pin will be a logical OR of the selected bits in the new configuration register when asserted in the Flags register. The default value for Alert Configuration register is 0.

Table 7-19. Alert Configuration Register Bit Definitions

	Bit 7	Bit 6	Bit 5	Bit 4	Bit 3	Bit 2	Bit 1	Bit 0
High Byte	OTC	OTD	BATHIGH	BATLOW	CHG_INH	RSVD	FC	CHG
Low Byte	OCVTAKEN	ISD	TDD	RSVD	RSVD	SOC1	SOCF	DSG

Legend: **RSVD** = Reserved

OTC: Over-Temperature in Charge condition is detected. $\overline{\text{ALERT}}$ is enabled when set.

OTD: Over-Temperature in Discharge condition is detected. $\overline{\text{ALERT}}$ is enabled when set.

BATHIGH: Battery High bit that indicates a high battery voltage condition. Refer to the data flash **BATTERY HIGH** parameters for threshold settings. $\overline{\text{ALERT}}$ is enabled when set.

BATLOW: Battery Low bit that indicates a low battery voltage condition. Refer to the data flash **BATTERY LOW** parameters for threshold settings. $\overline{\text{ALERT}}$ is enabled when set.

CHG_INH: Charge Inhibit; unable to begin charging. Refer to the data flash [**Charge Inhibit Temp Low, Charge Inhibit Temp High**]. $\overline{\text{ALERT}}$ is enabled when set.

RSVD: Reserved. Do not use.

FC: Full charge is detected. FC is set when charge termination is reached and **FC Set%** = -1 (see [Section 7.2.10](#) for details) or **StateOfCharge()** is larger than **FC Set%** and **FC Set%** is not -1. $\overline{\text{ALERT}}$ is enabled when set.

CHG: (Fast) charging allowed. $\overline{\text{ALERT}}$ is enabled when set.

OCVTAKEN: Cleared on entry to RELAX mode and set to 1 when OCV measurement is performed in RELAX mode. $\overline{\text{ALERT}}$ is enabled when set.

ISD: Internal Short is detected. $\overline{\text{ALERT}}$ is enabled when set.

TDD: Tab Disconnect is detected. $\overline{\text{ALERT}}$ is enabled when set.

SOC1: State-of-Charge Threshold 1 reached. $\overline{\text{ALERT}}$ is enabled when set.

SOCF: State-of-Charge Threshold Final reached. $\overline{\text{ALERT}}$ is enabled when set.

DSG: Discharging detected. $\overline{\text{ALERT}}$ is enabled when set.

7.2.14 Communications

7.2.14.1 Authentication

The BQ34Z100 can act as a SHA-1/HMAC authentication slave by using its internal engine. Sending a 160-bit SHA-1 challenge message to the device will cause the IC to return a 160-bit digest, based upon the challenge message and hidden plain-text authentication keys. When this digest matches an identical one generated by a host or dedicated authentication master (operating on the same challenge message and using the same plain text keys), the authentication process is successful.

The device contains a default plain-text authentication key of 0x0123456789ABCDEFEDCBA987654321. If using the device's internal authentication engine, the default key can be used for development purposes, but should be changed to a secret key and the part immediately sealed before putting a pack into operation.

7.2.14.2 Key Programming

When the device's SHA-1/HMAC internal engine is used, authentication keys are stored as plain-text in memory. A plain-text authentication key can only be written to the device while the IC is in UNSEALED mode. Once the IC is UNSEALED, a 0x00 is written to *BlockDataControl()* to enable the authentication data commands. Next, subclass ID and offset are specified by writing 0x70 and 0x00 to *DataFlashClass()* and *DataFlashBlock()*, respectively. The device is now prepared to receive the 16-byte plain-text key, which must begin at command location 0x4C. The key is accepted once a successful checksum has been written to *BlockDataChecksum()* for the entire 32-byte block (0x40 through 0x5F), not just the 16-byte key.

7.2.14.3 Executing an Authentication Query

To execute an authentication query in UNSEALED mode, a host must first write 0x01 to the *BlockDataControl()* command to enable the authentication data commands. If in SEALED mode, 0x00 must be written to *DataFlashBlock()*.

Next, the host writes a 20-byte authentication challenge to the *AuthenticateData()* address locations (0x40 through 0x53). After a valid checksum for the challenge is written to *AuthenticateChecksum()*, the device uses the challenge to perform its own SHA-1/HMAC computation in conjunction with its programmed keys. The resulting digest is written to *AuthenticateData()*, overwriting the pre-existing challenge. The host may then read this response and compare it against the result created by its own parallel computation.

7.2.14.4 HDQ Single-Pin Serial Interface

The HDQ interface is an asynchronous return-to-one protocol where a processor sends the command code to the device. With HDQ, the least significant bit (LSB) of a data byte (command) or word (data) is transmitted first. Note that the DATA signal on pin 12 is open-drain and requires an external pull-up resistor. The 8-bit command code consists of two fields: the 7-bit HDQ command code (bits 0–6) and the 1-bit R/W field (MSB Bit 7). The R/W field directs the device either to:

- Store the next 8 or 16 bits of data to a specified register or
- Output 8 or 16 bits of data from the specified register.

The HDQ peripheral can transmit and receive data as either an HDQ master or slave.

The return-to-one data bit frame of HDQ consists of three distinct sections. The first section is used to start the transmission by either the host or by the device taking the DATA pin to a logic-low state for a time $t_{\text{STRH,B}}$. The next section is for data transmission where the data is valid for a time t_{DSU} after the negative edge used to start communication. The data is held until a time t_{DV} , allowing the host or device time to sample the data bit. The final section is used to stop the transmission by returning the DATA pin to a logic-high state by at least a time t_{SSU} after the negative edge used to start communication. The final logic-high state is held until the end of $t_{\text{CYCH,B}}$, allowing time to ensure the transmission was stopped correctly. The timing for data and break communication is shown in [Section 6.13](#).

HDQ serial communication is normally initiated by the host processor sending a break command to the device. A break is detected when the DATA pin is driven to a logic-low state for a time t_B or greater. The DATA pin should then be returned to its normal ready high logic state for a time t_{BR} . The device is now ready to receive information from the host processor.

The device is shipped in the I²C mode. TI provides tools to enable the HDQ peripheral.

7.2.14.5 I²C Interface

The gas gauge supports the standard I²C read, incremental read, one-byte write quick read, and functions. The 7-bit device address (ADDR) is the most significant 7 bits of the hex address and is fixed as 1010101. The 8-bit device address is therefore 0xAA or 0xAB for write or read, respectively.

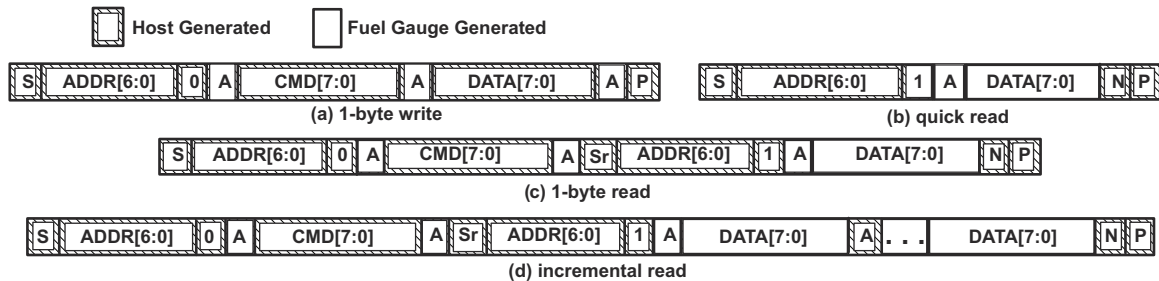

Figure 7-1. Supported I²C formats: (a) 1-byte write, (b) quick read, (c) 1 byte-read, and (d) incremental read (S = Start, Sr = Repeated Start, A = Acknowledge, N = No Acknowledge, and P = Stop).

The “quick read” returns data at the address indicated by the address pointer. The address pointer, a register internal to the I²C communication engine, increments whenever data is acknowledged by the device or the I²C master. “Quick writes” function in the same manner and are a convenient means of sending multiple bytes to consecutive command locations (such as 2-byte commands that require two bytes of data).

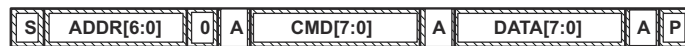

Figure 7-2. Attempt To Write a Read-Only Address (Nack After Data Sent By Master)



Figure 7-3. Attempt To Read An Address Above 0x7F (Nack Command)



Figure 7-4. Attempt At Incremental Writes (nack All Extra Data Bytes Sent)

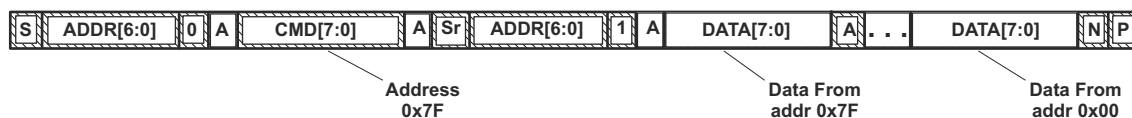

Figure 7-5. Incremental Read at the Maximum Allowed Read Address

The I²C engine releases both SDA and SCL if the I²C bus is held low for t_{BUSERR} . If the gas gauge was holding the lines, releasing them frees the master to drive the lines. If an external condition is holding either of the lines low, the I²C engine enters the low-power SLEEP mode.

7.2.15 Power Control

7.2.15.1 Reset Functions

When the device detects either a hardware or software reset (\overline{MRST} pin is driven low or the $[RESET]$ bit of $Control()$ is initiated, respectively), it determines the type of reset and increments the corresponding counter. This information is accessible by issuing the command $Control()$ function with the RESET_DATA subcommand.

As shown in Figure 7-6, if a partial reset was detected, a RAM checksum is generated and compared against the previously stored checksum. If the checksum values do not match, the RAM is reinitialized (a “Full Reset”). The stored checksum is updated every time RAM is altered.

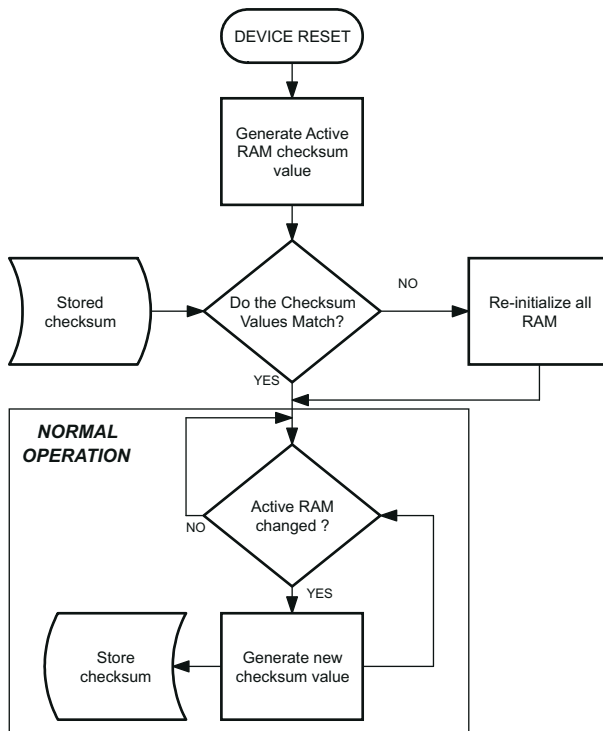

Figure 7-6. Partial Reset Flow Diagram

7.2.15.2 Wake-Up Comparator

The wake up comparator is used to indicate a change in cell current while the device is in SLEEP mode. *PackConfiguration()* uses bits [RSNS1–RSNS0] to set the sense resistor selection. *PackConfiguration()* uses the [IWAKE] bit to select one of two possible voltage threshold ranges for the given sense resistor selection. An internal interrupt is generated when the threshold is breached in either charge or discharge directions. A setting of 0x00 of RSNS1..0 disables this feature.

Table 7-20. I_{WAKE} t=Threshold Settings

RSNS1 (1)	RSNS0	IWAKE	Vth(SRP–SRN)
0	0	0	Disabled
0	0	1	Disabled
0	1	0	+1.25 mV or –1.25 mV
0	1	1	+2.5 mV or –2.5 mV
1	0	0	+2.5 mV or –2.5 mV
1	0	1	+5 mV or –5 mV
1	1	0	+5 mV or –5 mV
1	1	1	+10 mV or –10 mV

(1) The actual resistance value vs. the setting of the sense resistor is not important. Only the actual voltage threshold when calculating the configuration is important.

7.2.15.3 Flash Updates

Data flash can only be updated if $Voltage() \geq Flash\ Update\ OK\ Voltage$. Flash programming current can cause an increase in LDO dropout. The value of Flash Update OK Voltage should be selected such that the

device V_{CC} voltage does not fall below its minimum of 2.4 V during Flash write operations. The default value of 2800 mV is appropriate; however, for more information, refer to [Step 3](#).

7.3 Device Functional Modes

The device has three power modes: NORMAL mode, SLEEP mode, and FULL SLEEP mode.

- In NORMAL mode, the device is fully powered and can execute any allowable task.
- In SLEEP mode, the gas gauge exists in a reduced-power state, periodically taking measurements and performing calculations.
- In FULL SLEEP mode, the high frequency oscillator is turned off, and power consumption is further reduced compared to SLEEP mode.

7.3.1 NORMAL Mode

The gas gauge is in NORMAL mode when not in any other power mode. During this mode, *AverageCurrent()*, *Voltage()*, and *Temperature()* measurements are taken, and the interface data set is updated. Determinations to change states are also made. This mode is exited by activating a different power mode.

7.3.2 SLEEP Mode

SLEEP mode is entered automatically if the feature is enabled (**Pack Configuration [SLEEP] = 1**) and *Average Current()* is below the programmable level **Sleep Current**. Once entry to sleep has been qualified but prior to entry to SLEEP mode, the device performs an ADC autocalibration to minimize offset. Entry to SLEEP mode can be disabled by the [SLEEP] bit of *Pack Configuration()*, where 0 = disabled and 1 = enabled. During SLEEP mode, the device periodically wakes to take data measurements and updates the data set, after which it then returns directly to SLEEP. The device exits SLEEP if any entry condition is broken, a change in protection status occurs, or a current in excess of I_{WAKE} through R_{SENSE} is detected.

7.3.3 FULL SLEEP Mode

FULL SLEEP mode is entered automatically when the device is in SLEEP mode and the timer counts down to 0 (*Full Sleep Wait Time* > 0). FULL SLEEP mode is disabled when *Full Sleep Wait Time* is set to 0.

During FULL SLEEP mode, the device periodically takes data measurements and updates its data set. However, a majority of its time is spent in an idle condition.

The gauge exits the FULL SLEEP mode when there is any communication activity. Therefore, the execution of SET_FULLSLEEP sets [FULLSLEEP] bit, but the EVSW might still display the bit clear. The FULL SLEEP mode can be verified by measuring the current consumption of the gauge. In this mode, the high frequency oscillator is turned off. The power consumption is further reduced compared to the SLEEP mode.

While in FULL SLEEP mode, the fuel gauge can suspend serial communications as much as 4 ms by holding the communication line(s) low. This delay is necessary to correctly process host communication since the fuel gauge processor is mostly halted. For HDQ communication one host message will be dropped.

8 Application and Implementation

Note

Information in the following applications sections is not part of the TI component specification, and TI does not warrant its accuracy or completeness. TI's customers are responsible for determining suitability of components for their purposes, as well as validating and testing their design implementation to confirm system functionality.

8.1 Typical Applications

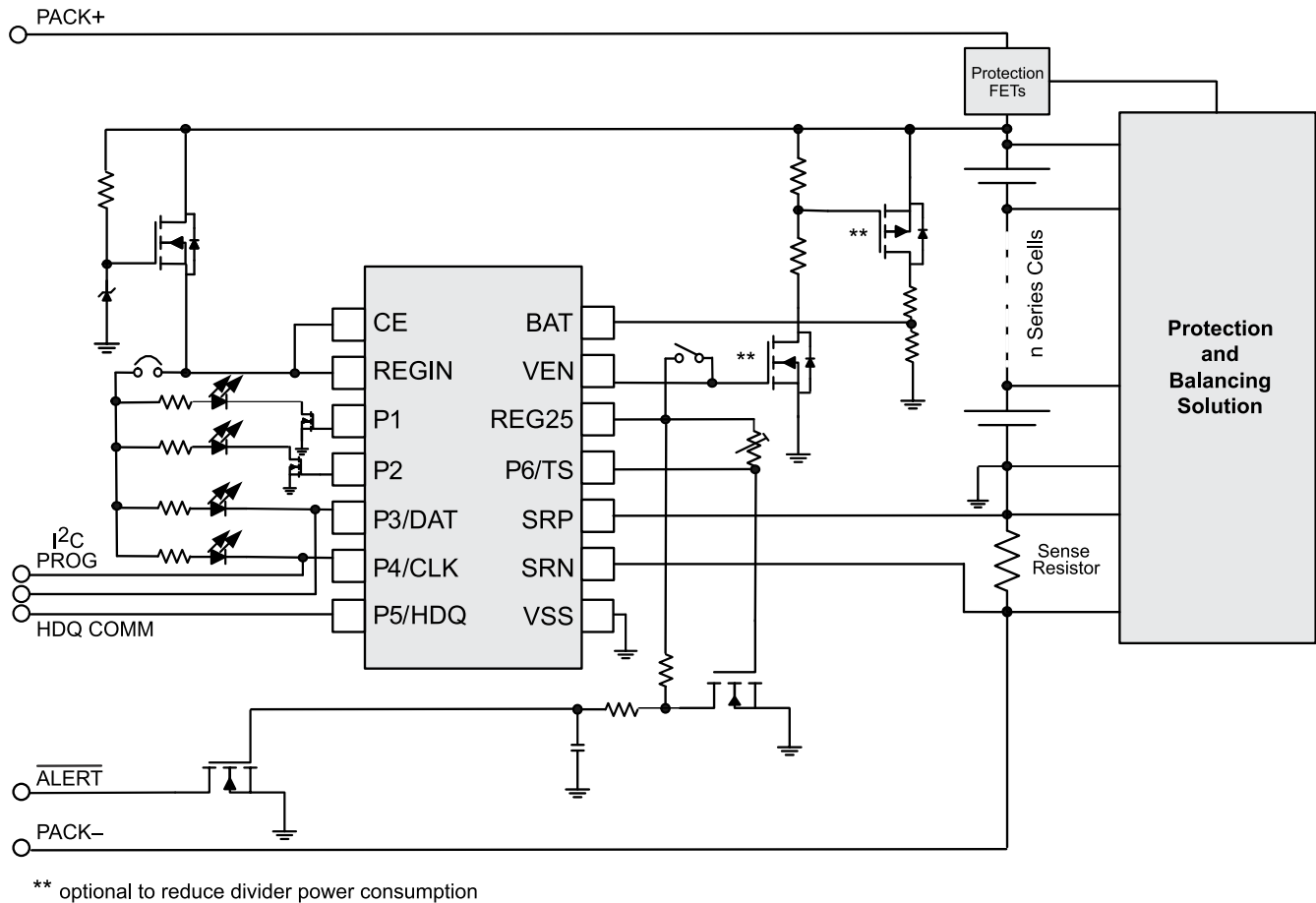

Figure 8-1. BQ34Z100 Simplified Implementation

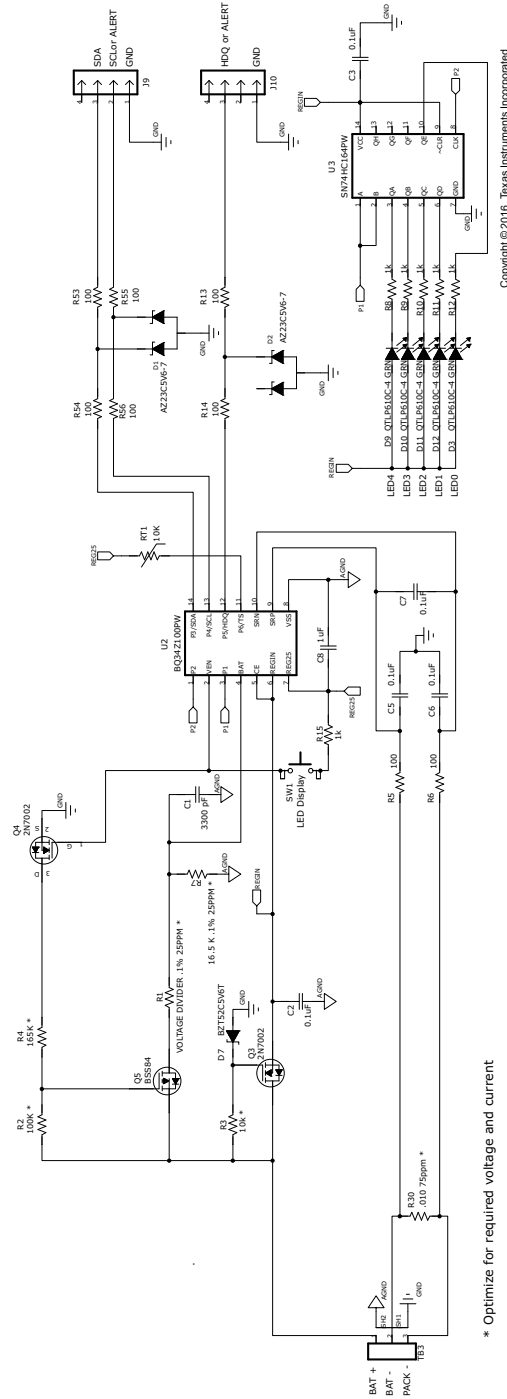

Figure 8-3. Multi-Cell and 5-LED Display

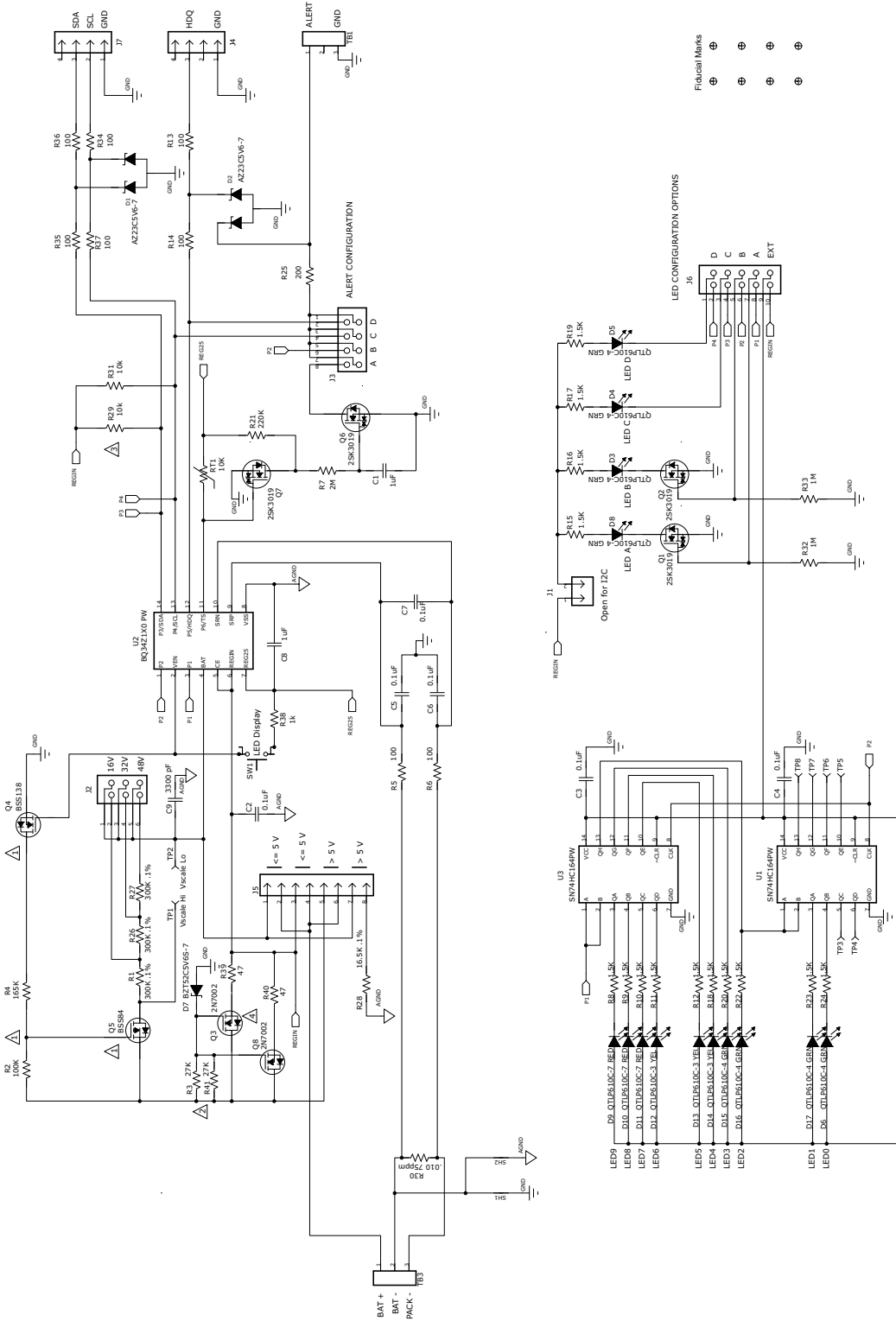

Figure 8-4. Full-Featured Evaluation Module EVM

8.1.1 Design Requirements

For additional design guidelines, refer to the *BQ34Z100 EVM Wide Range Impedance Track Enabled Battery Fuel Gauge User's Guide (SLUU904)*.

- ⚠ Optional for additional power saving
- ⚠ Adjust for minimum current consumption in the application
- ⚠ 12C pullups normally implemented in the host. Duplicated here since EV2300 does not provide
- ⚠ Optimize for required LED power dissipation

Copyright © 2016, Texas Instruments Incorporated

8.1.2 Detailed Design Procedure

8.1.2.1 Step-by-Step Design Procedure

8.1.2.1.1 STEP 1: Review and Modify the Data Flash Configuration Data.

While many of the default parameters in the data flash are suitable for most applications, the following should first be reviewed and modified to match the intended application.

- **Design Capacity:** Enter the value in mAh for the battery, even from the “design energy” point of view.
- **Design Energy:** Enter the value in mWh.
- **Cell Charge Voltage Tx-Ty:** Enter the desired cell charge voltage for each JEITA temperature range.

8.1.2.1.2 STEP 2: Review and Modify the Data Flash Configuration Registers.

- **LED_Comm Configuration:** See [Table 7-17](#) and [Table 7-18](#) to aid in selection of an LED mode. Note that the pin used for the optional Alert signal is dependent upon the LED mode selected.
- **Alert Configuration:** See [Table 7-19](#) to aid in selection of which faults will trigger the $\overline{\text{ALERT}}$ pin.
- **Number of Series Cells**
- **Pack Configuration:** Ensure that the VOLSEL bit is set for multi-cell applications and cleared for single-cell applications.

8.1.2.1.3 STEP 3: Design and Configure the Voltage Divider.

If the battery contains more than 1-s cells, a voltage divider network is required. Design the divider network, based on the formula below. The voltage division required is from the highest expected battery voltage, down to approximately 900 mV. For example, using a lower leg resistor of 16.5 K Ω where the highest expected voltage is 32000 mV:

$$R_{\text{series}} = 16.5 \text{ K}\Omega (32000 \text{ mV} - 900 \text{ mV})/900 \text{ mV} = 570.2 \text{ K}\Omega$$

Based on price and availability, a 600-K resistor or pair of 300-K resistors could be used in the top leg along with a 16.5-K resistor in the bottom leg.

Set the **Voltage Divider** in the Data Flash Calibration section of the Evaluation Software to 32000 mV.

Use the Evaluation Software to calibrate to the applied nominal voltage; for example, 24000 mV. After calibration, a slightly different value will appear in the **Voltage Divider** parameter, which can be used as a default value for the project.

Following the successful voltage calibration, calculate and apply the value to **Flash Update OK Cell Volt** as: **Flash Update OK Cell Volt** = 2800 mV \times **Number Of Series Cells** \times 5000/**Voltage Divider**.

8.1.2.1.4 STEP 4: Determine the Sense Resistor Value.

To ensure accurate current measurement, the input voltage generated across the current sense resistor should not exceed ± 125 mV. For applications with a very high dynamic range, it is allowable to extend this range to absolute maximum of ± 300 mV for overload conditions where a protector device will be taking independent protective action. In such an overloaded state, current reporting and gauging accuracy will not function correctly.

The value of the current sense resistor should be entered into both **CC Gain** and **CC Delta** parameters in the Data Flash Calibration section of the Evaluation Software.

8.1.2.1.5 STEP 5: Review and Modify the Data Flash Gas Gauging Configuration, Data, and State.

- **Load Select:** See [Table 7-10](#) and [Table 7-11](#).
- **Load Mode:** See [Table 7-10](#) and [Table 7-11](#).
- **Cell Terminate Voltage:** This is the theoretical voltage where the system will begin to fail. It is defined as zero state-of-charge. Generally a more conservative level is used in order to have some reserve capacity. Note the value is for a single cell only.
- **Quit Current:** Generally should be set to a value slightly above the expected idle current of the system.
- **Qmax Cell 0:** Start with the C-rate value of your battery.

8.1.2.1.6 STEP 6: Determine and Program the Chemical ID.

Use the BQChem feature in the Evaluation Software to select and program the chemical ID matching your cell. If no match is found, use the procedure defined in TI's ([Mathcad Chemistry Selection Tool \(SLUC138\)](#)).

8.1.2.1.7 STEP 7: Calibrate.

Follow the steps on the **Calibration** screen in the Evaluation Software. Achieving the best possible calibration is important before moving on to Step 8. For mass production, calibration is not required for single-cell applications. For multi-cell applications, only voltage calibration is required. Current and temperature may be calibrated to improve gauging accuracy if needed.

8.1.2.1.8 STEP 8: Run an Optimization Cycle.

Refer to the [Preparing Optimized Default Flash Constants for Specific Battery Types Application Report \(SLUA334B\)](#).

8.1.3 Battery Chemistry Configuration

When changing the battery chemistry, there are several configurations that need to be considered specific to each chemistry. The CHEM ID drives the majority of the changes but some do remain. These are mostly associated to the charge termination algorithm, but there are some additional registers that should be programmed based on the main chemistry type selected.

8.1.3.1 Battery Chemistry Charge Termination

The default setup of the BQ34Z100 is for Li-ion chemistries.

The charge-termination specific configurations include:

Table 8-1. Charge Termination Configurations

Class Name	Subclass Name	Parameter Name	Default Value	Units
Configuration	Charge Termination	Taper Current	100	mA
Configuration	Charge Termination	Min Taper Capacity	25	mAh
Configuration	Charge Termination	Cell Taper Voltage	100	mV
Configuration	Charge Termination	Current Taper Window	40	s

When changing to Lead Acid chemistry there are further configuration options.

Table 8-2. Configuration Options

Class Name	Subclass Name	Parameter Name	Default Value	Units
Configuration	Charge	Pb Temp Comp	25%	
Configuration	Charge	Pb Reduction Rate	10%	

When using Nickel Metal Hydride (NiMH) or Nickel Cadmium (NiCd) batteries, the charge termination criteria change significantly.

Table 8-3. NiMH and NiCd Charge Configuration Options

Class Name	Subclass Name	Parameter Name	Default Value	Units
Configuration	Charge Termination	NiMH Delta Temp	3	0.1°C
Configuration	Charge Termination	NiMH Delta Temp Time	180	s
Configuration	Charge Termination	NiMH Hold Off Time	100	s
Configuration	Charge Termination	NiMH Hold Off Current	240	mA
Configuration	Charge Termination	NiMH Hold Off Temp	25	0.1°C
Configuration	Charge Termination	NiMH Cell Negative Delta Volt	17	mV
Configuration	Charge Termination	NiMH Cell Negative Delta Time	16	s
Configuration	Charge Termination	NiMH Cell Neg Delta Qual Volt	4200	mV

To switch the charge termination criteria suitable for NiMH/NiCd, set the [NiDT] and/or [NiDV] bits. See [Section 7.2.10](#) for further details.

Where:

NiDT: Performs primary charge termination using the $\Delta T/\Delta t$ algorithm.

NiDV: Performs primary charge termination using the $-\Delta V$ algorithm.

Note

When a Nickel-based chemistry Chem ID is used, then the Li-ion/PbA charge termination method is NOT used regardless of the configuration of the NiDV and NiDT bits.

Table 8-4. Additional Chemistry-Related Configurations

Parameters	Li-ion	Lead Acid	NiMH/NiCd
Default Load Select	1	3	3
Cell Term V Delta	200	100	100
Min % Passed Chg for 1st Qmax	90	50	50

8.1.4 Replaceable Battery Systems

The BQ34Z100 is also capable of being used as a system-side gauge where the actual battery can be removed and replaced from the system. However, there are limitations to this feature. The replacing battery should be of the same chemistry and close to the original design capacity of the one to be replaced, as this ensures that the other configuration options of the device are still valid.

The BQ34Z100 is enabled to have the option to learn new Impedance Track data in larger steps through the following configuration registers:

Table 8-5. Learning Configuration Registers for Replaceable Battery Packs (Host Side Gauge)

Class Name	Subclass name	Parameter Name	Default Value	Units
Gas Gauging	IT Cfg	Max Res Factor	50	n/a
Gas Gauging	IT Cfg	Min Res Factor	1	n/a
Gas Gauging	IT Cfg	Max Res Scale	32000	n/a
Gas Gauging	IT Cfg	Min Res Scale	1	n/a
Gas Gauging	IT Cfg	Max QMAX Change	100	n/a

If the BQ34Z100 and the battery are not designed to be separated, it is recommended to make the following changes. This helps to prevent erroneous measurements from causing the Impedance Track data to be updated to extreme values.

Table 8-6. Learning Configuration Registers for Non-Removable Battery Packs

Class Name	Subclass name	Parameter Name	Value	Units
Gas Gauging	IT Cfg	Max Res Factor	15	n/a
Gas Gauging	IT Cfg	Min Res Factor	3	n/a
Gas Gauging	IT Cfg	Max Res Scale	5000	n/a
Gas Gauging	IT Cfg	Min Res Scale	200	n/a
Gas Gauging	IT Cfg	Max QMAX Change	30	n/a

8.1.5 Digital Interface Options

The default setup of the BQ34Z100 uses the I²C digital interface with the $\overline{\text{ALERT}}$ pin as an additional digital interrupt output. It is recommended to keep the device in this mode throughout development and battery production even if the single-wire HDQ interface will be used in the field. The I²C is much faster so any modifications to the device configuration and any data logging during battery evaluation or testing would be faster.

There are a series of commands required to switch between I²C and HDQ, which are detailed in this TRM.

8.1.6 Display Options

By default, the display is disabled. To setup the appropriate display, the LED/COMM Configuration data flash register needs to be programmed. Care should be taken to ensure the correct digital interface options (Communications and ALERT) are not interfered with when configuring the display. See [Section 7.2.13](#) for further details.

8.1.7 Application Curves

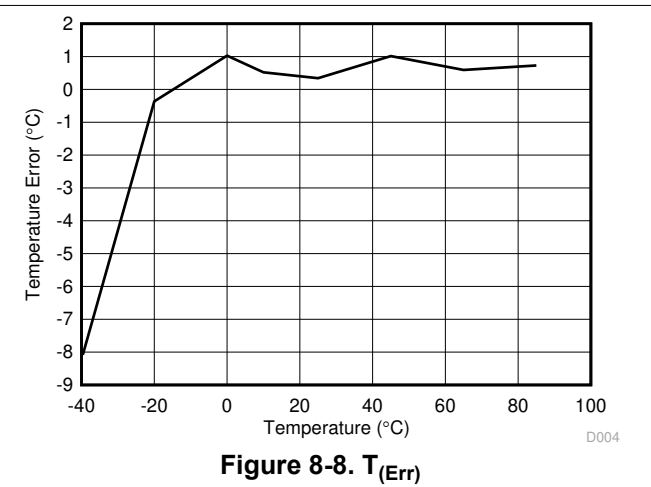
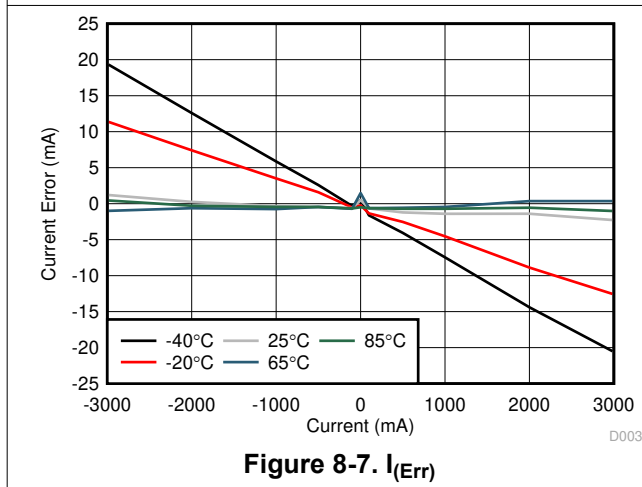
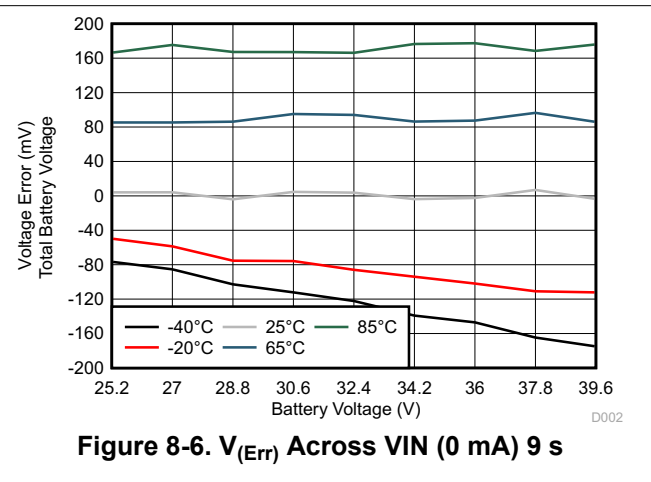
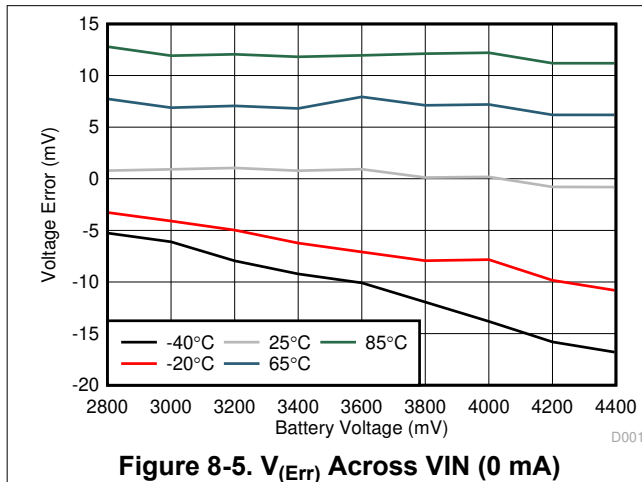

8.1.8 Special Applications

8.1.8.1 Operation Configuration B Register

Some device advanced features are rarely used. Operation Configuration registers B and C are available for configuring special applications. Default settings are recommended.

Table 8-7. Operation Configuration B Bit Definition

Bit 7	Bit 6	Bit 5	Bit 4	Bit 3	Bit 2	Bit 1	Bit 0
ChgDoDEoC	SE_TDD	VconsEN	SE_ISD	RSVD	LFPRelax	DoDWT	FConvEn

ChgDoDEoC: Enable DoD at EoC during charging only. True when set. Default is 1. Default setting is recommended.

SE_TDD: Enable Tab Disconnection Detection. True when set. Default is 1.

VconsEN: Enable voltage consistency check. True when set. Default is 1. Default setting is recommended.

SE_ISD: Enable Internal Short Detection. True when set. Default is 1.

RSVD: Reserved. Default is 1.

LFPRelax: Enable LiFePO₄ long RELAX mode when chemical ID 400 series is selected. True when set. Default is 1.

DoDWT: Enable Dod weighting for LiFePO₄ support when chemical ID 400 series is selected. True when set. Default is 1.

FConvEn: Enable fast convergence algorithm. Default is 1. Default setting is recommended.

8.1.8.2 Operation Configuration C Register

Table 8-8. Operation Configuration C Bit Definition

Bit 7	Bit 6	Bit 5	Bit 4	Bit 3	Bit 2	Bit 1	Bit 0
FastQmax	RsvdSBS	FF_Near_End	SleepWakeChg	RSVD	RSVD	RSVD	RSVD

FastQmax: Enable Fast Qmax Update mode. True when set. Default is 0. Default setting is recommended.

RsvdSBS: Enable to activate debug information in command space 0x6D ~ 0x76. For special use only. Default setting is recommended.

FF_Near_End: Enable to use a fast voltage filter near the end of discharge only. Default setting is recommended.

SleepWakeChg: Enable for faster sampling in sleep mode. Default setting is recommended.

RSVD: Reserved. Default is 0.

9 Power Supply Recommendations

Power supply requirements for the BQ34Z100 are simplified due to the presence of the internal LDO voltage regulation. The REGIN pin accepts any voltage level between 2.7 V and 4.5 V, which is optimum for a single-cell Li-ion application. For higher battery voltage applications, a simple pre-regulator can be provided to power the bq34Z100 and any optional LEDs. Decoupling the REGIN pin should be done with a 0.1- μ F 10% ceramic X5R capacitor placed close to the device. While the pre-regulator circuit is not critical, special attention should be paid to its quiescent current and power dissipation. The input voltage should handle the maximum battery stack voltage. The output voltage can be centered within the 2.7-V to 4.5-V range as recommended for the REGIN pin.

For high stack count applications, a commercially available LDO is often the best quality solution, but comes with a cost tradeoff. To lower the BOM cost, the following approaches are recommended.

In [Figure 9-1](#), Q1 is used to drop the battery stack voltage to roughly 4 V to power the BQ34Z100 REGIN pin and also to feed the anode of any LEDs used in the application. To avoid unwanted quiescent current consumption, R1 should be set as high as is practical. It is recommended to use a low-current Zener diode.

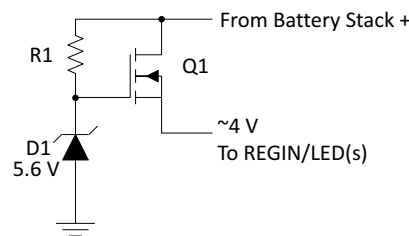

Figure 9-1. Q1 Dropping Battery Stack Voltage to 4 V

Alternatively, if the range of a high-voltage battery stack can be well defined, a simple source follower based on a resistive divider can be used to lower the BOM cost and the quiescent current. For example:

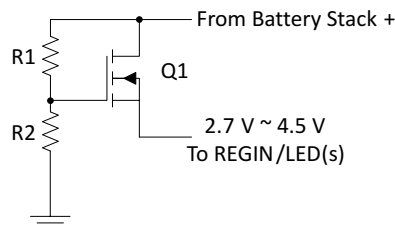

Figure 9-2. Source Follower on a Resistive Divider

Power dissipation of the linear pre-regulator may become an important design decision when multiple LEDs are employed in the application. For example, the BQ34Z100 EVM uses a pair of FETs in parallel to inexpensively dissipate enough power for 10-LED evaluation.

10 Layout

10.1 Layout Guidelines

10.1.1 Introduction

Attention to layout is critical to the success of any battery management circuit board. The mixture of high-current paths with an ultralow-current microcontroller creates the potential for design issues that are not always trivial to solve. Some of the key areas of concern are described in the following sections, and can help to enable success.

10.1.2 Power Supply Decoupling Capacitor

Power supply decoupling from VCC to ground is important for optimal operation of the gas gauge. To keep the loop area small, place this capacitor next to the IC and use the shortest possible traces. A large loop area renders the capacitor useless and forms a small-loop antenna for noise pickup.

Ideally, the traces on each side of the capacitor should be the same length and run in the same direction to avoid differential noise during ESD. If possible, place a via near the VSS pin to a ground plane layer.

10.1.3 Capacitors

Power supply decoupling for the gas gauges requires a pair of 0.1- μ F ceramic capacitors for (BAT) and (VCC) pins. These should be placed reasonably close to the IC without using long traces back to VSS. The LDO voltage regulator, whether external or internal to the main IC, requires a 0.47- μ F ceramic capacitor to be placed fairly close to the regulation output pin. This capacitor is for amplifier loop stabilization and as an energy well for the 2.5-V supply.

10.1.4 Communication Line Protection Components

The 5.6-V Zener diodes, used to protect the communication pins of the gas gauge from ESD, should be located as close as possible to the pack connector. The grounded end of these Zener diodes should be returned to the Pack(–) node rather than to the low-current digital ground system. This way, ESD is diverted away from the sensitive electronics as much as possible.

In some applications, it is sometimes necessary to cause transitions on the communication lines to trigger events that manage the gas gauge power modes. An example of one of these transitions is detecting a sustained low logic level on the communication lines to detect that a pack has been removed. Given that most of the gas gauges do not have internal pulldown networks, it is necessary to add a weak pulldown resistor to accomplish this when there's an absence of a strong pullup resistor on the system side. If the weak pulldown resistor is used, it may take less board space to use a small capacitor in parallel instead of the Zener diode to absorb any ESD transients that are received through communication lines.

10.2 Layout Example

10.2.1 Ground System

The gas gauge requires a low-current ground system separate from the high-current PACK(–) path. ESD ground is defined along the high-current path from the PACK(–) terminal to low-side protector FETs (if present) or the sense resistor. It is important that the low-current ground systems only connect to the BAT(–) path at the sense resistor Kelvin pick-off point. It is recommended to use an optional inner layer ground plane for the low-current ground system. In [Figure 10-1](#), the green is an example of using the low-current ground as a shield for the gas gauge circuit. Notice how it is kept separate from the high-current ground, which is shown in red. The high-current path is joined with the low-current path only at one point, shown with the small blue connection between the two planes.

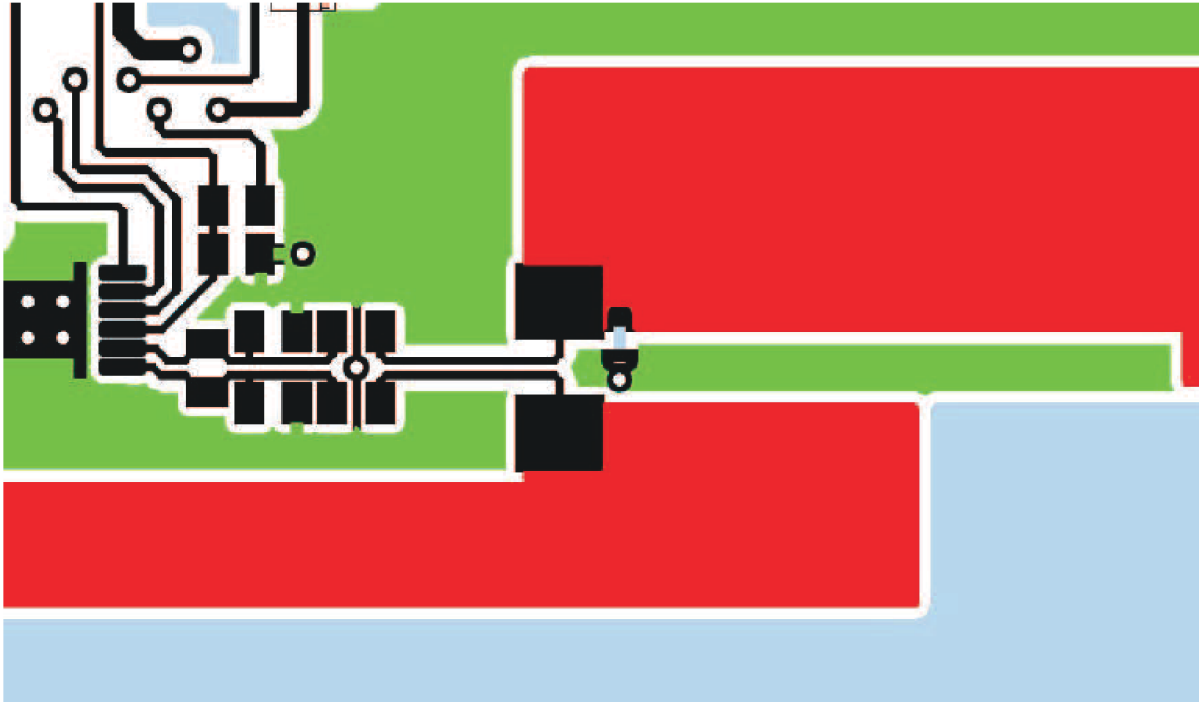

Figure 10-1. Differential Filter Component with Symmetrical Layout

10.2.2 Kelvin Connections

Kelvin voltage sensing is very important to accurately measure current and cell voltage. Notice how the differential connections at the sense resistor do not add any voltage drop across the copper etch that carries the high current path through the sense resistor. See [Figure 10-1](#) and [Figure 10-2](#).

10.2.3 Board Offset Considerations

Although the most important component for board offset reduction is the decoupling capacitor for V_{CC} , additional benefit is possible by using this recommended pattern for the coulomb counter differential low-pass filter network. Maintain the symmetrical placement pattern shown for optimum current offset performance. Use symmetrical shielded differential traces, if possible, from the sense resistor to the 100- Ω resistors, as shown in [Figure 10-2](#).

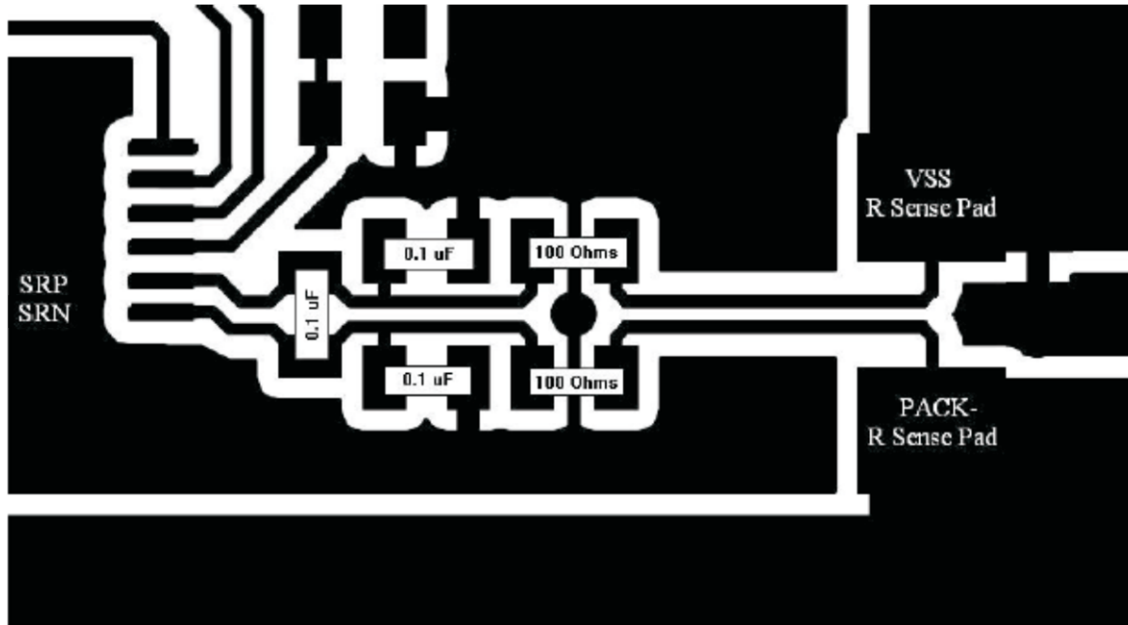

Figure 10-2. Differential Connection Between SRP and SRN Pins with Sense Resistor

10.2.4 ESD Spark Gap

Protect the communication lines from ESD with a spark gap at the connector. Figure 10-3 shows the recommended pattern with its 0.2-mm spacing between the points.

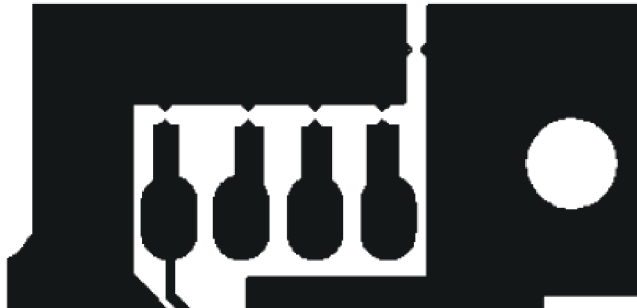

Figure 10-3. Recommended Spark-Gap Pattern Helps Protect Communication Lines from ESD

11 Device and Documentation Support

11.1 Documentation Support

11.1.1 Related Documentation

For design guidelines, refer to the [BQ34Z100EVM Wide Range Impedance Track Enabled Battery Fuel Gauge User's Guide \(SLUU904\)](#).

11.2 Receiving Notification of Documentation Updates

To receive notification of documentation updates, navigate to the device product folder on [ti.com](#). Click on *Subscribe to updates* to register and receive a weekly digest of any product information that has changed. For change details, review the revision history included in any revised document.

11.3 Support Resources

[TI E2E™ support forums](#) are an engineer's go-to source for fast, verified answers and design help — straight from the experts. Search existing answers or ask your own question to get the quick design help you need.

Linked content is provided "AS IS" by the respective contributors. They do not constitute TI specifications and do not necessarily reflect TI's views; see TI's [Terms of Use](#).

11.4 Trademarks

Impedance Track™ is a trademark of Texas Instruments.

TI E2E™ is a trademark of Texas Instruments.

All trademarks are the property of their respective owners.

11.5 Electrostatic Discharge Caution



This integrated circuit can be damaged by ESD. Texas Instruments recommends that all integrated circuits be handled with appropriate precautions. Failure to observe proper handling and installation procedures can cause damage.

ESD damage can range from subtle performance degradation to complete device failure. Precision integrated circuits may be more susceptible to damage because very small parametric changes could cause the device not to meet its published specifications.

11.6 Glossary

[TI Glossary](#) This glossary lists and explains terms, acronyms, and definitions.

12 Mechanical, Packaging, and Orderable Information

The following pages include mechanical, packaging, and orderable information. This information is the most current data available for the designated devices. This data is subject to change without notice and revision of this document. For browser-based versions of this data sheet, refer to the left-hand navigation.

PACKAGING INFORMATION

Orderable part number	Status (1)	Material type (2)	Package Pins	Package qty Carrier	RoHS (3)	Lead finish/ Ball material (4)	MSL rating/ Peak reflow (5)	Op temp (°C)	Part marking (6)
BQ34Z100PW	Active	Production	TSSOP (PW) 14	90 TUBE	Yes	NIPDAU	Level-2-260C-1 YEAR	-40 to 85	34Z100
BQ34Z100PW.B	Active	Production	TSSOP (PW) 14	90 TUBE	Yes	NIPDAU	Level-2-260C-1 YEAR	-40 to 85	34Z100
BQ34Z100PWR	Active	Production	TSSOP (PW) 14	2000 LARGE T&R	Yes	NIPDAU	Level-2-260C-1 YEAR	-40 to 85	34Z100
BQ34Z100PWR.B	Active	Production	TSSOP (PW) 14	2000 LARGE T&R	Yes	NIPDAU	Level-2-260C-1 YEAR	-40 to 85	34Z100

(1) **Status:** For more details on status, see our [product life cycle](#).

(2) **Material type:** When designated, preproduction parts are prototypes/experimental devices, and are not yet approved or released for full production. Testing and final process, including without limitation quality assurance, reliability performance testing, and/or process qualification, may not yet be complete, and this item is subject to further changes or possible discontinuation. If available for ordering, purchases will be subject to an additional waiver at checkout, and are intended for early internal evaluation purposes only. These items are sold without warranties of any kind.

(3) **RoHS values:** Yes, No, RoHS Exempt. See the [TI RoHS Statement](#) for additional information and value definition.

(4) **Lead finish/Ball material:** Parts may have multiple material finish options. Finish options are separated by a vertical ruled line. Lead finish/Ball material values may wrap to two lines if the finish value exceeds the maximum column width.

(5) **MSL rating/Peak reflow:** The moisture sensitivity level ratings and peak solder (reflow) temperatures. In the event that a part has multiple moisture sensitivity ratings, only the lowest level per JEDEC standards is shown. Refer to the shipping label for the actual reflow temperature that will be used to mount the part to the printed circuit board.

(6) **Part marking:** There may be an additional marking, which relates to the logo, the lot trace code information, or the environmental category of the part.

Multiple part markings will be inside parentheses. Only one part marking contained in parentheses and separated by a "~" will appear on a part. If a line is indented then it is a continuation of the previous line and the two combined represent the entire part marking for that device.

Important Information and Disclaimer: The information provided on this page represents TI's knowledge and belief as of the date that it is provided. TI bases its knowledge and belief on information provided by third parties, and makes no representation or warranty as to the accuracy of such information. Efforts are underway to better integrate information from third parties. TI has taken and continues to take reasonable steps to provide representative and accurate information but may not have conducted destructive testing or chemical analysis on incoming materials and chemicals. TI and TI suppliers consider certain information to be proprietary, and thus CAS numbers and other limited information may not be available for release.

In no event shall TI's liability arising out of such information exceed the total purchase price of the TI part(s) at issue in this document sold by TI to Customer on an annual basis.

TAPE AND REEL INFORMATION

QUADRANT ASSIGNMENTS FOR PIN 1 ORIENTATION IN TAPE

*All dimensions are nominal

Device	Package Type	Package Drawing	Pins	SPQ	Reel Diameter (mm)	Reel Width W1 (mm)	A0 (mm)	B0 (mm)	K0 (mm)	P1 (mm)	W (mm)	Pin1 Quadrant
BQ34Z100PWR	TSSOP	PW	14	2000	330.0	12.4	6.9	5.6	1.6	8.0	12.0	Q1

TAPE AND REEL BOX DIMENSIONS

*All dimensions are nominal

Device	Package Type	Package Drawing	Pins	SPQ	Length (mm)	Width (mm)	Height (mm)
BQ34Z100PWR	TSSOP	PW	14	2000	367.0	367.0	38.0

TUBE

*All dimensions are nominal

Device	Package Name	Package Type	Pins	SPQ	L (mm)	W (mm)	T (μm)	B (mm)
BQ34Z100PW	PW	TSSOP	14	90	530	10.2	3600	3.5
BQ34Z100PW.B	PW	TSSOP	14	90	530	10.2	3600	3.5

PW0014A



PACKAGE OUTLINE
TSSOP - 1.2 mm max height

SMALL OUTLINE PACKAGE



4220202/B 12/2023

NOTES:

1. All linear dimensions are in millimeters. Any dimensions in parenthesis are for reference only. Dimensioning and tolerancing per ASME Y14.5M.
2. This drawing is subject to change without notice.
3. This dimension does not include mold flash, protrusions, or gate burrs. Mold flash, protrusions, or gate burrs shall not exceed 0.15 mm per side.
4. This dimension does not include interlead flash. Interlead flash shall not exceed 0.25 mm per side.
5. Reference JEDEC registration MO-153.

EXAMPLE BOARD LAYOUT

PW0014A

TSSOP - 1.2 mm max height

SMALL OUTLINE PACKAGE



LAND PATTERN EXAMPLE
EXPOSED METAL SHOWN
SCALE: 10X



4220202/B 12/2023

NOTES: (continued)

- 6. Publication IPC-7351 may have alternate designs.
- 7. Solder mask tolerances between and around signal pads can vary based on board fabrication site.

EXAMPLE STENCIL DESIGN

PW0014A

TSSOP - 1.2 mm max height

SMALL OUTLINE PACKAGE



SOLDER PASTE EXAMPLE
BASED ON 0.125 mm THICK STENCIL
SCALE: 10X

4220202/B 12/2023

NOTES: (continued)

- 8. Laser cutting apertures with trapezoidal walls and rounded corners may offer better paste release. IPC-7525 may have alternate design recommendations.
- 9. Board assembly site may have different recommendations for stencil design.

IMPORTANT NOTICE AND DISCLAIMER

TI PROVIDES TECHNICAL AND RELIABILITY DATA (INCLUDING DATASHEETS), DESIGN RESOURCES (INCLUDING REFERENCE DESIGNS), APPLICATION OR OTHER DESIGN ADVICE, WEB TOOLS, SAFETY INFORMATION, AND OTHER RESOURCES "AS IS" AND WITH ALL FAULTS, AND DISCLAIMS ALL WARRANTIES, EXPRESS AND IMPLIED, INCLUDING WITHOUT LIMITATION ANY IMPLIED WARRANTIES OF MERCHANTABILITY, FITNESS FOR A PARTICULAR PURPOSE OR NON-INFRINGEMENT OF THIRD PARTY INTELLECTUAL PROPERTY RIGHTS.

These resources are intended for skilled developers designing with TI products. You are solely responsible for (1) selecting the appropriate TI products for your application, (2) designing, validating and testing your application, and (3) ensuring your application meets applicable standards, and any other safety, security, regulatory or other requirements.

These resources are subject to change without notice. TI grants you permission to use these resources only for development of an application that uses the TI products described in the resource. Other reproduction and display of these resources is prohibited. No license is granted to any other TI intellectual property right or to any third party intellectual property right. TI disclaims responsibility for, and you fully indemnify TI and its representatives against any claims, damages, costs, losses, and liabilities arising out of your use of these resources.

TI's products are provided subject to [TI's Terms of Sale](#), [TI's General Quality Guidelines](#), or other applicable terms available either on ti.com or provided in conjunction with such TI products. TI's provision of these resources does not expand or otherwise alter TI's applicable warranties or warranty disclaimers for TI products. Unless TI explicitly designates a product as custom or customer-specified, TI products are standard, catalog, general purpose devices.

TI objects to and rejects any additional or different terms you may propose.

Copyright © 2025, Texas Instruments Incorporated

Last updated 10/2025