

# AMC1301 高精度、±250mV 入力、強化絶縁型アンプ

## 1 特長

- シャント抵抗を用いた電流測定用に最適化された  $\pm 250\text{mV}$  の入力電圧範囲
- 固定ゲイン:  $8.2\text{V/V}$
- 小さい DC 誤差:
  - オフセット誤差:  $\pm 0.2\text{mV}$  (最大値)
  - オフセット・ドリフト:  $\pm 3\mu\text{V}/^\circ\text{C}$  (最大値)
  - ゲイン誤差:  $\pm 0.3\%$  (最大値)
  - ゲイン・ドリフト:  $\pm 50\text{ppm}/^\circ\text{C}$  (最大値)
  - 非線形性:  $0.03\%$  (最大値)
- ハイサイド、ローサイドとも  $3.3\text{V}$  で動作可能
- システム・レベル診断機能
- 安全関連認証:
  - DIN EN IEC 60747-17 (VDE 0884-17) に準拠した強化絶縁耐圧:  $7070\text{V}_{\text{PK}}$
  - UL1577 に準拠した絶縁耐圧:  $5000\text{V}_{\text{RMS}}$  (1 分間)
- 拡張産業用温度範囲全体にわたって仕様を完全に規定:  $-40^\circ\text{C} \sim +125^\circ\text{C}$

## 2 アプリケーション

- 次のような機器で使用するシャント抵抗方式電流センシング:
  - モーター・ドライブ
  - 周波数インバータ
  - 無停電電源

## 3 説明

AMC1301 は高精度の絶縁型アンプで、磁気干渉に対して高い耐性のある絶縁バリアにより、入力側と出力側の回路が分離されています。このバリアは、DIN EN IEC 60747-17 (VDE 0884-17) および UL1577 規格に従って最大  $7070\text{V}_{\text{PEAK}}$  の強化絶縁を達成していることが認証され、最大  $1\text{kV}_{\text{RMS}}$  の動作電圧に対応しています。

この絶縁バリアは、異なる同相電圧レベルで動作するシステム領域を分離し、電氣的損傷を生じさせる可能性がある電圧やオペレータに害を及ぼす可能性がある電圧から低電圧側を保護します。

AMC1301 の入力は、シャント抵抗またはその他の低電圧レベルの信号源と直接接続するように最適化されています。優れた DC 精度と低い温度ドリフトから、オンボード・チャージャ (OBC)、DC/DC コンバータ、周波数インバータ、その他の高電圧アプリケーションで、正確な電流制御を実現できます。AMC1301 には、同相モード過電圧検知およびハイサイド電源電圧喪失検知の機能が内蔵されているため、システム・レベルの設計と診断が簡単になります。

AMC1301 デバイスは、拡張工業用温度範囲の  $-40^\circ\text{C} \sim +125^\circ\text{C}$  で完全に動作が規定されており、幅広の 8 ピン SOIC (DWV) パッケージで供給されます。AMC1301S は、 $-55^\circ\text{C} \sim +125^\circ\text{C}$  の温度範囲で動作が規定されています。

### パッケージ情報

部品番号	パッケージ (1)	本体サイズ (公称)
AMC1301	DWV (SOIC, 8)	5.85mm × 7.50mm

(1) 利用可能なすべてのパッケージについては、このデータシートの末尾にある注文情報を参照してください。

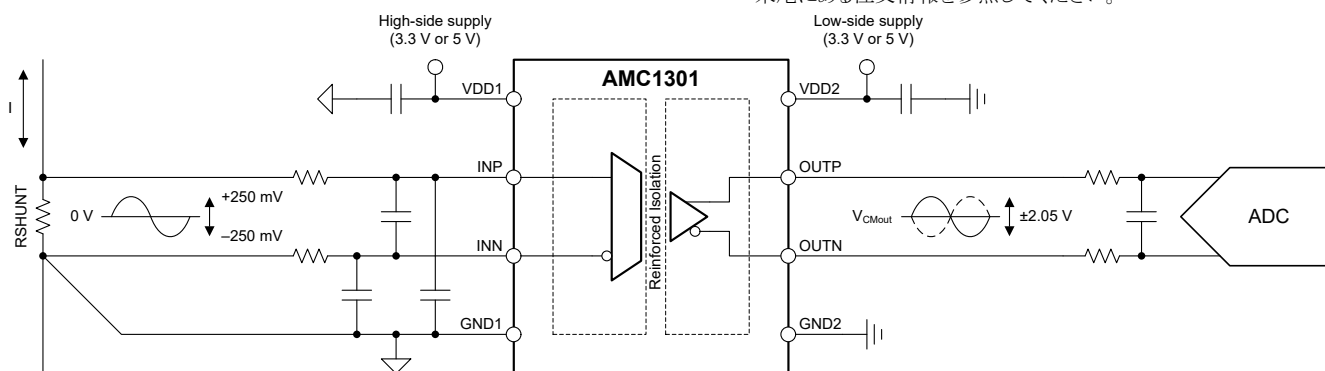

簡略回路図



## Table of Contents

<b>1 特長</b> .....	1	7.1 Overview.....	19
<b>2 アプリケーション</b> .....	1	7.2 Functional Block Diagram.....	19
<b>3 説明</b> .....	1	7.3 Feature Description.....	19
<b>4 Revision History</b> .....	2	7.4 Device Functional Modes.....	21
<b>5 Pin Configuration and Functions</b> .....	4	<b>8 Application and Implementation</b> .....	22
<b>6 Specifications</b> .....	5	8.1 Application Information.....	22
6.1 Absolute Maximum Ratings.....	5	8.2 Typical Application.....	22
6.2 ESD Ratings.....	5	8.3 Best Design Practices.....	25
6.3 Recommended Operating Conditions.....	5	8.4 Power Supply Recommendations.....	25
6.4 Thermal Information.....	6	8.5 Layout.....	26
6.5 Power Ratings.....	6	<b>9 Device and Documentation Support</b> .....	27
6.6 Insulation Specifications.....	7	9.1 Documentation Support.....	27
6.7 Safety-Related Certifications.....	8	9.2 ドキュメントの更新通知を受け取る方法.....	27
6.8 Safety Limiting Values.....	8	9.3 サポート・リソース.....	27
6.9 Electrical Characteristics.....	9	9.4 Trademarks.....	27
6.10 Switching Characteristics.....	10	9.5 静電気放電に関する注意事項.....	27
6.11 Timing Diagram.....	10	9.6 用語集.....	27
6.12 Insulation Characteristics Curves.....	11	<b>10 Mechanical, Packaging, and Orderable Information</b> .....	27
6.13 Typical Characteristics.....	12		
<b>7 Detailed Description</b> .....	19		

## 4 Revision History

資料番号末尾の英字は改訂を表しています。その改訂履歴は英語版に準じています。

### Changes from March 14, 2023 to April 24, 2023 (from Revision F (April 2020) to Revision G (April 2023))

	Page
ドキュメントのタイトルを変更.....	1
「特長」セクションを変更 箇条書き項目を変更、削除、再編成.....	1
絶縁規格を DIN VDE V 0884-11 (VDE V 0884-10) から DIN EN IEC 60747-17 (VDE 0884-17) に変更し、それに 応じて「絶縁仕様」と「安全関連認証」の表を更新.....	1
「特長」セクションの最後の箇条書き項目を削除.....	1
「概要」セクションを変更し、既知のベスト・プラクティスとして同相デカップリング・コンデンサを追加.....	1
Changed pin names VINP to INP, VINN to INN, VOUTP to OUTP, and VOUTN to OUTN throughout document.....	4
Changed <i>Description</i> column and added footnotes to <i>Pin Functions</i> table.....	4
Changed CDM ESD standard from JESD22-C101 to JEDEC JS-002.....	5
Changed PD from 81.4 mW to 99 mW.....	6
Changed PD1 (VDD1 = 3.3 V) from 24.85 mW to 31 mW.....	6
Changed PD1 (VDD1 = 5.5 V) from 45.65 mW to 54 mW.....	6
Changed PD2 (VDD2 = 3.3 V) from 20.16 mW to 26 mW.....	6
Changed PD2 (VDD2 = 5.5 V) from 35.75 mW to 45 mW.....	6
Changed DTI from $\geq 0.027$ mm to $\geq 0.021$ mm in <i>Insulation Specifications</i> table.....	7
Changed IDD1 (3.0 V $\leq$ VDD1 $\leq$ 3.6 V) from 5.0 mA (typ) / 6.9 mA (max) to 6.3 mA (typ) / 8.5 mA (max).....	9
Changed IDD1 (4.5 V $\leq$ VDD1 $\leq$ 5.5 V) from 5.9 mA (typ) / 8.3 mA (max) to 7.2 mA (typ) / 9.8 mA (max).....	9
Changed IDD2 (3.0 V $\leq$ VDD2 $\leq$ 3.6 V) from 4.4 mA (typ) / 5.6 mA (max) to 5.3 mA (typ) / 7.2 mA (max).....	9
Changed IDD2 (4.5 V $\leq$ VDD2 $\leq$ 5.5 V) from 4.8 mA (typ) / 6.5 mA (max) to 5.9 mA (typ) / 8.1 mA (max).....	9
Changed <i>Timing Diagram</i> section.....	10
Changed <i>Overview</i> section.....	19
Changed <i>Functional Block Diagram</i> image.....	19
Changed the <i>Analog Input</i> section.....	19
Added the <i>Isolation Channel Signal Transmission</i> section.....	20
Added <i>Analog Output</i> section, deleted <i>Fail-Safe Output</i> section.....	21

• Changed <i>Device Functional Modes</i> section.....	21
• Changed <i>Application Information</i> section.....	22
• Changed <i>Typical Application</i> section.....	22
• Changed <i>Best Design Practices</i> section.....	25
• Changed <i>Power Supply Recommendations</i> section.....	25
• Changed the <i>Recommended Layout of the AMC1301</i> figure.....	26
• Added a link to the <i>Isolated Voltage-Measurement Circuit</i> in the <i>Related Documentation</i> section.....	27

---

<b>Changes from Revision E (March 2018) to Revision F (April 2020)</b>	<b>Page</b>
--	-------------

---

• 安全関連認証の詳細を ISO 規格に合わせて変更.....	1
• IEC 60950-1 および IEC60065 を IEC 62368-1 に変更 .....	1
• 「概要」セクションの「VDE V 0884-10」を「VDE V 0884-11」に変更 .....	1
• Changed $T_A$ parameter from <i>specified</i> to <i>operating</i> in <i>Device Comparison Table</i> .....	4
• Changed CLR and CPG values from 9 mm to 8.5 mm.....	7
• Changed <i>Insulation Specifications</i> table per ISO standard.....	7
• Changed <i>Safety-Related Certifications</i> table per ISO standard.....	8
• Changed <i>Safety Limiting Values</i> description as per ISO standard.....	8
• Changed <i>Rise and Fall Time Test Waveforms</i> figure.....	10
• Changed <i>Delay Time Test Waveforms</i> figure.....	10
• Changed <i>Functional Block Diagram</i> figure.....	19

---

## Device Comparison Table

PARAMETER	AMC1301S	AMC1301
Operating ambient temperature, $T_A$	-55°C to +125°C	-40°C to +125°C
Input offset drift, $TCV_{OS}$	$\pm 4 \mu V/^\circ C$ (max)	$\pm 3 \mu V/^\circ C$ (max)
Gain error drift, $TCE_G$	$\pm 60 \text{ ppm}/^\circ C$ (max)	$\pm 50 \text{ ppm}/^\circ C$ (max)

## 5 Pin Configuration and Functions



图 5-1. DWV Package, 8-Pin SOIC (Top View)

表 5-1. Pin Functions

PIN		TYPE	DESCRIPTION
NO.	NAME		
1	VDD1	High-side power	High-side power supply. <sup>(1)</sup>
2	INP	Analog input	Noninverting analog input. Either INP or INN must have a DC current path to GND1 to define the common-mode input voltage. <sup>(2)</sup>
3	INN	Analog input	Inverting analog input. Either INP or INN must have a DC current path to GND1 to define the common-mode input voltage. <sup>(2)</sup>
4	GND1	High-side ground	High-side analog ground.
5	GND2	Low-side ground	Low-side analog ground.
6	OUTN	Analog output	Inverting analog output.
7	OUTP	Analog output	Noninverting analog output.
8	VDD2	Low-side power	Low-side power supply. <sup>(1)</sup>

(1) See the [Power Supply Recommendations](#) section for power-supply decoupling recommendations.

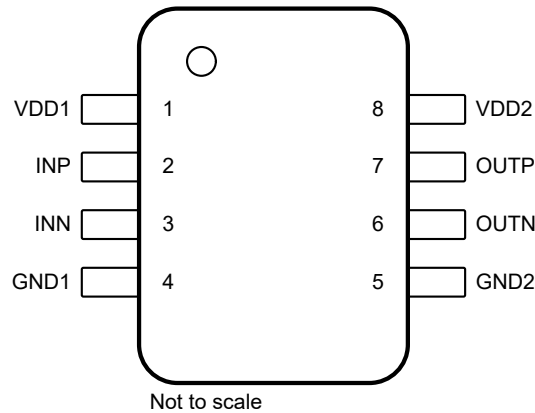
(2) See the [Layout](#) section for details.

## 6 Specifications

### 6.1 Absolute Maximum Ratings

see<sup>(1)</sup>

		MIN	MAX	UNIT
Power-supply voltage	High-side VDD1 to GND1	-0.3	7	V
	Low-side VDD2 to GND2	-0.3	7	
Analog input voltage	INP, INN	GND1 – 6	VDD1 + 0.5	V
Input current	Continuous, any pin except power-supply pins	-10	10	mA
Temperature	Junction, T <sub>J</sub>		150	°C
	Storage, T <sub>stg</sub>	-65	150	

- (1) Operation outside the *Absolute Maximum Ratings* may cause permanent device damage. *Absolute Maximum Ratings* do not imply functional operation of the device at these or any other conditions beyond those listed under *Recommended Operating Conditions*. If used outside the Recommended Operating Conditions but within the Absolute Maximum Ratings, the device may not be fully functional, and this may affect device reliability, functionality, performance, and shorten the device lifetime

### 6.2 ESD Ratings

			VALUE	UNIT
V <sub>(ESD)</sub>	Electrostatic discharge	Human-body model (HBM), per ANSI/ESDA/JEDEC JS-001 <sup>(1)</sup>	±2000	V
		Charged-device model (CDM), per ANSI/ESDA/JEDEC JS-002 <sup>(2)</sup>	±1000	

- (1) JEDEC document JEP155 states that 500-V HBM allows safe manufacturing with a standard ESD control process.  
(2) JEDEC document JEP157 states that 250-V CDM allows safe manufacturing with a standard ESD control process.

### 6.3 Recommended Operating Conditions

over operating ambient temperature range (unless otherwise noted)

			MIN	NOM	MAX	UNIT
<b>POWER SUPPLY</b>						
	High-side power supply	VDD1 to GND1	3	5	5.5	V
	Low-side power supply	VDD2 to GND2	3	3.3	5.5	V
<b>ANALOG INPUT</b>						
V <sub>Clipping</sub>	Differential input voltage before clipping output	V <sub>IN</sub> = V <sub>INP</sub> – V <sub>INN</sub>	±302.7			mV
V <sub>FSR</sub>	Specified linear differential full-scale voltage	V <sub>IN</sub> = V <sub>INP</sub> – V <sub>INN</sub>	-250		250	mV
	Absolute common-mode input voltage <sup>(1)</sup>	(V <sub>INP</sub> + V <sub>INN</sub> ) / 2 to GND1	-2		VDD1	V
V <sub>CM</sub>	Operating common-mode input voltage	(V <sub>INP</sub> + V <sub>INN</sub> ) / 2 to GND1	-0.16		VDD1 – 2.1	V
<b>TEMPERATURE RANGE</b>						
T <sub>A</sub>	Specified ambient temperature	AMC1301	-40		125	°C
		AMC1301S	-55		125	

- (1) Steady-state voltage supported by the device in case of a system failure. See specified common-mode input voltage V<sub>CM</sub> for normal operation. Observe analog input voltage range as specified in *Absolute Maximum Ratings* table.

## 6.4 Thermal Information

THERMAL METRIC <sup>(1)</sup>		DWV (SOIC)	UNIT
		8 PINS	
R <sub>θJA</sub>	Junction-to-ambient thermal resistance	110.1	°C/W
R <sub>θJC(top)</sub>	Junction-to-case (top) thermal resistance	51.7	°C/W
R <sub>θJB</sub>	Junction-to-board thermal resistance	66.4	°C/W
Ψ <sub>JT</sub>	Junction-to-top characterization parameter	16.0	°C/W
Ψ <sub>JB</sub>	Junction-to-board characterization parameter	64.5	°C/W
R <sub>θJC(bot)</sub>	Junction-to-case (bottom) thermal resistance	N/A	°C/W

(1) For more information about traditional and new thermal metrics, see the [Semiconductor and IC Package Thermal Metrics](#) application report.

## 6.5 Power Ratings

PARAMETER		TEST CONDITIONS	VALUE	UNIT
P <sub>D</sub>	Maximum power dissipation (both sides)	VDD1 = VDD2 = 5.5 V	99	mW
P <sub>D1</sub>	Maximum power dissipation (high-side)	VDD1 = 3.6 V	31	mW
		VDD1 = 5.5 V	54	
P <sub>D2</sub>	Maximum power dissipation (low-side)	VDD2 = 3.6 V	26	mW
		VDD2 = 5.5 V	45	

## 6.6 Insulation Specifications

over operating ambient temperature range (unless otherwise noted)

PARAMETER		TEST CONDITIONS	VALUE	UNIT
<b>GENERAL</b>				
CLR	External clearance <sup>(1)</sup>	Shortest pin-to-pin distance through air	≥ 8.5	mm
CPG	External creepage <sup>(1)</sup>	Shortest pin-to-pin distance across the package surface	≥ 8.5	mm
DTI	Distance through insulation	Minimum internal gap (internal clearance) of the double insulation	≥ 0.021	mm
CTI	Comparative tracking index	DIN EN 60112 (VDE 0303-11); IEC 60112	≥ 600	V
	Material group	According to IEC 60664-1	I	
	Overvoltage category per IEC 60664-1	Rated mains voltage ≤ 600 V <sub>RMS</sub>	I-IV	
		Rated mains voltage ≤ 1000 V <sub>RMS</sub>	I-III	
<b>DIN EN IEC 60747-17 (VDE 0884-17)<sup>(2)</sup></b>				
V <sub>IORM</sub>	Maximum repetitive peak isolation voltage	At AC voltage	1500	V <sub>PK</sub>
V <sub>IOWM</sub>	Maximum-rated isolation working voltage	At AC voltage (sine wave)	1000	V <sub>RMS</sub>
		At DC voltage	1500	V <sub>DC</sub>
V <sub>IOTM</sub>	Maximum transient isolation voltage	V <sub>TEST</sub> = V <sub>IOTM</sub> , t = 60 s (qualification test), V <sub>TEST</sub> = 1.2 × V <sub>IOTM</sub> , t = 1 s (100% production test)	7000	V <sub>PK</sub>
V <sub>IMP</sub>	Maximum impulse voltage <sup>(2)</sup>	Tested in air, 1.2/50-μs waveform per IEC 62368-1	7700	V <sub>PK</sub>
V <sub>IOSM</sub>	Maximum surge isolation voltage <sup>(3)</sup>	Tested in oil (qualification test), 1.2/50-μs waveform per IEC 62368-1	10000	V <sub>PK</sub>
q <sub>pd</sub>	Apparent charge <sup>(5)</sup>	Method a, after input/output safety test subgroups 2 and 3, V <sub>pd(ini)</sub> = V <sub>IOTM</sub> , t <sub>ini</sub> = 60 s, V <sub>pd(m)</sub> = 1.2 × V <sub>IORM</sub> , t <sub>m</sub> = 10 s	≤ 5	pC
		Method a, after environmental tests subgroup 1, V <sub>pd(ini)</sub> = V <sub>IOTM</sub> , t <sub>ini</sub> = 60 s, V <sub>pd(m)</sub> = 1.6 × V <sub>IORM</sub> , t <sub>m</sub> = 10 s	≤ 5	
		Method b1, at preconditioning (type test) and routine test, V <sub>pd(ini)</sub> = 1.2 × V <sub>IOTM</sub> , t <sub>ini</sub> = 1 s, V <sub>pd(m)</sub> = 1.875 × V <sub>IORM</sub> , t <sub>m</sub> = 1 s	≤ 5	
		Method b2, at routine test (100% production) <sup>(7)</sup> , V <sub>pd(ini)</sub> = V <sub>pd(m)</sub> = 1.2 × V <sub>IOTM</sub> , t <sub>ini</sub> = t <sub>m</sub> = 1 s	≤ 5	
C <sub>IO</sub>	Barrier capacitance, input to output <sup>(5)</sup>	V <sub>IO</sub> = 0.5 V <sub>PP</sub> at 1 MHz	~1.2	pF
R <sub>IO</sub>	Insulation resistance, input to output <sup>(5)</sup>	V <sub>IO</sub> = 500 V at T <sub>A</sub> = 25°C	> 10 <sup>12</sup>	Ω
		V <sub>IO</sub> = 500 V at 100°C ≤ T <sub>A</sub> ≤ 125°C	> 10 <sup>11</sup>	
		V <sub>IO</sub> = 500 V at T <sub>S</sub> = 150°C	> 10 <sup>9</sup>	
	Pollution degree		2	
	Climatic category	AMC1301	40/125/21	
		AMC1301S	55/125/21	
<b>UL1577</b>				
V <sub>ISO</sub>	Withstand isolation voltage	V <sub>TEST</sub> = V <sub>ISO</sub> , t = 60 s (qualification test), V <sub>TEST</sub> = 1.2 × V <sub>ISO</sub> , t = 1 s (100% production test)	5000	V <sub>RMS</sub>

- (1) Apply creepage and clearance requirements according to the specific equipment isolation standards of an application. Care must be taken to maintain the creepage and clearance distance of a board design to ensure that the mounting pads of the isolator on the printed circuit board (PCB) do not reduce this distance. Creepage and clearance on a PCB become equal in certain cases. Techniques such as inserting grooves, ribs, or both on a PCB are used to help increase these specifications.
- (2) Testing is carried out in air to determine the surge immunity of the package.
- (3) Testing is carried in oil to determine the intrinsic surge immunity of the isolation barrier.
- (4) Apparent charge is electrical discharge caused by a partial discharge (pd).
- (5) All pins on each side of the barrier are tied together, creating a two-pin device.
- (6) Either method b1 or b2 is used in production.

## 6.7 Safety-Related Certifications

VDE	UL
DIN EN IEC 60747-17 (VDE 0884-17), EN IEC 60747-17, DIN EN IEC 62368-1 (VDE 0868-1), EN IEC 62368-1, IEC 62368-1 Clause : 5.4.3 ; 5.4.4.4 ; 5.4.9	Recognized under 1577 component recognition program
Reinforced insulation	Single protection
Certificate number: 40040142	File number: E181974

## 6.8 Safety Limiting Values

Safety limiting<sup>(1)</sup> intends to minimize potential damage to the isolation barrier upon failure of input or output circuitry. A failure of the I/O can allow low resistance to ground or the supply and, without current limiting, dissipate sufficient power to over-heat the die and damage the isolation barrier potentially leading to secondary system failures.

PARAMETER		TEST CONDITIONS	MIN	TYP	MAX	UNIT
I <sub>S</sub>	Safety input, output, or supply current	R <sub>θJA</sub> = 110.1°C/W, VDDx = 5.5 V, T <sub>J</sub> = 150°C, T <sub>A</sub> = 25°C			206	mA
I <sub>S</sub>	Safety input, output, or supply current	R <sub>θJA</sub> = 110.1°C/W, VDDx = 3.6 V, T <sub>J</sub> = 150°C, T <sub>A</sub> = 25°C			315	mA
P <sub>S</sub>	Safety input, output, or total power	R <sub>θJA</sub> = 110.1°C/W, T <sub>J</sub> = 150°C, T <sub>A</sub> = 25°C			1135	mW
T <sub>S</sub>	Maximum safety temperature				150	°C

- (1) The maximum safety temperature, T<sub>S</sub>, has the same value as the maximum junction temperature, T<sub>J</sub>, specified for the device. The I<sub>S</sub> and P<sub>S</sub> parameters represent the safety current and safety power, respectively. Do not exceed the maximum limits of I<sub>S</sub> and P<sub>S</sub>. These limits vary with the ambient temperature, T<sub>A</sub>.

The junction-to-air thermal resistance, R<sub>θJA</sub>, in the Thermal Information table is that of a device installed on a high-K test board for leaded surface-mount packages. Use these equations to calculate the value for each parameter:

$T_J = T_A + R_{\theta JA} \times P$ , where P is the power dissipated in the device.

$T_{J(max)} = T_S = T_A + R_{\theta JA} \times P_S$ , where T<sub>J(max)</sub> is the maximum junction temperature.

$P_S = I_S \times VDD_{max}$ , where VDD<sub>max</sub> is the maximum supply voltage for high-side and low-side.



## 6.9 Electrical Characteristics

minimum and maximum specifications apply from  $T_A = -40^\circ\text{C}$  to  $+125^\circ\text{C}$  (for AMC1301S:  $T_A = -55^\circ\text{C}$  to  $+125^\circ\text{C}$ ),  $V_{DD1} = 3.0\text{ V}$  to  $5.5\text{ V}$ ,  $V_{DD2} = 3.0\text{ V}$  to  $5.5\text{ V}$ ,  $I_{NP} = -250\text{ mV}$  to  $+250\text{ mV}$ , and  $I_{NN} = \text{GND1}$ ; typical specifications are at  $T_A = 25^\circ\text{C}$ ,  $V_{DD1} = 5\text{ V}$ , and  $V_{DD2} = 3.3\text{ V}$  (unless otherwise noted)

PARAMETER	TEST CONDITIONS	MIN	TYP	MAX	UNIT			
<b>ANALOG INPUT</b>								
$V_{CMov}$	Common-mode overvoltage detection level	$(V_{INP} + V_{INN}) / 2$ to GND1		$V_{DD1} - 2$	V			
	Hysteresis of common-mode overvoltage detection level		60		mV			
$V_{OS}$	Input offset voltage <sup>(1)</sup>	Initial, at $T_A = 25^\circ\text{C}$ , $I_{NP} = I_{NN} = \text{GND1}$		-0.2	$\pm 0.05$	0.2	mV	
$TCV_{OS}$	Input offset drift <sup>(1) (4)</sup>	AMC1301		-3	$\pm 1$	3	$\mu\text{V}/^\circ\text{C}$	
		AMC1301S		-4	$\pm 1$	4		
$CMRR$	Common-mode rejection ratio	$f_{IN} = 0\text{ Hz}$ , $V_{CM\ min} \leq V_{CM} \leq V_{CM\ max}$				-93	dB	
		$f_{IN} = 10\text{ kHz}$ , $V_{CM\ min} \leq V_{CM} \leq V_{CM\ max}$				-93		
$R_{IN}$	Single-ended input resistance	$I_{NN} = \text{GND1}$				18	k $\Omega$	
$R_{IND}$	Differential input resistance					22	k $\Omega$	
$I_{IB}$	Input bias current	$I_{NP} = I_{NN} = \text{GND1}$ ; $I_{IB} = (I_{IBP} + I_{IBN}) / 2$		-41	-30	-24	$\mu\text{A}$	
$TCI_{IB}$	Input bias current drift					1	nA/ $^\circ\text{C}$	
$C_{IND}$	Differential input capacitance					1	pF	
<b>ANALOG OUTPUT</b>								
	Nominal gain					8.2	V/V	
$E_G$	Gain error <sup>(1)</sup>	at $T_A = 25^\circ\text{C}$		-0.3%	$\pm 0.05\%$	0.3%		
$TCE_G$	Gain drift <sup>(1) (5)</sup>	AMC1301		-50	$\pm 15$	50	ppm/ $^\circ\text{C}$	
		AMC1301S		-60	$\pm 15$	60		
	Nonlinearity <sup>(1)</sup>			-0.03%	$\pm 0.01\%$	0.03%		
	Nonlinearity drift					$\pm 1$	ppm/ $^\circ\text{C}$	
$THD$	Total harmonic distortion <sup>(3)</sup>	$f_{IN} = 10\text{ kHz}$				-87	dB	
	Output noise	$I_{NP} = I_{NN} = \text{GND1}$ , $f_{IN} = 0\text{ Hz}$ , BW = 100 kHz brickwall filter				220	$\mu\text{V}_{RMS}$	
$SNR$	Signal-to-noise ratio	$f_{IN} = 1\text{ kHz}$ , BW = 10 kHz		80	84		dB	
		$f_{IN} = 10\text{ kHz}$ , BW = 100 kHz				71		
$PSRR$	Power-supply rejection ratio <sup>(2)</sup>	PSRR vs $V_{DD1}$ , at DC				-94	dB	
		PSRR vs $V_{DD1}$ , 100-mV and 10-kHz ripple				-90		
		PSRR vs $V_{DD2}$ , at DC				-100		
		PSRR vs $V_{DD2}$ , 100-mV and 10-kHz ripple				-94		
$V_{CMout}$	Common-mode output voltage			1.39	1.44	1.49	V	
$V_{CLIPout}$	Clipping differential output voltage	$V_{OUT} = (V_{OUTP} - V_{OUTN})$ ; $ V_{IN}  =  V_{INP} - V_{INN}  >  V_{Clipping} $		-2.52	$\pm 2.49$	2.52	V	
$V_{Failsafe}$	Failsafe differential output voltage	$V_{CM} \geq V_{CMov}$ , or $V_{DD1}$ missing				-2.563	-2.545	V
$BW$	Output bandwidth			190	210		kHz	
$R_{OUT}$	Output resistance	On $OUTP$ or $OUTN$				< 0.2	$\Omega$	
	Output short-circuit current	On $OUTP$ or $OUTN$ , sourcing or sinking, $I_{NN} = I_{NP} = \text{GND1}$ , outputs shorted to either $\text{GND2}$ or $V_{DD2}$				13	mA	
$CMTI$	Common-mode transient immunity	$ GND1 - GND2  = 1\text{ kV}$				15	kV/ $\mu\text{s}$	

### 6.9 Electrical Characteristics (continued)

minimum and maximum specifications apply from  $T_A = -40^{\circ}\text{C}$  to  $+125^{\circ}\text{C}$  (for AMC1301S:  $T_A = -55^{\circ}\text{C}$  to  $+125^{\circ}\text{C}$ ),  $V_{DD1} = 3.0\text{ V}$  to  $5.5\text{ V}$ ,  $V_{DD2} = 3.0\text{ V}$  to  $5.5\text{ V}$ ,  $\text{INP} = -250\text{ mV}$  to  $+250\text{ mV}$ , and  $\text{INN} = \text{GND1}$ ; typical specifications are at  $T_A = 25^{\circ}\text{C}$ ,  $V_{DD1} = 5\text{ V}$ , and  $V_{DD2} = 3.3\text{ V}$  (unless otherwise noted)

PARAMETER		TEST CONDITIONS	MIN	TYP	MAX	UNIT
<b>POWER SUPPLY</b>						
IDD1	High-side supply current	$3.0\text{ V} \leq V_{DD1} \leq 3.6\text{ V}$		6.3	8.5	mA
		$4.5\text{ V} \leq V_{DD1} \leq 5.5\text{ V}$		7.2	9.8	
IDD2	Low-side supply current	$3.0\text{ V} \leq V_{DD2} \leq 3.6\text{ V}$		5.3	7.2	mA
		$4.5\text{ V} \leq V_{DD2} \leq 5.5\text{ V}$		5.9	8.1	

- (1) The typical value includes one standard deviation (*sigma*) at nominal operating conditions.
- (2) This parameter is input referred.
- (3) THD is the ratio of the rms sum of the amplitudes of first five higher harmonics to the amplitude of the fundamental.
- (4) Offset error temperature drift is calculated using the box method, as described by the following equation:  
 $TCV_{OS} = (V_{OS,MAX} - V_{OS,MIN}) / TempRange$  where  $V_{OS,MAX}$  and  $V_{OS,MIN}$  refer to the maximum and minimum  $V_{OS}$  values measured within the temperature range ( $-40$  to  $125^{\circ}\text{C}$ ).
- (5) Gain error temperature drift is calculated using the box method, as described by the following equation:  
 $TCE_G (ppm) = ((E_{G,MAX} - E_{G,MIN}) / TempRange) \times 10^4$  where  $E_{G,MAX}$  and  $E_{G,MIN}$  refer to the maximum and minimum  $E_G$  values (in %) measured within the temperature range ( $-40$  to  $125^{\circ}\text{C}$ ).

### 6.10 Switching Characteristics

over operating ambient temperature range (unless otherwise noted)

PARAMETER		TEST CONDITIONS	MIN	TYP	MAX	UNIT
$t_r$	Output signal rise time			2.0		$\mu\text{s}$
$t_f$	Output signal fall time			2.0		$\mu\text{s}$
	$V_{INx}$ to $V_{OUTx}$ signal delay (50% - 10%)	Unfiltered output		0.7	2.0	$\mu\text{s}$
	$V_{INx}$ to $V_{OUTx}$ signal delay (50% - 50%)	Unfiltered output		1.6	2.6	$\mu\text{s}$
	$V_{INx}$ to $V_{OUTx}$ signal delay (50% - 90%)	Unfiltered output		2.5	3	$\mu\text{s}$

### 6.11 Timing Diagram

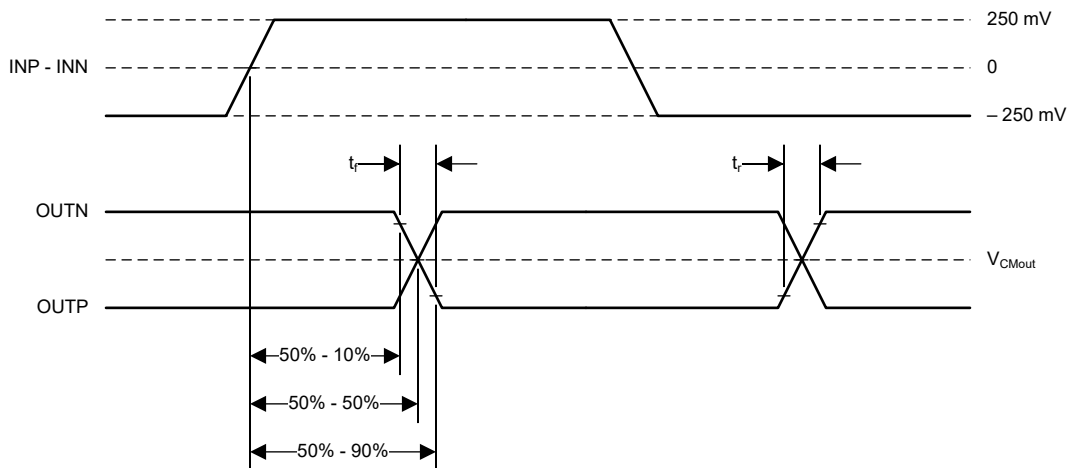

**6-1. Rise, Fall, and Delay Time Definition**

## 6.12 Insulation Characteristics Curves

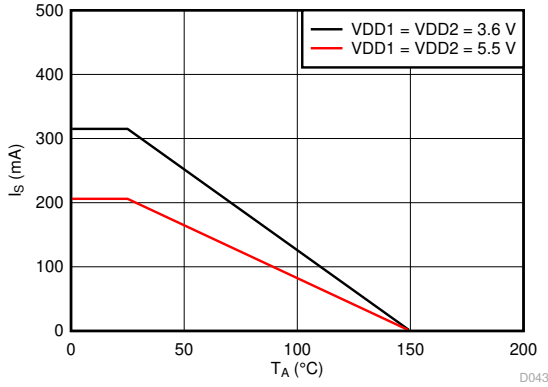

Figure 6-2. Thermal Derating Curve for Safety-Limiting Current per VDE

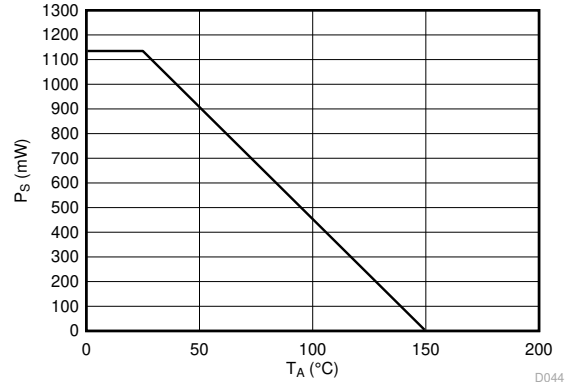
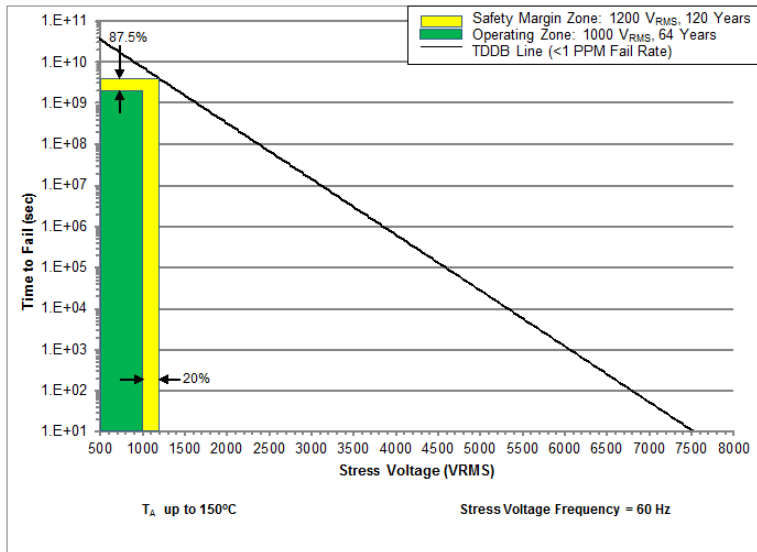

Figure 6-3. Thermal Derating Curve for Safety-Limiting Power per VDE



$T_A$  up to 150°C, stress voltage frequency = 60 Hz

Figure 6-4. Reinforced Isolation Capacitor Lifetime Projection

### 6.13 Typical Characteristics

at VDD1 = 5 V, VDD2 = 3.3 V, INP = -250 mV to 250 mV, INN = 0 V, and  $f_{IN} = 10$  kHz (unless otherwise noted)

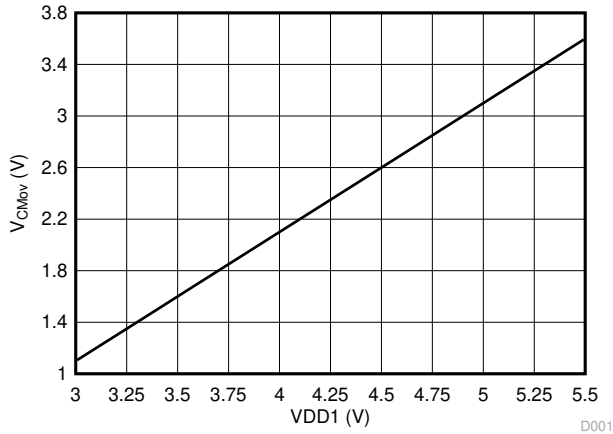

**6-5. Common-Mode Overvoltage Detection Level vs High-Side Supply Voltage**

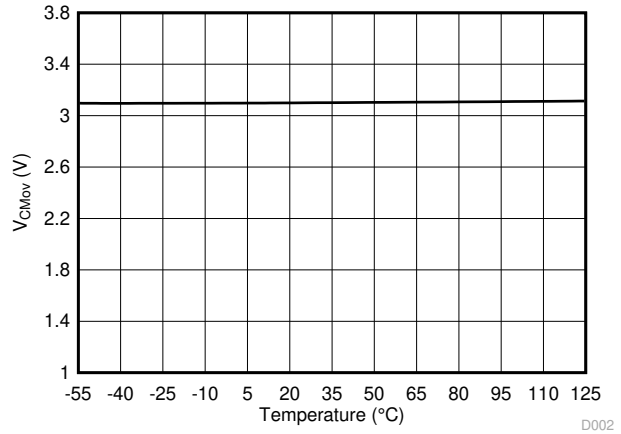

**6-6. Common-Mode Overvoltage Detection Level vs Temperature**

-55°C ≤ T<sub>A</sub> < 40°C valid for the AMC1301S only

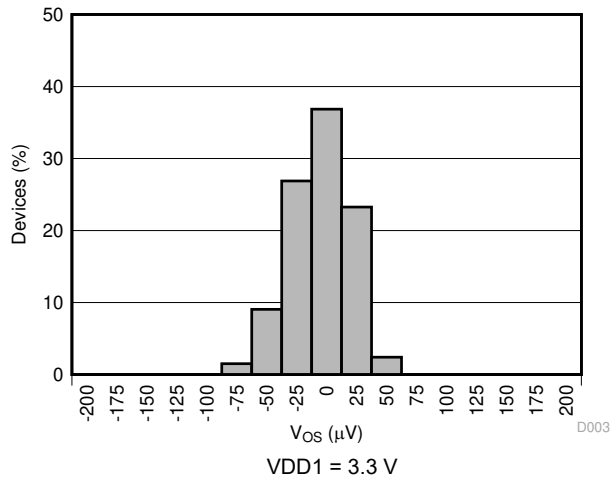

**6-7. Input Offset Voltage Histogram**

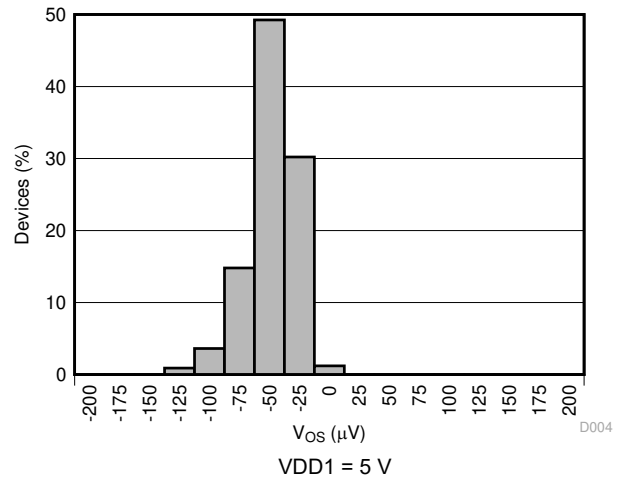

**6-8. Input Offset Voltage Histogram**

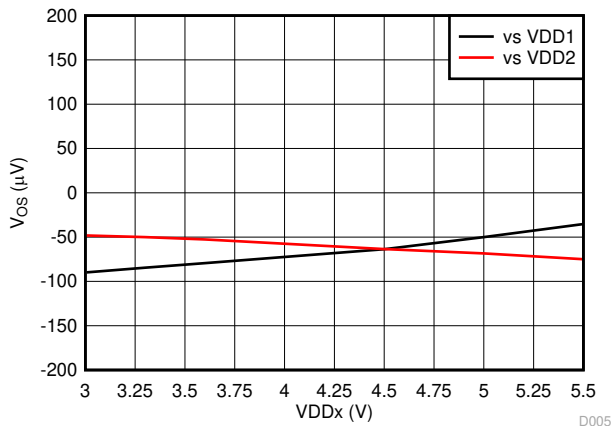

**6-9. Input Offset Voltage vs Supply Voltage**

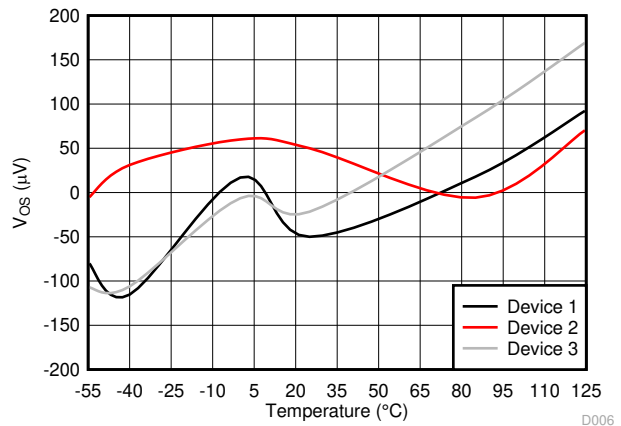

**6-10. Input Offset Voltage vs Temperature**

-55°C ≤ T<sub>A</sub> < 40°C valid for the AMC1301S only

### 6.13 Typical Characteristics (continued)

at VDD1 = 5 V, VDD2 = 3.3 V, INP = -250 mV to 250 mV, INN = 0 V, and  $f_{IN} = 10$  kHz (unless otherwise noted)

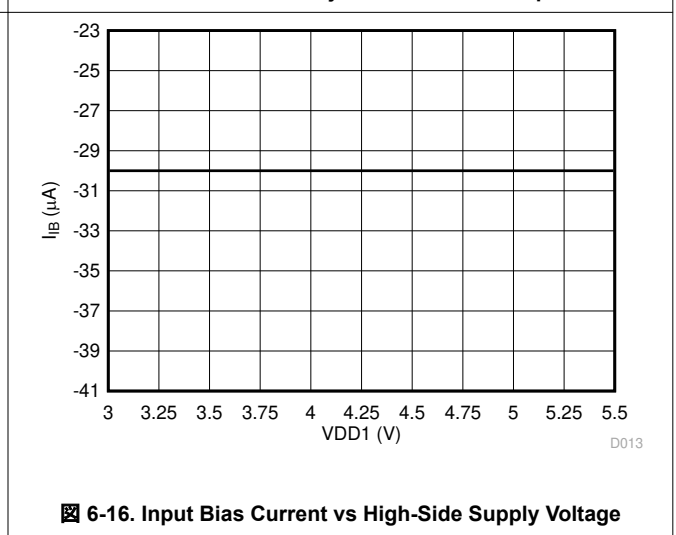
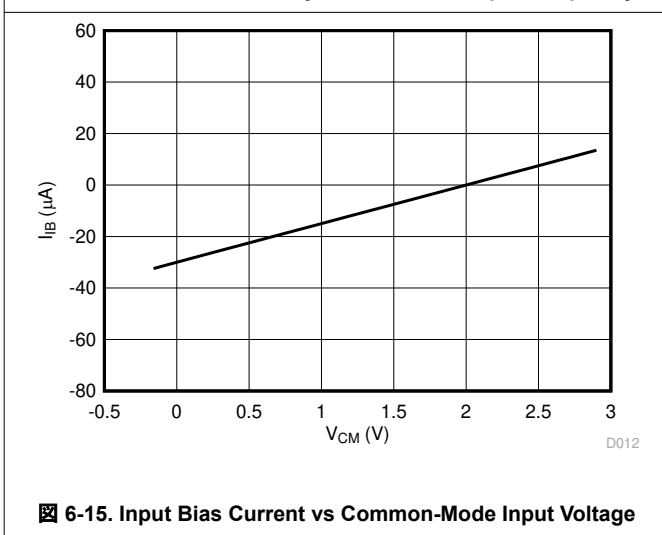
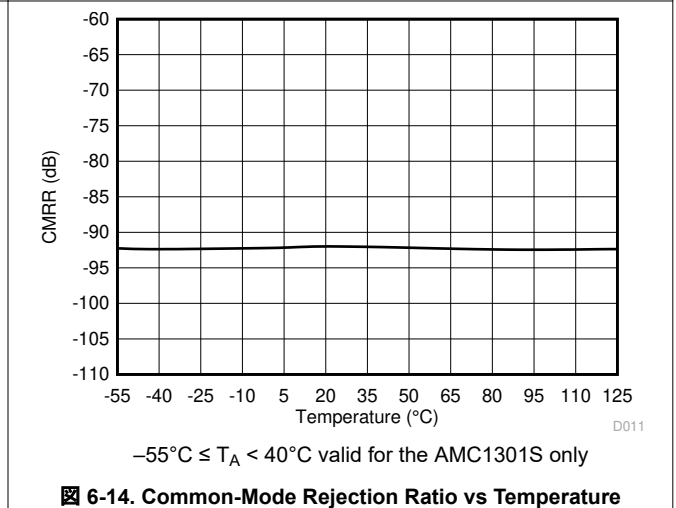
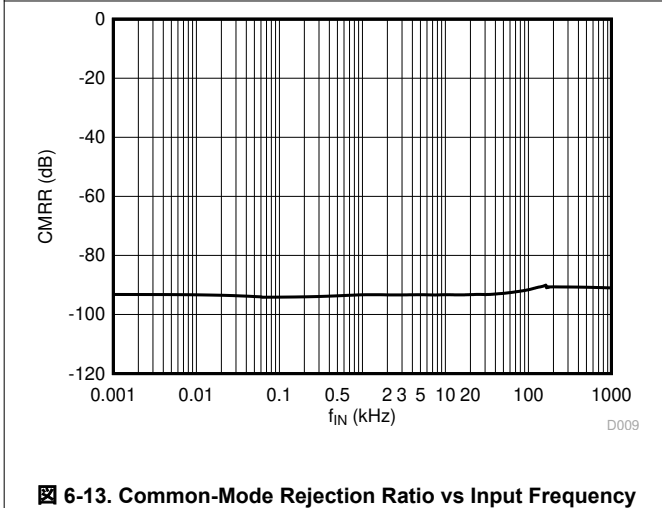
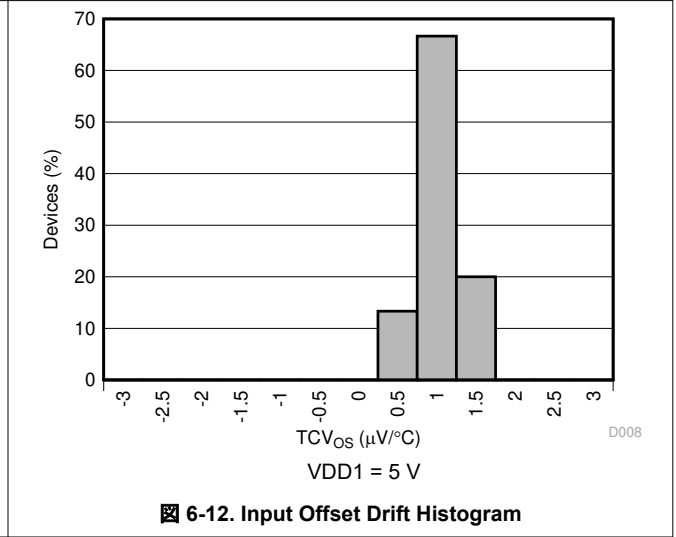
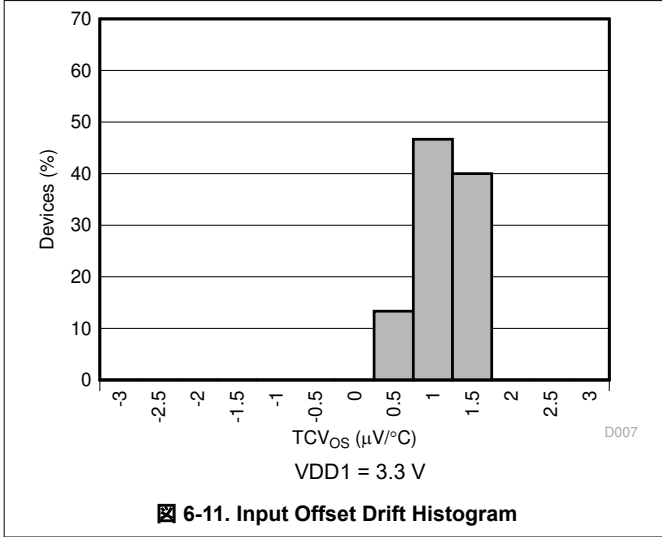

### 6.13 Typical Characteristics (continued)

at VDD1 = 5 V, VDD2 = 3.3 V, INP = -250 mV to 250 mV, INN = 0 V, and  $f_{IN} = 10$  kHz (unless otherwise noted)

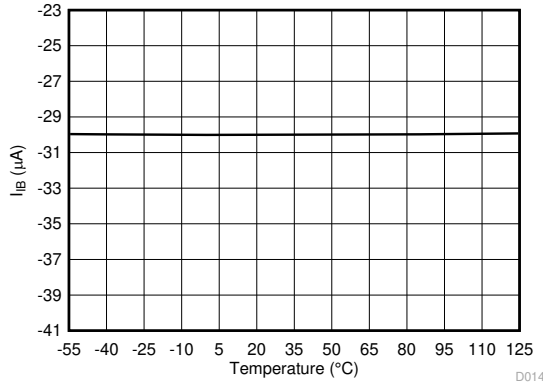

-55°C ≤ T<sub>A</sub> < 40°C valid for the AMC1301S only

6-17. Input Bias Current vs Temperature

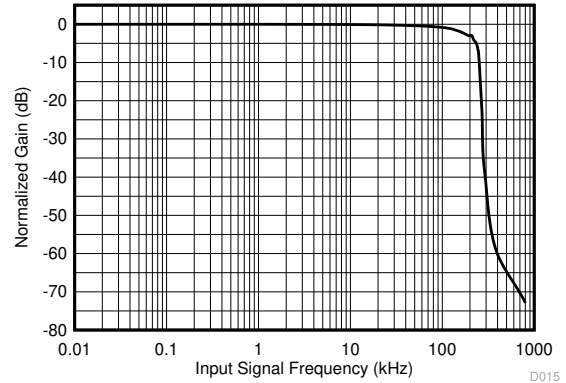

6-18. Normalized Gain vs Input Frequency

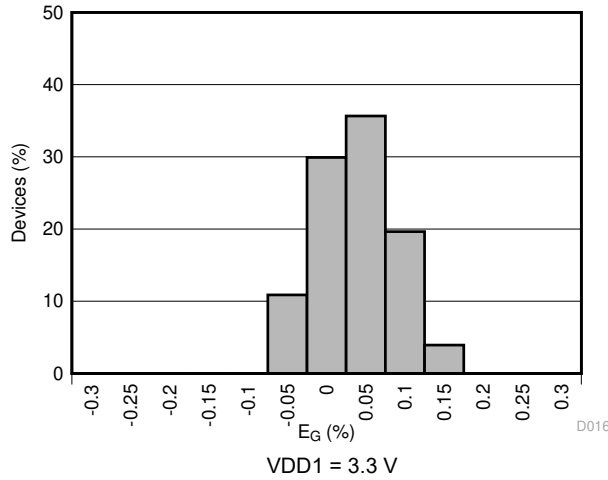

6-19. Gain Error Histogram

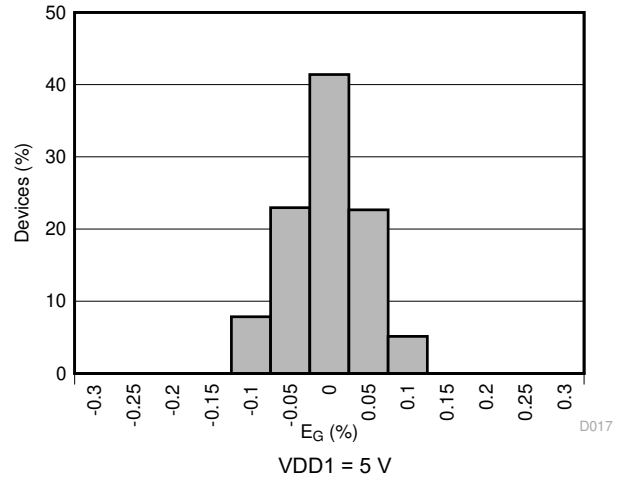

6-20. Gain Error Histogram

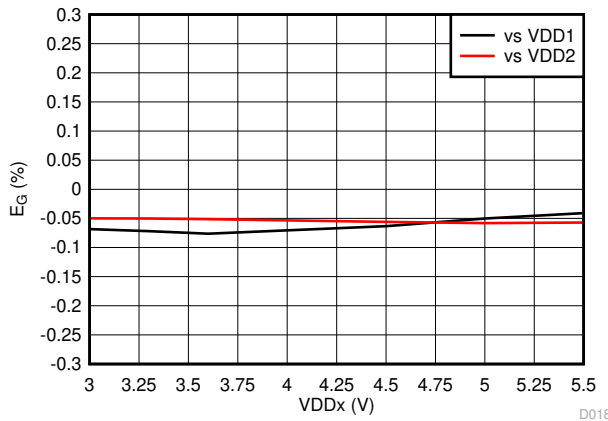

6-21. Gain Error vs Supply Voltage

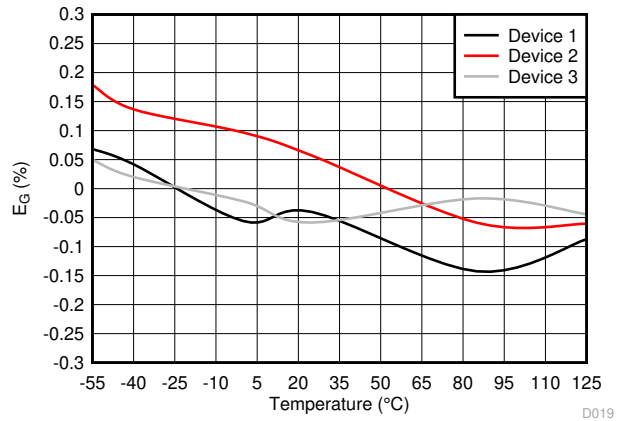

-55°C ≤ T<sub>A</sub> < 40°C valid for the AMC1301S only

6-22. Gain Error vs Temperature

### 6.13 Typical Characteristics (continued)

at VDD1 = 5 V, VDD2 = 3.3 V, INP = -250 mV to 250 mV, INN = 0 V, and  $f_{IN} = 10$  kHz (unless otherwise noted)

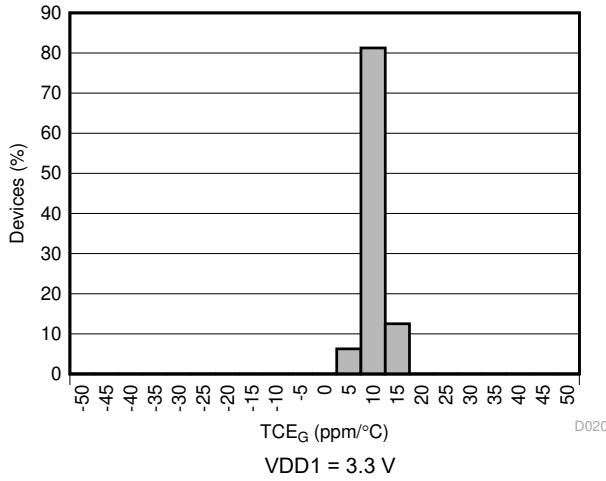

6-23. Gain Error Drift Histogram

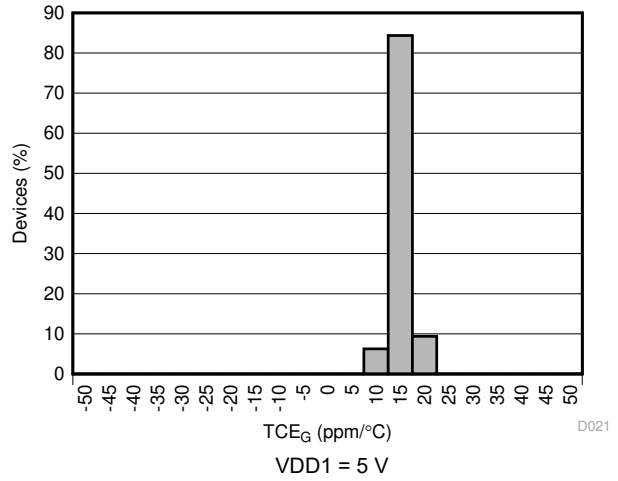

6-24. Gain Error Drift Histogram

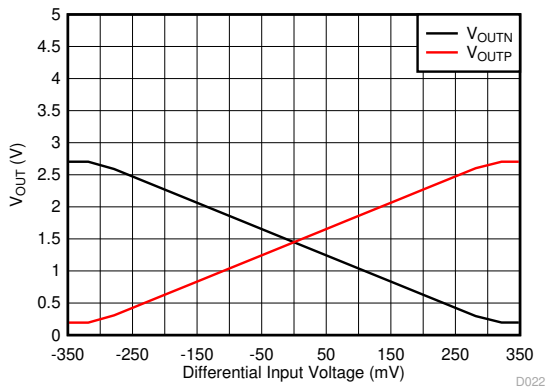

6-25. Output Voltage vs Input Voltage

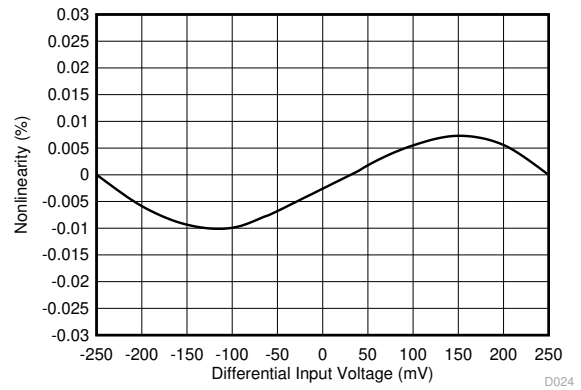

6-26. Nonlinearity vs Input Voltage

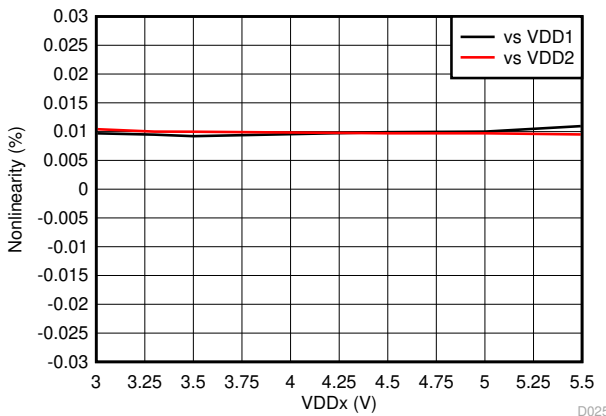

6-27. Nonlinearity vs Supply Voltage

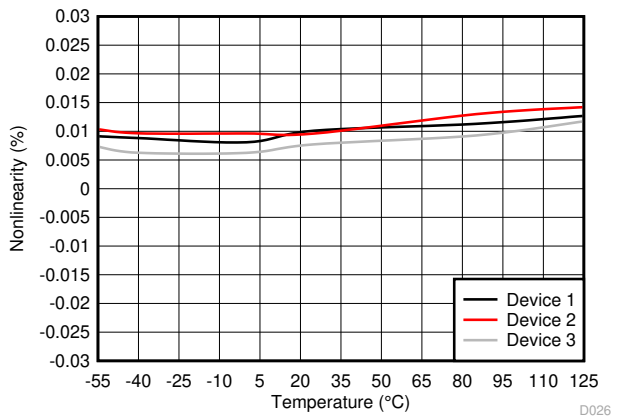

$-55^{\circ}\text{C} \leq T_A < 40^{\circ}\text{C}$  valid for the AMC1301S only

6-28. Nonlinearity vs Temperature

### 6.13 Typical Characteristics (continued)

at VDD1 = 5 V, VDD2 = 3.3 V, INP = -250 mV to 250 mV, INN = 0 V, and  $f_{IN} = 10$  kHz (unless otherwise noted)

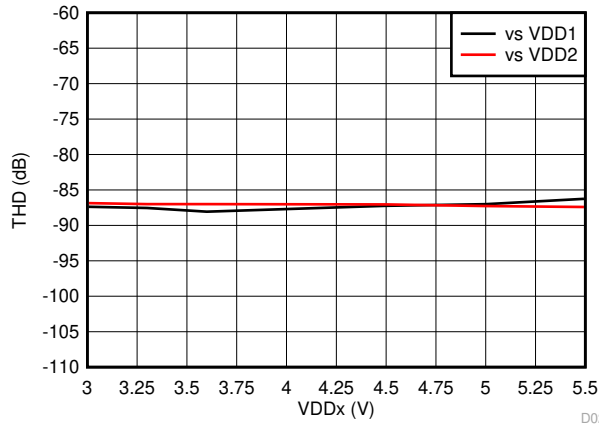

6-29. Total Harmonic Distortion vs Supply Voltage

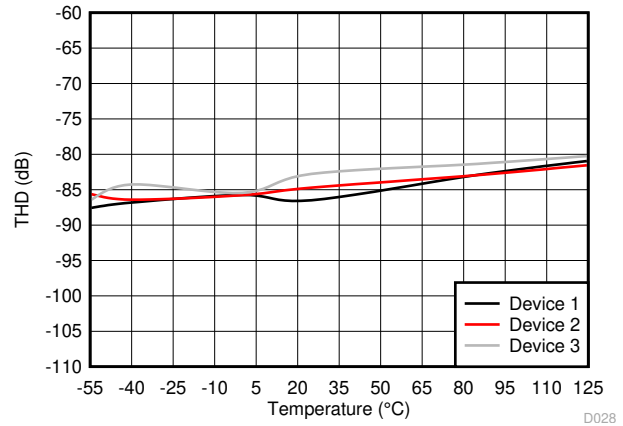

-55°C ≤ T<sub>A</sub> < 40°C valid for the AMC1301S only

6-30. Total Harmonic Distortion vs Temperature

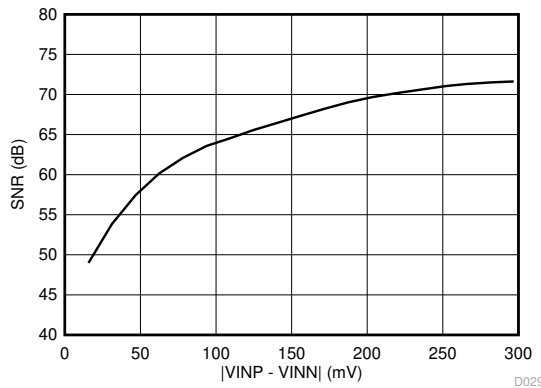

6-31. Signal-to-Noise Ratio vs Input Voltage

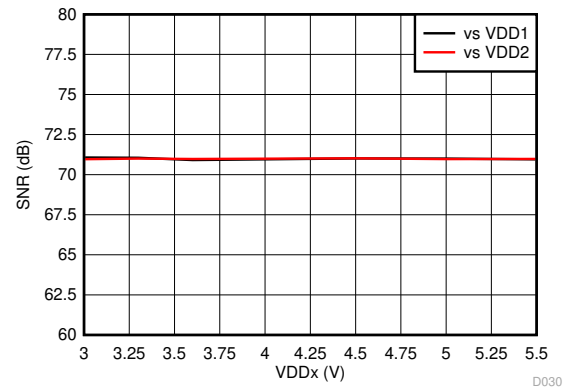

6-32. Signal-to-Noise Ratio vs Supply Voltage

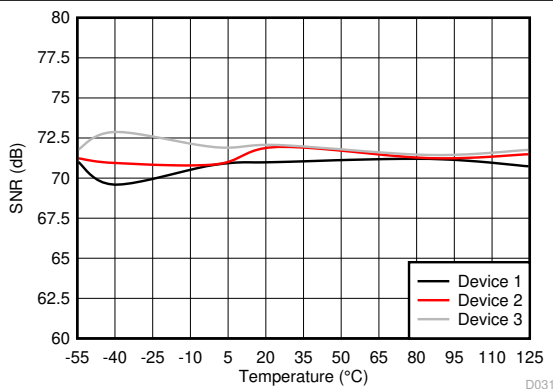

-55°C ≤ T<sub>A</sub> < 40°C valid for the AMC1301S only

6-33. Signal-to-Noise Ratio vs Temperature

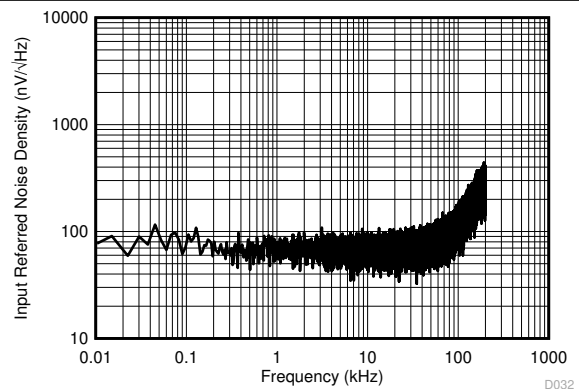

6-34. Input-Referred Noise Density vs Frequency



### 6.13 Typical Characteristics (continued)

at VDD1 = 5 V, VDD2 = 3.3 V, INP = -250 mV to 250 mV, INN = 0 V, and  $f_{IN} = 10$  kHz (unless otherwise noted)

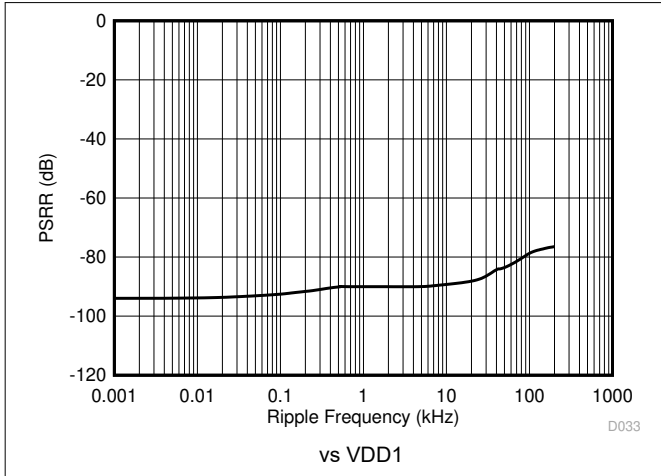

**Figure 6-35. Power-Supply Rejection Ratio vs Ripple Frequency vs VDD1**

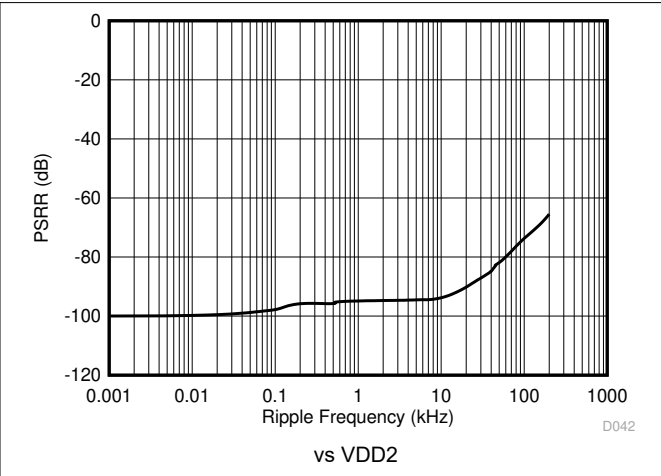

**Figure 6-36. Power-Supply Rejection Ratio vs Ripple Frequency vs VDD2**

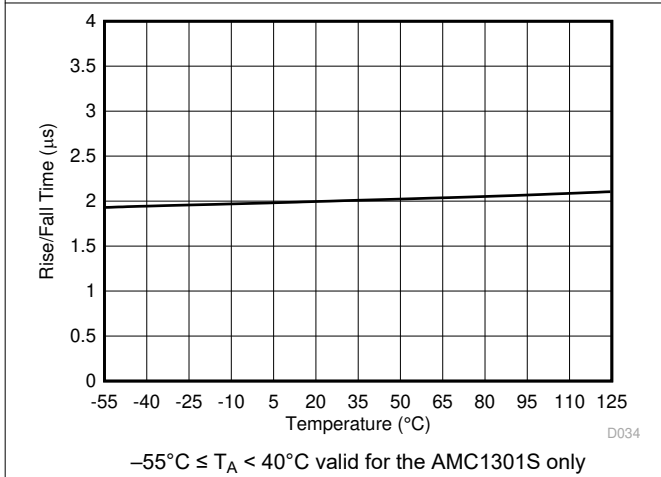

**Figure 6-37. Output Rise and Fall Time vs Temperature**

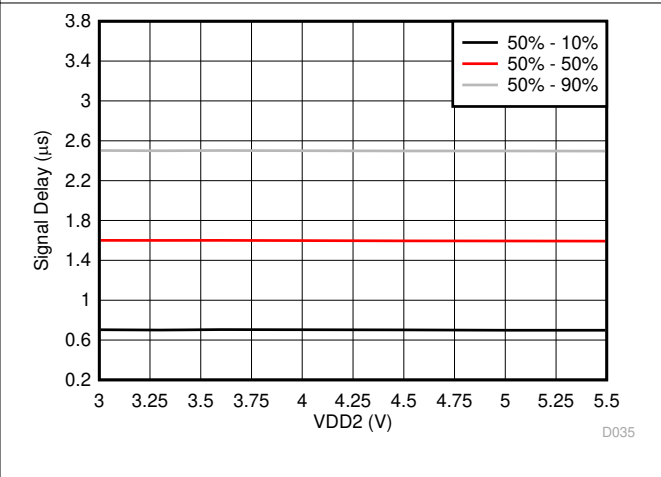

**Figure 6-38.  $V_{IN}$  to  $V_{OUT}$  Signal Delay vs Low-Side Supply Voltage**

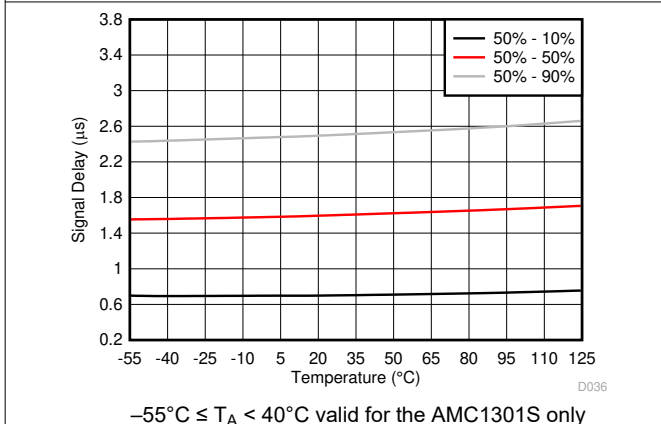

**Figure 6-39.  $V_{IN}$  to  $V_{OUT}$  Signal Delay vs Temperature**

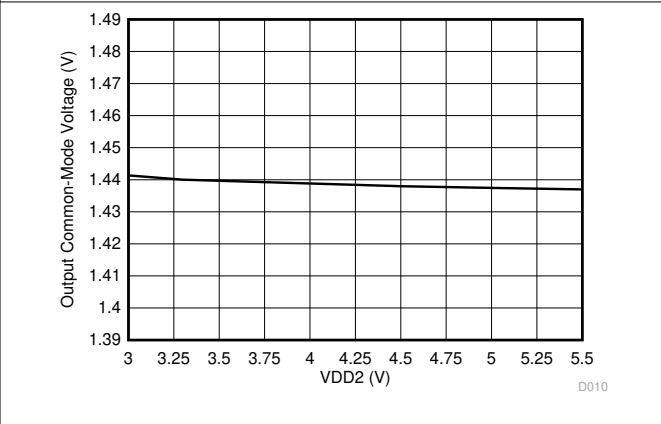

**Figure 6-40. Output Common-Mode Voltage vs Low-Side Supply Voltage**

### 6.13 Typical Characteristics (continued)

at VDD1 = 5 V, VDD2 = 3.3 V, INP = -250 mV to 250 mV, INN = 0 V, and  $f_{IN} = 10$  kHz (unless otherwise noted)

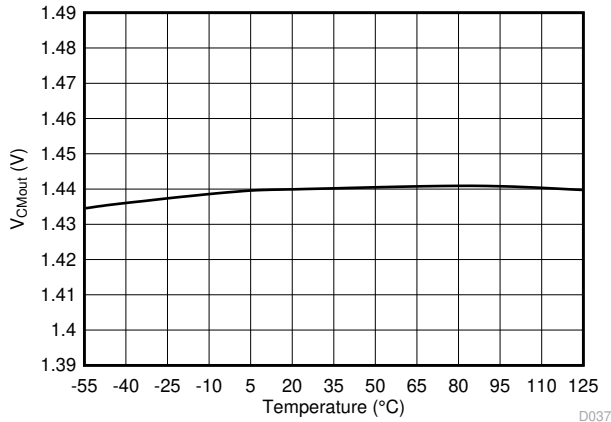

-55°C ≤ T<sub>A</sub> < 40°C valid for the AMC1301S only

**6-41. Output Common-Mode Voltage vs Temperature**

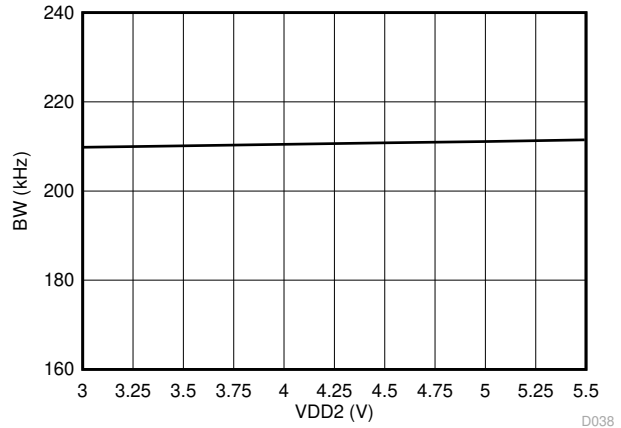

**6-42. Output Bandwidth vs Low-Side Supply Voltage**

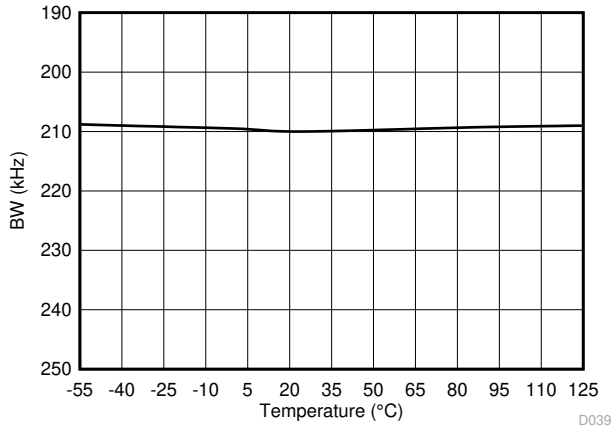

-55°C ≤ T<sub>A</sub> < 40°C valid for the AMC1301S only

**6-43. Output Bandwidth vs Temperature**

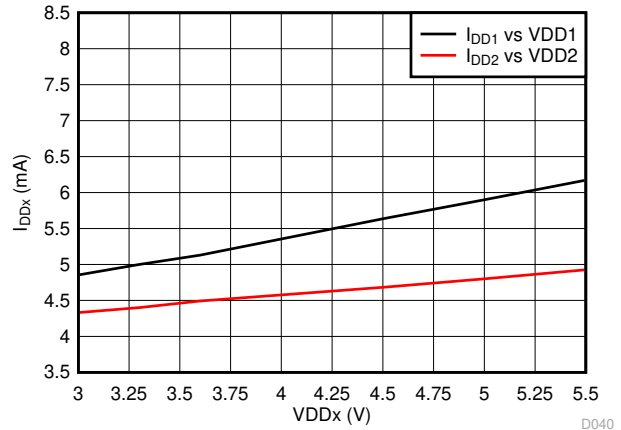

**6-44. Supply Current vs Supply Voltage**

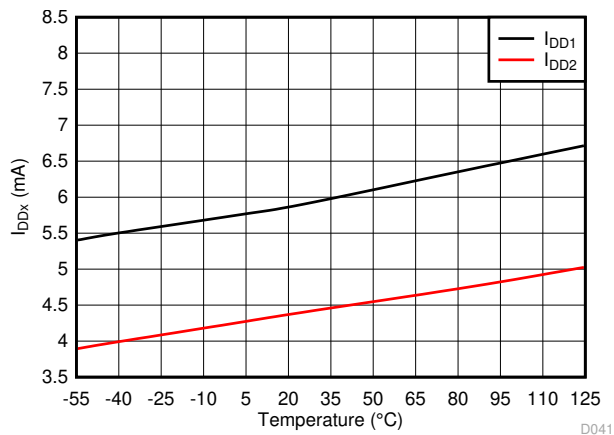

-55°C ≤ T<sub>A</sub> < 40°C valid for the AMC1301S only

**6-45. Supply Current vs Temperature**

## 7 Detailed Description

### 7.1 Overview

The AMC1301 is a fully differential, precision, isolated amplifier. The input stage of the device consists of a fully differential amplifier that drives a second-order, delta-sigma ( $\Delta\Sigma$ ) modulator. The modulator converts the analog input signal into a digital bitstream that is transferred across the isolation barrier that separates the high-side from the low-side. On the low-side, the received bitstream is processed by a fourth-order analog filter that outputs a differential signal at the OUPP and OUTN pins that is proportional to the input signal.

The SiO<sub>2</sub>-based, capacitive isolation barrier supports a high level of magnetic field immunity, as described in the [ISO72x Digital Isolator Magnetic-Field Immunity application note](#). The digital modulation used in the AMC1301 to transmit data across the isolation barrier, and the isolation barrier characteristics, result in high reliability and common-mode transient immunity.

### 7.2 Functional Block Diagram

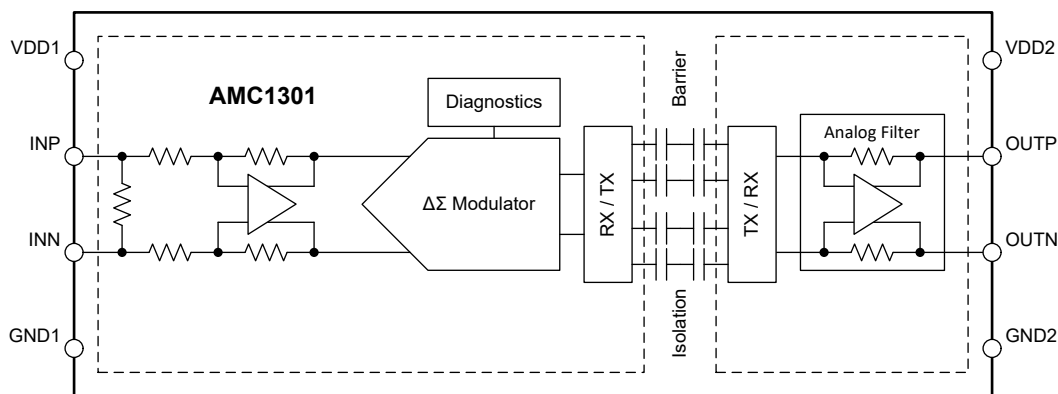

### 7.3 Feature Description

#### 7.3.1 Analog Input

The differential amplifier input stage of the AMC1301 feeds a second-order, switched-capacitor, feed-forward  $\Delta\Sigma$  modulator. The gain of the differential amplifier is set by internal precision resistors with a differential input impedance of  $R_{IND}$ . The modulator converts the analog input signal into a bitstream that is transferred across the isolation barrier, as described in the [Isolation Channel Signal Transmission](#) section.

There are two restrictions on the analog input signals (INP and INN). First, if the input voltages  $V_{INP}$  or  $V_{INN}$  exceed the range specified in the [Absolute Maximum Ratings](#) table, the input currents must be limited to the absolute maximum value, because the electrostatic discharge (ESD) protection turns on. In addition, the linearity and parametric performance of the device are ensured only when the analog input voltage remains within the linear full-scale range ( $V_{FSR}$ ) and within the common-mode input voltage range ( $V_{CM}$ ), as specified in the [Recommended Operating Conditions](#) table.

### 7.3.2 Isolation Channel Signal Transmission

The AMC1301 uses an on-off keying (OOK) modulation scheme, as shown in [Figure 7-1](#), to transmit the modulator output bitstream across the SiO<sub>2</sub>-based isolation barrier. The transmit driver (TX) shown in the [Functional Block Diagram](#) transmits an internally generated, high-frequency carrier across the isolation barrier to represent a digital *one* and does not send a signal to represent a digital *zero*. The nominal frequency of the carrier used inside the AMC1301 is 480 MHz.

The receiver (RX) on the other side of the isolation barrier recovers and demodulates the signal and provides the input to the fourth-order analog filter. The AMC1301 transmission channel is optimized to achieve the highest level of common-mode transient immunity (CMTI) and lowest level of radiated emissions caused by the high-frequency carrier and RX/TX buffer switching.

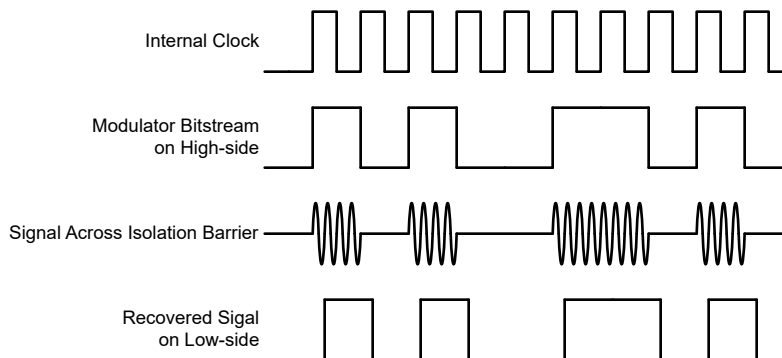

**Figure 7-1. OOK-Based Modulation Scheme**

### 7.3.3 Analog Output

The AMC1301 offers a differential analog output comprised of the OOUTP and OOUTN pins. For differential input voltages ( $V_{INP} - V_{INN}$ ) in the range from  $-250\text{ mV}$  to  $250\text{ mV}$ , the device provides a linear response with a nominal gain of 8.2. For example, for a differential input voltage of  $250\text{ mV}$ , the differential output voltage ( $V_{OOUTP} - V_{OOUTN}$ ) is  $2.05\text{ V}$ . At zero input (INP shorted to INN), both pins output the same common-mode output voltage  $V_{CMout}$ , as specified in the [Electrical Characteristics](#) table. For absolute differential input voltages greater than  $250\text{ mV}$  but less than  $320\text{ mV}$ , the differential output voltage continues to increase in magnitude but with reduced linearity performance. The outputs saturate at a differential output voltage of  $V_{CLIPout}$ , as shown in [Figure 7-2](#), if the differential input voltage exceeds the  $V_{Clipping}$  value.

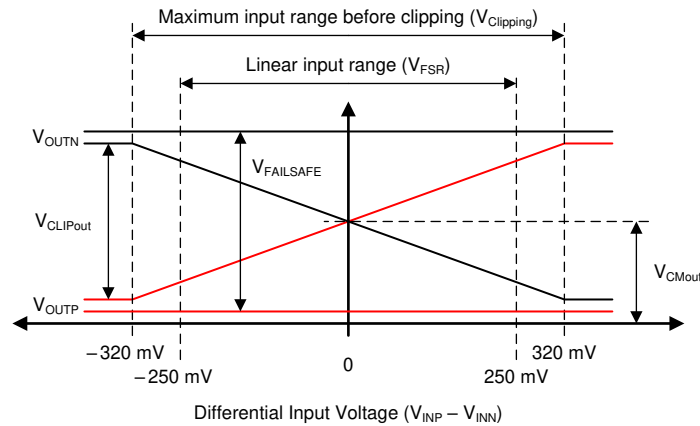

**Figure 7-2. Output Behavior of the AMC1301**

The AMC1301 offers a fail-safe feature that simplifies diagnostics on a system level. [Figure 7-2](#) shows the fail-safe mode, in which the AMC1301 outputs a negative differential output voltage that does not occur under normal operating conditions. The fail-safe output is active in two cases:

- When the high-side supply is missing or below the  $V_{DD1UV}$  threshold
- When the common-mode input voltage, that is  $V_{CM} = (V_{INP} + V_{INN}) / 2$ , exceeds the common-mode overvoltage detection level  $V_{CMov}$

Use the maximum  $V_{FAILSAFE}$  voltage specified in the [Electrical Characteristics](#) table as a reference value for fail-safe detection on a system level.

### 7.4 Device Functional Modes

The AMC1301 assumes normal operation as soon as  $V_{DD1}$ ,  $V_{DD2}$ , and the input common-mode voltage ( $V_{CM}$ ) are within the operational ranges, as specified in [Electrical Characteristics](#) table. In this mode, the output voltage is proportional to the input voltage.

The AMC1301 enters fail-safe mode whenever the high-side supply ( $V_{DD1}$ ) is missing or the input common-mode voltage ( $V_{CM}$ ) exceeds the specified input-overvoltage detection level  $V_{CMov}$ . In this mode, the differential output voltage is a fixed, negative value ( $V_{FAILSAFE}$ ). See the [Analog Output](#) section for details.

## 8 Application and Implementation

### 注

以下のアプリケーション情報は、TI の製品仕様に含まれるものではなく、TI ではその正確性または完全性を保証いたしません。個々の目的に対する製品の適合性については、お客様の責任で判断していただくこととなります。お客様は自身の設計実装を検証しテストすることで、システムの機能を確認する必要があります。

### 8.1 Application Information

With a low analog input voltage range, high DC accuracy, and low temperature drift, the AMC1301 is designed for precision, shunt-based current sensing in applications requiring high voltage isolation.

### 8.2 Typical Application

図 8-1 shows the AMC1301 in a typical application of an AC motor drive. The load current flowing through an external shunt resistor RSHUNT produces a voltage drop that is sensed by the AMC1301. The AMC1301 digitizes the analog input signal on the high-side, transfers the data across the isolation barrier to the low-side, reconstructs the analog signal, and presents that signal as a differential voltage on the output pins.

The differential input, differential output, and the high common-mode transient immunity (CMTI) of the AMC1301 provide reliable and accurate operation even in high-noise environments.



図 8-1. Using the AMC1301 for Current Sensing in a Typical Application

## 8.2.1 Design Requirements

表 8-1 lists the parameters for this typical application.

表 8-1. Design Requirements

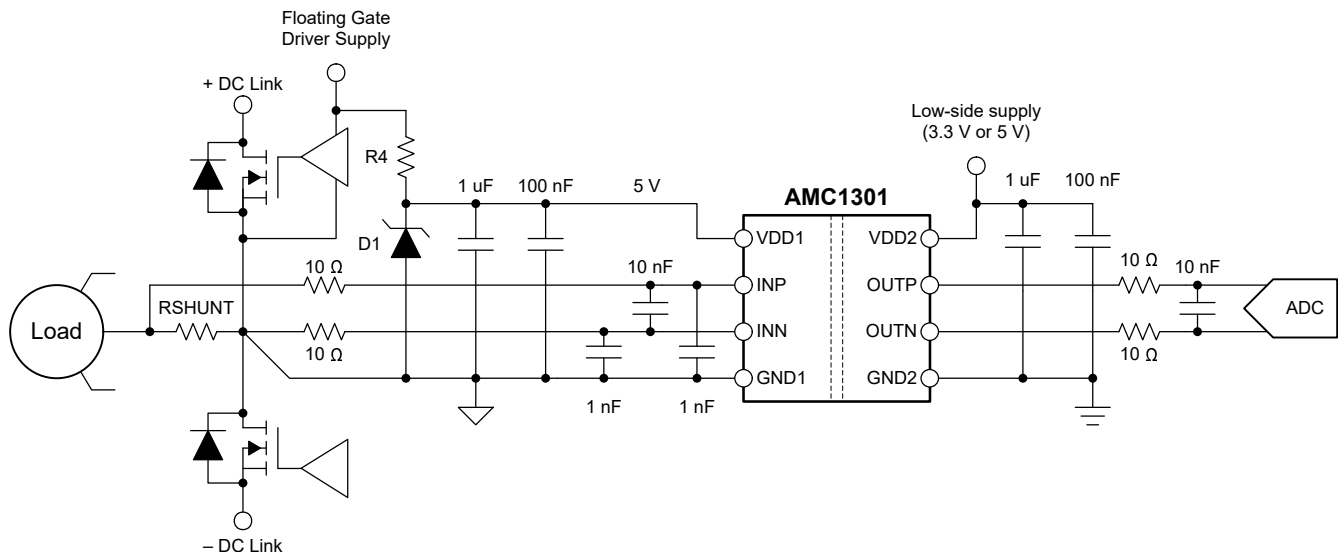
PARAMETER	VALUE
High-side supply voltage	3.3 V or 5 V
Low-side supply voltage	3.3 V or 5 V
Voltage drop across RSHUNT for a linear response	±250 mV (maximum)
Signal delay (50% V <sub>IN</sub> to 90% OUTP, OUTN)	3 μs (maximum)

## 8.2.2 Detailed Design Procedure

In 图 8-1, the high-side power supply (VDD1) for the AMC1301 is derived from the floating power supply of the upper gate driver.

The floating ground reference (GND1) is derived from the end of the shunt resistor that is connected to the negative input of the AMC1301 (INN). If a four-pin shunt is used, the inputs of the AMC1301 are connected to the inner leads and GND1 is connected to the outer lead on the INN-side of the shunt. To minimize offset and improve accuracy, route the ground connection as a separate trace that connects directly to the shunt resistor rather than shorting GND1 to INN directly at the input to the device. See the [Layout](#) section for more details.

### 8.2.2.1 Shunt Resistor Sizing

Use Ohm's Law to calculate the voltage drop across the shunt resistor (V<sub>SHUNT</sub>) for the desired measured current:  $V_{SHUNT} = I \times R_{SHUNT}$ .

Consider the following two restrictions when selecting the value of the shunt resistor, RSHUNT:

- The voltage drop caused by the nominal current range must not exceed the recommended differential input voltage range for a linear response:  $|V_{SHUNT}| \leq |V_{FSR}|$
- The voltage drop caused by the maximum allowed overcurrent must not exceed the input voltage that causes a clipping output:  $|V_{SHUNT}| \leq |V_{Clipping}|$

### 8.2.2.2 Input Filter Design

Place a differential RC filter (R1, R2, C5) in front of the isolated amplifier to improve signal-to-noise performance of the signal path. Design the input filter such that:

- The cutoff frequency of the filter is at least one order of magnitude lower than the sampling frequency of the  $\Delta\Sigma$  modulator (20 MHz)
- The input bias current does not generate significant voltage drop across the DC impedances (R1, R2) of the input filter
- The impedances measured from the analog inputs are equal (R1 equals R2)

Capacitors C6 and C7 are optional and improve common-mode rejection at high frequencies (>1 MHz). For best performance, C6 must match the value of C7 and both capacitors must be 10 to 20 times lower in value than C5. For most applications, the structure shown in 图 8-2 achieves excellent performance.



图 8-2. Differential Input Filter

### 8.2.2.3 Differential to Single-Ended Output Conversion

Figure 8-3 shows an example of a TLV900x-based signal conversion and filter circuit for systems using single-ended input ADCs to convert the analog output voltage into digital. For  $R1 = R3$  and  $R2 = R4$ , the output voltage equals  $(R2 / R1) \times (V_{OUTP} - V_{OUTN}) + V_{REF}$ . Tailor the bandwidth of this filter stage to the bandwidth requirement of the system and use NP0-type capacitors for best performance. For most applications,  $R1 = R2 = R3 = R4 = 3.3 \text{ k}\Omega$  and  $C1 = C2 = 330 \text{ pF}$  yields good performance.

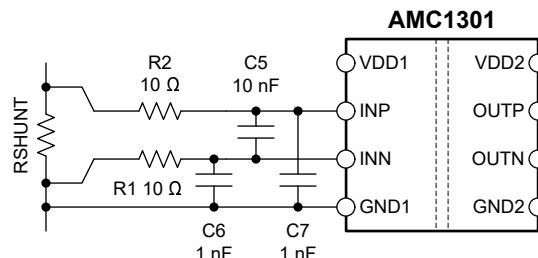
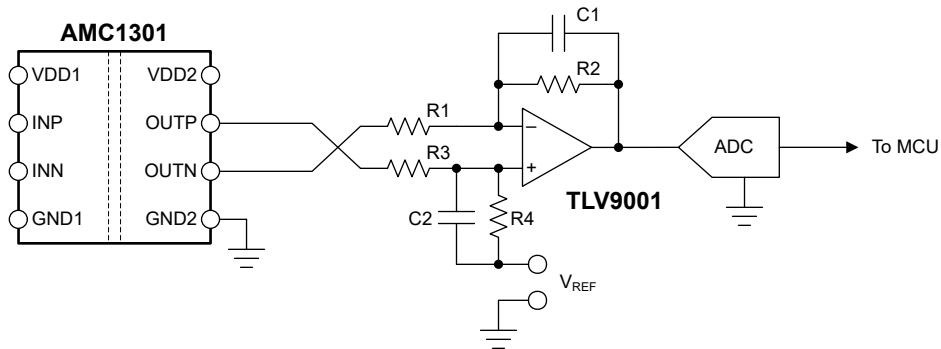

Figure 8-3. Connecting the AMC1301 Output to a Single-Ended Input ADC

For more information on the general procedure to design the filtering and driving stages of SAR ADCs, see the [18-Bit, 1MSPS Data Acquisition Block \(DAQ\) Optimized for Lowest Distortion and Noise](#) and [18-Bit Data Acquisition Block \(DAQ\) Optimized for Lowest Power](#) reference guides, available for download at [www.ti.com](http://www.ti.com).

### 8.2.3 Application Curve

One important aspect of power-stage design is the effective detection of an overcurrent condition to protect the switching devices and passive components from damage. To power off the system quickly in the event of an overcurrent condition, a low delay caused by the isolated amplifier is required. Figure 8-4 shows the typical full-scale step response of the AMC1301.



Figure 8-4. Step Response of the AMC1301



### 8.3 Best Design Practices

Do not leave the inputs of the AMC1301 unconnected (floating) when the device is powered up. If the device inputs are left floating, the input bias current can possibly drive the inputs to a positive value that exceeds the operating common-mode input voltage, thus causing the device to output the fail-safe voltage as described in the [Analog Output](#) section.

Connect the high-side ground (GND1) to INN, either by a hard short or through a resistive path. A DC current path between INN and GND1 is required to define the input common-mode voltage. Take care not to exceed the input common-mode range as specified in the [Recommended Operating Conditions](#) table. For best accuracy, route the ground connection as a separate trace that connects directly to the shunt resistor rather than shorting GND1 to INN directly at the input to the device. See the [Layout](#) section for more details.

### 8.4 Power Supply Recommendations

The AMC1301 does not require any specific power-up sequencing. The high-side power supply (AVDD) is decoupled with a low-ESR, 100-nF capacitor (C1) parallel to a low-ESR, 1- $\mu$ F capacitor (C2). The low-side power supply (DVDD) is equally decoupled with a low-ESR, 100-nF capacitor (C3) parallel to a low-ESR, 1- $\mu$ F capacitor (C4). Place all four capacitors (C1, C2, C3, and C4) as close to the device as possible.

The ground reference for the high-side (AGND) is derived from the end of the shunt resistor that is connected to the negative input (INN) of the device. For best DC accuracy, use a separate trace to make this connection instead of shorting AGND to INN directly at the device input. If a four-terminal shunt is used, the device inputs are connected to the inner leads and AGND is connected to the outer lead on the INN side of the shunt. [Figure 8-5](#) shows a decoupling diagram of the AMC1301.

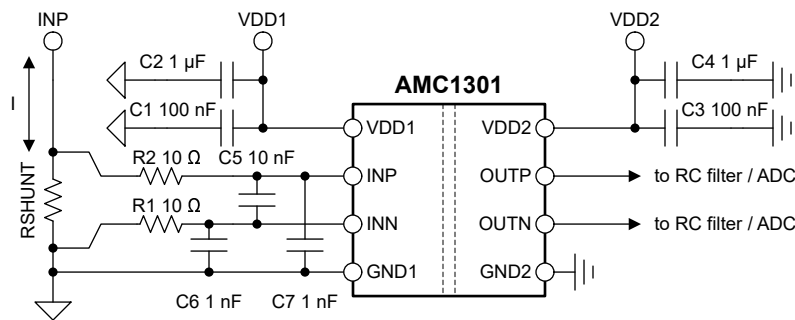

**Figure 8-5. Decoupling of the AMC1301**

## 8.5 Layout

### 8.5.1 Layout Guidelines

☒ 8-6 shows a layout recommendation with the critical placement of the decoupling capacitors (as close as possible to the AMC1301 supply pins) and placement of the other components required by the device. For best performance, place the shunt resistor close to the INP and INN inputs of the AMC1301 and keep the layout of both connections symmetrical.

### 8.5.2 Layout Example

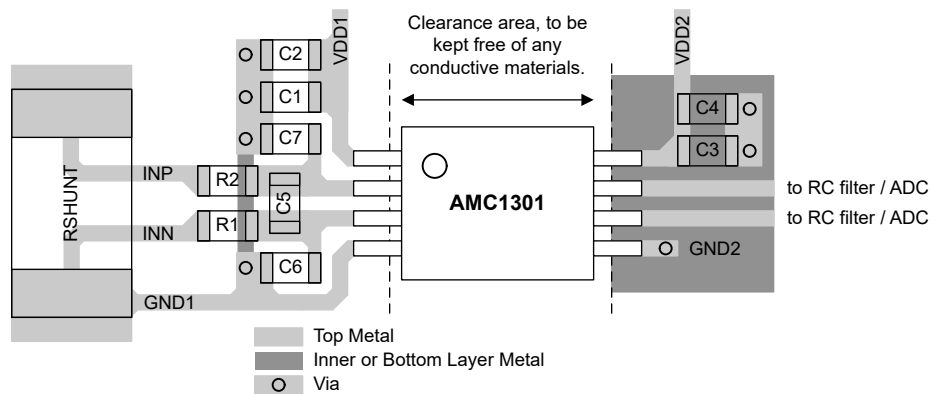

☒ 8-6. Recommended Layout of the AMC1301

## 9 Device and Documentation Support

### 9.1 Documentation Support

#### 9.1.1 Related Documentation

For related documentation, see the following:

- Texas Instruments, [Isolation Glossary application note](#)
- Texas Instruments, [Semiconductor and IC Package Thermal Metrics application note](#)
- Texas Instruments, [ISO72x Digital Isolator Magnetic-Field Immunity application note](#)
- Texas Instruments, [TLV900x Low-Power, RRIO, 1-MHz Operational Amplifier for Cost-Sensitive Systems data sheet](#)
- Texas Instruments, [18-Bit, 1-MSPS Data Acquisition Block \(DAQ\) Optimized for Lowest Distortion and Noise reference guide](#)
- Texas Instruments, [18-Bit, 1-MSPS Data Acquisition Block \(DAQ\) Optimized for Lowest Power reference guide](#)
- Texas Instruments, [Isolated Amplifier Voltage Sensing Excel Calculator design tool](#)
- Texas Instruments, [Best in Class Radiated Emissions EMI Performance with the AMC1300B-Q1 Isolated Amplifier technical white paper](#)
- Texas Instruments, [Isolated Voltage-Measurement Circuit With  \$\pm 250\$ -mV Input and Differential Output application note](#)

### 9.2 ドキュメントの更新通知を受け取る方法

ドキュメントの更新についての通知を受け取るには、[ti.com](http://ti.com) のデバイス製品フォルダを開いてください。「更新の通知を受け取る」をクリックして登録すると、変更されたすべての製品情報に関するダイジェストを毎週受け取れます。変更の詳細については、修正されたドキュメントに含まれている改訂履歴をご覧ください。

### 9.3 サポート・リソース

[TI E2E™ サポート・フォーラム](#)は、エンジニアが検証済みの回答と設計に関するヒントをエキスパートから迅速かつ直接得ることができる場所です。既存の回答を検索したり、独自の質問をしたりすることで、設計に必要な支援を迅速に得ることができます。

リンクされているコンテンツは、該当する貢献者により、現状のまま提供されるものです。これらは TI の仕様を構成するものではなく、必ずしも TI の見解を反映したものではありません。TI の[使用条件](#)を参照してください。

### 9.4 Trademarks

TI E2E™ is a trademark of Texas Instruments.

すべての商標は、それぞれの所有者に帰属します。

### 9.5 静電気放電に関する注意事項



この IC は、ESD によって破損する可能性があります。テキサス・インスツルメンツは、IC を取り扱う際には常に適切な注意を払うことを推奨します。正しい取り扱いおよび設置手順に従わない場合、デバイスを破損するおそれがあります。

ESD による破損は、わずかな性能低下からデバイスの完全な故障まで多岐にわたります。精密な IC の場合、パラメータがわずかに変化するだけで公表されている仕様から外れる可能性があるため、破損が発生しやすくなっています。

### 9.6 用語集

[テキサス・インスツルメンツ用語集](#) この用語集には、用語や略語の一覧および定義が記載されています。

## 10 Mechanical, Packaging, and Orderable Information

The following pages include mechanical, packaging, and orderable information. This information is the most current data available for the designated devices. This data is subject to change without notice and revision of this document. For browser-based versions of this data sheet, refer to the left-hand navigation.

**PACKAGING INFORMATION**

Orderable Device	Status (1)	Package Type	Package Drawing	Pins	Package Qty	Eco Plan (2)	Lead finish/ Ball material (6)	MSL Peak Temp (3)	Op Temp (°C)	Device Marking (4/5)	Samples
AMC1301DWV	ACTIVE	SOIC	DWV	8	64	RoHS & Green	NIPDAU	Level-3-260C-168 HR	-40 to 125	AMC1301	<a href="#">Samples</a>
AMC1301DWVR	ACTIVE	SOIC	DWV	8	1000	RoHS & Green	NIPDAU	Level-3-260C-168 HR	-40 to 125	AMC1301	<a href="#">Samples</a>
AMC1301SDWV	ACTIVE	SOIC	DWV	8	64	RoHS & Green	NIPDAU	Level-3-260C-168 HR	-55 to 125	AMC1301S	<a href="#">Samples</a>
AMC1301SDWVR	ACTIVE	SOIC	DWV	8	1000	RoHS & Green	NIPDAU	Level-3-260C-168 HR	-55 to 125	AMC1301S	<a href="#">Samples</a>

(1) The marketing status values are defined as follows:

**ACTIVE:** Product device recommended for new designs.

**LIFEBUY:** TI has announced that the device will be discontinued, and a lifetime-buy period is in effect.

**NRND:** Not recommended for new designs. Device is in production to support existing customers, but TI does not recommend using this part in a new design.

**PREVIEW:** Device has been announced but is not in production. Samples may or may not be available.

**OBSOLETE:** TI has discontinued the production of the device.

(2) **RoHS:** TI defines "RoHS" to mean semiconductor products that are compliant with the current EU RoHS requirements for all 10 RoHS substances, including the requirement that RoHS substance do not exceed 0.1% by weight in homogeneous materials. Where designed to be soldered at high temperatures, "RoHS" products are suitable for use in specified lead-free processes. TI may reference these types of products as "Pb-Free".

**RoHS Exempt:** TI defines "RoHS Exempt" to mean products that contain lead but are compliant with EU RoHS pursuant to a specific EU RoHS exemption.

**Green:** TI defines "Green" to mean the content of Chlorine (Cl) and Bromine (Br) based flame retardants meet JS709B low halogen requirements of <=1000ppm threshold. Antimony trioxide based flame retardants must also meet the <=1000ppm threshold requirement.

(3) MSL, Peak Temp. - The Moisture Sensitivity Level rating according to the JEDEC industry standard classifications, and peak solder temperature.

(4) There may be additional marking, which relates to the logo, the lot trace code information, or the environmental category on the device.

(5) Multiple Device Markings will be inside parentheses. Only one Device Marking contained in parentheses and separated by a "-" will appear on a device. If a line is indented then it is a continuation of the previous line and the two combined represent the entire Device Marking for that device.

(6) Lead finish/Ball material - Orderable Devices may have multiple material finish options. Finish options are separated by a vertical ruled line. Lead finish/Ball material values may wrap to two lines if the finish value exceeds the maximum column width.

**Important Information and Disclaimer:**The information provided on this page represents TI's knowledge and belief as of the date that it is provided. TI bases its knowledge and belief on information provided by third parties, and makes no representation or warranty as to the accuracy of such information. Efforts are underway to better integrate information from third parties. TI has taken and

continues to take reasonable steps to provide representative and accurate information but may not have conducted destructive testing or chemical analysis on incoming materials and chemicals. TI and TI suppliers consider certain information to be proprietary, and thus CAS numbers and other limited information may not be available for release.

In no event shall TI's liability arising out of such information exceed the total purchase price of the TI part(s) at issue in this document sold by TI to Customer on an annual basis.

**OTHER QUALIFIED VERSIONS OF AMC1301 :**

- Automotive : [AMC1301-Q1](#)

NOTE: Qualified Version Definitions:

- Automotive - Q100 devices qualified for high-reliability automotive applications targeting zero defects

**TAPE AND REEL INFORMATION**

**QUADRANT ASSIGNMENTS FOR PIN 1 ORIENTATION IN TAPE**

\*All dimensions are nominal

Device	Package Type	Package Drawing	Pins	SPQ	Reel Diameter (mm)	Reel Width W1 (mm)	A0 (mm)	B0 (mm)	K0 (mm)	P1 (mm)	W (mm)	Pin1 Quadrant
AMC1301DWVR	SOIC	DWV	8	1000	330.0	16.4	12.05	6.15	3.3	16.0	16.0	Q1
AMC1301DWVR	SOIC	DWV	8	1000	330.0	16.4	12.15	6.2	3.05	16.0	16.0	Q1
AMC1301DWVR	SOIC	DWV	8	1000	330.0	16.4	12.05	6.15	3.3	16.0	16.0	Q1
AMC1301SDWVR	SOIC	DWV	8	1000	330.0	16.4	12.05	6.15	3.3	16.0	16.0	Q1
AMC1301SDWVR	SOIC	DWV	8	1000	330.0	16.4	12.15	6.2	3.05	16.0	16.0	Q1
AMC1301SDWVR	SOIC	DWV	8	1000	330.0	16.4	12.05	6.15	3.3	16.0	16.0	Q1

**TAPE AND REEL BOX DIMENSIONS**

\*All dimensions are nominal

Device	Package Type	Package Drawing	Pins	SPQ	Length (mm)	Width (mm)	Height (mm)
AMC1301DWVR	SOIC	DWV	8	1000	350.0	350.0	43.0
AMC1301DWVR	SOIC	DWV	8	1000	356.0	356.0	35.0
AMC1301DWVR	SOIC	DWV	8	1000	350.0	350.0	43.0
AMC1301SDWVR	SOIC	DWV	8	1000	350.0	350.0	43.0
AMC1301SDWVR	SOIC	DWV	8	1000	356.0	356.0	35.0
AMC1301SDWVR	SOIC	DWV	8	1000	350.0	350.0	43.0

**TUBE**

\*All dimensions are nominal

Device	Package Name	Package Type	Pins	SPQ	L (mm)	W (mm)	T (μm)	B (mm)
AMC1301DWV	DWV	SOIC	8	64	505.46	13.94	4826	6.6
AMC1301SDWV	DWV	SOIC	8	64	505.46	13.94	4826	6.6



# PACKAGE OUTLINE

DWV0008A



SOIC - 2.8 mm max height

SOIC



4218796/A 09/2013

**NOTES:**

1. All linear dimensions are in millimeters. Dimensions in parenthesis are for reference only. Dimensioning and tolerancing per ASME Y14.5M.
2. This drawing is subject to change without notice.
3. This dimension does not include mold flash, protrusions, or gate burrs. Mold flash, protrusions, or gate burrs shall not exceed 0.15 mm, per side.
4. This dimension does not include interlead flash. Interlead flash shall not exceed 0.25 mm, per side.



LAND PATTERN EXAMPLE  
9.1 mm NOMINAL CLEARANCE/CREEPAGE  
SCALE:6X

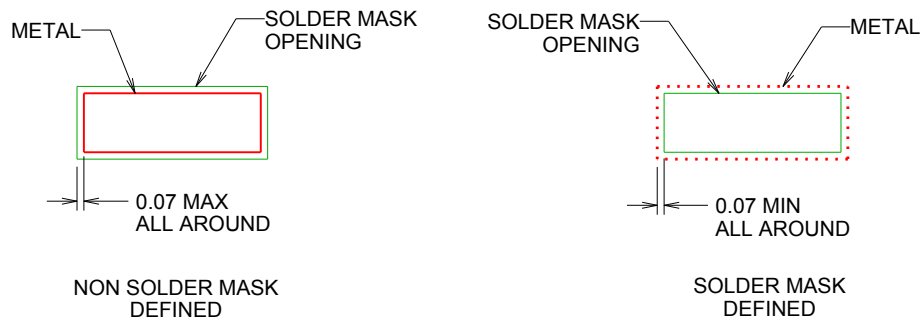

SOLDER MASK DETAILS

4218796/A 09/2013

NOTES: (continued)

- 5. Publication IPC-7351 may have alternate designs.
- 6. Solder mask tolerances between and around signal pads can vary based on board fabrication site.

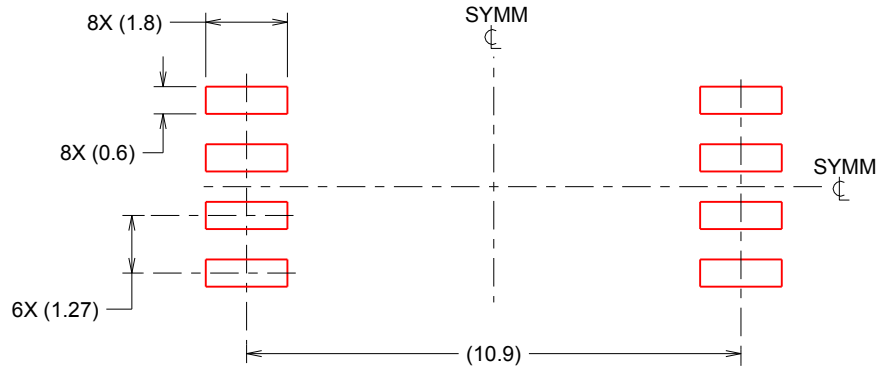

SOLDER PASTE EXAMPLE  
 BASED ON 0.125 mm THICK STENCIL  
 SCALE:6X

4218796/A 09/2013

NOTES: (continued)

- 7. Laser cutting apertures with trapezoidal walls and rounded corners may offer better paste release. IPC-7525 may have alternate design recommendations.
- 8. Board assembly site may have different recommendations for stencil design.

## 重要なお知らせと免責事項

TI は、技術データと信頼性データ（データシートを含みます）、設計リソース（リファレンス・デザインを含みます）、アプリケーションや設計に関する各種アドバイス、Web ツール、安全性情報、その他のリソースを、欠陥が存在する可能性のある「現状のまま」提供しており、商品性および特定目的に対する適合性の黙示保証、第三者の知的財産権の非侵害保証を含むいかなる保証も、明示的または黙示的にかかわらず拒否します。

これらのリソースは、TI 製品を使用する設計の経験を積んだ開発者への提供を意図したものです。(1) お客様のアプリケーションに適した TI 製品の選定、(2) お客様のアプリケーションの設計、検証、試験、(3) お客様のアプリケーションに該当する各種規格や、その他のあらゆる安全性、セキュリティ、規制、または他の要件への確実な適合に関する責任を、お客様のみが単独で負うものとし、

上記の各種リソースは、予告なく変更される可能性があります。これらのリソースは、リソースで説明されている TI 製品を使用するアプリケーションの開発の目的でのみ、TI はその使用をお客様に許諾します。これらのリソースに関して、他の目的で複製することや掲載することは禁止されています。TI や第三者の知的財産権のライセンスが付与されている訳ではありません。お客様は、これらのリソースを自身で使用した結果発生するあらゆる申し立て、損害、費用、損失、責任について、TI およびその代理人を完全に補償するものとし、TI は一切の責任を拒否します。

TI の製品は、[TI の販売条件](#)、または [ti.com](#) やかかる TI 製品の関連資料などのいずれかを通じて提供する適用可能な条項の下で提供されています。TI がこれらのリソースを提供することは、適用される TI の保証または他の保証の放棄の拡大や変更を意味するものではありません。

お客様がいかなる追加条項または代替条項を提案した場合でも、TI はそれらに異議を唱え、拒否します。

郵送先住所：Texas Instruments, Post Office Box 655303, Dallas, Texas 75265  
Copyright © 2024, Texas Instruments Incorporated