

# TPS2597xx 具有精确电流监视器和瞬态过流消隐功能的 2.7V 至 23V, 7A, 9.8mΩ 电子保险丝

## 1 特性

- 宽工作输入电压范围：2.7V 至 23V
  - 绝对最大值为 28V
- 具有低导通电阻的集成 FET： $R_{ON} = 9.8\text{m}\Omega$  (典型值)
- 快速过压保护
  - 过压钳位 (OVC)，可通过引脚选择阈值 (3.89V、5.76V 和 13.88V)，响应时间为  $5\mu\text{s}$  (典型值)，或
  - 可调节过压锁定 (OVLO)，响应时间为  $1.2\mu\text{s}$  (典型值)
- 过流保护，具有负载电流监控器输出 (ILM)
  - 主动电流限制或断路器选项
  - 可调节阈值 ( $I_{LIM}$ ) 0.87A 至 7.7A
    - $I_{LIM} > 1.74\text{A}$  时精度为  $\pm 10\%$
  - 可调瞬态消隐计时器 (ITIMER)，支持高达  $2 \times I_{LIM}$  的峰值电流
  - 输出负载电流监控精度： $\pm 8\%$  (最大值)
- 通过快速跳变响应实现短路保护
  - $550\text{ns}$  (典型值) 响应时间
  - 可调节 ( $2 \times I_{LIM}$ ) 和固定阈值
- 具有可调节欠压锁定阈值 (UVLO) 的高电平有效使能输入
- 可调节的输出压摆率控制 (dVdt)
- 过热保护
- 数字输出
  - 故障指示 ( $\overline{\text{FLT}}$ ) 或
  - 具有可调节阈值 (PGTH) 的电源正常状态指示 (PG)
- UL 2367 认证
  - 文件编号 E339631
  - $R_{ILM} \geq 750\Omega$
- 获得 IEC 62368-1 CB 认证
- 小尺寸：QFN 2mm × 2mm，0.45mm 间距

## 2 应用

- 服务器、PC 主板和插件卡
- 企业级存储 - RAID/HBA/SAN/eSSD
- 患者监护仪
- 电器和电动工具
- 零售销售点终端
- 智能手机和平板电脑

## 3 说明

TPS2597xx 系列电子保险丝是采用小型封装的高度集成电路保护和电源管理解决方案。此类器件只需很少的外部元件即可提供多种保护模式，能够非常有效地抵御过载、短路、电压浪涌和过多浪涌电流。

可以使用单个外部电容器来调节输出压摆率和浪涌电流。通过将输出钳制到安全的固定最大电压 (可通过引脚选择) 或在输入超过可调过压阈值时切断输出，可以保护负载免受输入过压情况的影响。此类器件通过主动限制电流或断开电路来响应输出过载。用户可以调节输出电流限值阈值以及瞬态过流消隐计时器。电流限值控制引脚还用作模拟负载电流监控器。

此类器件采用 2mm × 2mm 10 引脚 HotRod™ QFN 封装，旨在改善热性能并减小系统尺寸。

此类器件的额定工作结温范围为  $-40^{\circ}\text{C}$  至  $+125^{\circ}\text{C}$ 。

### 封装信息

器件型号	封装 <sup>(1)</sup>	封装尺寸 <sup>(2)</sup>
TPS2597xxRPW	RPW (QFN, 10)	2.00mm × 2.00mm

- 如需了解所有可用封装，请参阅数据表末尾的可订购产品附录。
- 封装尺寸 (长 × 宽) 为标称值，并包括引脚 (如适用)。

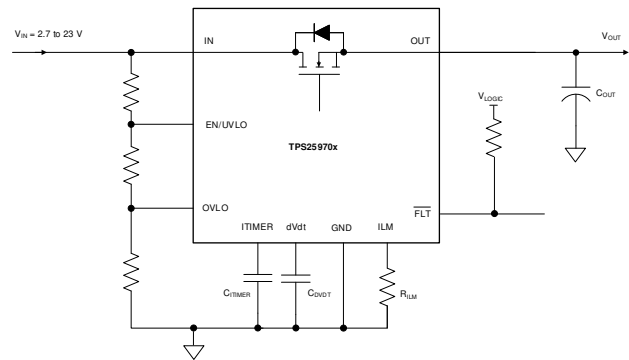

简化版原理图



## Table of Contents

<b>1 特性</b> .....	<b>1</b>	7.4 Device Functional Modes.....	<b>34</b>
<b>2 应用</b> .....	<b>1</b>	<b>8 Application and Implementation</b> .....	<b>35</b>
<b>3 说明</b> .....	<b>1</b>	8.1 Application Information.....	<b>35</b>
<b>4 Device Comparison Table</b> .....	<b>3</b>	8.2 Typical Application.....	<b>36</b>
<b>5 Pin Configuration and Functions</b> .....	<b>4</b>	8.3 Parallel Operation.....	<b>40</b>
<b>6 Specifications</b> .....	<b>5</b>	8.4 Power Supply Recommendations.....	<b>42</b>
6.1 Absolute Maximum Ratings.....	<b>5</b>	8.5 Layout.....	<b>44</b>
6.2 ESD Ratings.....	<b>5</b>	<b>9 Device and Documentation Support</b> .....	<b>46</b>
6.3 Recommended Operating Conditions.....	<b>5</b>	9.1 Device Support.....	<b>46</b>
6.4 Thermal Information.....	<b>6</b>	9.2 Documentation Support.....	<b>46</b>
6.5 Electrical Characteristics.....	<b>7</b>	9.3 接收文档更新通知.....	<b>46</b>
6.6 Timing Requirements.....	<b>8</b>	9.4 支持资源.....	<b>46</b>
6.7 Switching Characteristics.....	<b>10</b>	9.5 Trademarks.....	<b>46</b>
6.8 Typical Characteristics.....	<b>11</b>	9.6 静电放电警告.....	<b>46</b>
<b>7 Detailed Description</b> .....	<b>19</b>	9.7 术语表.....	<b>46</b>
7.1 Overview.....	<b>19</b>	<b>10 Revision History</b> .....	<b>46</b>
7.2 Functional Block Diagram.....	<b>20</b>	<b>11 Mechanical, Packaging, and Orderable Information</b> .....	<b>48</b>
7.3 Feature Description.....	<b>23</b>		

## 4 Device Comparison Table

PART NUMBER	OVERVOLTAGE RESPONSE	OVERCURRENT RESPONSE	PG and PGTH	FLT	RESPONSE TO FAULT
TPS25970ARPW	Adjustable OVLO	Active Current Limit	N	Y	Auto-Retry
TPS25970LRPW					Latch-Off
TPS25972ARPW	Pin Selectable OVC (3.89 V/5.76 V/13.88 V)		Y	N	Auto-Retry
TPS25972LRPW					Latch-Off
TPS25974ARPW	Adjustable OVLO	Circuit Breaker			Auto-Retry
TPS25974LRPW					Latch-Off

## 5 Pin Configuration and Functions



图 5-1. TPS2597xx RPW Package 10-Pin QFN (Top View)

表 5-1. Pin Functions

PIN		TYPE	DESCRIPTION
NAME	NO.		
EN/UVLO	1	Analog Input	Active high enable for the device. A resistor divider on this pin from input supply to GND can be used to adjust the undervoltage lockout threshold. <i>Do not leave floating.</i> Refer to <a href="#">Undervoltage Lockout (UVLO and UVP)</a> for details.
OVLO	2	Analog Input	<i>TPS25970x and TPS25974x:</i> A resistor divider on this pin from supply to GND can be used to adjust the overvoltage lockout threshold. This pin can also be used as an active low enable for the device. <i>Do not leave floating.</i> Refer to <a href="#">Overvoltage Lockout (OVLO)</a> for details.
OVCSEL		Analog Input	<i>TPS25972x:</i> Overvoltage clamp threshold select pin. Refer to <a href="#">Overvoltage Clamp (OVC)</a> for details.
PG	3	Digital Output	<i>TPS25972x and TPS25974x:</i> Power-good indication. This is an open-drain signal, which is asserted high when the internal powerpath is fully turned ON and the PGTH input exceeds a certain threshold. Refer to <a href="#">Power Good Indication (PG)</a> for more details.
DNC		Digital Output	<i>TPS25970x:</i> Can be left floating
FLT	4	Digital Output	<i>TPS25970x:</i> Active low fault event indicator. This pin is an open-drain signal that is pulled low when a fault is detected. Refer to <a href="#">Fault Response and Indication (FLT)</a> for more details.
PGTH		Analog Input	<i>TPS25972x and TPS25974x:</i> Power-good threshold. Refer to <a href="#">Power Good Indication (PG)</a> for more details.
IN	5	Power	Power input
OUT	6	Power	Power output
DVDT	7	Analog Output	A capacitor from this pin to GND sets the output turn on slew rate. Leave this pin floating for the fastest turn on slew rate. Refer to <a href="#">Slew Rate (dVdt) and Inrush Current Control</a> for details.
GND	8	Ground	This pin is the ground reference for all internal circuits and must be connected to system GND.
ILM	9	Analog Output	This pin is a dual function pin used to limit and monitor the output current. An external resistor from this pin to GND sets the output current limit threshold during start-up as well as steady state. The pin voltage can also be used as analog output load current monitor signal. <i>Do not leave floating.</i> Refer to <a href="#">Circuit-Breaker</a> or <a href="#">Active Current Limiting</a> for more details.
ITIMER	10	Analog Output	A capacitor from this pin to GND sets the overcurrent blanking interval during which the output current can temporarily exceed set current limit (but lower than fast-trip threshold) before the device overcurrent response takes action. Leave this pin open for the fastest response to overcurrent events. Refer to <a href="#">Circuit-Breaker</a> or <a href="#">Active Current Limiting</a> for more details.

## 6 Specifications

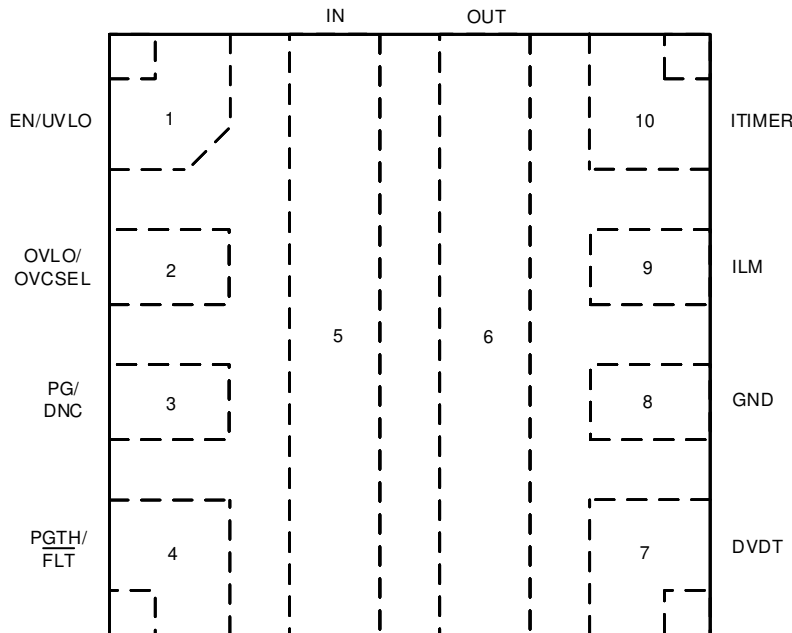
### 6.1 Absolute Maximum Ratings

over operating free-air temperature range (unless otherwise noted)<sup>(1)</sup>

Parameter		Pin	MIN	MAX	UNIT
V <sub>IN</sub>	Maximum input voltage range, -40 °C ≤ T <sub>J</sub> ≤ 125 °C	IN	-0.3	28	V
SR <sub>IN(R)</sub>	Maximum input voltage rising slew rate	IN		100	V/μs
SR <sub>IN(F)</sub>	Maximum input voltage falling slew rate	IN		10	V/μs
V <sub>OUT</sub>	Maximum output voltage range, -40 °C ≤ T <sub>J</sub> ≤ 125 °C	OUT	-0.3	V <sub>IN</sub> + 0.3	
V <sub>OUT,PLS</sub>	Minimum output voltage pulse (< 1 μs)	OUT	-0.8		
V <sub>EN/UVLO</sub>	Maximum Enable pin voltage range	EN/UVLO	-0.3	6.5	V
V <sub>OV</sub>	Maximum OVSEL/OVLO pin voltage range	OVSEL/OVLO	-0.3	6.5	V
V <sub>dVdT</sub>	Maximum dVdT pin voltage range	dVdT	Internally limited		V
V <sub>ITIMER</sub>	Maximum ITIMER pin voltage range	ITIMER	Internally limited		V
V <sub>PGTH</sub>	Maximum PGTH pin voltage range	PGTH	-0.3	6.5	V
V <sub>PG</sub>	Maximum PG pin voltage range	PG	-0.3	6.5	V
V <sub>FLT</sub>	Maximum FLT pin voltage range	FLT	-0.3	6.5	V
V <sub>ILM</sub>	Maximum ILM pin voltage range	ILM	Internally limited		V
I <sub>MAX</sub>	Maximum continuous switch current	IN to OUT	Internally limited		A
T <sub>J</sub>	Junction temperature		Internally limited		°C
T <sub>LEAD</sub>	Maximum lead temperature			300	°C
T <sub>stg</sub>	Storage temperature		-65	150	°C

- (1) Operation outside the Absolute Maximum Ratings may cause permanent device damage. Absolute Maximum Ratings do not imply functional operation of the device at these or any other conditions beyond those listed under Recommended Operating Conditions. If used outside the Recommended Operating Conditions but within the Absolute Maximum Ratings, the device may not be fully functional, and this may affect device reliability, functionality, performance, and shorten the device lifetime.

### 6.2 ESD Ratings

			VALUE	UNIT
V <sub>(ESD)</sub>	Electrostatic discharge	Human body model (HBM), per ANSI/ESDA/JEDEC JS-001 <sup>(1)</sup>	±2000	V
		Charged device model (CDM), per ANSI/ESDA/JEDEC JS-002 <sup>(2)</sup>	±500	

- (1) JEDEC document JEP155 states that 500-V HBM allows safe manufacturing with a standard ESD control process.  
(2) JEDEC document JEP157 states that 250-V CDM allows safe manufacturing with a standard ESD control process.

### 6.3 Recommended Operating Conditions

over operating free-air temperature range (unless otherwise noted)

Parameter		Pin	MIN	MAX	UNIT
V <sub>IN</sub>	Input voltage range	IN	2.7	23 <sup>(1)</sup>	V
V <sub>OUT</sub>	Output voltage range	OUT		V <sub>IN</sub>	V
V <sub>EN/UVLO</sub>	EN/UVLO pin voltage range	EN/UVLO		5 <sup>(2)</sup>	V
V <sub>OV</sub>	OVLO pin voltage range (TPS25970x and TPS25974x variants only)	OVLO	0.5	1.5	V
V <sub>dVdT</sub>	dVdT pin capacitor voltage rating	dVdT	V <sub>IN</sub> + 5 V		V
V <sub>PGTH</sub>	PGTH pin voltage range	PGTH		5	V
V <sub>FLT</sub>	FLT pin voltage range	FLT		5	V
V <sub>PG</sub>	PG pin voltage range	PG		5	V

### 6.3 Recommended Operating Conditions (续)

over operating free-air temperature range (unless otherwise noted)

Parameter		Pin	MIN	MAX	UNIT
$V_{ITIMER}$	ITIMER pin capacitor voltage rating	ITIMER	4		V
$R_{ILM}$	ILM pin resistance to GND	ILM	715	6650	$\Omega$
$I_{MAX}$	Continuous switch current, $T_J \leq 125^\circ\text{C}$	IN to OUT		7	A
$T_J$	Junction temperature		- 40	125	$^\circ\text{C}$

- (1) For TPS25972x OVC variants, the input operating voltage should be limited to the selected Output Voltage Clamp Option as listed in the Electrical Characteristics section
- (2) For supply voltages below 5V, it is okay to pull up the EN pin to IN directly. For supply voltages greater than 5V, it is recommended to use a resistor divider with minimum pull-up resistor value of 350 k $\Omega$ .

### 6.4 Thermal Information

THERMAL METRIC <sup>(1)</sup>		TPS2597xx	UNIT
		RPW (QFN)	
		10 PINS	
$R_{\theta JA}$	Junction-to-ambient thermal resistance	49.7 <sup>(2)</sup>	$^\circ\text{C/W}$
		71.8 <sup>(3)</sup>	$^\circ\text{C/W}$
$R_{\theta JB}$	Junction-to-board thermal resistance	15.7	$^\circ\text{C/W}$
$\Psi_{JT}$	Junction-to-top characterization parameter	2.1 <sup>(2)</sup>	$^\circ\text{C/W}$
	Junction-to-top characterization parameter	1.3 <sup>(3)</sup>	$^\circ\text{C/W}$
$\Psi_{JB}$	Junction-to-board characterization parameter	23 <sup>(2)</sup>	$^\circ\text{C/W}$
		14.5 <sup>(3)</sup>	$^\circ\text{C/W}$

- (1) For more information about traditional and new thermal metrics, see the [Semiconductor and IC Package Thermal Metrics](#) application report.
- (2) Based on simulations conducted with the device mounted on a custom 4-layer PCB (2s2p) with 8 thermal vias under device
- (3) Based on simulations conducted with the device mounted on a JEDEC 4-layer PCB (2s2p) with no thermal vias under device

## 6.5 Electrical Characteristics

(Test conditions unless otherwise noted) -  $40^{\circ}\text{C} \leq T_J \leq 125^{\circ}\text{C}$ ,  $V_{IN} = 12\text{ V}$ ,  $\text{OUT} = \text{Open}$ ,  $V_{EN/UVLO} = 2\text{ V}$ ,  $V_{OVLO} = 0\text{ V}$  for TPS25970x/4x,  $\text{OVCSEL} = 390\text{ k}\Omega$  to GND for TPS25972x,  $R_{ILM} = 715\ \Omega$ ,  $\text{dVdT} = \text{Open}$ ,  $\text{ITIMER} = \text{Open}$ ,  $\overline{\text{FLT}} = \text{Open}$  for TPS25970x,  $\text{PGTH} = \text{Open}$  for TPS25972x/4x,  $\text{PG} = \text{Open}$  for TPS25972x/4x. All voltages referenced to GND.

Test Parameter	Description	MIN	TYP	MAX	UNITS
<b>INPUT SUPPLY (IN)</b>					
$I_{Q(\text{ON})}$	IN supply quiescent current (TPS25970x)		413	650	$\mu\text{A}$
	IN supply quiescent current (TPS25972x)		407	650	$\mu\text{A}$
	IN supply quiescent current (TPS25974x)		413	650	$\mu\text{A}$
	IN supply quiescent current during OVC (TPS25972x)		429	650	$\mu\text{A}$
$I_{Q(\text{OFF})}$	IN supply OFF state current ( $V_{SD(F)} < V_{EN} < V_{UVLO(F)}$ )		67	131	$\mu\text{A}$
$I_{SD}$	IN supply shutdown current ( $V_{EN} < V_{SD(F)}$ )		2.3	25	$\mu\text{A}$
$V_{UVP(R)}$	IN supply UVP rising threshold	2.44	2.54	2.64	V
$V_{UVP(F)}$	IN supply UVP falling threshold	2.35	2.45	2.55	V
<b>OUTPUT VOLTAGE CLAMP (OUT) - TPS25972x</b>					
$V_{OVC}$	Overvoltage Clamp threshold, OVCSEL = Shorted to GND	3.65	3.89	4.1	V
	Overvoltage Clamp threshold, OVCSEL = Open	5.25	5.76	6.2	V
	Overvoltage Clamp threshold, OVCSEL = 390 k $\Omega$ to GND	13.2	13.88	14.5	V
$V_{CLAMP}$	Output voltage during clamping, OVCSEL = Shorted to GND, $I_{OUT} = 10\text{ mA}$	3.2	3.82	4.2	V
	Output voltage during clamping, OVCSEL = Open, $I_{OUT} = 10\text{ mA}$	5	5.68	6.12	V
	Output voltage during clamping, OVCSEL = 390 k $\Omega$ to GND, $I_{OUT} = 10\text{ mA}$	13	13.79	14.6	V
<b>OUTPUT LOAD CURRENT MONITOR (ILM)</b>					
$G_{IMON}$	Analog load current monitor gain ( $I_{MON} : I_{OUT}$ ), $1\text{ A} \leq I_{OUT} \leq 7.7\text{ A}$ , $I_{OUT} < I_{LIM}$	98	105.5	114	$\mu\text{A/A}$
<b>OVERCURRENT PROTECTION (OUT)</b>					
$I_{LIM}$	Overcurrent threshold, $R_{ILM} = 6.65\text{ K}\Omega$	0.745	0.87	0.97	A
	Overcurrent threshold, $R_{ILM} = 3.32\text{ K}\Omega$	1.55	1.73	1.905	A
	Overcurrent threshold, $R_{ILM} = 1.65\text{ K}\Omega$	3.2	3.48	3.715	A
	Overcurrent threshold, $R_{ILM} = 750\ \Omega$	7.03	7.67	8.15	A
$I_{SPFLT}$	Circuit-Breaker threshold, ILM pin open (Single point failure)			0.1	A
$I_{SPFLT}$	Circuit-Breaker threshold, ILM pin shorted to GND (Single point failure)		2	3.1	A
$I_{SCGain}$	Scalable fast-trip threshold ( $I_{SC}$ ) : $I_{LIM}$ ratio	170	201	240	%
VFB	$V_{OUT}$ threshold to exit current limit foldback	1.55	1.88	2.23	V
<b>ON RESISTANCE (IN - OUT)</b>					
$R_{ON}$	$2.7 \leq V_{IN} \leq 4\text{ V}$ , $I_{OUT} = 3\text{ A}$ , $T_J = 25^{\circ}\text{C}$		10	18.3	$\text{m}\Omega$
	$4 < V_{IN} \leq 23\text{ V}$ , $I_{OUT} = 3\text{ A}$ , $T_J = 25^{\circ}\text{C}$		9.8	18.3	$\text{m}\Omega$
<b>ENABLE/UNDERVOLTAGE LOCKOUT (EN/UVLO)</b>					
$V_{UVLO(R)}$	EN/UVLO rising threshold	1.183	1.2	1.228	V
$V_{UVLO(F)}$	EN/UVLO falling threshold	1.076	1.1	1.12	V
$V_{SD(F)}$	EN/UVLO falling threshold for lowest shutdown current	0.45	0.75	0.95	V
$I_{ENLKG}$	EN/UVLO pin leakage current	-0.1		0.1	$\mu\text{A}$
<b>OVERVOLTAGE LOCKOUT (OVLO) - TPS25970x/4x</b>					
$V_{OV(R)}$	OVLO rising threshold	1.183	1.2	1.228	V

## 6.5 Electrical Characteristics (续)

(Test conditions unless otherwise noted) -  $40^{\circ}\text{C} \leq T_J \leq 125^{\circ}\text{C}$ ,  $V_{IN} = 12\text{ V}$ ,  $\text{OUT} = \text{Open}$ ,  $V_{EN/UVLO} = 2\text{ V}$ ,  $V_{OVLO} = 0\text{ V}$  for TPS25970x/4x,  $\text{OVSEL} = 390\text{ k}\Omega$  to GND for TPS25972x,  $R_{ILIM} = 715\ \Omega$ ,  $\text{dVdt} = \text{Open}$ ,  $\text{ITIMER} = \text{Open}$ ,  $\text{FLT} = \text{Open}$  for TPS25970x,  $\text{PGTH} = \text{Open}$  for TPS25972x/4x,  $\text{PG} = \text{Open}$  for TPS25972x/4x. All voltages referenced to GND.

Test Parameter	Description	MIN	TYP	MAX	UNITS
$V_{OV(F)}$	OVLO falling threshold	1.076	1.1	1.12	V
$I_{OVLKG}$	OVLO pin leakage current ( $0.5\text{ V} < V_{OVLO} < 1.5\text{ V}$ )	-0.1		0.1	$\mu\text{A}$
<b>OVERCURRENT FAULT TIMER (ITIMER)</b>					
$I_{ITIMER}$	ITIMER pin internal discharge current, $I_{OUT} > I_{LIM}$	1.5	2	2.72	$\mu\text{A}$
$R_{ITIMER}$	ITIMER pin internal pull-up resistance		13.8	35	$\text{k}\Omega$
$V_{INT}$	ITIMER pin internal pull-up voltage	2.1	2.57	2.74	V
$V_{ITIMER(F)}$	ITIMER comparator threshold, $I_{OUT} > I_{LIM}$	0.609	1.05	1.37	V
$\Delta V_{ITIMER}$	ITIMER discharge differential voltage threshold, $I_{OUT} > I_{LIM}$	1.286	1.52	1.741	V
<b>POWER GOOD INDICATION (PG) - TPS25972x/4x</b>					
$V_{PGD}$	PG pin voltage while de-asserted. $V_{IN} < V_{UVP(F)}$ , $V_{EN} < V_{SD(F)}$ , Weak pull-up ( $I_{PG} = 26\ \mu\text{A}$ )		663	1000	mV
	PG pin voltage while de-asserted. $V_{IN} < V_{UVP(F)}$ , $V_{EN} < V_{SD(F)}$ , Strong pull-up ( $I_{PG} = 242\ \mu\text{A}$ )		782	1000	mV
	PG pin voltage while de-asserted, $V_{IN} > V_{UVP(R)}$		0	600	mV
$I_{PGLKG}$	PG pin leakage current, PG asserted			3	$\mu\text{A}$
<b>POWERGOOD THRESHOLD (PGTH)</b>					
$V_{PGTH(R)}$	PGTH rising threshold	1.178	1.2	1.23	V
$V_{PGTH(F)}$	PGTH falling threshold	1.071	1.1	1.13	V
$I_{PGTHLKG}$	PGTH pin leakage current	-1		1	$\mu\text{A}$
<b>FAULT INDICATION (FLT) - TPS25970x</b>					
$I_{FLTLKG}$	FLT pin leakage current	-1		1	$\mu\text{A}$
$R_{FLT}$	FLT pin internal pull-down resistance		12.4		$\Omega$
<b>OVERTEMPERATURE PROTECTION (OTP)</b>					
TSD	Thermal Shutdown rising threshold, $T_J \uparrow$		154		$^{\circ}\text{C}$
$TSD_{HYS}$	Thermal Shutdown hysteresis, $T_J \downarrow$		10		$^{\circ}\text{C}$
<b>DVDT</b>					
$I_{dVdt}$	dVdt pin internal charging current	1.4	3.4	5.7	$\mu\text{A}$

## 6.6 Timing Requirements

PARAMETER		TEST CONDITIONS	MIN	TYP	MAX	UNIT
$t_{OVLO}$	Overvoltage lock-out response time	TPS25970x and TPS25974x, $V_{OVLO} > V_{OV(R)}$ to $V_{OUT} \downarrow$		1.2		$\mu\text{s}$
$t_{OVC}$	Overvoltage clamp response time	TPS25972x, $V_{IN} > V_{OVC}$ to $V_{OUT} \downarrow$		5		$\mu\text{s}$
$t_{CB}$	Circuit-Breaker response time	TPS25974x, $I_{OUT} > I_{LIM} + 30\%$ to $V_{OUT} \downarrow$		2		$\mu\text{s}$
$t_{LIM}$	Current limit response time	TPS25970x and TPS25972x, $I_{OUT} > I_{LIM} + 30\%$ to $I_{OUT}$ settling to within 5% of $I_{LIM}$		465		$\mu\text{s}$
$t_{SC}$	Short-circuit response time	$I_{OUT} > 3x I_{LIM}$ to output current cut off		550		ns
$t_{FT}$	Fixed fast-trip response time	$I_{OUT} > I_{FT}$ to $I_{OUT} \downarrow$		550		ns
$t_{TSD,RST}$	Thermal Shutdown auto-retry Interval	Device enabled and $T_J < TSD - TSD_{HYS}$		110		ms
$t_{PGA}$	PG assertion de-glitch time	$V_{PGTH} > V_{PGTH(R)}$ to PG $\uparrow$		14		$\mu\text{s}$



PARAMETER		TEST CONDITIONS	MIN	TYP	MAX	UNIT
t <sub>PGD</sub>	PG de-assertion de-glitch time	V <sub>PGTH</sub> < V <sub>PGTH(F)</sub> to PG ↓		14		μs

## 6.7 Switching Characteristics

The output rising slew rate is internally controlled and constant across the entire operating voltage range to ensure the turn on timing is not affected by the load conditions. The rising slew rate can be adjusted by adding capacitance from the dVdt pin to ground. As  $C_{dVdt}$  is increased it will slow the rising slew rate (SR). See Slew Rate and Inrush Current Control (dVdt) section for more details. The Turn-Off Delay and Fall Time, however, are dependent on the RC time constant of the load capacitance ( $C_{OUT}$ ) and Load Resistance ( $R_L$ ). The Switching Characteristics are only valid for the power-up sequence where the supply is available in steady state condition and the load voltage is completely discharged before the device is enabled. Typical values are taken at  $T_J = 25^\circ\text{C}$  unless specifically noted otherwise.  $R_L = 100\ \Omega$ ,  $C_{OUT} = 1\ \mu\text{F}$ .

PARAMETER		$V_{IN}$	$C_{dVdt} = \text{Open}$	$C_{dVdt} = 1800\ \text{pF}$	$C_{dVdt} = 3300\ \text{pF}$	UNITS
$SR_{ON}$	Output rising slew rate	2.7 V	8.922	1.218	0.72	V/ms
		12 V	21.45	1.562	0.901	
		23 V	34.16	1.761	1.003	
$t_{D,ON}$	Turn on delay	2.7 V	0.138	0.505	0.79	ms
		12 V	0.145	0.979	1.659	
		23 V	0.15	1.478	2.562	
$t_R$	Rise time	2.7 V	0.242	1.771	2.993	ms
		12 V	0.446	6.131	10.63	
		23 V	0.538	10.43	18.31	
$t_{ON}$	Turn on time	2.7 V	0.379	2.277	3.783	ms
		12 V	0.582	7.11	12.29	
		23 V	0.668	11.91	20.87	
$t_{D,OFF}$	Turn off delay	2.7 V	22.1	22.1	22.1	$\mu\text{s}$
		12 V	18.9	18.9	18.9	
		23 V	16.5	16.5	16.5	

## 6.8 Typical Characteristics



图 6-1. ON-Resistance vs Supply Voltage



图 6-2. IN Quiescent Current vs Temperature (TPS25970x, TPS25974x Variants)

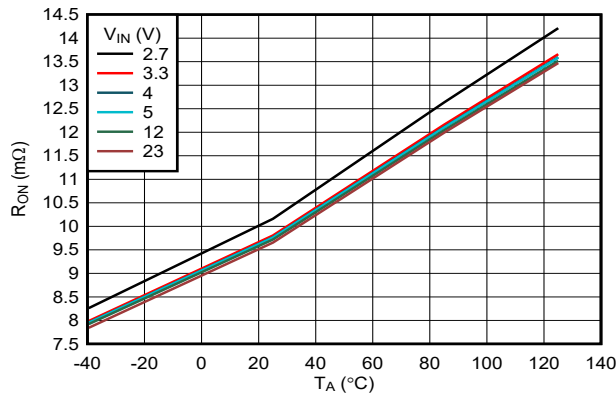

图 6-3. IN Quiescent Current vs Temperature (TPS25972x Variant)

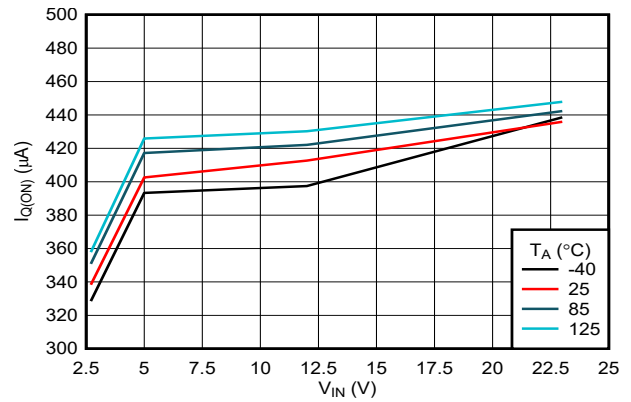

图 6-4. IN OFF State (UVLO) Current vs Temperature

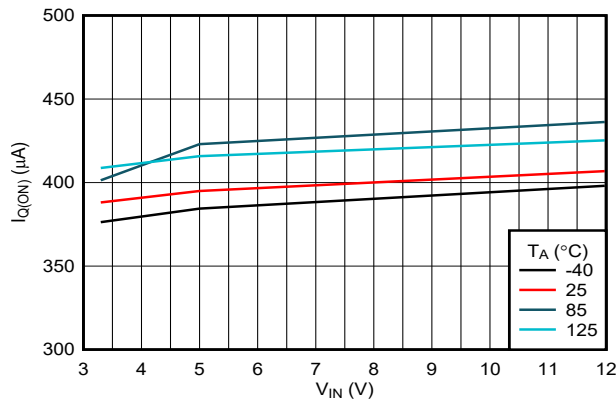

图 6-5. IN Shutdown Current vs Temperature

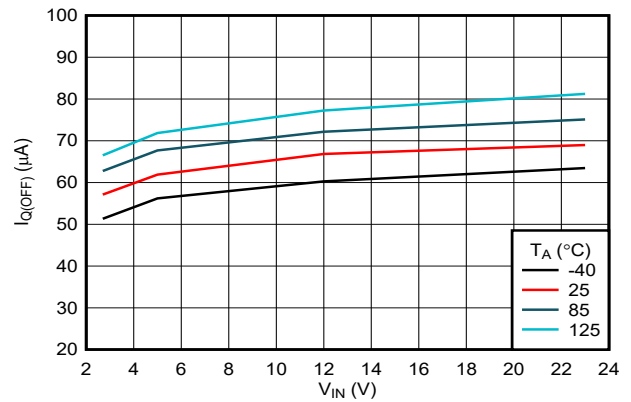

图 6-6. IN Undervoltage Threshold vs Temperature

### 6.8 Typical Characteristics (continued)

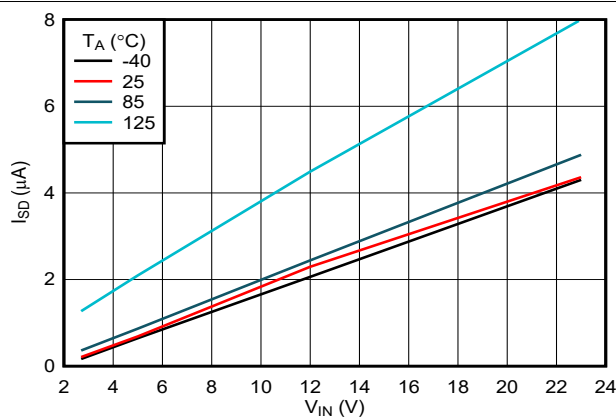

图 6-7. EN/UVLO Rising Threshold vs Temperature

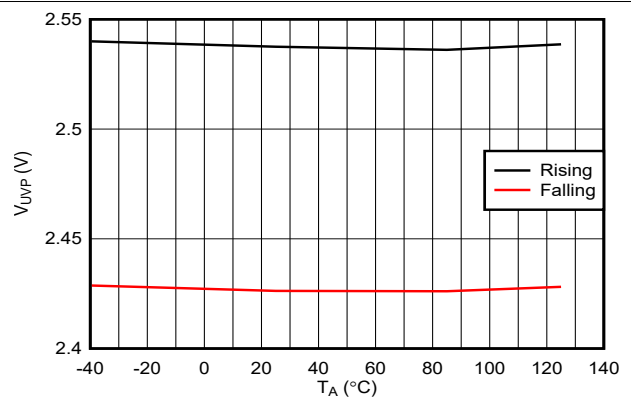

图 6-8. EN/UVLO Falling Threshold vs Temperature

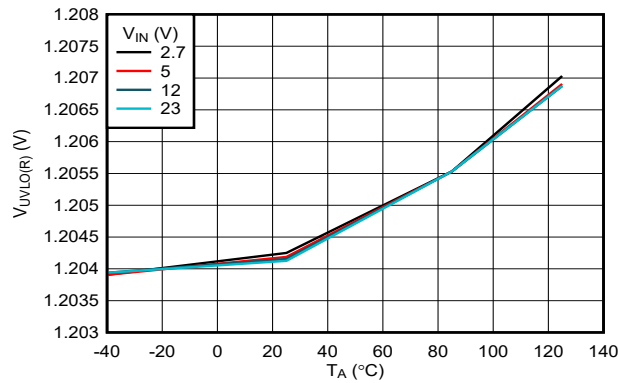

图 6-9. EN/UVLO Shutdown Falling Threshold vs Temperature

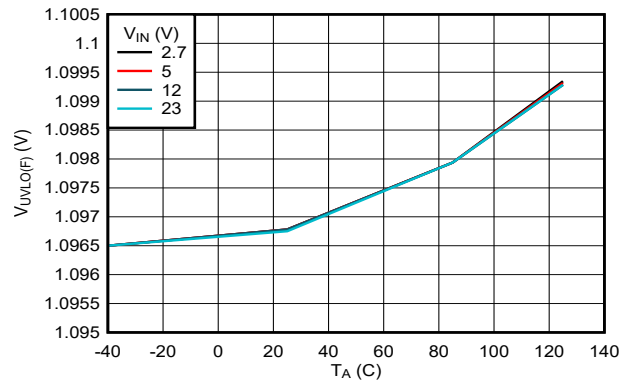

图 6-10. OVLO Rising Threshold vs Temperature (TPS25970x, TPS25974x Variants)

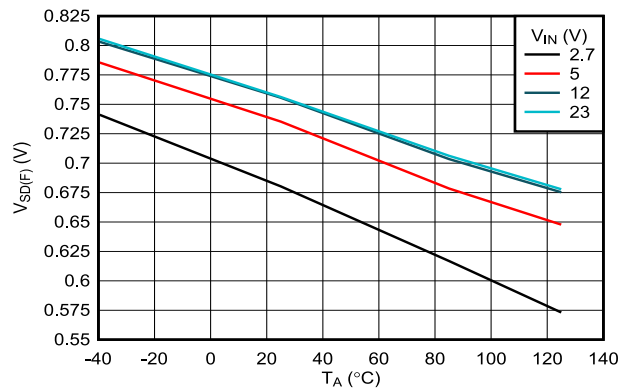

图 6-11. OVLO Falling Threshold vs Temperature (TPS25970x, TPS25974x Variants)

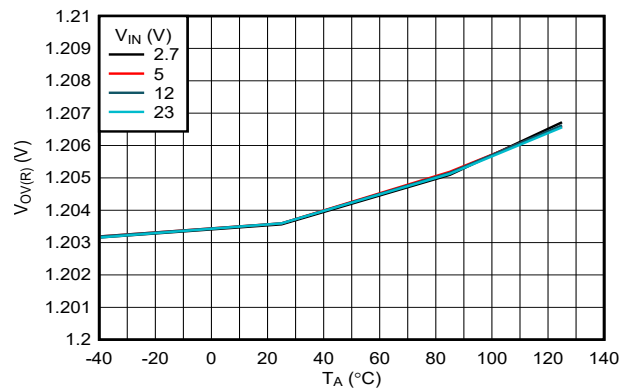

图 6-12. Overcurrent Threshold vs ILM Resistor

### 6.8 Typical Characteristics (continued)

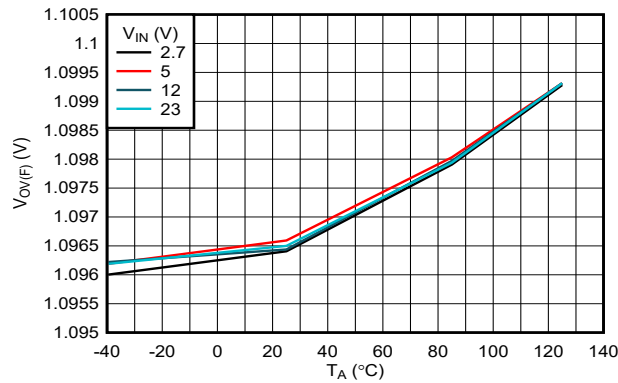

图 6-13. Overcurrent Threshold Accuracy (Across Process, Voltage and Temperature)

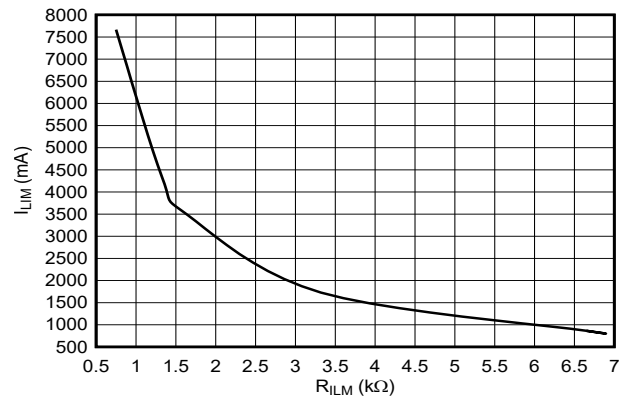

图 6-14. Analog Current Monitor Gain Accuracy

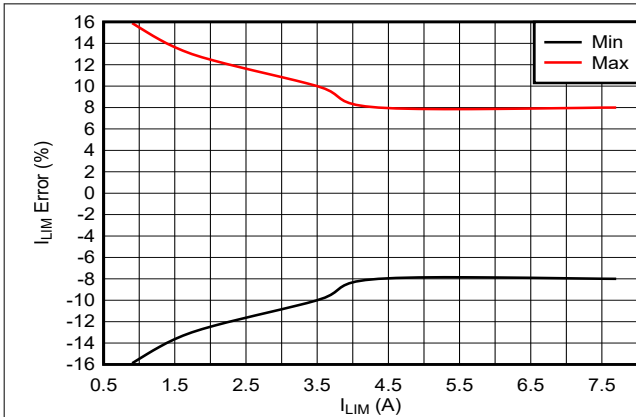

图 6-15. Scalable Fast-Trip Threshold: Current Limit Threshold ( $I_{LIM}$ ) Ratio vs Temperature

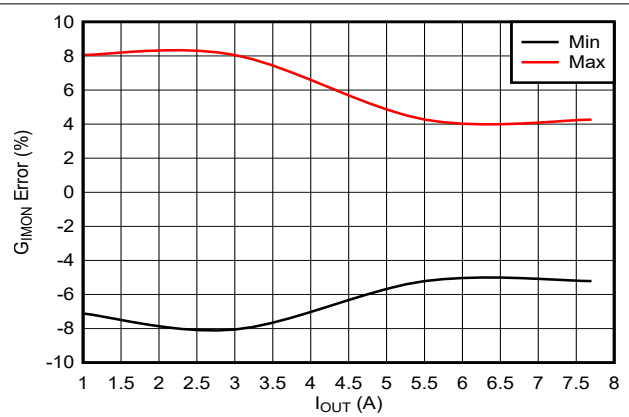

图 6-16. OVC Threshold vs Temperature (TPS25972x Variant)

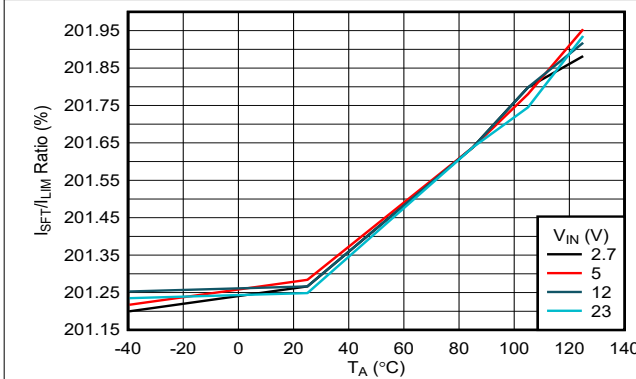

图 6-17. OVC Clamping Voltage (OVCSEL = 390 kΩ to GND) vs Load Current (TPS25972x Variant)

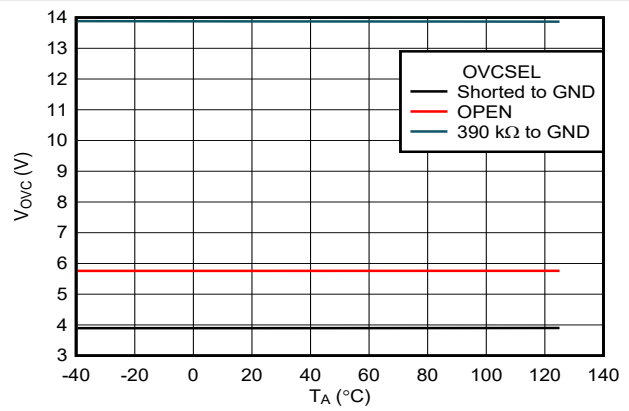

图 6-18. OVC Clamping Voltage (OVCSEL = OPEN) vs Load Current (TPS25972x Variant)

### 6.8 Typical Characteristics (continued)

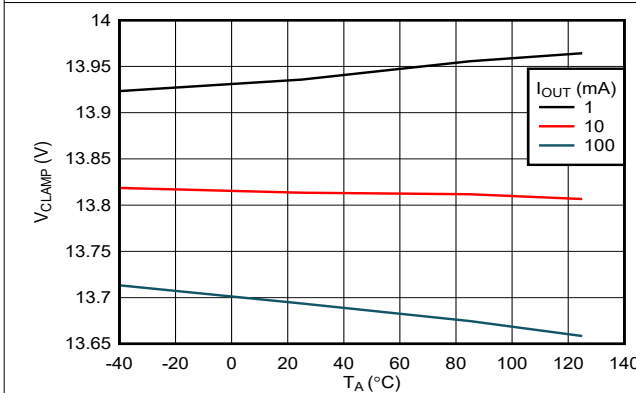

图 6-19. OVC Clamping Voltage (OVCSEL = GND) vs Load Current (TPS25972x Variant)

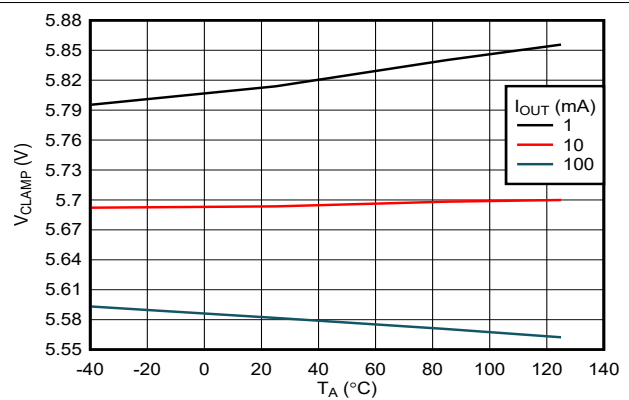

图 6-20. ITIMER Discharge Differential Voltage Threshold vs Temperature

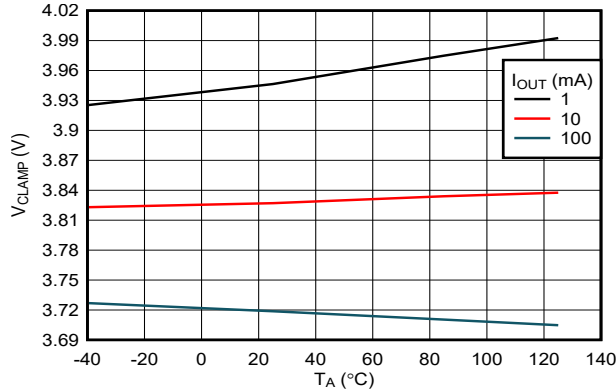

图 6-21. ITIMER Discharge Current vs Temperature

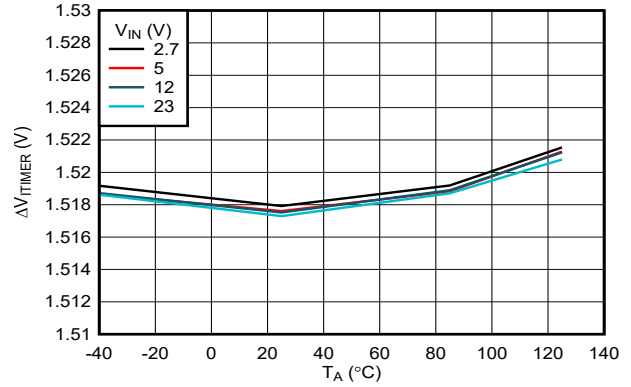

图 6-22. ITIMER Internal Pullup Resistance vs Temperature

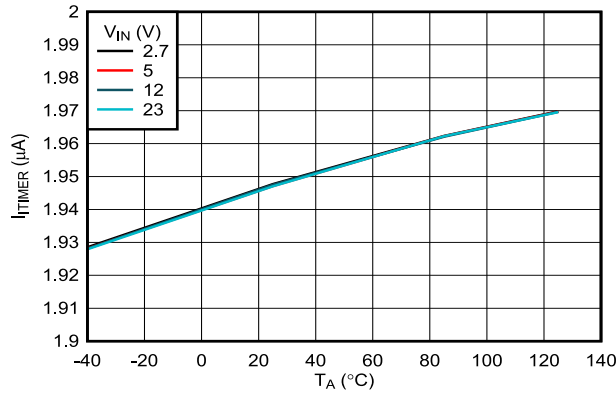

图 6-23. ITIMER internal Pullup Voltage vs Temperature

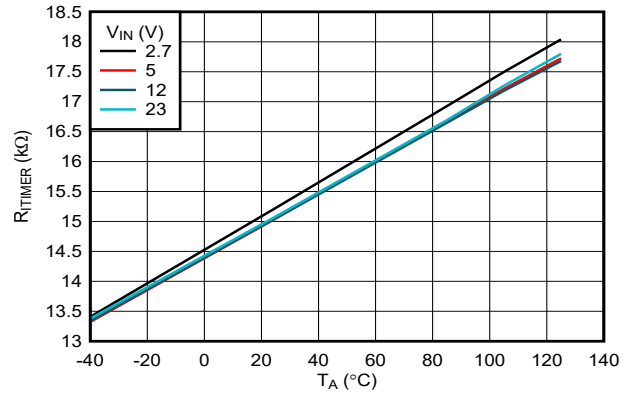

图 6-24. DVDT Charging Current vs Temperature

### 6.8 Typical Characteristics (continued)

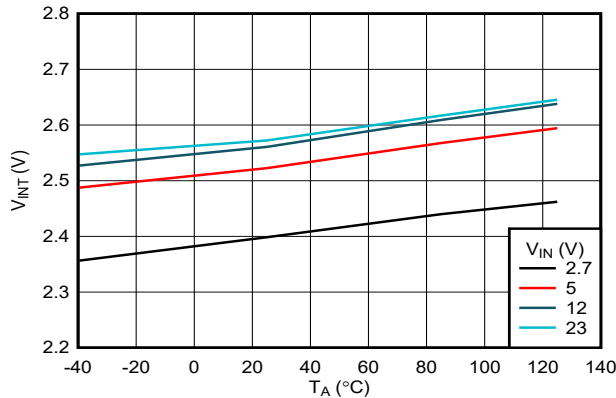

图 6-25. PGTH Threshold (Rising) vs Temperature (TPS25972x, TPS25974x Variants)

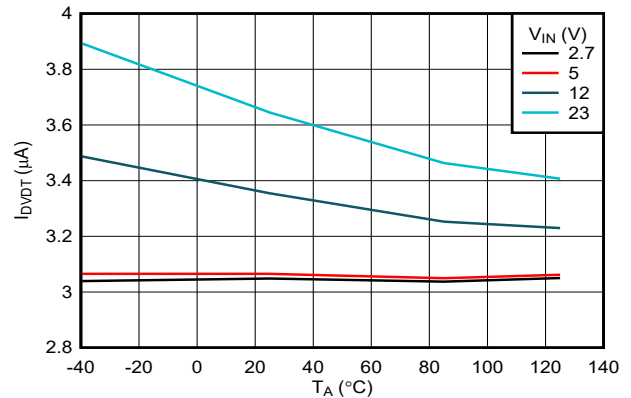

图 6-26. PGTH Threshold (Falling) vs Temperature (TPS25972x, TPS25974x Variants)

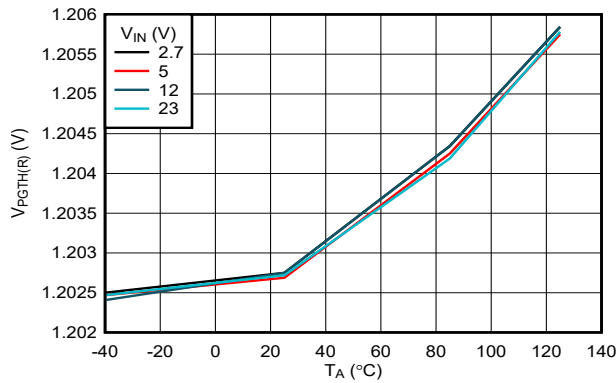

图 6-27. FLT Pin Pulldown Resistance vs Temperature

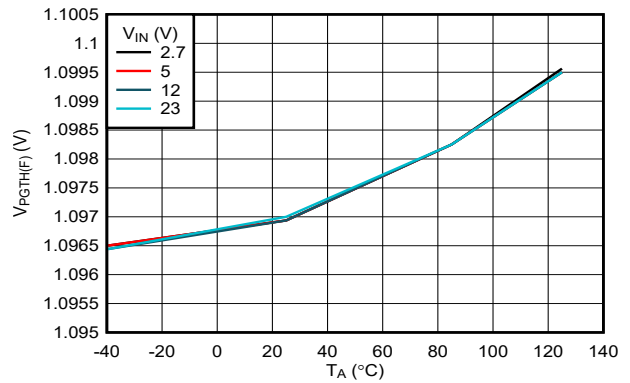

图 6-28. Time to Thermal Shut-Down During Inrush State

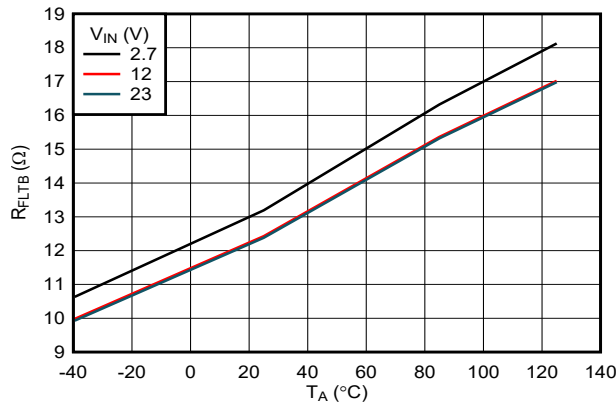

图 6-29. Time to Thermal Shut-Down During Steady State

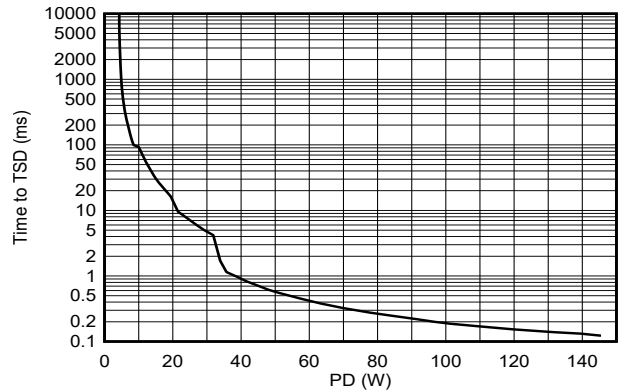

$V_{IN} = 12\text{ V}$ ,  $C_{OUT} = 22\ \mu\text{F}$ ,  $C_{dVdt} = \text{Open}$ ,  $V_{EN/UVLO}$  ramped from  $0\text{ V} \rightarrow 1.4\text{ V} \rightarrow 0\text{ V}$

图 6-30. Power Up and Down With EN/UVLO Control

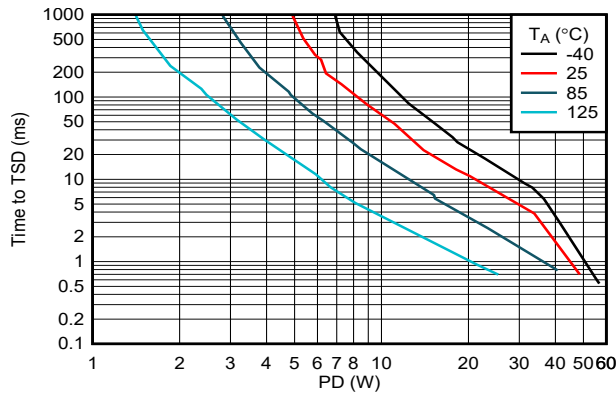
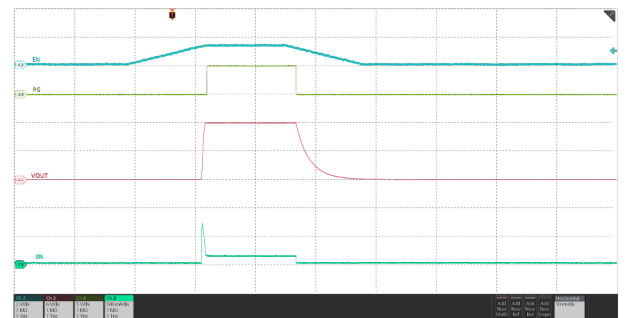
### 6.8 Typical Characteristics (continued)

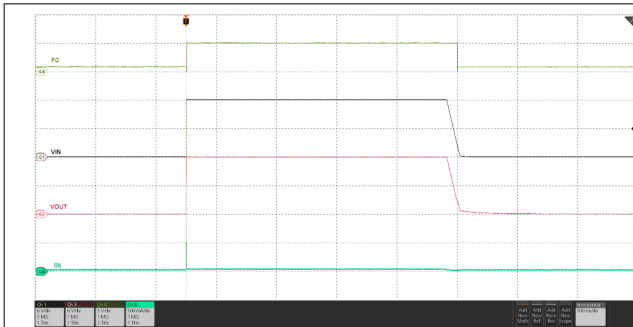

$V_{EN/UVLO} = 2\text{ V}$ ,  $C_{OUT} = 22\ \mu\text{F}$ ,  $C_{dVdt} = \text{Open}$ ,  $V_{IN}$  ramped from  $0\text{ V} \rightarrow 12\text{ V} \rightarrow 0\text{ V}$

图 6-31. Power Up and Down With Input Supply

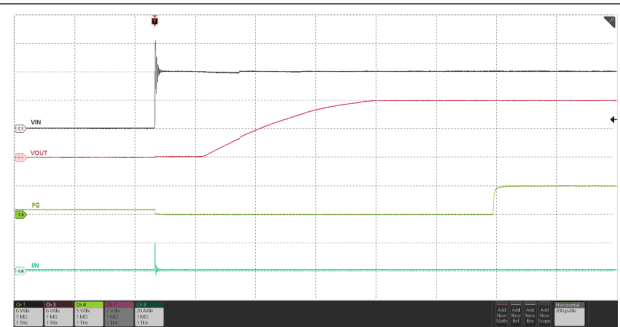

$C_{OUT} = 22\ \mu\text{F}$ ,  $C_{dVdt} = \text{Open}$ , EN/UVLO connected to IN through resistor ladder,  $12\text{ V}$  hot-plugged to IN

图 6-32. Input Hot-Plug

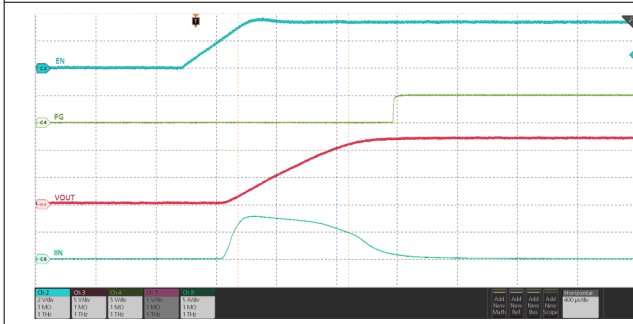

$V_{IN} = 12\text{ V}$ ,  $C_{OUT} = 470\ \mu\text{F}$ ,  $C_{dVdt} = \text{Open}$ ,  $V_{EN/UVLO}$  stepped up to  $3.3\text{ V}$

图 6-33. Inrush Current Without Slew Rate Control - Capacitive Load

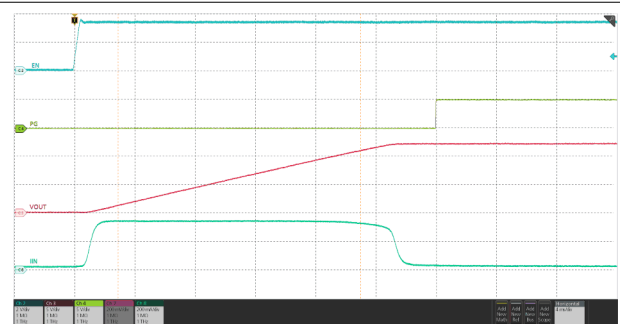

$V_{IN} = 12\text{ V}$ ,  $C_{OUT} = 470\ \mu\text{F}$ ,  $C_{dVdt} = 5100\text{ pF}$ ,  $V_{EN/UVLO}$  stepped up to  $3.3\text{ V}$

图 6-34. Inrush Current With Slew Rate Control - Capacitive Load

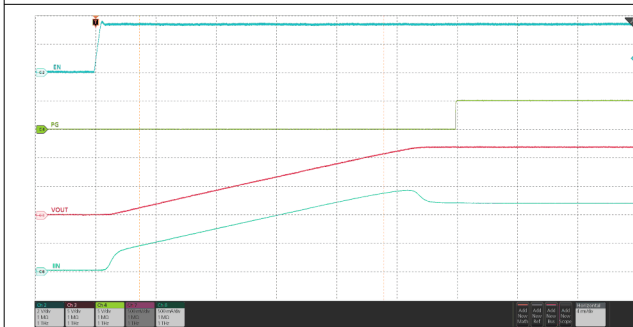

$V_{IN} = 12\text{ V}$ ,  $C_{OUT} = 470\ \mu\text{F}$ ,  $R_{OUT} = 10\ \Omega$ ,  $C_{dVdt} = 5100\text{ pF}$ ,  $V_{EN/UVLO}$  stepped up to  $3.3\text{ V}$

图 6-35. Inrush Current With Slew Rate Control - Resistive and Capacitive Load

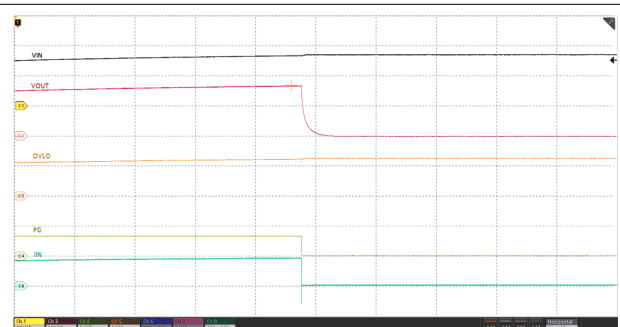

OV threshold set to  $16.7\text{ V}$ ,  $V_{IN}$  ramped up from  $12\text{ V}$  to  $17\text{ V}$

图 6-36. Overvoltage Lockout Response - TPS25970x and TPS25974x



## 6.8 Typical Characteristics (continued)

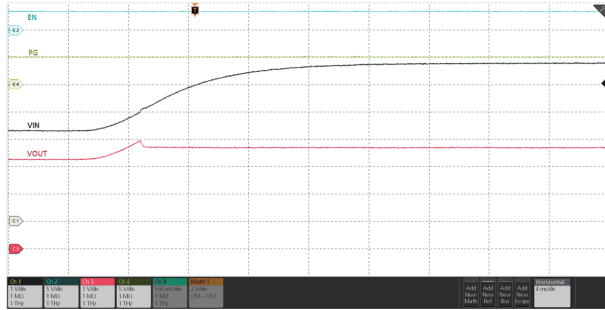

$R_{OVCSSEL} = GND$ ,  $C_{OUT} = 220 \mu F$ ,  $I_{OUT} = 200 \text{ mA}$ ,  $V_{IN}$  ramped up from 3.3 V to 5.8 V

图 6-37. Overvoltage Clamp Response - TPS25972x

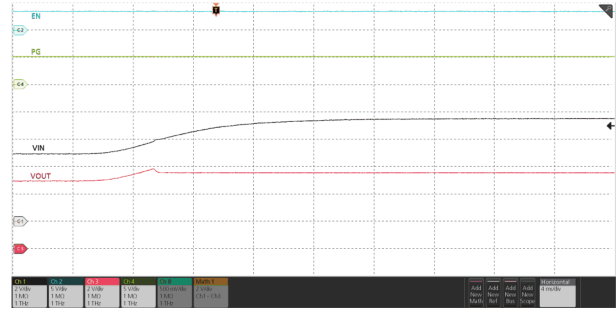

$R_{OVCSSEL} = \text{Open}$ ,  $C_{OUT} = 220 \mu F$ ,  $I_{OUT} = 200 \text{ mA}$ ,  $V_{IN}$  ramped up from 5 V to 7.5 V

图 6-38. Overvoltage Clamp Response - TPS25972x

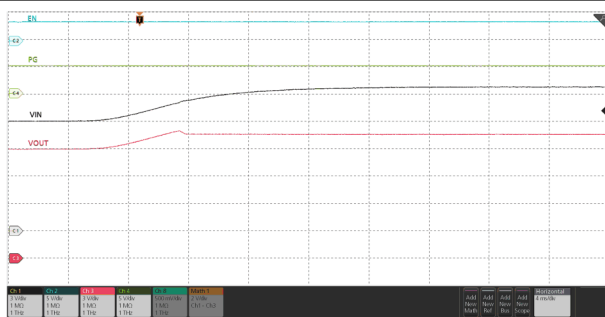

$R_{OVCSSEL} = 390 \text{ k}\Omega$ ,  $C_{OUT} = 220 \mu F$ ,  $I_{OUT} = 200 \text{ mA}$ ,  $V_{IN}$  ramped up from 12 V to 16.5 V

图 6-39. Overvoltage Clamp Response - TPS25972x

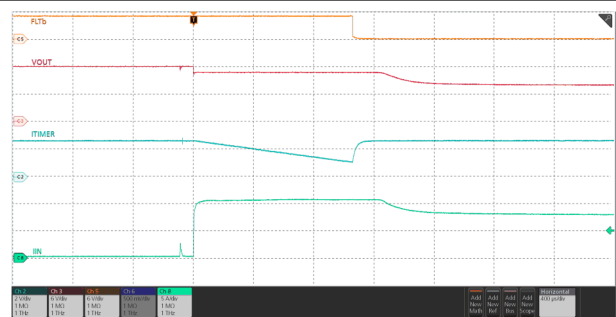

$V_{IN} = 12 \text{ V}$ ,  $C_{TIMER} = 1.3 \text{ nF}$ ,  $C_{OUT} = 220 \mu F$ ,  $R_{ILM} = 715 \Omega$ ,  $I_{OUT}$  stepped from 0 A  $\rightarrow$  11 A

图 6-40. Active Current Limit Response - TPS25970x

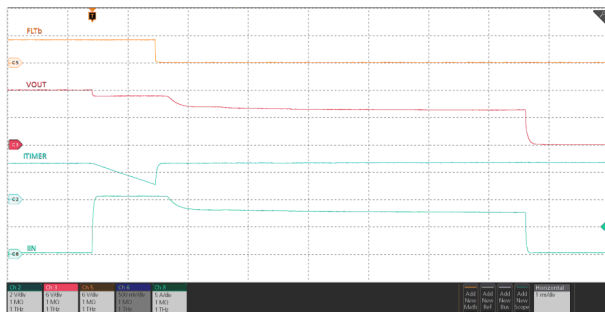

$V_{IN} = 12 \text{ V}$ ,  $C_{TIMER} = 1.3 \text{ nF}$ ,  $C_{OUT} = 220 \mu F$ ,  $R_{ILM} = 715 \Omega$ ,  $I_{OUT}$  stepped from 0 A  $\rightarrow$  11 A

图 6-41. Active Current Limit Response Followed by TSD - TPS25970x

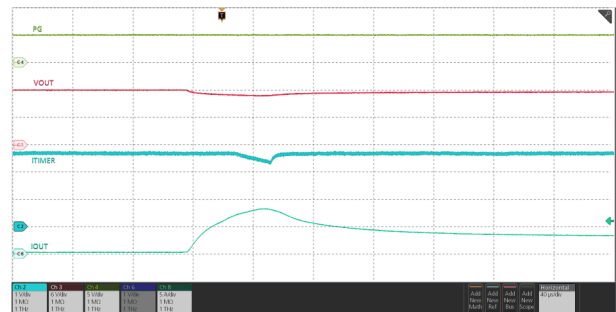

$V_{IN} = 12 \text{ V}$ ,  $C_{TIMER} = 120 \text{ pF}$ ,  $C_{OUT} = 470 \mu F$ ,  $R_{ILM} = 715 \Omega$ ,  $I_{OUT}$  ramped from 0 A  $\rightarrow$  8 A  $\rightarrow$  4 A within 100  $\mu\text{s}$

图 6-42. Transient Overcurrent Blanking Timer Response

## 6.8 Typical Characteristics (continued)

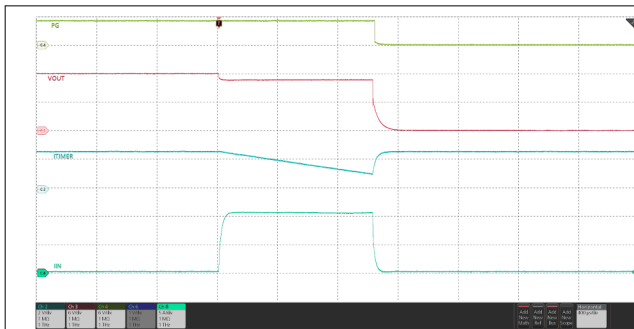

$V_{IN} = 12\text{ V}$ ,  $C_{TIMER} = 1.3\text{ nF}$ ,  $C_{OUT} = 470\text{ }\mu\text{F}$ ,  $R_{ILM} = 715\text{ }\Omega$ ,  $I_{OUT}$  stepped from  $0\text{ A} \rightarrow 11\text{ A}$

图 6-43. Circuit-Breaker Response TPS25974x

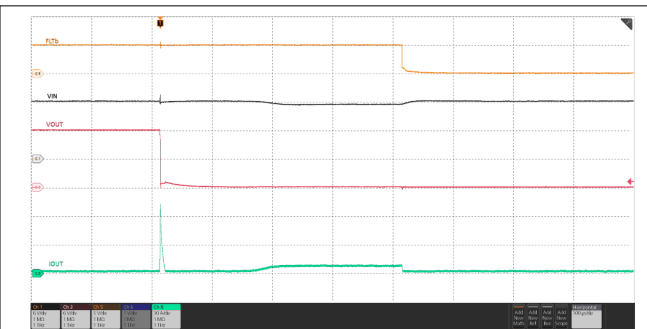

$V_{IN} = 12\text{ V}$ ,  $R_{ILM} = 715\text{ }\Omega$ , OUT stepped from Open  $\rightarrow$  Short-circuit to GND

图 6-44. Output Short-Circuit During Steady State

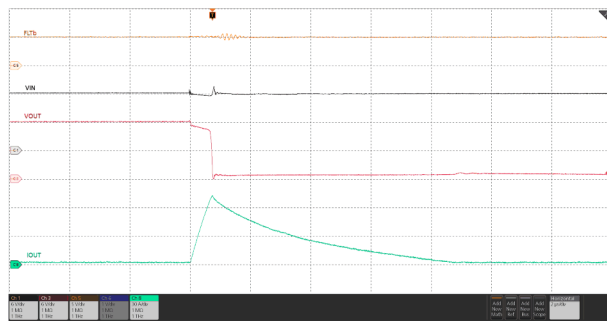

$V_{IN} = 12\text{ V}$ ,  $R_{ILM} = 715\text{ }\Omega$ , OUT stepped from Open  $\rightarrow$  Short-circuit to GND

图 6-45. Output Short-Circuit During Steady State (Zoomed In)

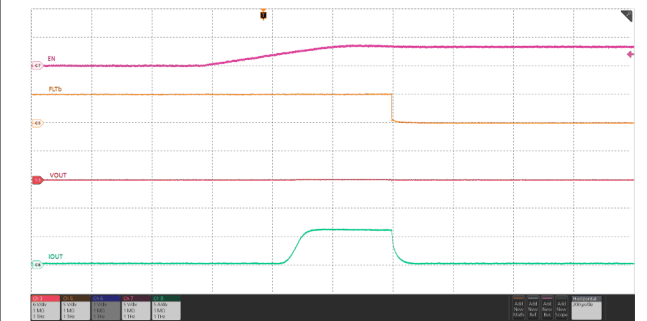

$V_{IN} = 12\text{ V}$ ,  $C_{OUT} = \text{Open}$ , OUT short-circuit to GND,  $R_{ILM} = 715\text{ }\Omega$ ,  $V_{EN/UVLO}$  stepped from  $0\text{ V}$  to  $3.3\text{ V}$

图 6-46. Power Up into Short-Circuit

## 7 Detailed Description

### 7.1 Overview

The TPS2597xx is an eFuse with an integrated power path that is used to ensure safe power delivery in a system. The device starts its operation by monitoring the IN bus. When the input supply voltage ( $V_{IN}$ ) exceeds the undervoltage protection threshold ( $V_{UVP}$ ), the device samples the EN/UVLO pin. A high level ( $> V_{UVLO}$ ) on this pin enables the internal power path (HFET) to start conducting and allow current to flow from IN to OUT. When EN/UVLO is held low ( $< V_{UVLO}$ ), the internal power path is turned off.

After a successful start-up sequence, the device now actively monitors its load current and input voltage, and controls the internal HFET to ensure that the user adjustable overcurrent limit threshold ( $I_{LIM}$ ) is not exceeded and overvoltage spikes are either safely clamped to the selected threshold voltage ( $V_{OVC}$ ) or cut-off after they cross the user-adjustable overvoltage lockout threshold ( $V_{OVLO}$ ). The device also provides fast protection against severe overcurrent during short-circuit events. This feature keeps the system safe from harmful levels of voltage and current. At the same time, a user-adjustable overcurrent blanking timer allows the system to pass moderate transient peaks in the load current profile without tripping the eFuse. This action ensures a robust protection solution against real faults which is also immune to transients, thereby ensuring maximum system uptime.

The device also has a built-in thermal sensor based shutdown mechanism to protect itself in case the device temperature ( $T_J$ ) exceeds the recommended operating conditions.

### 7.2 Functional Block Diagram

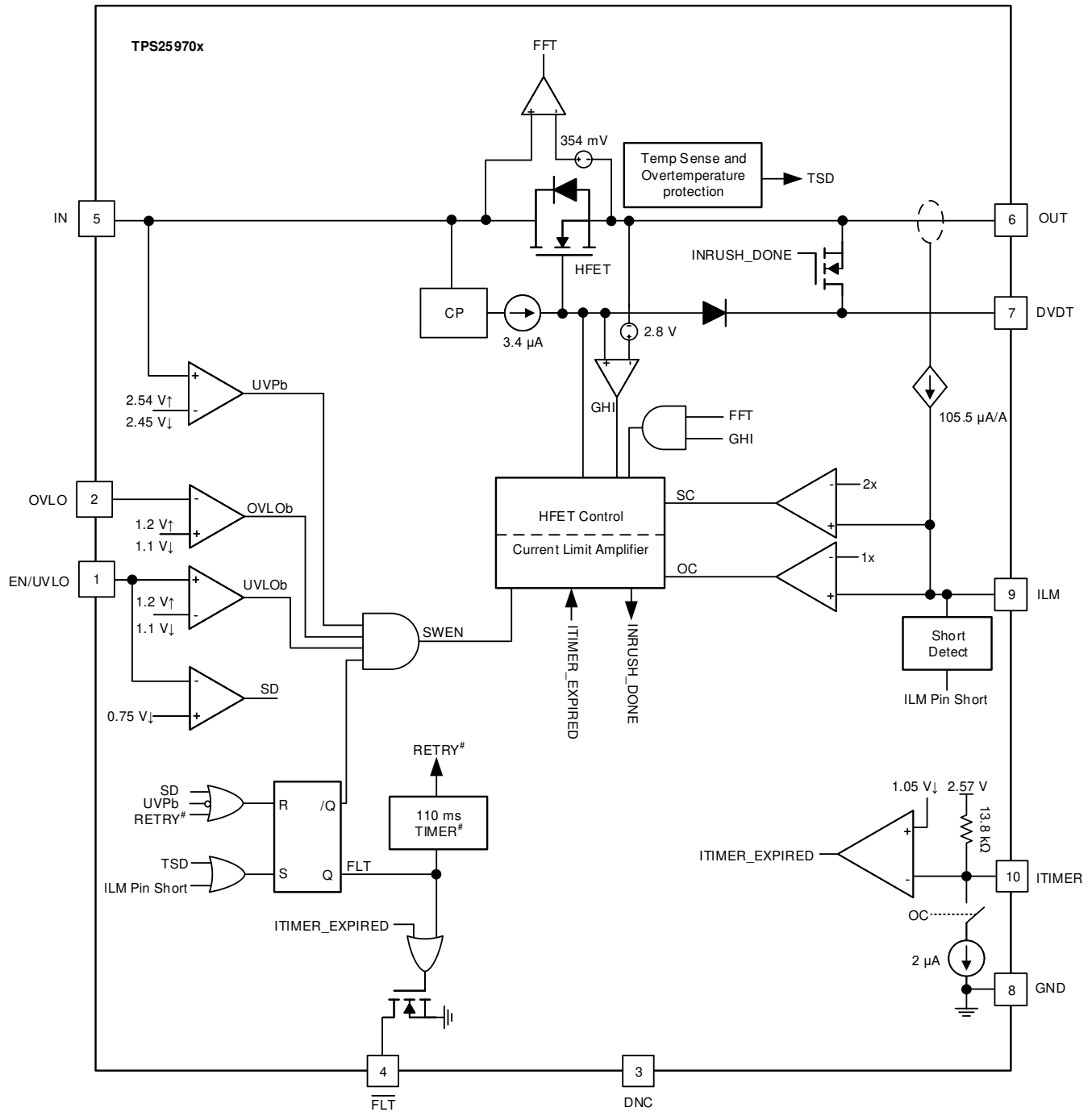

# Not applicable to Latch-off variants (TPS25970L)

图 7-1. TPS25970x Block Diagram

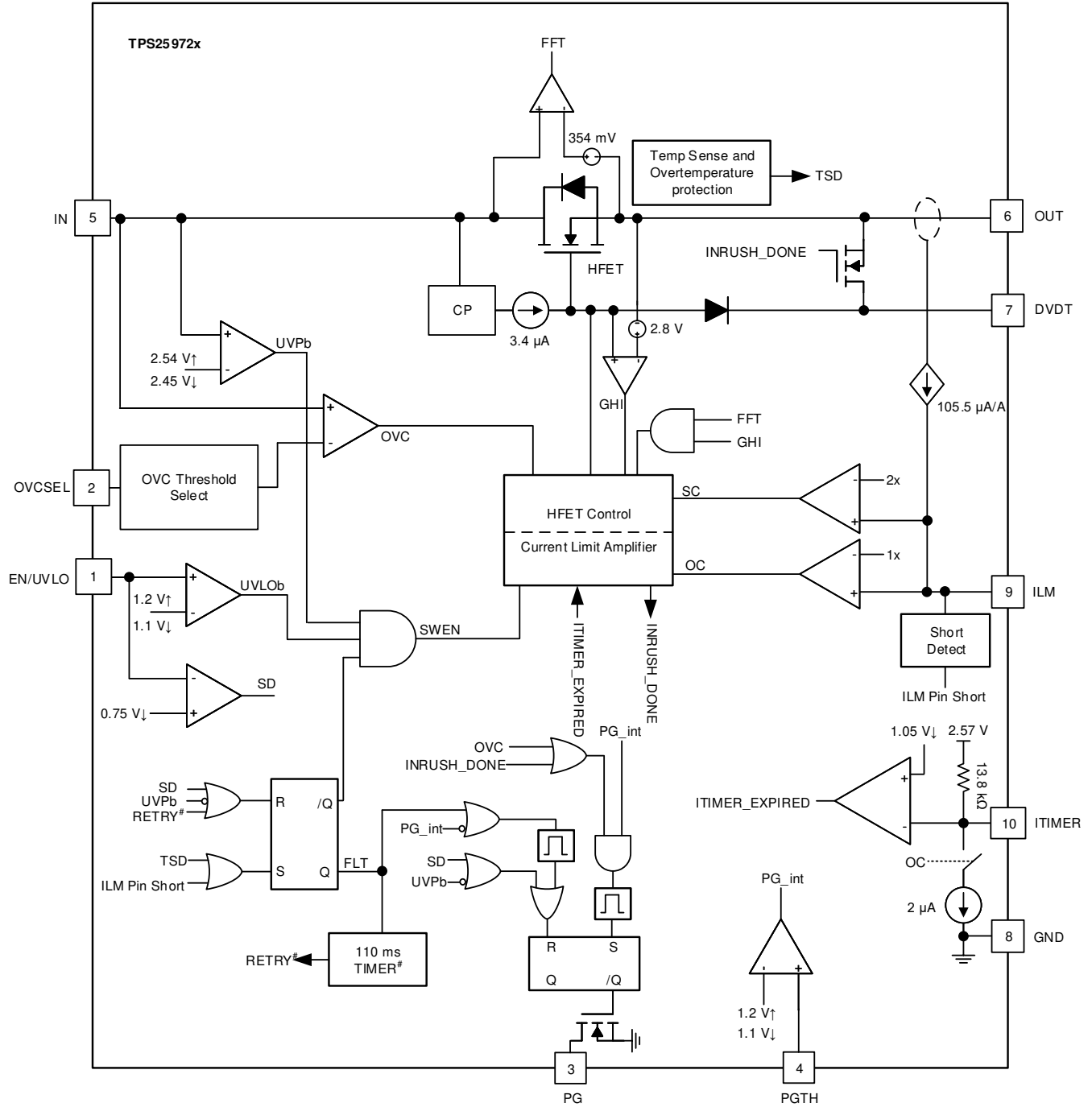

# Not applicable to Latch-off variants (TPS25972L)

图 7-2. TPS25972x Block Diagram

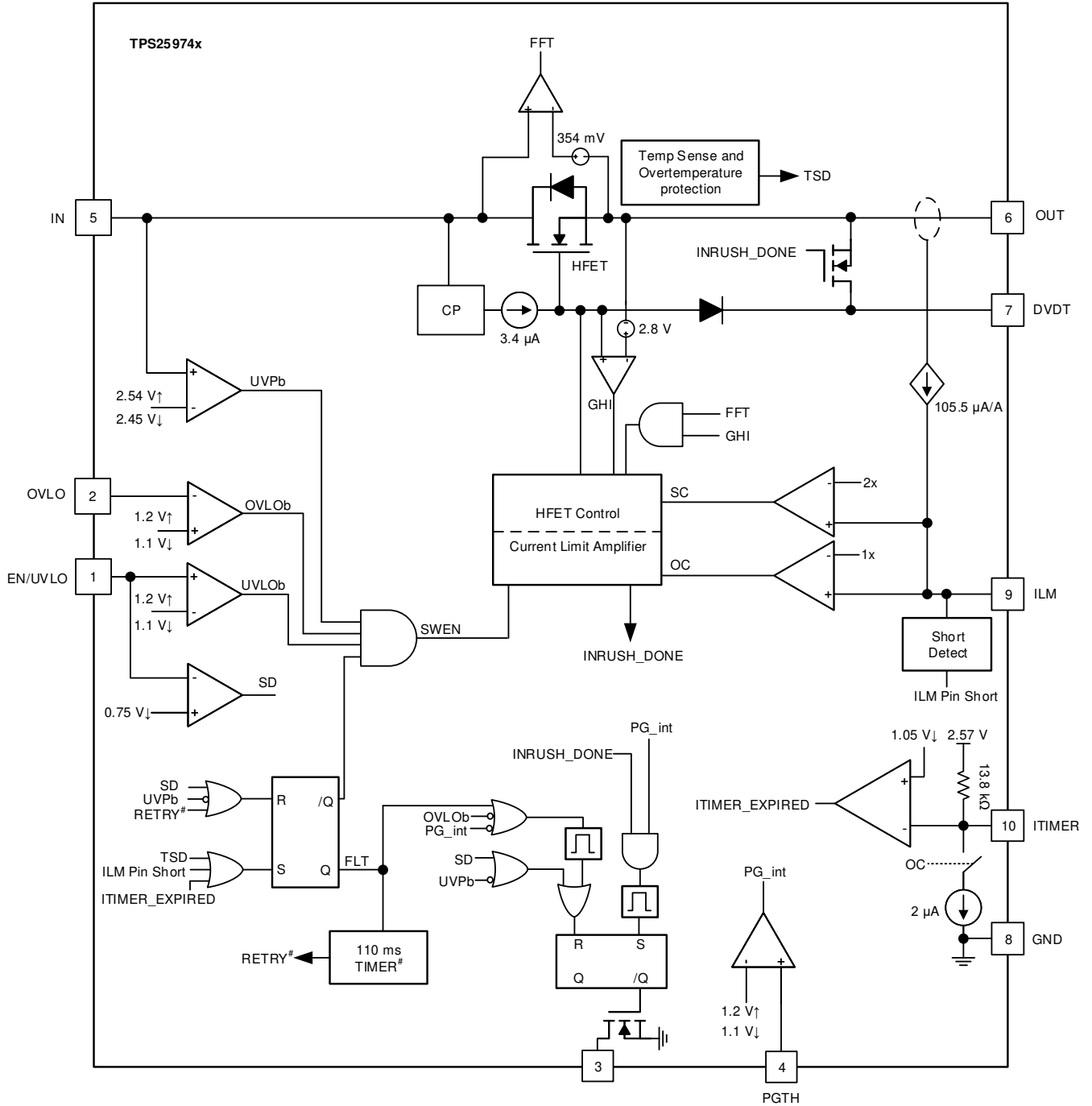

# Not applicable to Latch-off variants (TPS25974L)

图 7-3. TPS25974x Block Diagram

## 7.3 Feature Description

The TPS2597xx eFuse is a compact, feature-rich power management device that provides detection, protection, and indication in the event of system faults.

### 7.3.1 Undervoltage Lockout (UVLO and UVP)

The TPS2597xx implements undervoltage protection on IN in case the applied voltage becomes too low for the system or device to properly operate. The undervoltage protection has a default lockout threshold of  $V_{UVLP}$  which is fixed internally. Also, the UVLO comparator on the EN/UVLO pin allows the undervoltage protection threshold to be externally adjusted to a user-defined value. 图 7-4 和 方程式 1 show how a resistor divider can be used to set the UVLO set point for a given voltage supply.



图 7-4. Adjustable Undervoltage Protection

$$V_{IN(UV)} = \frac{V_{UVLO} \times (R_1 + R_2)}{R_2} \quad (1)$$

### 7.3.2 Overvoltage Lockout (OVLO)

The TPS25970x and TPS25974x variants allow the user to implement overvoltage lockout to protect the load from input overvoltage conditions. The OVLO comparator on the OVLO pin allows the overvoltage protection threshold to be adjusted to a user-defined value. After the voltage at the OVLO pin crosses the OVLO rising threshold,  $V_{OV(R)}$ , the device turns off the power to the output. Thereafter, the devices wait for the voltage at the OVLO pin to fall below the OVLO falling threshold,  $V_{OV(F)}$  before the output power is turned ON again. The rising and falling thresholds are slightly different to provide hysteresis. 图 7-5 和 方程式 2 show how a resistor divider can be used to set the OVLO set point for a given voltage supply.

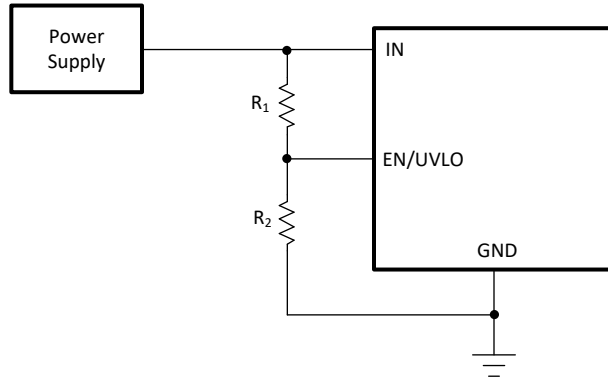

图 7-5. Adjustable Overvoltage Protection

$$V_{IN(OV)} = \frac{V_{OV} \times (R_1 + R_2)}{R_2} \quad (2)$$

While recovering from a OVLO event, the TPS25970x variants start up with inrush control (dVdt).

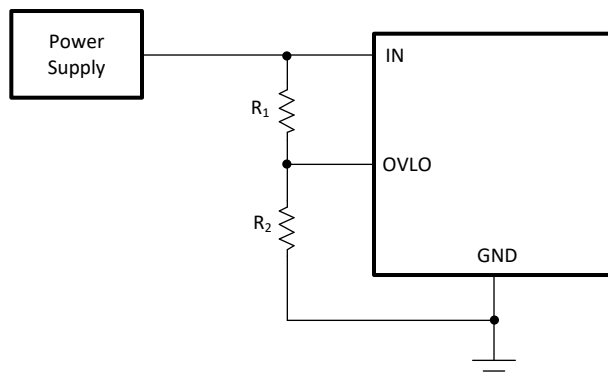

图 7-6. TPS25970x Overvoltage Lockout and Recovery

While recovering from an OVLO event, the TPS25974x variants start up with inrush control (dVdt).

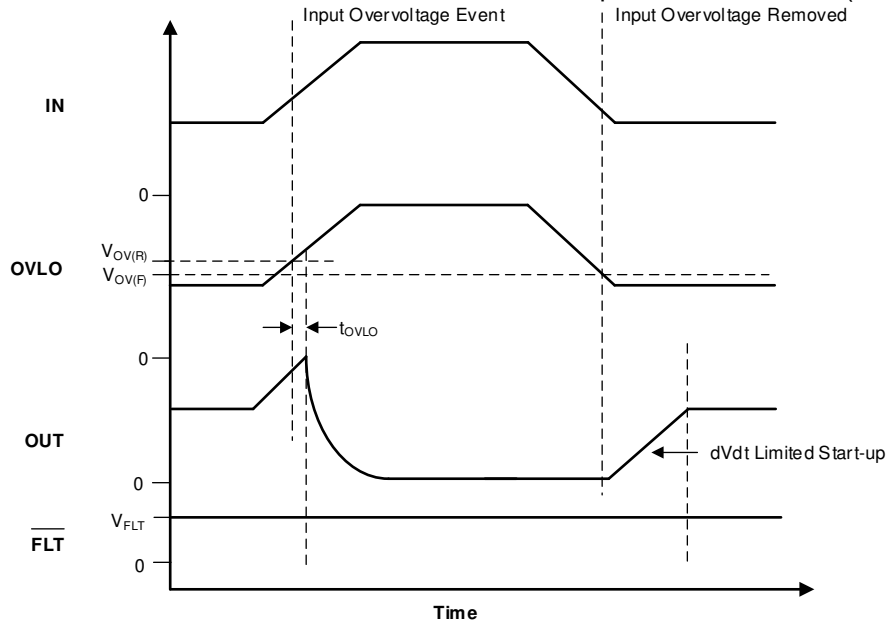

图 7-7. TPS25974x Overvoltage Lockout and Recovery

### 7.3.3 Overvoltage Clamp (OVC)

The TPS25972x variants implement a voltage clamp on the output to protect the system in the event of input overvoltage. When the device detects the input has exceeded the overvoltage clamp threshold ( $V_{OVC}$ ), it quickly responds within  $t_{OVC}$  and stops the output from rising further. The device then regulates the HFET linearly to clamp the output voltage below  $V_{CLAMP}$  as long as an overvoltage condition is present on the input.

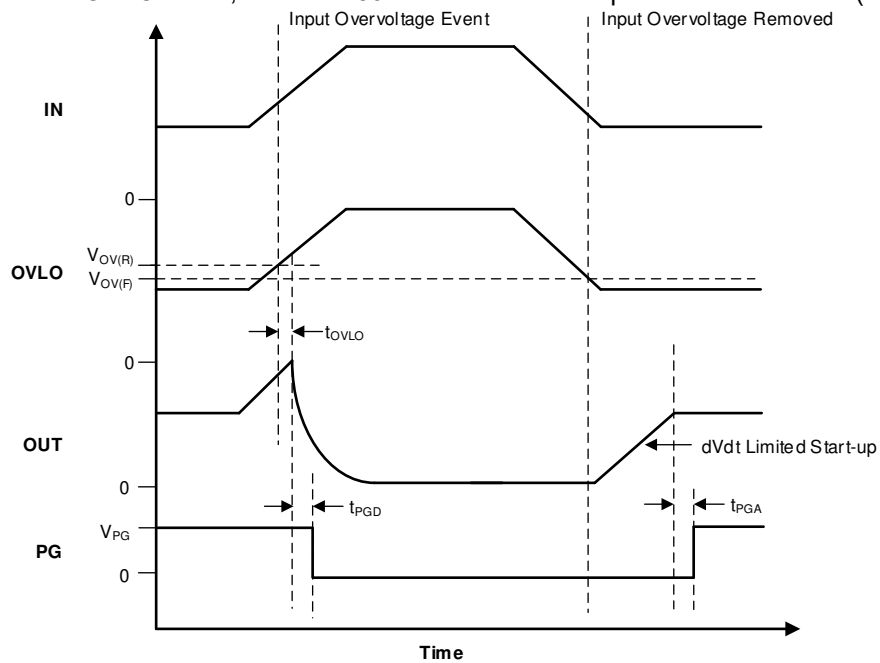

If the part stays in clamping state for an extended period of time, there is higher power dissipation inside the part which can eventually lead to thermal shutdown (TSD). After the part shuts down due to TSD fault, it either stays latched off (TPS25972L variant) or restart automatically after a fixed delay (TPS25972A variant). See [Overtemperature Protection \(OTP\)](#) for more details on device response to overtemperature.

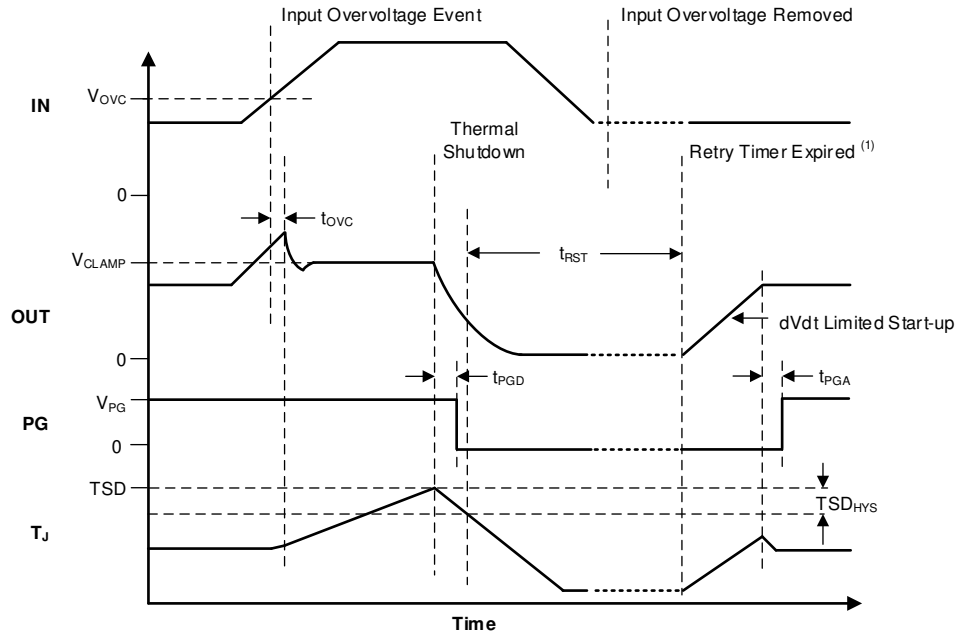

(1) Applicable only for TPS25972A (Auto-retry variant)

图 7-8. TPS25972x Overvoltage Response (Auto-Retry)

There are three available overvoltage clamp threshold options, which can be configured using the OVCSEL pin.

表 7-1. TPS25972x Overvoltage Clamp Threshold Selection

OVCSEL PIN CONNECTION	OVERVOLTAGE CLAMP THRESHOLD
Shorted to GND	3.89 V
Open	5.76 V
Connected to GND through a 390-kΩ resistor	13.88 V

### 7.3.4 Inrush Current, Overcurrent, and Short Circuit Protection

TPS2597xx incorporates four levels of protection against overcurrent:

1. Adjustable slew rate (dVdt) for inrush current control
2. Adjustable threshold ( $I_{LIM}$ ) for overcurrent protection during start-up or steady-state
3. Adjustable threshold ( $I_{SC}$ ) for fast-trip response to severe overcurrent during start-up or steady-state
4. Fixed threshold ( $I_{FT}$ ) for fast-trip response to quickly protect against hard output short-circuits during steady-state

#### 7.3.4.1 Slew Rate (dVdt) and Inrush Current Control

During hot-plug events or while trying to charge a large output capacitance at start-up, there can be a large inrush current. If the inrush current is not managed properly, it can damage the input connectors or cause the system power supply to droop leading to unexpected restarts elsewhere in the system or both. The inrush current during turn on is directly proportional to the load capacitance and rising slew rate. Use [方程式 3](#) to find the slew rate (SR) required to limit the inrush current ( $I_{INRUSH}$ ) for a given load capacitance ( $C_{OUT}$ ):

$$SR (V/ms) = \frac{I_{INRUSH} (mA)}{C_{OUT} (\mu F)} \quad (3)$$

A capacitor can be connected to the dVdt pin to control the rising slew rate and lower the inrush current during turn on. Use [方程式 4](#) to calculate the required  $C_{dVdt}$  capacitance to produce a given slew rate.

$$C_{dVdt} (pF) = \frac{3300}{SR (V/ms)} \quad (4)$$

The fastest output slew rate is achieved by leaving the dVdt pin open.

---

备注

For  $C_{dVdt} > 10nF$ , TI recommends to add a  $100\ \Omega$  resistor in series with the capacitor on the dVdt pin.

---

### 7.3.4.2 Circuit-Breaker

The circuit-breaker variants (TPS25974x) respond to output overcurrent conditions by turning off the output after a user-adjustable transient fault blanking interval. When the load current exceeds the set overcurrent threshold ( $I_{LIM}$ ) set by the ILM pin resistor ( $R_{ILM}$ ), but stays lower than the fast-trip threshold ( $2 \times I_{LIM}$ ), the device starts discharging the ITIMER pin capacitor using an internal  $2\text{-}\mu\text{A}$  pulldown current. If the load current drops below  $I_{LIM}$  before the ITIMER pin capacitor ( $C_{ITIMER}$ ) discharges by  $\Delta V_{ITIMER}$ , the ITIMER is reset by pulling it up to  $V_{INT}$  internally and the circuit breaker action is not engaged. This action allows short load transient pulses to pass through the device without tripping the circuit. If the overcurrent condition persists, the  $C_{ITIMER}$  continues to discharge and after it discharges by  $\Delta V_{ITIMER}$ , the circuit breaker action turns off the HFET immediately. At the same time, the  $C_{ITIMER}$  is charged up to  $V_{INT}$  again so that it is at its default state before the next overcurrent event. This action ensures the full blanking timer interval is provided for every overcurrent event. Use [方程式 5](#) to calculate the  $R_{ILM}$  value for an overcurrent threshold.

$$R_{ILM} (\Omega) = \frac{5747}{I_{LIM} (A)} \quad (5)$$

---

备注

1. Leaving the ILM pin Open sets the current limit to nearly zero and results in the part breaking the circuit with the slightest amount of loading at the output.
  2. Shorting the ILM pin to ground at any point during normal operation is detected as a fault and the part shuts down. There is a minimum current ( $I_{FLT}$ ) which the part allows in this condition before the pin short condition is detected.
- 

The duration for which transients are allowed can be adjusted using an appropriate capacitor value from ITIMER pin to ground. Use [方程式 6](#) to calculate the  $C_{ITIMER}$  value needed to set the desired transient overcurrent blanking interval.

$$t_{ITIMER} (ms) = \frac{\Delta V_{ITIMER} (V) \times C_{ITIMER} (nF)}{I_{ITIMER} (\mu A)} \quad (6)$$



图 7-9. TPS25974x Overcurrent Response

备注

1. Leave the ITIMER pin open to allow the part to break the circuit with the minimum possible delay.
2. Shorting the ITIMER pin to ground results in minimum overcurrent response delay (similar to ITIMER pin open condition), but increases the device current consumption. This action is not a recommended mode of operation.
3. Increasing the ITIMER cap value extends the overcurrent blanking interval, but it also extends the time needed for the ITIMER cap to recharge up to  $V_{INT}$ . If the next overcurrent event occurs before the ITIMER cap is recharged fully, it takes less time to discharge to the ITIMER expiry threshold, thereby providing a shorter blanking interval than intended.

After the part shuts down due to a circuit-breaker fault, it either stays latched off (TPS25974L variant) or restart automatically after a fixed delay (TPS25974A variant).

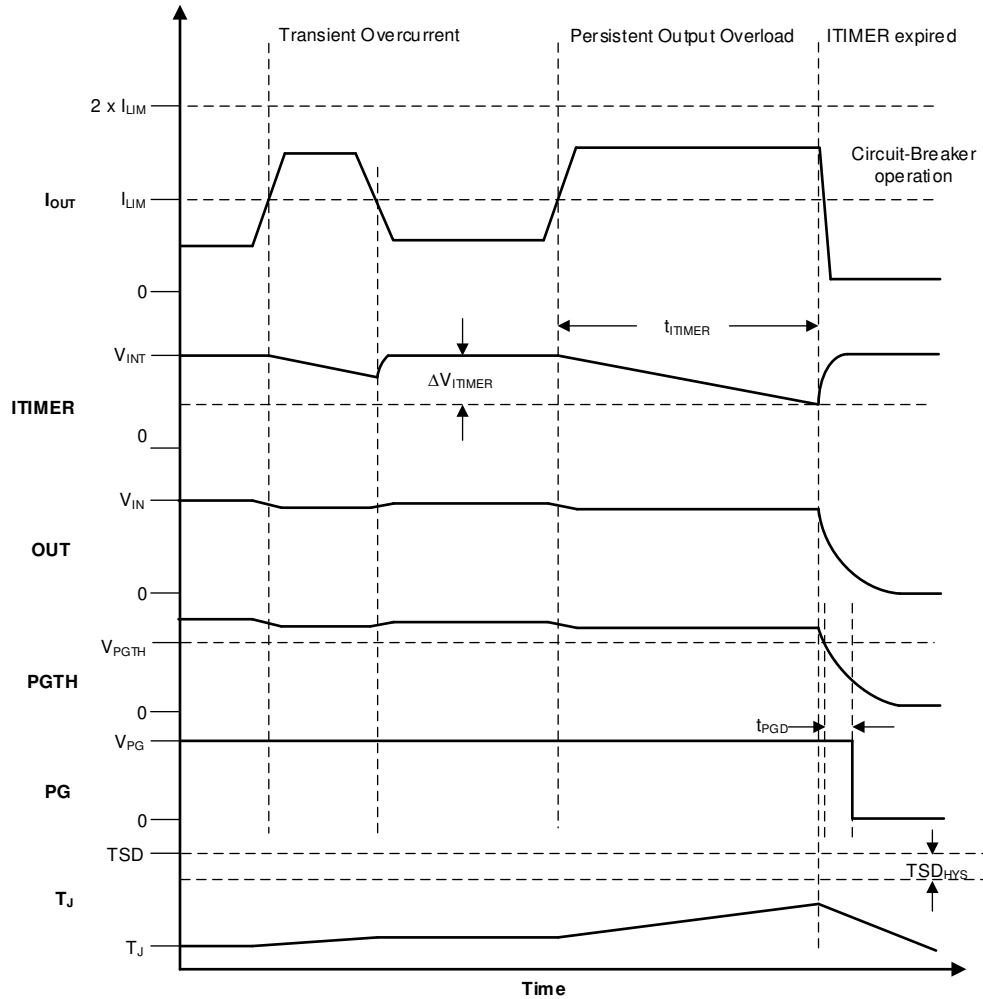
7.3.4.3 Active Current Limiting

The active current limit variants (TPS25970x and TPS25972x) respond to output overcurrent conditions by actively limiting the current after a user adjustable transient fault blanking interval. When the load current exceeds the set overcurrent threshold ( $I_{LIM}$ ) set by the ILM pin resistor ( $R_{ILM}$ ), but stays lower than the short-circuit threshold ( $2 \times I_{LIM}$ ), the device starts discharging the ITIMER pin capacitor using an internal 2- $\mu$ A pulldown current. If the load current drops below the overcurrent threshold before the ITIMER capacitor ( $C_{ITIMER}$ )

discharges by  $\Delta V_{ITIMER}$ , the ITIMER is reset by pulling it up to  $V_{INT}$  internally and the current limit action is not engaged. This event allows short load transient pulses to pass through the device without getting current limited. If the overcurrent condition persists, the  $C_{ITIMER}$  continues to discharge and after it discharges by  $\Delta V_{ITIMER}$ , the current limit starts regulating the HFET to actively limit the current to the set overcurrent threshold ( $I_{LIM}$ ). At the same time, the  $C_{ITIMER}$  is charged up to  $V_{INT}$  again so that it is at its default state before the next overcurrent event. This event ensures the full blanking timer interval is provided for every overcurrent event. Use [方程式 7](#) to calculate the  $R_{ILM}$  value for a desired overcurrent threshold.

$$R_{ILM} (\Omega) = \frac{5747}{I_{LIM} (A)} \quad (7)$$

---

#### 备注

1. Leaving the ILM pin open sets the current limit to nearly zero and results in the part entering current limit with the slightest amount of loading at the output.
  2. The current limit circuit employs a foldback mechanism. The current limit threshold in the foldback region ( $0 V < V_{OUT} < V_{FB}$ ) is lower than the steady state current limit threshold ( $I_{LIM}$ ).
  3. Shorting the ILM pin to ground at any point during normal operation is detected as a fault and the part shuts down. There's a minimum current ( $I_{FLT}$ ) which the part allows in this condition before the pin short condition is detected.
- 

The duration for which transients are allowed can be adjusted using an appropriate capacitor value from ITIMER pin to ground. Use [方程式 8](#) to calculate the  $C_{ITIMER}$  value needed to set the desired transient overcurrent blanking interval.

$$t_{ITIMER} (ms) = \frac{\Delta V_{ITIMER} (V) \times C_{ITIMER} (nF)}{I_{ITIMER} (\mu A)} \quad (8)$$



图 7-10. TPS25970x and TPS25972x Active Current Limit Response

备注

1. Leave the ITIMER pin open to allow the part to limit the current with the minimum possible delay.
2. Shorting the ITIMER pin to ground results in minimum overcurrent response delay (similar to ITIMER pin open condition), but increases the device current consumption. This action is not a recommended mode of operation.
3. Active current limiting based on  $R_{ILIM}$  is active during start-up for TPS25970x, TPS25972x (active current limit) as well as TPS25974x (circuit-breaker) variants. In case the start-up current exceeds  $I_{LIM}$ , the device regulates the current to the set limit. However, during start-up the current limit is engaged without waiting for the ITIMER delay.
4. For the TPS25972x variants, during overvoltage clamp condition, if an overcurrent event occurs, the current limit is engaged without waiting for the ITIMER delay.
5. Increasing the  $C_{ITIMER}$  value extends the overcurrent blanking interval, but it also extends the time needed for the  $C_{ITIMER}$  to recharge up to  $V_{INT}$ . If the next overcurrent event occurs before the  $C_{ITIMER}$  is recharged fully, it takes lesser time to discharge to the ITIMER expiry threshold, thereby providing a shorter blanking interval than intended.

During active current limit, the output voltage drops, resulting in increased device power dissipation across the HFET. If the device internal temperature ( $T_J$ ) exceeds the thermal shutdown threshold (TSD), the HFET is turned off. After the part shuts down due to TSD fault, it either stays latched off (TPS2597xL variants) or restarts

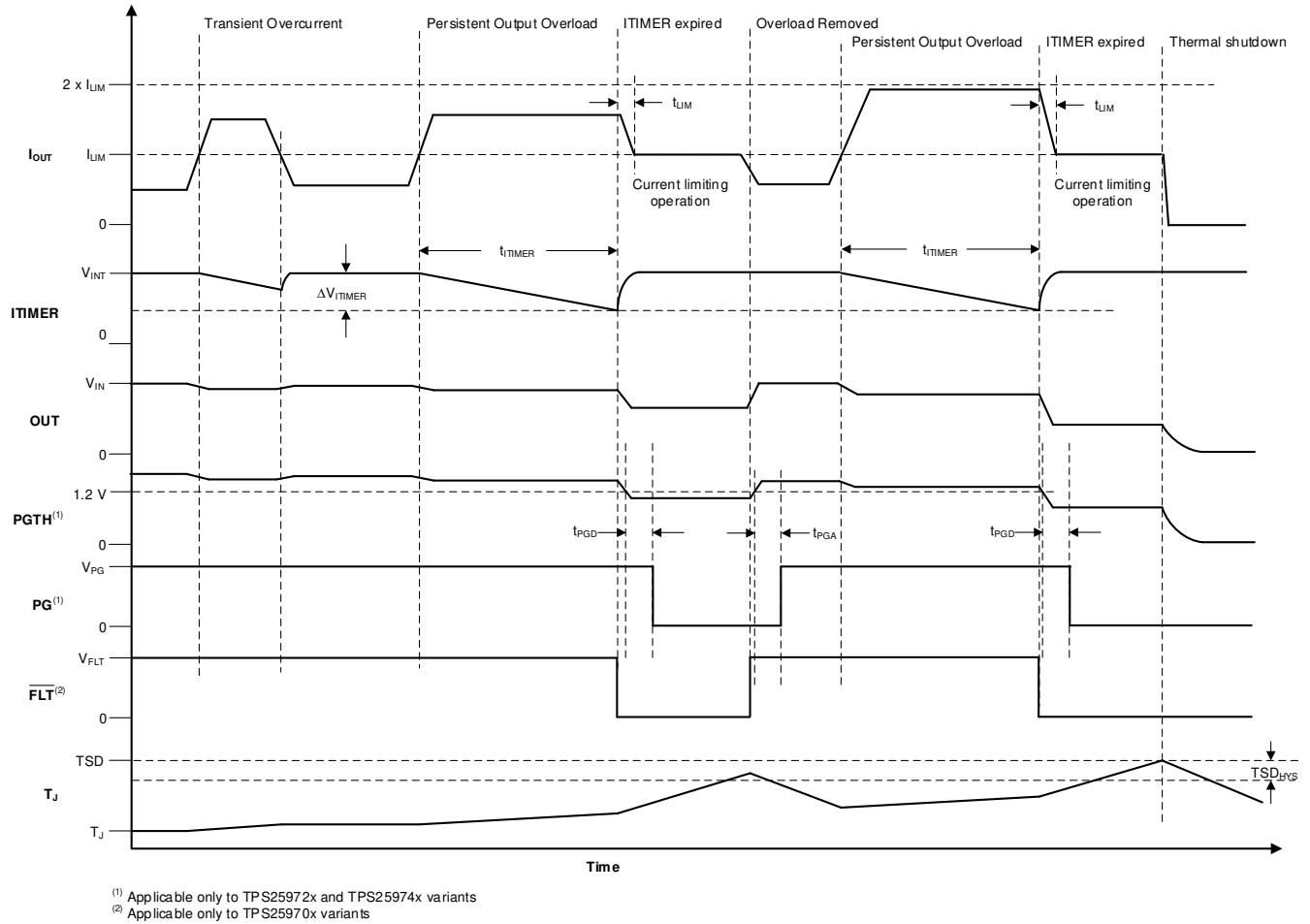
automatically after a fixed delay (TPS2597xA variants). See [Overtemperature Protection \(OTP\)](#) for more details on device response to overtemperature.

### 7.3.4.4 Short-Circuit Protection

During an output short-circuit event, the current through the device increases very rapidly. When a severe overcurrent condition is detected, the device triggers a fast-trip response to limit the current to a safe level. The internal fast-trip comparator employs a scalable threshold ( $I_{SC}$ ) which is equal to  $2 \times I_{LIM}$ . This action enables the user to adjust the fast-trip threshold rather than using a fixed threshold which can be too high for some low current systems. The device also employs a fixed fast-trip threshold ( $I_{FT}$ ) to protect fast protection against hard short-circuits during steady state. The fixed fast-trip threshold is higher than the maximum recommended user adjustable scalable fast-trip threshold. After the current exceeds  $I_{SC}$  or  $I_{FT}$ , the HFET is turned off completely within  $t_{FT}$ . Thereafter, the devices tries to turn the HFET back on after a short de-glitch interval ( $30 \mu s$ ) in a current limited manner instead of a dVdt limited manner. This action ensures that the HFET has a faster recovery after a transient overcurrent event and minimizes the output voltage droop. However, if the fault is persistent, the device stays in current limit causing the junction temperature to rise and eventually enter thermal shutdown. For details on the device response to overtemperature, see [Overtemperature Protection \(OTP\)](#).

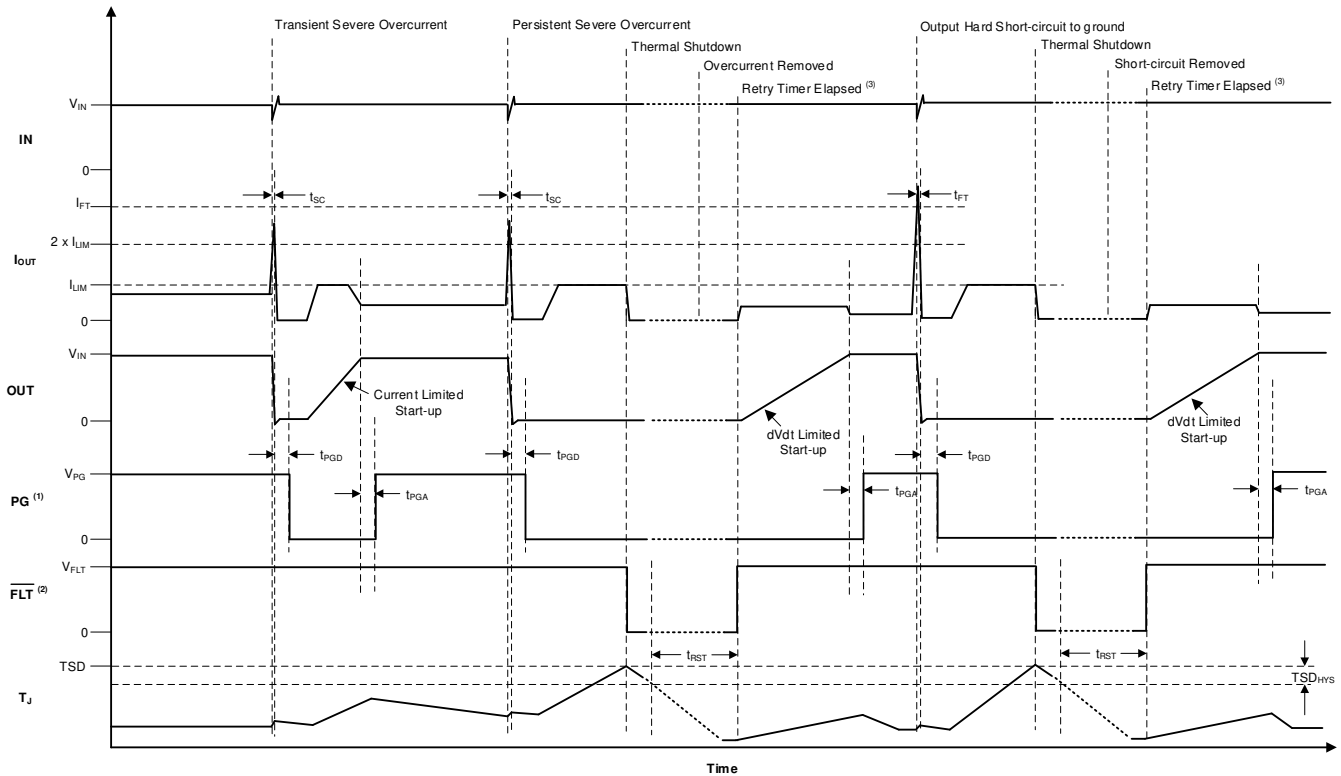

(1) Applicable only to TPS25972x and TPS25974x variants  
 (2) Applicable only to TP S25970x variants  
 (3) Applicable only to TP S2597xA variants

图 7-11. TPS2597xx Short-Circuit Response

### 7.3.5 Analog Load Current Monitor

The device allows the system to accurately monitor the output load current by providing an analog current sense output on the ILM pin, which is proportional to the current through the FET. The user can sense the voltage ( $V_{ILM}$ ) across the  $R_{ILM}$  to get a measure of the output load current.

$$I_{OUT} (A) = \frac{V_{ILM} (\mu V)}{R_{ILM} (\Omega) \times G_{IMON} (\mu A/A)} \tag{9}$$

The waveform below shows the ILM signal response to a load step at the output.

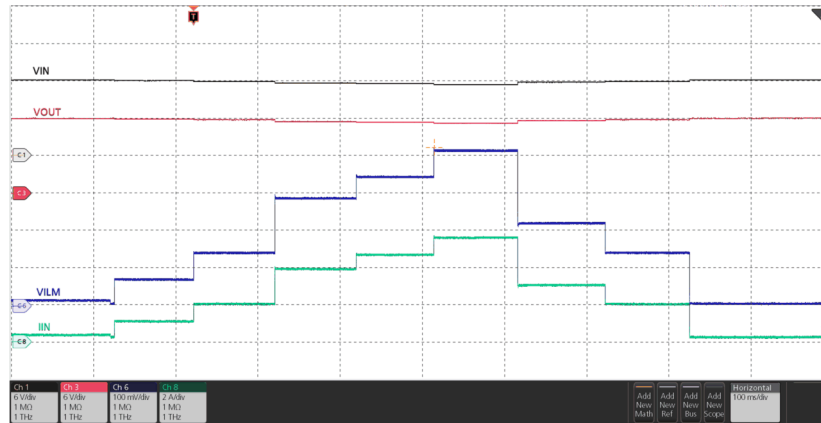

$V_{IN} = 12\text{ V}$ ,  $R_{ILM} = 715\ \Omega$ ,  $I_{OUT}$  varied dynamically between 0 A and 5.5 A

图 7-12. Analog Load Current Monitor Response

备注

The ILM pin is sensitive to capacitive loading. Careful design and layout is needed to ensure the parasitic capacitive loading on the ILM pin is  $< 50\text{ pF}$  for stable operation.

7.3.6 Overtemperature Protection (OTP)

The device monitors the internal die temperature ( $T_J$ ) at all times and shuts down the part as soon as the temperature exceeds a safe operating level (TSD), thereby protecting the device from damage. The device does not turn back on until the junction cools down sufficiently, that is the die temperature falls below  $(TSD - TSD_{HYS})$ .

When the TPS2597xL (latch-off variant) detects thermal overload, it shuts down and remains latched-off until the device is power cycled or re-enabled. When the TPS2597xA (auto-retry variant) detects thermal overload, it remains off until it has cooled down by  $TSD_{HYS}$ . Thereafter, the device remains off for an additional delay of  $t_{RST}$  after which it automatically retries to turn on if it is still enabled.

表 7-2. Thermal Shutdown

DEVICE	ENTER TSD	EXIT TSD
TPS2597xL (Latch-Off)	$T_J \geq TSD$	$T_J < TSD - TSD_{HYS}$ $V_{IN}$ cycled to 0 V and then above $V_{UVP(R)}$ OR EN/UVLO toggled below $V_{SD(F)}$
TPS2597xA (Auto-Retry)	$T_J \geq TSD$	$T_J < TSD - TSD_{HYS}$ $V_{IN}$ cycled to 0 V and then above $V_{UVP(R)}$ or EN/UVLO toggled below $V_{SD(F)}$ or $t_{RST}$ timer expired

7.3.7 Fault Response and Indication ( $\overline{FLT}$ )

表 7-3 summarizes the device response to various fault conditions. Additionally, an active low external fault indication ( $\overline{FLT}$ ) pin is available on the TPS25970x variants.

表 7-3. Fault Summary

EVENT	PROTECTION RESPONSE	FAULT LATCHED INTERNALLY	FLT PIN STATUS <sup>(1)</sup>	FLT ASSERTION DELAY <sup>(1)</sup>
Overtemperature	Shutdown	Y	L	
Undervoltage (UVP or UVLO)	Shutdown	N	H	
Input Overvoltage	Shutdown <sup>(1) (2)</sup>	N	H	
	Voltage Clamp <sup>(2)</sup>	N	N/A	
Transient Overcurrent ( $I_{LIM} < I_{OUT} < 2 \times I_{LIM}$ )	None	N	N	
Persistent Overcurrent	Circuit Breaker <sup>(3)</sup>	Y	N/A	
Persistent Overcurrent	Current Limit <sup>(4)</sup>	N	L	$t_{TIMER}$
Output Short-Circuit to GND	Circuit Breaker followed by Current Limit	N	H	
ILM Pin Open (During Steady State)	Shutdown	N	L	$t_{TIMER}$
ILM Pin Shorted to GND	Shutdown	Y	L	$t_{TIMER}$

(1) Applicable to TPS25970x variants only.

(2) Applicable to TPS25972x variants only.

(3) Applicable to TPS25974x variants only.

(4) Applicable to TPS25970x and TPS25972x variants only.

Faults which are latched internally can be cleared either by power cycling the part (pulling  $V_{IN}$  to 0 V) or by pulling the EN/UVLO pin voltage below  $V_{SD}$ . This action also releases the  $\overline{FLT}$  pin for the TPS25970x variants and resets the  $t_{RST}$  timer for the TPS2597xA (auto-retry) variants.

During a latched fault, pulling the EN/UVLO just below the UVLO threshold has no impact on the device. This fact is true for both TPS2597xL (latch-off) and TPS2597xA (auto-retry) variants.

For TPS2597xA (auto-retry) variants, on expiry of the  $t_{RST}$  timer after a fault, the device restarts automatically and the  $\overline{FLT}$  pin is de-asserted (TPS25970A variant).

### 7.3.8 Power-Good Indication (PG)

The TPS25972x and TPS25974x variants provide an active high digital output (PG) which serves as a power-good indication signal and is asserted high depending on the voltage at the PGTH pin along with the device state information. The PG is an open-drain pin and must be pulled up to an external supply.

After power up, PG is pulled low initially. The device initiates a inrush sequence in which the HFET is turned on in a controlled manner. When the HFET gate voltage reaches the full overdrive indicating that the inrush sequence is complete and the voltage at PGTH is above  $V_{PGTH(R)}$ , the PG is asserted after a de-glitch time ( $t_{PGA}$ ).

PG is de-asserted if at any time during normal operation, the voltage at PGTH falls below  $V_{PGTH(F)}$ , or the device detects a fault (except overcurrent). The PG de-assertion de-glitch time is  $t_{PGD}$ .





图 7-13. TPS25972x, TPS25974x PG Timing Diagram

表 7-4. TPS25972x and TPS25974x PG Indication Summary

EVENT	DEVICE STATUS	PG PIN STATUS	PG PIN TOGGLE DELAY
Undervoltage (UVP or UVLO)	OFF	L	
Oversvoltage (TPS25972x only)	ON (Clamping)	H (If PGTH pin voltage > $V_{PGTH(R)}$ ) L (If PGTH pin voltage < $V_{PGTH(F)}$ )	$t_{PGA}$ $t_{PGD}$
Oversvoltage (TPS25974x only)	OFF	L	$t_{PGD}$
Steady state	ON	H (If PGTH pin voltage > $V_{PGTH(R)}$ ) L (If PGTH pin voltage < $V_{PGTH(F)}$ )	$t_{PGA}$ $t_{PGD}$
Transient overcurrent	ON	H (If PGTH pin voltage > $V_{PGTH(R)}$ ) L (If PGTH pin voltage < $V_{PGTH(F)}$ )	$t_{PGA}$ $t_{PGD}$
Persistent overload (TPS25972x only)	ON (Current Limiting)	H (If PGTH pin voltage > $V_{PGTH(R)}$ ) L (If PGTH pin voltage < $V_{PGTH(F)}$ )	$t_{PGA}$ $t_{PGD}$
Persistent overload (TPS25974x only)	OFF (Circuit-Breaker)	L	$t_{PGD}$
Output short-circuit to GND	Fast-trip followed by Current Limit	H (If PGTH pin voltage > $V_{PGTH(R)}$ ) L (If PGTH pin voltage < $V_{PGTH(F)}$ )	$t_{PGA}$ $t_{PGD}$
ILM pin open	OFF	L (If PGTH < 1.1 V)	$t_{PGD} + t_{TIMER}$
ILM pin shorted to GND	OFF	L	$t_{PGD}$
Overtemperature	OFF	L	$t_{PGD}$

When there is no supply to the device, the PG pin is expected to stay low. However, there is no active pulldown in this condition to drive this pin all the way down to 0 V. If the PG pin is pulled up to an independent supply which is present even if the device is unpowered, there can be a small voltage seen on this pin depending on the pin sink current, which is a function of the pullup supply voltage and resistor. Minimize the sink current to keep this pin voltage low enough not to be detected as a logic HIGH by associated external circuits in this condition.

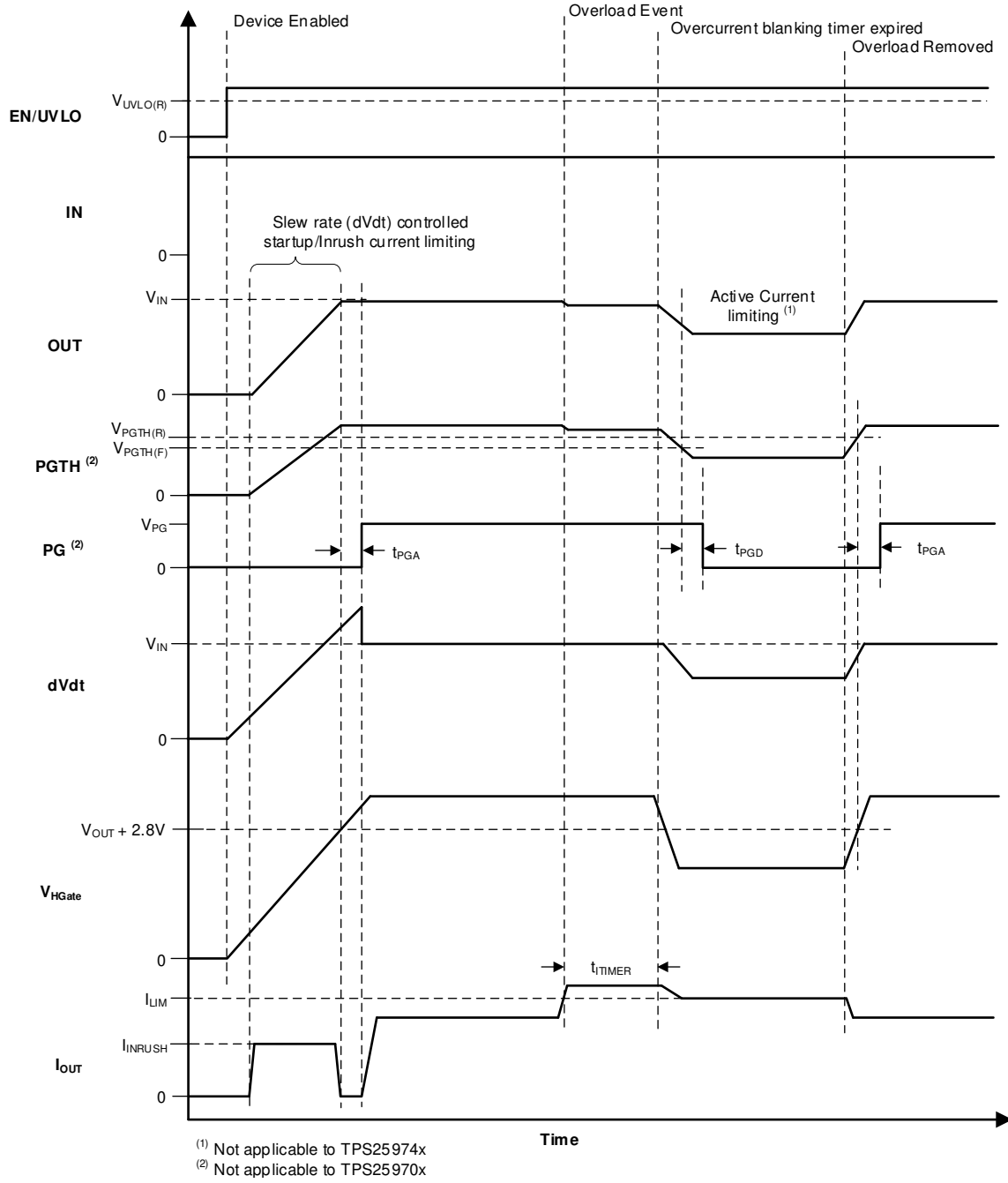
## 7.4 Device Functional Modes

The TPS25970x and TPS25974x variants have only one functional mode that applies when operated within the recommended operating conditions.

The TPS25972x variants have three different functional modes depending on the OVCSEL pin connection.

表 7-5. TPS25972x Oversvoltage Clamp Threshold Selection

OVCSEL PIN CONNECTION	OVERVOLTAGE CLAMP THRESHOLD
Shorted to GND	3.89 V
Open	5.76 V
Connected to GND through a 390-k $\Omega$ resistor	13.88 V

## 8 Application and Implementation

### 备注

Information in the following applications sections is not part of the TI component specification, and TI does not warrant its accuracy or completeness. TI's customers are responsible for determining suitability of components for their purposes, as well as validating and testing their design implementation to confirm system functionality.

### 8.1 Application Information

The TPS2597xx is a 2.7-V to 23-V, 7-A eFuse that is typically used for power rail protection applications. The device operates from 2.7 V to 23 V with adjustable overvoltage and undervoltage protection. The device provides ability to control inrush current and protection against overcurrent conditions. The device can be used in a variety of systems such as adapter input protection, server, PC motherboard, add-on cards, enterprise storage – RAID/HBA/SAN/eSSD, retail point-of-sale terminals, smartphones, and tablets. The design procedure explained in the subsequent sections can be used to select the supporting component values based on the application requirement. Additionally, a spreadsheet design tool, [TPS2597xx Design Calculator](#), is available in the web product folder.

#### 8.1.1 Single Device, Self-Controlled



图 8-1. Single Device, Self-Controlled

#### Other variations:

In a Host MCU controlled system, EN/UVLO or OVLO can also be driven from the host GPIO to control the device.

ILM pin can be connected to the MCU ADC input for current monitoring purpose.

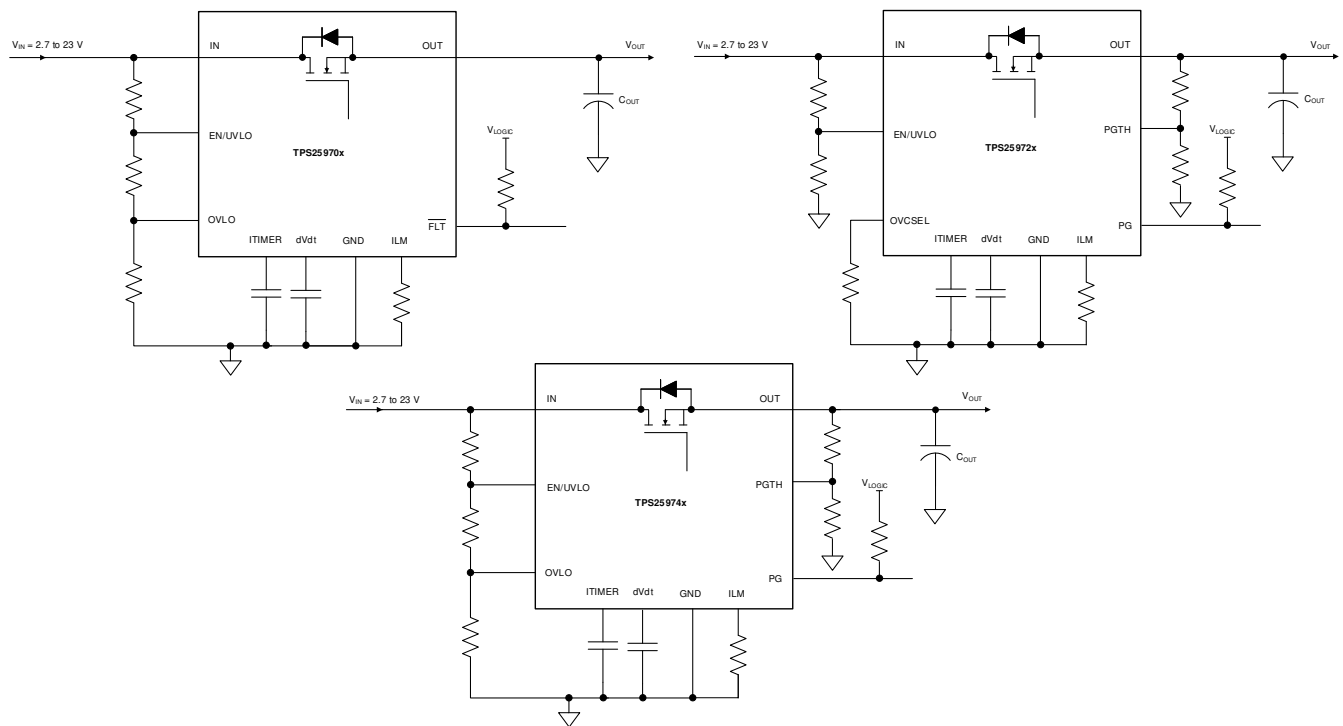
备注

TI recommends to keep parasitic capacitance on ILM pin below 50 pF to ensure stable operation.

For the TPS25972x and TPS25974x variants, either  $V_{IN}$  or  $V_{OUT}$  can be used to drive the PGTH resistor divider depending on which supply must be monitored for Power Good indication.

**8.2 Typical Application**

TPS2597xx can be used for server add-on card input power protection. During overcurrent or short-circuit event at load side, TPS2597xx can quickly respond to this fault event by turning off the device and thus protect the load from damage as well as prevent input supply from drooping. The ITIMER feature allows short duration peak currents to pass through without tripping the eFuse, thereby meeting the transient load current profile of these cards.

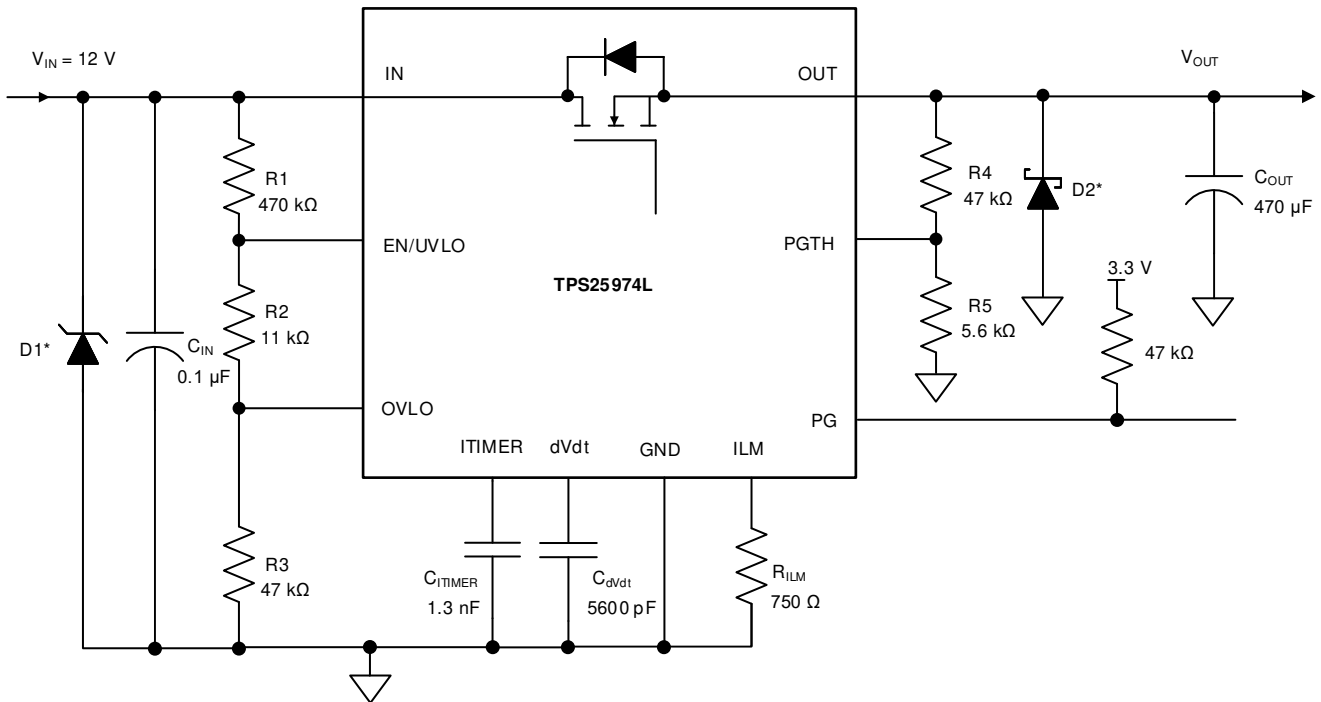

\* Optional circuit components needed for transient protection depending on input and output inductance. Please refer to [Transient Protection](#) section for details.

图 8-2. Server Add-on Card Input Power Protection

## 8.2.1 Design Requirements

**表 8-1. Design Parameters**

PARAMETER	VALUE
Input supply voltage ( $V_{IN}$ )	12 V
Undervoltage threshold ( $V_{IN(UV)}$ )	10.8 V
Overvoltage threshold ( $V_{IN(OV)}$ )	13.2 V
Output Power Good threshold ( $V_{PG}$ )	11.4 V
Maximum continuous current	7 A
Load transient blanking interval ( $t_{TIMER}$ )	1 ms
Output capacitance ( $C_{OUT}$ )	470 $\mu$ F
Output rise time ( $t_R$ )	20 ms
Overcurrent threshold ( $I_{LIM}$ )	7.7 A
Overcurrent response	Circuit breaker
Fault response	Latch-off

## 8.2.2 Detailed Design Procedure

### 8.2.2.1 Device Selection

Because the application requires circuit-breaker response to overcurrent with latch-off response after a fault, the TPS25974L variant is selected after referring to the [Device Comparison Table](#).

### 8.2.2.2 Setting Undervoltage and Overvoltage Thresholds

The supply undervoltage and overvoltage thresholds are set using the resistors R1, R2, and R3, whose values can be calculated using [方程式 10](#) and [方程式 11](#):

$$V_{IN(UV)} = \frac{V_{UVLO(R)} \times (R1 + R2 + R3)}{R2 + R3} \quad (10)$$

$$V_{IN(OV)} = \frac{V_{OV(R)} \times (R1 + R2 + R3)}{R3} \quad (11)$$

Where  $V_{UVLO(R)}$  is the UVLO rising threshold and  $V_{OV(R)}$  is the OVLO rising threshold. Because R1, R2, and R3 leak the current from input supply  $V_{IN}$ , these resistors must be selected based on the acceptable leakage current from input power supply  $V_{IN}$ . The current drawn by R1, R2, and R3 from the power supply is  $I_{R123} = V_{IN} / (R1 + R2 + R3)$ . However, leakage currents due to external active components connected to the resistor string can add error to these calculations. So, the resistor string current,  $I_{R123}$  must be chosen to be 20 times greater than the leakage current expected on the EN/UVLO and OVLO pins.

From the device electrical specifications, both the EN/UVLO and OVLO leakage currents are 0.1  $\mu$ A (maximum),  $V_{OV(R)} = 1.2$  V and  $V_{UVLO(R)} = 1.2$  V. From design requirements,  $V_{IN(OV)} = 13.2$  V and  $V_{IN(UV)} = 10.8$  V. To solve the equation, first choose the value of  $R1 = 470$  k $\Omega$  and use the above equations to solve for  $R2 = 10.7$  k $\Omega$  and  $R3 = 48$  k $\Omega$ .

Using the closest standard 1% resistor values, we get  $R1 = 470$  k $\Omega$ ,  $R2 = 11$  k $\Omega$ , and  $R3 = 47$  k $\Omega$ .

### 8.2.2.3 Setting Output Voltage Rise Time ( $t_R$ )

For a successful design, the junction temperature of the device must be kept below the absolute maximum rating during both dynamic (start-up) and steady-state conditions. Dynamic power stresses often are an order of magnitude greater than the static stresses, so it is important to determine the right start-up time and inrush current limit required with system capacitance to avoid thermal shutdown during start-up.

The slew rate (SR) needed to achieve the desired output rise time can be calculated as:

$$SR (V/ms) = \frac{VIN (V)}{tR (ms)} = \frac{12 V}{20 ms} = 0.6 V/ms \quad (12)$$

The  $C_{dVdt}$  needed to achieve this slew rate can be calculated as:

$$CdVdt (pF) = \frac{3300}{SR (V/ms)} = \frac{3300}{0.6} = 5500 pF \quad (13)$$

Choose the nearest standard capacitor value as 5600 pF.

For this slew rate, the inrush current can be calculated as:

$$IINRUSH (mA) = SR (V/ms) \times COUT (\mu F) = 0.6 \times 470 = 282 mA \quad (14)$$

The average power dissipation inside the part during inrush can be calculated as:

$$PDINRUSH (W) = \frac{IINRUSH (A) \times VIN (V)}{2} = \frac{0.282 \times 12}{2} = 1.69 W \quad (15)$$

For the given power dissipation, the thermal shutdown time of the device must be greater than the ramp-up time  $t_R$  to avoid start-up failure. 图 8-3 shows the thermal shutdown limit. For 1.69 W of power, the shutdown time is more than 10 s, which is very large as compared to  $t_R = 20 ms$ . Therefore, it is safe to use 20 ms as the start-up time for this application.



图 8-3. Thermal Shut-Down Plot During Inrush

#### 备注

In some systems, there can be active load circuits (for example, DC-DC converters) with low turn-on threshold voltages which can start drawing power before the eFuse has completed the inrush sequence. This action can cause additional power dissipation inside the eFuse during start-up and can lead to thermal shutdown. TI recommends to use the Power Good (PG) pin of the eFuse to enable and disable the load circuit. This action ensures that the load is turned on only when the eFuse has completed its start-up and is ready to deliver full power without the risk of hitting thermal shutdown.

#### 8.2.2.4 Setting Power-Good Assertion Threshold

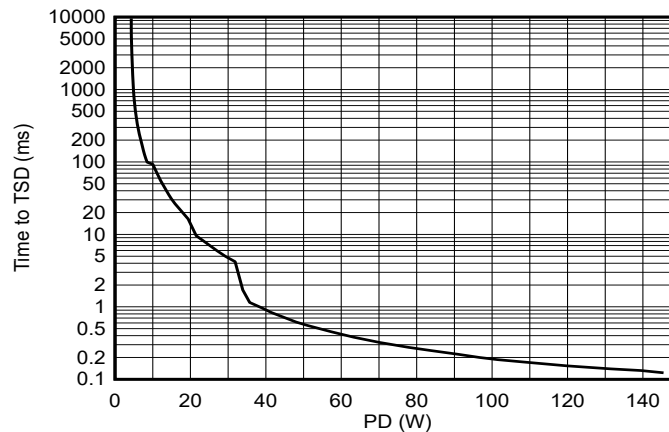
The Power Good assertion threshold can be set using the resistors R4 and R5 connected to the PGTH pin, whose values can be calculated as:

$$VPG = \frac{VPGTH(R) \times (R4 + R5)}{R5} \quad (16)$$

Because R4 and R5 leak the current from the output rail  $V_{OUT}$ , these resistors must be selected to minimize the leakage current. The current drawn by R4 and R5 from the power supply is  $I_{R45} = V_{OUT} / (R4 + R5)$ . However, leakage currents due to external active components connected to the resistor string can add error to these calculations. So, the resistor string current,  $I_{R123}$  must be chosen to be 20 times greater than the PGTH leakage current expected.

From the device electrical specifications, PGTH leakage current is  $1 \mu A$  (maximum),  $V_{PGTH(R)} = 1.2 V$  and from design requirements,  $V_{PG} = 11.4 V$ . To solve the equation, first choose the value of  $R4 = 47 k\Omega$  and calculate  $R5 = 5.52 k\Omega$ . Choose the nearest 1% standard resistor value as  $R5 = 5.6 k\Omega$ .

### 8.2.2.5 Setting Overcurrent Threshold ( $I_{LIM}$ )

The overcurrent protection (Circuit Breaker) threshold can be set using the  $R_{ILM}$  resistor whose value can be calculated as:

$$R_{ILM} (\Omega) = \frac{5747}{I_{LIM} (A)} = \frac{5747}{7.7 A} = 746.4 \Omega \quad (17)$$

Choose nearest 1% standard resistor value as  $715 \Omega$ .

### 8.2.2.6 Setting Overcurrent Blanking Interval ( $t_{TIMER}$ )

The overcurrent blanking timer interval can be set using the  $C_{TIMER}$  capacitor whose value can be calculated as:

$$C_{TIMER} (nF) = \frac{t_{TIMER} (ms) \times I_{TIMER} (\mu A)}{\Delta V_{TIMER} (V)} = \frac{1 \times 2}{1.52} = 1.32 nF \quad (18)$$

Choose nearest standard capacitor value as  $1.3 nF$ .

## 8.2.3 Application Curves



图 8-4. Power Up



图 8-5. Transient Overload

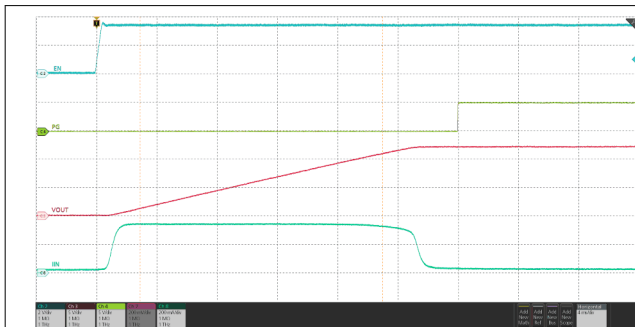

图 8-6. Circuit Breaker Response

### 8.3 Parallel Operation

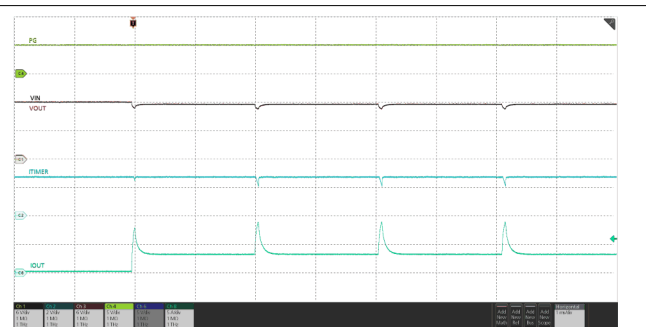
Applications that need higher steady current can use two TPS25974x devices connected in parallel as shown in [图 8-7](#). In this configuration, the first device turns on initially to provide the inrush current control. The second device is held in an OFF state by driving its EN/UVLO pin low using the PG signal of the first device. After the inrush sequence is complete, the first device asserts its PG pin high and turns on the second device. The second device asserts its PG signal to indicate when it has turned on fully, thereby indicating to the system that the parallel combination is ready to deliver the full steady state current.

After in steady state, both devices share current nearly equally. There can be a slight skew in the currents depending on the part-to-part variation in the  $R_{ON}$  as well as the PCB trace resistance mismatch.

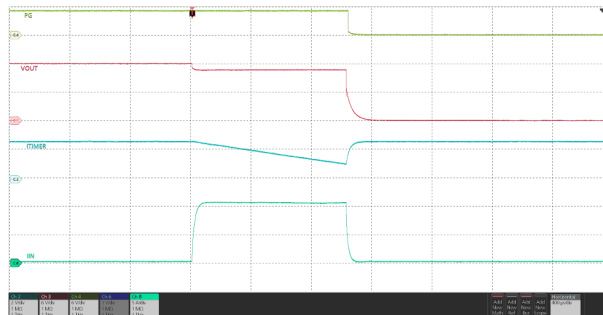



图 8-7. Two Devices Connected in Parallel for Higher Steady State Current Capability

The waveforms below illustrate the behavior of the parallel configuration during start-up as well as during steady state.



图 8-8. Parallel Devices Sequencing During Start-Up

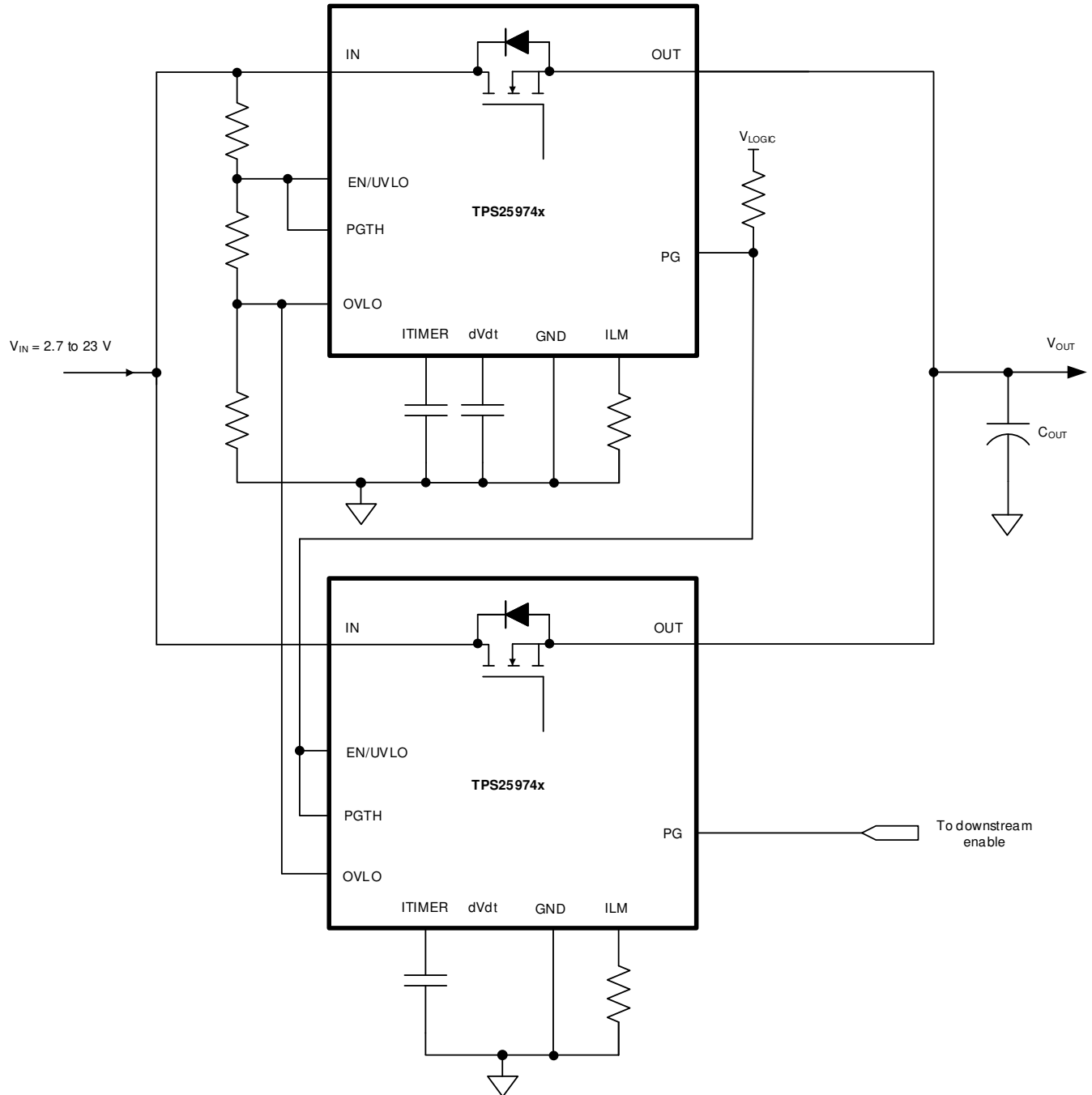

图 8-9. Parallel Devices Load Current During Steady State and Overload

## 8.4 Power Supply Recommendations

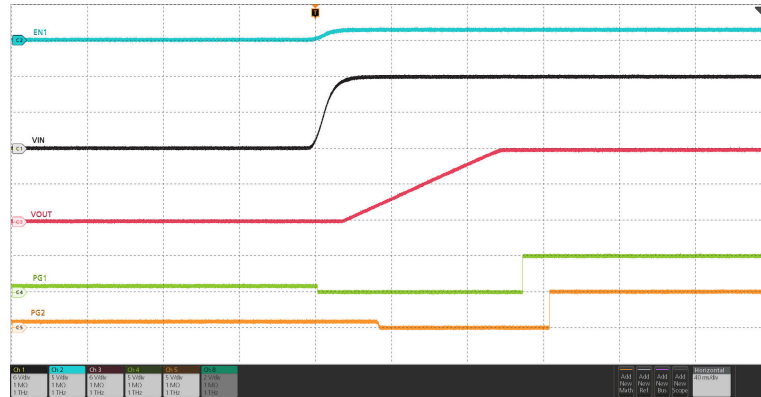
The TPS2597xx devices are designed for a supply voltage range of  $2.7\text{ V} \leq V_{\text{IN}} \leq 23\text{ V}$ . TI recommends an input ceramic bypass capacitor higher than  $0.1\ \mu\text{F}$  if the input supply is located more than a few inches from the device. The power supply must be rated higher than the set current limit to avoid voltage droops during overcurrent and short-circuit conditions.

### 8.4.1 Transient Protection

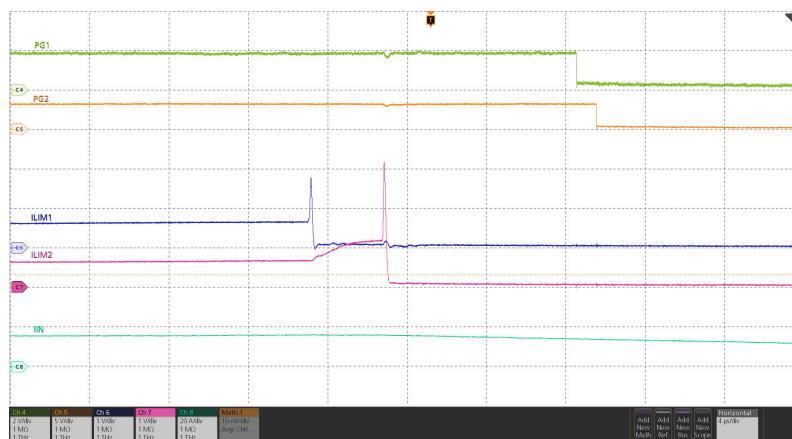
In the case of a short-circuit and overload current limit when the device interrupts current flow, the input inductance generates a positive voltage spike on the input, and the output inductance generates a negative voltage spike on the output. The peak amplitude of voltage spikes (transients) is dependent on the value of inductance in series to the input or output of the device. Such transients can exceed the absolute maximum ratings of the device if steps are not taken to address the issue. Typical methods for addressing transients include:

- Minimize lead length and inductance into and out of the device.
- Use a large PCB GND plane.
- Connect a Schottky diode from the OUT pin ground to absorb negative spikes.
- Connect a low ESR capacitor larger than  $1\ \mu\text{F}$  at the OUT pin very close to the device.
- Use a low-value ceramic capacitor  $C_{\text{IN}} = 1\ \mu\text{F}$  to absorb the energy and dampen the transients. The capacitor voltage rating must be at least twice the input supply voltage to be able to withstand the positive voltage excursion during inductive ringing.

Use 方程式 19 to estimate the approximate value of input capacitance:

$$V_{SPIKE(Absolute)} = V_{IN} + I_{LOAD} \times \sqrt{\frac{L_{IN}}{C_{IN}}} \quad (19)$$

where

- $V_{IN}$  is the nominal supply voltage.
- $I_{LOAD}$  is the load current.
- $L_{IN}$  equals the effective inductance seen looking into the source.
- $C_{IN}$  is the capacitance present at the input.
- Some applications can require the addition of a Transient Voltage Suppressor (TVS) to prevent transients from exceeding the absolute maximum ratings of the device. In some cases, even if the maximum amplitude of the transients is below the absolute maximum rating of the device, a TVS can help to absorb the excessive energy dump and prevent it from creating very fast transient voltages on the input supply pin of the IC, which can couple to the internal control circuits and cause unexpected behavior.

图 8-10 shows the circuit implementation with optional protection components.



图 8-10. Circuit Implementation With Optional Protection Components

#### 8.4.2 Output Short-Circuit Measurements

It is difficult to obtain repeatable and similar short-circuit testing results. The following contribute to variation in results:

- Source bypassing
- Input leads
- Circuit layout
- Component selection
- Output shorting method
- Relative location of the short
- Instrumentation

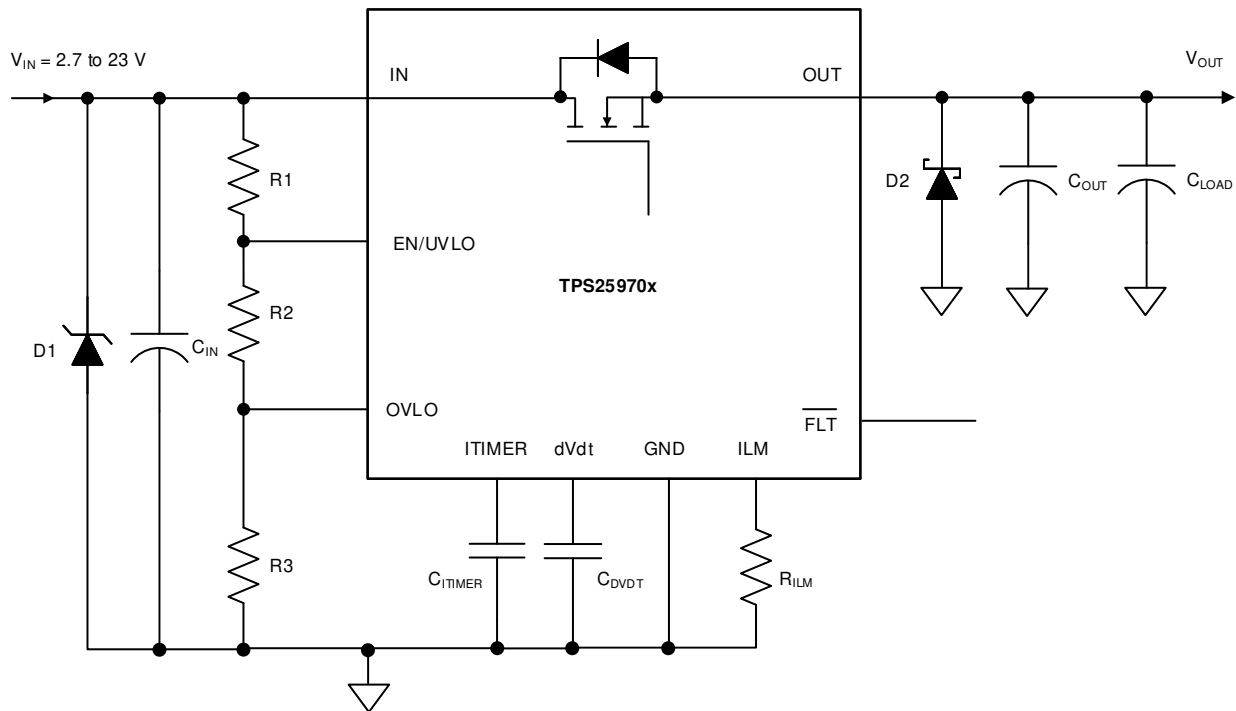
The actual short exhibits a certain degree of randomness because it microscopically bounces and arcs. Ensure that configuration and methods are used to obtain realistic results. Do not expect to see waveforms exactly like those in this data sheet because every setup is different.

## 8.5 Layout

### 8.5.1 Layout Guidelines

- For all applications, TI recommends a ceramic decoupling capacitor of 0.1  $\mu$ F or greater between the IN terminal and GND terminal.
- The optimal placement of the decoupling capacitor is closest to the IN and GND terminals of the device. Care must be taken to minimize the loop area formed by the bypass-capacitor connection, the IN terminal, and the GND terminal of the IC.
- High current-carrying power-path connections must be as short as possible and must be sized to carry at least twice the full-load current.
- The GND terminal must be tied to the PCB ground plane at the terminal of the IC with the shortest possible trace. The PCB ground must be a copper plane or island on the board. TI recommends to have a separate ground plane island for the eFuse. This plane does not carry any high currents and serves as a quiet ground reference for all the critical analog signals of the eFuse. The device ground plane must be connected to the system power ground plane using a star connection.
- The IN and OUT pins are used for heat dissipation. Connect to as much copper area on top and bottom PCB layers using as possible with thermal vias. The vias under the device also help to minimize the voltage gradient across the IN and OUT pads and distribute current uniformly through the device, which is essential to achieve the best on-resistance and current sense accuracy.
- Locate the following support components close to their connection pins:
  - R<sub>ILM</sub>
  - C<sub>dVdT</sub>
  - C<sub>ITIMER</sub>
  - Resistors for the EN/UVLO, OVLO/OVCSEL, and PGTH pins
- Connect the other end of the component to the GND pin of the device with shortest trace length. The trace routing for the RILM, CITIMER and CdVdt components to the device must be as short as possible to reduce parasitic effects on the current limit, overcurrent blanking interval and soft start timing. It's recommended to keep parasitic capacitance on ILM pin below 50 pF to ensure stable operation. These traces must not have any coupling to switching signals on the board.
- Because the bias current on ILM pin directly controls the overcurrent protection behavior of the device, the PCB routing of this node must be kept away from any noisy (switching) signals.
- Protection devices such as TVS, snubbers, capacitors, or diodes must be placed physically close to the device they are intended to protect. These protection devices must be routed with short traces to reduce inductance. For example, TI recommends a protection Schottky diode to address negative transients due to switching of inductive loads. TI also recommends to add a ceramic decoupling capacitor of 1  $\mu$ F or greater between OUT and GND. These components must be physically close to the OUT pins. Care must be taken to minimize the loop area formed by the Schottky diode/bypass-capacitor connection, the OUT pin, and the GND terminal of the IC.

### 8.5.2 Layout Example



图 8-11. Layout Example - Single TPS25974x With PGTH Referred to OUT

## 9 Device and Documentation Support

TI offers an extensive line of development tools. Tools and software to evaluate the performance of the device, generate code, and develop solutions are listed below.

### 9.1 Device Support

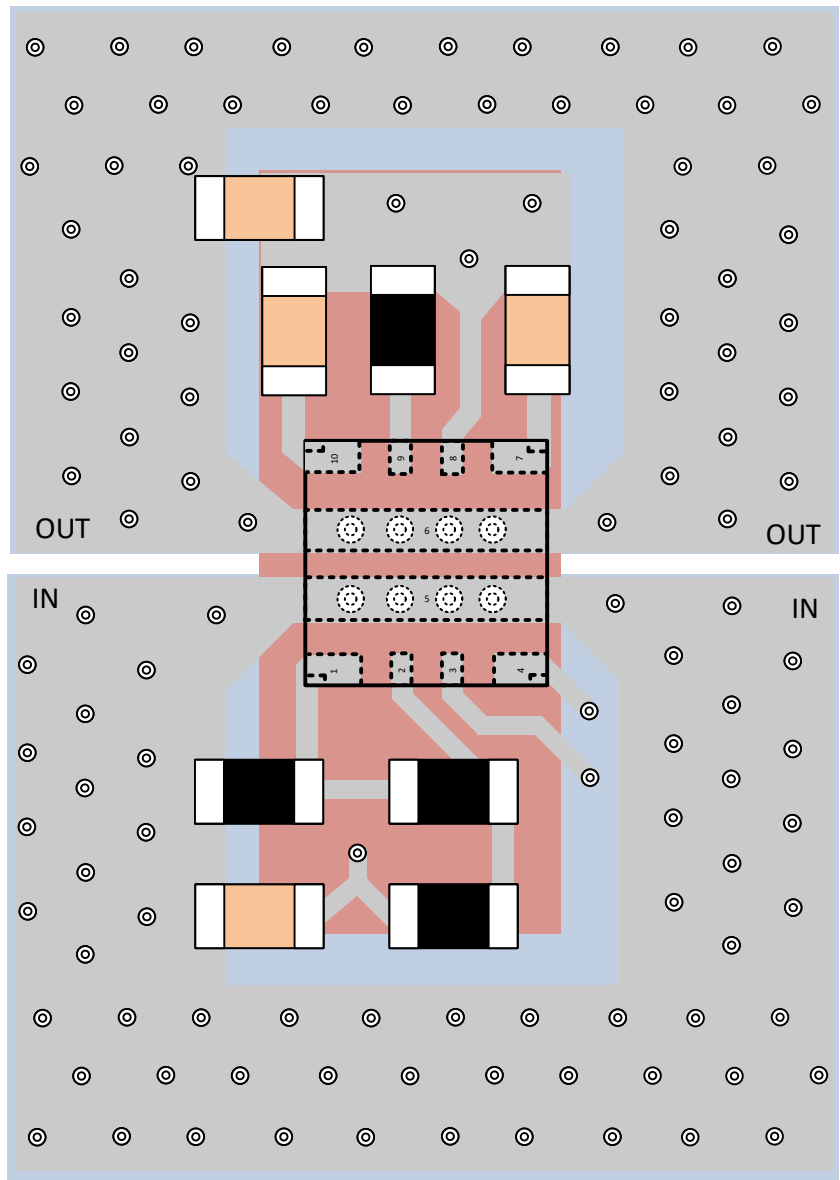
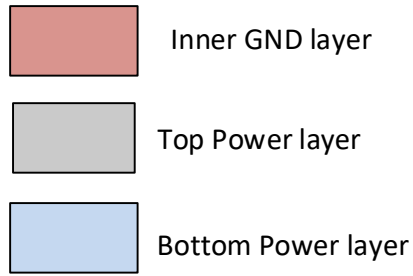
#### 9.1.1 第三方产品免责声明

TI 发布的与第三方产品或服务有关的信息，不能构成与此类产品或服务或保修的适用性有关的认可，不能构成此类产品或服务单独或与任何 TI 产品或服务一起的表示或认可。

### 9.2 Documentation Support

#### 9.2.1 Related Documentation

For related documentation see the following:

- Texas Instruments, [TPS2597EVM eFuse Evaluation Board user's guide](#)
- Texas Instruments, [TPS2597xx Design Calculator](#)

### 9.3 接收文档更新通知

要接收文档更新通知，请导航至 [ti.com](#) 上的器件产品文件夹。点击 [通知](#) 进行注册，即可每周接收产品信息更改摘要。有关更改的详细信息，请查看任何已修订文档中包含的修订历史记录。

### 9.4 支持资源

TI E2E™ [中文支持论坛](#) 是工程师的重要参考资料，可直接从专家处获得快速、经过验证的解答和设计帮助。搜索现有解答或提出自己的问题，获得所需的快速设计帮助。

链接的内容由各个贡献者“按原样”提供。这些内容并不构成 TI 技术规范，并且不一定反映 TI 的观点；请参阅 TI 的 [使用条款](#)。

### 9.5 Trademarks

HotRod™ and TI E2E™ are trademarks of Texas Instruments.

所有商标均为其各自所有者的财产。

### 9.6 静电放电警告



静电放电 (ESD) 会损坏这个集成电路。德州仪器 (TI) 建议通过适当的预防措施处理所有集成电路。如果不遵守正确的处理和安装程序，可能会损坏集成电路。

ESD 的损坏小至导致微小的性能降级，大至整个器件故障。精密的集成电路可能更容易受到损坏，这是因为非常细微的参数更改都可能会导致器件与其发布的规格不相符。

### 9.7 术语表

[TI 术语表](#) 本术语表列出并解释了术语、首字母缩略词和定义。

## 10 Revision History

注：以前版本的页码可能与当前版本的页码不同

Changes from Revision C (April 2023) to Revision D (May 2025)	Page
• Added maximum input voltage rising slew rate = 100V/μs to <i>Absolute Maximum Ratings</i> section.....	5
• Added maximum input voltage falling slew rate = 10V/μs to <i>Absolute Maximum Ratings</i> section.....	5

---

**Changes from Revision B (January 2022) to Revision C (April 2023)**

**Page**

- 更新了 UL/IEC 认证状态..... **1**
-

## 11 Mechanical, Packaging, and Orderable Information

The following pages include mechanical, packaging, and orderable information. This information is the most current data available for the designated devices. This data is subject to change without notice and revision of this document. For browser-based versions of this data sheet, refer to the left-hand navigation.



**PACKAGING INFORMATION**

Orderable part number	Status (1)	Material type (2)	Package   Pins	Package qty   Carrier	RoHS (3)	Lead finish/ Ball material (4)	MSL rating/ Peak reflow (5)	Op temp (°C)	Part marking (6)
<a href="#">TPS25970ARPWR</a>	Active	Production	VQFN-HR (RPW)   10	3000   LARGE T&R	Yes	SN	Level-2-260C-1 YEAR	-40 to 125	2KNH
TPS25970ARPWR.A	Active	Production	VQFN-HR (RPW)   10	3000   LARGE T&R	Yes	SN	Level-2-260C-1 YEAR	-40 to 125	2KNH
<a href="#">TPS25970LRPWR</a>	Active	Production	VQFN-HR (RPW)   10	3000   LARGE T&R	Yes	SN	Level-2-260C-1 YEAR	-40 to 125	2KOH
TPS25970LRPWR.A	Active	Production	VQFN-HR (RPW)   10	3000   LARGE T&R	Yes	SN	Level-2-260C-1 YEAR	-40 to 125	2KOH
<a href="#">TPS25972ARPWR</a>	Active	Production	VQFN-HR (RPW)   10	3000   LARGE T&R	Yes	SN	Level-2-260C-1 YEAR	-40 to 125	2KPH
TPS25972ARPWR.A	Active	Production	VQFN-HR (RPW)   10	3000   LARGE T&R	Yes	SN	Level-2-260C-1 YEAR	-40 to 125	2KPH
<a href="#">TPS25972LRPWR</a>	Active	Production	VQFN-HR (RPW)   10	3000   LARGE T&R	Yes	SN	Level-2-260C-1 YEAR	-40 to 125	2KQH
TPS25972LRPWR.A	Active	Production	VQFN-HR (RPW)   10	3000   LARGE T&R	Yes	SN	Level-2-260C-1 YEAR	-40 to 125	2KQH
<a href="#">TPS25974ARPWR</a>	Active	Production	VQFN-HR (RPW)   10	3000   LARGE T&R	Yes	SN	Level-2-260C-1 YEAR	-40 to 125	2KRH
TPS25974ARPWR.A	Active	Production	VQFN-HR (RPW)   10	3000   LARGE T&R	Yes	SN	Level-2-260C-1 YEAR	-40 to 125	2KRH
<a href="#">TPS25974LRPWR</a>	Active	Production	VQFN-HR (RPW)   10	3000   LARGE T&R	Yes	SN	Level-2-260C-1 YEAR	-40 to 125	2KSH
TPS25974LRPWR.A	Active	Production	VQFN-HR (RPW)   10	3000   LARGE T&R	Yes	SN	Level-2-260C-1 YEAR	-40 to 125	2KSH

(1) **Status:** For more details on status, see our [product life cycle](#).

(2) **Material type:** When designated, preproduction parts are prototypes/experimental devices, and are not yet approved or released for full production. Testing and final process, including without limitation quality assurance, reliability performance testing, and/or process qualification, may not yet be complete, and this item is subject to further changes or possible discontinuation. If available for ordering, purchases will be subject to an additional waiver at checkout, and are intended for early internal evaluation purposes only. These items are sold without warranties of any kind.

(3) **RoHS values:** Yes, No, RoHS Exempt. See the [TI RoHS Statement](#) for additional information and value definition.

(4) **Lead finish/Ball material:** Parts may have multiple material finish options. Finish options are separated by a vertical ruled line. Lead finish/Ball material values may wrap to two lines if the finish value exceeds the maximum column width.

(5) **MSL rating/Peak reflow:** The moisture sensitivity level ratings and peak solder (reflow) temperatures. In the event that a part has multiple moisture sensitivity ratings, only the lowest level per JEDEC standards is shown. Refer to the shipping label for the actual reflow temperature that will be used to mount the part to the printed circuit board.

(6) **Part marking:** There may be an additional marking, which relates to the logo, the lot trace code information, or the environmental category of the part.

Multiple part markings will be inside parentheses. Only one part marking contained in parentheses and separated by a "-" will appear on a part. If a line is indented then it is a continuation of the previous line and the two combined represent the entire part marking for that device.

**Important Information and Disclaimer:** The information provided on this page represents TI's knowledge and belief as of the date that it is provided. TI bases its knowledge and belief on information provided by third parties, and makes no representation or warranty as to the accuracy of such information. Efforts are underway to better integrate information from third parties. TI has taken and continues to take reasonable steps to provide representative and accurate information but may not have conducted destructive testing or chemical analysis on incoming materials and chemicals. TI and TI suppliers consider certain information to be proprietary, and thus CAS numbers and other limited information may not be available for release.

In no event shall TI's liability arising out of such information exceed the total purchase price of the TI part(s) at issue in this document sold by TI to Customer on an annual basis.

**TAPE AND REEL INFORMATION**

**QUADRANT ASSIGNMENTS FOR PIN 1 ORIENTATION IN TAPE**



\*All dimensions are nominal

Device	Package Type	Package Drawing	Pins	SPQ	Reel Diameter (mm)	Reel Width W1 (mm)	A0 (mm)	B0 (mm)	K0 (mm)	P1 (mm)	W (mm)	Pin1 Quadrant
TPS25970ARPWR	VQFN-HR	RPW	10	3000	180.0	8.4	2.3	2.3	1.15	4.0	8.0	Q2
TPS25970LRPWR	VQFN-HR	RPW	10	3000	180.0	8.4	2.3	2.3	1.15	4.0	8.0	Q2
TPS25972ARPWR	VQFN-HR	RPW	10	3000	180.0	8.4	2.3	2.3	1.15	4.0	8.0	Q2
TPS25972LRPWR	VQFN-HR	RPW	10	3000	180.0	8.4	2.3	2.3	1.15	4.0	8.0	Q2
TPS25974ARPWR	VQFN-HR	RPW	10	3000	180.0	8.4	2.3	2.3	1.15	4.0	8.0	Q2
TPS25974LRPWR	VQFN-HR	RPW	10	3000	180.0	8.4	2.3	2.3	1.15	4.0	8.0	Q2

**TAPE AND REEL BOX DIMENSIONS**

\*All dimensions are nominal

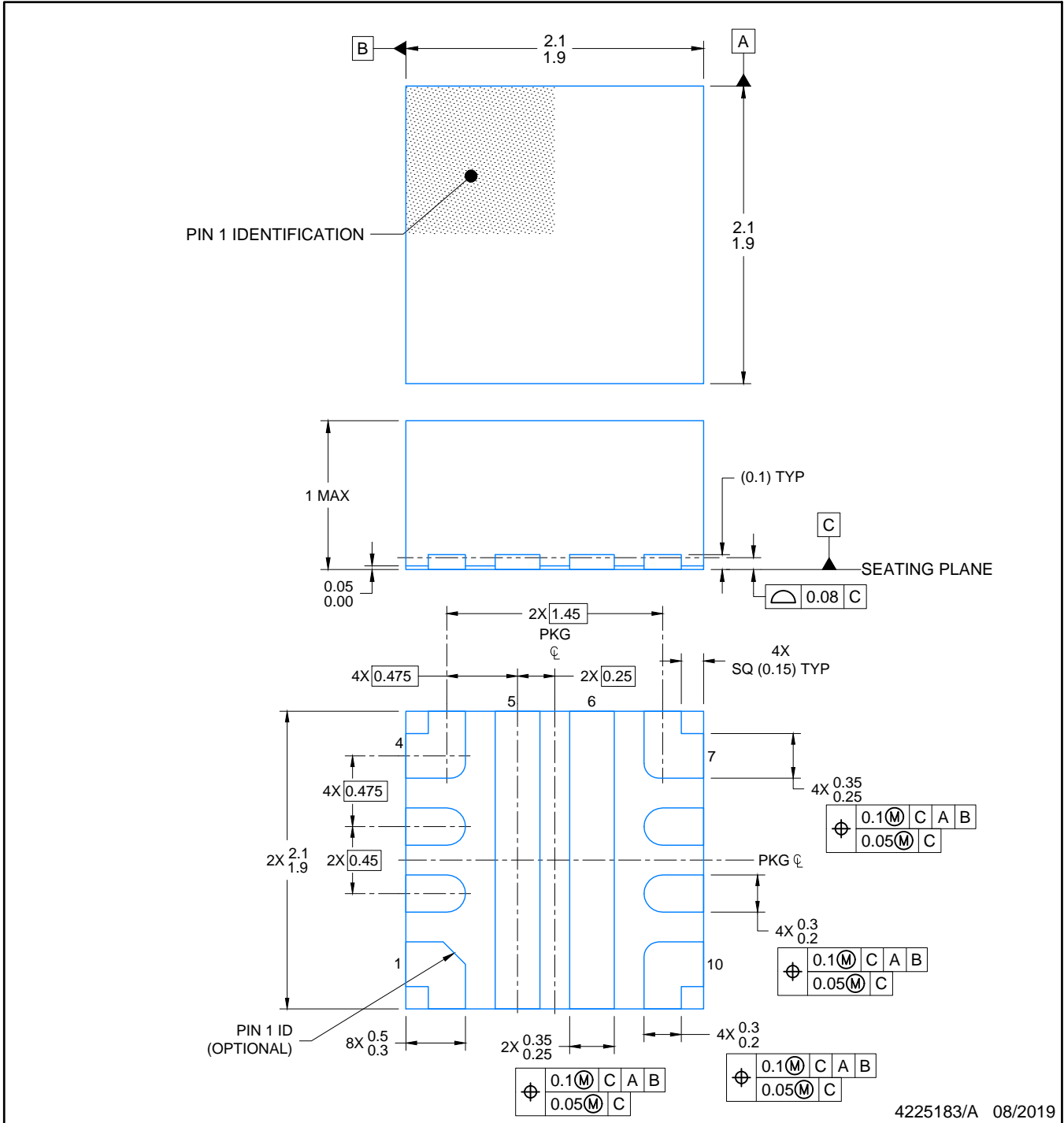
Device	Package Type	Package Drawing	Pins	SPQ	Length (mm)	Width (mm)	Height (mm)
TPS25970ARPWR	VQFN-HR	RPW	10	3000	210.0	185.0	35.0
TPS25970LRPWR	VQFN-HR	RPW	10	3000	210.0	185.0	35.0
TPS25972ARPWR	VQFN-HR	RPW	10	3000	210.0	185.0	35.0
TPS25972LRPWR	VQFN-HR	RPW	10	3000	210.0	185.0	35.0
TPS25974ARPWR	VQFN-HR	RPW	10	3000	210.0	185.0	35.0
TPS25974LRPWR	VQFN-HR	RPW	10	3000	210.0	185.0	35.0



4225183/A 08/2019

NOTES:

1. All linear dimensions are in millimeters. Any dimensions in parenthesis are for reference only. Dimensioning and tolerancing per ASME Y14.5M.
2. This drawing is subject to change without notice.

# EXAMPLE BOARD LAYOUT

## VQFN-HR - 1 mm max height

RPW0010A

PLASTIC QUAD FLATPACK - NO LEAD

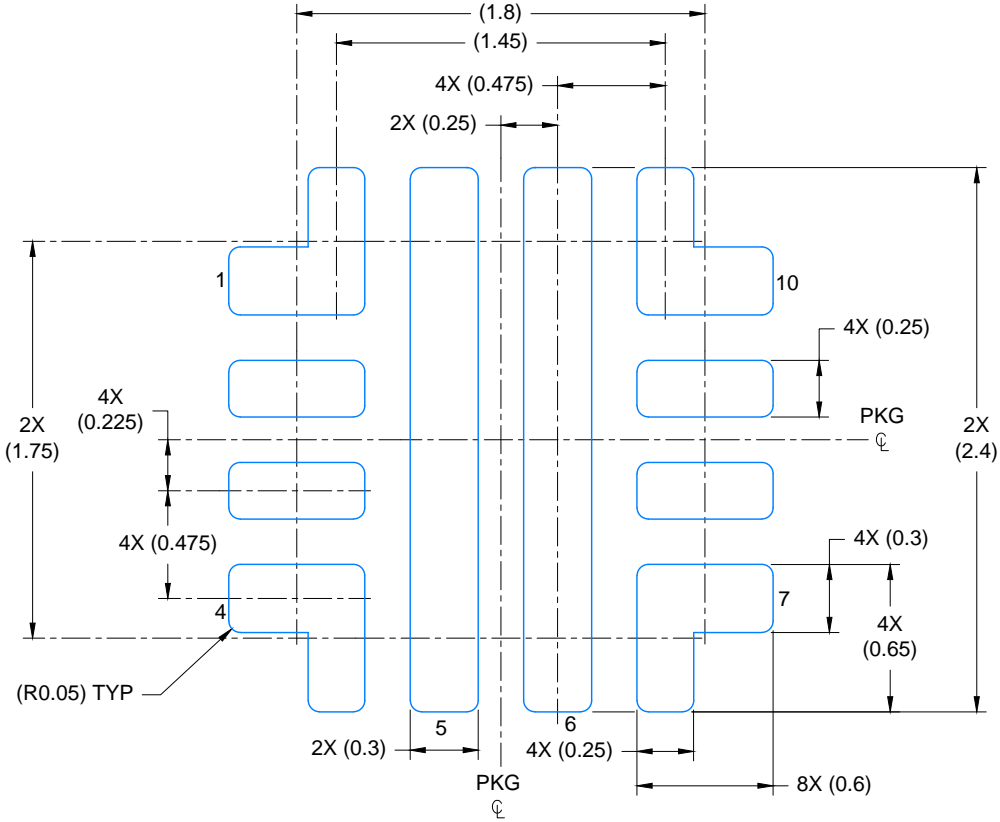

LAND PATTERN EXAMPLE  
SCALE: 30X

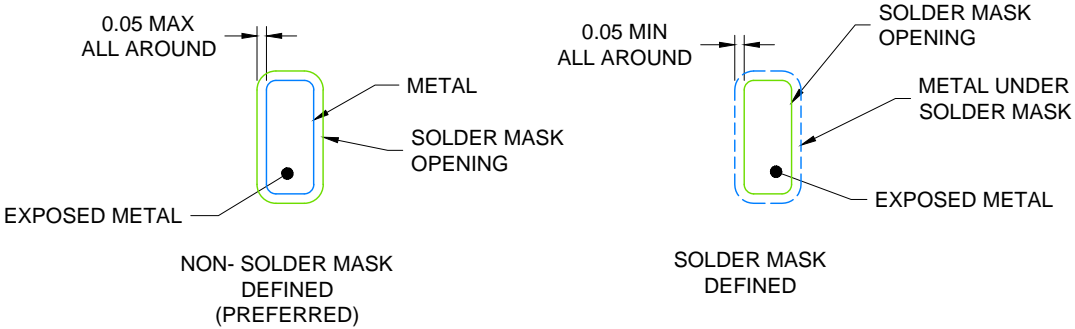

SOLDER MASK DETAILS  
NOT TO SCALE

4225183/A 08/2019

NOTES: (continued)

3. For more information, see Texas Instruments literature number SLUA271 ([www.ti.com/lit/sluea271](http://www.ti.com/lit/sluea271)).
4. Solder mask tolerances between and around signal pads can vary based on board fabrication site.

# EXAMPLE STENCIL DESIGN

RPW0010A

VQFN-HR - 1 mm max height

PLASTIC QUAD FLATPACK - NO LEAD

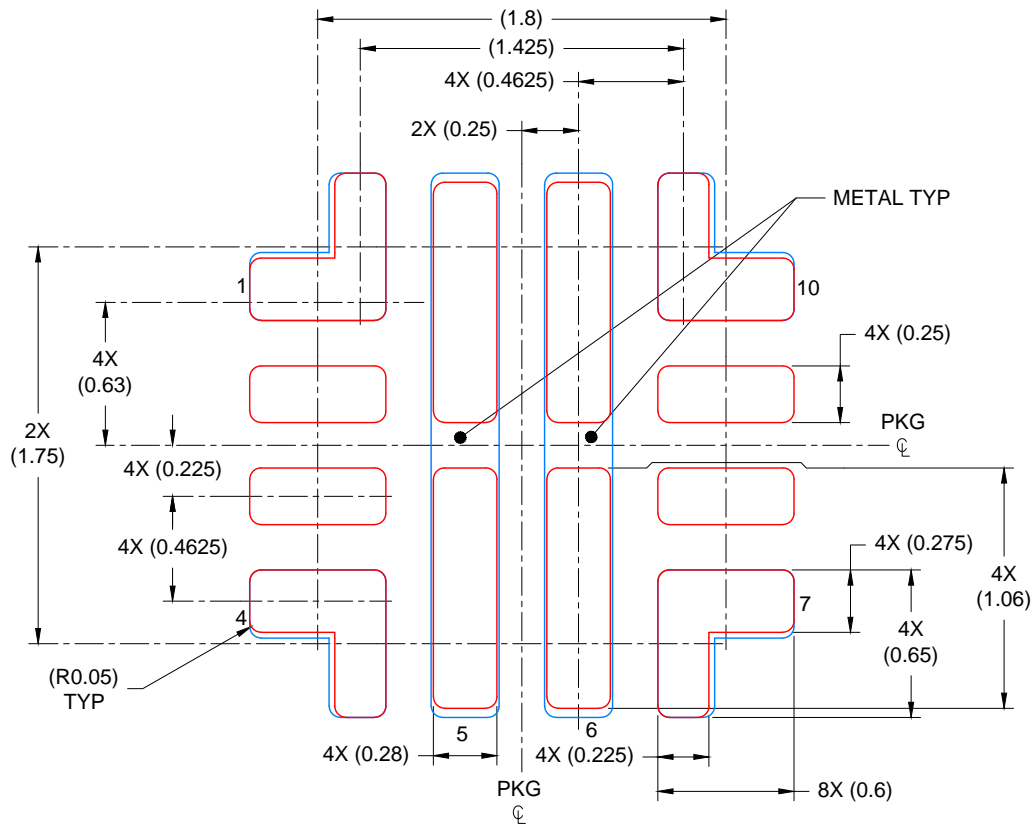

SOLDER PASTE EXAMPLE  
BASED ON 0.100 mm THICK STENCIL

PADS 1, 4, 7 & 10: 93%; PADS 5 & 6: 82%  
SCALE: 30X

4225183/A 08/2019

NOTES: (continued)

5. Laser cutting apertures with trapezoidal walls and rounded corners may offer better paste release. IPC-7525 may have alternate design recommendations.

## 重要通知和免责声明

TI“按原样”提供技术和可靠性数据（包括数据表）、设计资源（包括参考设计）、应用或其他设计建议、网络工具、安全信息和其他资源，不保证没有瑕疵且不做任何明示或暗示的担保，包括但不限于对适销性、与某特定用途的适用性或不侵犯任何第三方知识产权的暗示担保。

这些资源可供使用 TI 产品进行设计的熟练开发人员使用。您将自行承担以下全部责任：(1) 针对您的应用选择合适的 TI 产品，(2) 设计、验证并测试您的应用，(3) 确保您的应用满足相应标准以及任何其他安全、安保法规或其他要求。

这些资源如有变更，恕不另行通知。TI 授权您仅可将这些资源用于研发本资源所述的 TI 产品的相关应用。严禁以其他方式对这些资源进行复制或展示。您无权使用任何其他 TI 知识产权或任何第三方知识产权。对于因您对这些资源的使用而对 TI 及其代表造成的任何索赔、损害、成本、损失和债务，您将全额赔偿，TI 对此概不负责。

TI 提供的产品受 [TI 销售条款](#)、[TI 通用质量指南](#) 或 [ti.com](#) 上其他适用条款或 TI 产品随附的其他适用条款的约束。TI 提供这些资源并不会扩展或以其他方式更改 TI 针对 TI 产品发布的适用的担保或担保免责声明。除非德州仪器 (TI) 明确将某产品指定为定制产品或客户特定产品，否则其产品均为按确定价格收入目录的标准通用器件。

TI 反对并拒绝您可能提出的任何其他或不同的条款。

版权所有 © 2025，德州仪器 (TI) 公司

最后更新日期：2025 年 10 月