

Best-in-Class Radiated Emissions EMI Performance With Isolated Amplifiers



Andrew Cao

ABSTRACT

Several industrial and automotive applications require some type of isolation to protect the digital circuitry from the high-voltage circuit performing a function. Texas Instruments has an extensive portfolio of [isolated amplifiers](#) and [data converters](#) featuring a capacitive isolation barrier to help customers address isolated data conversion needs. Texas Instruments' capacitive isolation barrier allows for exceptional reliability, often over 100 years of operation. For more information on TI's capacitive isolation barrier, see the [Isolation](#) website.

Radiated emissions testing is common in these applications to verify the system does not produce radiated emissions that exceed the defined levels which can negatively impact other components or circuits in the system. See [Understanding electromagnetic compliance tests in digital isolators](#) for a more in-depth description of EMI. The magnitude of acceptable radiation and testing procedure for radiated emissions is put in place by the Comité International Spécial des Perturbations Radio, also known as CISPR. Industrial applications measure according to the CISPR 11 standard, while automotive applications measure to the CISPR 25 standard. For more information on the CISPR standards and the respective magnitudes over frequency, see [An overview of conducted EMI specifications for power supplies](#).

This document shows the radiated emissions electromagnetic interference (EMI) performance of the following Texas Instruments' isolated amplifiers: [AMC0381D-Q1](#), [AMC0311D-Q1](#), [AMC1200C](#), [AMC0300D](#), [AMC1200BDWV](#), [AMC1200BDUB](#), [AMC1400](#), [AMC1300](#), [AMC3330](#), and [AMC131M03](#).

For radiated emissions EMI guidance for the AMC3301 family, see [Best Practices to Attenuate AMC3301 Family Radiated Emissions EMI](#).

Table of Contents

1 Introduction	3
2 Current Generation of Texas Instruments Isolated Amplifiers Radiated Emissions Performance	5
3 Previous Generations of Texas Instruments Isolated Amplifiers Radiated Emissions Performance	9
4 Summary	15
5 References	15

List of Figures

Figure 1-1. Isolated Amplifier Block Diagram.....	3
Figure 1-2. CISPR 25 Test Set Up.....	4
Figure 2-1. AMC0311D-Q1 CISPR 25 Radiated Emissions EMI High Voltage Long Scan.....	5
Figure 2-2. AMC0311D-Q1 CISPR 25 Radiated Emissions EMI Low Voltage Long Scan.....	5
Figure 2-3. AMC0300D CISPR 25 Radiated Emissions EMI High Voltage Long Scan.....	6
Figure 2-4. AMC0300D CISPR 25 Radiated Emissions EMI Low Voltage Long Scan.....	6
Figure 2-5. AMC0381D-Q1 CISPR 25 Radiated Emissions EMI High Voltage Long Scan.....	7
Figure 2-6. AMC0381D-Q1 CISPR 25 Radiated Emissions EMI Low Voltage Long Scan.....	7
Figure 2-7. AMC1200C CISPR 25 Radiated Emissions EMI High Voltage Long Scan.....	8
Figure 2-8. AMC1200C CISPR 25 Radiated Emissions EMI Low Voltage Long Scan.....	8
Figure 3-1. AMC1200DUB CISPR 25 Radiated Emissions EMI High Voltage Long Scan.....	9
Figure 3-2. AMC1200DUB CISPR 25 Radiated Emissions EMI Low Voltage Long Scan.....	9
Figure 3-3. AMC1200DWV CISPR 25 Radiated Emissions EMI High Voltage Long Scan.....	10
Figure 3-4. AMC1200DWV CISPR 25 Radiated Emissions EMI Low Voltage Long Scan.....	10

Figure 3-5. AMC1400 CISPR 25 Radiated Emissions EMI High Voltage Long Scan.....	11
Figure 3-6. AMC1400 CISPR 25 Radiated Emissions EMI Low Voltage Long Scan.....	11
Figure 3-7. AMC1300 CISPR 25 Radiated Emissions EMI High Voltage Long Scan.....	12
Figure 3-8. AMC1300 CISPR 25 Radiated Emissions EMI High Voltage Long Scan.....	12
Figure 3-9. AMC3330 CISPR 25 Radiated Emissions EMI High Voltage Long Scan.....	13
Figure 3-10. AMC3330 CISPR 25 Radiated Emissions EMI Low Voltage Long Scan.....	13
Figure 3-11. AMC131M03 CISPR 25 Radiated Emissions EMI High Voltage Long Scan.....	14
Figure 3-12. AMC131M03 CISPR 25 Radiated Emissions EMI Low Voltage Long Scan.....	14

Trademarks

All trademarks are the property of their respective owners.

1 Introduction

In isolated amplifiers with a capacitive isolation barrier, radiated emissions can be created when the capacitors that span the barrier are charged and discharged to transmit data in the form of either a one or a zero. The charges flow through the differential capacitors in opposite directions mostly canceling each other, however any difference in magnitude or time between these charge flows results in electro-magnetic energy injected between the isolated grounds GND1 and GND2. Because of the nature of the isolation barrier, the energy is unable to find a conductor to return to the source. With no path back to the source, the energy radiates from the device pins (and any traces or PCB planes the pins are connected to) in the form of radiated emissions. This radiation can extend to frequencies significantly above the amplifier signal bandwidth and data rates, since this is caused by timing mismatches in the pico-second range.

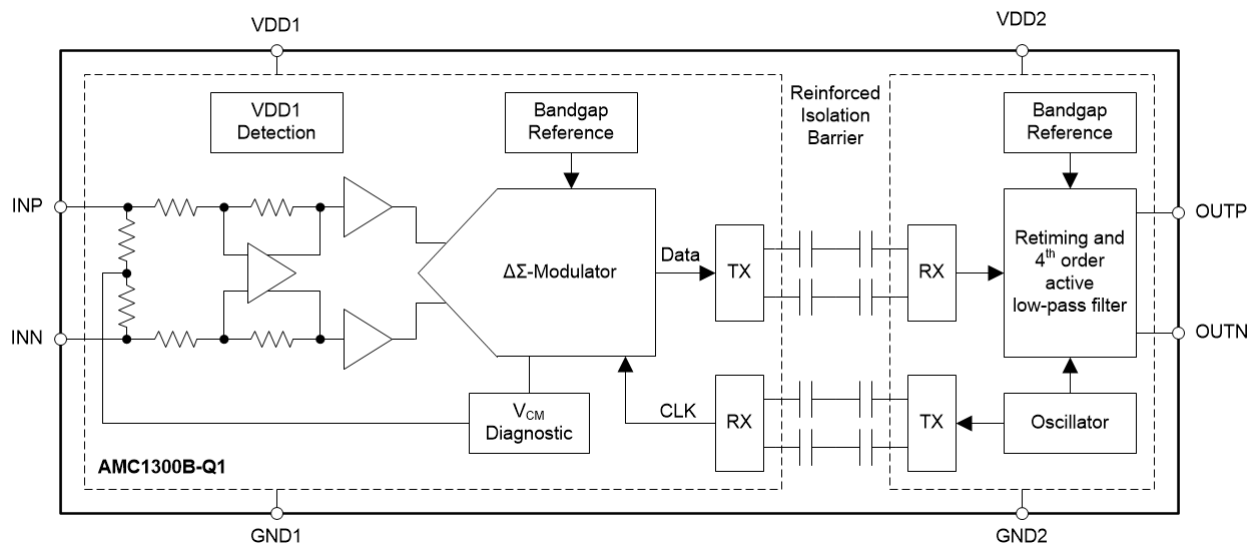

Figure 1-1. Isolated Amplifier Block Diagram

Within the recent years, there have been significant improvements to the architecture of Texas Instruments isolated amplifiers to optimize radiated EMI performance. Beginning in 2018 with the [ISO224](#), isolated amplifiers from Texas Instruments began to use on or off keying (OOK) signal modulation compared to previously used pulse coding. The OOK modulation enabled significantly improved Common-Mode Transient Immunity levels. Then in 2020, the [AMC1300B-Q1](#) was the first isolated amplifier that significantly reduced the amount of energy crossing over the isolation barrier, which reduces the radiated emissions, providing sufficient margins to the standard specifications. Now in 2025, the [AMC03xx](#) family of devices further reduce the radiated emissions with new single-capacitor isolation technology. These design changes, as well as a re-designed isolated signal path, are now present in the entire Texas Instruments isolated amplifier portfolio, with the exception of the [AMC1100](#), [AMC1200](#), and [ISO224](#) devices. The optimized timing and amplitude in the signal chain yields a reduction of radiated emissions EMI at high frequencies to an even lower level.

The following sections show the radiated emissions EMI performance for the Texas Instruments' isolated amplifiers. The current generation of isolated amplifiers radiated emissions performance data is shown by the [AMC0381D-Q1](#), [AMC0311D-Q1](#), [AMC1200C](#), and [AMC0300D](#), while the previous generation data is shown by the [AMC1200BDWV](#), [AMC1200BDUB](#), [AMC1400](#), [AMC1300](#), [AMC3330](#), and [AMC131M03](#). The radiated emissions scans were all performed according to the standards set in place by CISPR 25. All tests were performed using each devices respective EVM except for the [AMC0311D-Q1](#), [AMC1200C](#), and [AMC0300D](#), which use the [DIYAMC-0-EVM](#) printed circuit board (PCB).

For the test setup, if present, the transformer driver (U3) was removed from the EVM to reduce external component noise. The inputs were shorted to ground, and the outputs were connected through a resistor as shown by the [Device Pin Setup](#) in [Figure 1-2](#). Two external 3.3V batteries power the high voltage and low voltage side of the device. One battery was connected directly to the EVM of the device, and the other battery was connected to LISN. LISN was then connected to a wire that spanned the table to power the side of the

device tested. A 1.5m wire is connected to the input or output of the device on the same side as the power from LISN.

For each device, two tests were conducted: low voltage long and high voltage long. The configuration for low voltage long is shown in [Option A in CISPR 25 Test Set Up](#). The input is connected to the 1.5m wire, and a short is connected to the end of the wire. The output is connected through a resistor. For power, the low voltage side is connected to the power source from LISN, and the high voltage side is connected directly to a 3.3V battery. The configuration for high voltage long is shown in [Option B in CISPR Test Set Up](#). The output is connected to the 1.5m wire, and a resistor is connected to the end of the wire. The input is connected through a short. For power, the high voltage side is connected to the power source from LISN, and the low voltage side is connected directly to a 3.3V battery.

There are four antennas used to create the CISPR 25 data: monopole for 150kHz to 30MHz, biconical antenna for 30MHz to 200MHz, log periodic antenna for 200MHz to 1GHz, and horn antenna for 1GHz - 3GHz. For the positioning, the monopole, biconical, and log periodic antenna are placed in [Position A in CISPR Test Set Up](#), which is 1m from the center of the table. For the monopole, a copper sheet is needed to connect the table to the antenna stand. The horn antenna is placed in [Position B in CISPR Test Set Up](#), which is 1m from the device.

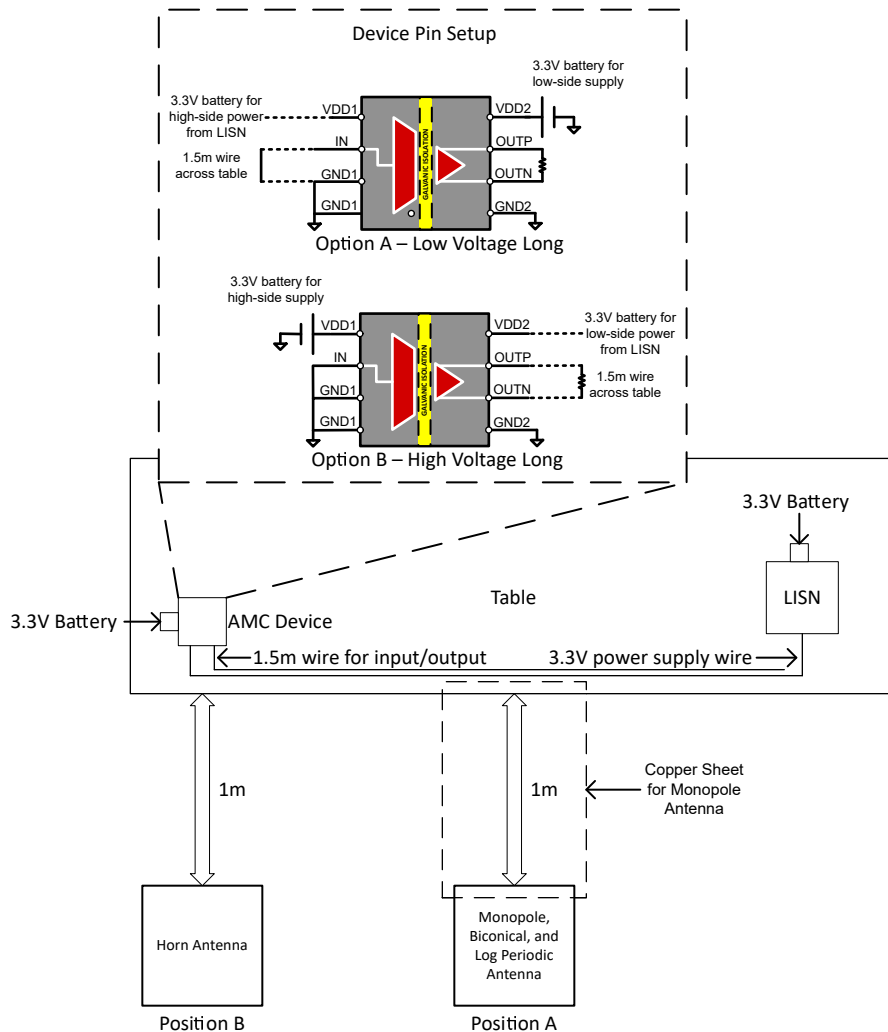

Figure 1-2. CISPR 25 Test Set Up

2 Current Generation of Texas Instruments Isolated Amplifiers Radiated Emissions Performance

The current isolated amplifiers from Texas Instruments incorporate several years of radiated emissions EMI performance advancements. In this generation, the devices has a single-die capacitor isolation and further improvement in the analog signal chain. The following images are the CISPR 25 results for the [AMC0311D-Q1](#), [AMC0300D](#), [AMC0381D-Q1](#), and [AMC1200C](#) when the high voltage side is long (connected to the 1.5m wire) and when the low voltage side is long.

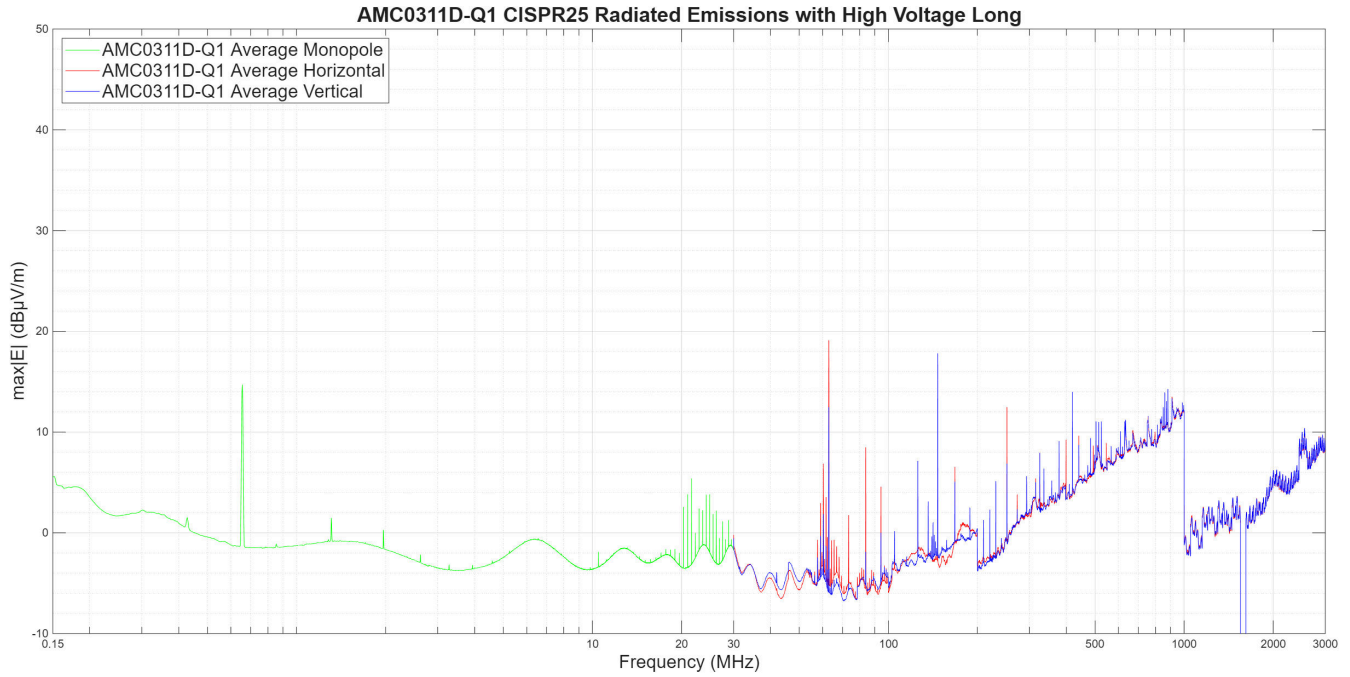

Figure 2-1. AMC0311D-Q1 CISPR 25 Radiated Emissions EMI High Voltage Long Scan

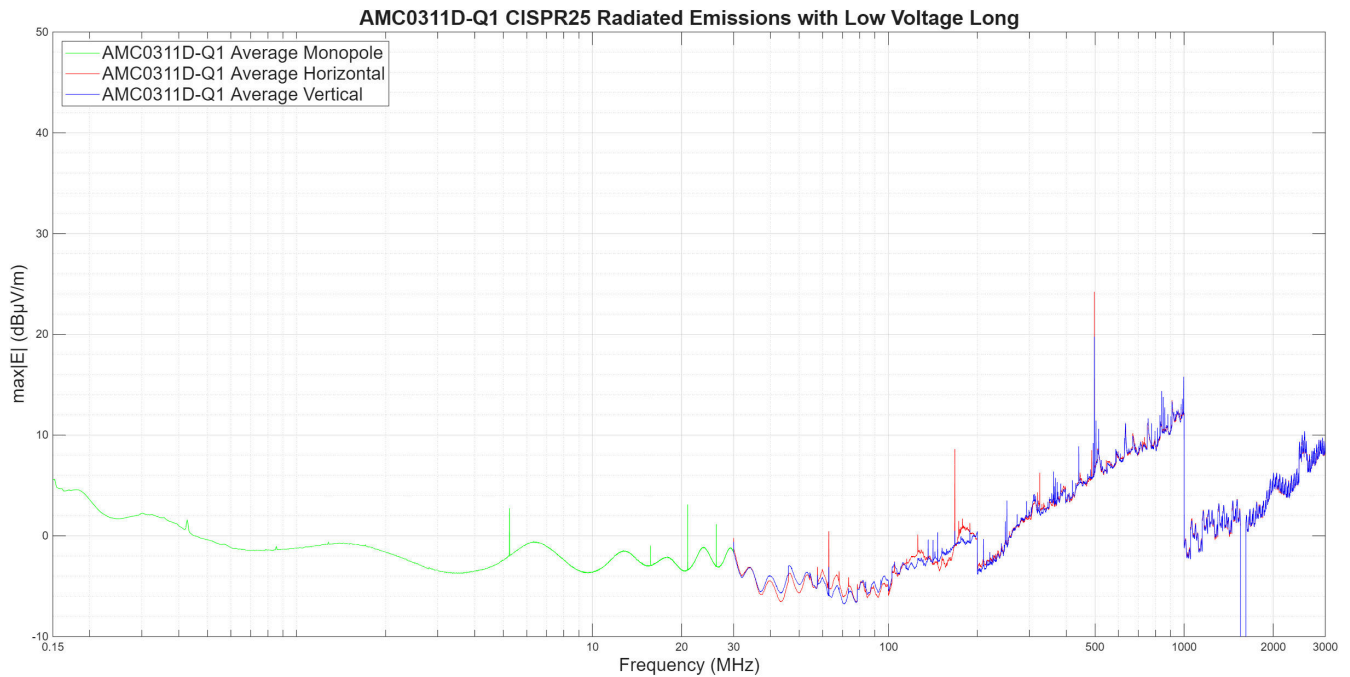

Figure 2-2. AMC0311D-Q1 CISPR 25 Radiated Emissions EMI Low Voltage Long Scan

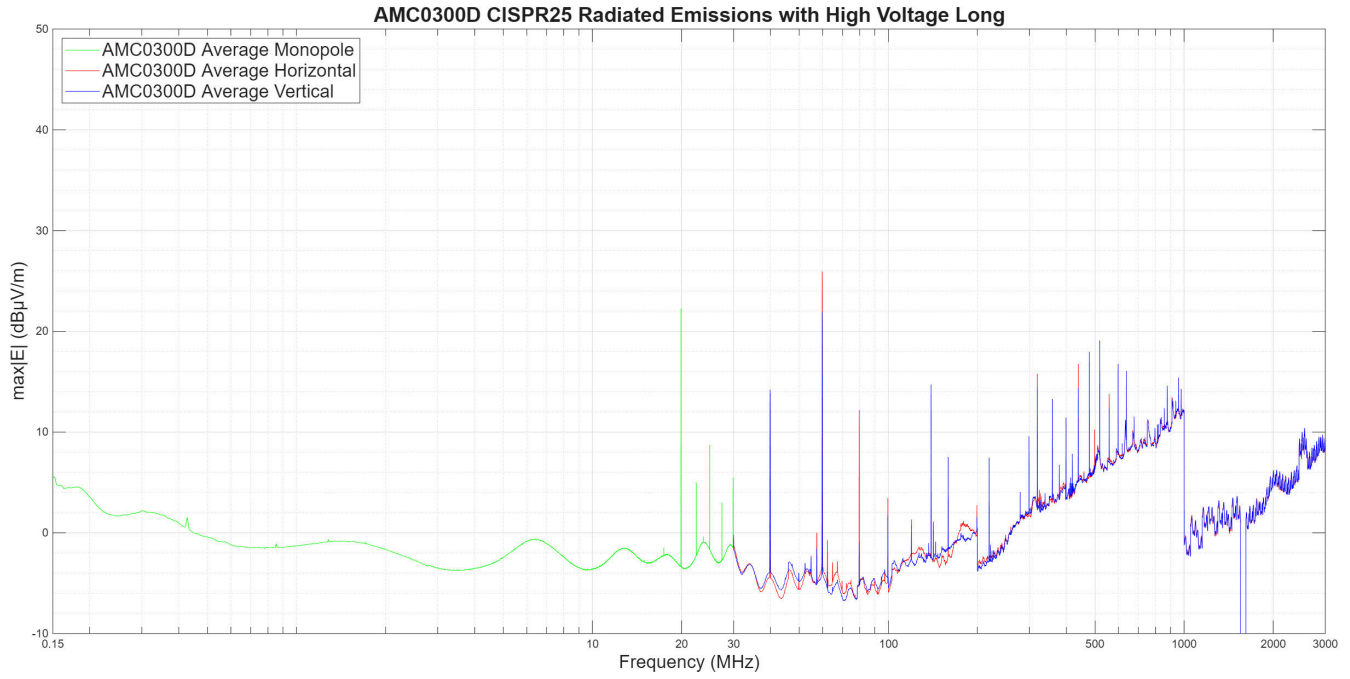

Figure 2-3. AMC0300D CISPR 25 Radiated Emissions EMI High Voltage Long Scan

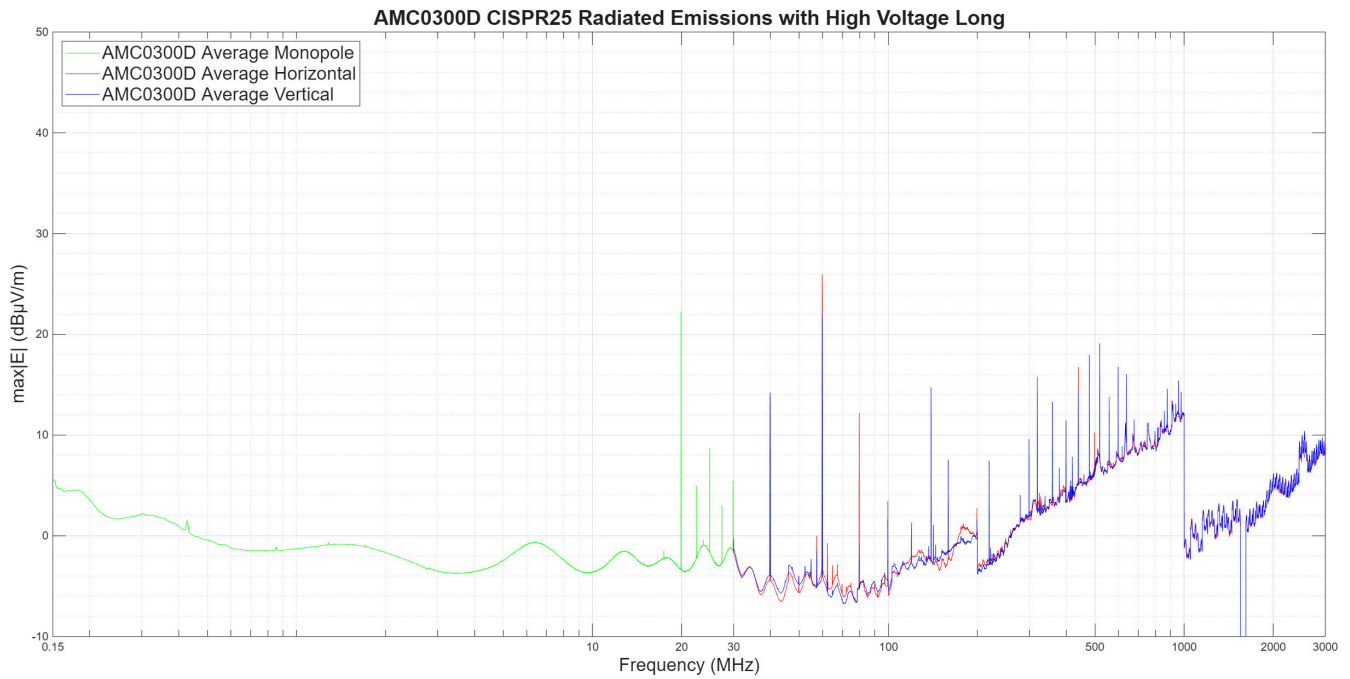

Figure 2-4. AMC0300D CISPR 25 Radiated Emissions EMI Low Voltage Long Scan

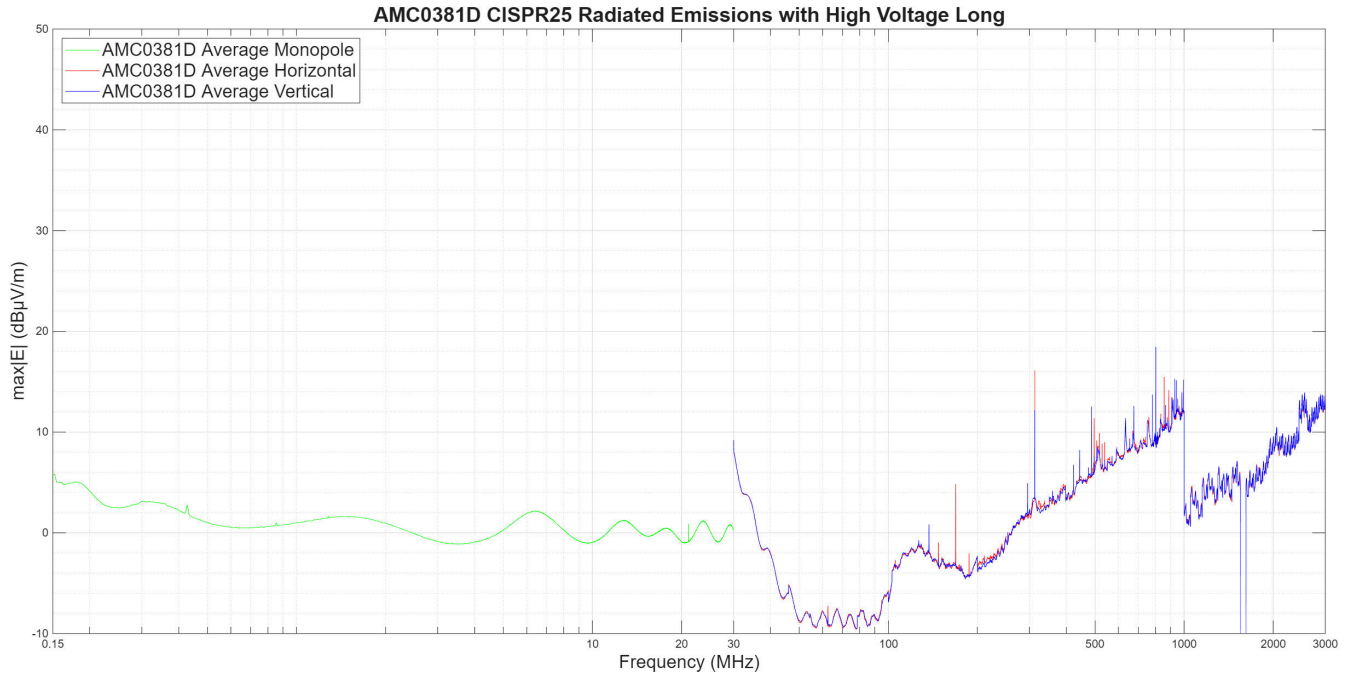

Figure 2-5. AMC0381D10-Q1 CISPR 25 Radiated Emissions EMI High Voltage Long Scan

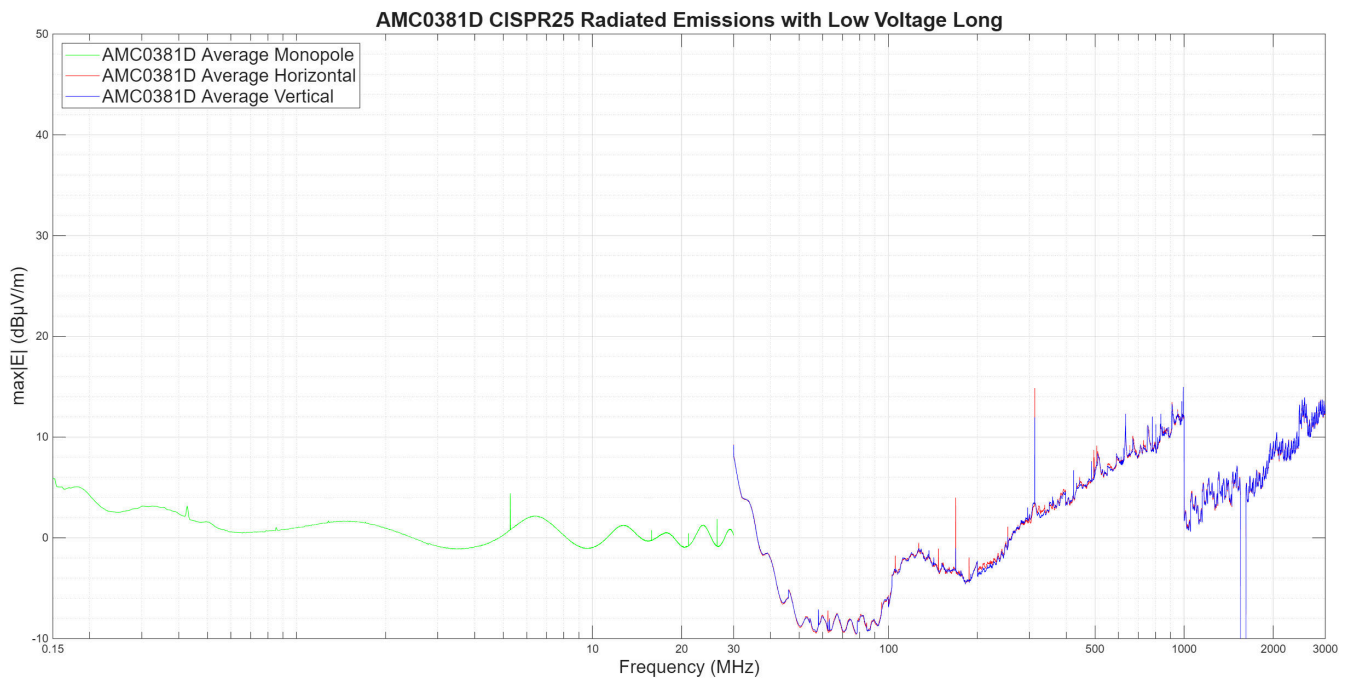

Figure 2-6. AMC0381D-Q1 CISPR 25 Radiated Emissions EMI Low Voltage Long Scan

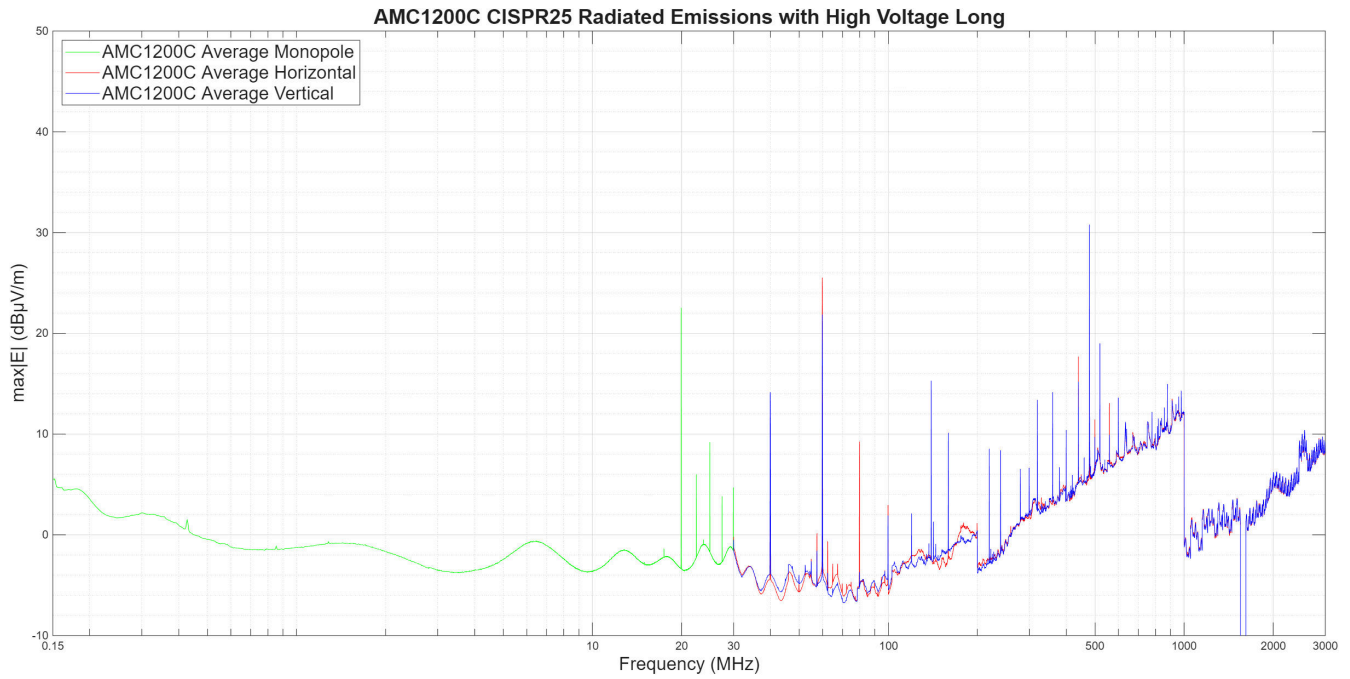

Figure 2-7. AMC1200C CISPR 25 Radiated Emissions EMI High Voltage Long Scan

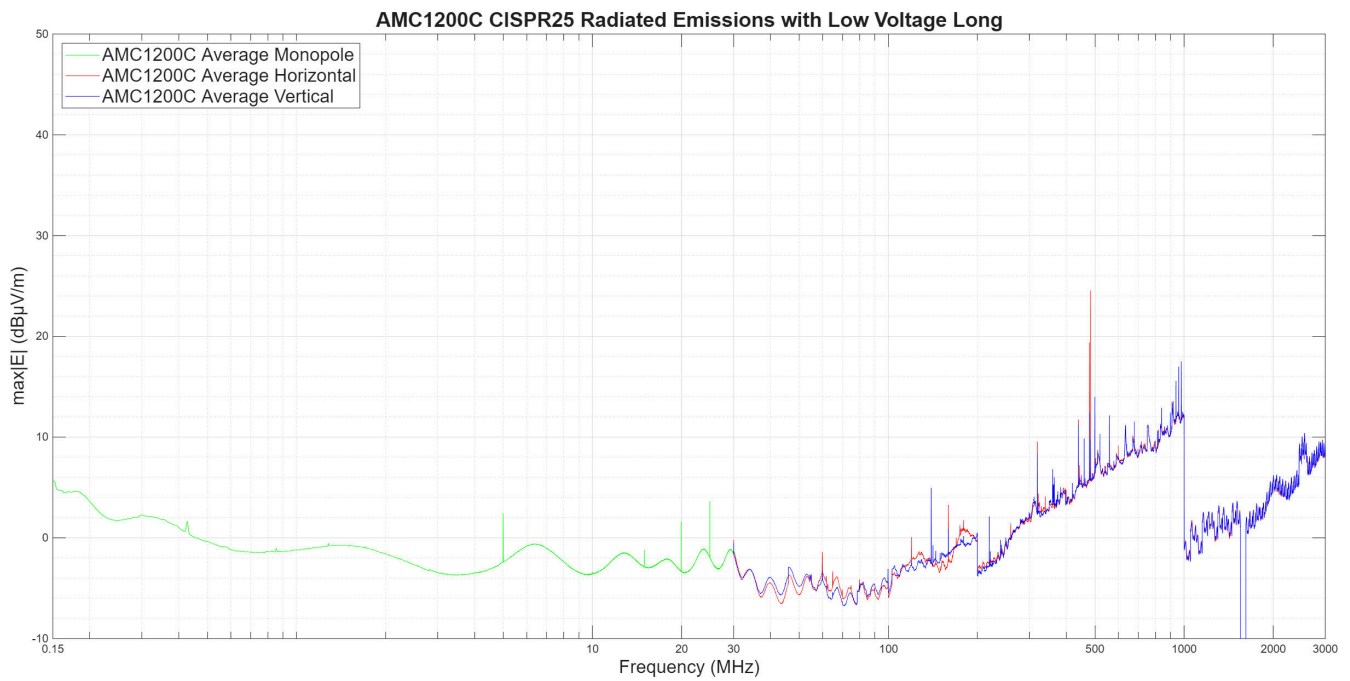

Figure 2-8. AMC1200C CISPR 25 Radiated Emissions EMI Low Voltage Long Scan

3 Previous Generations of Texas Instruments Isolated Amplifiers Radiated Emissions Performance

The previous generation of isolated amplifiers include a lot of improvements including an optimized analog signal chain, the amount of energy crossing over the isolation barrier was more closely managed, and OOK data transmission. The following images are the CISPR 25 results for the [AMC1200BDWV](#), [AMC1200DUB](#), [AMC1400](#), [AMC1300](#), [AMC3330](#), and [AMC131M03](#) when the high voltage side is long (connected to the 1.5m wire) and when the low voltage side is long.

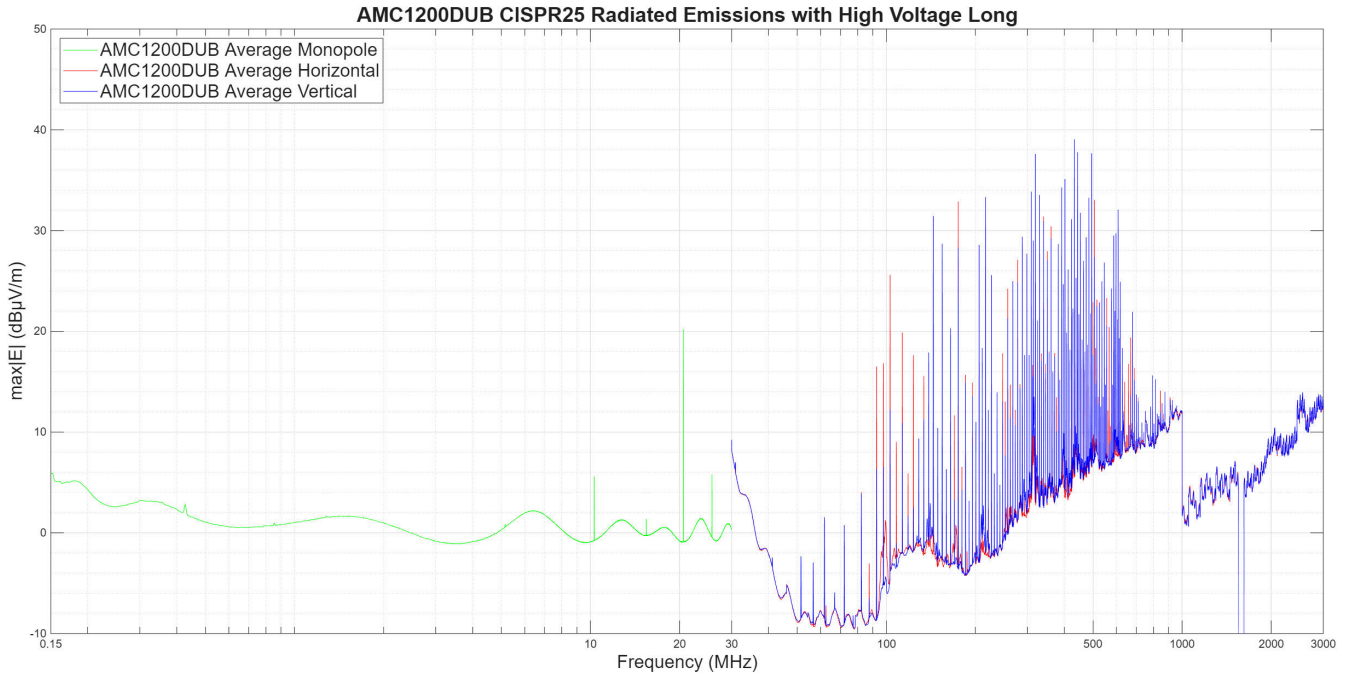

Figure 3-1. AMC1200DUB CISPR 25 Radiated Emissions EMI High Voltage Long Scan

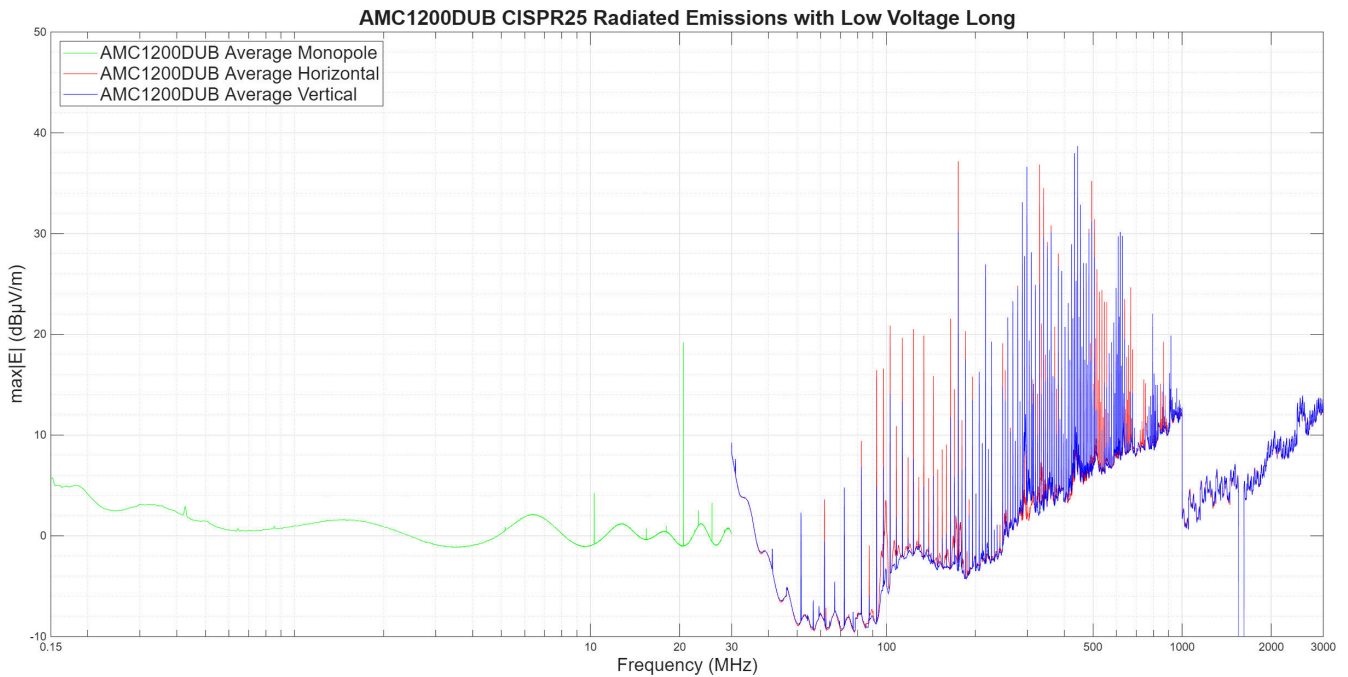

Figure 3-2. AMC1200DUB CISPR 25 Radiated Emissions EMI Low Voltage Long Scan

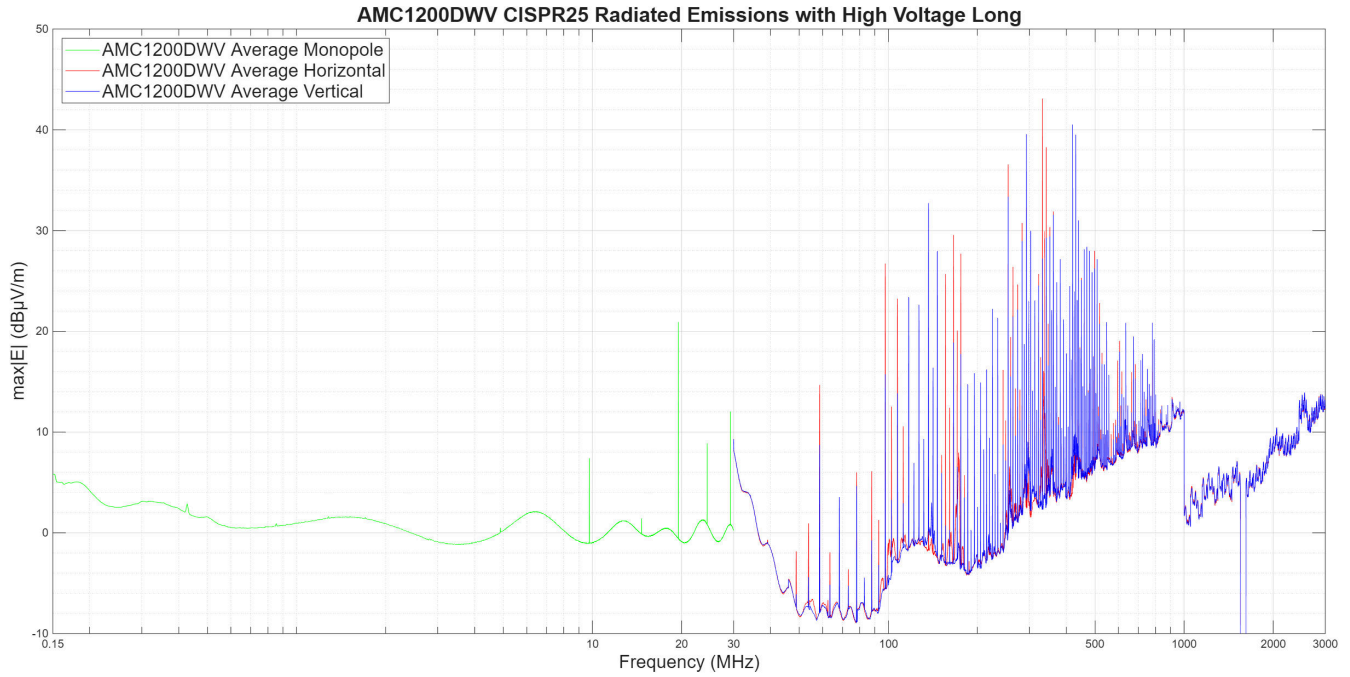

Figure 3-3. AMC1200DWV CISPR 25 Radiated Emissions EMI High Voltage Long Scan

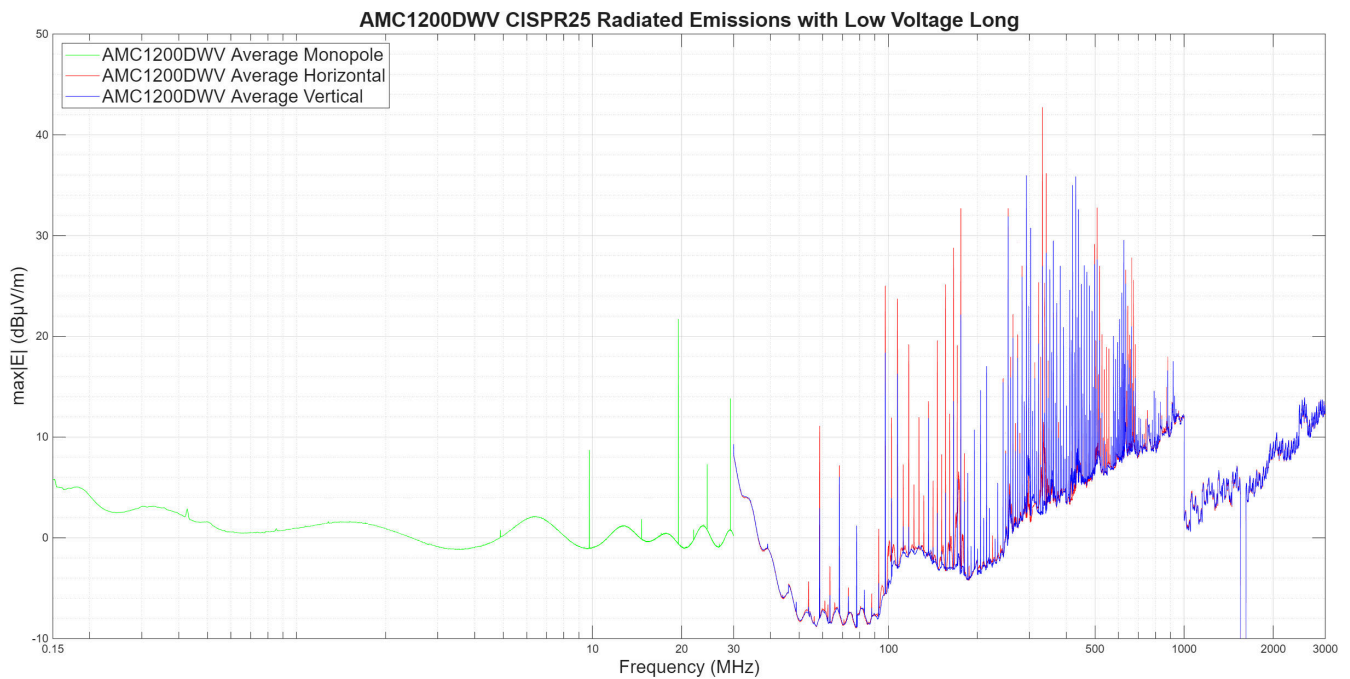

Figure 3-4. AMC1200DWV CISPR 25 Radiated Emissions EMI Low Voltage Long Scan

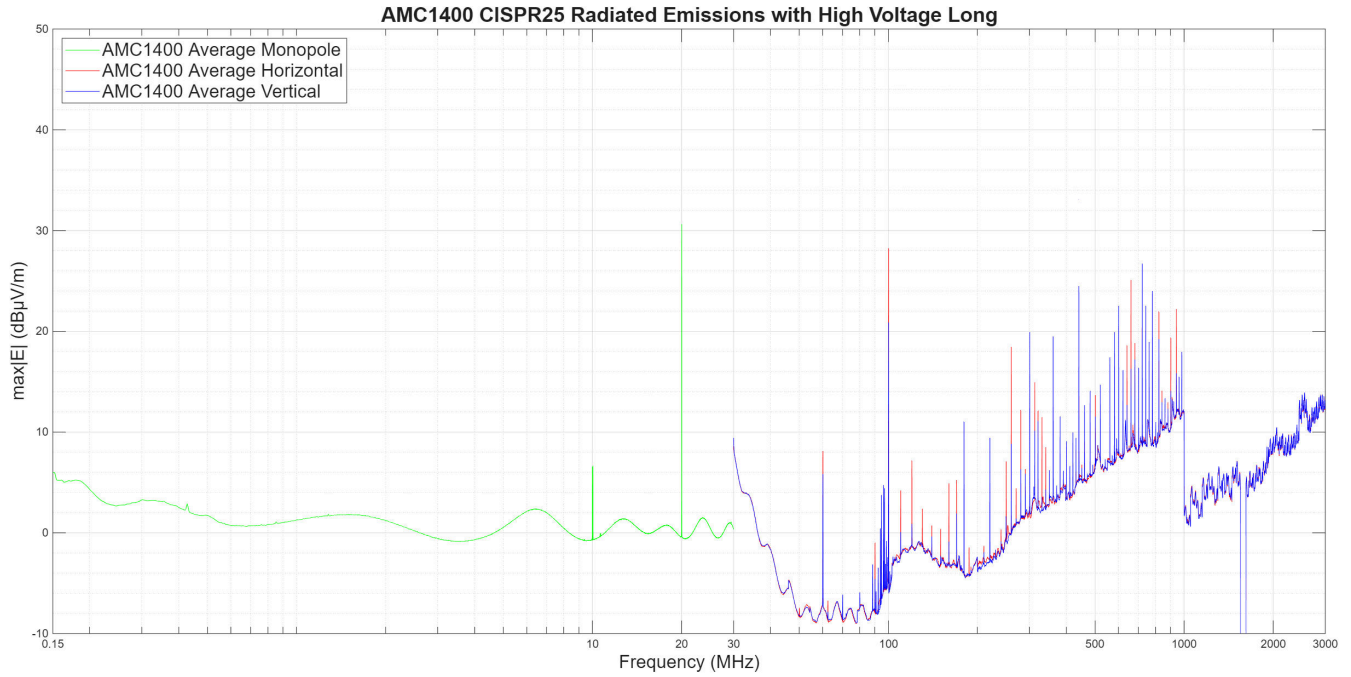

Figure 3-5. AMC1400 CISPR 25 Radiated Emissions EMI High Voltage Long Scan

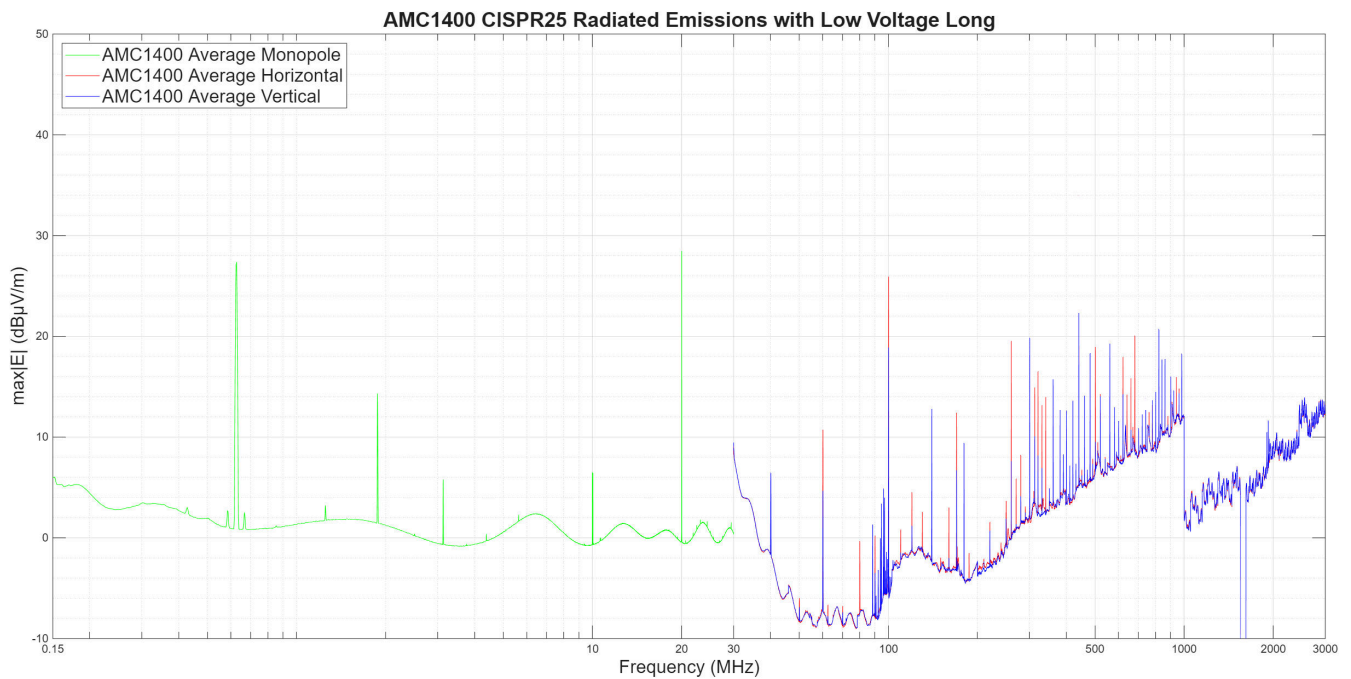

Figure 3-6. AMC1400 CISPR 25 Radiated Emissions EMI Low Voltage Long Scan

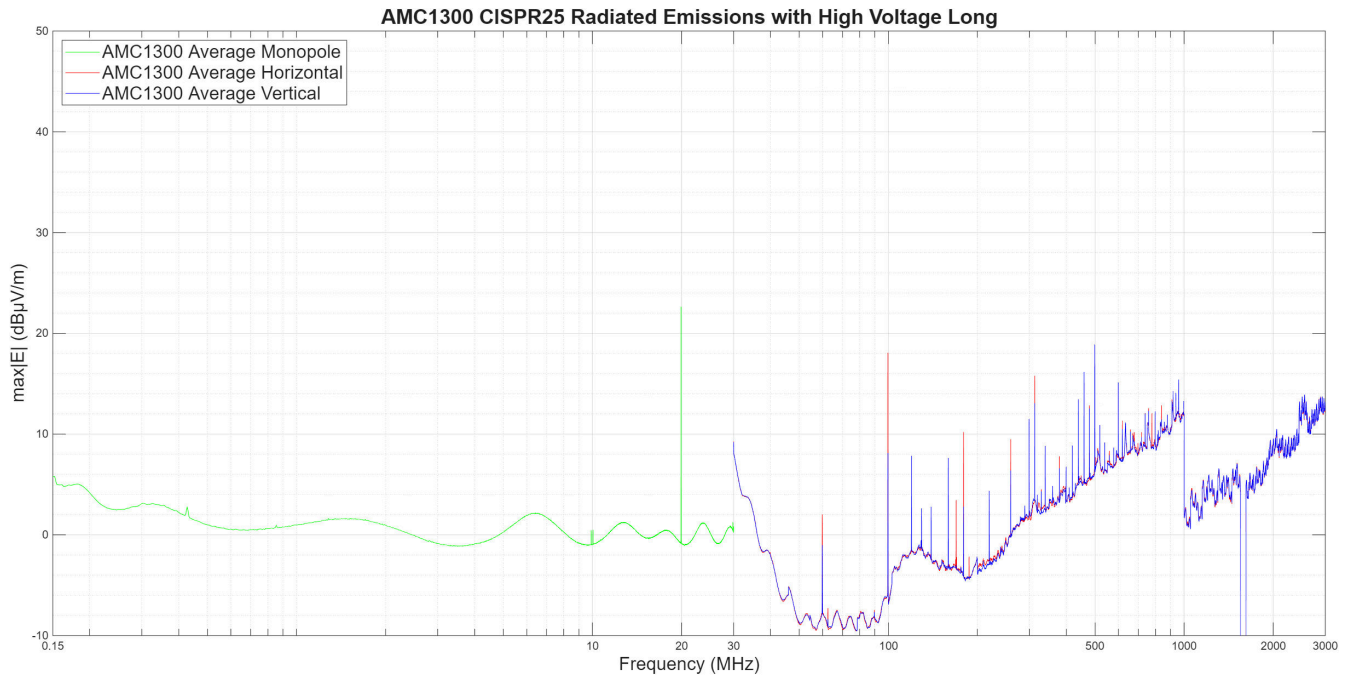

Figure 3-7. AMC1300 CISPR 25 Radiated Emissions EMI High Voltage Long Scan

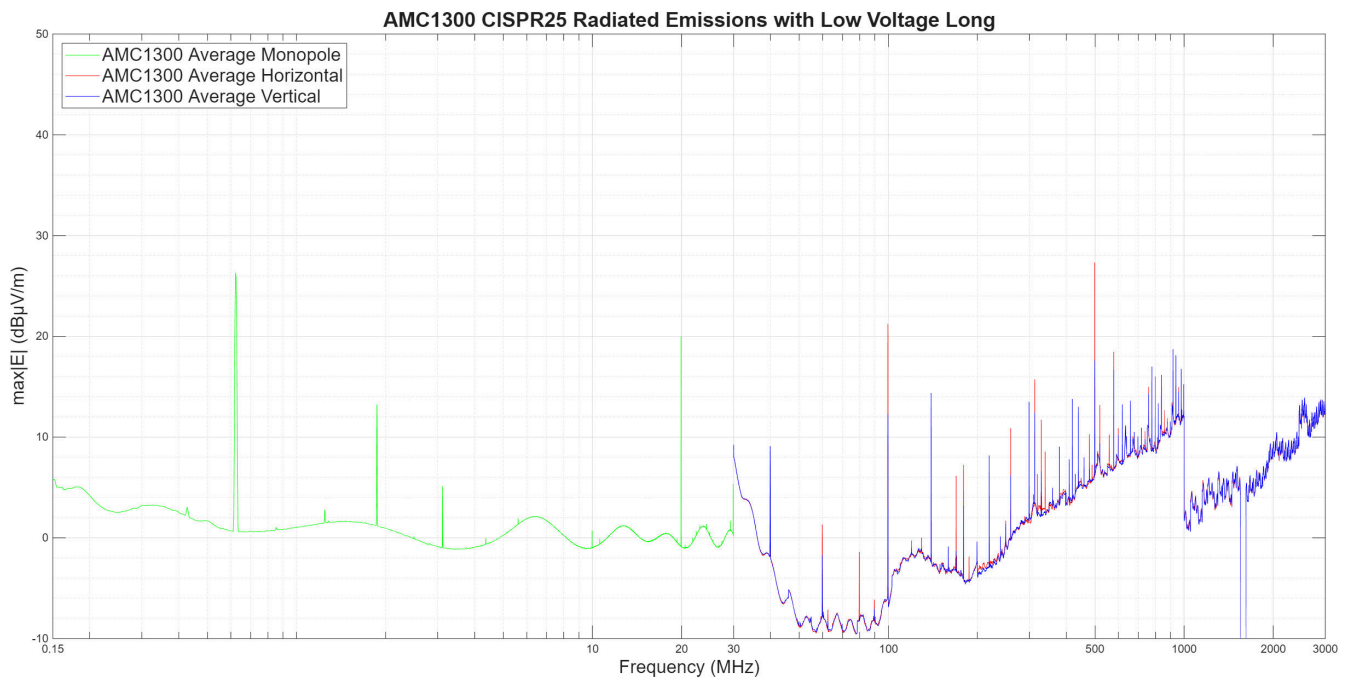

Figure 3-8. AMC1300 CISPR 25 Radiated Emissions EMI High Voltage Long Scan

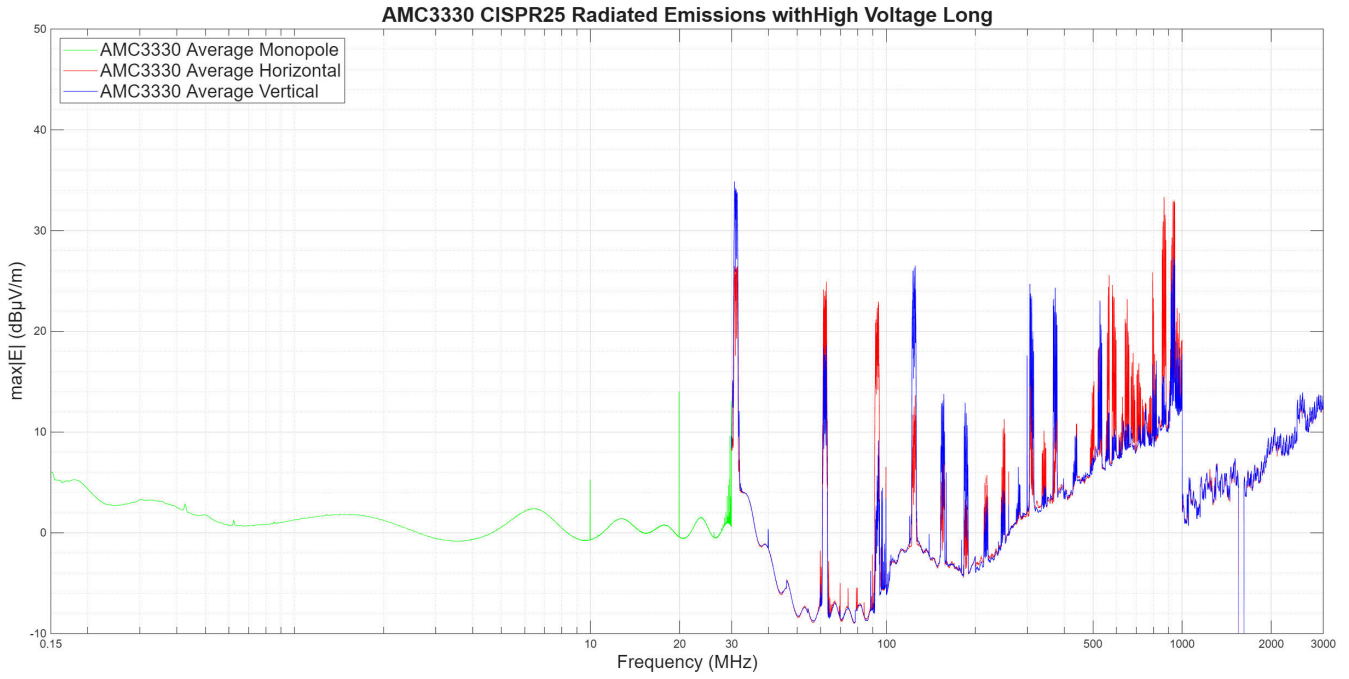

Figure 3-9. AMC3330 CISPR 25 Radiated Emissions EMI High Voltage Long Scan

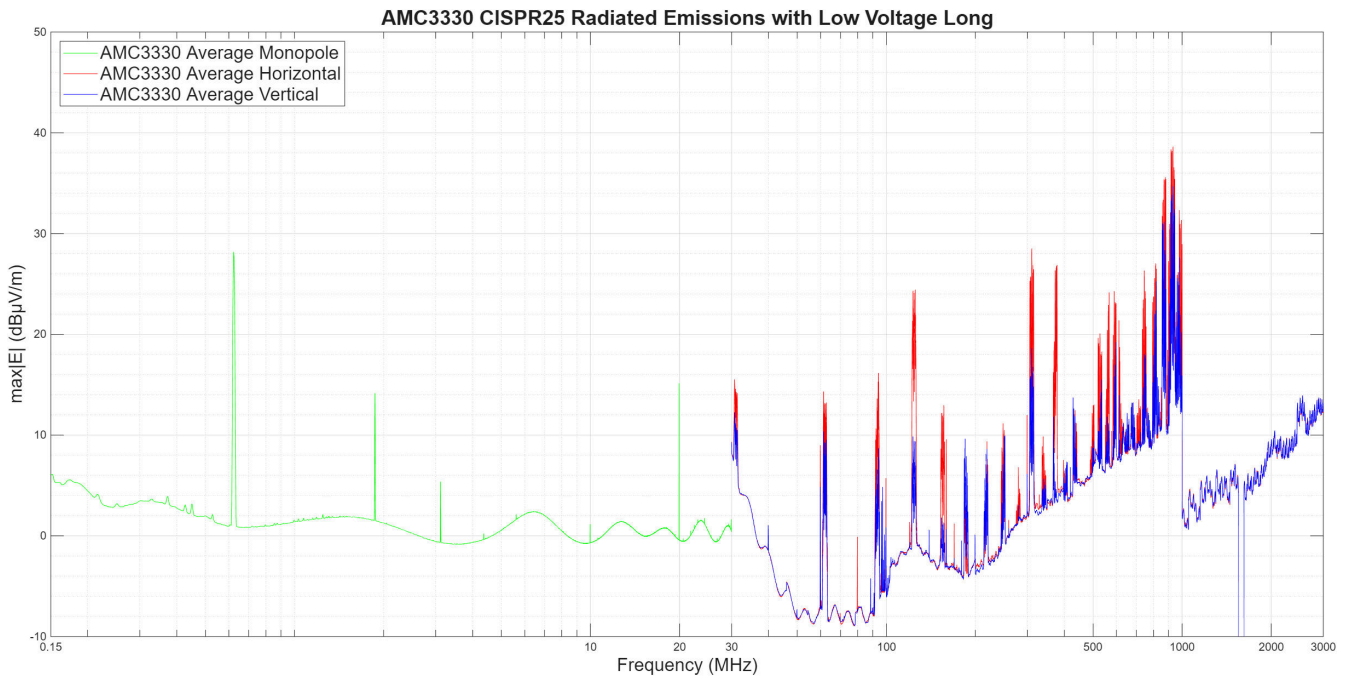

Figure 3-10. AMC3330 CISPR 25 Radiated Emissions EMI Low Voltage Long Scan

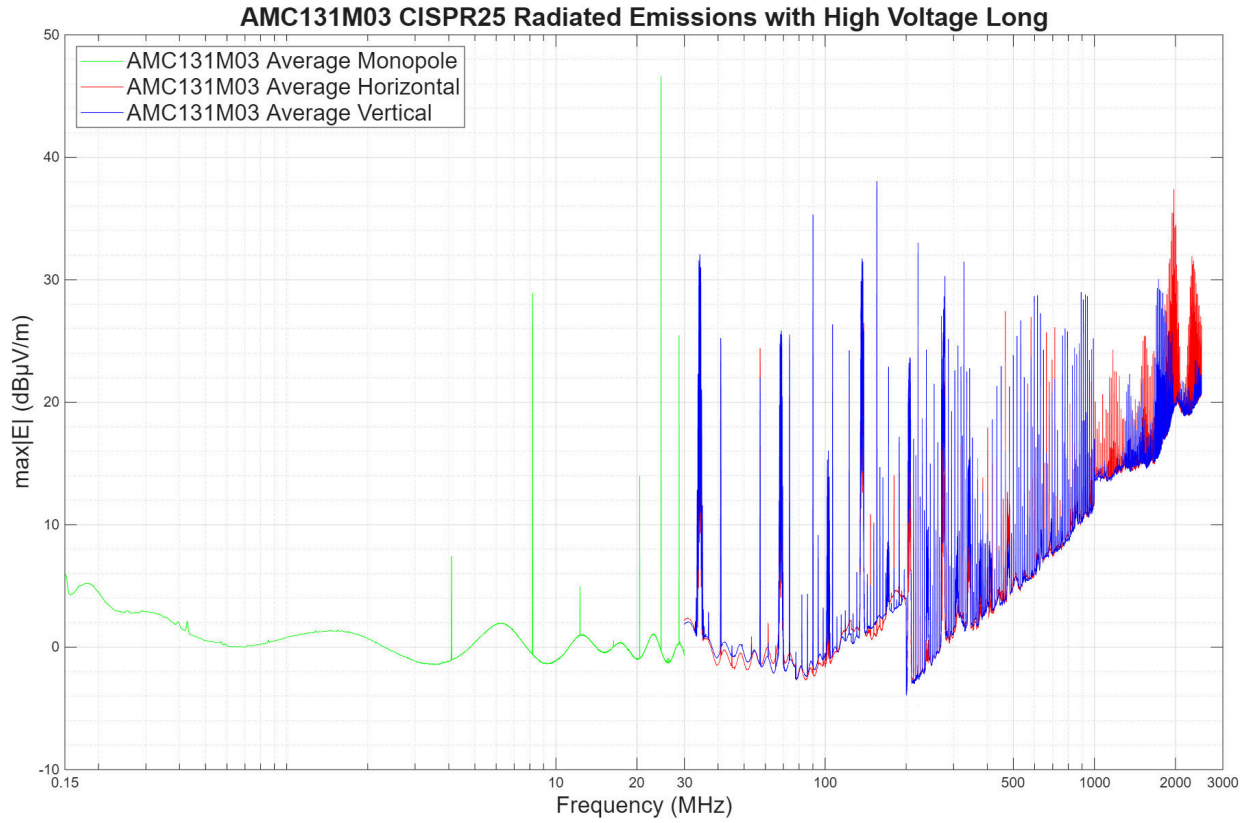

Figure 3-11. AMC131M03 CISPR 25 Radiated Emissions EMI High Voltage Long Scan

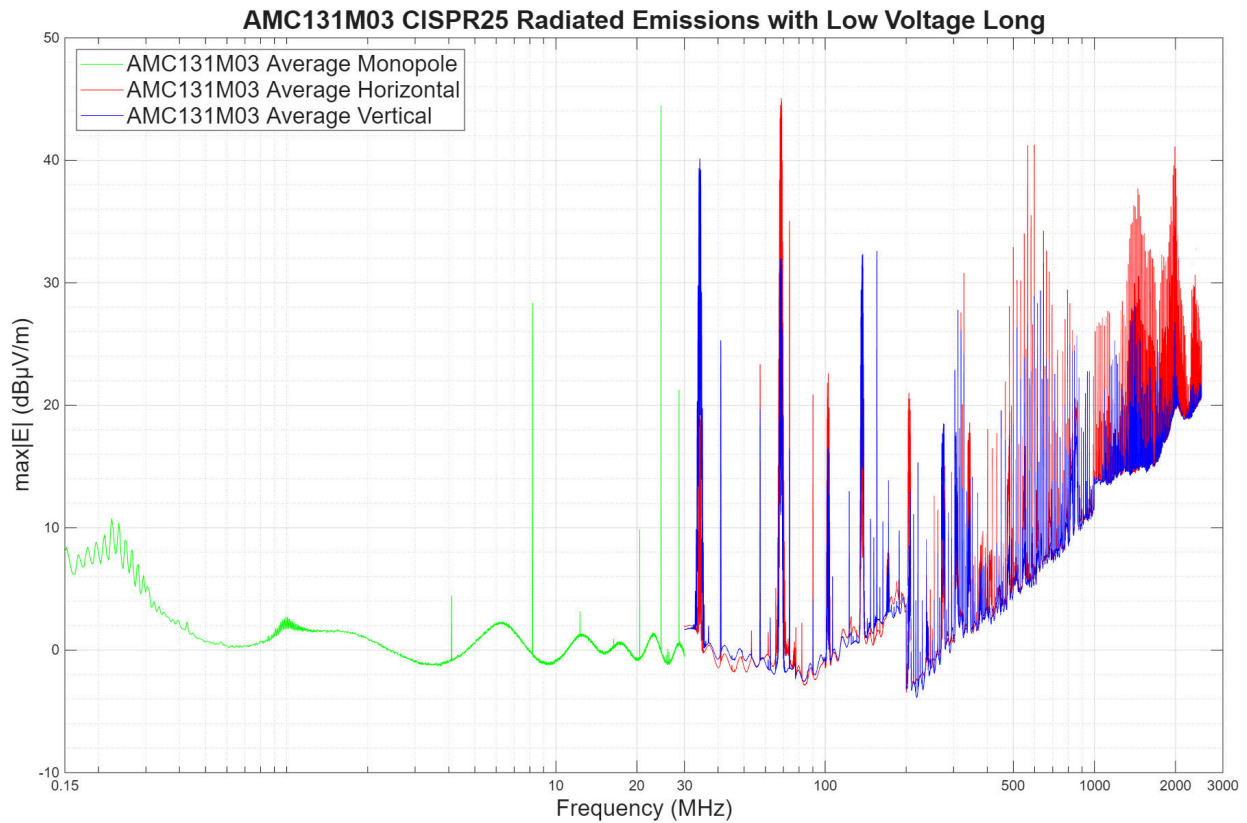

Figure 3-12. AMC131M03 CISPR 25 Radiated Emissions EMI Low Voltage Long Scan

4 Summary

Over the past several years, capacitive isolation has been a popular choice for many customers in need of [isolated amplifiers](#) and [data converters](#) due to the long term reliability and strong analog performance. When using the re-designed isolated amplifiers from Texas Instruments, including the [AMC0381D-Q1](#), [AMC0311D-Q1](#), [AMC1200C](#), and [AMC0300D](#), customers can confidently create designs featuring the high reliability and high analog performance that capacitive isolation brings, with best in class radiated emissions EMI performance.

5 References

- Texas Instruments, [Understanding Electromagnetic Compliance Tests in Digital Isolators](#), application note.
- Texas Instruments, [An Overview of Conducted EMI Specifications for Power Supplies](#), application note.
- Texas Instruments, [Best Practices to Attenuate AMC3301 Family Radiated Emissions EMI](#), application note.

IMPORTANT NOTICE AND DISCLAIMER

TI PROVIDES TECHNICAL AND RELIABILITY DATA (INCLUDING DATA SHEETS), DESIGN RESOURCES (INCLUDING REFERENCE DESIGNS), APPLICATION OR OTHER DESIGN ADVICE, WEB TOOLS, SAFETY INFORMATION, AND OTHER RESOURCES "AS IS" AND WITH ALL FAULTS, AND DISCLAIMS ALL WARRANTIES, EXPRESS AND IMPLIED, INCLUDING WITHOUT LIMITATION ANY IMPLIED WARRANTIES OF MERCHANTABILITY, FITNESS FOR A PARTICULAR PURPOSE OR NON-INFRINGEMENT OF THIRD PARTY INTELLECTUAL PROPERTY RIGHTS.

These resources are intended for skilled developers designing with TI products. You are solely responsible for (1) selecting the appropriate TI products for your application, (2) designing, validating and testing your application, and (3) ensuring your application meets applicable standards, and any other safety, security, regulatory or other requirements.

These resources are subject to change without notice. TI grants you permission to use these resources only for development of an application that uses the TI products described in the resource. Other reproduction and display of these resources is prohibited. No license is granted to any other TI intellectual property right or to any third party intellectual property right. TI disclaims responsibility for, and you will fully indemnify TI and its representatives against, any claims, damages, costs, losses, and liabilities arising out of your use of these resources.

TI's products are provided subject to [TI's Terms of Sale](#) or other applicable terms available either on [ti.com](https://www.ti.com) or provided in conjunction with such TI products. TI's provision of these resources does not expand or otherwise alter TI's applicable warranties or warranty disclaimers for TI products.

TI objects to and rejects any additional or different terms you may have proposed.

Mailing Address: Texas Instruments, Post Office Box 655303, Dallas, Texas 75265

Copyright © 2025, Texas Instruments Incorporated