

TLV320ADC6140 Quad-Channel, 768-kHz, Burr-Brown™ Audio ADC



1 Features

- Multichannel high-performance ADC:
 - 4-channel analog microphones or line-in,
 - 8-channel digital PDM microphones, or
 - Combination of analog and digital microphones
- ADC line and microphone differential input performance:
 - Dynamic range (DR):
 - 123-dB, dynamic range enhancer (DRE) enabled
 - 113-dB, DRE disabled
 - THD+N: –98 dB
- ADC channel summing mode, DR performance:
 - 116-dB, DRE disabled, 2-channel summing
 - 119-dB, DRE disabled, 4-channel summing
- ADC input voltage:
 - Differential, 2- V_{RMS} full-scale inputs
 - Single-ended, 1- V_{RMS} full-scale inputs
- ADC sample rate (f_s) = 8 kHz to 768 kHz
- Programmable channel settings:
 - Channel gain: 0 dB to 42 dB, 1-dB steps
 - Digital volume control: –100 dB to 27 dB
 - Gain calibration with 0.1-dB resolution
 - Phase calibration with 163-ns resolution
- Programmable microphone bias or supply voltage generation
- Low-latency signal processing filter selection
- Programmable HPF and biquad digital filters
- Automatic gain controller (AGC)
- I²C or SPI controls
- Integrated high-performance audio PLL
- Automatic clock divider setting configurations
- Audio serial data interface:
 - Format: TDM, I²S, or left-justified (LJ)
 - Word length: 16 bits, 20 bits, 24 bits, or 32 bits
 - Master or slave interface
- Single-supply operation: 3.3 V or 1.8 V
- I/O-supply operation: 3.3 V or 1.8 V
- Power consumption for 1.8-V AVDD supply:
 - 8.5 mW/channel at 16-kHz sample rate
 - 9.2 mW/channel at 48-kHz sample rate

2 Applications

- Microphone array systems
- Voice-activated digital assistants
- Teleconferencing systems
- Security and surveillance systems

3 Description

The TLV320ADC6140 is a Burr-Brown™ high-performance, audio analog-to-digital converter (ADC) that supports simultaneous sampling of up to four analog channels or eight digital channels for the pulse density modulation (PDM) microphone input. The device supports line and microphone inputs, and allows for both single-ended and differential input configurations. The device integrates programmable channel gain, digital volume control, a programmable microphone bias voltage, a phase-locked loop (PLL), a programmable high-pass filter (HPF), biquad filters, low-latency filter modes, and allows for sample rates up to 768 kHz. The device supports time-division multiplexing (TDM), I²S, or left-justified (LJ) audio formats, and can be controlled with either the I²C or SPI interface. These integrated high-performance features, along with the ability to be powered from a single-supply of 3.3 V or 1.8 V, make the device an excellent choice for space-constrained audio systems in far-field microphone recording applications.

The TLV320ADC6140 is specified from –40°C to +125°C, and is offered in a 24-pin WQFN package.

Device Information⁽¹⁾

PART NUMBER	PACKAGE	BODY SIZE (NOM)
TLV320ADC6140	WQFN (24)	4.00 mm × 4.00 mm with 0.5-mm pitch

(1) For all available packages, see the package option addendum at the end of the data sheet.

Simplified Block Diagram

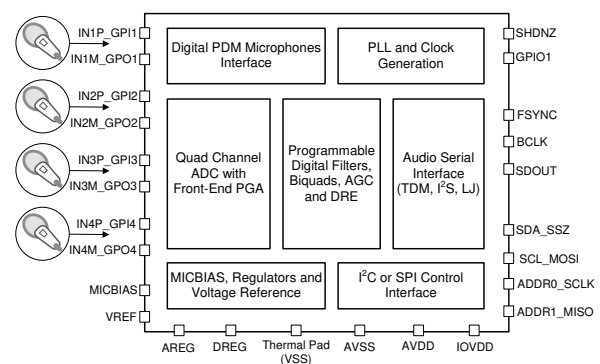

Table of Contents

1 Features	1	8.1 Overview	18
2 Applications	1	8.2 Functional Block Diagram	19
3 Description	1	8.3 Feature Description	19
4 Revision History	2	8.4 Device Functional Modes	56
5 Device Comparison Table	3	8.5 Programming	57
6 Pin Configuration and Functions	4	8.6 Register Maps	61
7 Specifications	6	9 Application and Implementation	108
7.1 Absolute Maximum Ratings	6	9.1 Application Information	108
7.2 ESD Ratings	6	9.2 Typical Applications	108
7.3 Recommended Operating Conditions	6	9.3 What to Do and What Not to Do	115
7.4 Thermal Information	7	10 Power Supply Recommendations	115
7.5 Electrical Characteristics	7	11 Layout	116
7.6 Timing Requirements: I ² C Interface	11	11.1 Layout Guidelines	116
7.7 Switching Characteristics: I ² C Interface	11	11.2 Layout Example	116
7.8 Timing Requirements: SPI Interface	12	12 Device and Documentation Support	117
7.9 Switching Characteristics: SPI Interface	12	12.1 Documentation Support	117
7.10 Timing Requirements: TDM, I ² S or LJ Interface ...	12	12.2 Receiving Notification of Documentation Updates	117
7.11 Switching Characteristics: TDM, I ² S or LJ Interface	12	12.3 Community Resources	117
7.12 Timing Requirements: PDM Digital Microphone Interface	13	12.4 Trademarks	117
7.13 Switching Characteristics: PDM Digital Microphone Interface	13	12.5 Electrostatic Discharge Caution	117
7.14 Typical Characteristics	15	12.6 Glossary	117
8 Detailed Description	18	13 Mechanical, Packaging, and Orderable Information	118

4 Revision History

NOTE: Page numbers for previous revisions may differ from page numbers in the current version.

Changes from Original (July 2019) to Revision A	Page
• Changed document status from advance information to production data	1

5 Device Comparison Table

FEATURES	TLV320ADC3140	TLV320ADC5140	TLV320ADC6140
Control interface	I ² C or SPI		
Digital audio serial interface	TDM, I ² S, or left-justified (LJ)		
Audio analog channel	4	4	4
Digital PDM channel	8	8	8
Dynamic range enhancer (DRE)	Not available	Available	Available
Dynamic range (DRE disabled)	106 dB	108 dB	113 dB
Dynamic range (DRE enabled)	Not available	120 dB	123 dB
Compatibility	Pin-to-pin, package, and control registers compatible; drop-in replacements of each other		
Package	WQFN (RTW), 24-pin, 4.00 mm x 4.00 mm (0.5-mm pitch)		

6 Pin Configuration and Functions

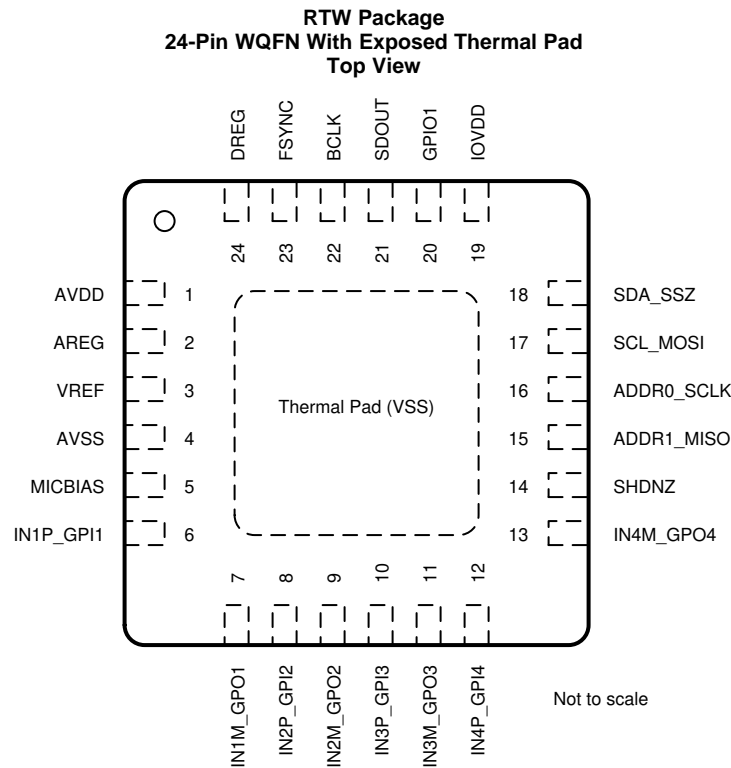

Pin Functions

PIN		TYPE	DESCRIPTION
NO.	NAME		
1	AVDD	Analog supply	Analog power (1.8 V or 3.3 V, nominal)
2	AREG	Analog supply	Analog on-chip regulator output voltage for analog supply (1.8 V, nominal) or external analog power (1.8 V, nominal)
3	VREF	Analog	Analog reference voltage filter output
4	AVSS	Analog supply	Analog ground. Short this pin directly to the board ground plane.
5	MICBIAS	Analog	MICBIAS output
6	IN1P_GPI1	Analog input/digital input	Analog input 1P pin or general-purpose digital input 1 (multipurpose functions such as digital microphone data, PLL input clock source, and so forth)
7	IN1M_GPO1	Analog input/digital output	Analog input 1M pin or general-purpose digital output 1 (multipurpose functions such as digital microphone clock, interrupt, and so forth)
8	IN2P_GPI2	Analog input/digital input	Analog input 2P pin or general-purpose digital input 2 (multipurpose functions such as digital microphones data, PLL input clock source, and so forth)
9	IN2M_GPO2	Analog input/digital output	Analog input 2M pin or general-purpose digital output 2 (multipurpose functions such as digital microphone clock, interrupt, and so forth)
10	IN3P_GPI3	Analog input/digital input	Analog input 3P pin or general-purpose digital input 3 (multipurpose functions such as digital microphones data, PLL input clock source, and so forth)
11	IN3M_GPO3	Analog input/digital output	Analog input 3M pin or general-purpose digital output 3 (multipurpose functions such as digital microphone clock, interrupt, and so forth)
12	IN4P_GPI4	Analog input/digital input	Analog input 4P pin or general-purpose digital input 4 (multipurpose functions such as digital microphones data, PLL input clock source, and so forth)
13	IN4M_GPO4	Analog input/digital output	Analog input 4M pin or general-purpose digital output 4 (multipurpose functions such as digital microphone clock, interrupt, and so forth)
14	SHDNZ	Digital input	Device hardware shutdown and reset (active low)
15	ADDR1_MISO	Digital I/O	For I ² C operation: I ² C slave address A1 pin For SPI operation: SPI slave output pin

Pin Functions (continued)

PIN		TYPE	DESCRIPTION
NO.	NAME		
16	ADDR0_SCLK	Digital input	For I ² C operation: I ² C slave address A0 pin For SPI operation : SPI serial bit clock
17	SCL_MOSI	Digital input	For I ² C operation: clock pin for I ² C control bus For SPI operation: SPI slave input pin
18	SDA_SSZ	Digital I/O	For I ² C operation: data pin for I ² C control bus For SPI operation: SPI slave-select pin
19	IOVDD	Digital supply	Digital I/O power supply (1.8 V or 3.3 V, nominal)
20	GPIO1	Digital I/O	General-purpose digital input/output 1 (multipurpose functions such as digital microphones clock or data, PLL input clock source, interrupt, and so forth)
21	SDOUT	Digital output	Audio serial data interface bus output
22	BCLK	Digital I/O	Audio serial data interface bus bit clock
23	FSYNC	Digital I/O	Audio serial data interface bus frame synchronization signal
24	DREG	Digital supply	Digital regulator output voltage for digital core supply (1.5 V, nominal)
Thermal Pad	Thermal Pad (VSS)	Ground supply	Thermal pad shorted to internal device ground. Short the thermal pad directly to the board ground plane.

7 Specifications

7.1 Absolute Maximum Ratings

over the operating ambient temperature range (unless otherwise noted)⁽¹⁾

		MIN	MAX	UNIT
Supply voltage	AVDD to AVSS	-0.3	3.9	V
	AREG to AVSS	-0.3	2.0	
	IOVDD to VSS (thermal pad)	-0.3	3.9	
Ground voltage differences	AVSS to VSS (thermal pad)	-0.3	0.3	V
Analog input voltage	Analog input pins voltage to AVSS	-0.3	AVDD + 0.3	V
Digital input voltage	Digital input except INxP_GPIx pins voltage to VSS (thermal pad)	-0.3	IOVDD + 0.3	V
	Digital input INxP_GPIx pins voltage to VSS (thermal pad)	-0.3	AVDD + 0.3	
Temperature	Operating ambient, T _A	-40	125	°C
	Junction, T _J	-40	150	
	Storage, T _{stg}	-65	150	

(1) Stresses beyond those listed under *Absolute Maximum Ratings* may cause permanent damage to the device. These are stress ratings only, which do not imply functional operation of the device at these or any other conditions beyond those indicated under *Recommended Operating Conditions*. Exposure to absolute-maximum-rated conditions for extended periods may affect device reliability.

7.2 ESD Ratings

			VALUE	UNIT
V _(ESD)	Electrostatic discharge	Human-body model (HBM), per ANSI/ESDA/JEDEC JS-001 ⁽¹⁾	±2000	V
		Charged-device model (CDM), per JEDEC specification JESD22-C101 ⁽²⁾	±500	

(1) JEDEC document JEP155 states that 500-V HBM allows safe manufacturing with a standard ESD control process.

(2) JEDEC document JEP157 states that 250-V CDM allows safe manufacturing with a standard ESD control process.

7.3 Recommended Operating Conditions

		MIN	NOM	MAX	UNIT
POWER					
AVDD, AREG ⁽¹⁾	Analog supply voltage AVDD to AVSS (AREG is generated using onchip regulator) - AVDD 3.3-V operation	3.0	3.3	3.6	V
	Analog supply voltage AVDD and AREG to AVSS (AREG internal regulator is shutdown) - AVDD 1.8-V operation	1.7	1.8	1.9	
IOVDD	IO supply voltage to VSS (thermal pad) - IOVDD 3.3-V operation	3.0	3.3	3.6	V
	IO supply voltage to VSS (thermal pad) - IOVDD 1.8-V operation	1.65	1.8	1.95	
INPUTS					
	Analog input pins voltage to AVSS	0		AVDD	V
	Digital input except INxP_GPIx pins voltage to VSS (thermal pad)	0		IOVDD	V
	Digital input INxP_GPIx pins voltage to VSS (thermal pad)	0		AVDD	V
TEMPERATURE					
T _A	Operating ambient temperature	-40		125	°C
OTHERS					
	GPIOx or GPIx (used as MCLK input) clock frequency			36.864	MHz
C _b	SCL and SDA bus capacitance for I ² C interface supports standard-mode and fast-mode			400	pF
	SCL and SDA bus capacitance for I ² C interface supports fast-mode plus			550	
C _L	Digital output load capacitance		20	50	pF

(1) AVSS and VSS (thermal pad): all ground pins must be tied together and must not differ in voltage by more than 0.2 V.

7.4 Thermal Information

THERMAL METRIC ⁽¹⁾		TLV320ADCx140	UNIT
		RTW (WQFN)	
		24 PINS	
R _{θJA}	Junction-to-ambient thermal resistance	32.6	°C/W
R _{θJC(top)}	Junction-to-case (top) thermal resistance	25.0	°C/W
R _{θJB}	Junction-to-board thermal resistance	11.9	°C/W
ψ _{JT}	Junction-to-top characterization parameter	0.2	°C/W
ψ _{JB}	Junction-to-board characterization parameter	11.9	°C/W
R _{θJC(bot)}	Junction-to-case (bottom) thermal resistance	2.9	°C/W

- (1) For more information about traditional and new thermal metrics, see the [Semiconductor and IC Package Thermal Metrics](#) application report.

7.5 Electrical Characteristics

at T_A = 25°C, AVDD = 3.3 V, IOVDD = 3.3 V, f_{IN} = 1-kHz sinusoidal signal, f_S = 48 kHz, 32-bit audio data, BCLK = 256 × f_S, TDM slave mode, PLL on (unless otherwise noted)

PARAMETER	TEST CONDITIONS	MIN	TYP	MAX	UNIT
ADC CONFIGURATION					
AC input impedance	Input pins INxP or INxM, 2.5-kΩ input impedance selection		2.5		kΩ
	Input pins INxP or INxM, 10-kΩ input impedance selection		10		
	Input pins INxP or INxM, 20-kΩ input impedance selection		20		
Channel gain range	Programmable range with 1-dB steps	0		42	dB
ADC PERFORMANCE FOR LINE/MICROPHONE INPUT RECORDING : AVDD 3.3-V OPERATION					
	Differential input full-scale AC signal voltage	AC-coupled input		2	V _{RMS}
	Single-ended input full-scale AC signal voltage	AC-coupled input		1	V _{RMS}
SNR	Signal-to-noise ratio, A-weighted ⁽¹⁾⁽²⁾	IN1 differential input selected and AC signal shorted to ground, DRE enabled (DRE_LVL = -36 dB, DRE_MAXGAIN = 24 dB), 2.5-kΩ input impedance selection	115	122	dB
		IN1 differential input selected and AC signal shorted to ground, DRE enabled (DRE_LVL = -36 dB, DRE_MAXGAIN = 24 dB), 10-kΩ input impedance selection		117	
		IN1 differential input selected and AC signal shorted to ground, DRE disabled, 2.5-kΩ input impedance selection, 0-dB channel gain	106	112	
		IN1 differential input selected and AC signal shorted to ground, DRE disabled, 2.5-kΩ input impedance selection, 12-dB channel gain		108	
DR	Dynamic range, A-weighted ⁽²⁾	IN1 differential input selected and -60-dB full-scale AC signal input, DRE enabled (DRE_LVL = -36 dB, DRE_MAXGAIN = 24 dB), 2.5-kΩ input impedance selection		123	dB
		IN1 differential input selected and -60-dB full-scale AC signal input, DRE enabled (DRE_LVL = -36 dB, DRE_MAXGAIN = 24 dB), 10-kΩ input impedance selection		118	
		IN1 differential input selected and -60-dB full-scale AC signal input, DRE disabled, 2.5-kΩ input impedance selection, 0-dB channel gain		113	
		IN1 differential input selected and -72-dB full-scale AC signal input, DRE disabled, 2.5-kΩ input impedance selection, 12-dB channel gain		108	

- (1) Ratio of output level with 1-kHz full-scale sine-wave input, to the output level with the AC signal input shorted to ground, measured A-weighted over a 20-Hz to 20-kHz bandwidth using an audio analyzer.
- (2) All performance measurements done with 20-kHz low-pass filter and, where noted, A-weighted filter. Failure to use such a filter may result in higher THD and lower SNR and dynamic range readings than shown in the Electrical Characteristics. The low-pass filter removes out-of-band noise, which, although not audible, may affect dynamic specification values.

Electrical Characteristics (continued)

at $T_A = 25^\circ\text{C}$, $AVDD = 3.3\text{ V}$, $IOVDD = 3.3\text{ V}$, $f_{IN} = 1\text{-kHz}$ sinusoidal signal, $f_S = 48\text{ kHz}$, 32-bit audio data, $BCLK = 256 \times f_S$, TDM slave mode, PLL on (unless otherwise noted)

PARAMETER		TEST CONDITIONS	MIN	TYP	MAX	UNIT
THD+N	Total harmonic distortion ⁽²⁾⁽³⁾	IN1 differential input selected and –1-dB full-scale AC signal input, DRE enabled (DRE_LVL = –36 dB, DRE_MAXGAIN = 24 dB), 2.5-k Ω input impedance selection		–98	–80	dB
		IN1 differential input selected and –1-dB full-scale AC signal input, DRE enabled (DRE_LVL = –36 dB, DRE_MAXGAIN = 24 dB), 10-k Ω input impedance selection		–98		
		IN1 differential input selected and –1-dB full-scale AC signal input, DRE disabled, 2.5-k Ω input impedance selection, 0-dB channel gain		–98		
		IN1 differential input selected and –13-dB full-scale AC signal input, DRE disabled, 2.5-k Ω input impedance selection, 12-dB channel gain		–98		
ADC PERFORMANCE FOR LINE/MICROPHONE INPUT RECORDING : AVDD 1.8-V OPERATION						
	Differential input full-scale AC signal voltage	AC-coupled Input		1		V_{RMS}
	Single-ended input full-scale AC signal voltage	AC-coupled Input		0.5		V_{RMS}
SNR	Signal-to-noise ratio, A-weighted ⁽¹⁾⁽²⁾	IN1 differential input selected and AC signal shorted to ground, DRE enabled (DRE_LVL = –36 dB, DRE_MAXGAIN = 24 dB), 2.5-k Ω input impedance selection		116		dB
		IN1 differential input selected and AC signal shorted to ground, DRE enabled (DRE_LVL = –36 dB, DRE_MAXGAIN = 24 dB), 10-k Ω input impedance selection		111		
		IN1 differential input selected and AC signal shorted to ground, DRE disabled, 2.5-k Ω input impedance selection, 0-dB channel gain		105		
DR	Dynamic range, A-weighted ⁽²⁾	IN1 differential input selected and –60-dB full-scale AC signal input, DRE enabled (DRE_LVL = –36 dB, DRE_MAXGAIN = 24 dB), 2.5-k Ω input impedance selection		117		dB
		IN1 differential input selected and –60-dB full-scale AC signal input, DRE enabled (DRE_LVL = –36 dB, DRE_MAXGAIN = 24 dB), 10-k Ω input impedance selection		112		
		IN1 differential input selected and –60-dB full-scale AC signal input, DRE disabled, 2.5-k Ω input impedance selection, 0-dB channel gain		106		
THD+N	Total harmonic distortion ⁽²⁾⁽³⁾	IN1 differential input selected and –2-dB full-scale AC signal input, DRE enabled (DRE_LVL = –36 dB, DRE_MAXGAIN = 24 dB), 2.5-k Ω input impedance selection		–90		dB
		IN1 differential input selected and –2-dB full-scale AC signal input, DRE enabled (DRE_LVL = –36 dB, DRE_MAXGAIN = 24 dB), 10-k Ω input impedance selection		–90		
		IN1 differential input selected and –2-dB full-scale AC signal input, DRE disabled, 2.5-k Ω input impedance selection, 0 dB channel gain		–90		
ADC OTHER PARAMETERS						
	Digital volume control range	Programmable 0.5-dB steps	–100		27	dB
	Output data sample rate	Programmable	7.35		768	kHz
	Output data sample word length	Programmable	16		32	Bits
	Digital high-pass filter cutoff frequency	First-order IIR filter with programmable coefficients, –3-dB point (default setting)		12		Hz
	Interchannel isolation	–1-dB full-scale AC-signal input to non measurement channel		–124		dB

(3) For best distortion performance, use input AC-coupling capacitors with low-voltage-coefficient.

Electrical Characteristics (continued)

at $T_A = 25^\circ\text{C}$, $AVDD = 3.3\text{ V}$, $IOVDD = 3.3\text{ V}$, $f_{IN} = 1\text{-kHz}$ sinusoidal signal, $f_S = 48\text{ kHz}$, 32-bit audio data, $BCLK = 256 \times f_S$, TDM slave mode, PLL on (unless otherwise noted)

PARAMETER		TEST CONDITIONS	MIN	TYP	MAX	UNIT
	Interchannel gain mismatch	–6-dB full-scale AC-signal input and 0-dB channel gain		0.1		dB
	Gain drift	0-dB channel gain, across temperature range 15°C to 35°C		–4.4		ppm/ $^\circ\text{C}$
	Interchannel phase mismatch	1-kHz sinusoidal signal		0.02		Degrees
	Phase drift	1-kHz sinusoidal signal, across temperature range 15°C to 35°C		0.0005		Degrees/ $^\circ\text{C}$
PSRR	Power-supply rejection ratio	100-mV _{PP} , 1-kHz sinusoidal signal on AVDD, differential input selected, 0-dB channel gain		102		dB
CMRR	Common-mode rejection ratio	Differential microphone input selected, 0-dB channel gain, 100-mV _{PP} , 1-kHz signal on both pins and measure level at output		60		dB
MICROPHONE BIAS						
	MICBIAS noise	BW = 20 Hz to 20 kHz, A-weighted, 1- μF capacitor between MICBIAS and AVSS		1.6		μV_{RMS}
	MICBIAS voltage	MICBIAS programmed to VREF and VREF programmed to either 2.75 V, 2.5 V, or 1.375 V		VREF		V
		MICBIAS programmed to VREF \times 1.096 and VREF programmed to either 2.75 V, 2.5 V, or 1.375 V		VREF \times 1.096		
		Bypass to AVDD with 20-mA load		AVDD – 0.2		
	MICBIAS current drive	MICBIAS voltage $\geq 2.5\text{ V}$			20	mA
		MICBIAS voltage $< 2.5\text{ V}$			10	
	MICBIAS load regulation	MICBIAS programmed to either VREF or VREF \times 1.096, measured up to max load	0.1	0.6	1.8	%
	MICBIAS over current protection threshold		30			mA
DIGITAL I/O						
V_{IL}	Low-level digital input logic voltage threshold	All digital pins except INxP_GPIx, SDA and SCL, IOVDD 1.8-V operation	–0.3		$0.35 \times \text{IOVDD}$	V
		All digital pins except INxP_GPIx, SDA and SCL, IOVDD 3.3-V operation	–0.3		0.8	
V_{IH}	High-level digital input logic voltage threshold	All digital pins except INxP_GPIx, SDA and SCL, IOVDD 1.8-V operation	$0.65 \times \text{IOVDD}$		$\text{IOVDD} + 0.3$	V
		All digital pins except INxP_GPIx, SDA and SCL, IOVDD 3.3-V operation	2		$\text{IOVDD} + 0.3$	
V_{OL}	Low-level digital output voltage	All digital pins except INxM_GPOx, SDA and SCL, $I_{OL} = -2\text{ mA}$, IOVDD 1.8-V operation			0.45	V
		All digital pins except INxM_GPOx, SDA and SCL, $I_{OL} = -2\text{ mA}$, IOVDD 3.3-V operation			0.4	
V_{OH}	High-level digital output voltage	All digital pins except INxM_GPOx, SDA and SCL, $I_{OH} = 2\text{ mA}$, IOVDD 1.8-V operation	$\text{IOVDD} - 0.45$			V
		All digital pins except INxM_GPOx, SDA and SCL, $I_{OH} = 2\text{ mA}$, IOVDD 3.3-V operation	2.4			
$V_{IL(I2C)}$	Low-level digital input logic voltage threshold	SDA and SCL	–0.5		$0.3 \times \text{IOVDD}$	V
$V_{IH(I2C)}$	High-level digital input logic voltage threshold	SDA and SCL	$0.7 \times \text{IOVDD}$		$\text{IOVDD} + 0.5$	V
$V_{OL1(I2C)}$	Low-level digital output voltage	SDA, $I_{OL(I2C)} = -3\text{ mA}$, IOVDD $> 2\text{ V}$			0.4	V
$V_{OL2(I2C)}$	Low-level digital output voltage	SDA, $I_{OL(I2C)} = -2\text{ mA}$, IOVDD $\leq 2\text{ V}$			$0.2 \times \text{IOVDD}$	V
$I_{OL(I2C)}$	Low-level digital output current	SDA, $V_{OL(I2C)} = 0.4\text{ V}$, standard-mode or fast-mode	3			mA
		SDA, $V_{OL(I2C)} = 0.4\text{ V}$, fast-mode plus	20			
I_{IH}	Input logic-high leakage for digital inputs	All digital pins except INxP_GPIx pins, input = IOVDD	–5	0.1	5	μA
I_{IL}	Input logic-low leakage for digital inputs	All digital pins except INxP_GPIx pins, input = 0 V	–5	0.1	5	μA

Electrical Characteristics (continued)

at $T_A = 25^\circ\text{C}$, $AVDD = 3.3\text{ V}$, $IOVDD = 3.3\text{ V}$, $f_{IN} = 1\text{-kHz}$ sinusoidal signal, $f_S = 48\text{ kHz}$, 32-bit audio data, $BCLK = 256 \times f_S$, TDM slave mode, PLL on (unless otherwise noted)

PARAMETER		TEST CONDITIONS	MIN	TYP	MAX	UNIT
$V_{IL(GPIx)}$	Low-level digital input logic voltage threshold	All INxP_GPIx digital pins, AVDD 1.8-V operation	-0.3		$0.35 \times AVDD$	V
		All INxP_GPIx digital pins, AVDD 3.3-V operation	-0.3		0.8	
$V_{IH(GPIx)}$	High-level digital input logic voltage threshold	All INxP_GPIx digital pins, AVDD 1.8-V operation	$0.65 \times AVDD$		$AVDD + 0.3$	V
		All INxP_GPIx digital pins, AVDD 3.3-V operation	2		$AVDD + 0.3$	
$V_{OL(GPOx)}$	Low-level digital output voltage	All INxM_GPOx digital pins, $I_{OL} = -2\text{ mA}$, AVDD 1.8-V operation			0.45	V
		All INxM_GPOx digital pins, $I_{OL} = -2\text{ mA}$, AVDD 3.3-V operation			0.4	
$V_{OH(GPOx)}$	High-level digital output voltage	All INxM_GPOx digital pins, $I_{OH} = 2\text{ mA}$, AVDD 1.8-V operation	$AVDD - 0.45$			V
		All INxM_GPOx digital pins, $I_{OH} = 2\text{ mA}$, AVDD 3.3-V operation	2.4			
$I_{IH(GPIx)}$	Input logic-high leakage for digital inputs	All INxP_GPIx digital pins, input = AVDD	-5	0.1	5	μA
$I_{IL(GPIx)}$	Input logic-high leakage for digital inputs	All INxP_GPIx digital pins, input = 0 V	-5	0.1	5	μA
C_{IN}	Input capacitance for digital inputs	All digital pins		5		pF
R_{PD}	Pulldown resistance for digital I/O pins when asserted on			20		k Ω
TYPICAL SUPPLY CURRENT CONSUMPTION						
I_{AVDD}	Current consumption in hardware shutdown mode	SHDNZ = 0, AVDD = 3.3 V, internal AREG		0.5		μA
I_{AVDD}		SHDNZ = 0, AVDD = 1.8 V, external AREG supply (AREG shorted to AVDD)		0.5		
I_{IOVDD}		SHDNZ = 0, all external clocks stopped, IOVDD = 3.3 V		0.1		
I_{IOVDD}		SHDNZ = 0, all external clocks stopped, IOVDD = 1.8 V		0.1		
I_{AVDD}	Current consumption in sleep mode (software shutdown mode)	All external clocks stopped, AVDD = 3.3 V, internal AREG		5		μA
I_{AVDD}		All external clocks stopped, AVDD = 1.8 V, external AREG supply (AREG shorted to AVDD)		5		
I_{IOVDD}		All external clocks stopped, IOVDD = 3.3 V		0.1		
I_{IOVDD}		All external clocks stopped, IOVDD = 1.8 V		0.1		
I_{AVDD}	Current consumption with ADC 2-channel operating at f_S 48-kHz, PLL off, BCLK = $512 \times f_S$ and DRE disable	AVDD = 3.3 V, internal AREG		11.3		mA
I_{AVDD}		AVDD = 1.8 V, external AREG supply (AREG shorted to AVDD)		10.7		
I_{IOVDD}		IOVDD = 3.3 V		0.1		
I_{IOVDD}		IOVDD = 1.8 V		0.05		
I_{AVDD}	Current consumption with ADC 4-channel operating at f_S 16-kHz, PLL on, BCLK = $256 \times f_S$ and DRE disable	AVDD = 3.3 V, internal AREG		19.7		mA
I_{AVDD}		AVDD = 1.8 V, external AREG supply (AREG shorted to AVDD)		18.6		
I_{IOVDD}		IOVDD = 3.3 V		0.05		
I_{IOVDD}		IOVDD = 1.8 V		0.02		
I_{AVDD}	Current consumption with ADC 4-channel operating at f_S 48-kHz, PLL on, BCLK = $256 \times f_S$ and DRE disable	AVDD = 3.3 V, internal AREG		21.3		mA
I_{AVDD}		AVDD = 1.8 V, external AREG supply (AREG shorted to AVDD)		20.2		
I_{IOVDD}		IOVDD = 3.3 V		0.1		
I_{IOVDD}		IOVDD = 1.8 V		0.05		
I_{AVDD}	Current consumption with ADC 4-channel operating at f_S 48-kHz, PLL on, BCLK = $256 \times f_S$ and DRE enable	AVDD = 3.3 V, internal AREG		23.6		mA
I_{AVDD}		AVDD = 1.8 V, external AREG supply (AREG shorted to AVDD)		22.3		
I_{IOVDD}		IOVDD = 3.3 V		0.1		
I_{IOVDD}		IOVDD = 1.8 V		0.05		

7.6 Timing Requirements: I²C Interface

 at T_A = 25°C, IOVDD = 3.3 V or 1.8 V (unless otherwise noted); see [Figure 1](#) for timing diagram

		MIN	NOM	MAX	UNIT
STANDARD-MODE					
f _{SCL}	SCL clock frequency	0		100	kHz
t _{HD,STA}	Hold time (repeated) START condition. After this period, the first clock pulse is generated.	4			μs
t _{LOW}	Low period of the SCL clock	4.7			μs
t _{HIGH}	High period of the SCL clock	4			μs
t _{SU,STA}	Setup time for a repeated START condition	4.7			μs
t _{HD,DAT}	Data hold time	0		3.45	μs
t _{SU,DAT}	Data setup time	250			ns
t _r	SDA and SCL rise time			1000	ns
t _f	SDA and SCL fall time			300	ns
t _{SU,STO}	Setup time for STOP condition	4			μs
t _{BUF}	Bus free time between a STOP and START condition	4.7			μs
FAST-MODE					
f _{SCL}	SCL clock frequency	0		400	kHz
t _{HD,STA}	Hold time (repeated) START condition. After this period, the first clock pulse is generated.	0.6			μs
t _{LOW}	Low period of the SCL clock	1.3			μs
t _{HIGH}	High period of the SCL clock	0.6			μs
t _{SU,STA}	Setup time for a repeated START condition	0.6			μs
t _{HD,DAT}	Data hold time	0		0.9	μs
t _{SU,DAT}	Data setup time	100			ns
t _r	SDA and SCL rise time	20		300	ns
t _f	SDA and SCL fall time		20 × (IOVDD / 5.5 V)	300	ns
t _{SU,STO}	Setup time for STOP condition	0.6			μs
t _{BUF}	Bus free time between a STOP and START condition	1.3			μs
FAST-MODE PLUS					
f _{SCL}	SCL clock frequency	0		1000	kHz
t _{HD,STA}	Hold time (repeated) START condition. After this period, the first clock pulse is generated.	0.26			μs
t _{LOW}	Low period of the SCL clock	0.5			μs
t _{HIGH}	High period of the SCL clock	0.26			μs
t _{SU,STA}	Setup time for a repeated START condition	0.26			μs
t _{HD,DAT}	Data hold time	0			μs
t _{SU,DAT}	Data setup time	50			ns
t _r	SDA and SCL rise time			120	ns
t _f	SDA and SCL fall time		20 × (IOVDD / 5.5 V)	120	ns
t _{SU,STO}	Setup time for STOP condition	0.26			μs
t _{BUF}	Bus free time between a STOP and START condition	0.5			μs

7.7 Switching Characteristics: I²C Interface

 at T_A = 25°C, IOVDD = 3.3 V or 1.8 V (unless otherwise noted); see [Figure 1](#) for timing diagram

PARAMETER	TEST CONDITIONS	MIN	TYP	MAX	UNIT
t _{d(SDA)}	Standard-mode	250		1250	ns
	Fast-mode	250		850	
	Fast-mode plus			400	

7.8 Timing Requirements: SPI Interface

at $T_A = 25^\circ\text{C}$, IOVDD = 3.3 V or 1.8 V and 20-pF load on all outputs (unless otherwise noted); see [Figure 2](#) for timing diagram

		MIN	NOM	MAX	UNIT
$t_{(SCLK)}$	SCLK period	40			ns
$t_{H(SCLK)}$	SCLK high pulse duration	18			ns
$t_{L(SCLK)}$	SCLK low pulse duration	18			ns
t_{LEAD}	Enable lead time	16			ns
t_{TRAIL}	Enable trail time	16			ns
t_{DSEQ}	Sequential transfer delay	20			ns
$t_{SU(MOSI)}$	MOSI data setup time	8			ns
$t_{HLD(MOSI)}$	MOSI data hold time	8			ns
$t_{r(SCLK)}$	SCLK rise time	10% - 90% rise time		6	ns
$t_{f(SCLK)}$	SCLK fall time	90% - 10% fall time		6	ns

7.9 Switching Characteristics: SPI Interface

at $T_A = 25^\circ\text{C}$, IOVDD = 3.3 V or 1.8 V and 20-pF load on all outputs (unless otherwise noted); see [Figure 2](#) for timing diagram

PARAMETER	TEST CONDITIONS	MIN	TYP	MAX	UNIT
$t_a(\text{MISO})$	MISO access time			16	ns
$t_d(\text{MISO})$	SCLK to MISO delay	50% of SCLK to 50% of MISO		16	ns
$t_{dis}(\text{MISO})$	MISO disable time			20	ns

7.10 Timing Requirements: TDM, I²S or LJ Interface

at $T_A = 25^\circ\text{C}$, IOVDD = 3.3 V or 1.8 V and 20-pF load on all outputs (unless otherwise noted); see [Figure 3](#) for timing diagram

		MIN	NOM	MAX	UNIT
$t_{(BCLK)}$	BCLK period	40			ns
$t_{H(BCLK)}$	BCLK high pulse duration ⁽¹⁾	18			ns
$t_{L(BCLK)}$	BCLK low pulse duration ⁽¹⁾	18			ns
$t_{SU(FSYNC)}$	FSYNC setup time	8			ns
$t_{HLD(FSYNC)}$	FSYNC hold time	8			ns
$t_{r(BCLK)}$	BCLK rise time	10% - 90% rise time		10	ns
$t_{f(BCLK)}$	BCLK fall time	90% - 10% fall time		10	ns

(1) The BCLK minimum high or low pulse duration must be higher than 25 ns (to meet the timing specifications), if the SDO_{UT} data line is latched on the opposite BCLK edge polarity than the edge used by the device to transmit SDO_{UT} data.

7.11 Switching Characteristics: TDM, I²S or LJ Interface

at $T_A = 25^\circ\text{C}$, IOVDD = 3.3 V or 1.8 V and 20-pF load on all outputs (unless otherwise noted); see [Figure 3](#) for timing diagram

PARAMETER	TEST CONDITIONS	MIN	TYP	MAX	UNIT
$t_d(\text{SDOUT-BCLK})$	BCLK to SDO _{UT} delay	50% of BCLK to 50% of SDO _{UT}		18	ns
$t_d(\text{SDOUT-FSYNC})$	FSYNC to SDO _{UT} delay in TDM or LJ mode (for MSB data with TX_OFFSET = 0)	50% of FSYNC to 50% of SDO _{UT}		18	ns
$f_{(BCLK)}$	BCLK output clock frequency: master mode ⁽¹⁾			24.576	MHz
$t_{H(BCLK)}$	BCLK high pulse duration: master mode	14			ns
$t_{L(BCLK)}$	BCLK low pulse duration: master mode	14			ns
$t_d(\text{FSYNC})$	BCLK to FSYNC delay: master mode	50% of BCLK to 50% of FSYNC		18	ns
$t_{r(BCLK)}$	BCLK rise time: master mode	10% - 90% rise time		8	ns
$t_{f(BCLK)}$	BCLK fall time: master mode	90% - 10% fall time		8	ns

(1) The BCLK output clock frequency must be lower than 18.5 MHz (to meet the timing specifications), if the SDO_{UT} data line is latched on the opposite BCLK edge polarity than the edge used by the device to transmit SDO_{UT} data.

7.12 Timing Requirements: PDM Digital Microphone Interface

at $T_A = 25^\circ\text{C}$, $\text{IOVDD} = 3.3\text{ V}$ or 1.8 V and 20-pF load on all outputs (unless otherwise noted); see Figure 4 for timing diagram

		MIN	NOM	MAX	UNIT
$t_{\text{SU}}(\text{PDMINx})$	PDMINx setup time	30			ns
$t_{\text{HLD}}(\text{PDMINx})$	PDMINx hold time	0			ns

7.13 Switching Characteristics: PDM Digital Microphone Interface

at $T_A = 25^\circ\text{C}$, $\text{IOVDD} = 3.3\text{ V}$ or 1.8 V and 20-pF load on all outputs (unless otherwise noted); see Figure 4 for timing diagram

PARAMETER	TEST CONDITIONS	MIN	TYP	MAX	UNIT
$f_{\text{r}}(\text{PDMCLK})$	PDMCLK clock frequency	0.768		6.144	MHz
$t_{\text{H}}(\text{PDMCLK})$	PDMCLK high pulse duration	72			ns
$t_{\text{L}}(\text{PDMCLK})$	PDMCLK low pulse duration	72			ns
$t_{\text{r}}(\text{PDMCLK})$	PDMCLK rise time	10% - 90% rise time		18	ns
$t_{\text{f}}(\text{PDMCLK})$	PDMCLK fall time	90% - 10% fall time		18	ns

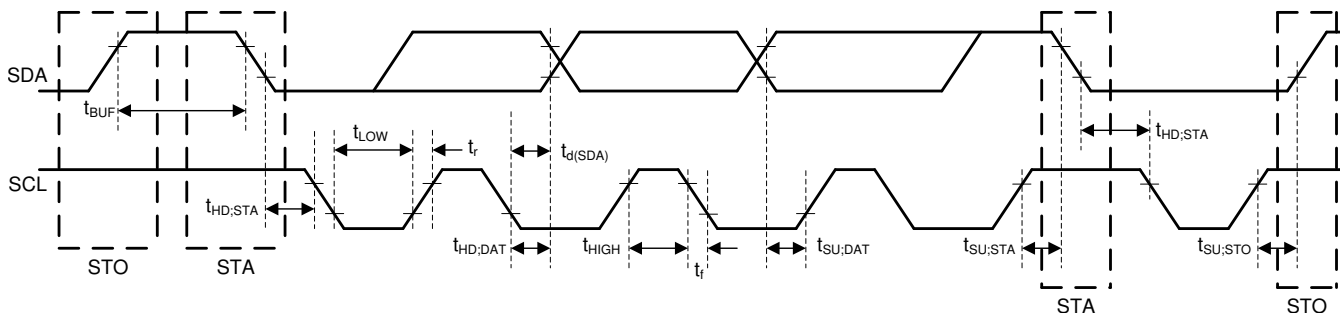

Figure 1. I²C Interface Timing Diagram

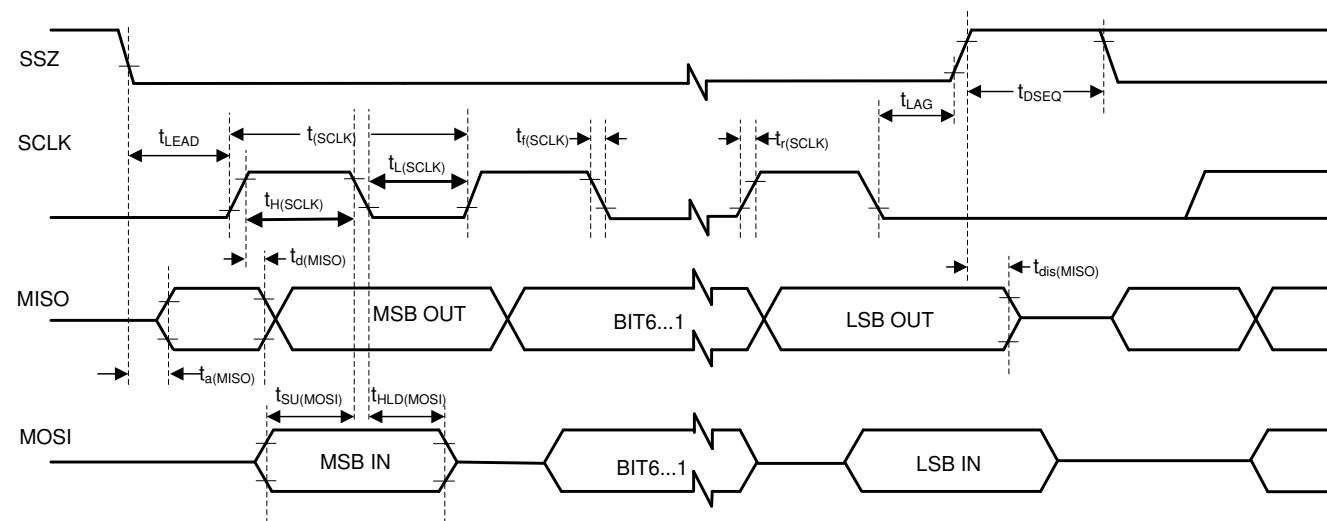
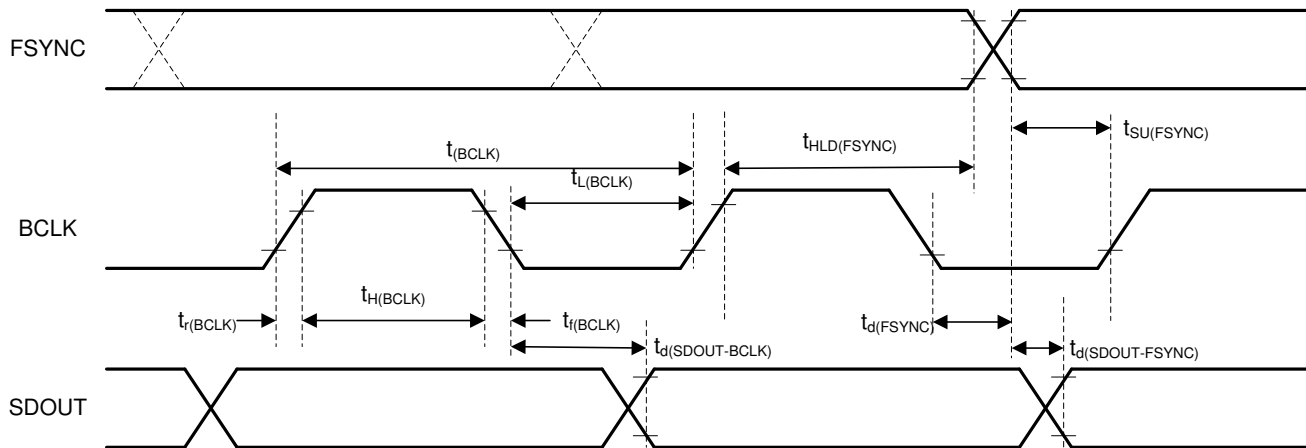
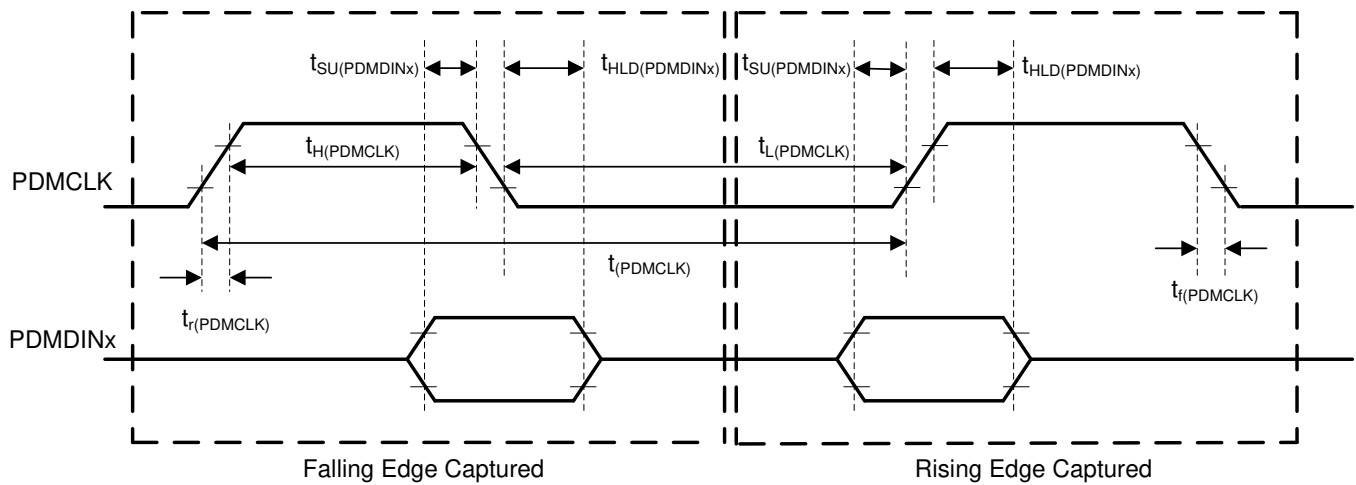

Figure 2. SPI Interface Timing Diagram

Figure 3. TDM (With BCLK_POL = 1), I²S, and LJ Interface Timing Diagram

Figure 4. PDM Digital Microphone Interface Timing Diagram

7.14 Typical Characteristics

at $T_A = 25^\circ\text{C}$, $AVDD = 3.3\text{ V}$, $IOVDD = 3.3\text{ V}$, $f_{IN} = 1\text{-kHz}$ sinusoidal signal, $f_S = 48\text{ kHz}$, 32-bit audio data, $BCLK = 256 \times f_S$, TDM slave mode, PLL on, $DRE_LVL = -36\text{ dB}$, channel gain = 0 dB, and linear phase decimation filter (unless otherwise noted); all performance measurements are done with a 20-kHz, low-pass filter, and an A-weighted filter

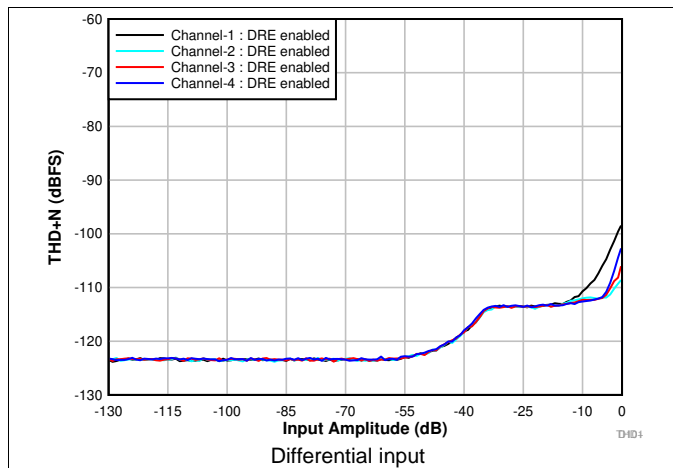

Figure 5. THD+N vs Input Amplitude With DRE Enabled

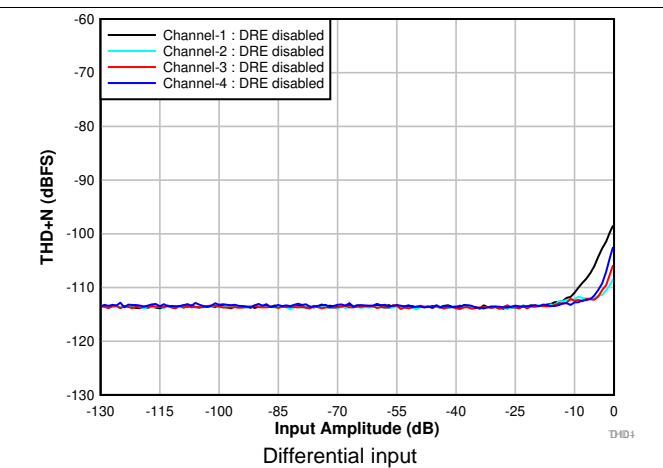

Figure 6. THD+N vs Input Amplitude With DRE Disabled

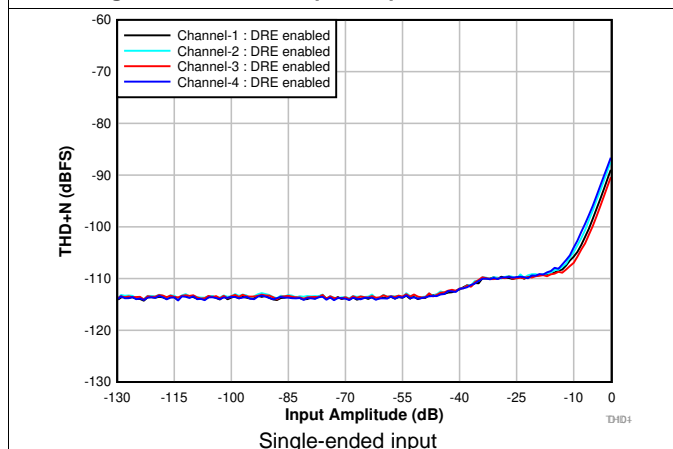

Figure 7. THD+N vs Input Amplitude With DRE Enabled

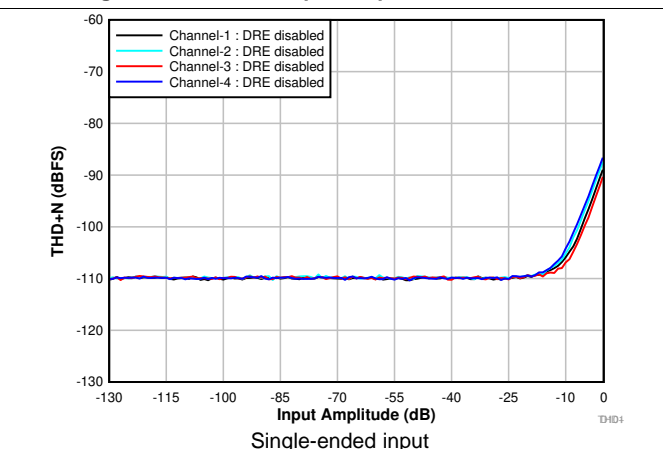

Figure 8. THD+N vs Input Amplitude With DRE Disabled

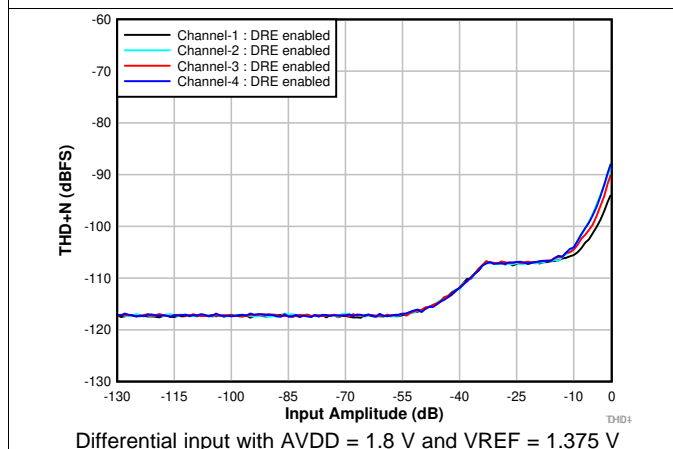

Figure 9. THD+N vs Input Amplitude With DRE Enabled

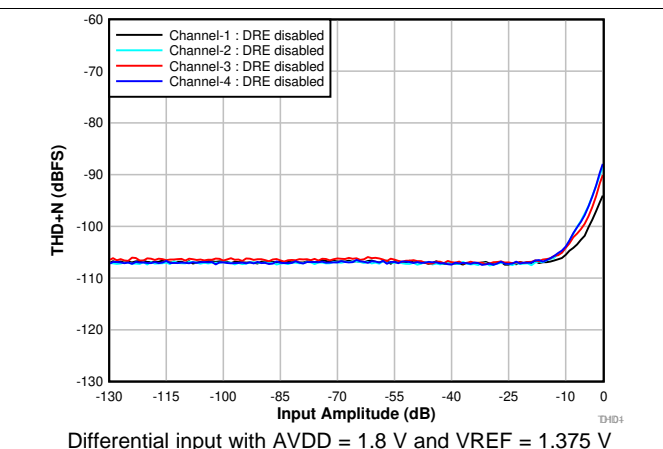

Figure 10. THD+N vs Input Amplitude With DRE Disabled

Typical Characteristics (continued)

at $T_A = 25^\circ\text{C}$, $AV_{DD} = 3.3\text{ V}$, $IOV_{DD} = 3.3\text{ V}$, $f_{IN} = 1\text{-kHz}$ sinusoidal signal, $f_S = 48\text{ kHz}$, 32-bit audio data, $BCLK = 256 \times f_S$, TDM slave mode, PLL on, $DRE_LVL = -36\text{ dB}$, channel gain = 0 dB , and linear phase decimation filter (unless otherwise noted); all performance measurements are done with a 20-kHz, low-pass filter, and an A-weighted filter

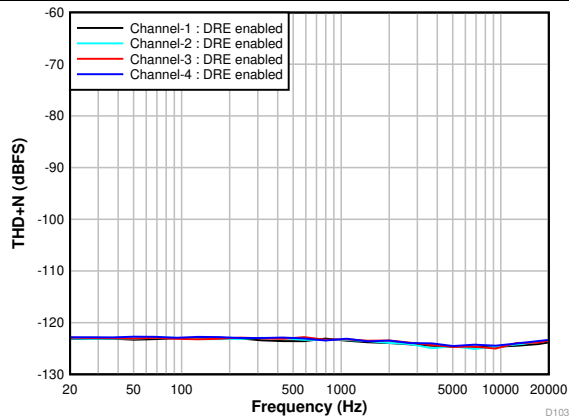

Figure 11. THD+N vs Input Frequency With a -60-dBr Input

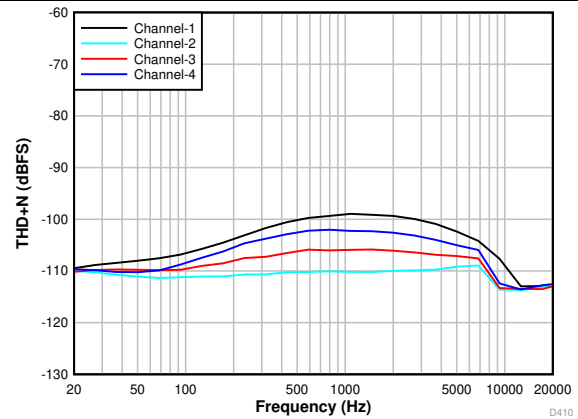

Figure 12. THD+N vs Input Frequency With a -1-dBr Input

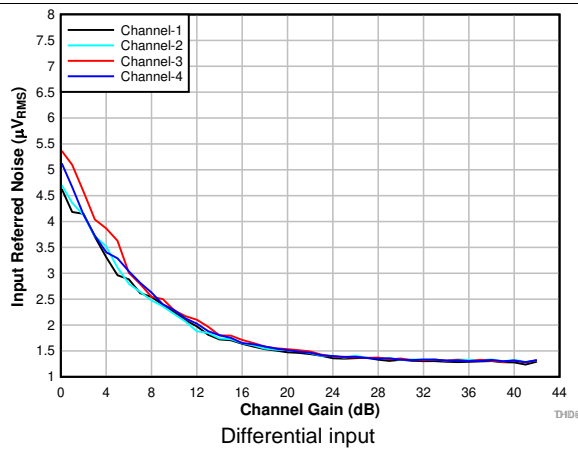

Figure 13. Input-Referred Noise vs Channel Gain

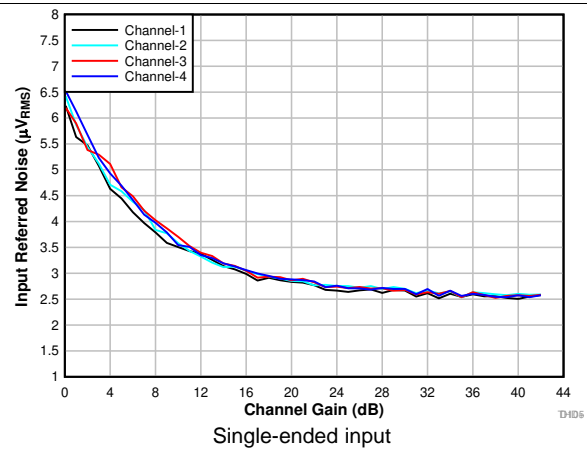

Figure 14. Input-Referred Noise vs Channel Gain

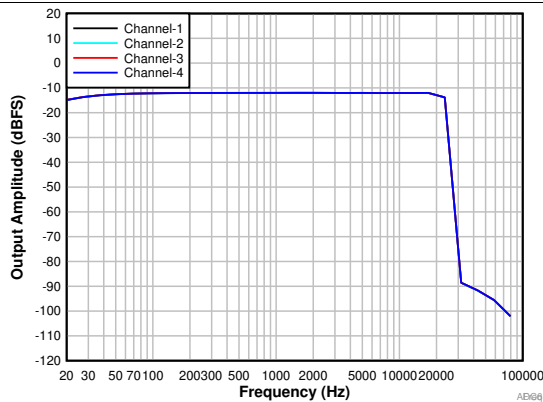

Figure 15. Frequency Response With a -12-dBr Input

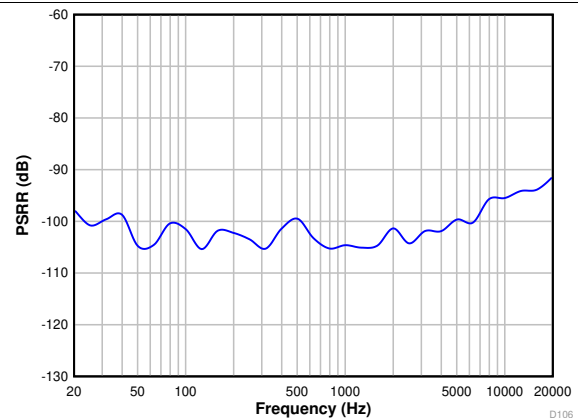

Figure 16. Power-Supply Rejection Ratio vs Ripple Frequency With 100-mV_{PP} Amplitude

Typical Characteristics (continued)

at $T_A = 25^\circ\text{C}$, $AVDD = 3.3\text{ V}$, $IOVDD = 3.3\text{ V}$, $f_{IN} = 1\text{-kHz}$ sinusoidal signal, $f_S = 48\text{ kHz}$, 32-bit audio data, $BCLK = 256 \times f_S$, TDM slave mode, PLL on, $DRE_LVL = -36\text{ dB}$, channel gain = 0 dB , and linear phase decimation filter (unless otherwise noted); all performance measurements are done with a 20-kHz, low-pass filter, and an A-weighted filter

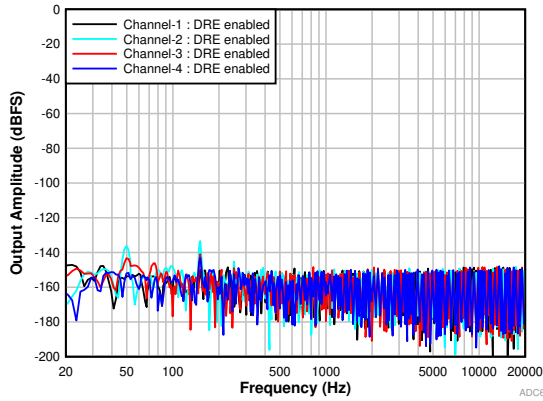

Figure 17. FFT With Idle Input With DRE Enabled

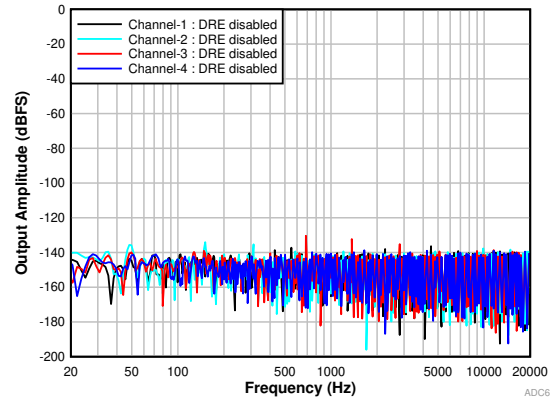

Figure 18. FFT With Idle Input With DRE Disabled

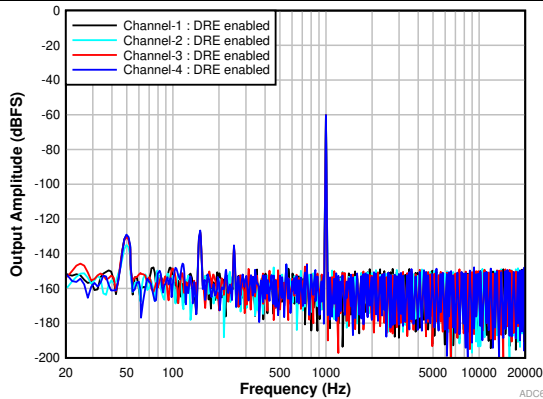

Figure 19. FFT With a -60-dBr Input With DRE Enabled

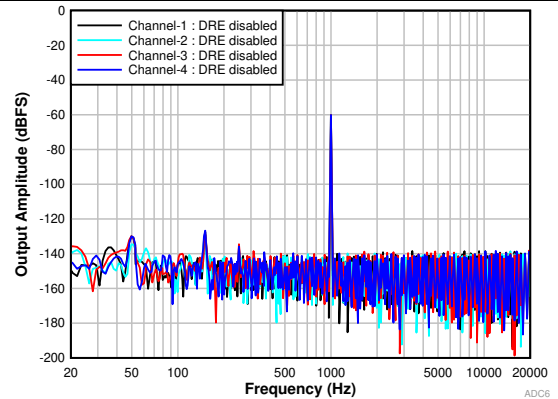

Figure 20. FFT With a -60-dBr Input With DRE Disabled

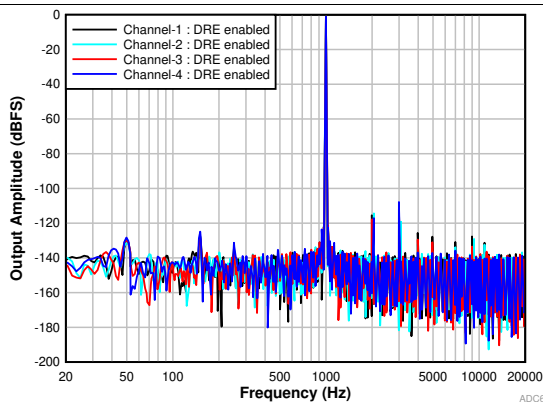

Figure 21. FFT With a -1-dBr Input With DRE Enabled

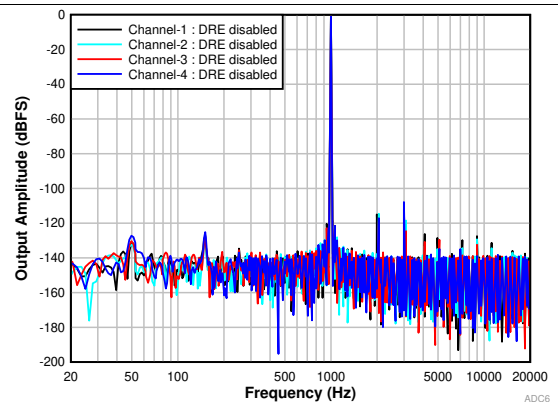

Figure 22. FFT With a -1-dBr Input With DRE Disabled

8 Detailed Description

8.1 Overview

The TLV320ADC6140 is a high-performance, low-power, flexible, quad-channel, audio analog-to-digital converter (ADC) with extensive feature integration. This device is intended for applications in voice-activated systems, professional microphones, audio conferencing, portable computing, communication, and entertainment applications. The high dynamic range of the device enables far-field audio recording with high fidelity. This device integrates a host of features that reduces cost, board space, and power consumption in space-constrained, battery-powered, consumer, home, and industrial applications.

The TLV320ADC6140 consists of the following blocks:

- Quad-channel, multibit, high-performance delta-sigma ($\Delta\Sigma$) ADC
- Configurable single-ended or differential audio inputs
- Low-noise, programmable microphone bias output
- Dynamic range enhancer (DRE) to support 120-dB dynamic range
- Automatic gain controller (AGC)
- Programmable decimation filters with linear-phase or low-latency filter
- Programmable channel gain, volume control, biquad filters for each channel
- Programmable phase and gain calibration with fine resolution for each channel
- Programmable high-pass filter (HPF), and digital channel mixer
- Pulse density modulation (PDM) digital microphone interface with high-performance decimation filter
- Integrated low-jitter phase-locked loop (PLL) supporting a wide range of system clocks
- Integrated digital and analog voltage regulators to support single-supply operation

Communication to the TLV320ADC6140 to configure the control registers is supported using an I²C or SPI interface. The device supports a highly flexible audio serial interface [time-division multiplexing (TDM), I²S, or left-justified (LJ)] to transmit audio data seamlessly in the system across devices.

The device can support multiple devices by sharing the common I²C and TDM buses across devices. Moreover, the device includes a daisy-chain feature and a secondary audio serial output data pin. These features relax the shared TDM bus timing requirements and board design complexities when operating multiple devices for applications requiring high audio data bandwidth.

[Table 1](#) lists the reference abbreviations used throughout this document to registers that control the device.

Table 1. Abbreviations for Register References

REFERENCE	ABBREVIATION	DESCRIPTION	EXAMPLE
Page y, register z, bit k	Py_Rz_Dk	Single data bit. The value of a single bit in a register.	Page 4, register 36, bit 0 = P4_R36_D0
Page y, register z, bits k-m	Py_Rz_D[k:m]	Range of data bits. A range of data bits (inclusive).	Page 4, register 36, bits 3-0 = P4_R36_D[3:0]
Page y, register z	Py_Rz	One entire register. All eight bits in the register as a unit.	Page 4, register 36 = P4_R36
Page y, registers z-n	Py_Rz-Rn	Range of registers. A range of registers in the same page.	Page 4, registers 36, 37, 38 = P4_R36-R38

8.2 Functional Block Diagram

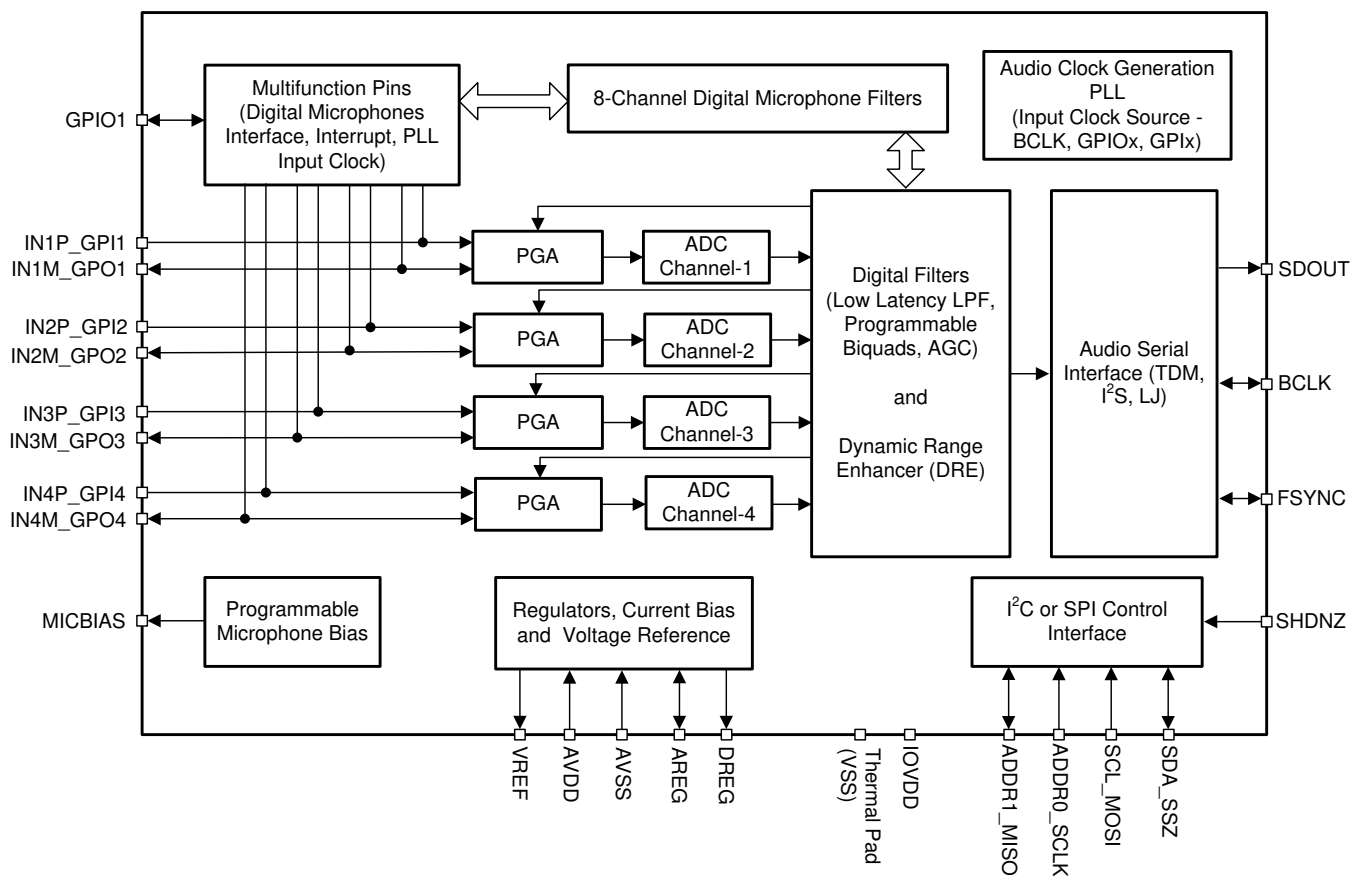

8.3 Feature Description

8.3.1 Serial Interfaces

This device has two serial interfaces: control and audio data. The control serial interface is used for device configuration. The audio data serial interface is used for transmitting audio data to the host device.

8.3.1.1 Control Serial Interfaces

The device contains configuration registers and programmable coefficients that can be set to the desired values for a specific system and application use. All these registers can be accessed using either I²C or SPI communication to the device. For more information, see the [Programming](#) section.

8.3.1.2 Audio Serial Interfaces

Digital audio data flows between the host processor and the TLV320ADC6140 on the digital audio serial interface (ASI), or audio bus. This highly flexible ASI bus includes a TDM mode for multichannel operation, support for I²S or left-justified protocols format, programmable data length options, very flexible master-slave configurability for bus clock lines and the ability to communicate with multiple devices within a system directly.

Feature Description (continued)

The bus protocol TDM, I²S, or left-justified (LJ) format can be selected by using the ASI_FORMAT[1:0], P0_R7_D[7:6] register bits. As shown in [Table 2](#) and [Table 3](#), these modes are all most significant byte (MSB)-first, pulse code modulation (PCM) data format, with the output channel data word-length programmable as 16, 20, 24, or 32 bits by configuring the ASI_WLEN[1:0], P0_R7_D[5:4] register bits.

Table 2. Audio Serial Interface Format

P0_R7_D[7:6] : ASI_FORMAT[1:0]	AUDIO SERIAL INTERFACE FORMAT
00 (default)	Time division multiplexing (TDM) mode
01	Inter IC sound (I ² S) mode
10	Left-justified (LJ) mode
11	Reserved (do not use this setting)

Table 3. Audio Output Channel Data Word-Length

P0_R7_D[5:4] : ASI_WLEN[1:0]	AUDIO OUTPUT CHANNEL DATA WORD-LENGTH
00	Output channel data word-length set to 16 bits
01	Output channel data word-length set to 20 bits
10	Output channel data word-length set to 24 bits
11 (default)	Output channel data word-length set to 32 bits

The frame sync pin, FSYNC, is used in this audio bus protocol to define the beginning of a frame and has the same frequency as the output data sample rates. The bit clock pin, BCLK, is used to clock out the digital audio data across the serial bus. The number of bit-clock cycles in a frame must accommodate multiple device active output channels with the programmed data word length.

A frame consists of multiple time-division channel slots (up to 64) to allow all output channel audio data transmissions to complete on the audio bus by a device or multiple TLV320ADC6140 devices sharing the same audio bus. The device supports up to eight output channels that can be configured to place their audio data on bus slot 0 to slot 63. [Table 4](#) lists the output channel slot configuration settings. In I²S and LJ mode, the slots are divided into two sets, left-channel slots and right-channel slots, as described in the [Inter IC Sound \(I²S\) Interface](#) and [Left-Justified \(LJ\) Interface](#) sections.

Table 4. Output Channel Slot Assignment Settings

P0_R11_D[5:0] : CH1_SLOT[5:0]	OUTPUT CHANNEL 1 SLOT ASSIGNMENT
00 0000 = 0d (default)	Slot 0 for TDM or left slot 0 for I ² S, LJ.
00 0001 = 1d	Slot 1 for TDM or left slot 1 for I ² S, LJ.
...	...
01 1111 = 31d	Slot 31 for TDM or left slot 31 for I ² S, LJ.
10 0000 = 32d	Slot 32 for TDM or right slot 0 for I ² S, LJ.
...	...
11 1110 = 62d	Slot 62 for TDM or right slot 30 for I ² S, LJ.
11 1111 = 63d	Slot 63 for TDM or right slot 31 for I ² S, LJ.

Similarly, the slot assignment setting for output channel 2 to channel 8 can be done using the CH2_SLOT (P0_R12) to CH8_SLOT (P0_R18) registers, respectively.

The slot word length is the same as the output channel data word length set for the device. The output channel data word length must be set to the same value for all TLV320ADC6140 devices if all devices share the same ASI bus in a system. The maximum number of slots possible for the ASI bus in a system is limited by the available bus bandwidth, which depends upon the BCLK frequency, output data sample rate used, and the channel data word length configured.

The device also includes a feature that offsets the start of the slot data transfer with respect to the frame sync by up to 31 cycles of the bit clock. Table 5 lists the programmable offset configuration settings.

Table 5. Programmable Offset Settings for the ASI Slot Start

P0_R8_D[4:0] : TX_OFFSET[4:0]	PROGRAMMABLE OFFSET SETTING FOR SLOT DATA TRANSMISSION START
0 0000 = 0d (default)	The device follows the standard protocol timing without any offset.
0 0001 = 1d	Slot start is offset by one BCLK cycle, as compared to standard protocol timing. For I ² S or LJ, the left and right slot start is offset by one BCLK cycle, as compared to standard protocol timing.
.....
1 1110 = 30d	Slot start is offset by 30 BCLK cycles, as compared to standard protocol timing. For I ² S or LJ, the left and right slot start is offset by 30 BCLK cycles, as compared to standard protocol timing.
1 1111 = 31d	Slot start is offset by 31 BCLK cycles, as compared to standard protocol timing. For I ² S or LJ, the left and right slot start is offset by 31 BCLK cycles, as compared to standard protocol timing.

The device also features the ability to invert the polarity of the frame sync pin, FSYNC, used to transfer the audio data as compared to the default FSYNC polarity used in standard protocol timing. This feature can be set using the FSYNC_POL, P0_R7_D3 register bit. Similarly, the device can invert the polarity of the bit clock pin, BCLK, which can be set using the BCLK_POL, P0_R7_D2 register bit.

8.3.1.2.1 Time Division Multiplexed Audio (TDM) Interface

In TDM mode, also known as DSP mode, the rising edge of FSYNC starts the data transfer with the slot 0 data first. Immediately after the slot 0 data transmission, the remaining slot data are transmitted in order. FSYNC and each data bit (except the MSB of slot 0 when TX_OFFSET equals 0) is transmitted on the rising edge of BCLK. Figure 23 to Figure 26 illustrate the protocol timing for TDM operation with various configurations.

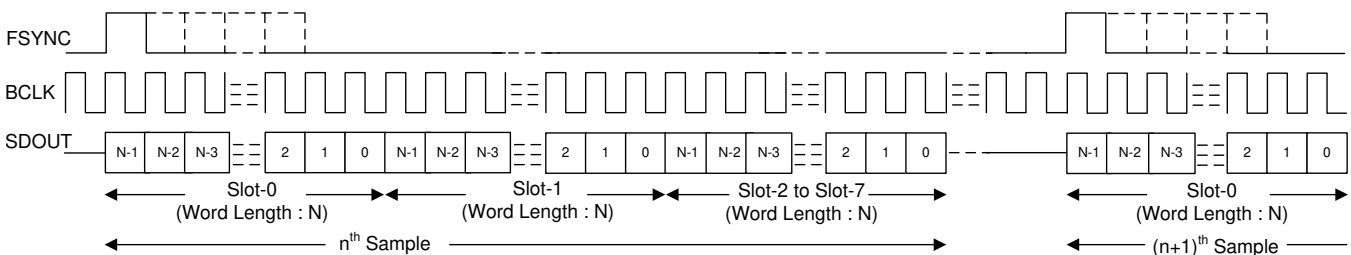

Figure 23. TDM Mode Standard Protocol Timing (TX_OFFSET = 0)

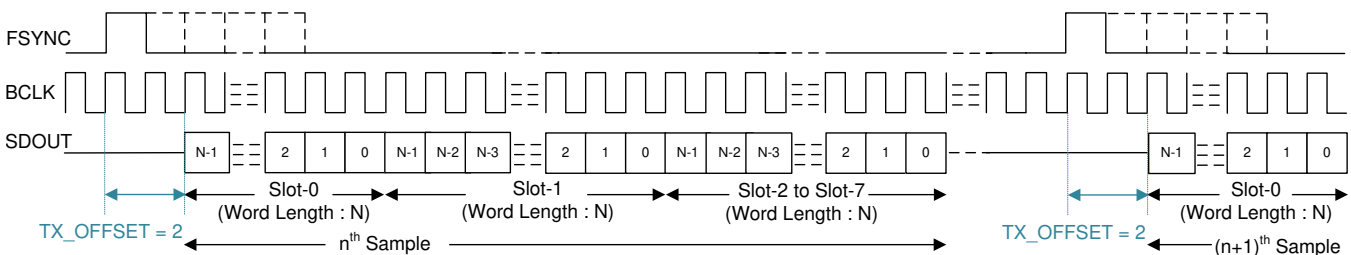

Figure 24. TDM Mode Protocol Timing (TX_OFFSET = 2)

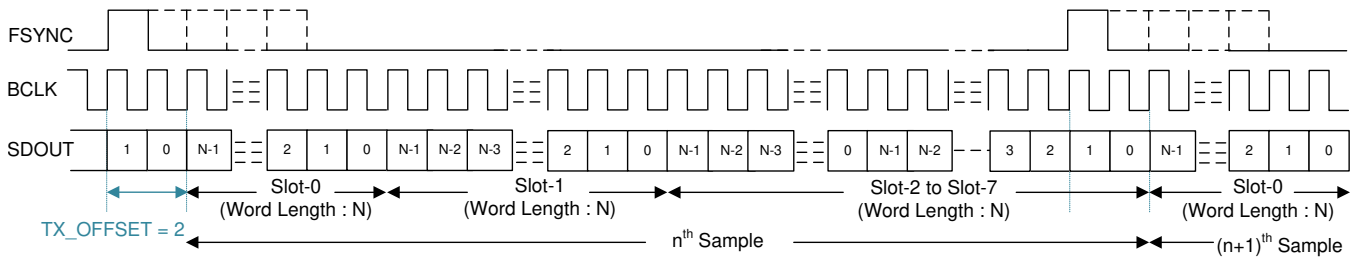

Figure 25. TDM Mode Protocol Timing (No Idle BCLK Cycles, TX_OFFSET = 2)

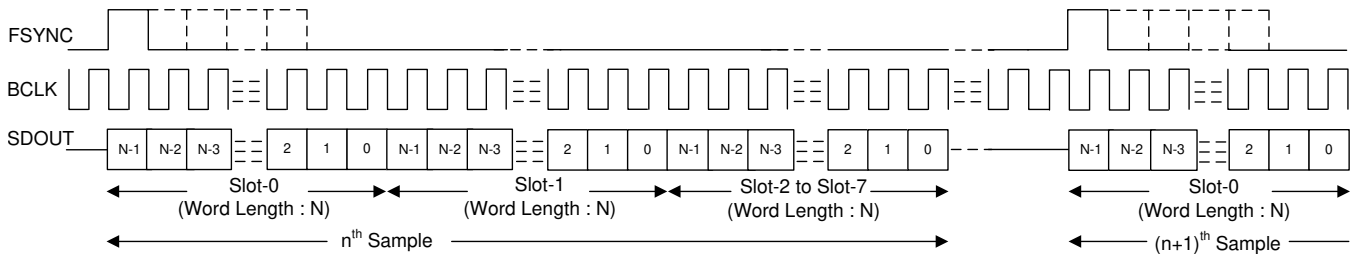

Figure 26. TDM Mode Protocol Timing (TX_OFFSET = 0 and BCLK_POL = 1)

For proper operation of the audio bus in TDM mode, the number of bit clocks per frame must be greater than or equal to the number of active output channels times the programmed word length of the output channel data. The device supports FSYNC as a pulse with a 1-cycle-wide bit clock, but also supports multiples as well. For a higher BCLK frequency operation, using TDM mode with a TX_OFFSET value higher than 0 is recommended.

8.3.1.2.2 Inter IC Sound (I²S) Interface

The standard I²S protocol is defined for only two channels: left and right. The device extends the same protocol timing for multichannel operation. In I²S mode, the MSB of the left slot 0 is transmitted on the falling edge of BCLK in the second cycle after the falling edge of FSYNC. Immediately after the left slot 0 data transmission, the remaining left slot data are transmitted in order. The MSB of the right slot 0 is transmitted on the falling edge of BCLK in the second cycle after the rising edge of FSYNC. Immediately after the right slot 0 data transmission, the remaining right slot data are transmitted in order. FSYNC and each data bit is transmitted on the falling edge of BCLK. Figure 27 to Figure 30 illustrate the protocol timing for I²S operation with various configurations.

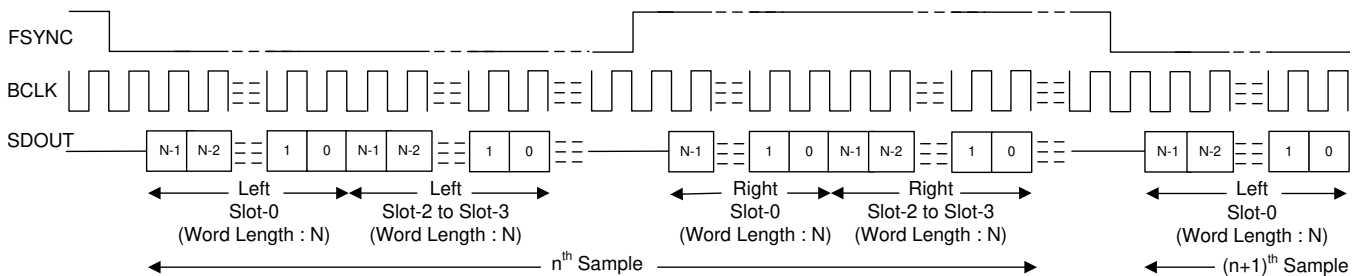

Figure 27. I²S Mode Standard Protocol Timing (TX_OFFSET = 0)

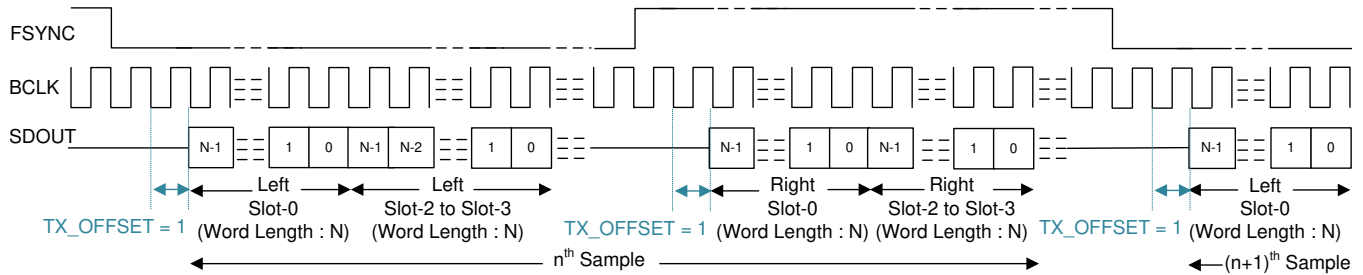

Figure 28. I²S Protocol Timing (TX_OFFSET = 1)

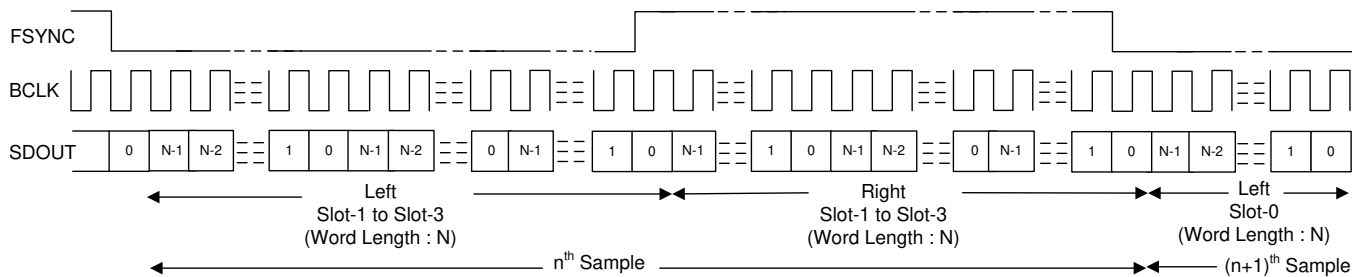

Figure 29. I²S Protocol Timing (No Idle BCLK Cycles, TX_OFFSET = 0)

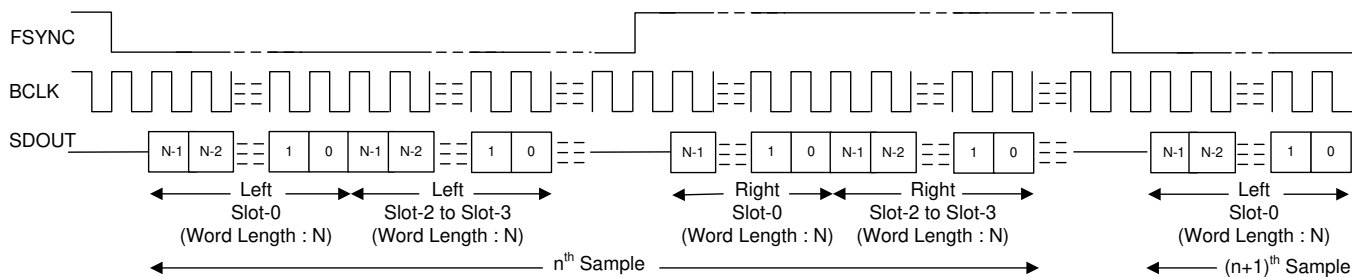
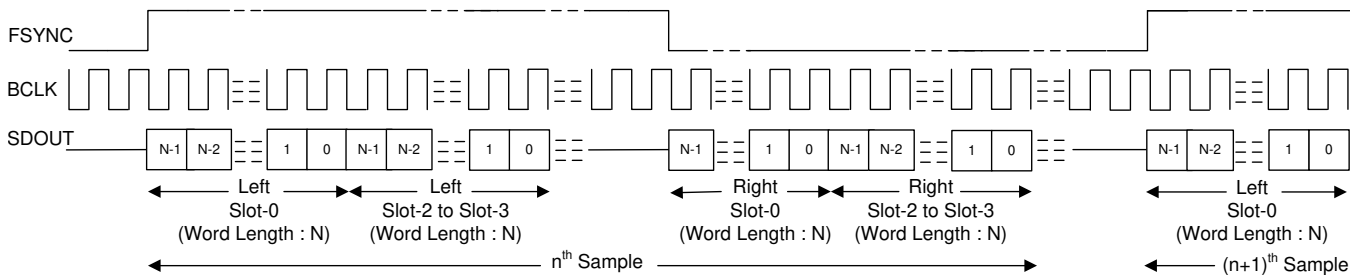
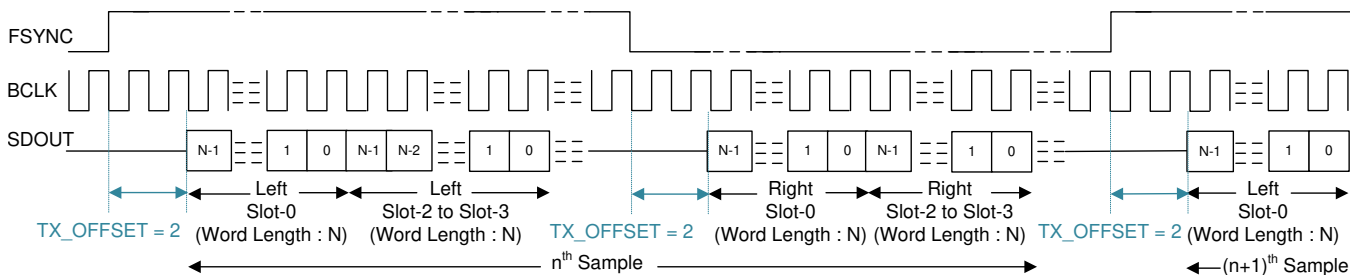
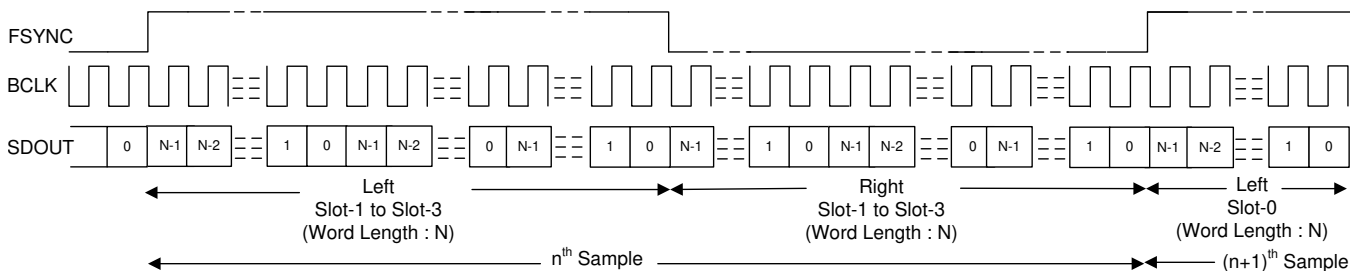
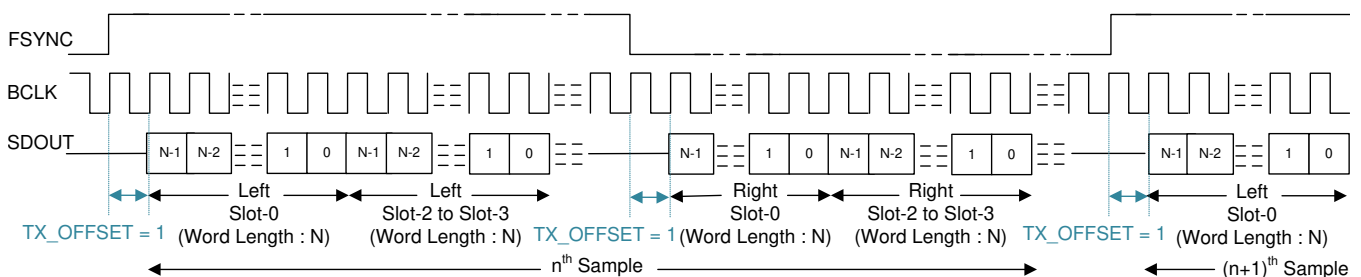

Figure 30. I²S Protocol Timing (TX_OFFSET = 0 and BCLK_POL = 1)

For proper operation of the audio bus in I²S mode, the number of bit clocks per frame must be greater than or equal to the number of active output channels (including left and right slots) times the programmed word length of the output channel data. The device FSYNC low pulse must be a number of BCLK cycles wide that is greater than or equal to the number of active left slots times the data word length configured. Similarly, the FSYNC high pulse must be a number of BCLK cycles wide that is greater than or equal to the number of active right slots times the data word length configured.

8.3.1.2.3 Left-Justified (LJ) Interface

The standard LJ protocol is defined for only two channels: left and right. The device extends the same protocol timing for multichannel operation. In LJ mode, the MSB of the left slot 0 is transmitted in the same BCLK cycle after the rising edge of FSYNC. Each subsequent data bit is transmitted on the falling edge of BCLK. Immediately after the left slot 0 data transmission, the remaining left slot data are transmitted in order. The MSB of the right slot 0 is transmitted in the same BCLK cycle after the falling edge of FSYNC. Each subsequent data bit is transmitted on the falling edge of BCLK. Immediately after the right slot 0 data transmission, the remaining right slot data are transmitted in order. FSYNC is transmitted on the falling edge of BCLK. Figure 31 to Figure 34 illustrate the protocol timing for LJ operation with various configurations.

Figure 31. LJ Mode Standard Protocol Timing (TX_OFFSET = 0)

Figure 32. LJ Protocol Timing (TX_OFFSET = 2)

Figure 33. LJ Protocol Timing (No Idle BCLK Cycles, TX_OFFSET = 0)

Figure 34. LJ Protocol Timing (TX_OFFSET = 1 and BCLK_POL = 1)

For proper operation of the audio bus in LJ mode, the number of bit clocks per frame must be greater than or equal to the number of active output channels (including left and right slots) times the programmed word length of the output channel data. The device FSYNC high pulse must be a number of BCLK cycles wide that is greater than or equal to the number of active left slots times the data word length configured. Similarly, the FSYNC low pulse must be number of BCLK cycles wide that is greater than or equal to the number of active right slots times the data word length configured. For a higher BCLK frequency operation, using LJ mode with a TX_OFFSET value higher than 0 is recommended.

8.3.1.3 Using Multiple Devices With Shared Buses

The device has many supported features and flexible options that can be used in the system to seamlessly connect multiple TLV320ADC6140 devices by sharing a single common I²C control bus and an audio serial interface bus. This architecture enables multiple applications to be applied to a system that require a microphone array for beam-forming operation, audio conferencing, noise cancellation, and so forth. Figure 35 shows a diagram of multiple TLV320ADC6140 devices in a configuration where the control and audio data buses are shared.

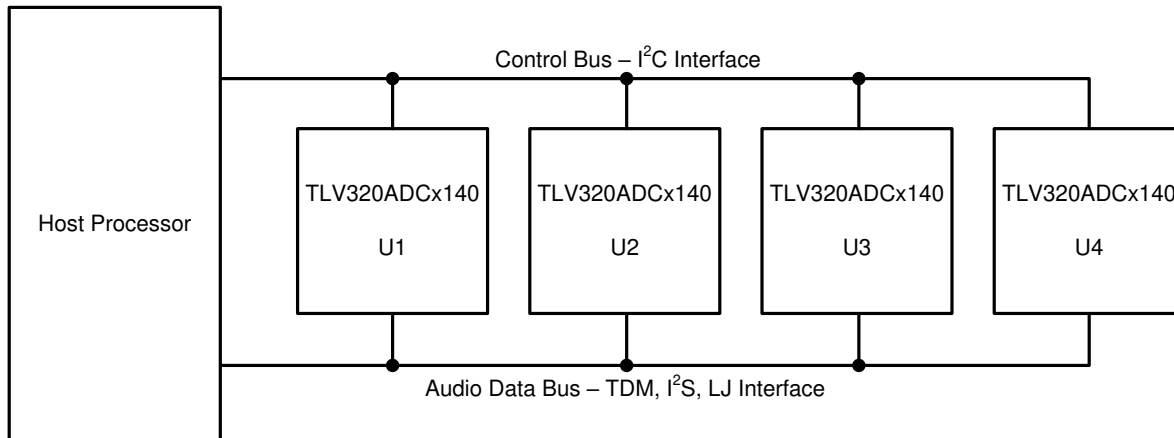

Figure 35. Multiple TLV320ADC6140 Devices With Shared Control and Audio Data Buses

The TLV320ADC6140 consists of the following features to enable seamless connection and interaction of multiple devices using a shared bus:

- Supports up to four pin-programmable I²C slave addresses
- I²C broadcast simultaneously writes to (or triggers) all TLV320ADC6140 devices
- Supports up to 64 configuration output channel slots for the audio serial interface
- Tri-state feature (with enable and disable) for the unused audio data slots of the device
- Supports a bus-holder feature (with enable and disable) to keep the last driven value on the audio bus
- The GPIO1 or GPOx pin can be configured as a secondary output data lane for the audio serial interface
- The GPIO1 or GPIx pin can be used in a daisy-chain configuration of multiple TLV320ADC6140 devices
- Supports one BCLK cycle data latching timing to relax the timing requirement for the high-speed interface
- Programmable master and slave options for the audio serial interface
- Ability to synchronize the multiple devices for the simultaneous sampling requirement across devices

See the [Multiple TLV320ADCx140 Devices With a Shared TDM and I²C Bus application report](#) for further details.

8.3.2 Phase-Locked Loop (PLL) and Clock Generation

The device has a smart auto-configuration block to generate all necessary internal clocks required for the ADC modulator and the digital filter engine used for signal processing. This configuration is done by monitoring the frequency of the FSYNC and BCLK signal on the audio bus.

The device supports the various output data sample rates (of the FSYNC signal frequency) and the BCLK to FSYNC ratio to configure all clock dividers, including the PLL configuration, internally without host programming. [Table 6](#) and [Table 7](#) list the supported FSYNC and BCLK frequencies.

Table 6. Supported FSYNC (Multiples or Submultiples of 48 kHz) and BCLK Frequencies

BCLK TO FSYNC RATIO	BCLK (MHz)								
	FSYNC (8 kHz)	FSYNC (16 kHz)	FSYNC (24 kHz)	FSYNC (32 kHz)	FSYNC (48 kHz)	FSYNC (96 kHz)	FSYNC (192 kHz)	FSYNC (384 kHz)	FSYNC (768 kHz)
16	Reserved	0.256	0.384	0.512	0.768	1.536	3.072	6.144	12.288
24	Reserved	0.384	0.576	0.768	1.152	2.304	4.608	9.216	18.432
32	0.256	0.512	0.768	1.024	1.536	3.072	6.144	12.288	24.576
48	0.384	0.768	1.152	1.536	2.304	4.608	9.216	18.432	Reserved
64	0.512	1.024	1.536	2.048	3.072	6.144	12.288	24.576	Reserved
96	0.768	1.536	2.304	3.072	4.608	9.216	18.432	Reserved	Reserved
128	1.024	2.048	3.072	4.096	6.144	12.288	24.576	Reserved	Reserved
192	1.536	3.072	4.608	6.144	9.216	18.432	Reserved	Reserved	Reserved
256	2.048	4.096	6.144	8.192	12.288	24.576	Reserved	Reserved	Reserved
384	3.072	6.144	9.216	12.288	18.432	Reserved	Reserved	Reserved	Reserved
512	4.096	8.192	12.288	16.384	24.576	Reserved	Reserved	Reserved	Reserved
1024	8.192	16.384	24.576	Reserved	Reserved	Reserved	Reserved	Reserved	Reserved
2048	16.384	Reserved	Reserved	Reserved	Reserved	Reserved	Reserved	Reserved	Reserved

Table 7. Supported FSYNC (Multiples or Submultiples of 44.1 kHz) and BCLK Frequencies

BCLK TO FSYNC RATIO	BCLK (MHz)								
	FSYNC (7.35 kHz)	FSYNC (14.7 kHz)	FSYNC (22.05 kHz)	FSYNC (29.4 kHz)	FSYNC (44.1 kHz)	FSYNC (88.2 kHz)	FSYNC (176.4 kHz)	FSYNC (352.8 kHz)	FSYNC (705.6 kHz)
16	Reserved	Reserved	0.3528	0.4704	0.7056	1.4112	2.8224	5.6448	11.2896
24	Reserved	0.3528	0.5292	0.7056	1.0584	2.1168	4.2336	8.4672	16.9344
32	Reserved	0.4704	0.7056	0.9408	1.4112	2.8224	5.6448	11.2896	22.5792
48	0.3528	0.7056	1.0584	1.4112	2.1168	4.2336	8.4672	16.9344	Reserved
64	0.4704	0.9408	1.4112	1.8816	2.8224	5.6448	11.2896	22.5792	Reserved
96	0.7056	1.4112	2.1168	2.8224	4.2336	8.4672	16.9344	Reserved	Reserved
128	0.9408	1.8816	2.8224	3.7632	5.6448	11.2896	22.5792	Reserved	Reserved
192	1.4112	2.8224	4.2336	5.6448	8.4672	16.9344	Reserved	Reserved	Reserved
256	1.8816	3.7632	5.6448	7.5264	11.2896	22.5792	Reserved	Reserved	Reserved
384	2.8224	5.6448	8.4672	11.2896	16.9344	Reserved	Reserved	Reserved	Reserved
512	3.7632	7.5264	11.2896	15.0528	22.5792	Reserved	Reserved	Reserved	Reserved
1024	7.5264	15.0528	22.5792	Reserved	Reserved	Reserved	Reserved	Reserved	Reserved
2048	15.0528	Reserved	Reserved	Reserved	Reserved	Reserved	Reserved	Reserved	Reserved

The status register ASI_STS, P0_R21, captures the device auto detect result for the FSYNC frequency and the BCLK to FSYNC ratio. If the device finds any unsupported combinations of FSYNC frequency and BCLK to FSYNC ratios, the device generates an ASI clock-error interrupt and mutes the record channels accordingly.

The device uses an integrated, low-jitter, phase-locked loop (PLL) to generate internal clocks required for the ADC modulator and digital filter engine, as well as other control blocks. The device also supports an option to use BCLK, GPIO1, or the GPIx pin (as MCLK) as the audio clock source without using the PLL to reduce power consumption. However, the ADC performance may degrade based on jitter from the external clock source, and some processing features may not be supported if the external audio clock source frequency is not high enough. Therefore, TI recommends using the PLL for high-performance applications. More details and information on how to configure and use the device in low-power mode without using the PLL are discussed in the [TLV320ADCx140 Operation for Low-Power Critical Applications application report](#).

The device also supports an audio bus master mode operation using the GPIO1 or GPIx pin (as MCLK) as the reference input clock source and supports various flexible options and a wide variety of system clocks. More details and information on master mode configuration and operation are discussed in the [Configuring and Operating the TLV320ADCx140 as an Audio Bus Master application report](#).

The audio bus clock error detection and auto-detect feature automatically generates all internal clocks, but can be disabled using the ASI_ERR, P0_R9_D5 and AUTO_CLK_CFG, P0_R19_D6, register bits, respectively. In the system, this disable feature can be used to support custom clock frequencies that are not covered by the auto detect scheme. For such application use cases, care must be taken to ensure that the multiple clock dividers are all configured appropriately. Therefore, TI recommends using the PPC3 GUI for device configuration settings; for more details see the [TLV320ADCx140 Evaluation module user's guide](#) and the [PurePath™ console graphical development suite](#).

8.3.3 Input Channel Configurations

The device consists of four pairs of analog input pins (INxP and INxM) that can be configured as differential inputs or single-ended inputs for the recording channel. The device supports simultaneous recording of up to four channels using the high-performance multichannel ADC. The input source for the analog pins can be from electret condenser analog microphones, microelectrical-mechanical system (MEMS) analog microphones, or line-in (auxiliary) inputs from the system board. Additionally, if the application uses digital PDM microphones for the recording, then the INxP and INxM pins can be reconfigured in the device to support up to eight channels for the digital microphone recording. [Table 8](#) shows the input source selection for the record channel.

Table 8. Input Source Selection for the Record Channel

P0_R60_D[6:5] : CH1_INSRC[1:0]	INPUT CHANNEL 1 RECORD SOURCE SELECTION
00 (default)	Analog differential input for channel 1 (this setting is valid only when the GPI1 and GPO1 pin functions are disabled)
01	Analog single-ended Input for channel 1 (this setting is valid only when the GPI1 and GPO1 pin functions are disabled)
10	Digital PDM input for channel 1 (configure the GPIx and GPOx pin accordingly for PDMDIN1 and PDMCLK)
11	Reserved (do not use this setting)

Similarly, the input source selection setting for input channel 2, channel 3, and channel 4 can be configured using the CH2_INSRC[1:0] (P0_R65_D[6:5]), CH3_INSRC[1:0] (P0_R70_D[6:5]), and CH4_INSRC[1:0] (P0_R75_D[6:5]) register bits, respectively.

Typically, voice or audio signal inputs are capacitively coupled (AC-coupled) to the device; however, the device also supports an option for DC-coupled inputs to save board space. This configuration can be done independently for each channel by setting the CH1_DC (P0_R60_D4), CH2_DC (P0_R65_D4), CH3_DC (P0_R70_D4), and CH4_DC (P0_R75_D4) register bits. The INM pin can be directly grounded in DC-coupled mode (see [Figure 36](#)), but the INM pin must be grounded after the AC-coupling capacitor in AC-coupled mode (see [Figure 37](#)) for the single-ended input configuration. For the best dynamic range performance, the differential AC-coupled input must be used with the DRE enabled.

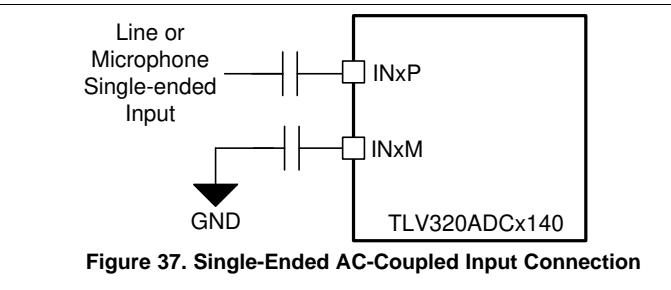
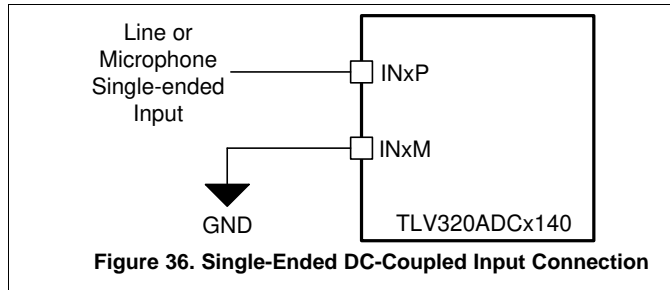

The device allows for flexibility in choosing the typical input impedance on INxP or INxM from 2.5 k Ω (default), 10 k Ω , and 20 k Ω based on the input source impedance. The higher input impedance results in slightly higher noise or lower dynamic range. [Table 9](#) lists the configuration register settings for the input impedance for the record channel.

Table 9. Input Impedance Selection for the Record Channel

P0_R60_D[3:2] : CH1_IMP[1:0]	CHANNEL 1 INPUT IMPEDANCE SELECTION
00 (default)	Channel 1 input impedance typical value is 2.5 k Ω on INxP or INxM
01	Channel 1 input impedance typical value is 10 k Ω on INxP or INxM
10	Channel 1 input impedance typical value is 20 k Ω on INxP or INxM
11	Reserved (do not use this setting)

Similarly, the input impedance selection setting for input channel 2, channel 3, and channel 4 can be configured using the CH2_IMP[1:0] (P0_R65_D[3:2]), CH3_IMP[1:0] (P0_R70_D[3:2]), and CH4_IMP[1:0] (P0_R75_D[3:2]) register bits, respectively.

The value of the coupling capacitor in AC-coupled mode must be chosen so that the high-pass filter formed by the coupling capacitor and the input impedance do not affect the signal content. Before proper recording can begin, this coupling capacitor must be charged up to the common-mode voltage at power-up. To enable quick charging, the device has modes to speed up the charging of the coupling capacitor. The default value of the quick-charge timing is set for a coupling capacitor up to 1 μ F. However, if a higher-value capacitor is used in the system, then the quick-charging timing can be increased by using the INCAP_QCHG (P0_R5_D[5:4]) register bits. For best distortion performance, use the low-voltage coefficient capacitors for AC coupling. The input impedance value of 2.5 k Ω is not supported for the DC-coupled input.

8.3.4 Reference Voltage

All audio data converters require a DC reference voltage. The TLV320ADC6140 achieves low-noise performance by internally generating a low-noise reference voltage. This reference voltage is generated using a band-gap circuit with high PSRR performance. This audio converter reference voltage must be filtered externally using a minimum 1- μ F capacitor connected from the VREF pin to analog ground (AVSS).

The value of this reference voltage can be configured using the P0_R59_D[1:0] register bits and must be set to an appropriate value based on the desired full-scale input for the device and the AVDD supply voltage available in the system. The default VREF value is set to 2.75 V, which in turn supports a 2- V_{RMS} differential full-scale input to the device. The required minimum AVDD voltage for this mode is 3 V. [Table 10](#) lists the various VREF settings supported along with required AVDD range and the supported full-scale input signal for that configuration.

Table 10. VREF Programmable Settings

P0_R59_D[1:0] : ADC_FSCALE[1:0]	VREF OUTPUT VOLTAGE (Same as Internal ADC VREF)	DIFFERENTIAL FULL-SCALE INPUT SUPPORTED	SINGLE-ENDED FULL-SCALE INPUT SUPPORTED	AVDD RANGE REQUIREMENT
00 (default)	2.75 V	2 V_{RMS}	1 V_{RMS}	3 V to 3.6 V
01	2.5 V	1.818 V_{RMS}	0.909 V_{RMS}	2.8 V to 3.6 V
10	1.375 V	1 V_{RMS}	0.5 V_{RMS}	1.7 V to 1.9 V
11	Reserved	Reserved	Reserved	Reserved

To achieve low-power consumption, this audio reference block is powered down as described in the [Sleep Mode or Software Shutdown](#) section. When exiting sleep mode, the audio reference block is powered up using the internal fast-charge scheme and the VREF pin settles to its steady-state voltage after the settling time (a function of the decoupling capacitor on the VREF pin). This time is approximately equal to 3.5 ms when using a 1- μ F decoupling capacitor. If a higher-value decoupling capacitor is used on the VREF pin, the fast-charge setting must be reconfigured using the VREF_QCHG, P0_R2_D[4:3] register bits, which support options of 3.5 ms (default), 10 ms, 50 ms, or 100 ms.

8.3.5 Programmable Microphone Bias

The device integrates a built-in, low-noise microphone bias pin that can be used in the system for biasing electret-condenser microphones or providing the supply to the MEMS analog or digital microphone. The integrated bias amplifier supports up to 20 mA of load current that can be used for multiple microphones and is designed to provide a combination of high PSRR, low noise, and programmable bias voltages to allow the biasing to be fine tuned for specific microphone combinations.

When using this MICBIAS pin for biasing or supplying to multiple microphones, avoid any common impedance on the board layout for the MICBIAS connection to minimize coupling across microphones. [Table 11](#) shows the available microphone bias programmable options.

Table 11. MICBIAS Programmable Settings

P0_R59_D[6:4] : MBIAS_VAL[2:0]	P0_R59_D[1:0] : ADC_FSCALE[1:0]	MICBIAS OUTPUT VOLTAGE
000 (default)	00 (default)	2.75 V (same as the VREF output)
	01	2.5 V (same as the VREF output)
	10	1.375 V (same as the VREF output)
001	00 (default)	3.014 V (1.096 times the VREF output)
	01	2.740 V (1.096 times the VREF output)
	10	1.507 V (1.096 times the VREF output)
010 to 101	XX	Reserved (do not use these settings)
110	XX	Same as AVDD
111	XX	Reserved (do not use this setting)

The microphone bias output can be powered on or powered off (default) by configuring the MICBIAS_PDZ, P0_R117_D7 register bit. Additionally, the device provides an option to configure the GPIO1 or GPIx pin to directly control the microphone bias output powering on or off. This feature is useful to control the microphone directly without engaging the host for I²C or SPI communication. The MICBIAS_PDZ, P0_R117_D7 register bit value is ignored if the GPIO1 or GPIx pin is configured to set the microphone bias on or off.

8.3.6 Signal-Chain Processing

The TLV320ADC6140 signal chain is comprised of very-low-noise, high-performance, and low-power analog blocks and highly flexible and programmable digital processing blocks. The high performance and flexibility combined with a compact package makes the TLV320ADC6140 optimized for a variety of end-equipments and applications that require multichannel audio capture. [Figure 38](#) shows a conceptual block diagram that highlights the various building blocks used in the signal chain, and how the blocks interact in the signal chain.

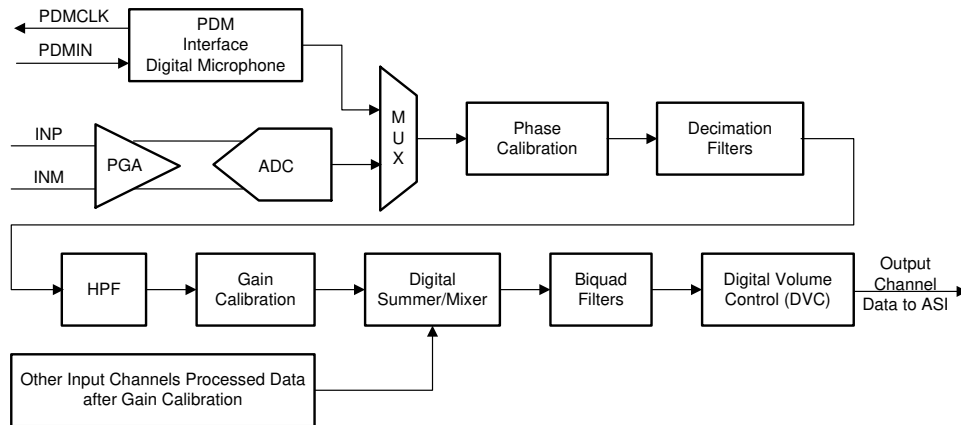

Figure 38. Signal-Chain Processing Flowchart

The front-end PGA is very low noise, with a 120-dB dynamic range performance. Along with a low-noise and low-distortion, multibit, delta-sigma ADC, the front-end PGA enables the TLV320ADC6140 to record a far-field audio signal with very high fidelity, both in quiet and loud environments. Moreover, the ADC architecture has inherent antialias filtering with a high rejection of out-of-band frequency noise around multiple modulator frequency components. Therefore, the device prevents noise from aliasing into the audio band during ADC sampling. Further on in the signal chain, an integrated, high-performance multistage digital decimation filter sharply cuts off any out-of-band frequency noise with high stop-band attenuation.

The device also has an integrated programmable biquad filter that allows for custom low-pass, high-pass, or any other desired frequency shaping. Thus, the overall signal chain architecture removes the requirement to add external components for antialiasing low-pass filtering, and thus saves drastically on the external system component cost and board space. See the [TLV320ADCx140 Integrated Analog Antialiasing Filter and Flexible Digital Filter application report](#) for further details.

The signal chain also consists of various highly programmable digital processing blocks such as phase calibration, gain calibration, high-pass filter, digital summer or mixer, biquad filters, and volume control. The details on these processing blocks are discussed further in this section. The device also supports up to eight digital PDM microphone recording channels when the analog record channels are not used. Channels 1 to 4 in the signal chain block diagram of [Figure 38](#) are as described in this section, however, channels 5 to 8 only support the digital microphone recording option and do not support the digital summer or mixer option.

The desired input channels for recording can be enabled or disabled by using the IN_CH_EN (P0_R115) register, and the output channels for the audio serial interface can be enabled or disabled by using the ASI_OUT_EN (P0_R116) register. In general, the device supports simultaneous power-up and power-down of all active channels for simultaneous recording. However, based on the application needs, if some channels must be powered-up or powered-down dynamically when the other channel recording is on, then that use case is supported by setting the DYN_CH_PUPD_EN, P0_R117_D4 register bit to '1'b1.

The device supports an input signal bandwidth up to 80 kHz, which allows the high-frequency non-audio signal to be recorded by using a 176.4-kHz (or higher) sample rate.

For output sample rates of 48 kHz or lower, the device supports all features for 8-channel recording and various programmable processing blocks. However, for output sample rates higher than 48 kHz, there are limitations in the number of simultaneous channel recordings supported and the number of biquad filters and such. See the [TLV320ADCx140 Sampling Rates and Programmable Processing Blocks Supported application report](#) for further details.

8.3.6.1 Programmable Channel Gain and Digital Volume Control

The device has an independent programmable channel gain setting for each input channel that can be set to the appropriate value based on the maximum input signal expected in the system and the ADC VREF setting used (see the [Reference Voltage](#) section), which determines the ADC full-scale signal level.

Configure the desired channel gain setting before powering up the ADC channel and do not change this setting while the ADC is powered on. The programmable range supported for each channel gain is from 0 dB to 42 dB in steps of 1 dB. To achieve low-noise performance, the device internal logic first maximizes the gain for the front-end low-noise analog PGA, which supports a dynamic range of 120 dB, and then applies any residual programmed channel gain in the digital processing block.

Table 12 shows the programmable options available for the channel gain.

Table 12. Channel Gain Programmable Settings

P0_R61_D[7:2] : CH1_GAIN[5:0]	CHANNEL GAIN SETTING FOR INPUT CHANNEL 1
00 0000 = 0d (default)	Input channel 1 gain is set to 0 dB
00 0001 = 1d	Input channel 1 gain is set to 1 dB
00 0010 = 2d	Input channel 1 gain is set to 2 dB
...	...
10 1001 = 41d	Input channel 1 gain is set to 41 dB
10 1010 = 42d	Input channel 1 gain is set to 42 dB
10 1011 to 11 1111 = 43d to 63d	Reserved (do not use these settings)

Similarly, the channel gain setting for input channel 2, channel 3, and channel 4 can be configured using the CH2_GAIN (P0_R66), CH3_GAIN (P0_R71), and CH4_GAIN (P0_R76) register bits, respectively. The channel gain feature is not available for the digital microphone record path.

The device also has a programmable digital volume control with a range from –100 dB to 27 dB in steps of 0.5 dB with the option to mute the channel recording. The digital volume control value can be changed dynamically while the ADC channel is powered-up and recording. During volume control changes, the soft ramp-up or ramp-down volume feature is used internally to avoid any audible artifacts. Soft-stepping can be entirely disabled using the DISABLE_SOFT_STEP (P0_R108_D4) register bit.

The digital volume control setting is independently available for each output channel, including the digital microphone record channel. However, the device also supports an option to gang-up the volume control setting for all channels together using the channel 1 digital volume control setting, regardless if channel 1 is powered up or powered down. This gang-up can be enabled using the DVOL_GANG (P0_R108_D7) register bit.

Table 13 shows the programmable options available for the digital volume control.

Table 13. Digital Volume Control (DVC) Programmable Settings

P0_R62_D[7:0] : CH1_DVOL[7:0]	DVC SETTING FOR OUTPUT CHANNEL 1
0000 0000 = 0d	Output channel 1 DVC is set to mute
0000 0001 = 1d	Output channel 1 DVC is set to –100 dB
0000 0010 = 2d	Output channel 1 DVC is set to –99.5 dB
0000 0011 = 3d	Output channel 1 DVC is set to –99 dB
...	...
1100 1000 = 200d	Output channel 1 DVC is set to –0.5 dB
1100 1001 = 201d (default)	Output channel 1 DVC is set to 0 dB
1100 1010 = 202d	Output channel 1 DVC is set to 0.5 dB
...	...
1111 1101 = 253d	Output channel 1 DVC is set to 26 dB
1111 1110 = 254d	Output channel 1 DVC is set to 26.5 dB
1111 1111 = 255d	Output channel 1 DVC is set to 27 dB

Similarly, the digital volume control setting for output channel 2 to channel 8 can be configured using the CH2_DVOL (P0_R67) to CH8_DVOL (P0_R97) register bits, respectively.

The internal digital processing engine soft ramps up the volume from a muted level to the programmed volume level when the channel is powered up, and the internal digital processing engine soft ramps down the volume from a programmed volume to mute when the channel is powered down. This soft-stepping of volume is done to prevent abruptly powering up and powering down the record channel. This feature can also be entirely disabled using the DISABLE_SOFT_STEP (P0_R108_D4) register bit.

8.3.6.2 Programmable Channel Gain Calibration

Along with the programmable channel gain and digital volume, this device also provides programmable channel gain calibration. The gain of each channel can be finely calibrated or adjusted in steps of 0.1 dB for a range of –0.8-dB to 0.7-dB gain error. This adjustment is useful when trying to match the gain across channels resulting from external components and microphone sensitivity. This feature, in combination with the regular digital volume control, allows the gains across all channels to be matched for a wide gain error range with a resolution of 0.1 dB. Table 14 shows the programmable options available for the channel gain calibration.

Table 14. Channel Gain Calibration Programmable Settings

P0_R63_D[7:4] : CH1_GCAL[3:0]	CHANNEL GAIN CALIBRATION SETTING FOR INPUT CHANNEL 1
0000 = 0d	Input channel 1 gain calibration is set to –0.8 dB
0001 = 1d	Input channel 1 gain calibration is set to –0.7 dB
...	...
1000 = 8d (default)	Input channel 1 gain calibration is set to 0 dB
...	...
1110 = 14d	Input channel 1 gain calibration is set to 0.6 dB
1111 = 15d	Input channel 1 gain calibration is set to 0.7 dB

Similarly, the channel gain calibration setting for input channel 2 to channel 8 can be configured using the CH2_GCAL (P0_R68) to CH8_GCAL (P0_R98) register bits, respectively.

8.3.6.3 Programmable Channel Phase Calibration

In addition to the gain calibration, the phase delay in each channel can be finely calibrated or adjusted in steps of one modulator clock cycle for a cycle range of 0 to 255 for the phase error. The modulator clock, the same clock used for ADC_MOD_CLK, is 6.144 MHz (the output data sample rate is multiples or submultiples of 48 kHz) or 5.6448 MHz (the output data sample rate is multiples or submultiples of 44.1 kHz) irrespective of the analog microphone or digital microphone use case. This feature is very useful for many applications that must match the phase with fine resolution between each channel, including any phase mismatch across channels resulting from external components or microphones. Table 15 shows the available programmable options for channel phase calibration.

Table 15. Channel Phase Calibration Programmable Settings

P0_R64_D[7:0] : CH1_PCAL[7:0]	CHANNEL PHASE CALIBRATION SETTING FOR INPUT CHANNEL 1
0000 0000 = 0d (default)	Input channel 1 phase calibration with no delay
0000 0001 = 1d	Input channel 1 phase calibration delay is set to one cycle of the modulator clock
0000 0010 = 2d	Input channel 1 phase calibration delay is set to two cycles of the modulator clock
...	...
1111 1110 = 254d	Input channel 1 phase calibration delay is set to 254 cycles of the modulator clock
1111 1111 = 255d	Input channel 1 phase calibration delay is set to 255 cycles of the modulator clock

Similarly, the channel phase calibration setting for input channel 2 to channel 8 can be configured using the CH2_PCAL (P0_R69) to CH8_PCAL (P0_R99) register bits, respectively.

The phase calibration feature must not be used when the analog input and PDM input are used together for simultaneous conversion.

8.3.6.4 Programmable Digital High-Pass Filter

To remove the DC offset component and attenuate the undesired low-frequency noise content in the record data, the device supports a programmable high-pass filter (HPF). The HPF is not a channel-independent filter setting but is globally applicable for all ADC channels. This HPF is constructed using the first-order infinite impulse response (IIR) filter, and is efficient enough to filter out possible DC components of the signal. Table 16 shows the predefined –3-dB cutoff frequencies available that can be set by using the HPF_SEL[1:0] register bits of P0_R107. Additionally, to achieve a custom –3-dB cutoff frequency for a specific application, the device also allows the first-order IIR filter coefficients to be programmed when the HPF_SEL[1:0] register bits are set to 2'b00. Figure 39 illustrates a frequency response plot for the HPF filter.

Table 16. HPF Programmable Settings

P0_R107_D[1:0] : HPF_SEL[1:0]	-3-dB CUTOFF FREQUENCY SETTING	-3-dB CUTOFF FREQUENCY AT 16-kHz SAMPLE RATE	-3-dB CUTOFF FREQUENCY AT 48-kHz SAMPLE RATE
00	Programmable 1st-order IIR filter	Programmable 1st-order IIR filter	Programmable 1st-order IIR filter
01 (default)	$0.00025 \times f_s$	4 Hz	12 Hz
10	$0.002 \times f_s$	32 Hz	96 Hz
11	$0.008 \times f_s$	128 Hz	384 Hz

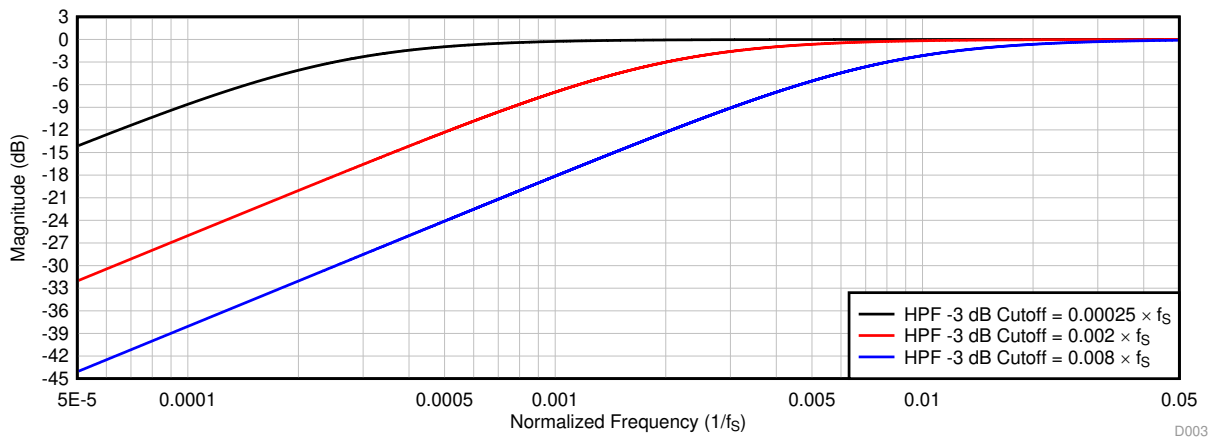

Figure 39. HPF Filter Frequency Response Plot

Equation 1 gives the transfer function for the first-order programmable IIR filter:

$$H(z) = \frac{N_0 + N_1 z^{-1}}{2^{31} - D_1 z^{-1}} \quad (1)$$

The frequency response for this first-order programmable IIR filter with default coefficients is flat at a gain of 0 dB (all-pass filter). The host device can override the frequency response by programming the IIR coefficients in Table 17 to achieve the desired frequency response for high-pass filtering or any other desired filtering. If HPF_SEL[1:0] are set to 2'b00, the host device must write these coefficients values for the desired frequency response before powering-up any ADC channel for recording. Table 17 shows the filter coefficients for the first-order IIR filter.

Table 17. 1st-Order IIR Filter Coefficients

FILTER	FILTER COEFFICIENT	DEFAULT COEFFICIENT VALUE	COEFFICIENT REGISTER MAPPING
Programmable 1st-order IIR filter (can be allocated to HPF or any other desired filter)	N_0	0x7FFFFFFF	P4_R72-R75
	N_1	0x00000000	P4_R76-R79
	D_1	0x00000000	P4_R80-R83

8.3.6.5 Programmable Digital Biquad Filters

The device supports up to 12 programmable digital biquad filters. These highly efficient filters achieve the desired frequency response. In digital signal processing, a digital biquad filter is a second-order, recursive linear filter with two poles and two zeros. Equation 2 gives the transfer function of each biquad filter:

$$H(z) = \frac{N_0 + 2N_1z^{-1} + N_2z^{-2}}{2^{31} - 2D_1z^{-1} - D_2z^{-2}} \tag{2}$$

The frequency response for the biquad filter section with default coefficients is flat at a gain of 0 dB (all-pass filter). The host device can override the frequency response by programming the biquad coefficients to achieve the desired frequency response for a low-pass, high-pass, or any other desired frequency shaping. The programmable coefficients for the mixer operation are located in the [Programmable Coefficient Registers: Page = 0x02](#) and [Programmable Coefficient Registers: Page = 0x03](#) sections. If biquad filtering is required, then the host device must write these coefficients values before powering up any ADC channels for recording. As described in [Table 18](#), these biquad filters can be allocated for each output channel based on the BIQUAD_CFG[1:0] register setting of P0_R108. By setting BIQUAD_CFG[1:0] to 2'b00, the biquad filtering for all record channels is disabled and the host device can choose this setting if no additional filtering is required for the system application. See the [TLV320ADCx140 Programmable Biquad Filter Configuration and Applications application report](#) for further details.

Table 18. Biquad Filter Allocation to the Record Output Channel

PROGRAMMABLE BIQUAD FILTER	RECORD OUTPUT CHANNEL ALLOCATION USING P0_R108_D[6:5] REGISTER SETTING		
	BIQUAD_CFG[1:0] = 2'b01 (1 Biquad per Channel)	BIQUAD_CFG[1:0] = 2'b10 (Default) (2 Biquads per Channel)	BIQUAD_CFG[1:0] = 2'b11 (3 Biquads per Channel)
	SUPPORTS ALL 8 CHANNELS	SUPPORTS UP TO 6 CHANNELS	SUPPORTS UP TO 4 CHANNELS
Biquad filter 1	Allocated to output channel 1	Allocated to output channel 1	Allocated to output channel 1
Biquad filter 2	Allocated to output channel 2	Allocated to output channel 2	Allocated to output channel 2
Biquad filter 3	Allocated to output channel 3	Allocated to output channel 3	Allocated to output channel 3
Biquad filter 4	Allocated to output channel 4	Allocated to output channel 4	Allocated to output channel 4
Biquad filter 5	Not used	Allocated to output channel 1	Allocated to output channel 1
Biquad filter 6	Not used	Allocated to output channel 2	Allocated to output channel 2
Biquad filter 7	Not used	Allocated to output channel 3	Allocated to output channel 3
Biquad filter 8	Not used	Allocated to output channel 4	Allocated to output channel 4
Biquad filter 9	Allocated to output channel 5	Allocated to output channel 5	Allocated to output channel 1
Biquad filter 10	Allocated to output channel 6	Allocated to output channel 6	Allocated to output channel 2
Biquad filter 11	Allocated to output channel 7	Allocated to output channel 5	Allocated to output channel 3
Biquad filter 12	Allocated to output channel 8	Allocated to output channel 6	Allocated to output channel 4

Table 19 shows the biquad filter coefficients mapping to the register space.

Table 19. Biquad Filter Coefficients Register Mapping

PROGRAMMABLE BIQUAD FILTER	BIQUAD FILTER COEFFICIENTS REGISTER MAPPING	PROGRAMMABLE BIQUAD FILTER	BIQUAD FILTER COEFFICIENTS REGISTER MAPPING
Biquad filter 1	P2_R8-R27	Biquad filter 7	P3_R8-R27
Biquad filter 2	P2_R28-R47	Biquad filter 8	P3_R28-R47
Biquad filter 3	P2_R48-R67	Biquad filter 9	P3_R48-R67
Biquad filter 4	P2_R68-R87	Biquad filter 10	P3_R68-R87
Biquad filter 5	P2_R88-R107	Biquad filter 11	P3_R88-R107
Biquad filter 6	P2_R108-R127	Biquad filter 12	P3_R108-R127

8.3.6.6 Programmable Channel Summer and Digital Mixer

For applications that require an even higher SNR than that supported for each channel, the device digital summing mode can be used. In this mode, the digital record data are summed up across the channel with an equal weightage factor, which helps in reducing the effective record noise. Table 20 lists the configuration settings available for channel summing mode.

Table 20. Channel Summing Mode Programmable Settings

P0_R107_D[3:2] : CH_SUM[2:0]	CHANNEL SUMMING MODE FOR INPUT CHANNELS	SNR AND DYNAMIC RANGE BOOST
00 (Default)	Channel summing mode is disabled	Not applicable
01	Output channel 1 = (input channel 1 + input channel 2) / 2	Around 3-dB boost in SNR and dynamic range
	Output channel 2 = (input channel 1 + input channel 2) / 2	
	Output channel 3 = (input channel 3 + input channel 4) / 2	
	Output channel 4 = (input channel 3 + input channel 4) / 2	
	Output channel 5 = (input channel 5 + input channel 6) / 2	
	Output channel 6 = (input channel 5 + input channel 6) / 2	
10	Output channel 1 = (input channel 1 + input channel 2 + input channel 3 + input channel 4) / 4	Around 6-dB boost in SNR and dynamic range
	Output channel 2 = (input channel 1 + input channel 2 + input channel 3 + input channel 4) / 4	
	Output channel 3 = (input channel 1 + input channel 2 + input channel 3 + input channel 4) / 4	
	Output channel 4 = (input channel 1 + input channel 2 + input channel 3 + input channel 4) / 4	
11	Reserved (do not use this setting)	Not applicable

The device additionally supports a fully programmable mixer feature that can mix the various input channels with their custom programmable scale factor to generate the final output channels. The programmable mixer feature is available only if CH_SUM[2:0] is set to 2'b00. The mixer function is only supported for input channel 1 to channel 4. Figure 40 shows a block diagram that describes the mixer 1 operation to generate output channel 1. The programmable coefficients for the mixer operation are located in the Programmable Coefficient Registers: Page = 0x04 section.

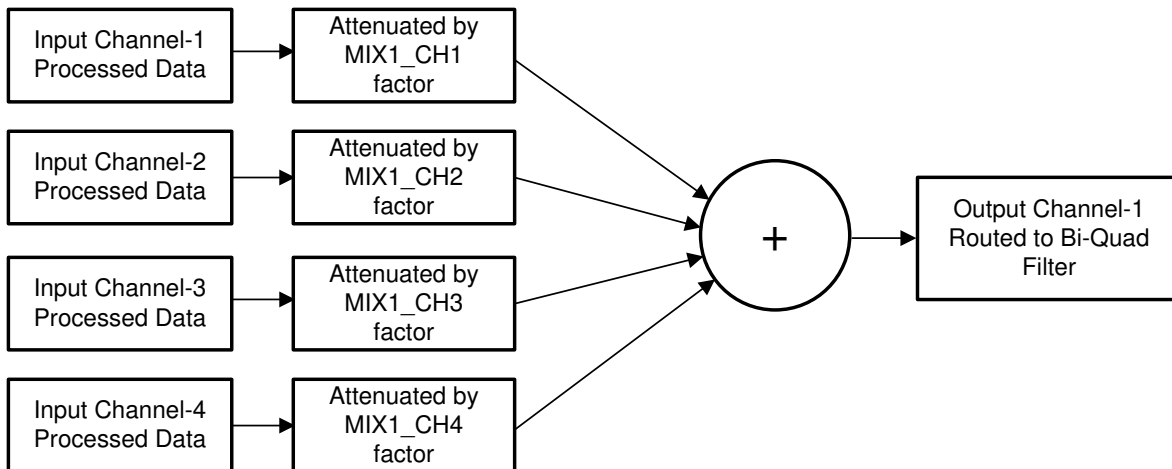

Figure 40. Programmable Digital Mixer Block Diagram

A similar mixer operation is performed by mixer 2, mixer 3, and mixer 4 to generate output channel 2, channel 3, and channel 4, respectively.

8.3.6.7 Configurable Digital Decimation Filters

The device record channel includes a high dynamic range, built-in digital decimation filter to process the oversampled data from the multibit delta-sigma ($\Delta\Sigma$) modulator to generate digital data at the same Nyquist sampling rate as the FSYNC rate. As illustrated in [Figure 38](#), this decimation filter can also be used for processing the oversampled PDM stream from the digital microphone. The decimation filter can be chosen from three different types, depending on the required frequency response, group delay, and phase linearity requirements for the target application. The selection of the decimation filter option can be done by configuring the DECI_FILT, P0_R107_D[5:4] register bits. [Table 21](#) shows the configuration register setting for the decimation filter mode selection for the record channel.

Table 21. Decimation Filter Mode Selection for the Record Channel

P0_R107_D[5:4] : DECI_FILT[1:0]	DECIMATION FILTER MODE SELECTION
00 (default)	Linear phase filters are used for the decimation
01	Low latency filters are used for the decimation
10	Ultra-low latency filters are used for the decimation
11	Reserved (do not use this setting)

8.3.6.7.1 Linear Phase Filters

The linear phase decimation filters are the default filters set by the device and can be used for all applications that require a perfect linear phase with zero-phase deviation within the pass-band specification of the filter. The filter performance specifications and various plots for all supported output sampling rates are listed in this section.

8.3.6.7.1.1 Sampling Rate: 8 kHz or 7.35 kHz

[Figure 41](#) and [Figure 42](#) respectively show the magnitude response and the pass-band ripple for a decimation filter with a sampling rate of 8 kHz or 7.35 kHz. [Table 22](#) lists the specifications for a decimation filter with an 8-kHz or 7.35-kHz sampling rate.

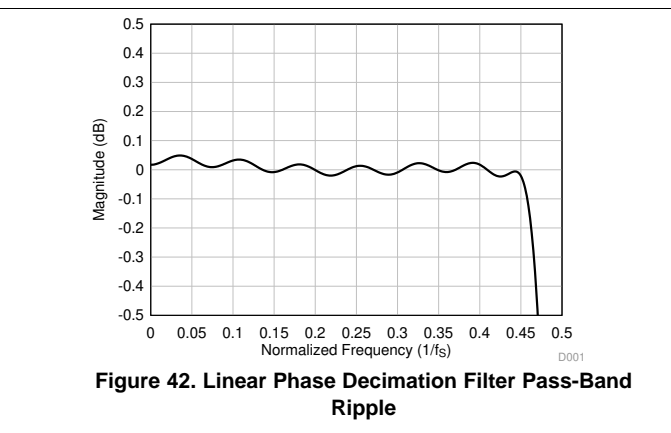
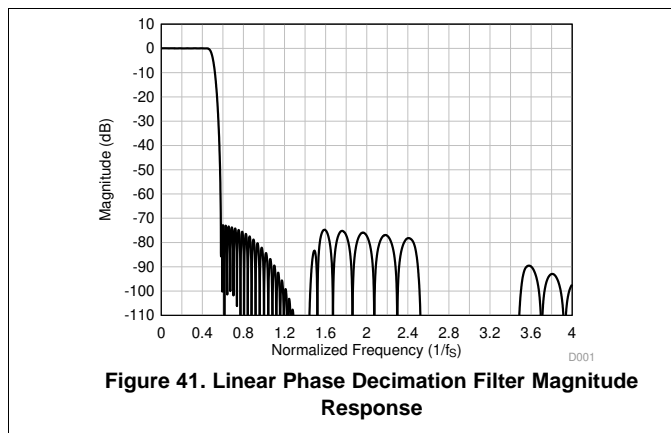

Table 22. Linear Phase Decimation Filter Specifications

PARAMETER	TEST CONDITIONS	MIN	TYP	MAX	UNIT
Pass-band ripple	Frequency range is 0 to $0.454 \times f_s$	-0.05		0.05	dB
Stop-band attenuation	Frequency range is $0.58 \times f_s$ to $4 \times f_s$	72.7			dB
	Frequency range is $4 \times f_s$ onwards	81.2			
Group delay or latency	Frequency range is 0 to $0.454 \times f_s$		17.1		$1/f_s$

8.3.6.7.1.2 Sampling Rate: 16 kHz or 14.7 kHz

Figure 43 and Figure 44 respectively show the magnitude response and the pass-band ripple for a decimation filter with a sampling rate of 16 kHz or 14.7 kHz. Table 23 lists the specifications for a decimation filter with an 16-kHz or 14.7-kHz sampling rate.

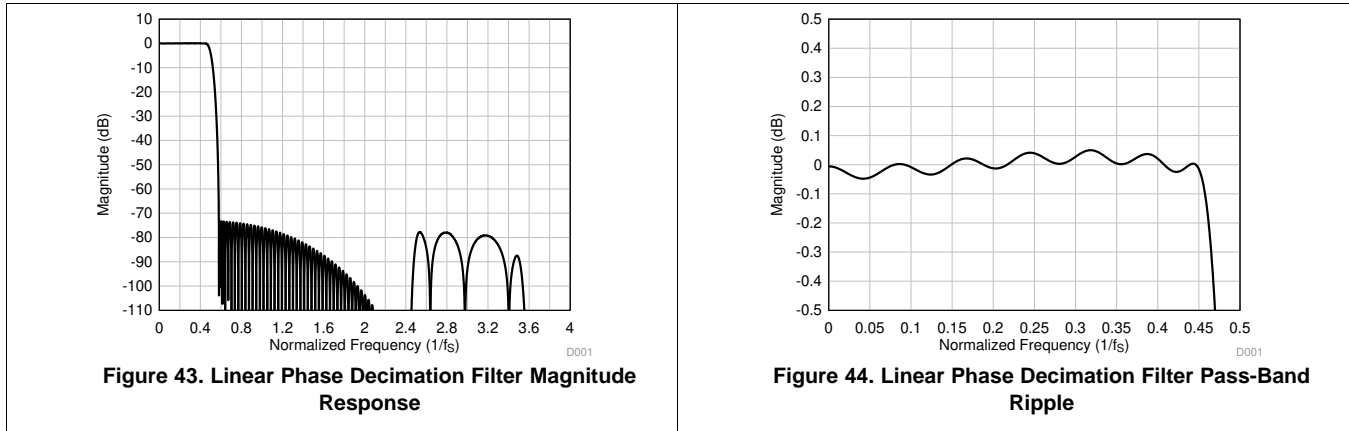

Table 23. Linear Phase Decimation Filter Specifications

PARAMETER	TEST CONDITIONS	MIN	TYP	MAX	UNIT
Pass-band ripple	Frequency range is 0 to $0.454 \times f_s$	-0.05		0.05	dB
Stop-band attenuation	Frequency range is $0.58 \times f_s$ to $4 \times f_s$	73.3			
	Frequency range is $4 \times f_s$ onwards	95.0			
Group delay or latency	Frequency range is 0 to $0.454 \times f_s$		15.7		$1/f_s$

8.3.6.7.1.3 Sampling Rate: 24 kHz or 22.05 kHz

Figure 45 and Figure 46 respectively show the magnitude response and the pass-band ripple for a decimation filter with a sampling rate of 24 kHz or 22.05 kHz. Table 24 lists the specifications for a decimation filter with an 24-kHz or 22.05-kHz sampling rate.

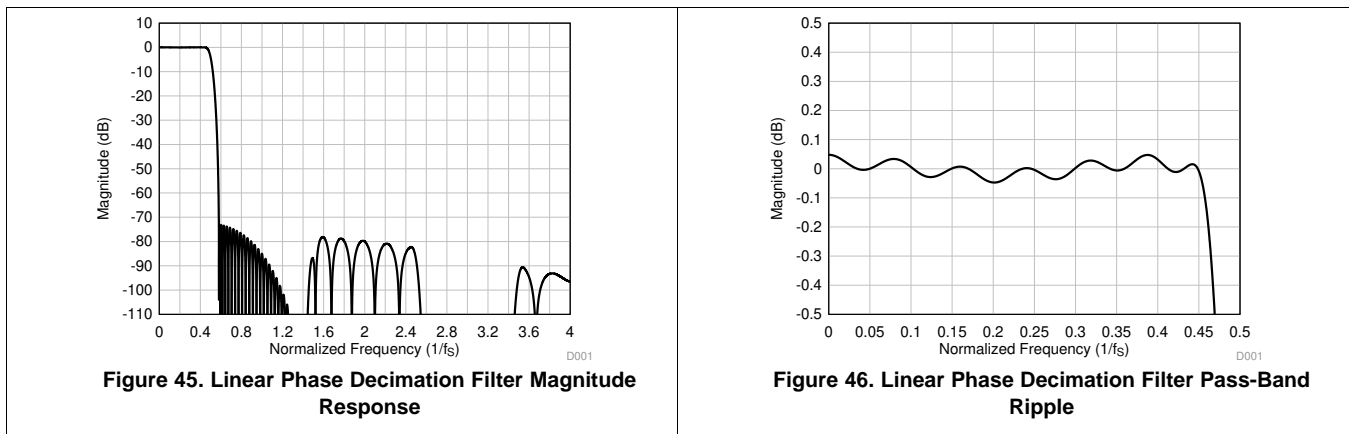

Table 24. Linear Phase Decimation Filter Specifications

PARAMETER	TEST CONDITIONS	MIN	TYP	MAX	UNIT
Pass-band ripple	Frequency range is 0 to $0.454 \times f_s$	-0.05		0.05	dB
Stop-band attenuation	Frequency range is $0.58 \times f_s$ to $4 \times f_s$	73.0			
	Frequency range is $4 \times f_s$ onwards	96.4			
Group delay or latency	Frequency range is 0 to $0.454 \times f_s$		16.6		$1/f_s$

8.3.6.7.1.4 Sampling Rate: 32 kHz or 29.4 kHz

Figure 47 and Figure 48 respectively show the magnitude response and the pass-band ripple for a decimation filter with a sampling rate of 32 kHz or 29.4 kHz. Table 25 lists the specifications for a decimation filter with an 32-kHz or 29.4-kHz sampling rate.

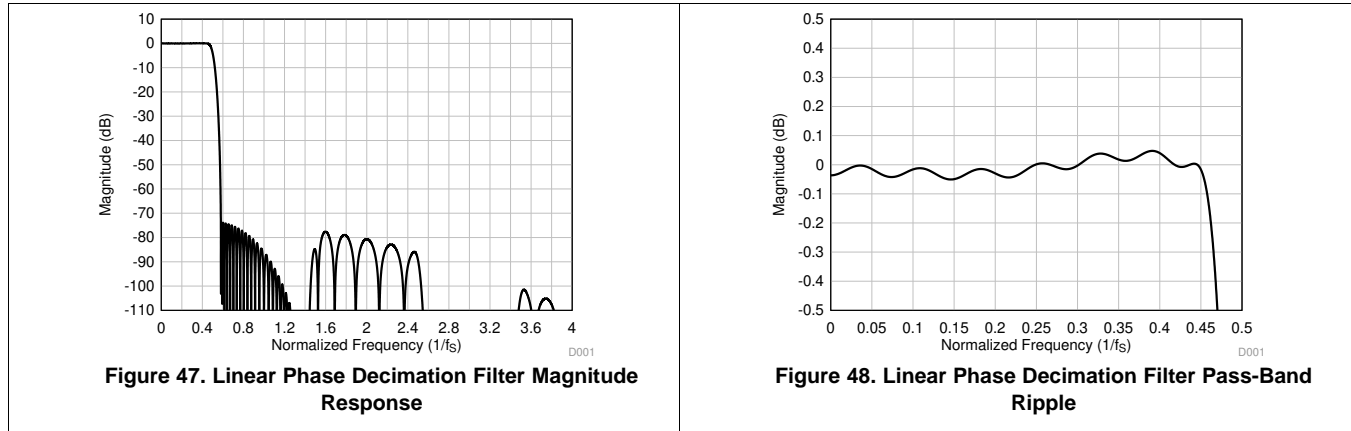

Table 25. Linear Phase Decimation Filter Specifications

PARAMETER	TEST CONDITIONS	MIN	TYP	MAX	UNIT
Pass-band ripple	Frequency range is 0 to $0.454 \times f_s$	-0.05		0.05	dB
Stop-band attenuation	Frequency range is $0.58 \times f_s$ to $4 \times f_s$	73.7			
	Frequency range is $4 \times f_s$ onwards	107.2			
Group delay or latency	Frequency range is 0 to $0.454 \times f_s$		16.9		$1/f_s$

8.3.6.7.1.5 Sampling Rate: 48 kHz or 44.1 kHz

Figure 49 and Figure 50 respectively show the magnitude response and the pass-band ripple for a decimation filter with a sampling rate of 48 kHz or 44.1 kHz. Table 26 lists the specifications for a decimation filter with an 48-kHz or 44.1-kHz sampling rate.

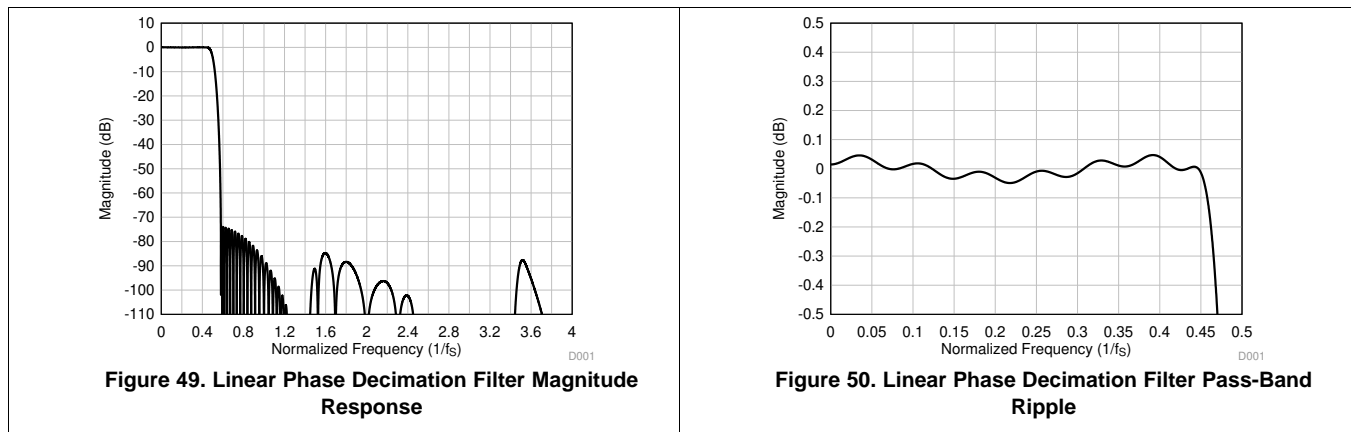

Table 26. Linear Phase Decimation Filter Specifications

PARAMETER	TEST CONDITIONS	MIN	TYP	MAX	UNIT
Pass-band ripple	Frequency range is 0 to $0.454 \times f_s$	-0.05		0.05	dB
Stop-band attenuation	Frequency range is $0.58 \times f_s$ to $4 \times f_s$	73.8			
	Frequency range is $4 \times f_s$ onwards	98.1			
Group delay or latency	Frequency range is 0 to $0.454 \times f_s$		17.1		$1/f_s$

8.3.6.7.1.6 Sampling Rate: 96 kHz or 88.2 kHz

Figure 51 and Figure 52 respectively show the magnitude response and the pass-band ripple for a decimation filter with a sampling rate of 96 kHz or 88.2 kHz. Table 27 lists the specifications for a decimation filter with an 96-kHz or 88.2-kHz sampling rate.

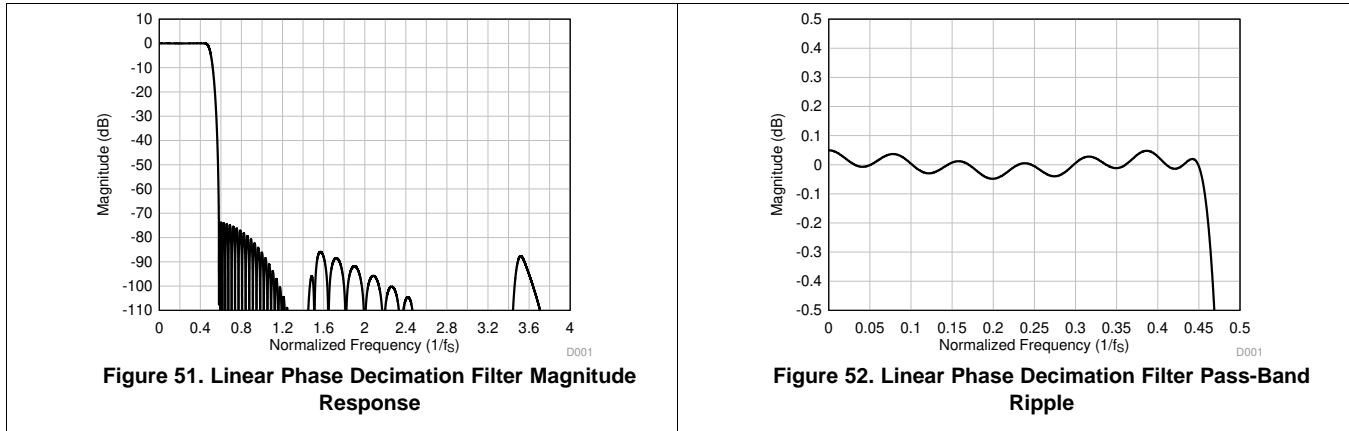

Table 27. Linear Phase Decimation Filter Specifications

PARAMETER	TEST CONDITIONS	MIN	TYP	MAX	UNIT
Pass-band ripple	Frequency range is 0 to $0.454 \times f_s$	-0.05		0.05	dB
Stop-band attenuation	Frequency range is $0.58 \times f_s$ to $4 \times f_s$	73.6			
	Frequency range is $4 \times f_s$ onwards	97.9			
Group delay or latency	Frequency range is 0 to $0.454 \times f_s$		17.1		$1/f_s$

8.3.6.7.1.7 Sampling Rate: 192 kHz or 176.4 kHz

Figure 53 and Figure 54 respectively show the magnitude response and the pass-band ripple for a decimation filter with a sampling rate of 192 kHz or 176.4 kHz. Table 28 lists the specifications for a decimation filter with an 192-kHz or 176.4-kHz sampling rate.

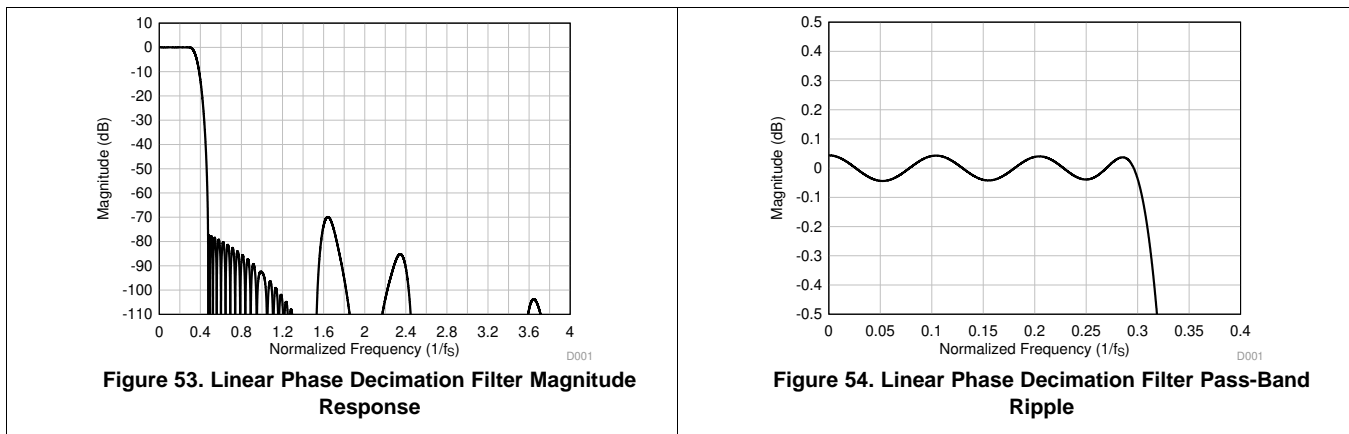

Table 28. Linear Phase Decimation Filter Specifications

PARAMETER	TEST CONDITIONS	MIN	TYP	MAX	UNIT
Pass-band ripple	Frequency range is 0 to $0.3 \times f_s$	-0.05		0.05	dB
Stop-band attenuation	Frequency range is $0.473 \times f_s$ to $4 \times f_s$	70.0			
	Frequency range is $4 \times f_s$ onwards	111.0			
Group delay or latency	Frequency range is 0 to $0.3 \times f_s$		11.9		$1/f_s$

8.3.6.7.1.8 Sampling Rate: 384 kHz or 352.8 kHz

Figure 55 and Figure 56 respectively show the magnitude response and the pass-band ripple for a decimation filter with a sampling rate of 384 kHz or 352.8 kHz. Table 29 lists the specifications for a decimation filter with an 384-kHz or 352.8-kHz sampling rate.

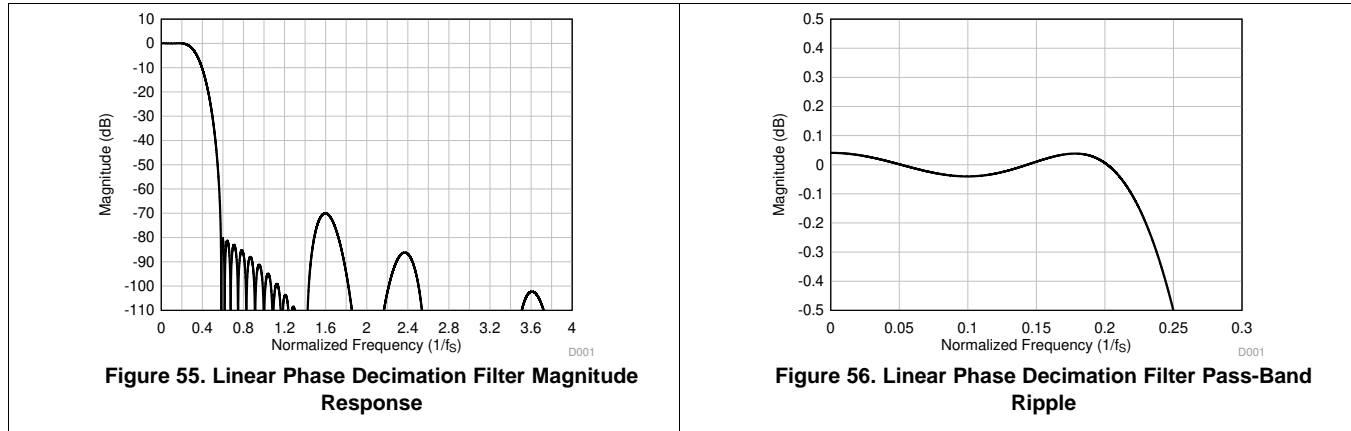

Table 29. Linear Phase Decimation Filter Specifications

PARAMETER	TEST CONDITIONS	MIN	TYP	MAX	UNIT
Pass-band ripple	Frequency range is 0 to $0.212 \times f_s$	-0.05		0.05	dB
Stop-band attenuation	Frequency range is $0.58 \times f_s$ to $4 \times f_s$	70.0			dB
	Frequency range is $4 \times f_s$ onwards	108.8			
Group delay or latency	Frequency range is 0 to $0.212 \times f_s$		7.2		$1/f_s$

8.3.6.7.1.9 Sampling Rate 768 kHz or 705.6 kHz

Figure 57 and Figure 58 respectively show the magnitude response and the pass-band ripple for a decimation filter with a sampling rate of 768 kHz or 705.6 kHz. Table 30 lists the specifications for a decimation filter with an 768-kHz or 705.6-kHz sampling rate.

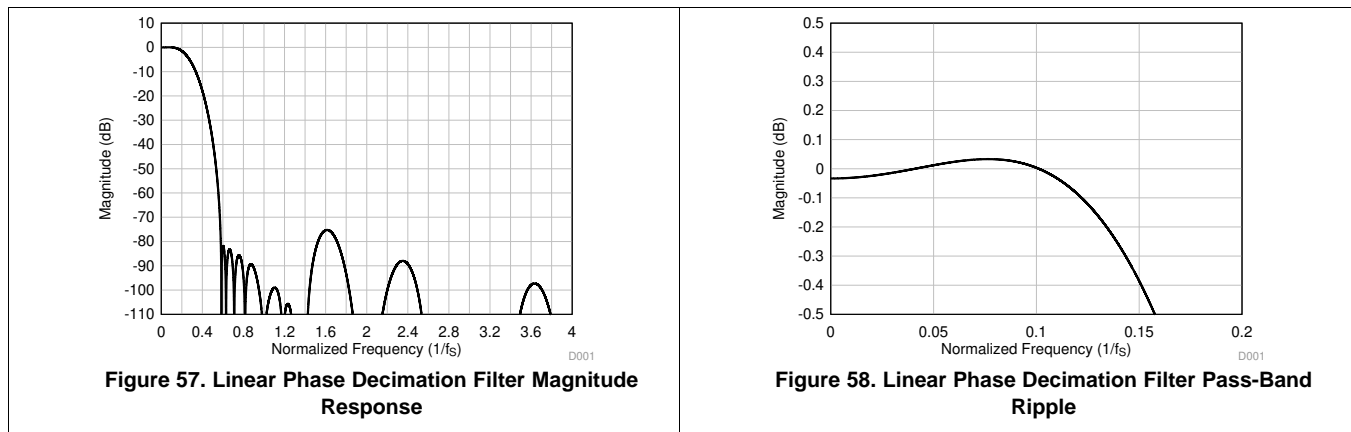

Table 30. Linear Phase Decimation Filter Specifications

PARAMETER	TEST CONDITIONS	MIN	TYP	MAX	UNIT
Pass-band ripple	Frequency range is 0 to $0.113 \times f_s$	-0.05		0.05	dB
Stop-band attenuation	Frequency range is $0.58 \times f_s$ to $2 \times f_s$	75.0			dB
	Frequency range is $2 \times f_s$ onwards	88.0			
Group Delay or Latency	Frequency range is 0 to $0.113 \times f_s$		$5.9 \times f_s$		$1/f_s$

8.3.6.7.2 Low-Latency Filters

For applications where low latency with minimal phase deviation (within the audio band) is critical, the low-latency decimation filters on the TLV320ADC6140 can be used. The device supports these filters with a group delay of approximately seven samples with an almost linear phase response within the $0.365 \times f_s$ frequency band. This section provides the filter performance specifications and various plots for all supported output sampling rates for the low-latency filters.

8.3.6.7.2.1 Sampling Rate: 16 kHz or 14.7 kHz

Figure 59 shows the magnitude response and Figure 60 shows the pass-band ripple and phase deviation for a decimation filter with a sampling rate of 16 kHz or 14.7 kHz. Table 31 lists the specifications for a decimation filter with a 16-kHz or 14.7-kHz sampling rate.

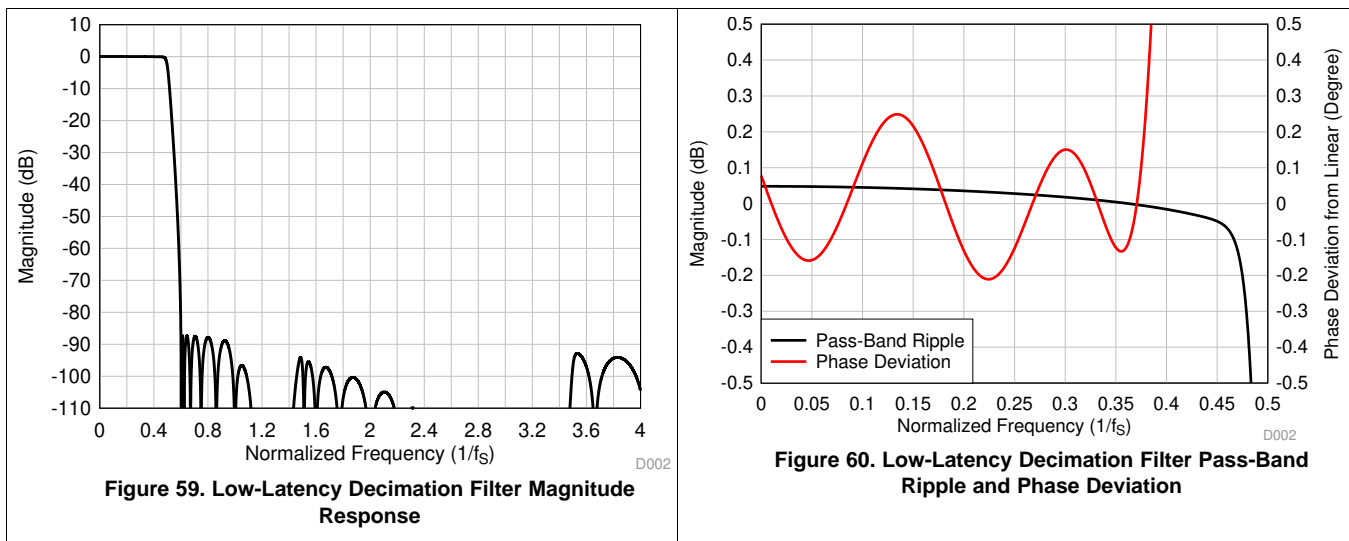

Table 31. Low-Latency Decimation Filter Specifications

PARAMETER	TEST CONDITIONS	MIN	TYP	MAX	UNIT
Pass-band ripple	Frequency range is 0 to $0.451 \times f_s$	-0.05		0.05	dB
Stop-band attenuation	Frequency range is $0.61 \times f_s$ onwards	87.3			dB
Group delay or latency	Frequency range is 0 to $0.363 \times f_s$		7.6		$1/f_s$
Group delay deviation	Frequency range is 0 to $0.363 \times f_s$	-0.022		0.022	$1/f_s$
Phase deviation	Frequency range is 0 to $0.363 \times f_s$	-0.21		0.25	Degrees

8.3.6.7.2.2 Sampling Rate: 24 kHz or 22.05 kHz

Figure 61 shows the magnitude response and Figure 62 shows the pass-band ripple and phase deviation for a decimation filter with a sampling rate of 24 kHz or 22.05 kHz. Table 32 lists the specifications for a decimation filter with a 24-kHz or 22.05-kHz sampling rate.

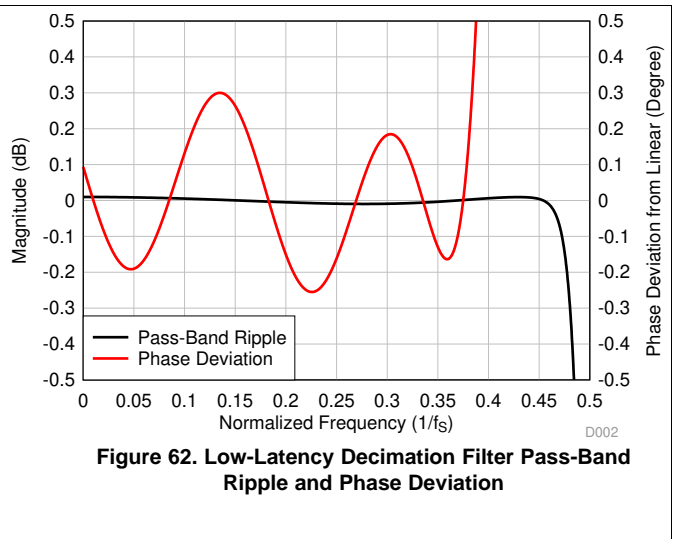
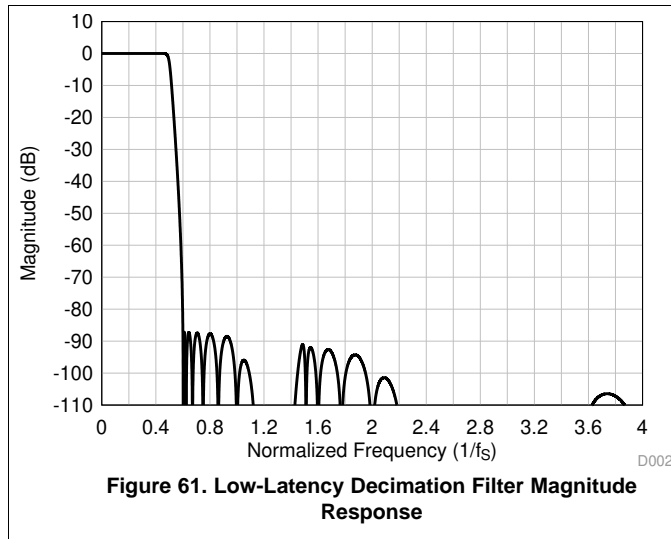

Table 32. Low-Latency Decimation Filter Specifications

PARAMETER	TEST CONDITIONS	MIN	TYP	MAX	UNIT
Pass-band ripple	Frequency range is 0 to $0.459 \times f_s$	-0.01		0.01	dB
Stop-band attenuation	Frequency range is $0.6 \times f_s$ onwards	87.2			dB
Group delay or latency	Frequency range is 0 to $0.365 \times f_s$		7.5		$1/f_s$
Group delay deviation	Frequency range is 0 to $0.365 \times f_s$	-0.026		0.026	$1/f_s$
Phase deviation	Frequency range is 0 to $0.365 \times f_s$	-0.26		0.30	Degrees

8.3.6.7.2.3 Sampling Rate: 32 kHz or 29.4 kHz

Figure 63 shows the magnitude response and Figure 64 shows the pass-band ripple and phase deviation for a decimation filter with a sampling rate of 32 kHz or 29.4 kHz. Table 33 lists the specifications for a decimation filter with a 32-kHz or 29.4-kHz sampling rate.

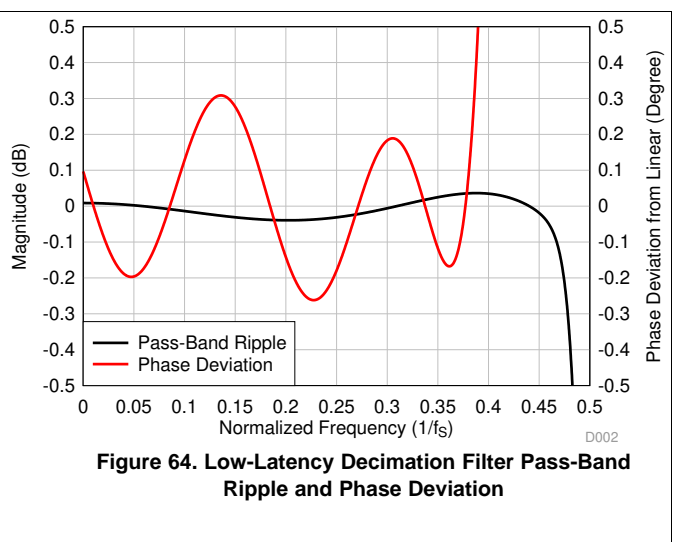
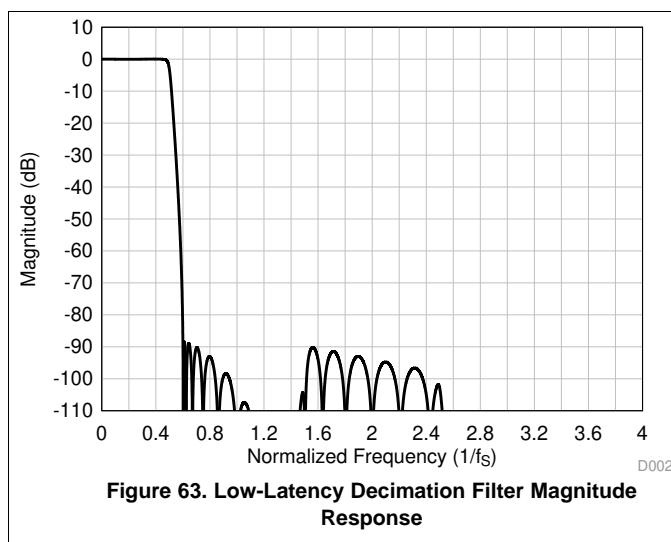

Table 33. Low-Latency Decimation Filter Specifications

PARAMETER	TEST CONDITIONS	MIN	TYP	MAX	UNIT
Pass-band ripple	Frequency range is 0 to $0.457 \times f_S$	-0.04		0.04	dB
Stop-band attenuation	Frequency range is $0.6 \times f_S$ onwards	88.3			dB
Group delay or latency	Frequency range is 0 to $0.368 \times f_S$		8.7		$1/f_S$
Group delay deviation	Frequency range is 0 to $0.368 \times f_S$	-0.026		0.026	$1/f_S$
Phase deviation	Frequency range is 0 to $0.368 \times f_S$	-0.26		0.31	Degrees

8.3.6.7.2.4 Sampling Rate: 48 kHz or 44.1 kHz

Figure 65 shows the magnitude response and Figure 66 shows the pass-band ripple and phase deviation for a decimation filter with a sampling rate of 48 kHz or 44.1 kHz. Table 34 lists the specifications for a decimation filter with a 48-kHz or 44.1-kHz sampling rate.

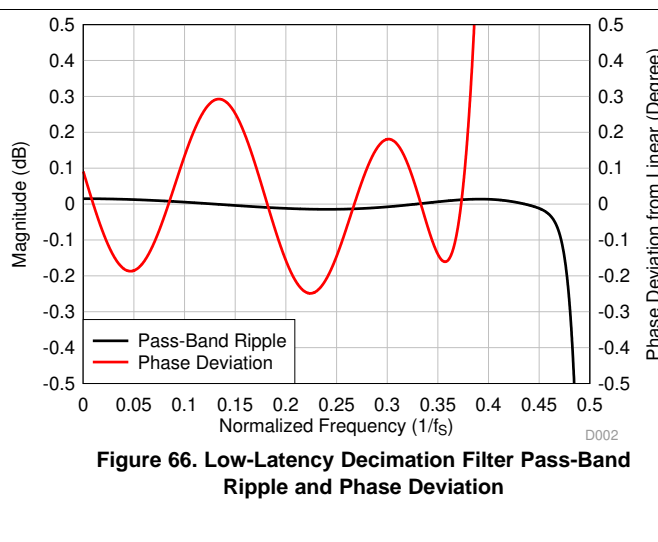
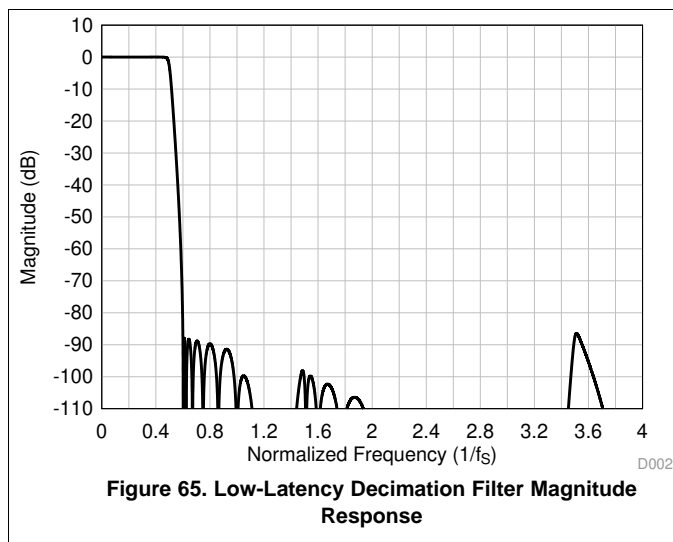

Table 34. Low-Latency Decimation Filter Specifications

PARAMETER	TEST CONDITIONS	MIN	TYP	MAX	UNIT
Pass-band ripple	Frequency range is 0 to $0.452 \times f_S$	-0.015		0.015	dB
Stop-band attenuation	Frequency range is $0.6 \times f_S$ onwards	86.4			dB
Group delay or latency	Frequency range is 0 to $0.365 \times f_S$		7.7		$1/f_S$
Group delay deviation	Frequency range is 0 to $0.365 \times f_S$	-0.027		0.027	$1/f_S$
Phase deviation	Frequency range is 0 to $0.365 \times f_S$	-0.25		0.30	Degrees

8.3.6.7.2.5 Sampling Rate: 96 kHz or 88.2 kHz

Figure 67 shows the magnitude response and Figure 68 shows the pass-band ripple and phase deviation for a decimation filter with a sampling rate of 96 kHz or 88.2 kHz. Table 35 lists the specifications for a decimation filter with a 96-kHz or 88.2-kHz sampling rate.

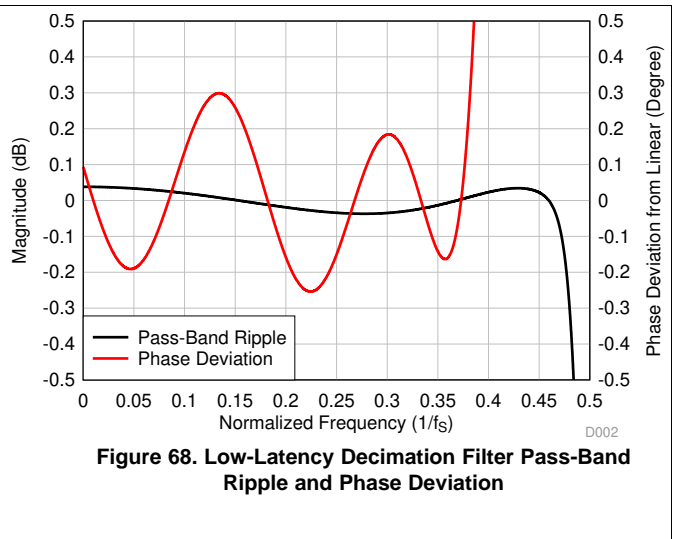
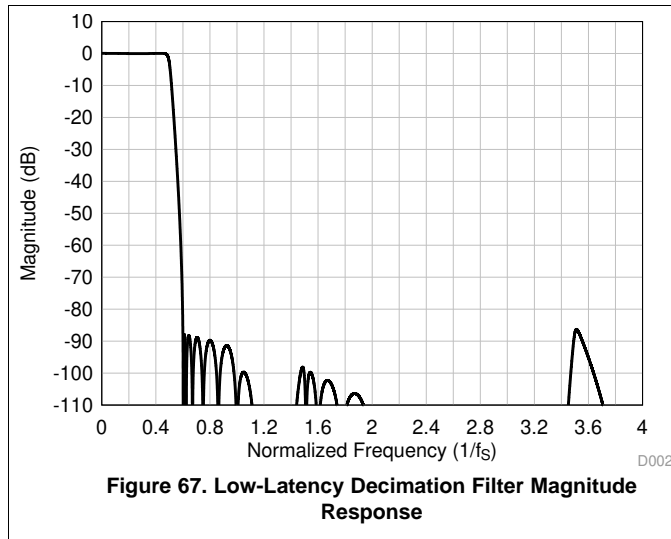

Table 35. Low-Latency Decimation Filter Specifications

PARAMETER	TEST CONDITIONS	MIN	TYP	MAX	UNIT
Pass-band ripple	Frequency range is 0 to $0.466 \times f_s$	-0.04		0.04	dB
Stop-band attenuation	Frequency range is $0.6 \times f_s$ onwards	86.3			dB
Group delay or latency	Frequency range is 0 to $0.365 \times f_s$		7.7		$1/f_s$
Group delay deviation	Frequency range is 0 to $0.365 \times f_s$	-0.027		0.027	$1/f_s$
Phase deviation	Frequency range is 0 to $0.365 \times f_s$	-0.26		0.30	Degrees

8.3.6.7.2.6 Sampling Rate 192 kHz or 176.4 kHz

Figure 69 shows the magnitude response and Figure 70 shows the pass-band ripple and phase deviation for a decimation filter with a sampling rate of 192 kHz or 176.4 kHz. Table 36 lists the specifications for a decimation filter with a 192-kHz or 176.4-kHz sampling rate.

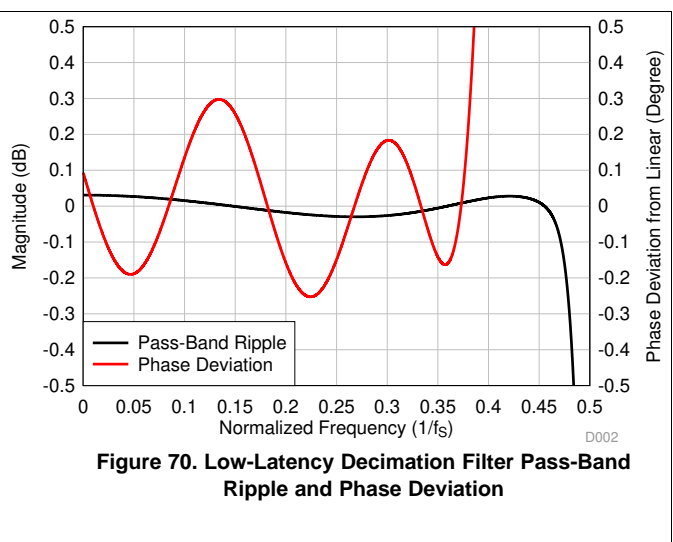
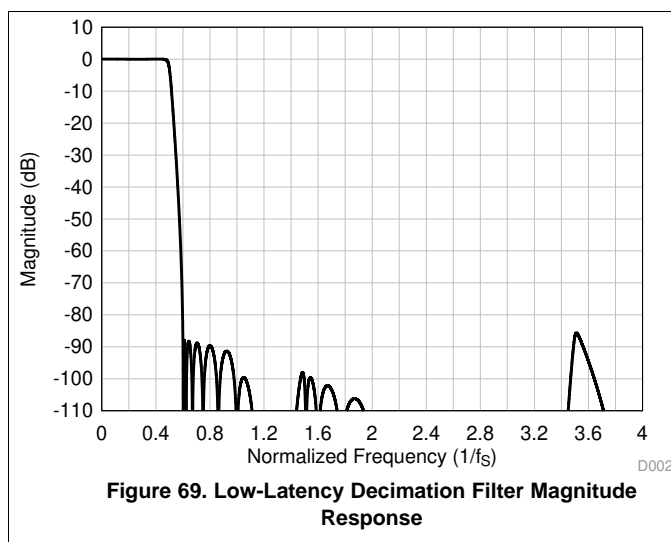

Table 36. Low-Latency Decimation Filter Specifications

PARAMETER	TEST CONDITIONS	MIN	TYP	MAX	UNIT
Pass-band ripple	Frequency range is 0 to $463 \times f_s$	-0.03		0.03	dB
Stop-band attenuation	Frequency range is $0.6 \times f_s$ onwards	85.6			dB
Group delay or latency	Frequency range is 0 to $0.365 \times f_s$		7.7		$1/f_s$
Group delay deviation	Frequency range is 0 to $0.365 \times f_s$	-0.027		0.027	$1/f_s$
Phase deviation	Frequency range is 0 to $0.365 \times f_s$	-0.26		0.30	Degrees

8.3.6.7.3 Ultra-Low-Latency Filters

For applications where ultra-low latency (within the audio band) is critical, the ultra-low-latency decimation filters on the TLV320ADC6140 can be used. The device supports these filters with a group delay of approximately four samples with an almost linear phase response within the $0.325 \times f_s$ frequency band. This section provides the filter performance specifications and various plots for all supported output sampling rates for the ultra-low-latency filters.

8.3.6.7.3.1 Sampling Rate: 16 kHz or 14.7 kHz

Figure 71 shows the magnitude response and Figure 72 shows the pass-band ripple and phase deviation for a decimation filter with a sampling rate of 16 kHz or 14.7 kHz. Table 37 lists the specifications for a decimation filter with a 16-kHz or 14.7-kHz sampling rate.

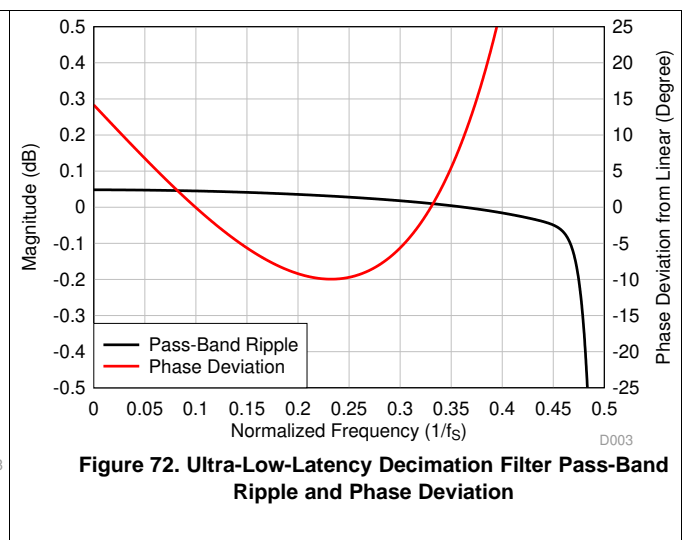
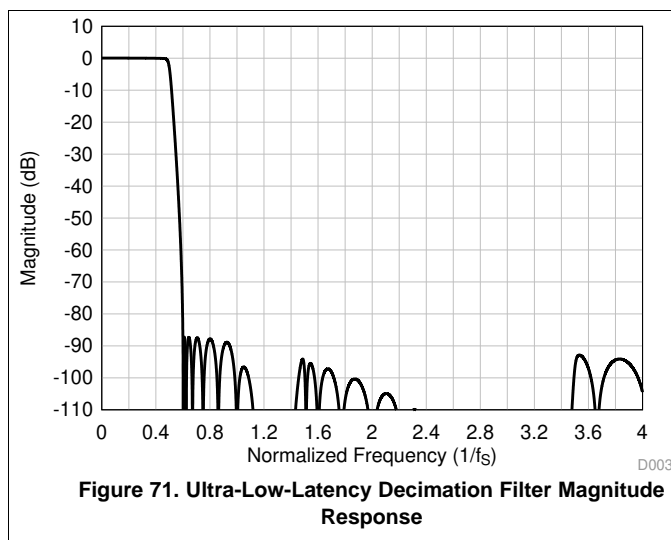

Table 37. Ultra-Low-Latency Decimation Filter Specifications

PARAMETER	TEST CONDITIONS	MIN	TYP	MAX	UNIT
Pass-band ripple	Frequency range is 0 to $0.45 \times f_s$	-0.05		0.05	dB
Stop-band attenuation	Frequency range is $0.6 \times f_s$ onwards	87.2			dB
Group delay or latency	Frequency range is 0 to $0.325 \times f_s$		4.3		$1/f_s$
Group delay deviation	Frequency range is 0 to $0.325 \times f_s$	-0.512		0.512	$1/f_s$
Phase deviation	Frequency range is 0 to $0.325 \times f_s$	-10.0		14.2	Degrees

8.3.6.7.3.2 Sampling Rate: 24 kHz or 22.05 kHz

Figure 73 shows the magnitude response and Figure 74 shows the pass-band ripple and phase deviation for a decimation filter with a sampling rate of 24 kHz or 22.05 kHz. Table 38 lists the specifications for a decimation filter with a 24-kHz or 22.05-kHz sampling rate.

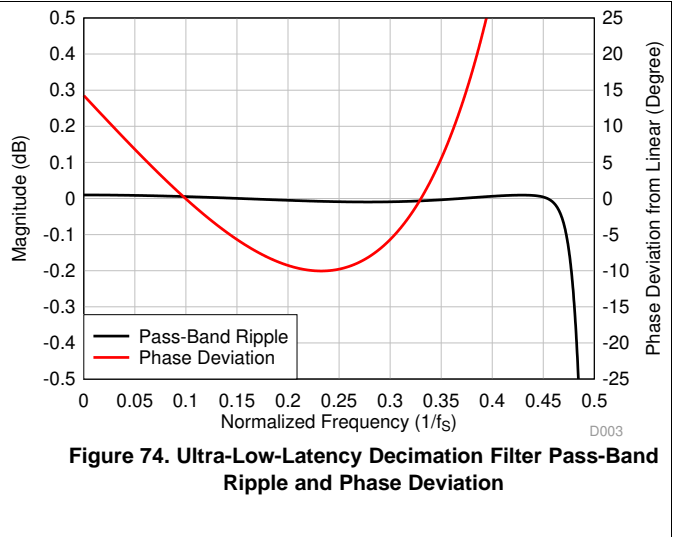
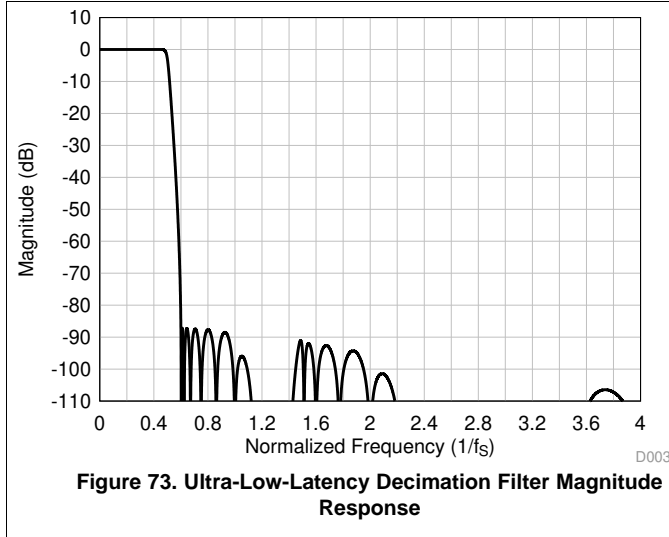

Table 38. Ultra-Low-Latency Decimation Filter Specifications

PARAMETER	TEST CONDITIONS	MIN	TYP	MAX	UNIT
Pass-band ripple	Frequency range is 0 to $0.46 \times f_s$	-0.01		0.01	dB
Stop-band attenuation	Frequency range is $0.6 \times f_s$ onwards	87.1			dB
Group delay or latency	Frequency range is 0 to $0.325 \times f_s$		4.1		$1/f_s$
Group delay deviation	Frequency range is 0 to $0.325 \times f_s$	-0.514		0.514	$1/f_s$
Phase deviation	Frequency range is 0 to $0.325 \times f_s$	-10.0		14.3	Degrees

8.3.6.7.3.3 Sampling Rate: 32 kHz or 29.4 kHz

Figure 75 shows the magnitude response and Figure 76 shows the pass-band ripple and phase deviation for a decimation filter with a sampling rate of 32 kHz or 29.4 kHz. Table 39 lists the specifications for a decimation filter with an 32-kHz or 29.4-kHz sampling rate.

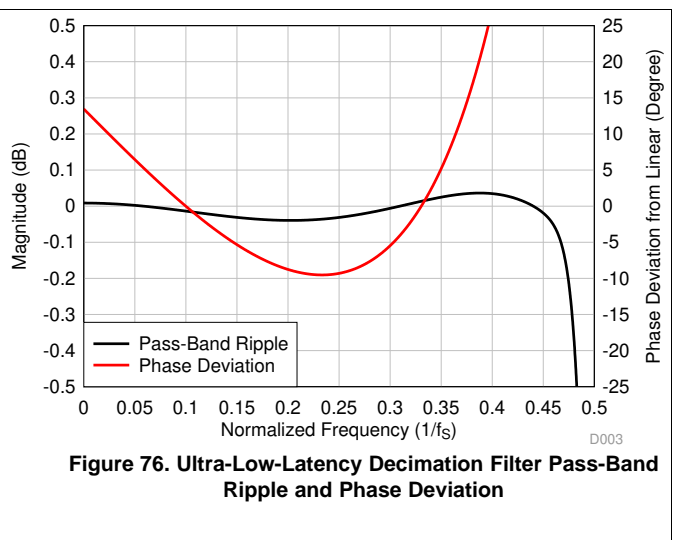
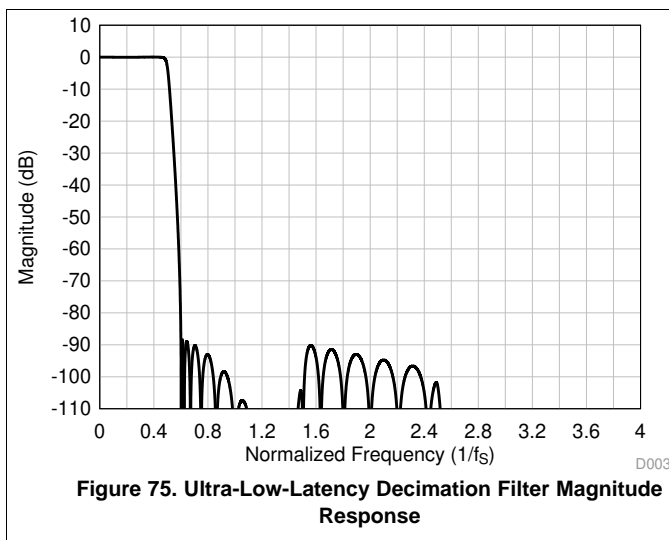

Table 39. Ultra-Low-Latency Decimation Filter Specifications

PARAMETER	TEST CONDITIONS	MIN	TYP	MAX	UNIT
Pass-band ripple	Frequency range is 0 to $0.457 \times f_S$	-0.04		0.04	dB
Stop-band attenuation	Frequency range is $0.6 \times f_S$ onwards	88.3			dB
Group delay or latency	Frequency range is 0 to $0.325 \times f_S$		5.2		$1/f_S$
Group delay deviation	Frequency range is 0 to $0.325 \times f_S$	-0.492		0.492	$1/f_S$
Phase deviation	Frequency range is 0 to $0.325 \times f_S$	-9.5		13.5	Degrees

8.3.6.7.3.4 Sampling Rate: 48 kHz or 44.1 kHz

Figure 77 shows the magnitude response and Figure 78 shows the pass-band ripple and phase deviation for a decimation filter with a sampling rate of 48 kHz or 44.1 kHz. Table 40 lists the specifications for a decimation filter with a 48-kHz or 44.1-kHz sampling rate.

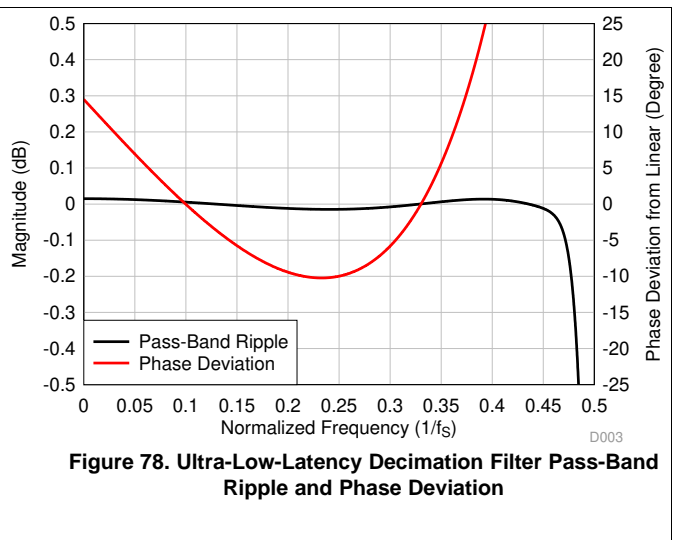
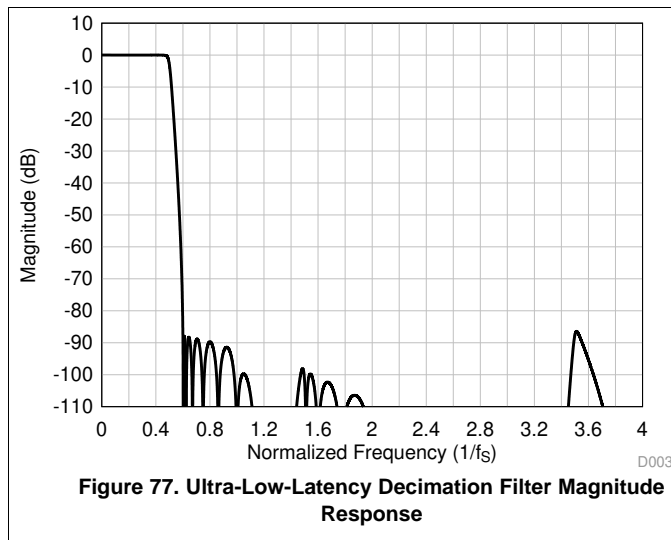

Table 40. Ultra-Low-Latency Decimation Filter Specifications

PARAMETER	TEST CONDITIONS	MIN	TYP	MAX	UNIT
Pass-band ripple	Frequency range is 0 to $0.452 \times f_S$	-0.015		0.015	dB
Stop-band attenuation	Frequency range is $0.6 \times f_S$ onwards	86.4			dB
Group delay or latency	Frequency range is 0 to $0.325 \times f_S$		4.1		$1/f_S$
Group delay deviation	Frequency range is 0 to $0.325 \times f_S$	-0.525		0.525	$1/f_S$
Phase deviation	Frequency range is 0 to $0.325 \times f_S$	-10.3		14.5	Degrees

8.3.6.7.3.5 Sampling Rate: 96 kHz or 88.2 kHz

Figure 79 shows the magnitude response and Figure 80 shows the pass-band ripple and phase deviation for a decimation filter with a sampling rate of 96 kHz or 88.2 kHz. Table 41 lists the specifications for a decimation filter with a 96-kHz or 88.2-kHz sampling rate.

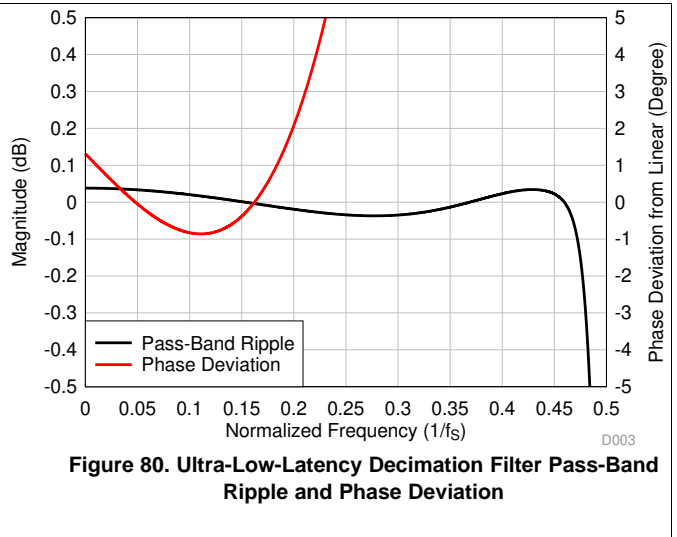
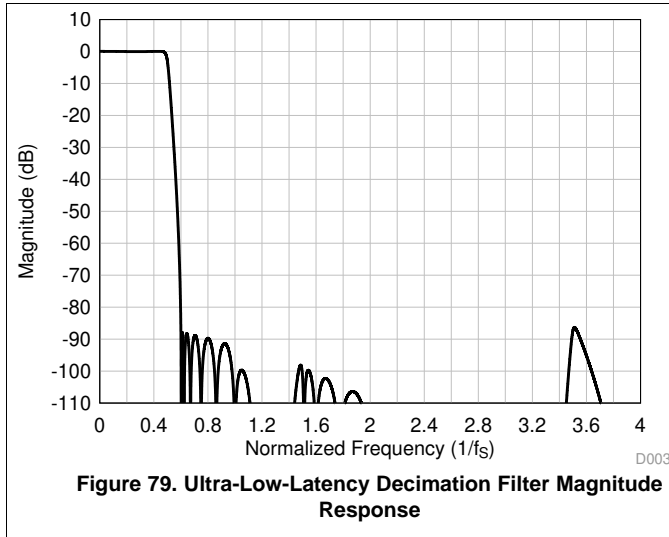

Table 41. Ultra-Low-Latency Decimation Filter Specifications

PARAMETER	TEST CONDITIONS	MIN	TYP	MAX	UNIT
Pass-band ripple	Frequency range is 0 to $0.466 \times f_s$	-0.04		0.04	dB
Stop-band attenuation	Frequency range is $0.6 \times f_s$ onwards	86.3			dB
Group delay or latency	Frequency range is 0 to $0.1625 \times f_s$		3.7		$1/f_s$
Group delay deviation	Frequency range is 0 to $0.1625 \times f_s$	-0.091		0.091	$1/f_s$
Phase deviation	Frequency range is 0 to $0.1625 \times f_s$	-0.86		1.30	Degrees

8.3.6.7.3.6 Sampling Rate 192 kHz or 176.4 kHz

Figure 81 shows the magnitude response and Figure 82 shows the pass-band ripple and phase deviation for a decimation filter with a sampling rate of 192 kHz or 176.4 kHz. Table 42 lists the specifications for a decimation filter with a 192-kHz or 176.4-kHz sampling rate.

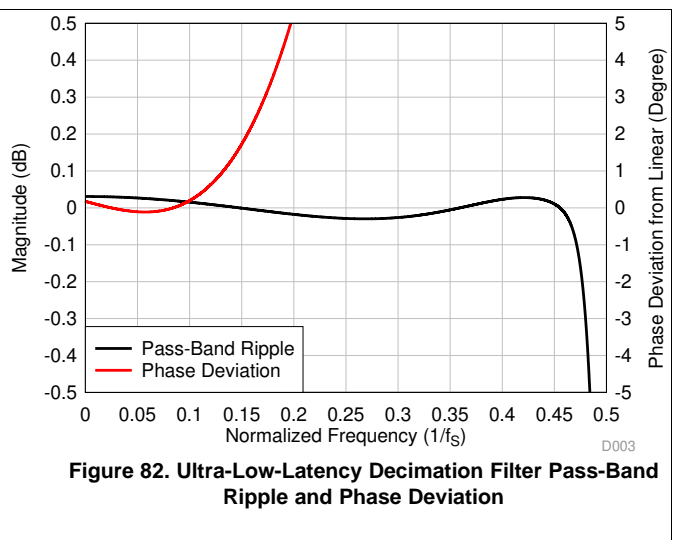
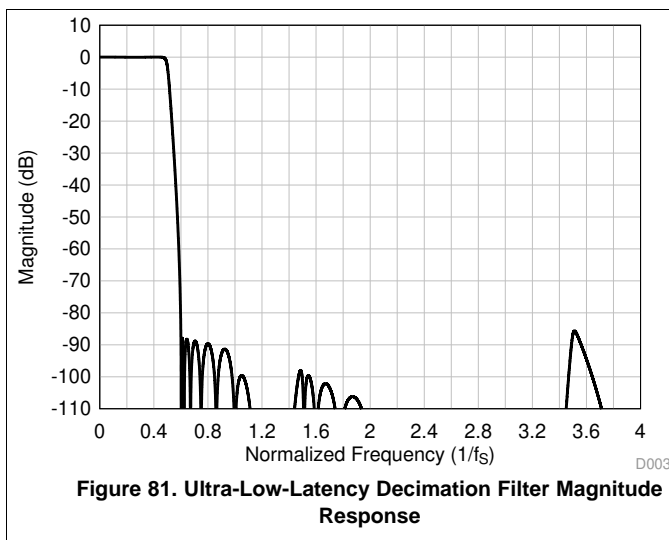

Table 42. Ultra-Low-Latency Decimation Filter Specifications

PARAMETER	TEST CONDITIONS	MIN	TYP	MAX	UNIT
Pass-band ripple	Frequency range is 0 to $0.463 \times f_S$	-0.03		0.03	dB
Stop-band attenuation	Frequency range is $0.6 \times f_S$ onwards	85.6			dB
Group delay or latency	Frequency range is 0 to $0.085 \times f_S$		3.7		$1/f_S$
Group delay deviation	Frequency range is 0 to $0.085 \times f_S$	-0.024		0.024	$1/f_S$
Phase deviation	Frequency range is 0 to $0.085 \times f_S$	-0.12		0.18	Degrees

8.3.6.7.3.7 Sampling Rate 384 kHz or 352.8 kHz

Figure 83 shows the magnitude response and Figure 84 shows the pass-band ripple and phase deviation for a decimation filter with a sampling rate of 384 kHz or 352.8 kHz. Table 43 lists the specifications for a decimation filter with a 384-kHz or 352.8-kHz sampling rate.

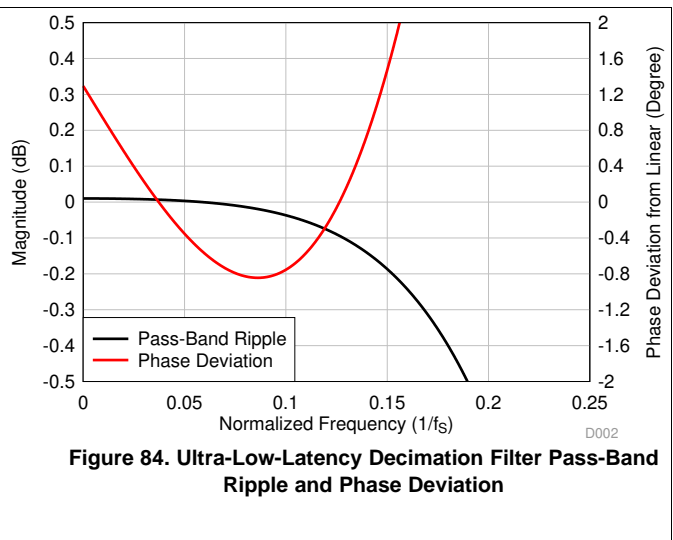
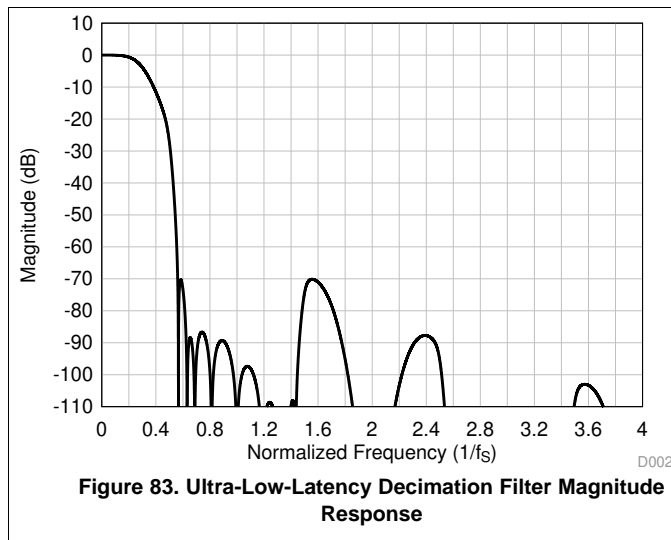

Table 43. Ultra-Low-Latency Decimation Filter Specifications

PARAMETER	TEST CONDITIONS	MIN	TYP	MAX	UNIT
Pass-band ripple	Frequency range is 0 to $0.1 \times f_S$	-0.04		0.01	dB
Stop-band attenuation	Frequency range is $0.56 \times f_S$ onwards	70.1			dB
Group delay or latency	Frequency range is 0 to $0.157 \times f_S$		4.1		$1/f_S$
Group delay deviation	Frequency range is 0 to $0.157 \times f_S$	-0.18		0.18	$1/f_S$
Phase deviation	Frequency range is 0 to $0.157 \times f_S$	-0.85		2.07	Degrees

8.3.7 Dynamic Range Enhancer (DRE)

The device integrates an ultra-low noise front-end PGA with 120-dB dynamic range performance with a low-noise, low-distortion, multibit delta-sigma ($\Delta\Sigma$) ADC with a 108-dB dynamic range. The dynamic range enhancer (DRE) is a digitally assisted algorithm to boost the overall channel performance. The DRE monitors the incoming signal amplitude and accordingly adjusts the internal PGA gain automatically. The DRE achieves a complete-channel dynamic range as high as 120 dB. At a system level, the DRE scheme enables far-field, high-fidelity recording of audio signals in very quiet environments and low-distortion recording in loud environments.

This algorithm is implemented with very low latency and all signal chain blocks are designed to minimize any audible artifacts that may occur resulting from dynamic gain modulation. Additionally, the host can configure the target signal threshold level at which DRE is triggered by setting the appropriate value for the DRE_LVL[3:0], P0_R109[7:4] register bits. The DRE_LVL default level is set to –54 dB and TI recommends setting the DRE_LVL value lower than –30 dB to maximize the benefit of the DRE in real-world applications and to minimize any audible artifacts. [Table 44](#) lists the DRE_LVL configuration settings.

Table 44. DRE Trigger Threshold Level Programmable Settings

P0_R109_D[7:4] : DRE_LVL[3:0]	DRE TRIGGER THRESHOLD LEVEL
0000	The DRE trigger threshold is the –12-dB input signal level
0001	The DRE trigger threshold is the –18-dB input signal level
0010	The DRE trigger threshold is the –24-dB input signal level
...	...
0111 (default)	The DRE trigger threshold is the –54-dB input signal level
...	...
1001	The DRE trigger threshold is the –66-dB input signal level
1010 to 1111	Reserved (do not use these settings)

The DRE gain range can be dynamically modulated by using the DRE_MAXGAIN[3:0, P0_R109[3:0] register bits. The DRE_MAXGAIN default value is set to 24 dB, and the DRE_MAXGAIN value is recommended to be set lower than 24 dB to maximize the benefit of the DRE in real-world applications and to minimize any audible artifacts. [Table 45](#) lists the DRE_MAXGAIN configuration settings.

Table 45. DRE Maximum Gain Programmable Settings

P0_R109_D[3:0] : DRE_MAXGAIN[3:0]	DRE MAXIMUM GAIN ALLOWED
0000	The DRE maximum gain allowed is 2 dB
0001	The DRE maximum gain allowed is 4 dB
0010	The DRE maximum gain allowed is 6 dB
...	...
1011 (default)	The DRE maximum gain allowed is 24 dB
...	...
1110	The DRE maximum gain allowed is 30 dB
1111	Reserved (do not use this setting)

The DRE scheme is only supported for analog microphone recording channels with an AC-coupled input for best dynamic range performance. The DRE scheme can be independently enabled or disabled for each channel using the CH1_DREEN (P0_R60_D0), CH2_DREEN (P0_R65_D0), CH3_DREEN (P0_R70_D0), and CH4_DREEN (P0_R75_D0) register bits. For a DC-coupled input, the DRE scheme can be used with limited DRE_MAXGAIN depending on the DC differential input common-mode offset.

Enabling the DRE for processing increases the power consumption of the device because of increased signal processing. Therefore, disable the DRE for low-power critical applications. Furthermore, the DRE is not supported for output sample rates greater than 192 kHz.

8.3.8 Automatic Gain Controller (AGC)

The device includes an automatic gain controller (AGC) for ADC recording. As shown in Figure 85, the AGC can be used to maintain a nominally constant output level when recording speech. Instead of manually setting the channel gain in AGC mode, the circuitry automatically adjusts the channel gain when the input signal becomes overly loud or very weak, such as when a person speaking into a microphone moves closer to or farther from the microphone. The AGC algorithm has several programmable parameters, including target level, maximum gain allowed, attack and release (or decay) time constants, and noise thresholds that allow the algorithm to be fine-tuned for any particular application.

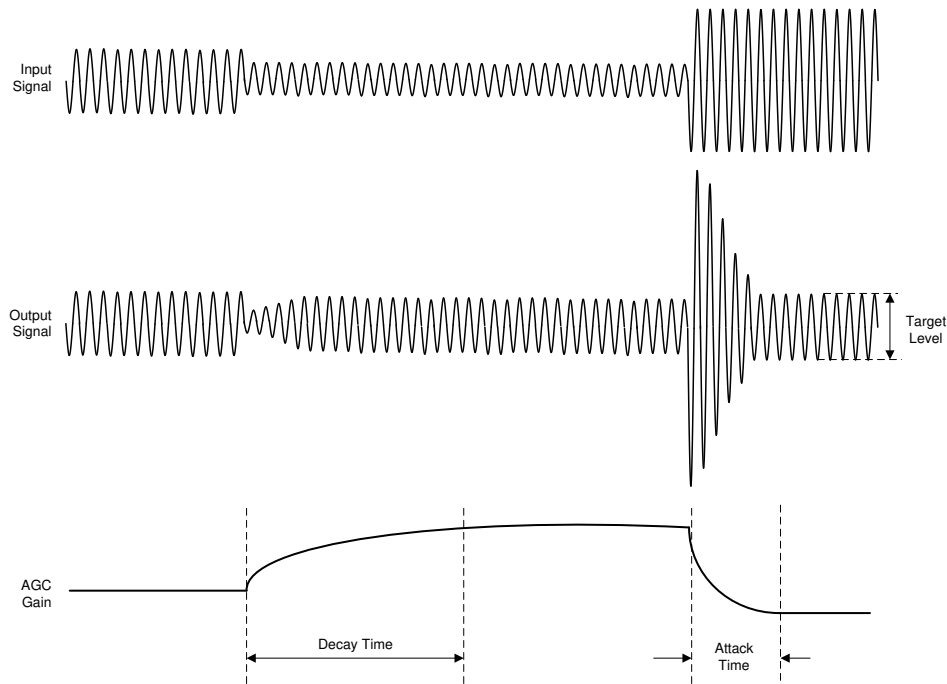

Figure 85. AGC Characteristics

The target level (AGC_LVL) represents the nominal approximate output level at which the AGC attempts to hold the ADC output signal level. The TLV320ADC6140 allows programming of different target levels, which can be programmed from –6 dB to –36 dB relative to a full-scale signal, and the AGC_LVL default value is set to –34 dB. The target level is recommended to be set with enough margin to prevent clipping when loud sounds occur. Table 46 lists the AGC target level configuration settings.

Table 46. AGC Target Level Programmable Settings

P0_R112_D[7:4] : AGC_LVL[3:0]	AGC TARGET LEVEL FOR OUTPUT
0000	The AGC target level is the –6-dB output signal level
0001	The AGC target level is the –8-dB output signal level
0010	The AGC target level is the –10-dB output signal level
...	...
1110 (default)	The AGC target level is the –34-dB output signal level
1111	The AGC target level is the –36-dB output signal level

The maximum gain allowed (AGC_MAXGAIN) gives flexibility to the designer to restrict the maximum gain applied by the AGC. This feature limits the channel gain in situations where environmental noise is greater than the programmed noise threshold. The AGC_MAXGAIN can be programmed from 3 dB to 42 dB with steps of 3 dB and the default value is set to 24 dB. [Table 47](#) lists the AGC_MAXGAIN configuration settings.

Table 47. AGC Maximum Gain Programmable Settings

P0_R112_D[3:0] : AGC_MAXGAIN[3:0]	AGC MAXIMUM GAIN ALLOWED
0000	The AGC maximum gain allowed is 3 dB
0001	The AGC maximum gain allowed is 6 dB
0010	The AGC maximum gain allowed is 9 dB
...	...
0111 (default)	The AGC maximum gain allowed is 24 dB
...	...
1110	The AGC maximum gain allowed is 39 dB
1111	The AGC maximum gain allowed is 42 dB

For further details on the AGC various configurable parameter and application use, see the [Using the Automatic Gain Controller \(AGC\) in TLV320ADCx140 application report](#).

8.3.9 Digital PDM Microphone Record Channel

In addition to supporting analog microphones, the device also interfaces to digital pulse-density-modulation (PDM) microphones and uses high-order and high-performance decimation filters to generate pulse code modulation (PCM) output data that can be transmitted on the audio serial interface to the host. If analog microphones are not used in the system, then the analog input pins (INxP and INxM) can be repurposed as the GPix and GPOx pins respectively and can be configured for the PDMINx and PDMCLK clocks for digital PDM microphone recording. The device supports up to eight digital microphone recording channels.

The device internally generates PCMCLK with a programmable frequency of either 6.144 MHz, 3.072 MHz, 1.536 MHz, or 768 kHz (for output data sample rates in multiples or submultiples of 48 kHz) or 5.6448 MHz, 2.8224 MHz, 1.4112 MHz, or 705.6 kHz (for output data sample rates in multiples or submultiples of 44.1 kHz) using the PDMCLK_DIV[1:0], P0_R31_D[1:0] register bits. PDMCLK can be routed on the GPOx pin. This clock can be connected to the external digital microphone device. Figure 86 shows a connection diagram of the digital PDM microphones.

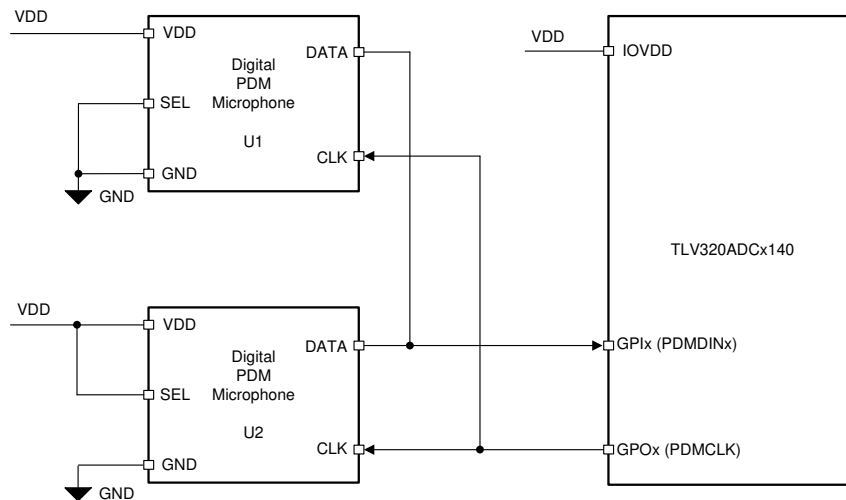

Figure 86. Digital PDM Microphones Connection Diagram to the TLV320ADC6140

The single-bit output of the external digital microphone device can be connected to the GPix pin. This single data line can be shared by two digital microphones to place their data on the opposite edge of PDMCLK. Internally, the device latches the steady value of the data on the rising edge of PDMCLK or the falling edge of PDMCLK based on the configuration register bits set in P0_R32_D[7:4]. Figure 87 shows the digital PDM microphone interface timing diagram.

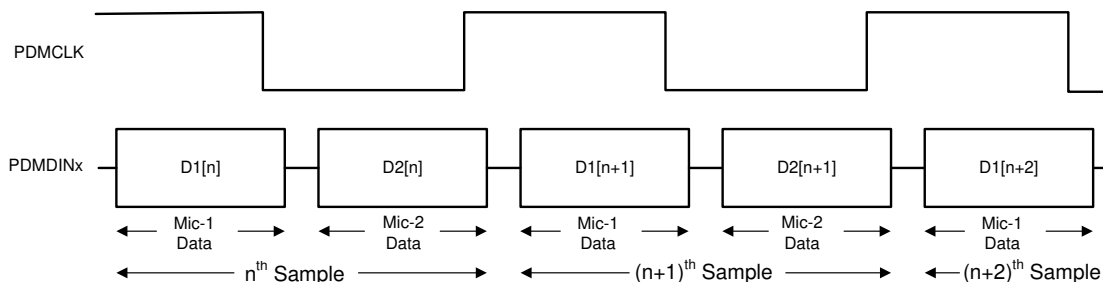

Figure 87. Digital PDM Microphone Protocol Timing Diagram

When the digital microphone is used for recording, the analog blocks of the respective ADC channel are powered down and bypassed for power efficiency. Use the CH1_INSRC[1:0] (P0_R60_D[6:5]), CH2_INSRC[1:0] (P0_R65_D[6:5]), CH3_INSRC[1:0] (P0_R70_D[6:5]), and CH4_INSRC[1:0] (P0_R75_D[6:5]) register bits to select the analog microphone or digital microphone for channel 1 to channel 4.

8.3.10 Interrupts, Status, and Digital I/O Pin Multiplexing

Certain events in the device may require host processor intervention and can be used to trigger interrupts to the host processor. One such event is an audio serial interface (ASI) bus error. The device powers down the record channels if any faults are detected with the ASI bus error clocks, such as:

- Invalid FSYNC frequency
- Invalid SBCLK to FSYNC ratio
- Long pauses of the SBCLK or FSYNC clocks

When an ASI bus clock error is detected, the device shuts down the record channel as quickly as possible. After all ASI bus clock errors are resolved, the device volume ramps back to its previous state to recover the record channel. During an ASI bus clock error, the internal interrupt request (IRQ) interrupt signal asserts low if the clock error interrupt mask register bit INT_MASK0[7], P0_R51_D7 is set low. The clock fault is also available for readback in the latched fault status register bit INT_LTCH0, P0_R54, which is a read-only register. Reading the latched fault status register, INT_LTCH0, clears all latched fault status. The device can be additionally configured to route the internal IRQ interrupt signal on the GPIO1 or GPOx pins and also can be configured as open-drain outputs so that these pins can be wire-ANDed to the open-drain interrupt outputs of other devices.

The IRQ interrupt signal can either be configured as active low or active high polarity by setting the INT_POL, P0_R50_D7 register bit. This signal can also be configured as a single pulse or a series of pulses by programming the INT_EVENT[1:0], P0_R50_D[6:5] register bits. If the interrupts are configured as a series of pulses, the events trigger the start of pulses that stop when the latched fault status register is read to determine the cause of the interrupt.

The device also supports read-only live-status registers to determine if the channels are powered up or down and if the device is in sleep mode or not. These status registers are located in P0_R118, DEV_STS0 and P0_R119, DEV_STS1.

The device has a multifunctional GPIO1 pin that can be configured for a desired specific function. Additionally, if the channel is not used for analog input recording, then the analog input pins for that channel (INxP and INxM) can be repurposed as multifunction pins (GPIx and GPOx) by configuring the CHx_INSRC[1:0] register bits located in the CHx_CFG0 register. The maximum number of GPO pins supported by the device is four and the maximum number of GPI pins are four. [Table 48](#) shows all possible allocations of these multifunctional pins for the various features.

Table 48. Multifunction Pin Assignments

ROW	Pin Function ⁽¹⁾	GPIO1	GPO1	GPO2	GPO3	GPO4	GPI1	GPI2	GPI3	GPI4
—	—	GPIO1_CFG	GPO1_CFG	GPO2_CFG	GPO3_CFG	GPO4_CFG	GPI1_CFG	GPI2_CFG	GPI3_CFG	GPI4_CFG
—	—	P0_R33[7:4]	P0_R34[7:4]	P0_R35[7:4]	P0_R36[7:4]	P0_R37[7:4]	P0_R43[6:4]	P0_R43[2:0]	P0_R44[6:4]	P0_R44[2:0]
A	Pin disabled	S ⁽²⁾	S (default)	S (default)	S (default)	S (default)	S (default)	S (default)	S (default)	S (default)
B	General-purpose output (GPO)	S	S	S	S	S	NS ⁽³⁾	NS	NS	NS
C	Interrupt output (IRQ)	S (default)	S	S	S	S	NS	NS	NS	NS
D	Secondary ASI output (SDOUT2) ⁽⁴⁾	S	S	S	S	S	NS	NS	NS	NS
E	PDM clock output (PDMCLK)	S	S	S	S	S	NS	NS	NS	NS
F	MICBIAS on/off input (BIASEN)	S	NS	NS	NS	NS	NS	NS	NS	NS
G	General-purpose input (GPI)	S	NS	NS	NS	NS	S	S	S	S
H	Master clock input (MCLK)	S	NS	NS	NS	NS	S	S	S	S
I	ASI daisy-chain input (SDIN)	S	NS	NS	NS	NS	S	S	S	S
J	PDM data input 1 (PDMIN1)	S	NS	NS	NS	NS	S	S	S	S
K	PDM data input 2 (PDMIN2)	S	NS	NS	NS	NS	S	S	S	S
L	PDM data input 3 (PDMIN3)	S	NS	NS	NS	NS	S	S	S	S
M	PDM data input 4 (PDMIN4)	S	NS	NS	NS	NS	S	S	S	S

- (1) Only the GPIO1 pin is with reference to the IOVDD supply, the other GPOx and GPIx pins are with reference to the AVDD supply and their primary pin functions are for the PDMCLK or PDMIN function.
- (2) S means the feature mentioned in this row is *supported* for the respective GPIO1, GPOx, or GPIx pin mentioned in this column.
- (3) NS means the feature mentioned in this row is *not supported* for the respective GPIO1, GPOx, or GPIx pin mentioned in this column.
- (4) For the high-speed ASI output, GPIO1 must be used instead of GPOx for the secondary ASI output. GPOx can be used only if the bus speed requirement is less than 6.144 MHz.

Each GPOx or GPIOx pin can be independently set for the desired drive configurations setting using the GPOx_DRV[3:0] or GPIO1_DRV[3:0] register bits. [Table 49](#) lists the drive configuration settings.

Table 49. GPIO or GPOx Pins Drive Configuration Settings

P0_R33_D[3:0] : GPIO1_DRV[3:0]	GPIO OUTPUT DRIVE CONFIGURATION SETTINGS FOR GPIO1
000	The GPIO1 pin is set to high impedance (floated)
001	The GPIO1 pin is set to be driven active low or active high
010 (default)	The GPIO1 pin is set to be driven active low or weak high (on-chip pullup)
011	The GPIO1 pin is set to be driven active low or Hi-Z (floated)
100	The GPIO1 pin is set to be driven weak low (on-chip pulldown) or active high
101	The GPIO1 pin is set to be driven Hi-Z (floated) or active high
110 and 111	Reserved (do not use these settings)

Similarly, the GPO1 to GPO4 pins can be configured using the GPO1_DRV(P0_R34) to GPO4_DRV(P0_R37) register bits, respectively.

When configured as a general-purpose output (GPO), the GPIO1 or GPOx pin values can be driven by writing the GPIO_VAL or GPOx_VAL, P0_R41 registers. The GPIO_MON, P0_R42 register can be used to readback the status of the GPIO1 pin when configured as a general-purpose input (GPI). Similarly, the GPI_MON, P0_R47 register can be used to readback the status of the GPIx pins when configured as a general-purpose input (GPI).

8.4 Device Functional Modes

8.4.1 Hardware Shutdown

The device enters hardware shutdown mode when the SHDNZ pin is asserted low or the AVDD supply voltage is not applied to the device. In hardware shutdown mode, the device consumes the minimum quiescent current from the AVDD supply. All configuration registers and programmable coefficients lose their value in this mode, and I²C or SPI communication to the device is not supported.

If the SHDNZ pin is asserted low when the device is in active mode, the device ramps down volume on the record data, powers down the analog and digital blocks, and puts the device into hardware shutdown mode in 25 ms (typical). The device can also be immediately put into hardware shutdown mode from active mode if the SHDNZ_CFG[1:0], P0_R5_D[3:2], register bits are set to 2'b00. After the SHDNZ pin is asserted low, and after the device enters hardware shutdown mode, keep the SHDNZ pin low for at least 1 ms before releasing SHDNZ for further device operation.

Assert the SHDNZ pin high only when the IOVDD supply settles to a steady voltage level. When the SHDNZ pin goes high, the device sets all configuration registers and programmable coefficients to their default values, and then enters sleep mode.

8.4.2 Sleep Mode or Software Shutdown

In sleep mode or software shutdown mode, the device consumes very low quiescent current from the AVDD supply and, at the same time, allows the I²C or SPI communication to wake the device for active operation.

The device can also enter sleep mode when the host device sets the SLEEP_ENZ, P0_R2_D0 bit to 1'b0. If the SLEEP_ENZ bit is asserted low when the device is in active mode, the device ramps down the volume on the record data, powers down the analog and digital blocks, and enters sleep mode. However, the device still continues to retain the last programmed value of the device configuration registers and programmable coefficients.

In sleep mode, do not perform any I²C or SPI transactions, except for exiting sleep mode in order to enter active mode. After entering sleep mode, wait at least 10 ms before starting I²C or SPI transactions to exit sleep mode.

While exiting sleep mode, the host device must configure the TLV320ADC6140 to use either an external 1.8-V AREG supply (default setting) or an on-chip-regulator-generated AREG supply. To configure the AREG supply, write to AREG_SELECT, bit D7 in the same P0_R2 register.

8.4.3 Active Mode

If the host device exits sleep mode by setting the SLEEP_ENZ bit to 1'b1, the device enters active mode. In active mode, I²C or SPI transactions can be done to configure and power-up the device for active operation. After entering active mode, wait at least 1 ms before starting any I²C or SPI transactions in order to allow the device to complete the internal wake-up sequence.

After configuring all other registers for the target application and system settings, configure the input and output channel enable registers, P0_R115 (IN_CH_EN) and P0_R116 (ASI_OUT_CH_EN), respectively. Lastly, configure the device power-up register, P0_R117 (PWR_CFG). All the programmable coefficient values must be written before powering up the respective channel.

In active mode, the power-up and power-down status of various blocks is monitored by reading the read-only device status bits located in the P0_R117 (DEV_STS0) and P0_R118 (DEV_STS1) registers.

8.4.4 Software Reset

A software reset can be done any time by asserting the SW_RESET bit, P0_R1_D0, which is a self-clearing bit. This software reset immediately shuts down the device, and restores all device configuration registers and programmable coefficients to their default values.

8.5 Programming

The device contains configuration registers and programmable coefficients that can be set to the desired values for a specific system and application use. These registers are called *device control registers* and are each eight bits in width, mapped using a page scheme.

Each page contains 128 configuration registers. All device configuration registers are stored in page 0, which is the default page setting at power up and after a software reset. All programmable coefficient registers are located in page 2, page 3, and page 4. The current page of the device can be switched to a new desired page by using the PAGE[7:0] bits located in register 0 of every page.

8.5.1 Control Serial Interfaces

The device control registers can be accessed using either I²C or SPI communication to the device.

By monitoring the SDA_SSZ, SCL_MOSI, ADDR0_SCLK, and ADDR1_MISO device pins, which are the multiplexed pins for the I²C or SPI Interface, the device automatically detects whether the host device is using I²C or SPI communication to configure the device. For a given end application, the host device must always use either the I²C or SPI interface, but not both, to configure the device.

8.5.1.1 I²C Control Interface

The device supports the I²C control protocol as a slave device, and is capable of operating in standard mode, fast mode, and fast mode plus. The I²C control protocol requires a 7-bit slave address. The five most significant bits (MSBs) of the slave address are fixed at 10011 and cannot be changed. The two least significant bits (LSBs) are programmable and are controlled by the ADDR0_SCLK and ADDR1_MISO pins. These two pins must always be either pulled to VSS or IOVDD. If the I2C_BRDCAST_EN (P0_R2_D2) bit is set to 1'b1, then the I²C slave address is fixed to 1001100 in order to allow simultaneous I²C broadcast communication to all TLV320ADC6140 devices in the system. [Table 50](#) lists the four possible device addresses resulting from this configuration.

Table 50. I²C Slave Address Settings

ADDR1_MISO	ADDR0_SCLK	I2C_BRDCAST_EN (P0_R2_D2)	I ² C SLAVE ADDRESS
0	0	0 (default)	1001 100
0	1	0 (default)	1001 101
1	0	0 (default)	1001 110
1	1	0 (default)	1001 111
X	X	1	1001 100

8.5.1.1.1 General I²C Operation

The I²C bus employs two signals, SDA (data) and SCL (clock), to communicate between integrated circuits in a system using serial data transmission. The address and data 8-bit bytes are transferred MSB first. In addition, each byte transferred on the bus is acknowledged by the receiving device with an acknowledge bit. Each transfer operation begins with the master device driving a start condition on the bus and ends with the master device driving a stop condition on the bus. The bus uses transitions on the data pin (SDA) while the clock is at logic high to indicate start and stop conditions. A high-to-low transition on SDA indicates a start, and a low-to-high transition indicates a stop. Normal data-bit transitions must occur within the low time of the clock period.

The master device drives a start condition followed by the 7-bit slave address and the read/write (R/W) bit to open communication with another device and then waits for an acknowledgment condition. The slave device holds SDA low during the acknowledge clock period to indicate acknowledgment. When this occurs, the master device transmits the next byte of the sequence. Each slave device is addressed by a unique 7-bit slave address plus the R/W bit (1 byte). All compatible devices share the same signals via a bidirectional bus using a wired-AND connection.

There is no limit on the number of bytes that can be transmitted between start and stop conditions. When the last word transfers, the master device generates a stop condition to release the bus. Figure 88 shows a generic data transfer sequence.

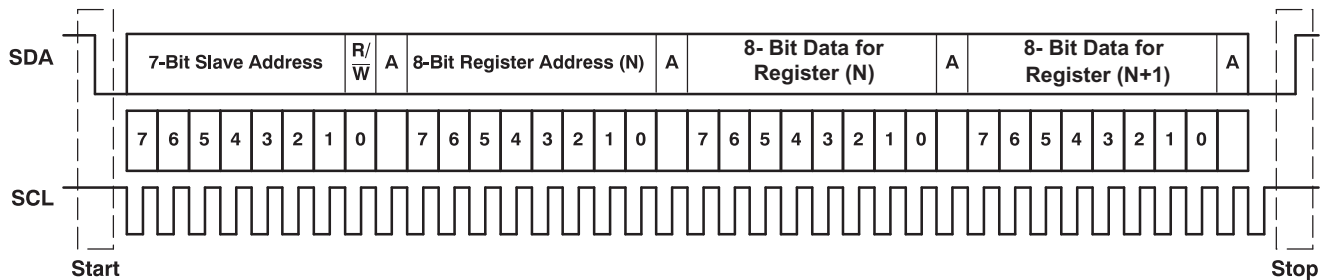

Figure 88. Typical I²C Sequence

In the system, use external pullup resistors for the SDA and SCL signals to set the logic high level for the bus. The SDA and SCL voltages must not exceed the device supply voltage, IOVDD.

8.5.1.1.2 I²C Single-Byte and Multiple-Byte Transfers

The device I²C interface supports both single-byte and multiple-byte read/write operations for all registers. During multiple-byte read operations, the device responds with data, a byte at a time, starting at the register assigned, as long as the master device continues to respond with acknowledges.

The device supports sequential I²C addressing. For write transactions, if a register is issued followed by data for that register and all the remaining registers that follow, a sequential I²C write transaction takes place. For I²C sequential write transactions, the register issued then serves as the starting point, and the amount of data subsequently transmitted, before a stop or start is transmitted, determines how many registers are written.

8.5.1.1.2.1 I²C Single-Byte Write

As shown in Figure 89, a single-byte data write transfer begins with the master device transmitting a start condition followed by the I²C device address and the read/write bit. The read/write bit determines the direction of the data transfer. For a write-data transfer, the read/write bit must be set to 0. After receiving the correct I²C slave address and the read/write bit, the device responds with an acknowledge bit (ACK). Next, the master device transmits the register byte corresponding to the device internal register address being accessed. After receiving the register byte, the device again responds with an acknowledge bit (ACK). Then, the master transmits the byte of data to be written to the specified register. When finished, the slave device responds with an acknowledge bit (ACK). Finally, the master device transmits a stop condition to complete the single-byte data write transfer.

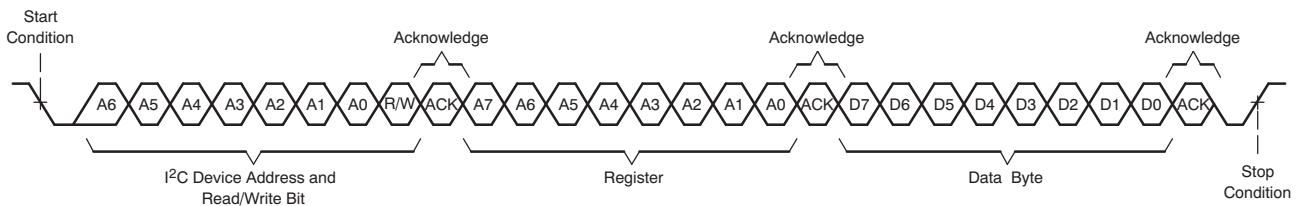

Figure 89. I²C Single-Byte Write Transfer

8.5.1.1.2.2 I²C Multiple-Byte Write

As shown in Figure 90, a multiple-byte data write transfer is identical to a single-byte data write transfer except that multiple data bytes are transmitted by the master device to the slave device. After receiving each data byte, the device responds with an acknowledge bit (ACK). Finally, the master device transmits a stop condition after the last data-byte write transfer.

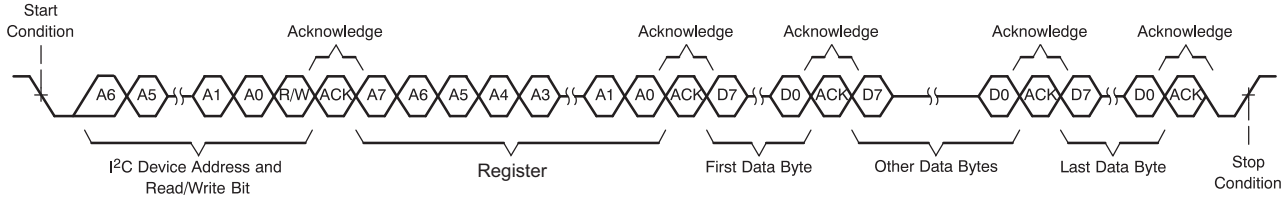

Figure 90. I²C Multiple-Byte Write Transfer

8.5.1.1.2.3 I²C Single-Byte Read

As shown in Figure 91, a single-byte data read transfer begins with the master device transmitting a start condition followed by the I²C slave address and the read/write bit. For the data read transfer, both a write followed by a read are done. Initially, a write is done to transfer the address byte of the internal register address to be read. As a result, the read/write bit is set to 0.

After receiving the slave address and the read/write bit, the device responds with an acknowledge bit (ACK). The master device then sends the internal register address byte, after which the device issues an acknowledge bit (ACK). The master device transmits another start condition followed by the slave address and the read/write bit again. This time, the read/write bit is set to 1, indicating a read transfer. Next, the device transmits the data byte from the register address being read. After receiving the data byte, the master device transmits a not-acknowledge (NACK) followed by a stop condition to complete the single-byte data read transfer.

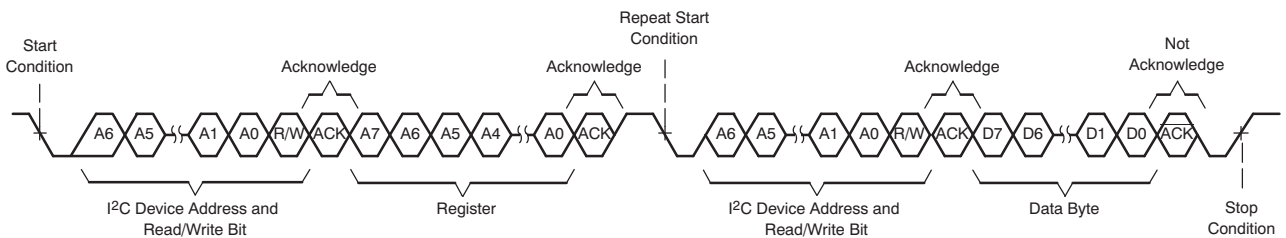

Figure 91. I²C Single-Byte Read Transfer

8.5.1.1.2.4 I²C Multiple-Byte Read

As shown in Figure 92, a multiple-byte data read transfer is identical to a single-byte data read transfer except that multiple data bytes are transmitted by the device to the master device. With the exception of the last data byte, the master device responds with an acknowledge bit after receiving each data byte. After receiving the last data byte, the master device transmits a not-acknowledge (NACK) followed by a stop condition to complete the data read transfer.

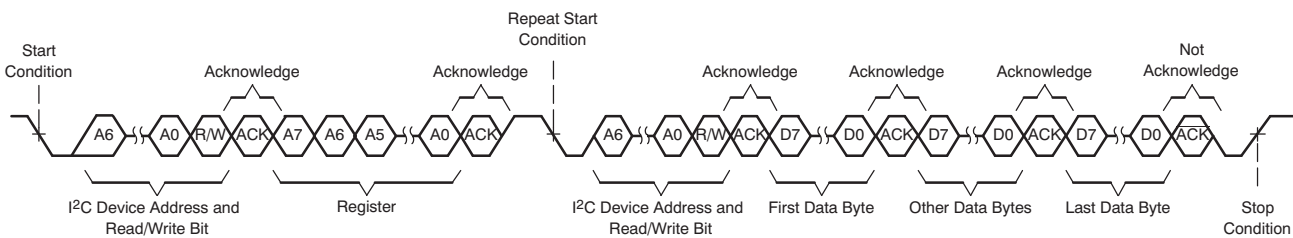

Figure 92. I²C Multiple-Byte Read Transfer

8.5.1.2 SPI Control Interface

The general SPI protocol allows full-duplex, synchronous, serial communication between a host processor (the master) and peripheral devices (slaves). The SPI master (in this case, the host processor) generates the synchronizing clock (driven onto SCLK) and initiates transmissions by taking the slave-select pin SSZ from high to low. The SPI slave devices (such as the TLV320ADC6140) depend on a master to start and synchronize transmissions. A transmission begins when initiated by an SPI master. The byte from the SPI master begins shifting in on the slave MOSI pin under the control of the master serial clock (driven onto SCLK). When the byte shifts in on the MOSI pin, a byte shifts out on the MISO pin to the master shift register.

The TLV320ADC6140 supports a standard SPI control protocol with a clock polarity setting of 0 (typical microprocessor SPI control bit CPOL = 0) and a clock phase setting of 1 (typical microprocessor SPI control bit CPHA = 1). The SSZ pin can remain low between transmissions; however, the device only interprets the first eight bits transmitted after the falling edge of SSZ as a command byte, and the next eight bits as a data byte only if writing to a register. The device is entirely controlled by registers. Reading and writing these registers is accomplished by an 8-bit command sent to the MOSI pin prior to the data for that register. Table 51 shows the command structure. The first seven bits specify the address of the register that is being written or read, from 0 to 127 (decimal). The command word ends with an R/W bit, which specifies the direction of data flow on the serial bus.

In the case of a register write, set the R/W bit to 0. A second byte of data is sent to the MOSI pin and contains the data to be written to the register. A register read is accomplished in a similar fashion. The 8-bit command word sends the 7-bit register address, followed by the R/W bit equal to 1 to signify a register read. The 8-bit register data is then clocked out of the device on the MISO pin during the second eight SCLK clocks in the frame. The device supports sequential SPI addressing for a multiple-byte data write/read transfer until the SSZ pin is pulled high. A multiple-byte data write or read transfer is identical to a single-byte data write or read transfer, respectively, until all data byte transfers complete. The host device must keep the SSZ pin low during all data byte transfers. Figure 93 shows the single-byte write transfer and Figure 94 shows the single-byte read transfer.

Table 51. SPI Command Word

BIT 7	BIT 6	BIT 5	BIT 4	BIT 3	BIT 2	BIT 1	BIT 0
ADDR(6)	ADDR(5)	ADDR(4)	ADDR(3)	ADDR(2)	ADDR(1)	ADDR(0)	R/WZ

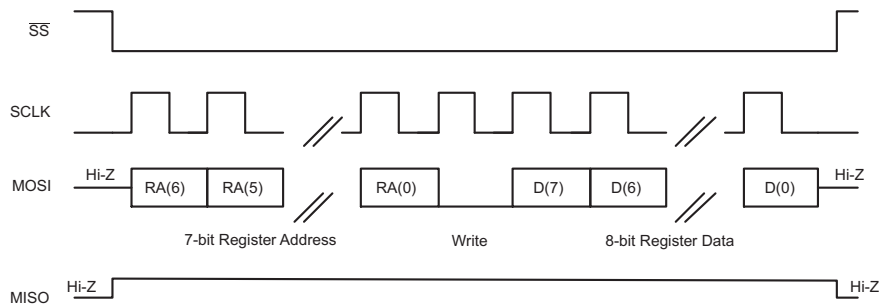

Figure 93. SPI Single-Byte Write Transfer

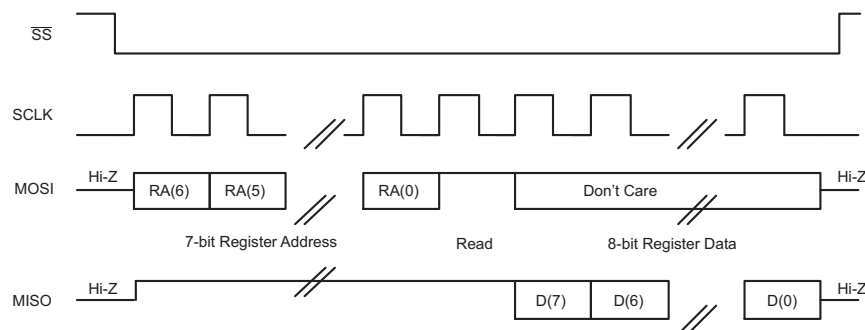

Figure 94. SPI Single-Byte Read Transfer

8.6 Register Maps

This section describes the control registers for the device in detail. All these registers are eight bits in width and allocated to device configuration and programmable coefficients settings. These registers are mapped internally using a page scheme that can be controlled using either I²C or SPI communication to the device. Each page contains 128 bytes of registers. All device configuration registers are stored in page 0, which is the default page setting at power up (and after a software reset). All programmable coefficient registers are located in page 2, page 3, and page 4. The device current page can be switched to a new desired page by using the PAGE[7:0] bits located in register 0 of every page.

Do not read from or write to reserved pages or reserved registers. Write only default values for the reserved bits in the valid registers.

The procedure for register access across pages is:

- Select page N (write data N to register 0 regardless of the current page number)
- Read or write data from or to valid registers in page N
- Select the new page M (write data M to register 0 regardless of the current page number)
- Read or write data from or to valid registers in page M
- Repeat as needed

8.6.1 Device Configuration Registers

This section describes the device configuration registers for page 0.

Table 52. Register Summary Table, Page = 0x00

ADDRESS	REGISTER	DESCRIPTION	SECTION
0x00	PAGE_CFG	Device page register	PAGE_CFG Register (P0_R0)
0x01	SW_RESET	Software reset register	SW_RESET Register (P0_R1)
0x02	SLEEP_CFG	Sleep mode register	SLEEP_CFG Register (P0_R2)
0x05	SHDN_CFG	Shutdown configuration register	SHDN_CFG Register (P0_R5)
0x07	ASI_CFG0	ASI configuration register 0	ASI_CFG0 Register (P0_R7)
0x08	ASI_CFG1	ASI configuration register 1	ASI_CFG1 Register (P0_R8)
0x09	ASI_CFG2	ASI configuration register 2	ASI_CFG2 Register (P0_R9)
0x0B	ASI_CH1	Channel 1 ASI slot configuration register	ASI_CH1 Register (P0_R11)
0x0C	ASI_CH2	Channel 2 ASI slot configuration register	ASI_CH2 Register (P0_R12)
0x0D	ASI_CH3	Channel 3 ASI slot configuration register	ASI_CH3 Register (P0_R13)
0x0E	ASI_CH4	Channel 4 ASI slot configuration register	ASI_CH4 Register (P0_R14)
0x0F	ASI_CH5	Channel 5 ASI slot configuration register	ASI_CH5 Register (P0_R15)
0x10	ASI_CH6	Channel 6 ASI slot configuration register	ASI_CH6 Register (P0_R16)
0x11	ASI_CH7	Channel 7 ASI slot configuration register	ASI_CH7 Register (P0_R17)
0x12	ASI_CH8	Channel 8 ASI slot configuration register	ASI_CH8 Register (P0_R18)
0x13	MST_CFG0	ASI master mode configuration register 0	MST_CFG0 Register (P0_R19)
0x14	MST_CFG1	ASI master mode configuration register 1	MST_CFG1 Register (P0_R20)
0x15	ASI_STS	ASI bus clock monitor status register	ASI_STS Register (P0_R21)
0x16	CLK_SRC	Clock source configuration register 0	CLK_SRC Register (P0_R22)
0x1F	PDMCLK_CFG	PDM clock generation configuration register	PDMCLK_CFG Register (P0_R31)
0x20	PDMIN_CFG	PDM DINx sampling edge register	PDMIN_CFG Register (P0_R32)
0x21	GPIO_CFG0	GPIO configuration register 0	GPIO_CFG0 Register (P0_R33)
0x22	GPO_CFG0	GPO configuration register 0	GPO_CFG0 Register (P0_R34)
0x23	GPO_CFG1	GPO configuration register 1	GPO_CFG1 Register (P0_R35)
0x24	GPO_CFG2	GPO configuration register 2	GPO_CFG2 Register (P0_R36)
0x25	GPO_CFG3	GPO configuration register 3	GPO_CFG3 Register (P0_R37)
0x29	GPO_VAL	GPIO, GPO output value register	GPO_VAL Register (P0_R41)
0x2A	GPIO_MON	GPIO monitor value register	GPIO_MON Register (P0_R42)
0x2B	GPI_CFG0	GPI configuration register 0	GPI_CFG0 Register (P0_R43)
0x2C	GPI_CFG1	GPI configuration register 1	GPI_CFG1 Register (P0_R44)

Register Maps (continued)
Table 52. Register Summary Table, Page = 0x00 (continued)

ADDRESS	REGISTER	DESCRIPTION	SECTION
0x2F	GPI_MON	GPI monitor value register	GPI_MON Register (P0_R47)
0x32	INT_CFG	Interrupt configuration register	INT_CFG Register (P0_R50)
0x33	INT_MASK0	Interrupt mask register 0	INT_MASK0 Register (P0_R51)
0x36	INT_LTCH0	Latched interrupt readback register 0	INT_LTCH0 Register (P0_R54)
0x3B	BIAS_CFG	Bias and ADC configuration register	BIAS_CFG Register (P0_R59)
0x3C	CH1_CFG0	Channel 1 configuration register 0	CH1_CFG0 Register (P0_R60)
0x3D	CH1_CFG1	Channel 1 configuration register 1	CH1_CFG1 Register (P0_R61)
0x3E	CH1_CFG2	Channel 1 configuration register 2	CH1_CFG2 Register (P0_R62)
0x3F	CH1_CFG3	Channel 1 configuration register 3	CH1_CFG3 Register (P0_R63)
0x40	CH1_CFG4	Channel 1 configuration register 4	CH1_CFG4 Register (P0_R64)
0x41	CH2_CFG0	Channel 2 configuration register 0	CH2_CFG0 Register (P0_R65)
0x42	CH2_CFG1	Channel 2 configuration register 1	CH2_CFG1 Register (P0_R66)
0x43	CH2_CFG2	Channel 2 configuration register 2	CH2_CFG2 Register (P0_R67)
0x44	CH2_CFG3	Channel 2 configuration register 3	CH2_CFG3 Register (P0_R68)
0x45	CH2_CFG4	Channel 2 configuration register 4	CH2_CFG4 Register (P0_R69)
0x46	CH3_CFG0	Channel 3 configuration register 0	CH3_CFG0 Register (P0_R70)
0x47	CH3_CFG1	Channel 3 configuration register 1	CH3_CFG1 Register (P0_R71)
0x48	CH3_CFG2	Channel 3 configuration register 2	CH3_CFG2 Register (P0_R72)
0x49	CH3_CFG3	Channel 3 configuration register 3	CH3_CFG3 Register (P0_R73)
0x4A	CH3_CFG4	Channel 3 configuration register 4	CH3_CFG4 Register (P0_R74)
0x4B	CH4_CFG0	Channel 4 configuration register 0	CH4_CFG0 Register (P0_R75)
0x4C	CH4_CFG1	Channel 4 configuration register 1	CH4_CFG1 Register (P0_R76)
0x4D	CH4_CFG2	Channel 4 configuration register 2	CH4_CFG2 Register (P0_R77)
0x4E	CH4_CFG3	Channel 4 configuration register 3	CH4_CFG3 Register (P0_R78)
0x4F	CH4_CFG4	Channel 4 configuration register 4	CH4_CFG4 Register (P0_R79)
0x52	CH5_CFG2	Channel 5 (PDM only) configuration register 2	CH5_CFG2 Register (P0_R82)
0x53	CH5_CFG3	Channel 5 (PDM only) configuration register 3	CH5_CFG3 Register (P0_R83)
0x54	CH5_CFG4	Channel 5 (PDM only) configuration register 4	CH5_CFG4 Register (P0_R84)
0x57	CH6_CFG2	Channel 6 (PDM only) configuration register 2	CH6_CFG2 Register (P0_R87)
0x58	CH6_CFG3	Channel 6 (PDM only) configuration register 3	CH6_CFG3 Register (P0_R88)
0x59	CH6_CFG4	Channel 6 (PDM only) configuration register 4	CH6_CFG4 Register (P0_R89)
0x5C	CH7_CFG2	Channel 7 (PDM only) configuration register 2	CH7_CFG2 Register (P0_R92)
0x5D	CH7_CFG3	Channel 7 (PDM only) configuration register 3	CH7_CFG3 Register (P0_R93)
0x5E	CH7_CFG4	Channel 7 (PDM only) configuration register 4	CH7_CFG4 Register (P0_R94)
0x61	CH8_CFG2	Channel 8 (PDM only) configuration register 2	CH8_CFG2 Register (P0_R97)
0x62	CH8_CFG3	Channel 8 (PDM only) configuration register 3	CH8_CFG3 Register (P0_R98)
0x63	CH8_CFG4	Channel 8 (PDM only) configuration register 4	CH8_CFG4 Register (P0_R99)
0x6B	DSP_CFG0	DSP configuration register 0	DSP_CFG0 Register (P0_R107)
0x6C	DSP_CFG1	DSP configuration register 1	DSP_CFG1 Register (P0_R108)
0x6D	DRE_CFG0	DRE configuration register 0	DRE_CFG0 Register (P0_R109)
0x70	AGC_CFG0	AGC configuration register 0	AGC_CFG0 Register (P0_R112)
0x73	IN_CH_EN	Input channel enable configuration register	IN_CH_EN Register (P0_R115)
0x74	ASI_OUT_CH_EN	ASI output channel enable configuration register	ASI_OUT_CH_EN Register (P0_R116)
0x75	PWR_CFG	Power up configuration register	PWR_CFG Register (P0_R117)
0x76	DEV_STS0	Device status value register 0	DEV_STS0 Register (P0_R118)
0x77	DEV_STS1	Device status value register 1	DEV_STS1 Register (P0_R119)
0x7E	I2C_CKSUM	I ² C checksum register	I2C_CKSUM Register (P0_R126)

Table 53 lists the access codes used for the TLV320ADC6140 registers.

Table 53. TLV320ADC6140 Access Type Codes

Access Type	Code	Description
Read Type		
R	R	Read
R-W	R/W	Read or write
Write Type		
W	W	Write
Reset or Default Value		
-n		Value after reset or the default value

8.6.1.1 Register Descriptions

8.6.1.1.1 PAGE_CFG Register (page = 0x00, address = 0x00) [reset = 0h]

The device memory map is divided into pages. This register sets the page.

Figure 95. PAGE_CFG Register

7	6	5	4	3	2	1	0
PAGE[7:0]							
R/W-0h							

Table 54. PAGE_CFG Register Field Descriptions

Bit	Field	Type	Reset	Description
7-0	PAGE[7:0]	R/W	0h	These bits set the device page. 0d = Page 0 1d = Page 1 ... 255d = Page 255

8.6.1.1.2 SW_RESET Register (page = 0x00, address = 0x01) [reset = 0h]

This register is the software reset register. Asserting a software reset places all register values in their default power-on-reset (POR) state.

Figure 96. SW_RESET Register

7	6	5	4	3	2	1	0
Reserved							SW_RESET
R-0h							R/W-0h

Table 55. SW_RESET Register Field Descriptions

Bit	Field	Type	Reset	Description
7-1	Reserved	R	0h	Reserved
0	SW_RESET	R/W	0h	Software reset. This bit is self clearing. 0d = Do not reset 1d = Reset

8.6.1.1.3 SLEEP_CFG Register (page = 0x00, address = 0x02) [reset = 0h]

This register configures the regulator, VREF quick charge, I²C broadcast, and sleep mode.

Figure 97. SLEEP_CFG Register

7	6	5	4	3	2	1	0
AREG_SELECT	Reserved		VREF_QCHG[1:0]		I2C_BRDCAST_EN	Reserved	SLEEP_ENZ
R/W-0h	R/W-0h		R/W-0h		R/W-0h	R-0h	R/W-0h

Table 56. SLEEP_CFG Register Field Descriptions

Bit	Field	Type	Reset	Description
7	AREG_SELECT	R/W	0h	The analog supply selection from either the internal regulator supply or the external AREG supply. 0d = External 1.8-V AREG supply (use this setting when AVDD is 1.8 V and short AREG with AVDD) 1d = Internally generated 1.8-V AREG supply using an on-chip regulator (use this setting when AVDD is 3.3 V)
6-5	Reserved	R/W	0h	Reserved
4-3	VREF_QCHG[1:0]	R/W	0h	The duration of the quick-charge for the VREF external capacitor is set using an internal series impedance of 200 Ω. 0d = VREF quick-charge duration of 3.5 ms (typical) 1d = VREF quick-charge duration of 10 ms (typical) 2d = VREF quick-charge duration of 50 ms (typical) 3d = VREF quick-charge duration of 100 ms (typical)
2	I2C_BRDCAST_EN	R/W	0h	I ² C broadcast addressing setting. 0d = I ² C broadcast mode disabled; the I ² C slave address is determined based on the ADDR pins 1d = I ² C broadcast mode enabled; the I ² C slave address is fixed at 1001 100
1	Reserved	R	0h	Reserved
0	SLEEP_ENZ	R/W	0h	Sleep mode setting. 0d = Device is in sleep mode 1d = Device is not in sleep mode

8.6.1.1.4 SHDN_CFG Register (page = 0x00, address = 0x05) [reset = 5h]

This register configures the device shutdown.

Figure 98. SHDN_CFG Register

7	6	5	4	3	2	1	0
Reserved		INCAP_QCHG[1:0]		SHDNZ_CFG[1:0]		DREG_KA_TIME[1:0]	
R-0h		R/W-0h		R/W-1h		R/W-1h	

Table 57. SHDN_CFG Register Field Descriptions

Bit	Field	Type	Reset	Description
7-6	Reserved	R	0h	Reserved
5-4	INCAP_QCHG[1:0]	R/W	0h	The duration of the quick-charge for the external AC-coupling capacitor is set using an internal series impedance of 800 Ω. 0d = INxP, INxM quick-charge duration of 2.5 ms (typical) 1d = INxP, INxM quick-charge duration of 12.5 ms (typical) 2d = INxP, INxM quick-charge duration of 25 ms (typical) 3d = INxP, INxM quick-charge duration of 50 ms (typical)
3-2	SHDNZ_CFG[1:0]	R/W	1h	Shutdown configuration. 0d = DREG is powered down immediately after SHDNZ asserts 1d = DREG remains active to enable a clean shut down until a time-out is reached; after the time-out period, DREG is forced to power off 2d = DREG remains active until the device cleanly shuts down 3d = Reserved
1-0	DREG_KA_TIME[1:0]	R/W	1h	These bits set how long DREG remains active after SHDNZ asserts. 0d = DREG remains active for 30 ms (typical) 1d = DREG remains active for 25 ms (typical) 2d = DREG remains active for 10 ms (typical) 3d = DREG remains active for 5 ms (typical)

8.6.1.1.5 ASI_CFG0 Register (page = 0x00, address = 0x07) [reset = 30h]

This register is the ASI configuration register 0.

Figure 99. ASI_CFG0 Register

7	6	5	4	3	2	1	0
ASI_FORMAT[1:0]		ASI_WLEN[1:0]		FSYNC_POL	BCLK_POL	TX_EDGE	TX_FILL
R/W-0h		R/W-3h		R/W-0h	R/W-0h	R/W-0h	R/W-0h

Table 58. ASI_CFG0 Register Field Descriptions

Bit	Field	Type	Reset	Description
7-6	ASI_FORMAT[1:0]	R/W	0h	ASI protocol format. 0d = TDM mode 1d = I ² S mode 2d = LJ (left-justified) mode 3d = Reserved
5-4	ASI_WLEN[1:0]	R/W	3h	ASI word or slot length. 0d = 16 bits 1d = 20 bits 2d = 24 bits 3d = 32 bits
3	FSYNC_POL	R/W	0h	ASI FSYNC polarity. 0d = Default polarity as per standard protocol 1d = Inverted polarity with respect to standard protocol
2	BCLK_POL	R/W	0h	ASI BCLK polarity. 0d = Default polarity as per standard protocol 1d = Inverted polarity with respect to standard protocol
1	TX_EDGE	R/W	0h	ASI data output (on the primary and secondary data pin) transmit edge. 0d = Default edge as per the protocol configuration setting in bit 2 (BCLK_POL) 1d = Inverted following edge (half cycle delay) with respect to the default edge setting
0	TX_FILL	R/W	0h	ASI data output (on the primary and secondary data pin) for any unused cycles 0d = Always transmit 0 for unused cycles 1d = Always use Hi-Z for unused cycles

8.6.1.1.6 ASI_CFG1 Register (page = 0x00, address = 0x08) [reset = 0h]

This register is the ASI configuration register 1.

Figure 100. ASI_CFG1 Register

7	6	5	4	3	2	1	0
TX_LSB	TX_KEEPER[1:0]		TX_OFFSET[4:0]				
R/W-0h	R/W-0h		R/W-0h				

Table 59. ASI_CFG1 Register Field Descriptions

Bit	Field	Type	Reset	Description
7	TX_LSB	R/W	0h	ASI data output (on the primary and secondary data pin) for LSB transmissions. 0d = Transmit the LSB for a full cycle 1d = Transmit the LSB for the first half cycle and Hi-Z for the second half cycle
6-5	TX_KEEPER[1:0]	R/W	0h	ASI data output (on the primary and secondary data pin) bus keeper. 0d = Bus keeper is always disabled 1d = Bus keeper is always enabled 2d = Bus keeper is enabled during LSB transmissions only for one cycle 3d = Bus keeper is enabled during LSB transmissions only for one and half cycles

Table 59. ASI_CFG1 Register Field Descriptions (continued)

Bit	Field	Type	Reset	Description
4-0	TX_OFFSET[4:0]	R/W	0h	ASI data MSB slot 0 offset (on the primary and secondary data pin). 0d = ASI data MSB location has no offset and is as per standard protocol 1d = ASI data MSB location (TDM mode is slot 0 or I ² S, LJ mode is the left and right slot 0) offset of one BCLK cycle with respect to standard protocol 2d = ASI data MSB location (TDM mode is slot 0 or I ² S, LJ mode is the left and right slot 0) offset of two BCLK cycles with respect to standard protocol 3d to 30d = ASI data MSB location (TDM mode is slot 0 or I ² S, LJ mode is the left and right slot 0) offset assigned as per configuration 31d = ASI data MSB location (TDM mode is slot 0 or I ² S, LJ mode is the left and right slot 0) offset of 31 BCLK cycles with respect to standard protocol

8.6.1.1.7 ASI_CFG2 Register (page = 0x00, address = 0x09) [reset = 0h]

This register is the ASI configuration register 2.

Figure 101. ASI_CFG2 Register

7	6	5	4	3	2	1	0
ASI_DAI5Y	Reserved	ASI_ERR	ASI_ERR_RCOV	Reserved			
R/W-0h	R-0h	R/W-0h	R/W-0h	R-0h			

Table 60. ASI_CFG2 Register Field Descriptions

Bit	Field	Type	Reset	Description
7	ASI_DAI5Y	R/W	0h	ASI daisy-chain connection. 0d = All devices are connected in the common ASI bus 1d = All devices are daisy-chained for the ASI bus
6	Reserved	R	0h	Reserved
5	ASI_ERR	R/W	0h	ASI bus error detection. 0d = Enable bus error detection 1d = Disable bus error detection
4	ASI_ERR_RCOV	R/W	0h	ASI bus error auto resume. 0d = Enable auto resume after bus error recovery 1d = Disable auto resume after bus error recovery and remain powered down until the host configures the device
3-0	Reserved	R	0h	Reserved

8.6.1.1.8 ASI_CH1 Register (page = 0x00, address = 0x0B) [reset = 0h]

This register is the ASI slot configuration register for channel 1.

Figure 102. ASI_CH1 Register

7	6	5	4	3	2	1	0
Reserved	CH1_OUTPUT	CH1_SLOT[5:0]					
R-0h	R/W-0h	R/W-0h					

Table 61. ASI_CH1 Register Field Descriptions

Bit	Field	Type	Reset	Description
7	Reserved	R	0h	Reserved
6	CH1_OUTPUT	R/W	0h	Channel 1 output line. 0d = Channel 1 output is on the ASI primary output pin (SDOUT) 1d = Channel 1 output is on the ASI secondary output pin (GPIO1 or GPOx)

Table 61. ASI_CH1 Register Field Descriptions (continued)

Bit	Field	Type	Reset	Description
5-0	CH1_SLOT[5:0]	R/W	0h	Channel 1 slot assignment. 0d = TDM is slot 0 or I ² S, LJ is left slot 0 1d = TDM is slot 1 or I ² S, LJ is left slot 1 2d to 30d = Slot assigned as per configuration 31d = TDM is slot 31 or I ² S, LJ is left slot 31 32d = TDM is slot 32 or I ² S, LJ is right slot 0 33d = TDM is slot 33 or I ² S, LJ is right slot 1 34d to 62d = Slot assigned as per configuration 63d = TDM is slot 63 or I ² S, LJ is right slot 31

8.6.1.1.9 ASI_CH2 Register (page = 0x00, address = 0x0C) [reset = 1h]

This register is the ASI slot configuration register for channel 2.

Figure 103. ASI_CH2 Register

7	6	5	4	3	2	1	0
Reserved	CH2_OUTPUT	CH2_SLOT[5:0]					
R-0h	R/W-0h	R/W-1h					

Table 62. ASI_CH2 Register Field Descriptions

Bit	Field	Type	Reset	Description
7	Reserved	R	0h	Reserved
6	CH2_OUTPUT	R/W	0h	Channel 2 output line. 0d = Channel 2 output is on the ASI primary output pin (SDOUT) 1d = Channel 2 output is on the ASI secondary output pin (GPIO1 or GPOx)
5-0	CH2_SLOT[5:0]	R/W	1h	Channel 2 slot assignment. 0d = TDM is slot 0 or I ² S, LJ is left slot 0 1d = TDM is slot 1 or I ² S, LJ is left slot 1 2d to 30d = Slot assigned as per configuration 31d = TDM is slot 31 or I ² S, LJ is left slot 31 32d = TDM is slot 32 or I ² S, LJ is right slot 0 33d = TDM is slot 33 or I ² S, LJ is right slot 1 34d to 62d = Slot assigned as per configuration 63d = TDM is slot 63 or I ² S, LJ is right slot 31

8.6.1.1.10 ASI_CH3 Register (page = 0x00, address = 0x0D) [reset = 2h]

This register is the ASI slot configuration register for channel 3.

Figure 104. ASI_CH3 Register

7	6	5	4	3	2	1	0
Reserved	CH3_OUTPUT	CH3_SLOT[5:0]					
R-0h	R/W-0h	R/W-2h					

Table 63. ASI_CH3 Register Field Descriptions

Bit	Field	Type	Reset	Description
7	Reserved	R	0h	Reserved
6	CH3_OUTPUT	R/W	0h	Channel 3 output line. 0d = Channel 3 output is on the ASI primary output pin (SDOUT) 1d = Channel 3 output is on the ASI secondary output pin (GPIO1 or GPOx)

Table 63. ASI_CH3 Register Field Descriptions (continued)

Bit	Field	Type	Reset	Description
5-0	CH3_SLOT[5:0]	R/W	2h	Channel 3 slot assignment. 0d = TDM is slot 0 or I ² S, LJ is left slot 0 1d = TDM is slot 1 or I ² S, LJ is left slot 1 2d to 30d = Slot assigned as per configuration 31d = TDM is slot 31 or I ² S, LJ is left slot 31 32d = TDM is slot 32 or I ² S, LJ is right slot 0 33d = TDM is slot 33 or I ² S, LJ is right slot 1 34d to 62d = Slot assigned as per configuration 63d = TDM is slot 63 or I ² S, LJ is right slot 31

8.6.1.1.11 ASI_CH4 Register (page = 0x00, address = 0x0E) [reset = 3h]

This register is the ASI slot configuration register for channel 4.

Figure 105. ASI_CH4 Register

7	6	5	4	3	2	1	0
Reserved	CH4_OUTPUT	CH4_SLOT[5:0]					
R-0h	R/W-0h	R/W-3h					

Table 64. ASI_CH4 Register Field Descriptions

Bit	Field	Type	Reset	Description
7	Reserved	R	0h	Reserved
6	CH4_OUTPUT	R/W	0h	Channel 4 output line. 0d = Channel 4 output is on the ASI primary output pin (SDOUT) 1d = Channel 4 output is on the ASI secondary output pin (GPIO1 or GPOx)
5-0	CH4_SLOT[5:0]	R/W	3h	Channel 4 slot assignment. 0d = TDM is slot 0 or I ² S, LJ is left slot 0 1d = TDM is slot 1 or I ² S, LJ is left slot 1 2d to 30d = Slot assigned as per configuration 31d = TDM is slot 31 or I ² S, LJ is left slot 31 32d = TDM is slot 32 or I ² S, LJ is right slot 0 33d = TDM is slot 33 or I ² S, LJ is right slot 1 34d to 62d = Slot assigned as per configuration 63d = TDM is slot 63 or I ² S, LJ is right slot 31

8.6.1.1.12 ASI_CH5 Register (page = 0x00, address = 0x0F) [reset = 4h]

This register is the ASI slot configuration register for channel 5.

Figure 106. ASI_CH5 Register

7	6	5	4	3	2	1	0
Reserved	CH5_OUTPUT	CH5_SLOT[5:0]					
R-0h	R/W-0h	R/W-4h					

Table 65. ASI_CH5 Register Field Descriptions

Bit	Field	Type	Reset	Description
7	Reserved	R	0h	Reserved
6	CH5_OUTPUT	R/W	0h	Channel 5 output line. 0d = Channel 5 output is on the ASI primary output pin (SDOUT) 1d = Channel 5 output is on the ASI secondary output pin (GPIO1 or GPOx)

Table 65. ASI_CH5 Register Field Descriptions (continued)

Bit	Field	Type	Reset	Description
5-0	CH5_SLOT[5:0]	R/W	4h	Channel 5 slot assignment. 0d = TDM is slot 0 or I ² S, LJ is left slot 0 1d = TDM is slot 1 or I ² S, LJ is left slot 1 2d to 30d = Slot assigned as per configuration 31d = TDM is slot 31 or I ² S, LJ is left slot 31 32d = TDM is slot 32 or I ² S, LJ is right slot 0 33d = TDM is slot 33 or I ² S, LJ is right slot 1 34d to 62d = Slot assigned as per configuration 63d = TDM is slot 63 or I ² S, LJ is right slot 31

8.6.1.1.13 ASI_CH6 Register (page = 0x00, address = 0x10) [reset = 5h]

This register is the ASI slot configuration register for channel 6.

Figure 107. ASI_CH6 Register

7	6	5	4	3	2	1	0
Reserved	CH6_OUTPUT	CH6_SLOT[5:0]					
R-0h	R/W-0h	R/W-5h					

Table 66. ASI_CH6 Register Field Descriptions

Bit	Field	Type	Reset	Description
7	Reserved	R	0h	Reserved
6	CH6_OUTPUT	R/W	0h	Channel 6 output line. 0d = Channel 6 output is on the ASI primary output pin (SDOUT) 1d = Channel 6 output is on the ASI secondary output pin (GPIO1 or GPOx)
5-0	CH6_SLOT[5:0]	R/W	5h	Channel 6 slot assignment. 0d = TDM is slot 0 or I ² S, LJ is left slot 0 1d = TDM is slot 1 or I ² S, LJ is left slot 1 2d to 30d = Slot assigned as per configuration 31d = TDM is slot 31 or I ² S, LJ is left slot 31 32d = TDM is slot 32 or I ² S, LJ is right slot 0 33d = TDM is slot 33 or I ² S, LJ is right slot 1 34d to 62d = Slot assigned as per configuration 63d = TDM is slot 63 or I ² S, LJ is right slot 31

8.6.1.1.14 ASI_CH7 Register (page = 0x00, address = 0x11) [reset = 6h]

This register is the ASI slot configuration register for channel 7.

Figure 108. ASI_CH7 Register

7	6	5	4	3	2	1	0
Reserved	CH7_OUTPUT	CH7_SLOT[5:0]					
R-0h	R/W-0h	R/W-6h					

Table 67. ASI_CH7 Register Field Descriptions

Bit	Field	Type	Reset	Description
7	Reserved	R	0h	Reserved
6	CH7_OUTPUT	R/W	0h	Channel 7 output line. 0d = Channel 7 output is on the ASI primary output pin (SDOUT) 1d = Channel 7 output is on the ASI secondary output pin (GPIO1 or GPOx)

Table 67. ASI_CH7 Register Field Descriptions (continued)

Bit	Field	Type	Reset	Description
5-0	CH7_SLOT[5:0]	R/W	6h	Channel 7 slot assignment. 0d = TDM is slot 0 or I ² S, LJ is left slot 0 1d = TDM is slot 1 or I ² S, LJ is left slot 1 2d to 30d = Slot assigned as per configuration 31d = TDM is slot 31 or I ² S, LJ is left slot 31 32d = TDM is slot 32 or I ² S, LJ is right slot 0 33d = TDM is slot 33 or I ² S, LJ is right slot 1 34d to 62d = Slot assigned as per configuration 63d = TDM is slot 63 or I ² S, LJ is right slot 31

8.6.1.1.15 ASI_CH8 Register (page = 0x00, address = 0x12) [reset = 7h]

This register is the ASI slot configuration register for channel 8.

Figure 109. ASI_CH8 Register

7	6	5	4	3	2	1	0
Reserved	CH8_OUTPUT	CH8_SLOT[5:0]					
R-0h	R/W-0h	R/W-7h					

Table 68. ASI_CH8 Register Field Descriptions

Bit	Field	Type	Reset	Description
7	Reserved	R	0h	Reserved
6	CH8_OUTPUT	R/W	0h	Channel 8 output line. 0d = Channel 8 output is on the ASI primary output pin (SDOUT) 1d = Channel 8 output is on the ASI secondary output pin (GPIO1 or GPOx)
5-0	CH8_SLOT[5:0]	R/W	7h	Channel 8 slot assignment. 0d = TDM is slot 0 or I ² S, LJ is left slot 0 1d = TDM is slot 1 or I ² S, LJ is left slot 1 2d to 30d = Slot assigned as per configuration 31d = TDM is slot 31 or I ² S, LJ is left slot 31 32d = TDM is slot 32 or I ² S, LJ is right slot 0 33d = TDM is slot 33 or I ² S, LJ is right slot 1 34d to 62d = Slot assigned as per configuration 63d = TDM is slot 63 or I ² S, LJ is right slot 31

8.6.1.1.16 MST_CFG0 Register (page = 0x00, address = 0x13) [reset = 2h]

This register is the ASI master mode configuration register 0.

Figure 110. MST_CFG0 Register

7	6	5	4	3	2	1	0
MST_SLV_CFG	AUTO_CLK_CFG	AUTO_MODE_PLL_DIS	BCLK_FSYNC_GATE	FS_MODE	MCLK_FREQ_SEL[2:0]		
R/W-0h	R/W-0h	R/W-0h	R/W-0h	R/W-0h	R/W-2h		

Table 69. MST_CFG0 Register Field Descriptions

Bit	Field	Type	Reset	Description
7	MST_SLV_CFG	R/W	0h	ASI master or slave configuration register setting. 0d = Device is in slave mode (both BCLK and FSYNC are inputs to the device) 1d = Device is in master mode (both BCLK and FSYNC are generated from the device)
6	AUTO_CLK_CFG	R/W	0h	Automatic clock configuration setting. 0d = Auto clock configuration is enabled (all internal clock divider and PLL configurations are auto derived) 1d = Auto clock configuration is disabled (custom mode and device GUI must be used for the device configuration settings)

Table 69. MST_CFG0 Register Field Descriptions (continued)

Bit	Field	Type	Reset	Description
5	AUTO_MODE_PLL_DIS	R/W	0h	Automatic mode PLL setting. 0d = PLL is enabled in auto clock configuration 1d = PLL is disabled in auto clock configuration
4	BCLK_FSYNC_GATE	R/W	0h	BCLK and FSYNC clock gate (valid when the device is in master mode). 0d = Do not gate BCLK and FSYNC 1d = Force gate BCLK and FSYNC when being transmitted from the device in master mode
3	FS_MODE	R/W	0h	Sample rate setting (valid when the device is in master mode). 0d = f_S is a multiple (or submultiple) of 48 kHz 1d = f_S is a multiple (or submultiple) of 44.1 kHz
2-0	MCLK_FREQ_SEL[2:0]	R/W	2h	These bits select the MCLK (GPIO or GPIx) frequency for the PLL source clock input (valid when the device is in master mode and MCLK_FREQ_SEL_MODE = 0). 0d = 12 MHz 1d = 12.288 MHz 2d = 13 MHz 3d = 16 MHz 4d = 19.2 MHz 5d = 19.68 MHz 6d = 24 MHz 7d = 24.576 MHz

8.6.1.1.17 MST_CFG1 Register (page = 0x00, address = 0x14) [reset = 48h]

This register is the ASI master mode configuration register 1.

Figure 111. MST_CFG1 Register

7	6	5	4	3	2	1	0
FS_RATE[3:0]				FS_BCLK_RATIO[3:0]			
R/W-4h				R/W-8h			

Table 70. MST_CFG1 Register Field Descriptions

Bit	Field	Type	Reset	Description
7-4	FS_RATE[3:0]	R/W	4h	Programmed sample rate of the ASI bus (not used when the device is configured in slave mode auto clock configuration). 0d = 7.35 kHz or 8 kHz 1d = 14.7 kHz or 16 kHz 2d = 22.05 kHz or 24 kHz 3d = 29.4 kHz or 32 kHz 4d = 44.1 kHz or 48 kHz 5d = 88.2 kHz or 96 kHz 6d = 176.4 kHz or 192 kHz 7d = 352.8 kHz or 384 kHz 8d = 705.6 kHz or 768 kHz 9d to 15d = Reserved
3-0	FS_BCLK_RATIO[3:0]	R/W	8h	Programmed BCLK to FSYNC frequency ratio of the ASI bus (not used when the device is configured in slave mode auto clock configuration). 0d = Ratio of 16 1d = Ratio of 24 2d = Ratio of 32 3d = Ratio of 48 4d = Ratio of 64 5d = Ratio of 96 6d = Ratio of 128 7d = Ratio of 192 8d = Ratio of 256 9d = Ratio of 384 10d = Ratio of 512 11d = Ratio of 1024 12d = Ratio of 2048 13d to 15d = Reserved

8.6.1.1.18 ASI_STS Register (page = 0x00, address = 0x15) [reset = FFh]

This register is the ASI bus clock monitor status register.

Figure 112. ASI_STS Register

7	6	5	4	3	2	1	0
FS_RATE_STS[3:0]				FS_RATIO_STS[3:0]			
R-Fh				R-Fh			

Table 71. ASI_STS Register Field Descriptions

Bit	Field	Type	Reset	Description
7-4	FS_RATE_STS[3:0]	R	Fh	Detected sample rate of the ASI bus. 0d = 7.35 kHz or 8 kHz 1d = 14.7 kHz or 16 kHz 2d = 22.05 kHz or 24 kHz 3d = 29.4 kHz or 32 kHz 4d = 44.1 kHz or 48 kHz 5d = 88.2 kHz or 96 kHz 6d = 176.4 kHz or 192 kHz 7d = 352.8 kHz or 384 kHz 8d = 705.6 kHz or 768 kHz 9d to 14d = Reserved 15d = Invalid sample rate
3-0	FS_RATIO_STS[3:0]	R	Fh	Detected BCLK to FSYNC frequency ratio of the ASI bus. 0d = Ratio of 16 1d = Ratio of 24 2d = Ratio of 32 3d = Ratio of 48 4d = Ratio of 64 5d = Ratio of 96 6d = Ratio of 128 7d = Ratio of 192 8d = Ratio of 256 9d = Ratio of 384 10d = Ratio of 512 11d = Ratio of 1024 12d = Ratio of 2048 13d to 14d = Reserved 15d = Invalid ratio

8.6.1.1.19 CLK_SRC Register (page = 0x00, address = 0x16) [reset = 10h]

This register is the clock source configuration register.

Figure 113. CLK_SRC Register

7	6	5	4	3	2	1	0
DIS_PLL_SLV_CLK_SRC	MCLK_FREQ_SEL_MODE	MCLK_RATIO_SEL[2:0]			Reserved		
R/W-0h	R/W-0h	R/W-2h			R-0h		

Table 72. CLK_SRC Register Field Descriptions

Bit	Field	Type	Reset	Description
7	DIS_PLL_SLV_CLK_SRC	R/W	0h	Audio root clock source setting when the device is configured with the PLL disabled in the auto clock configuration for slave mode (AUTO_MODE_PLL_DIS = 1). 0d = BCLK is used as the audio root clock source 1d = MCLK (GPIO or GP1x) is used as the audio root clock source (the MCLK to FSYNC ratio is as per the MCLK_RATIO_SEL setting)
6	MCLK_FREQ_SEL_MODE	R/W	0h	Master mode MCLK (GPIO or GP1x) frequency selection mode (valid when the device is in auto clock configuration). 0d = MCLK frequency is based on the MCLK_FREQ_SEL (P0_R19) configuration 1d = MCLK frequency is specified as a multiple of FSYNC in the MCLK_RATIO_SEL (P0_R22) configuration

Table 72. CLK_SRC Register Field Descriptions (continued)

Bit	Field	Type	Reset	Description
5-3	MCLK_RATIO_SEL[2:0]	R/W	2h	These bits select the MCLK (GPIO or GPIx) to FSYNC ratio for master mode or when MCLK is used as the audio root clock source in slave mode. 0d = Ratio of 64 1d = Ratio of 256 2d = Ratio of 384 3d = Ratio of 512 4d = Ratio of 768 5d = Ratio of 1024 6d = Ratio of 1536 7d = Ratio of 2304
2-0	Reserved	R	0h	Reserved

8.6.1.1.20 PDMCLK_CFG Register (page = 0x00, address = 0x1F) [reset = 40h]

This register is the PDM clock generation configuration register.

Figure 114. PDMCLK_CFG Register

7	6	5	4	3	2	1	0
Reserved						PDMCLK_DIV[1:0]	
R/W-10h						R/W-0h	

Table 73. PDMCLK_CFG Register Field Descriptions

Bit	Field	Type	Reset	Description
7-2	Reserved	R/W	10h	Reserved
1-0	PDMCLK_DIV[1:0]	R/W	0h	PDMCLK divider value. 0d = PDMCLK is 2.8224 MHz or 3.072 MHz 1d = PDMCLK is 1.4112 MHz or 1.536 MHz 2d = PDMCLK is 705.6 kHz or 768 kHz 3d = PDMCLK is 5.6448 MHz or 6.144 MHz

8.6.1.1.21 PDMIN_CFG Register (page = 0x00, address = 0x20) [reset = 0h]

This register is the PDM DINx sampling edge configuration register.

Figure 115. PDMIN_CFG Register

7	6	5	4	3	2	1	0
PDMIN1_EDGE	PDMIN2_EDGE	PDMIN3_EDGE	PDMIN4_EDGE	Reserved			
R/W-0h	R/W-0h	R/W-0h	R/W-0h	R-0h			

Table 74. PDMIN_CFG Register Field Descriptions

Bit	Field	Type	Reset	Description
7	PDMIN1_EDGE	R/W	0h	PDMCLK latching edge used for channel 1 and channel 2 data. 0d = Channel 1 data are latched on the negative edge, channel 2 data are latched on the positive edge 1d = Channel 1 data are latched on the positive edge, channel 2 data are latched on the negative edge
6	PDMIN2_EDGE	R/W	0h	PDMCLK latching edge used for channel 3 and channel 4 data. 0d = Channel 3 data are latched on the negative edge, channel 4 data are latched on the positive edge 1d = Channel 3 data are latched on the positive edge, channel 4 data are latched on the negative edge
5	PDMIN3_EDGE	R/W	0h	PDMCLK latching edge used for channel 5 and channel 6 data. 0d = Channel 5 data are latched on the negative edge, channel 6 data are latched on the positive edge 1d = Channel 5 data are latched on the positive edge, channel 6 data are latched on the negative edge

Table 74. PDMIN_CFG Register Field Descriptions (continued)

Bit	Field	Type	Reset	Description
4	PDM DIN4_EDGE	R/W	0h	PDMCLK latching edge used for channel 7 and channel 8 data. 0d = Channel 7 data are latched on the negative edge, channel 8 data are latched on the positive edge 1d = Channel 7 data are latched on the positive edge, channel 8 data are latched on the negative edge
3-0	Reserved	R	0h	Reserved

8.6.1.1.22 GPIO_CFG0 Register (page = 0x00, address = 0x21) [reset = 22h]

This register is the GPIO configuration register 0.

Figure 116. GPIO_CFG0 Register

7	6	5	4	3	2	1	0
GPIO1_CFG[3:0]				Reserved	GPIO1_DRV[2:0]		
R/W-2h				R-0h	R/W-2h		

Table 75. GPIO_CFG0 Register Field Descriptions

Bit	Field	Type	Reset	Description
7-4	GPIO1_CFG[3:0]	R/W	2h	GPIO1 configuration. 0d = GPIO1 is disabled 1d = GPIO1 is configured as a general-purpose output (GPO) 2d = GPIO1 is configured as a device interrupt output (IRQ) 3d = GPIO1 is configured as a secondary ASI output (SDOUT2) 4d = GPIO1 is configured as a PDM clock output (PDMCLK) 5d to 7d = Reserved 8d = GPIO1 is configured as an input to control when MICBIAS turns on or off (MICBIAS_EN) 9d = GPIO1 is configured as a general-purpose input (GPI) 10d = GPIO1 is configured as a master clock input (MCLK) 11d = GPIO1 is configured as an ASI input for daisy-chain (SDIN) 12d = GPIO1 is configured as a PDM data input for channel 1 and channel 2 (PDM DIN1) 13d = GPIO1 is configured as a PDM data input for channel 3 and channel 4 (PDM DIN2) 14d = GPIO1 is configured as a PDM data input for channel 5 and channel 6 (PDM DIN3) 15d = GPIO1 is configured as a PDM data input for channel 7 and channel 8 (PDM DIN4)
3	Reserved	R	0h	Reserved
2-0	GPIO1_DRV[2:0]	R/W	2h	GPIO1 output drive configuration (not used when GPIO1 is configured as SDOUT2). 0d = Hi-Z output 1d = Drive active low and active high 2d = Drive active low and weak high 3d = Drive active low and Hi-Z 4d = Drive weak low and active high 5d = Drive Hi-Z and active high 6d to 7d = Reserved

8.6.1.1.23 GPO_CFG0 Register (page = 0x00, address = 0x22) [reset = 0h]

This register is the GPO configuration register 0.

Figure 117. GPO_CFG0 Register

7	6	5	4	3	2	1	0
GPO1_CFG[3:0]				Reserved	GPO1_DRV[2:0]		
R/W-0h				R-0h	R/W-0h		

Table 76. GPO_CFG0 Register Field Descriptions

Bit	Field	Type	Reset	Description
7-4	GPO1_CFG[3:0]	R/W	0h	IN1M_GPO1 (GPO1) configuration. 0d = GPO1 is disabled 1d = GPO1 is configured as a general-purpose output (GPO) 2d = GPO1 is configured as a device interrupt output (IRQ) 3d = GPO1 is configured as a secondary ASI output (SDOUT2) 4d = GPO1 is configured as a PDM clock output (PDMCLK) 5d to 15d = Reserved
3	Reserved	R	0h	Reserved
2-0	GPO1_DRV[2:0]	R/W	0h	IN1M_GPO1 (GPO1) output drive configuration (not used when GPO1 is configured as SDOUT2). 0d = Hi-Z output 1d = Drive active low and active high 2d = Drive active low and weak high 3d = Drive active low and Hi-Z 4d = Drive weak low and active high 5d = Drive Hi-Z and active high 6d to 7d = Reserved

8.6.1.1.24 GPO_CFG1 Register (page = 0x00, address = 0x23) [reset = 0h]

This register is the GPO configuration register 1.

Figure 118. GPO_CFG1 Register

7	6	5	4	3	2	1	0
GPO2_CFG[3:0]				Reserved	GPO2_DRV[2:0]		
R/W-0h				R-0h	R/W-0h		

Table 77. GPO_CFG1 Register Field Descriptions

Bit	Field	Type	Reset	Description
7-4	GPO2_CFG[3:0]	R/W	0h	IN2M_GPO2 (GPO2) configuration. 0d = GPO2 is disabled 1d = GPO2 is configured as a general-purpose output (GPO) 2d = GPO2 is configured as a device interrupt output (IRQ) 3d = GPO2 is configured as a secondary ASI output (SDOUT2) 4d = GPO2 is configured as a PDM clock output (PDMCLK) 5d to 15d = Reserved
3	Reserved	R	0h	Reserved
2-0	GPO2_DRV[2:0]	R/W	0h	IN2M_GPO2 (GPO2) output drive configuration (not used when GPO2 is configured as SDOUT2). 0d = Hi-Z output 1d = Drive active low and active high 2d = Drive active low and weak high 3d = Drive active low and Hi-Z 4d = Drive weak low and active high 5d = Drive Hi-Z and active high 6d to 7d = Reserved

8.6.1.1.25 GPO_CFG2 Register (page = 0x00, address = 0x24) [reset = 0h]

This register is the GPO configuration register 2.

Figure 119. GPO_CFG2 Register

7	6	5	4	3	2	1	0
GPO3_CFG[3:0]				Reserved	GPO3_DRV[2:0]		
R/W-0h				R-0h	R/W-0h		

Table 78. GPO_CFG2 Register Field Descriptions

Bit	Field	Type	Reset	Description
7-4	GPO3_CFG[3:0]	R/W	0h	IN3M_GPO3 (GPO3) configuration. 0d = GPO3 is disabled 1d = GPO3 is configured as a general-purpose output (GPO) 2d = GPO3 is configured as a device interrupt output (IRQ) 3d = GPO3 is configured as a secondary ASI output (SDOUT2) 4d = GPO3 is configured as a PDM clock output (PDMCLK) 5d to 15d = Reserved
3	Reserved	R	0h	Reserved
2-0	GPO3_DRV[2:0]	R/W	0h	IN3M_GPO3 (GPO3) output drive configuration (not used when GPO3 is configured as SDOUT2). 0d = Hi-Z output 1d = Drive active low and active high 2d = Drive active low and weak high 3d = Drive active low and Hi-Z 4d = Drive weak low and active high 5d = Drive Hi-Z and active high 6d to 7d = Reserved

8.6.1.1.26 GPO_CFG3 Register (page = 0x00, address = 0x25) [reset = 0h]

This register is the GPO configuration register 3.

Figure 120. GPO_CFG3 Register

7	6	5	4	3	2	1	0
GPO4_CFG[3:0]				Reserved	GPO4_DRV[2:0]		
R/W-0h				R-0h	R/W-0h		

Table 79. GPO_CFG3 Register Field Descriptions

Bit	Field	Type	Reset	Description
7-4	GPO4_CFG[3:0]	R/W	0h	IN4M_GPO4 (GPO4) configuration. 0d = GPO4 is disabled 1d = GPO4 is configured as a general-purpose output (GPO) 2d = GPO4 is configured as a device interrupt output (IRQ) 3d = GPO4 is configured as a secondary ASI output (SDOUT2) 4d = GPO4 is configured as a PDM clock output (PDMCLK) 5d to 15d = Reserved
3	Reserved	R	0h	Reserved
2-0	GPO4_DRV[2:0]	R/W	0h	IN4M_GPO4 (GPO4) output drive configuration (not used when GPO4 is configured as SDOUT2). 0d = Hi-Z output 1d = Drive active low and active high 2d = Drive active low and weak high 3d = Drive active low and Hi-Z 4d = Drive weak low and active high 5d = Drive Hi-Z and active high 6d to 7d = Reserved

8.6.1.1.27 GPO_VAL Register (page = 0x00, address = 0x29) [reset = 0h]

This register is the GPIO and GPO output value register.

Figure 121. GPO_VAL Register

7	6	5	4	3	2	1	0
GPIO1_VAL	GPO1_VAL	GPO2_VAL	GPO3_VAL	GPO4_VAL	Reserved		
R/W-0h	R/W-0h	R/W-0h	R/W-0h	R/W-0h	R-0h		

Table 80. GPO_VAL Register Field Descriptions

Bit	Field	Type	Reset	Description
7	GPIO1_VAL	R/W	0h	GPIO1 output value when configured as a GPO. 0d = Drive the output with a value of 0 1d = Drive the output with a value of 1
6	GPO1_VAL	R/W	0h	GPO1 output value when configured as a GPO. 0d = Drive the output with a value of 0 1d = Drive the output with a value of 1
5	GPO2_VAL	R/W	0h	GPO2 output value when configured as a GPO. 0d = Drive the output with a value of 0 1d = Drive the output with a value of 1
4	GPO3_VAL	R/W	0h	GPO3 output value when configured as a GPO. 0d = Drive the output with a value of 0 1d = Drive the output with a value of 1
3	GPO4_VAL	R/W	0h	GPO4 output value when configured as a GPO. 0d = Drive the output with a value of 0 1d = Drive the output with a value of 1
2-0	Reserved	R	0h	Reserved

8.6.1.1.28 GPIO_MON Register (page = 0x00, address = 0x2A) [reset = 0h]

This register is the GPIO monitor value register.

Figure 122. GPIO_MON Register

7	6	5	4	3	2	1	0
GPIO1_MON	Reserved						
R-0h	R-0h						

Table 81. GPIO_MON Register Field Descriptions

Bit	Field	Type	Reset	Description
7	GPIO1_MON	R	0h	GPIO1 monitor value when configured as a GPI. 0d = Input monitor value 0 1d = Input monitor value 1
6-0	Reserved	R	0h	Reserved

8.6.1.1.29 GPI_CFG0 Register (page = 0x00, address = 0x2B) [reset = 0h]

This register is the GPI configuration register 0.

Figure 123. GPI_CFG0 Register

7	6	5	4	3	2	1	0
Reserved	GPI1_CFG[2:0]			Reserved	GPI2_CFG[2:0]		
R-0h	R/W-0h			R-0h	R/W-0h		

Table 82. GPI_CFG0 Register Field Descriptions

Bit	Field	Type	Reset	Description
7	Reserved	R	0h	Reserved
6-4	GPI1_CFG[2:0]	R/W	0h	IN1P_GPI1 (GPI1) configuration. 0d = GPI1 is disabled 1d = GPI1 is configured as a general-purpose input (GPI) 2d = GPI1 is configured as a master clock input (MCLK) 3d = GPI1 is configured as an ASI input for daisy-chain (SDIN) 4d = GPI1 is configured as a PDM data input for channel 1 and channel 2 (PDMDIN1) 5d = GPI1 is configured as a PDM data input for channel 3 and channel 4 (PDMDIN2) 6d = GPI1 is configured as a PDM data input for channel 5 and channel 6 (PDMDIN3) 7d = GPI1 is configured as a PDM data input for channel 7 and channel 8 (PDMDIN4)
3	Reserved	R	0h	Reserved
2-0	GPI2_CFG[2:0]	R/W	0h	IN2P_GPI2 (GPI2) configuration. 0d = GPI2 is disabled 1d = GPI2 is configured as a general-purpose input (GPI) 2d = GPI2 is configured as a master clock input (MCLK) 3d = GPI2 is configured as an ASI input for daisy-chain (SDIN) 4d = GPI2 is configured as a PDM data input for channel 1 and channel 2 (PDMDIN1) 5d = GPI2 is configured as a PDM data input for channel 3 and channel 4 (PDMDIN2) 6d = GPI2 is configured as a PDM data input for channel 5 and channel 6 (PDMDIN3) 7d = GPI2 is configured as a PDM data input for channel 7 and channel 8 (PDMDIN4)

8.6.1.1.30 GPI_CFG1 Register (page = 0x00, address = 0x2C) [reset = 0h]

This register is the GPI configuration register 1.

Figure 124. GPI_CFG1 Register

7	6	5	4	3	2	1	0
Reserved	GPI3_CFG[2:0]			Reserved	GPI4_CFG[2:0]		
R-0h	R/W-0h			R-0h	R/W-0h		

Table 83. GPI_CFG1 Register Field Descriptions

Bit	Field	Type	Reset	Description
7	Reserved	R	0h	Reserved
6-4	GPI3_CFG[2:0]	R/W	0h	IN3P_GPI3 (GPI3) configuration. 0d = GPI3 is disabled 1d = GPI3 is configured as a general-purpose input (GPI) 2d = GPI3 is configured as a master clock input (MCLK) 3d = GPI3 is configured as an ASI input for daisy-chain (SDIN) 4d = GPI3 is configured as a PDM data input for channel 1 and channel 2 (PDMDIN1) 5d = GPI3 is configured as a PDM data input for channel 3 and channel 4 (PDMDIN2) 6d = GPI3 is configured as a PDM data input for channel 5 and channel 6 (PDMDIN3) 7d = GPI3 is configured as a PDM data input for channel 7 and channel 8 (PDMDIN4)
3	Reserved	R	0h	Reserved

Table 83. GPI_CFG1 Register Field Descriptions (continued)

Bit	Field	Type	Reset	Description
2-0	GPI4_CFG[2:0]	R/W	0h	IN4P_GPI4 (GPI4) configuration. 0d = GPI4 is disabled 1d = GPI4 is configured as a general-purpose input (GPI) 2d = GPI4 is configured as a master clock input (MCLK) 3d = GPI4 is configured as an ASI input for daisy-chain (SDIN) 4d = GPI4 is configured as a PDM data input for channel 1 and channel 2 (PDM DIN1) 5d = GPI4 is configured as a PDM data input for channel 3 and channel 4 (PDM DIN2) 6d = GPI4 is configured as a PDM data input for channel 5 and channel 6 (PDM DIN3) 7d = GPI4 is configured as a PDM data input for channel 7 and channel 8 (PDM DIN4)

8.6.1.1.31 GPI_MON Register (page = 0x00, address = 0x2F) [reset = 0h]

This register is the GPI monitor value register.

Figure 125. GPI_MON Register

7	6	5	4	3	2	1	0
GPI1_MON	GPI2_MON	GPI3_MON	GPI4_MON	Reserved			
R-0h	R-0h	R-0h	R-0h	R-0h			

Table 84. GPI_MON Register Field Descriptions

Bit	Field	Type	Reset	Description
7	GPI1_MON	R	0h	GPI1 monitor value when configured as a GPI. 0d = Input monitor value 0 1d = Input monitor value 1
6	GPI2_MON	R	0h	GPI2 monitor value when configured as a GPI. 0d = Input monitor value 0 1d = Input monitor value 1
5	GPI3_MON	R	0h	GPI3 monitor value when configured as a GPI. 0d = Input monitor value 0 1d = Input monitor value 1
4	GPI4_MON	R	0h	GPI4 monitor value when configured as a GPI. 0d = Input monitor value 0 1d = Input monitor value 1
3-0	Reserved	R	0h	Reserved

8.6.1.1.32 INT_CFG Register (page = 0x00, address = 0x32) [reset = 0h]

This register is the interrupt configuration register.

Figure 126. INT_CFG Register

7	6	5	4	3	2	1	0
INT_POL	INT_EVENT[1:0]		Reserved		LTCH_READ_CFG	Reserved	
R/W-0h	R/W-0h		R-0h		R/W-0h	R-0h	

Table 85. INT_CFG Register Field Descriptions

Bit	Field	Type	Reset	Description
7	INT_POL	R/W	0h	Interrupt polarity. 0b = Active low (IRQZ) 1b = Active high (IRQ)

Table 85. INT_CFG Register Field Descriptions (continued)

Bit	Field	Type	Reset	Description
6-5	INT_EVENT[1:0]	R/W	0h	Interrupt event configuration. 0d = INT asserts on any unmasked latched interrupts event 1d = Reserved 2d = INT asserts for 2 ms (typical) for every 4-ms (typical) duration on any unmasked latched interrupts event 3d = INT asserts for 2 ms (typical) one time on each pulse for any unmasked interrupts event
4-3	Reserved	R	0h	Reserved
2	LTCH_READ_CFG	R/W	0h	Interrupt latch registers readback configuration. 0b = All interrupts can be read through the LTCH registers 1b = Only unmasked interrupts can be read through the LTCH registers
1-0	Reserved	R	0h	Reserved

8.6.1.1.33 INT_MASK0 Register (page = 0x00, address = 0x33) [reset = FFh]

This register is the interrupt masks register 0.

Figure 127. INT_MASK0 Register

7	6	5	4	3	2	1	0
INT_MASK0[7]	INT_MASK0[6]	Reserved					
R/W-1h	R/W-1h	R/W-3Fh					

Table 86. INT_MASK0 Register Field Descriptions

Bit	Field	Type	Reset	Description
7	INT_MASK0[7]	R/W	1h	ASI clock error mask. 0b = Do not mask 1b = Mask
6	INT_MASK0[6]	R/W	1h	PLL lock interrupt mask. 0b = Do not mask 1b = Mask
5-0	Reserved	R/W	3Fh	Reserved

8.6.1.1.34 INT_LTCH0 Register (page = 0x00, address = 0x36) [reset = 0h]

This register is the latched interrupt readback register 0.

Figure 128. INT_LTCH0 Register

7	6	5	4	3	2	1	0
INT_LTCH0[7]	INT_LTCH0[6]	Reserved					
R-0h	R-0h	R-0h					

Table 87. INT_LTCH0 Register Field Descriptions

Bit	Field	Type	Reset	Description
7	INT_LTCH0[7]	R	0h	Interrupt caused by an ASI bus clock error (self-clearing bit). 0b = No interrupt 1b = Interrupt
6	INT_LTCH0[6]	R	0h	Interrupt caused by PLL LOCK (self-clearing bit). 0b = No interrupt 1b = Interrupt
5-0	Reserved	R	0h	Reserved

8.6.1.1.35 BIAS_CFG Register (page = 0x00, address = 0x3B) [reset = 0h]

This register is the bias and ADC configuration register.

Figure 129. BIAS_CFG Register

7	6	5	4	3	2	1	0
Reserved	MIBIAS_VAL[2:0]			Reserved		ADC_FSCALE[1:0]	
R-0h	R/W-0h			R-0h		R/W-0h	

Table 88. BIAS_CFG Register Field Descriptions

Bit	Field	Type	Reset	Description
7	Reserved	R	0h	Reserved
6-4	MIBIAS_VAL[2:0]	R/W	0h	MICBIAS value. 0d = Microphone bias is set to VREF (2.750 V, 2.500 V, or 1.375 V) 1d = Microphone bias is set to VREF × 1.096 (3.014 V, 2.740 V, or 1.507 V) 2d to 5d = Reserved 6d = Microphone bias is set to AVDD
3-2	Reserved	R	0h	Reserved
1-0	ADC_FSCALE[1:0]	R/W	0h	ADC full-scale setting (configure this setting based on the AVDD supply minimum voltage used). 0d = VREF is set to 2.75 V to support 2 V _{RMS} for the differential input or 1 V _{RMS} for the single-ended input 1d = VREF is set to 2.5 V to support 1.818 V _{RMS} for the differential input or 0.909 V _{RMS} for the single-ended input 2d = VREF is set to 1.375 V to support 1 V _{RMS} for the differential input or 0.5 V _{RMS} for the single-ended input 3d = Reserved

8.6.1.1.36 CH1_CFG0 Register (page = 0x00, address = 0x3C) [reset = 0h]

This register is configuration register 0 for channel 1.

Figure 130. CH1_CFG0 Register

7	6	5	4	3	2	1	0
CH1_INTYP	CH1_INSRC[1:0]		CH1_DC	CH1_IMP[1:0]		Reserved	CH1_DREEN
R/W-0h	R/W-0h		R/W-0h	R/W-0h		R-0h	R/W-0h

Table 89. CH1_CFG0 Register Field Descriptions

Bit	Field	Type	Reset	Description
7	CH1_INTYP	R/W	0h	Channel 1 input type. 0d = Microphone input 1d = Line input
6-5	CH1_INSRC[1:0]	R/W	0h	Channel 1 input configuration. 0d = Analog differential input (the GPI1 and GPO1 pin functions must be disabled) 1d = Analog single-ended input (the GPI1 and GPO1 pin functions must be disabled) 2d = Digital microphone PDM input (configure the GPO and GPI pins accordingly for PDMIN1 and PDMCLK) 3d = Reserved
4	CH1_DC	R/W	0h	Channel 1 input coupling (applicable for the analog input). 0d = AC-coupled input 1d = DC-coupled input
3-2	CH1_IMP[1:0]	R/W	0h	Channel 1 input impedance (applicable for the analog input). 0d = Typical 2.5-kΩ input impedance 1d = Typical 10-kΩ input impedance 2d = Typical 20-kΩ input impedance 3d = Reserved
1	Reserved	R	0h	Reserved
0	CH1_DREEN	R/W	0h	Channel 1 dynamic range enhancer (DRE) and automatic gain controller (AGC) setting. 0d = DRE and AGC disabled 1d = DRE or AGC enabled based on the configuration of bit 3 in register 108 (P0_R108)

8.6.1.1.37 CH1_CFG1 Register (page = 0x00, address = 0x3D) [reset = 0h]

This register is configuration register 1 for channel 1.

Figure 131. CH1_CFG1 Register

7	6	5	4	3	2	1	0
CH1_GAIN[5:0]						Reserved	
R/W-0h						R-0h	

Table 90. CH1_CFG1 Register Field Descriptions

Bit	Field	Type	Reset	Description
7-2	CH1_GAIN[5:0]	R/W	0h	Channel 1 gain. 0d = Channel gain is set to 0 dB 1d = Channel gain is set to 1 dB 2d = Channel gain is set to 2 dB 3d to 41d = Channel gain is set as per configuration 42d = Channel gain is set to 42 dB 43d to 63d = Reserved
1-0	Reserved	R	0h	Reserved

8.6.1.1.38 CH1_CFG2 Register (page = 0x00, address = 0x3E) [reset = C9h]

This register is configuration register 2 for channel 1.

Figure 132. CH1_CFG2 Register

7	6	5	4	3	2	1	0
CH1_DVOL[7:0]							
R/W-C9h							

Table 91. CH1_CFG2 Register Field Descriptions

Bit	Field	Type	Reset	Description
7-0	CH1_DVOL[7:0]	R/W	C9h	Channel 1 digital volume control. 0d = Digital volume is muted 1d = Digital volume control is set to –100 dB 2d = Digital volume control is set to –99.5 dB 3d to 200d = Digital volume control is set as per configuration 201d = Digital volume control is set to 0 dB 202d = Digital volume control is set to 0.5 dB 203d to 253d = Digital volume control is set as per configuration 254d = Digital volume control is set to 26.5 dB 255d = Digital volume control is set to 27 dB

8.6.1.1.39 CH1_CFG3 Register (page = 0x00, address = 0x3F) [reset = 80h]

This register is configuration register 3 for channel 1.

Figure 133. CH1_CFG3 Register

7	6	5	4	3	2	1	0
CH1_GCAL[3:0]				Reserved			
R/W-8h				R-0h			

Table 92. CH1_CFG3 Register Field Descriptions

Bit	Field	Type	Reset	Description
7-4	CH1_GCAL[3:0]	R/W	8h	Channel 1 gain calibration. 0d = Gain calibration is set to –0.8 dB 1d = Gain calibration is set to –0.7 dB 2d = Gain calibration is set to –0.6 dB 3d to 7d = Gain calibration is set as per configuration 8d = Gain calibration is set to 0 dB 9d = Gain calibration is set to 0.1 dB 10d to 13d = Gain calibration is set as per configuration 14d = Gain calibration is set to 0.6 dB 15d = Gain calibration is set to 0.7 dB
3-0	Reserved	R	0h	Reserved

8.6.1.1.40 CH1_CFG4 Register (page = 0x00, address = 0x40) [reset = 0h]

This register is configuration register 4 for channel 1.

Figure 134. CH1_CFG4 Register

7	6	5	4	3	2	1	0
CH1_PCAL[7:0]							
R/W-0h							

Table 93. CH1_CFG4 Register Field Descriptions

Bit	Field	Type	Reset	Description
7-0	CH1_PCAL[7:0]	R/W	0h	Channel 1 phase calibration with modulator clock resolution. 0d = No phase calibration 1d = Phase calibration delay is set to one cycle of the modulator clock 2d = Phase calibration delay is set to two cycles of the modulator clock 3d to 254d = Phase calibration delay as per configuration 255d = Phase calibration delay is set to 255 cycles of the modulator clock

8.6.1.1.41 CH2_CFG0 Register (page = 0x00, address = 0x41) [reset = 0h]

This register is configuration register 0 for channel 2.

Figure 135. CH2_CFG0 Register

7	6	5	4	3	2	1	0
CH2_INTYP	CH2_INSRC[1:0]		CH2_DC	CH2_IMP[1:0]		Reserved	CH2_DREEN
R/W-0h	R/W-0h		R/W-0h	R/W-0h		R-0h	R/W-0h

Table 94. CH2_CFG0 Register Field Descriptions

Bit	Field	Type	Reset	Description
7	CH2_INTYP	R/W	0h	Channel 2 input type. 0d = Microphone input 1d = Line input
6-5	CH2_INSRC[1:0]	R/W	0h	Channel 2 input configuration. 0d = Analog differential input (the GPI2 and GPO2 pin functions must be disabled) 1d = Analog single-ended input (the GPI2 and GPO2 pin functions must be disabled) 2d = Digital microphone PDM input (configure the GPO and GPI pins accordingly for PDMIN1 and PDMCLK) 3d = Reserved
4	CH2_DC	R/W	0h	Channel 2 input coupling (applicable for the analog input). 0d = AC-coupled input 1d = DC-coupled input

Table 94. CH2_CFG0 Register Field Descriptions (continued)

Bit	Field	Type	Reset	Description
3-2	CH2_IMP[1:0]	R/W	0h	Channel 2 input impedance (applicable for the analog input). 0d = Typical 2.5-kΩ input impedance 1d = Typical 10-kΩ input impedance 2d = Typical 20-kΩ input impedance 3d = Reserved
1	Reserved	R	0h	Reserved
0	CH2_DREEN	R/W	0h	Channel 2 dynamic range enhancer (DRE) and automatic gain controller (AGC) setting. 0d = DRE and AGC disabled 1d = DRE or AGC enabled based on the configuration of bit 3 in register 108 (P0_R108)

8.6.1.1.42 CH2_CFG1 Register (page = 0x00, address = 0x42) [reset = 0h]

This register is configuration register 1 for channel 2.

Figure 136. CH2_CFG1 Register

7	6	5	4	3	2	1	0
CH2_GAIN[5:0]						Reserved	
R/W-0h						R-0h	

Table 95. CH2_CFG1 Register Field Descriptions

Bit	Field	Type	Reset	Description
7-2	CH2_GAIN[5:0]	R/W	0h	Channel 2 gain. 0d = Channel gain is set to 0 dB 1d = Channel gain is set to 1 dB 2d = Channel gain is set to 2 dB 3d to 41d = Channel gain is set as per configuration 42d = Channel gain is set to 42 dB 43d to 63d = Reserved
1-0	Reserved	R	0h	Reserved

8.6.1.1.43 CH2_CFG2 Register (page = 0x00, address = 0x43) [reset = C9h]

This register is configuration register 2 for channel 2.

Figure 137. CH2_CFG2 Register

7	6	5	4	3	2	1	0
CH2_DVOL[7:0]							
R/W-C9h							

Table 96. CH2_CFG2 Register Field Descriptions

Bit	Field	Type	Reset	Description
7-0	CH2_DVOL[7:0]	R/W	C9h	Channel 2 digital volume control. 0d = Digital volume is muted 1d = Digital volume control is set to –100 dB 2d = Digital volume control is set to –99.5 dB 3d to 200d = Digital volume control is set as per configuration 201d = Digital volume control is set to 0 dB 202d = Digital volume control is set to 0.5 dB 203d to 253d = Digital volume control is set as per configuration 254d = Digital volume control is set to 26.5 dB 255d = Digital volume control is set to 27 dB

8.6.1.1.44 CH2_CFG3 Register (page = 0x00, address = 0x44) [reset = 80h]

This register is configuration register 3 for channel 2.

Figure 138. CH2_CFG3 Register

7	6	5	4	3	2	1	0
CH2_GCAL[3:0]				Reserved			
R/W-8h				R-0h			

Table 97. CH2_CFG3 Register Field Descriptions

Bit	Field	Type	Reset	Description
7-4	CH2_GCAL[3:0]	R/W	8h	Channel 2 gain calibration. 0d = Gain calibration is set to –0.8 dB 1d = Gain calibration is set to –0.7 dB 2d = Gain calibration is set to –0.6 dB 3d to 7d = Gain calibration is set as per configuration 8d = Gain calibration is set to 0 dB 9d = Gain calibration is set to 0.1 dB 10d to 13d = Gain calibration is set as per configuration 14d = Gain calibration is set to 0.6 dB 15d = Gain calibration is set to 0.7 dB
3-0	Reserved	R	0h	Reserved

8.6.1.1.45 CH2_CFG4 Register (page = 0x00, address = 0x45) [reset = 0h]

This register is configuration register 4 for channel 2.

Figure 139. CH2_CFG4 Register

7	6	5	4	3	2	1	0
CH2_PCAL[7:0]							
R/W-0h							

Table 98. CH2_CFG4 Register Field Descriptions

Bit	Field	Type	Reset	Description
7-0	CH2_PCAL[7:0]	R/W	0h	Channel 2 phase calibration with modulator clock resolution. 0d = No phase calibration 1d = Phase calibration delay is set to one cycle of the modulator clock 2d = Phase calibration delay is set to two cycles of the modulator clock 3d to 254d = Phase calibration delay as per configuration 255d = Phase calibration delay is set to 255 cycles of the modulator clock

8.6.1.1.46 CH3_CFG0 Register (page = 0x00, address = 0x46) [reset = 0h]

This register is configuration register 0 for channel 3.

Figure 140. CH3_CFG0 Register

7	6	5	4	3	2	1	0
CH3_INTYP	CH3_INSRC[1:0]		CH3_DC	CH3_IMP[1:0]		Reserved	CH3_DREEN
R/W-0h	R/W-0h		R/W-0h	R/W-0h		R-0h	R/W-0h

Table 99. CH3_CFG0 Register Field Descriptions

Bit	Field	Type	Reset	Description
7	CH3_INTYP	R/W	0h	Channel 3 input type. 0d = Microphone input 1d = Line input

Table 99. CH3_CFG0 Register Field Descriptions (continued)

Bit	Field	Type	Reset	Description
6-5	CH3_INSRC[1:0]	R/W	0h	Channel 3 input configuration. 0d = Analog differential input (the GPI3 and GPO3 pin functions must be disabled) 1d = Analog single-ended input (the GPI3 and GPO3 pin functions must be disabled) 2d = Digital microphone PDM input (configure the GPO and GPI pins accordingly for PDMDIN2 and PDMCLK) 3d = Reserved
4	CH3_DC	R/W	0h	Channel 3 input coupling (applicable for the analog input). 0d = AC-coupled input 1d = DC-coupled input
3-2	CH3_IMP[1:0]	R/W	0h	Channel 3 input impedance (applicable for the analog input). 0d = Typical 2.5-kΩ input impedance 1d = Typical 10-kΩ input impedance 2d = Typical 20-kΩ input impedance 3d = Reserved
1	Reserved	R	0h	Reserved
0	CH3_DREEN	R/W	0h	Channel 3 dynamic range enhancer (DRE) and automatic gain controller (AGC) setting. 0d = DRE and AGC disabled 1d = DRE or AGC enabled based on the configuration of bit 3 in register 108 (P0_R108)

8.6.1.1.47 CH3_CFG1 Register (page = 0x00, address = 0x47) [reset = 0h]

This register is configuration register 1 for channel 3.

Figure 141. CH3_CFG1 Register

7	6	5	4	3	2	1	0
CH3_GAIN[5:0]						Reserved	
R/W-0h						R-0h	

Table 100. CH3_CFG1 Register Field Descriptions

Bit	Field	Type	Reset	Description
7-2	CH3_GAIN[5:0]	R/W	0h	Channel 3 gain. 0d = Channel gain is set to 0 dB 1d = Channel gain is set to 1 dB 2d = Channel gain is set to 2 dB 3d to 41d = Channel gain is set as per configuration 42d = Channel gain is set to 42 dB 43d to 63d = Reserved
1-0	Reserved	R	0h	Reserved

8.6.1.1.48 CH3_CFG2 Register (page = 0x00, address = 0x48) [reset = C9h]

This register is configuration register 2 for channel 3.

Figure 142. CH3_CFG2 Register

7	6	5	4	3	2	1	0
CH3_DVOL[7:0]							
R/W-C9h							

Table 101. CH3_CFG2 Register Field Descriptions

Bit	Field	Type	Reset	Description
7-0	CH3_DVOL[7:0]	R/W	C9h	Channel 3 digital volume control. 0d = Digital volume is muted 1d = Digital volume control is set to –100 dB 2d = Digital volume control is set to –99.5 dB 3d to 200d = Digital volume control is set as per configuration 201d = Digital volume control is set to 0 dB 202d = Digital volume control is set to 0.5 dB 203d to 253d = Digital volume control is set as per configuration 254d = Digital volume control is set to 26.5 dB 255d = Digital volume control is set to 27 dB

8.6.1.1.49 CH3_CFG3 Register (page = 0x00, address = 0x49) [reset = 80h]

This register is configuration register 3 for channel 3.

Figure 143. CH3_CFG3 Register

7	6	5	4	3	2	1	0
CH3_GCAL[3:0]				Reserved			
R/W-8h				R-0h			

Table 102. CH3_CFG3 Register Field Descriptions

Bit	Field	Type	Reset	Description
7-4	CH3_GCAL[3:0]	R/W	8h	Channel 3 gain calibration. 0d = Gain calibration is set to –0.8 dB 1d = Gain calibration is set to –0.7 dB 2d = Gain calibration is set to –0.6 dB 3d to 7d = Gain calibration is set as per configuration 8d = Gain calibration is set to 0 dB 9d = Gain calibration is set to 0.1 dB 10d to 13d = Gain calibration is set as per configuration 14d = Gain calibration is set to 0.6 dB 15d = Gain calibration is set to 0.7 dB
3-0	Reserved	R	0h	Reserved

8.6.1.1.50 CH3_CFG4 Register (page = 0x00, address = 0x4A) [reset = 0h]

This register is configuration register 4 for channel 3.

Figure 144. CH3_CFG4 Register

7	6	5	4	3	2	1	0
CH3_PCAL[7:0]							
R/W-0h							

Table 103. CH3_CFG4 Register Field Descriptions

Bit	Field	Type	Reset	Description
7-0	CH3_PCAL[7:0]	R/W	0h	Channel 3 phase calibration with modulator clock resolution. 0d = No phase calibration 1d = Phase calibration delay is set to one cycle of the modulator clock 2d = Phase calibration delay is set to two cycles of the modulator clock 3d to 254d = Phase calibration delay as per configuration 255d = Phase calibration delay is set to 255 cycles of the modulator clock

8.6.1.1.51 CH4_CFG0 Register (page = 0x00, address = 0x4B) [reset = 0h]

This register is configuration register 0 for channel 4.

Figure 145. CH4_CFG0 Register

7	6	5	4	3	2	1	0
CH4_INTYP	CH4_INSRC[1:0]		CH4_DC	CH4_IMP[1:0]		Reserved	CH4_DREEN
R/W-0h	R/W-0h		R/W-0h	R/W-0h		R-0h	R/W-0h

Table 104. CH4_CFG0 Register Field Descriptions

Bit	Field	Type	Reset	Description
7	CH4_INTYP	R/W	0h	Channel 4 input type. 0d = Microphone input 1d = Line input
6-5	CH4_INSRC[1:0]	R/W	0h	Channel 4 input configuration. 0d = Analog differential input (the GPI4 and GPO4 pin functions must be disabled) 1d = Analog single-ended input (the GPI4 and GPO4 pin functions must be disabled) 2d = Digital microphone PDM input (configure the GPO and GPI pins accordingly for PDMDIN2 and PDMCLK) 3d = Reserved
4	CH4_DC	R/W	0h	Channel 4 input coupling (applicable for the analog input). 0d = AC-coupled input 1d = DC-coupled input
3-2	CH4_IMP[1:0]	R/W	0h	Channel 4 input impedance (applicable for the analog input). 0d = Typical 2.5-k Ω input impedance 1d = Typical 10-k Ω input impedance 2d = Typical 20-k Ω input impedance 3d = Reserved
1	Reserved	R	0h	Reserved
0	CH4_DREEN	R/W	0h	Channel 4 dynamic range enhancer (DRE) and automatic gain controller (AGC) setting. 0d = DRE and AGC disabled 1d = DRE or AGC enabled based on the configuration of bit 3 in register 108 (P0_R108)

8.6.1.1.52 CH4_CFG1 Register (page = 0x00, address = 0x4C) [reset = 0h]

This register is configuration register 1 for channel 4.

Figure 146. CH4_CFG1 Register

7	6	5	4	3	2	1	0
CH4_GAIN[5:0]						Reserved	
R/W-0h						R-0h	

Table 105. CH4_CFG1 Register Field Descriptions

Bit	Field	Type	Reset	Description
7-2	CH4_GAIN[5:0]	R/W	0h	Channel 4 gain. 0d = Channel gain is set to 0 dB 1d = Channel gain is set to 1 dB 2d = Channel gain is set to 2 dB 3d to 41d = Channel gain is set as per configuration 42d = Channel gain is set to 42 dB 43d to 63d = Reserved
1-0	Reserved	R	0h	Reserved

8.6.1.1.53 CH4_CFG2 Register (page = 0x00, address = 0x4D) [reset = C9h]

This register is configuration register 2 for channel 4.

Figure 147. CH4_CFG2 Register

7	6	5	4	3	2	1	0
CH4_DVOL[7:0]							
R/W-C9h							

Table 106. CH4_CFG2 Register Field Descriptions

Bit	Field	Type	Reset	Description
7-0	CH4_DVOL[7:0]	R/W	C9h	Channel 4 digital volume control. 0d = Digital volume is muted 1d = Digital volume control is set to –100 dB 2d = Digital volume control is set to –99.5 dB 3d to 200d = Digital volume control is set as per configuration 201d = Digital volume control is set to 0 dB 202d = Digital volume control is set to 0.5 dB 203d to 253d = Digital volume control is set as per configuration 254d = Digital volume control is set to 26.5 dB 255d = Digital volume control is set to 27 dB

8.6.1.1.54 CH4_CFG3 Register (page = 0x00, address = 0x4E) [reset = 80h]

This register is configuration register 3 for channel 4.

Figure 148. CH4_CFG3 Register

7	6	5	4	3	2	1	0
CH4_GCAL[3:0]				Reserved			
R/W-8h				R-0h			

Table 107. CH4_CFG3 Register Field Descriptions

Bit	Field	Type	Reset	Description
7-4	CH4_GCAL[3:0]	R/W	8h	Channel 4 gain calibration. 0d = Gain calibration is set to –0.8 dB 1d = Gain calibration is set to –0.7 dB 2d = Gain calibration is set to –0.6 dB 3d to 7d = Gain calibration is set as per configuration 8d = Gain calibration is set to 0 dB 9d = Gain calibration is set to 0.1 dB 10d to 13d = Gain calibration is set as per configuration 14d = Gain calibration is set to 0.6 dB 15d = Gain calibration is set to 0.7 dB
3-0	Reserved	R	0h	Reserved

8.6.1.1.55 CH4_CFG4 Register (page = 0x00, address = 0x4F) [reset = 0h]

This register is configuration register 4 for channel 4.

Figure 149. CH4_CFG4 Register

7	6	5	4	3	2	1	0
CH4_PCAL[7:0]							
R/W-0h							

Table 108. CH4_CFG4 Register Field Descriptions

Bit	Field	Type	Reset	Description
7-0	CH4_PCAL[7:0]	R/W	0h	Channel 4 phase calibration with modulator clock resolution. 0d = No phase calibration 1d = Phase calibration delay is set to one cycle of the modulator clock 2d = Phase calibration delay is set to two cycles of the modulator clock 3d to 254d = Phase calibration delay as per configuration 255d = Phase calibration delay is set to 255 cycles of the modulator clock

8.6.1.1.56 CH5_CFG2 Register (page = 0x00, address = 0x52) [reset = C9h]

This register is configuration register 2 for channel 5 (for the digital microphone PDM input only).

Figure 150. CH5_CFG2 Register

7	6	5	4	3	2	1	0
CH5_DVOL[7:0]							
R/W-C9h							

Table 109. CH5_CFG2 Register Field Descriptions

Bit	Field	Type	Reset	Description
7-0	CH5_DVOL[7:0]	R/W	C9h	Channel 5 digital volume control. 0d = Digital volume is muted 1d = Digital volume control is set to -100 dB 2d = Digital volume control is set to -99.5 dB 3d to 200d = Digital volume control is set as per configuration 201d = Digital volume control is set to 0 dB 202d = Digital volume control is set to 0.5 dB 203d to 253d = Digital volume control is set as per configuration 254d = Digital volume control is set to 26.5 dB 255d = Digital volume control is set to 27 dB

8.6.1.1.57 CH5_CFG3 Register (page = 0x00, address = 0x53) [reset = 80h]

This register is configuration register 3 for channel 5 (for the digital microphone PDM input only).

Figure 151. CH5_CFG3 Register

7	6	5	4	3	2	1	0
CH5_GCAL[3:0]				Reserved			
R/W-8h				R-0h			

Table 110. CH5_CFG3 Register Field Descriptions

Bit	Field	Type	Reset	Description
7-4	CH5_GCAL[3:0]	R/W	8h	Channel 5 gain calibration. 0d = Gain calibration is set to -0.8 dB 1d = Gain calibration is set to -0.7 dB 2d = Gain calibration is set to -0.6 dB 3d to 7d = Gain calibration is set as per configuration 8d = Gain calibration is set to 0 dB 9d = Gain calibration is set to 0.1 dB 10d to 13d = Gain calibration is set as per configuration 14d = Gain calibration is set to 0.6 dB 15d = Gain calibration is set to 0.7 dB
3-0	Reserved	R	0h	Reserved

8.6.1.1.58 CH5_CFG4 Register (page = 0x00, address = 0x54) [reset = 0h]

This register is configuration register 4 for channel 5 (for the digital microphone PDM input only).

Figure 152. CH5_CFG4 Register

7	6	5	4	3	2	1	0
CH5_PCAL[7:0]							
R/W-0h							

Table 111. CH5_CFG4 Register Field Descriptions

Bit	Field	Type	Reset	Description
7-0	CH5_PCAL[7:0]	R/W	0h	Channel 5 phase calibration with modulator clock resolution. 0d = No phase calibration 1d = Phase calibration delay is set to one cycle of the modulator clock 2d = Phase calibration delay is set to two cycles of the modulator clock 3d to 254d = Phase calibration delay as per configuration 255d = Phase calibration delay is set to 255 cycles of the modulator clock

8.6.1.1.59 CH6_CFG2 Register (page = 0x00, address = 0x57) [reset = C9h]

This register is configuration register 2 for channel 6 (for the digital microphone PDM input only).

Figure 153. CH6_CFG2 Register

7	6	5	4	3	2	1	0
CH6_DVOL[7:0]							
R/W-C9h							

Table 112. CH6_CFG2 Register Field Descriptions

Bit	Field	Type	Reset	Description
7-0	CH6_DVOL[7:0]	R/W	C9h	Channel 6 digital volume control. 0d = Digital volume is muted 1d = Digital volume control is set to –100 dB 2d = Digital volume control is set to –99.5 dB 3d to 200d = Digital volume control is set as per configuration 201d = Digital volume control is set to 0 dB 202d = Digital volume control is set to 0.5 dB 203d to 253d = Digital volume control is set as per configuration 254d = Digital volume control is set to 26.5 dB 255d = Digital volume control is set to 27 dB

8.6.1.1.60 CH6_CFG3 Register (page = 0x00, address = 0x58) [reset = 80h]

This register is configuration register 3 for channel 6 (for the digital microphone PDM input only).

Figure 154. CH6_CFG3 Register

7	6	5	4	3	2	1	0
CH6_GCAL[3:0]				Reserved			
R/W-8h				R-0h			

Table 113. CH6_CFG3 Register Field Descriptions

Bit	Field	Type	Reset	Description
7-4	CH6_GCAL[3:0]	R/W	8h	Channel 6 gain calibration. 0d = Gain calibration is set to –0.8 dB 1d = Gain calibration is set to –0.7 dB 2d = Gain calibration is set to –0.6 dB 3d to 7d = Gain calibration is set as per configuration 8d = Gain calibration is set to 0 dB 9d = Gain calibration is set to 0.1 dB 10d to 13d = Gain calibration is set as per configuration 14d = Gain calibration is set to 0.6 dB 15d = Gain calibration is set to 0.7 dB
3-0	Reserved	R	0h	Reserved

8.6.1.1.61 CH6_CFG4 Register (page = 0x00, address = 0x59) [reset = 0h]

This register is configuration register 4 for channel 6 (for the digital microphone PDM input only).

Figure 155. CH6_CFG4 Register

7	6	5	4	3	2	1	0
CH6_PCAL[7:0]							
R/W-0h							

Table 114. CH6_CFG4 Register Field Descriptions

Bit	Field	Type	Reset	Description
7-0	CH6_PCAL[7:0]	R/W	0h	Channel 6 phase calibration with modulator clock resolution. 0d = No phase calibration 1d = Phase calibration delay is set to one cycle of the modulator clock 2d = Phase calibration delay is set to two cycles of the modulator clock 3d to 254d = Phase calibration delay as per configuration 255d = Phase calibration delay is set to 255 cycles of the modulator clock

8.6.1.1.62 CH7_CFG2 Register (page = 0x00, address = 0x5C) [reset = C9h]

This register is configuration register 2 for channel 7 (for the digital microphone PDM input only).

Figure 156. CH7_CFG2 Register

7	6	5	4	3	2	1	0
CH7_DVOL[7:0]							
R/W-C9h							

Table 115. CH7_CFG2 Register Field Descriptions

Bit	Field	Type	Reset	Description
7-0	CH7_DVOL[7:0]	R/W	C9h	Channel 7 digital volume control. 0d = Digital volume is muted 1d = Digital volume control is set to –100 dB 2d = Digital volume control is set to –99.5 dB 3d to 200d = Digital volume control is set as per configuration 201d = Digital volume control is set to 0 dB 202d = Digital volume control is set to 0.5 dB 203d to 253d = Digital volume control is set as per configuration 254d = Digital volume control is set to 26.5 dB 255d = Digital volume control is set to 27 dB

8.6.1.1.63 CH7_CFG3 Register (page = 0x00, address = 0x5D) [reset = 80h]

This register is configuration register 3 for channel 7 (for the digital microphone PDM input only).

Figure 157. CH7_CFG3 Register

7	6	5	4	3	2	1	0
CH7_GCAL[3:0]				Reserved			
R/W-8h				R-0h			

Table 116. CH7_CFG3 Register Field Descriptions

Bit	Field	Type	Reset	Description
7-4	CH7_GCAL[3:0]	R/W	8h	Channel 7 gain calibration. 0d = Gain calibration is set to –0.8 dB 1d = Gain calibration is set to –0.7 dB 2d = Gain calibration is set to –0.6 dB 3d to 7d = Gain calibration is set as per configuration 8d = Gain calibration is set to 0 dB 9d = Gain calibration is set to 0.1 dB 10d to 13d = Gain calibration is set as per configuration 14d = Gain calibration is set to 0.6 dB 15d = Gain calibration is set to 0.7 dB
3-0	Reserved	R	0h	Reserved

8.6.1.1.64 CH7_CFG4 Register (page = 0x00, address = 0x5E) [reset = 0h]

This register is configuration register 4 for channel 7 (for the digital microphone PDM input only).

Figure 158. CH7_CFG4 Register

7	6	5	4	3	2	1	0
CH7_PCAL[7:0]							
R/W-0h							

Table 117. CH7_CFG4 Register Field Descriptions

Bit	Field	Type	Reset	Description
7-0	CH7_PCAL[7:0]	R/W	0h	Channel 7 phase calibration with modulator clock resolution. 0d = No phase calibration 1d = Phase calibration delay is set to one cycle of the modulator clock 2d = Phase calibration delay is set to two cycles of the modulator clock 3d to 254d = Phase calibration delay as per configuration 255d = Phase calibration delay is set to 255 cycles of the modulator clock

8.6.1.1.65 CH8_CFG2 Register (page = 0x00, address = 0x61) [reset = C9h]

This register is configuration register 2 for channel 8 (for the digital microphone PDM input only).

Figure 159. CH8_CFG2 Register

7	6	5	4	3	2	1	0
CH8_DVOL[7:0]							
R/W-C9h							

Table 118. CH8_CFG2 Register Field Descriptions

Bit	Field	Type	Reset	Description
7-0	CH8_DVOL[7:0]	R/W	C9h	Channel 8 digital volume control. 0d = Digital volume is muted 1d = Digital volume control is set to –100 dB 2d = Digital volume control is set to –99.5 dB 3d to 200d = Digital volume control is set as per configuration 201d = Digital volume control is set to 0 dB 202d = Digital volume control is set to 0.5 dB 203d to 253d = Digital volume control is set as per configuration 254d = Digital volume control is set to 26.5 dB 255d = Digital volume control is set to 27 dB

8.6.1.1.66 CH8_CFG3 Register (page = 0x00, address = 0x62) [reset = 80h]

This register is configuration register 3 for channel 8 (for the digital microphone PDM input only).

Figure 160. CH8_CFG3 Register

7	6	5	4	3	2	1	0
CH8_GCAL[3:0]				Reserved			
R/W-8h				R-0h			

Table 119. CH8_CFG3 Register Field Descriptions

Bit	Field	Type	Reset	Description
7-4	CH8_GCAL[3:0]	R/W	8h	Channel 8 gain calibration. 0d = Gain calibration is set to –0.8 dB 1d = Gain calibration is set to –0.7 dB 2d = Gain calibration is set to –0.6 dB 3d to 7d = Gain calibration is set as per configuration 8d = Gain calibration is set to 0 dB 9d = Gain calibration is set to 0.1 dB 10d to 13d = Gain calibration is set as per configuration 14d = Gain calibration is set to 0.6 dB 15d = Gain calibration is set to 0.7 dB

Table 119. CH8_CFG3 Register Field Descriptions (continued)

Bit	Field	Type	Reset	Description
3-0	Reserved	R	0h	Reserved

8.6.1.1.67 CH8_CFG4 Register (page = 0x00, address = 0x63) [reset = 0h]

This register is configuration register 4 for channel 8 (for the digital microphone PDM input only).

Figure 161. CH8_CFG4 Register

7	6	5	4	3	2	1	0
CH8_PCAL[7:0]							
R/W-0h							

Table 120. CH8_CFG4 Register Field Descriptions

Bit	Field	Type	Reset	Description
7-0	CH8_PCAL[7:0]	R/W	0h	Channel 8 phase calibration with modulator clock resolution. 0d = No phase calibration 1d = Phase calibration delay is set to one cycle of the modulator clock 2d = Phase calibration delay is set to two cycles of the modulator clock 3d to 254d = Phase calibration delay as per configuration 255d = Phase calibration delay is set to 255 cycles of the modulator clock

8.6.1.1.68 DSP_CFG0 Register (page = 0x00, address = 0x6B) [reset = 1h]

This register is the digital signal processor (DSP) configuration register 0.

Figure 162. DSP_CFG0 Register

7	6	5	4	3	2	1	0
Reserved		DECI_FILT[1:0]		CH_SUM[1:0]		HPF_SEL[1:0]	
R-0h		R/W-0h		R/W-0h		R/W-1h	

Table 121. DSP_CFG0 Register Field Descriptions

Bit	Field	Type	Reset	Description
7-6	Reserved	R	0h	Reserved
5-4	DECI_FILT[1:0]	R/W	0h	Decimation filter response. 0d = Linear phase 1d = Low latency 2d = Ultra-low latency 3d = Reserved
3-2	CH_SUM[1:0]	R/W	0h	Channel summation mode for higher SNR 0d = Channel summation mode is disabled 1d = 2-channel summation mode is enabled to generate a (CH1 + CH2) / 2 and a (CH3 + CH4) / 2 output 2d = 4-channel summation mode is enabled to generate a (CH1 + CH2 + CH3 + CH4) / 4 output 3d = Reserved
1-0	HPF_SEL[1:0]	R/W	1h	High-pass filter (HPF) selection. 0d = Programmable first-order IIR filter for a custom HPF with default coefficient values in P4_R72 to P4_R83 set as the all-pass filter 1d = HPF with a cutoff of $0.00025 \times f_S$ (12 Hz at $f_S = 48$ kHz) is selected 2d = HPF with a cutoff of $0.002 \times f_S$ (96 Hz at $f_S = 48$ kHz) is selected 3d = HPF with a cutoff of $0.008 \times f_S$ (384 Hz at $f_S = 48$ kHz) is selected

8.6.1.1.69 DSP_CFG1 Register (page = 0x00, address = 0x6C) [reset = 40h]

This register is the digital signal processor (DSP) configuration register 1.

Figure 163. DSP_CFG1 Register

7	6	5	4	3	2	1	0
DVOL_GANG	BIQUAD_CFG[1:0]		DISABLE_SOFT_STEP	DRE_AGC_SEL	Reserved		
R/W-0h	R/W-2h		R/W-0h	R/W-0h	R/W-0h		

Table 122. DSP_CFG1 Register Field Descriptions

Bit	Field	Type	Reset	Description
7	DVOL_GANG	R/W	0h	DVOL control ganged across channels. 0d = Each channel has its own DVOL CTRL settings as programmed in the CHx_DVOL bits 1d = All active channels must use the channel 1 DVOL setting (CH1_DVOL) irrespective of whether channel 1 is turned on or not
6-5	BIQUAD_CFG[1:0]	R/W	2h	Number of biquads per channel configuration. 0d = No biquads per channel; biquads are all disabled 1d = 1 biquad per channel 2d = 2 biquads per channel 3d = 3 biquads per channel
4	DISABLE_SOFT_STEP	R/W	0h	Soft-stepping disable during DVOL change, mute, and unmute. 0d = Soft-stepping enabled 1d = Soft-stepping disabled
3	DRE_AGC_SEL	R/W	0h	DRE or AGC selection when is enabled for any channel. 0d = DRE is selected 1d = AGC is selected
2-0	Reserved	R/W	0h	Reserved

8.6.1.1.70 DRE_CFG0 Register (page = 0x00, address = 0x6D) [reset = 7Bh]

This register is the dynamic range enhancer (DRE) configuration register 0.

Figure 164. DRE_CFG0 Register

7	6	5	4	3	2	1	0
DRE_LVL[3:0]				DRE_MAXGAIN[3:0]			
R/W-7h				R/W-Bh			

Table 123. DRE_CFG0 Register Field Descriptions

Bit	Field	Type	Reset	Description
7-4	DRE_LVL[3:0]	R/W	7h	DRE trigger signal level threshold. 0d = Input signal level threshold is –12 dB 1d = Input signal level threshold is –18 dB 2d = Input signal level threshold is –24 dB 3d to 6d = Input signal level threshold is as per configuration 7d = Input signal level threshold is –54 dB 8d = Input signal level threshold is –60 dB 9d = Input signal level threshold is –66 dB 10d to 15d = Reserved
3-0	DRE_MAXGAIN[3:0]	R/W	Bh	DRE maximum gain allowed. 0d = Maximum gain allowed is 2 dB 1d = Maximum gain allowed is 4 dB 2d = Maximum gain allowed is 6 dB 3d to 10d = Maximum gain allowed is as per configuration 11d = Maximum gain allowed is 24 dB 12d = Maximum gain allowed is 26 dB 13d to 15d = Reserved

8.6.1.1.71 AGC_CFG0 Register (page = 0x00, address = 0x70) [reset = E7h]

This register is the automatic gain controller (AGC) configuration register 0.

Figure 165. AGC_CFG0 Register

7	6	5	4	3	2	1	0
AGC_LVL[3:0]				AGC_MAXGAIN[3:0]			
R/W-Eh				R/W-7h			

Table 124. AGC_CFG0 Register Field Descriptions

Bit	Field	Type	Reset	Description
7-4	AGC_LVL[3:0]	R/W	Eh	AGC output signal target level. 0d = Output signal target level is –6 dB 1d = Output signal target level is –8 dB 2d = Output signal target level is –10 dB 3d to 13d = Output signal target level is as per configuration 14d = Output signal target level is –34 dB 15d = Output signal target level is –36 dB
3-0	AGC_MAXGAIN[3:0]	R/W	7h	AGC maximum gain allowed. 0d = Maximum gain allowed is 3 dB 1d = Maximum gain allowed is 6 dB 2d = Maximum gain allowed is 9 dB 3d to 11d = Maximum gain allowed is as per configuration 12d = Maximum gain allowed is 39 dB 13d = Maximum gain allowed is 42 dB 14d to 15d = Reserved

8.6.1.1.72 IN_CH_EN Register (page = 0x00, address = 0x73) [reset = F0h]

This register is the input channel enable configuration register.

Figure 166. IN_CH_EN Register

7	6	5	4	3	2	1	0
IN_CH1_EN	IN_CH2_EN	IN_CH3_EN	IN_CH4_EN	IN_CH5_EN	IN_CH6_EN	IN_CH7_EN	IN_CH8_EN
R/W-1h	R/W-1h	R/W-1h	R/W-1h	R/W-0h	R/W-0h	R/W-0h	R/W-0h

Table 125. IN_CH_EN Register Field Descriptions

Bit	Field	Type	Reset	Description
7	IN_CH1_EN	R/W	1h	Input channel 1 enable setting. 0d = Channel 1 is disabled 1d = Channel 1 is enabled
6	IN_CH2_EN	R/W	1h	Input channel 2 enable setting. 0d = Channel 2 is disabled 1d = Channel 2 is enabled
5	IN_CH3_EN	R/W	1h	Input channel 3 enable setting. 0d = Channel 3 is disabled 1d = Channel 3 is enabled
4	IN_CH4_EN	R/W	1h	Input channel 4 enable setting. 0d = Channel 4 is disabled 1d = Channel 4 is enabled
3	IN_CH5_EN	R/W	0h	Input channel 5 (PDM only) enable setting. 0d = Channel 5 is disabled 1d = Channel 5 is enabled
2	IN_CH6_EN	R/W	0h	Input channel 6 (PDM only) enable setting. 0d = Channel 6 is disabled 1d = Channel 6 is enabled
1	IN_CH7_EN	R/W	0h	Input channel 7 (PDM only) enable setting. 0d = Channel 7 is disabled 1d = Channel 7 is enabled
0	IN_CH8_EN	R/W	0h	Input channel 8 (PDM only) enable setting. 0d = Channel 8 is disabled 1d = Channel 8 is enabled

8.6.1.1.73 ASI_OUT_CH_EN Register (page = 0x00, address = 0x74) [reset = 0h]

This register is the ASI output channel enable configuration register.

Figure 167. ASI_OUT_CH_EN Register

7	6	5	4	3	2	1	0
ASI_OUT_CH1_EN	ASI_OUT_CH2_EN	ASI_OUT_CH3_EN	ASI_OUT_CH4_EN	ASI_OUT_CH5_EN	ASI_OUT_CH6_EN	ASI_OUT_CH7_EN	ASI_OUT_CH8_EN
R/W-0h	R/W-0h	R/W-0h	R/W-0h	R/W-0h	R/W-0h	R/W-0h	R/W-0h

Table 126. ASI_OUT_CH_EN Register Field Descriptions

Bit	Field	Type	Reset	Description
7	ASI_OUT_CH1_EN	R/W	0h	ASI output channel 1 enable setting. 0d = Channel 1 output slot is in a tri-state condition 1d = Channel 1 output slot is enabled
6	ASI_OUT_CH2_EN	R/W	0h	ASI output channel 2 enable setting. 0d = Channel 2 output slot is in a tri-state condition 1d = Channel 2 output slot is enabled
5	ASI_OUT_CH3_EN	R/W	0h	ASI output channel 3 enable setting. 0d = Channel 3 output slot is in a tri-state condition 1d = Channel 3 output slot is enabled
4	ASI_OUT_CH4_EN	R/W	0h	ASI output channel 4 enable setting. 0d = Channel 4 output slot is in a tri-state condition 1d = Channel 4 output slot is enabled
3	ASI_OUT_CH5_EN	R/W	0h	ASI output channel 5 enable setting. 0d = Channel 5 output slot is in a tri-state condition 1d = Channel 5 output slot is enabled
2	ASI_OUT_CH6_EN	R/W	0h	ASI output channel 6 enable setting. 0d = Channel 6 output slot is in a tri-state condition 1d = Channel 6 output slot is enabled
1	ASI_OUT_CH7_EN	R/W	0h	ASI output channel 7 enable setting. 0d = Channel 7 output slot is in a tri-state condition 1d = Channel 7 output slot is enabled
0	ASI_OUT_CH8_EN	R/W	0h	ASI output channel 8 enable setting. 0d = Channel 8 output slot is in a tri-state condition 1d = Channel 8 output slot is enabled

8.6.1.1.74 PWR_CFG Register (page = 0x00, address = 0x75) [reset = 0h]

This register is the power-up configuration register.

Figure 168. PWR_CFG Register

7	6	5	4	3	2	1	0
MICBIAS_PDZ	ADC_PDZ	PLL_PDZ	DYN_CH_PUPD_EN	DYN_MAXCH_SEL[1:0]		Reserved	
R/W-0h	R/W-0h	R/W-0h	R/W-0h	R/W-0h		R/W-0h	

Table 127. PWR_CFG Register Field Descriptions

Bit	Field	Type	Reset	Description
7	MICBIAS_PDZ	R/W	0h	Power control for MICBIAS. 0d = Power down MICBIAS 1d = Power up MICBIAS
6	ADC_PDZ	R/W	0h	Power control for ADC and PDM channels. 0d = Power down all ADC and PDM channels 1d = Power up all enabled ADC and PDM channels
5	PLL_PDZ	R/W	0h	Power control for the PLL. 0d = Power down the PLL 1d = Power up the PLL

Table 127. PWR_CFG Register Field Descriptions (continued)

Bit	Field	Type	Reset	Description
4	DYN_CH_PUPD_EN	R/W	0h	Dynamic channel power-up, power-down enable. 0d = Channel power-up, power-down is not supported if any channel recording is on 1d = Channel can be powered up or down individually, even if channel recording is on
3-2	DYN_MAXCH_SEL[1:0]	R/W	0h	Dynamic mode maximum channel select configuration. 0d = Channel 1 and channel 2 are used with dynamic channel power-up, power-down feature enabled 1d = Channel 1 to channel 4 are used with dynamic channel power-up, power-down feature enabled 2d = Channel 1 to channel 6 are used with dynamic channel power-up, power-down feature enabled 3d = Channel 1 to channel 8 are used with dynamic channel power-up, power-down feature enabled
1-0	Reserved	R/W	0h	Reserved

8.6.1.1.75 DEV_STS0 Register (page = 0x00, address = 0x76) [reset = 0h]

This register is the device status value register 0.

Figure 169. DEV_STS0 Register

7	6	5	4	3	2	1	0
CH1_STATUS	CH2_STATUS	CH3_STATUS	CH4_STATUS	CH5_STATUS	CH6_STATUS	CH7_STATUS	CH8_STATUS
R-0h	R-0h	R-0h	R-0h	R-0h	R-0h	R-0h	R-0h

Table 128. DEV_STS0 Register Field Descriptions

Bit	Field	Type	Reset	Description
7	CH1_STATUS	R	0h	ADC or PDM channel 1 power status. 0d = ADC or PDM channel is powered down 1d = ADC or PDM channel is powered up
6	CH2_STATUS	R	0h	ADC or PDM channel 2 power status. 0d = ADC or PDM channel is powered down 1d = ADC or PDM channel is powered up
5	CH3_STATUS	R	0h	ADC or PDM channel 3 power status. 0d = ADC or PDM channel is powered down 1d = ADC or PDM channel is powered up
4	CH4_STATUS	R	0h	ADC or PDM channel 4 power status. 0d = ADC or PDM channel is powered down 1d = ADC or PDM channel is powered up
3	CH5_STATUS	R	0h	PDM channel 5 power status. 0d = PDM channel is powered down 1d = PDM channel is powered up
2	CH6_STATUS	R	0h	PDM channel 6 power status. 0d = PDM channel is powered down 1d = PDM channel is powered up
1	CH7_STATUS	R	0h	PDM channel 7 power status. 0d = PDM channel is powered down 1d = PDM channel is powered up
0	CH8_STATUS	R	0h	PDM channel 8 power status. 0d = PDM channel is powered down 1d = PDM channel is powered up

8.6.1.1.76 DEV_STS1 Register (page = 0x00, address = 0x77) [reset = 80h]

This register is the device status value register 1.

Figure 170. DEV_STS1 Register

7	6	5	4	3	2	1	0
MODE_STS[2:0]			Reserved				
R-4h			R-0h				

Table 129. DEV_STS1 Register Field Descriptions

Bit	Field	Type	Reset	Description
7-5	MODE_STS[2:0]	R	4h	Device mode status. 4d = Device is in sleep mode or software shutdown mode 6d = Device is in active mode with all ADC or PDM channels turned off 7d = Device is in active mode with at least one ADC or PDM channel turned on
4-0	Reserved	R	0h	Reserved

8.6.1.1.77 I2C_CKSUM Register (page = 0x00, address = 0x7E) [reset = 0h]

This register returns the I²C transactions checksum value.

Figure 171. I2C_CKSUM Register

7	6	5	4	3	2	1	0
I2C_CKSUM[7:0]							
R/W-0h							

Table 130. I2C_CKSUM Register Field Descriptions

Bit	Field	Type	Reset	Description
7-0	I2C_CKSUM[7:0]	R/W	0h	These bits return the I ² C transactions checksum value. Writing to this register resets the checksum to the written value. This register is updated on writes to other registers on all pages.

8.6.2 Programmable Coefficient Registers

8.6.2.1 Programmable Coefficient Registers: Page = 0x02

This register page (shown in [Table 131](#)) consists of the programmable coefficients for the biquad 1 to biquad 6 filters. To optimize the coefficients register transaction time for page 2, page 3, and page 4, the device also supports (by default) auto-incremented pages for the I²C and SPI burst writes and reads. After a transaction of register address 0x7F, the device auto increments to the next page at register 0x08 to transact the next coefficient value.

Table 131. Page 0x02 Programmable Coefficient Registers

ADDRESS	REGISTER	RESET	DESCRIPTION
0x00	PAGE[7:0]	0x00	Device page register
0x08	BQ1_N0_BYT1[7:0]	0x7F	Programmable biquad 1, N0 coefficient byte[31:24]
0x09	BQ1_N0_BYT2[7:0]	0xFF	Programmable biquad 1, N0 coefficient byte[23:16]
0x0A	BQ1_N0_BYT3[7:0]	0xFF	Programmable biquad 1, N0 coefficient byte[15:8]
0x0B	BQ1_N0_BYT4[7:0]	0xFF	Programmable biquad 1, N0 coefficient byte[7:0]
0x0C	BQ1_N1_BYT1[7:0]	0x00	Programmable biquad 1, N1 coefficient byte[31:24]
0x0D	BQ1_N1_BYT2[7:0]	0x00	Programmable biquad 1, N1 coefficient byte[23:16]
0x0E	BQ1_N1_BYT3[7:0]	0x00	Programmable biquad 1, N1 coefficient byte[15:8]
0x0F	BQ1_N1_BYT4[7:0]	0x00	Programmable biquad 1, N1 coefficient byte[7:0]
0x10	BQ1_N2_BYT1[7:0]	0x00	Programmable biquad 1, N2 coefficient byte[31:24]
0x11	BQ1_N2_BYT2[7:0]	0x00	Programmable biquad 1, N2 coefficient byte[23:16]
0x12	BQ1_N2_BYT3[7:0]	0x00	Programmable biquad 1, N2 coefficient byte[15:8]
0x13	BQ1_N2_BYT4[7:0]	0x00	Programmable biquad 1, N2 coefficient byte[7:0]
0x14	BQ1_D1_BYT1[7:0]	0x00	Programmable biquad 1, D1 coefficient byte[31:24]
0x15	BQ1_D1_BYT2[7:0]	0x00	Programmable biquad 1, D1 coefficient byte[23:16]
0x16	BQ1_D1_BYT3[7:0]	0x00	Programmable biquad 1, D1 coefficient byte[15:8]
0x17	BQ1_D1_BYT4[7:0]	0x00	Programmable biquad 1, D1 coefficient byte[7:0]
0x18	BQ1_D2_BYT1[7:0]	0x00	Programmable biquad 1, D2 coefficient byte[31:24]
0x19	BQ1_D2_BYT2[7:0]	0x00	Programmable biquad 1, D2 coefficient byte[23:16]
0x1A	BQ1_D2_BYT3[7:0]	0x00	Programmable biquad 1, D2 coefficient byte[15:8]
0x1B	BQ1_D2_BYT4[7:0]	0x00	Programmable biquad 1, D2 coefficient byte[7:0]
0x1C	BQ2_N0_BYT1[7:0]	0x7F	Programmable biquad 2, N0 coefficient byte[31:24]
0x1D	BQ2_N0_BYT2[7:0]	0xFF	Programmable biquad 2, N0 coefficient byte[23:16]
0x1E	BQ2_N0_BYT3[7:0]	0xFF	Programmable biquad 2, N0 coefficient byte[15:8]
0x1F	BQ2_N0_BYT4[7:0]	0xFF	Programmable biquad 2, N0 coefficient byte[7:0]
0x20	BQ2_N1_BYT1[7:0]	0x00	Programmable biquad 2, N1 coefficient byte[31:24]
0x21	BQ2_N1_BYT2[7:0]	0x00	Programmable biquad 2, N1 coefficient byte[23:16]
0x22	BQ2_N1_BYT3[7:0]	0x00	Programmable biquad 2, N1 coefficient byte[15:8]
0x23	BQ2_N1_BYT4[7:0]	0x00	Programmable biquad 2, N1 coefficient byte[7:0]
0x24	BQ2_N2_BYT1[7:0]	0x00	Programmable biquad 2, N2 coefficient byte[31:24]
0x25	BQ2_N2_BYT2[7:0]	0x00	Programmable biquad 2, N2 coefficient byte[23:16]
0x26	BQ2_N2_BYT3[7:0]	0x00	Programmable biquad 2, N2 coefficient byte[15:8]
0x27	BQ2_N2_BYT4[7:0]	0x00	Programmable biquad 2, N2 coefficient byte[7:0]
0x28	BQ2_D1_BYT1[7:0]	0x00	Programmable biquad 2, D1 coefficient byte[31:24]
0x29	BQ2_D1_BYT2[7:0]	0x00	Programmable biquad 2, D1 coefficient byte[23:16]
0x2A	BQ2_D1_BYT3[7:0]	0x00	Programmable biquad 2, D1 coefficient byte[15:8]
0x2B	BQ2_D1_BYT4[7:0]	0x00	Programmable biquad 2, D1 coefficient byte[7:0]
0x2C	BQ2_D2_BYT1[7:0]	0x00	Programmable biquad 2, D2 coefficient byte[31:24]
0x2D	BQ2_D2_BYT2[7:0]	0x00	Programmable biquad 2, D2 coefficient byte[23:16]
0x2E	BQ2_D2_BYT3[7:0]	0x00	Programmable biquad 2, D2 coefficient byte[15:8]
0x2F	BQ2_D2_BYT4[7:0]	0x00	Programmable biquad 2, D2 coefficient byte[7:0]
0x30	BQ3_N0_BYT1[7:0]	0x7F	Programmable biquad 3, N0 coefficient byte[31:24]
0x31	BQ3_N0_BYT2[7:0]	0xFF	Programmable biquad 3, N0 coefficient byte[23:16]

Table 131. Page 0x02 Programmable Coefficient Registers (continued)

0x32	BQ3_N0_BYT3[7:0]	0xFF	Programmable biquad 3, N0 coefficient byte[15:8]
0x33	BQ3_N0_BYT4[7:0]	0xFF	Programmable biquad 3, N0 coefficient byte[7:0]
0x34	BQ3_N1_BYT1[7:0]	0x00	Programmable biquad 3, N1 coefficient byte[31:24]
0x35	BQ3_N1_BYT2[7:0]	0x00	Programmable biquad 3, N1 coefficient byte[23:16]
0x36	BQ3_N1_BYT3[7:0]	0x00	Programmable biquad 3, N1 coefficient byte[15:8]
0x37	BQ3_N1_BYT4[7:0]	0x00	Programmable biquad 3, N1 coefficient byte[7:0]
0x38	BQ3_N2_BYT1[7:0]	0x00	Programmable biquad 3, N2 coefficient byte[31:24]
0x39	BQ3_N2_BYT2[7:0]	0x00	Programmable biquad 3, N2 coefficient byte[23:16]
0x3A	BQ3_N2_BYT3[7:0]	0x00	Programmable biquad 3, N2 coefficient byte[15:8]
0x3B	BQ3_N2_BYT4[7:0]	0x00	Programmable biquad 3, N2 coefficient byte[7:0]
0x3C	BQ3_D1_BYT1[7:0]	0x00	Programmable biquad 3, D1 coefficient byte[31:24]
0x3D	BQ3_D1_BYT2[7:0]	0x00	Programmable biquad 3, D1 coefficient byte[23:16]
0x3E	BQ3_D1_BYT3[7:0]	0x00	Programmable biquad 3, D1 coefficient byte[15:8]
0x3F	BQ3_D1_BYT4[7:0]	0x00	Programmable biquad 3, D1 coefficient byte[7:0]
0x40	BQ3_D2_BYT1[7:0]	0x00	Programmable biquad 3, D2 coefficient byte[31:24]
0x41	BQ3_D2_BYT2[7:0]	0x00	Programmable biquad 3, D2 coefficient byte[23:16]
0x42	BQ3_D2_BYT3[7:0]	0x00	Programmable biquad 3, D2 coefficient byte[15:8]
0x43	BQ3_D2_BYT4[7:0]	0x00	Programmable biquad 3, D2 coefficient byte[7:0]
0x44	BQ4_N0_BYT1[7:0]	0x7F	Programmable biquad 4, N0 coefficient byte[31:24]
0x45	BQ4_N0_BYT2[7:0]	0xFF	Programmable biquad 4, N0 coefficient byte[23:16]
0x46	BQ4_N0_BYT3[7:0]	0xFF	Programmable biquad 4, N0 coefficient byte[15:8]
0x47	BQ4_N0_BYT4[7:0]	0xFF	Programmable biquad 4, N0 coefficient byte[7:0]
0x48	BQ4_N1_BYT1[7:0]	0x00	Programmable biquad 4, N1 coefficient byte[31:24]
0x49	BQ4_N1_BYT2[7:0]	0x00	Programmable biquad 4, N1 coefficient byte[23:16]
0x4A	BQ4_N1_BYT3[7:0]	0x00	Programmable biquad 4, N1 coefficient byte[15:8]
0x4B	BQ4_N1_BYT4[7:0]	0x00	Programmable biquad 4, N1 coefficient byte[7:0]
0x4C	BQ4_N2_BYT1[7:0]	0x00	Programmable biquad 4, N2 coefficient byte[31:24]
0x4D	BQ4_N2_BYT2[7:0]	0x00	Programmable biquad 4, N2 coefficient byte[23:16]
0x4E	BQ4_N2_BYT3[7:0]	0x00	Programmable biquad 4, N2 coefficient byte[15:8]
0x4F	BQ4_N2_BYT4[7:0]	0x00	Programmable biquad 4, N2 coefficient byte[7:0]
0x50	BQ4_D1_BYT1[7:0]	0x00	Programmable biquad 4, D1 coefficient byte[31:24]
0x51	BQ4_D1_BYT2[7:0]	0x00	Programmable biquad 4, D1 coefficient byte[23:16]
0x52	BQ4_D1_BYT3[7:0]	0x00	Programmable biquad 4, D1 coefficient byte[15:8]
0x53	BQ4_D1_BYT4[7:0]	0x00	Programmable biquad 4, D1 coefficient byte[7:0]
0x54	BQ4_D2_BYT1[7:0]	0x00	Programmable biquad 4, D2 coefficient byte[31:24]
0x55	BQ4_D2_BYT2[7:0]	0x00	Programmable biquad 4, D2 coefficient byte[23:16]
0x56	BQ4_D2_BYT3[7:0]	0x00	Programmable biquad 4, D2 coefficient byte[15:8]
0x57	BQ4_D2_BYT4[7:0]	0x00	Programmable biquad 4, D2 coefficient byte[7:0]
0x58	BQ5_N0_BYT1[7:0]	0x7F	Programmable biquad 5, N0 coefficient byte[31:24]
0x59	BQ5_N0_BYT2[7:0]	0xFF	Programmable biquad 5, N0 coefficient byte[23:16]
0x5A	BQ5_N0_BYT3[7:0]	0xFF	Programmable biquad 5, N0 coefficient byte[15:8]
0x5B	BQ5_N0_BYT4[7:0]	0xFF	Programmable biquad 5, N0 coefficient byte[7:0]
0x5C	BQ5_N1_BYT1[7:0]	0x00	Programmable biquad 5, N1 coefficient byte[31:24]
0x5D	BQ5_N1_BYT2[7:0]	0x00	Programmable biquad 5, N1 coefficient byte[23:16]
0x5E	BQ5_N1_BYT3[7:0]	0x00	Programmable biquad 5, N1 coefficient byte[15:8]
0x5F	BQ5_N1_BYT4[7:0]	0x00	Programmable biquad 5, N1 coefficient byte[7:0]
0x60	BQ5_N2_BYT1[7:0]	0x00	Programmable biquad 5, N2 coefficient byte[31:24]
0x61	BQ5_N2_BYT2[7:0]	0x00	Programmable biquad 5, N2 coefficient byte[23:16]
0x62	BQ5_N2_BYT3[7:0]	0x00	Programmable biquad 5, N2 coefficient byte[15:8]
0x63	BQ5_N2_BYT4[7:0]	0x00	Programmable biquad 5, N2 coefficient byte[7:0]
0x64	BQ5_D1_BYT1[7:0]	0x00	Programmable biquad 5, D1 coefficient byte[31:24]
0x65	BQ5_D1_BYT2[7:0]	0x00	Programmable biquad 5, D1 coefficient byte[23:16]

Table 131. Page 0x02 Programmable Coefficient Registers (continued)

0x66	BQ5_D1_BYT3[7:0]	0x00	Programmable biquad 5, D1 coefficient byte[15:8]
0x67	BQ5_D1_BYT4[7:0]	0x00	Programmable biquad 5, D1 coefficient byte[7:0]
0x68	BQ5_D2_BYT1[7:0]	0x00	Programmable biquad 5, D2 coefficient byte[31:24]
0x69	BQ5_D2_BYT2[7:0]	0x00	Programmable biquad 5, D2 coefficient byte[23:16]
0x6A	BQ5_D2_BYT3[7:0]	0x00	Programmable biquad 5, D2 coefficient byte[15:8]
0x6B	BQ5_D2_BYT4[7:0]	0x00	Programmable biquad 5, D2 coefficient byte[7:0]
0x6C	BQ6_N0_BYT1[7:0]	0x7F	Programmable biquad 6, N0 coefficient byte[31:24]
0x6D	BQ6_N0_BYT2[7:0]	0xFF	Programmable biquad 6, N0 coefficient byte[23:16]
0x6E	BQ6_N0_BYT3[7:0]	0xFF	Programmable biquad 6, N0 coefficient byte[15:8]
0x6F	BQ6_N0_BYT4[7:0]	0xFF	Programmable biquad 6, N0 coefficient byte[7:0]
0x70	BQ6_N1_BYT1[7:0]	0x00	Programmable biquad 6, N1 coefficient byte[31:24]
0x71	BQ6_N1_BYT2[7:0]	0x00	Programmable biquad 6, N1 coefficient byte[23:16]
0x72	BQ6_N1_BYT3[7:0]	0x00	Programmable biquad 6, N1 coefficient byte[15:8]
0x73	BQ6_N1_BYT4[7:0]	0x00	Programmable biquad 6, N1 coefficient byte[7:0]
0x74	BQ6_N2_BYT1[7:0]	0x00	Programmable biquad 6, N2 coefficient byte[31:24]
0x75	BQ6_N2_BYT2[7:0]	0x00	Programmable biquad 6, N2 coefficient byte[23:16]
0x76	BQ6_N2_BYT3[7:0]	0x00	Programmable biquad 6, N2 coefficient byte[15:8]
0x77	BQ6_N2_BYT4[7:0]	0x00	Programmable biquad 6, N2 coefficient byte[7:0]
0x78	BQ6_D1_BYT1[7:0]	0x00	Programmable biquad 6, D1 coefficient byte[31:24]
0x79	BQ6_D1_BYT2[7:0]	0x00	Programmable biquad 6, D1 coefficient byte[23:16]
0x7A	BQ6_D1_BYT3[7:0]	0x00	Programmable biquad 6, D1 coefficient byte[15:8]
0x7B	BQ6_D1_BYT4[7:0]	0x00	Programmable biquad 6, D1 coefficient byte[7:0]
0x7C	BQ6_D2_BYT1[7:0]	0x00	Programmable biquad 6, D2 coefficient byte[31:24]
0x7D	BQ6_D2_BYT2[7:0]	0x00	Programmable biquad 6, D2 coefficient byte[23:16]
0x7E	BQ6_D2_BYT3[7:0]	0x00	Programmable biquad 6, D2 coefficient byte[15:8]
0x7F	BQ6_D2_BYT4[7:0]	0x00	Programmable biquad 6, D2 coefficient byte[7:0]

8.6.2.2 Programmable Coefficient Registers: Page = 0x03

This register page (shown in [Table 132](#)) consists of the programmable coefficients for the biquad 7 to biquad 12 filters. To optimize the coefficients register transaction time for page 2, page 3, and page 4, the device also supports (by default) auto-incremented pages for the I²C and SPI burst writes and reads. After a transaction of register address 0x7F, the device auto increments to the next page at register 0x08 to transact the next coefficient value.

Table 132. Page 0x03 Programmable Coefficient Registers

ADDR	REGISTER	RESET	DESCRIPTION
0x00	PAGE[7:0]	0x00	Device page register
0x08	BQ7_N0_BYT1[7:0]	0x7F	Programmable biquad 7, N0 coefficient byte[31:24]
0x09	BQ7_N0_BYT2[7:0]	0xFF	Programmable biquad 7, N0 coefficient byte[23:16]
0x0A	BQ7_N0_BYT3[7:0]	0xFF	Programmable biquad 7, N0 coefficient byte[15:8]
0x0B	BQ7_N0_BYT4[7:0]	0xFF	Programmable biquad 7, N0 coefficient byte[7:0]
0x0C	BQ7_N1_BYT1[7:0]	0x00	Programmable biquad 7, N1 coefficient byte[31:24]
0x0D	BQ7_N1_BYT2[7:0]	0x00	Programmable biquad 7, N1 coefficient byte[23:16]
0x0E	BQ7_N1_BYT3[7:0]	0x00	Programmable biquad 7, N1 coefficient byte[15:8]
0x0F	BQ7_N1_BYT4[7:0]	0x00	Programmable biquad 7, N1 coefficient byte[7:0]
0x10	BQ7_N2_BYT1[7:0]	0x00	Programmable biquad 7, N2 coefficient byte[31:24]
0x11	BQ7_N2_BYT2[7:0]	0x00	Programmable biquad 7, N2 coefficient byte[23:16]
0x12	BQ7_N2_BYT3[7:0]	0x00	Programmable biquad 7, N2 coefficient byte[15:8]
0x13	BQ7_N2_BYT4[7:0]	0x00	Programmable biquad 7, N2 coefficient byte[7:0]
0x14	BQ7_D1_BYT1[7:0]	0x00	Programmable biquad 7, D1 coefficient byte[31:24]
0x15	BQ7_D1_BYT2[7:0]	0x00	Programmable biquad 7, D1 coefficient byte[23:16]
0x16	BQ7_D1_BYT3[7:0]	0x00	Programmable biquad 7, D1 coefficient byte[15:8]
0x17	BQ7_D1_BYT4[7:0]	0x00	Programmable biquad 7, D1 coefficient byte[7:0]
0x18	BQ7_D2_BYT1[7:0]	0x00	Programmable biquad 7, D2 coefficient byte[31:24]
0x19	BQ7_D2_BYT2[7:0]	0x00	Programmable biquad 7, D2 coefficient byte[23:16]
0x1A	BQ7_D2_BYT3[7:0]	0x00	Programmable biquad 7, D2 coefficient byte[15:8]
0x1B	BQ7_D2_BYT4[7:0]	0x00	Programmable biquad 7, D2 coefficient byte[7:0]
0x1C	BQ8_N0_BYT1[7:0]	0x7F	Programmable biquad 8, N0 coefficient byte[31:24]
0x1D	BQ8_N0_BYT2[7:0]	0xFF	Programmable biquad 8, N0 coefficient byte[23:16]
0x1E	BQ8_N0_BYT3[7:0]	0xFF	Programmable biquad 8, N0 coefficient byte[15:8]
0x1F	BQ8_N0_BYT4[7:0]	0xFF	Programmable biquad 8, N0 coefficient byte[7:0]
0x20	BQ8_N1_BYT1[7:0]	0x00	Programmable biquad 8, N1 coefficient byte[31:24]
0x21	BQ8_N1_BYT2[7:0]	0x00	Programmable biquad 8, N1 coefficient byte[23:16]
0x22	BQ8_N1_BYT3[7:0]	0x00	Programmable biquad 8, N1 coefficient byte[15:8]
0x23	BQ8_N1_BYT4[7:0]	0x00	Programmable biquad 8, N1 coefficient byte[7:0]
0x24	BQ8_N2_BYT1[7:0]	0x00	Programmable biquad 8, N2 coefficient byte[31:24]
0x25	BQ8_N2_BYT2[7:0]	0x00	Programmable biquad 8, N2 coefficient byte[23:16]
0x26	BQ8_N2_BYT3[7:0]	0x00	Programmable biquad 8, N2 coefficient byte[15:8]
0x27	BQ8_N2_BYT4[7:0]	0x00	Programmable biquad 8, N2 coefficient byte[7:0]
0x28	BQ8_D1_BYT1[7:0]	0x00	Programmable biquad 8, D1 coefficient byte[31:24]
0x29	BQ8_D1_BYT2[7:0]	0x00	Programmable biquad 8, D1 coefficient byte[23:16]
0x2A	BQ8_D1_BYT3[7:0]	0x00	Programmable biquad 8, D1 coefficient byte[15:8]
0x2B	BQ8_D1_BYT4[7:0]	0x00	Programmable biquad 8, D1 coefficient byte[7:0]
0x2C	BQ8_D2_BYT1[7:0]	0x00	Programmable biquad 8, D2 coefficient byte[31:24]
0x2D	BQ8_D2_BYT2[7:0]	0x00	Programmable biquad 8, D2 coefficient byte[23:16]
0x2E	BQ8_D2_BYT3[7:0]	0x00	Programmable biquad 8, D2 coefficient byte[15:8]
0x2F	BQ8_D2_BYT4[7:0]	0x00	Programmable biquad 8, D2 coefficient byte[7:0]
0x30	BQ9_N0_BYT1[7:0]	0x7F	Programmable biquad 9, N0 coefficient byte[31:24]
0x31	BQ9_N0_BYT2[7:0]	0xFF	Programmable biquad 9, N0 coefficient byte[23:16]
0x32	BQ9_N0_BYT3[7:0]	0xFF	Programmable biquad 9, N0 coefficient byte[15:8]

Table 132. Page 0x03 Programmable Coefficient Registers (continued)

0x33	BQ9_N0_BYT4[7:0]	0xFF	Programmable biquad 9, N0 coefficient byte[7:0]
0x34	BQ9_N1_BYT1[7:0]	0x00	Programmable biquad 9, N1 coefficient byte[31:24]
0x35	BQ9_N1_BYT2[7:0]	0x00	Programmable biquad 9, N1 coefficient byte[23:16]
0x36	BQ9_N1_BYT3[7:0]	0x00	Programmable biquad 9, N1 coefficient byte[15:8]
0x37	BQ9_N1_BYT4[7:0]	0x00	Programmable biquad 9, N1 coefficient byte[7:0]
0x38	BQ9_N2_BYT1[7:0]	0x00	Programmable biquad 9, N2 coefficient byte[31:24]
0x39	BQ9_N2_BYT2[7:0]	0x00	Programmable biquad 9, N2 coefficient byte[23:16]
0x3A	BQ9_N2_BYT3[7:0]	0x00	Programmable biquad 9, N2 coefficient byte[15:8]
0x3B	BQ9_N2_BYT4[7:0]	0x00	Programmable biquad 9, N2 coefficient byte[7:0]
0x3C	BQ9_D1_BYT1[7:0]	0x00	Programmable biquad 9, D1 coefficient byte[31:24]
0x3D	BQ9_D1_BYT2[7:0]	0x00	Programmable biquad 9, D1 coefficient byte[23:16]
0x3E	BQ9_D1_BYT3[7:0]	0x00	Programmable biquad 9, D1 coefficient byte[15:8]
0x3F	BQ9_D1_BYT4[7:0]	0x00	Programmable biquad 9, D1 coefficient byte[7:0]
0x40	BQ9_D2_BYT1[7:0]	0x00	Programmable biquad 9, D2 coefficient byte[31:24]
0x41	BQ9_D2_BYT2[7:0]	0x00	Programmable biquad 9, D2 coefficient byte[23:16]
0x42	BQ9_D2_BYT3[7:0]	0x00	Programmable biquad 9, D2 coefficient byte[15:8]
0x43	BQ9_D2_BYT4[7:0]	0x00	Programmable biquad 9, D2 coefficient byte[7:0]
0x44	BQ10_N0_BYT1[7:0]	0x7F	Programmable biquad 10, N0 coefficient byte[31:24]
0x45	BQ10_N0_BYT2[7:0]	0xFF	Programmable biquad 10, N0 coefficient byte[23:16]
0x46	BQ10_N0_BYT3[7:0]	0xFF	Programmable biquad 10, N0 coefficient byte[15:8]
0x47	BQ10_N0_BYT4[7:0]	0xFF	Programmable biquad 10, N0 coefficient byte[7:0]
0x48	BQ10_N1_BYT1[7:0]	0x00	Programmable biquad 10, N1 coefficient byte[31:24]
0x49	BQ10_N1_BYT2[7:0]	0x00	Programmable biquad 10, N1 coefficient byte[23:16]
0x4A	BQ10_N1_BYT3[7:0]	0x00	Programmable biquad 10, N1 coefficient byte[15:8]
0x4B	BQ10_N1_BYT4[7:0]	0x00	Programmable biquad 10, N1 coefficient byte[7:0]
0x4C	BQ10_N2_BYT1[7:0]	0x00	Programmable biquad 10, N2 coefficient byte[31:24]
0x4D	BQ10_N2_BYT2[7:0]	0x00	Programmable biquad 10, N2 coefficient byte[23:16]
0x4E	BQ10_N2_BYT3[7:0]	0x00	Programmable biquad 10, N2 coefficient byte[15:8]
0x4F	BQ10_N2_BYT4[7:0]	0x00	Programmable biquad 10, N2 coefficient byte[7:0]
0x50	BQ10_D1_BYT1[7:0]	0x00	Programmable biquad 10, D1 coefficient byte[31:24]
0x51	BQ10_D1_BYT2[7:0]	0x00	Programmable biquad 10, D1 coefficient byte[23:16]
0x52	BQ10_D1_BYT3[7:0]	0x00	Programmable biquad 10, D1 coefficient byte[15:8]
0x53	BQ10_D1_BYT4[7:0]	0x00	Programmable biquad 10, D1 coefficient byte[7:0]
0x54	BQ10_D2_BYT1[7:0]	0x00	Programmable biquad 10, D2 coefficient byte[31:24]
0x55	BQ10_D2_BYT2[7:0]	0x00	Programmable biquad 10, D2 coefficient byte[23:16]
0x56	BQ10_D2_BYT3[7:0]	0x00	Programmable biquad 10, D2 coefficient byte[15:8]
0x57	BQ10_D2_BYT4[7:0]	0x00	Programmable biquad 10, D2 coefficient byte[7:0]
0x58	BQ11_N0_BYT1[7:0]	0x7F	Programmable biquad 11, N0 coefficient byte[31:24]
0x59	BQ11_N0_BYT2[7:0]	0xFF	Programmable biquad 11, N0 coefficient byte[23:16]
0x5A	BQ11_N0_BYT3[7:0]	0xFF	Programmable biquad 11, N0 coefficient byte[15:8]
0x5B	BQ11_N0_BYT4[7:0]	0xFF	Programmable biquad 11, N0 coefficient byte[7:0]
0x5C	BQ11_N1_BYT1[7:0]	0x00	Programmable biquad 11, N1 coefficient byte[31:24]
0x5D	BQ11_N1_BYT2[7:0]	0x00	Programmable biquad 11, N1 coefficient byte[23:16]
0x5E	BQ11_N1_BYT3[7:0]	0x00	Programmable biquad 11, N1 coefficient byte[15:8]
0x5F	BQ11_N1_BYT4[7:0]	0x00	Programmable biquad 11, N1 coefficient byte[7:0]
0x60	BQ11_N2_BYT1[7:0]	0x00	Programmable biquad 11, N2 coefficient byte[31:24]
0x61	BQ11_N2_BYT2[7:0]	0x00	Programmable biquad 11, N2 coefficient byte[23:16]
0x62	BQ11_N2_BYT3[7:0]	0x00	Programmable biquad 11, N2 coefficient byte[15:8]
0x63	BQ11_N2_BYT4[7:0]	0x00	Programmable biquad 11, N2 coefficient byte[7:0]
0x64	BQ11_D1_BYT1[7:0]	0x00	Programmable biquad 11, D1 coefficient byte[31:24]
0x65	BQ11_D1_BYT2[7:0]	0x00	Programmable biquad 11, D1 coefficient byte[23:16]
0x66	BQ11_D1_BYT3[7:0]	0x00	Programmable biquad 11, D1 coefficient byte[15:8]

Table 132. Page 0x03 Programmable Coefficient Registers (continued)

0x67	BQ11_D1_BYT4[7:0]	0x00	Programmable biquad 11, D1 coefficient byte[7:0]
0x68	BQ11_D2_BYT1[7:0]	0x00	Programmable biquad 11, D2 coefficient byte[31:24]
0x69	BQ11_D2_BYT2[7:0]	0x00	Programmable biquad 11, D2 coefficient byte[23:16]
0x6A	BQ11_D2_BYT3[7:0]	0x00	Programmable biquad 11, D2 coefficient byte[15:8]
0x6B	BQ11_D2_BYT4[7:0]	0x00	Programmable biquad 11, D2 coefficient byte[7:0]
0x6C	BQ12_N0_BYT1[7:0]	0x7F	Programmable biquad 12, N0 coefficient byte[31:24]
0x6D	BQ12_N0_BYT2[7:0]	0xFF	Programmable biquad 12, N0 coefficient byte[23:16]
0x6E	BQ12_N0_BYT3[7:0]	0xFF	Programmable biquad 12, N0 coefficient byte[15:8]
0x6F	BQ12_N0_BYT4[7:0]	0xFF	Programmable biquad 12, N0 coefficient byte[7:0]
0x70	BQ12_N1_BYT1[7:0]	0x00	Programmable biquad 12, N1 coefficient byte[31:24]
0x71	BQ12_N1_BYT2[7:0]	0x00	Programmable biquad 12, N1 coefficient byte[23:16]
0x72	BQ12_N1_BYT3[7:0]	0x00	Programmable biquad 12, N1 coefficient byte[15:8]
0x73	BQ12_N1_BYT4[7:0]	0x00	Programmable biquad 12, N1 coefficient byte[7:0]
0x74	BQ12_N2_BYT1[7:0]	0x00	Programmable biquad 12, N2 coefficient byte[31:24]
0x75	BQ12_N2_BYT2[7:0]	0x00	Programmable biquad 12, N2 coefficient byte[23:16]
0x76	BQ12_N2_BYT3[7:0]	0x00	Programmable biquad 12, N2 coefficient byte[15:8]
0x77	BQ12_N2_BYT4[7:0]	0x00	Programmable biquad 12, N2 coefficient byte[7:0]
0x78	BQ12_D1_BYT1[7:0]	0x00	Programmable biquad 12, D1 coefficient byte[31:24]
0x79	BQ12_D1_BYT2[7:0]	0x00	Programmable biquad 12, D1 coefficient byte[23:16]
0x7A	BQ12_D1_BYT3[7:0]	0x00	Programmable biquad 12, D1 coefficient byte[15:8]
0x7B	BQ12_D1_BYT4[7:0]	0x00	Programmable biquad 12, D1 coefficient byte[7:0]
0x7C	BQ12_D2_BYT1[7:0]	0x00	Programmable biquad 12, D2 coefficient byte[31:24]
0x7D	BQ12_D2_BYT2[7:0]	0x00	Programmable biquad 12, D2 coefficient byte[23:16]
0x7E	BQ12_D2_BYT3[7:0]	0x00	Programmable biquad 12, D2 coefficient byte[15:8]
0x7F	BQ12_D2_BYT4[7:0]	0x00	Programmable biquad 12, D2 coefficient byte[7:0]

8.6.2.3 Programmable Coefficient Registers: Page = 0x04

This register page (shown in [Table 133](#)) consists of the programmable coefficients for mixer 1 to mixer 4 and the first-order IIR filter.

Table 133. Page 0x04 Programmable Coefficient Registers

ADDR	REGISTER	RESET	DESCRIPTION
0x00	PAGE[7:0]	0x00	Device page register
0x08	MIX1_CH1_BYT1[7:0]	0x7F	Digital mixer 1, channel 1 coefficient byte[31:24]
0x09	MIX1_CH1_BYT2[7:0]	0xFF	Digital mixer 1, channel 1 coefficient byte[23:16]
0x0A	MIX1_CH1_BYT3[7:0]	0xFF	Digital mixer 1, channel 1 coefficient byte[15:8]
0x0B	MIX1_CH1_BYT4[7:0]	0xFF	Digital mixer 1, channel 1 coefficient byte[7:0]
0x0C	MIX1_CH2_BYT1[7:0]	0x00	Digital mixer 1, channel 2 coefficient byte[31:24]
0x0D	MIX1_CH2_BYT2[7:0]	0x00	Digital mixer 1, channel 2 coefficient byte[23:16]
0x0E	MIX1_CH2_BYT3[7:0]	0x00	Digital mixer 1, channel 2 coefficient byte[15:8]
0x0F	MIX1_CH2_BYT4[7:0]	0x00	Digital mixer 1, channel 2 coefficient byte[7:0]
0x10	MIX1_CH3_BYT1[7:0]	0x00	Digital mixer 1, channel 3 coefficient byte[31:24]
0x11	MIX1_CH3_BYT2[7:0]	0x00	Digital mixer 1, channel 3 coefficient byte[23:16]
0x12	MIX1_CH3_BYT3[7:0]	0x00	Digital mixer 1, channel 3 coefficient byte[15:8]
0x13	MIX1_CH3_BYT4[7:0]	0x00	Digital mixer 1, channel 3 coefficient byte[7:0]
0x14	MIX1_CH4_BYT1[7:0]	0x00	Digital mixer 1, channel 4 coefficient byte[31:24]
0x15	MIX1_CH4_BYT2[7:0]	0x00	Digital mixer 1, channel 4 coefficient byte[23:16]
0x16	MIX1_CH4_BYT3[7:0]	0x00	Digital mixer 1, channel 4 coefficient byte[15:8]
0x17	MIX1_CH4_BYT4[7:0]	0x00	Digital mixer 1, channel 4 coefficient byte[7:0]
0x18	MIX2_CH1_BYT1[7:0]	0x00	Digital mixer 2, channel 1 coefficient byte[31:24]
0x19	MIX2_CH1_BYT2[7:0]	0x00	Digital mixer 2, channel 1 coefficient byte[23:16]
0x1A	MIX2_CH1_BYT3[7:0]	0x00	Digital mixer 2, channel 1 coefficient byte[15:8]
0x1B	MIX2_CH1_BYT4[7:0]	0x00	Digital mixer 2, channel 1 coefficient byte[7:0]
0x1C	MIX2_CH2_BYT1[7:0]	0x7F	Digital mixer 2, channel 2 coefficient byte[31:24]
0x1D	MIX2_CH2_BYT2[7:0]	0xFF	Digital mixer 2, channel 2 coefficient byte[23:16]
0x1E	MIX2_CH2_BYT3[7:0]	0xFF	Digital mixer 2, channel 2 coefficient byte[15:8]
0x1F	MIX2_CH2_BYT4[7:0]	0xFF	Digital mixer 2, channel 2 coefficient byte[7:0]
0x20	MIX2_CH3_BYT1[7:0]	0x00	Digital mixer 2, channel 3 coefficient byte[31:24]
0x21	MIX2_CH3_BYT2[7:0]	0x00	Digital mixer 2, channel 3 coefficient byte[23:16]
0x22	MIX2_CH3_BYT3[7:0]	0x00	Digital mixer 2, channel 3 coefficient byte[15:8]
0x23	MIX2_CH3_BYT4[7:0]	0x00	Digital mixer 2, channel 3 coefficient byte[7:0]
0x24	MIX2_CH4_BYT1[7:0]	0x00	Digital mixer 2, channel 4 coefficient byte[31:24]
0x25	MIX2_CH4_BYT2[7:0]	0x00	Digital mixer 2, channel 4 coefficient byte[23:16]
0x26	MIX2_CH4_BYT3[7:0]	0x00	Digital mixer 2, channel 4 coefficient byte[15:8]
0x27	MIX2_CH4_BYT4[7:0]	0x00	Digital mixer 2, channel 4 coefficient byte[7:0]
0x28	MIX3_CH1_BYT1[7:0]	0x00	Digital mixer 3, channel 1 coefficient byte[31:24]
0x29	MIX3_CH1_BYT2[7:0]	0x00	Digital mixer 3, channel 1 coefficient byte[23:16]
0x2A	MIX3_CH1_BYT3[7:0]	0x00	Digital mixer 3, channel 1 coefficient byte[15:8]
0x2B	MIX3_CH1_BYT4[7:0]	0x00	Digital mixer 3, channel 1 coefficient byte[7:0]
0x2C	MIX3_CH2_BYT1[7:0]	0x00	Digital mixer 3, channel 2 coefficient byte[31:24]
0x2D	MIX3_CH2_BYT2[7:0]	0x00	Digital mixer 3, channel 2 coefficient byte[23:16]
0x2E	MIX3_CH2_BYT3[7:0]	0x00	Digital mixer 3, channel 2 coefficient byte[15:8]
0x2F	MIX3_CH2_BYT4[7:0]	0x00	Digital mixer 3, channel 2 coefficient byte[7:0]
0x30	MIX3_CH3_BYT1[7:0]	0x7F	Digital mixer 3, channel 3 coefficient byte[31:24]
0x31	MIX3_CH3_BYT2[7:0]	0xFF	Digital mixer 3, channel 3 coefficient byte[23:16]
0x32	MIX3_CH3_BYT3[7:0]	0xFF	Digital mixer 3, channel 3 coefficient byte[15:8]
0x33	MIX3_CH3_BYT4[7:0]	0xFF	Digital mixer 3, channel 3 coefficient byte[7:0]
0x34	MIX3_CH4_BYT1[7:0]	0x00	Digital mixer 3, channel 4 coefficient byte[31:24]
0x35	MIX3_CH4_BYT2[7:0]	0x00	Digital mixer 3, channel 4 coefficient byte[23:16]

Table 133. Page 0x04 Programmable Coefficient Registers (continued)

0x36	MIX3_CH4_BYT3[7:0]	0x00	Digital mixer 3, channel 4 coefficient byte[15:8]
0x37	MIX3_CH4_BYT4[7:0]	0x00	Digital mixer 3, channel 4 coefficient byte[7:0]
0x38	MIX4_CH1_BYT1[7:0]	0x00	Digital mixer 4, channel 1 coefficient byte[31:24]
0x39	MIX4_CH1_BYT2[7:0]	0x00	Digital mixer 4, channel 1 coefficient byte[23:16]
0x3A	MIX4_CH1_BYT3[7:0]	0x00	Digital mixer 4, channel 1 coefficient byte[15:8]
0x3B	MIX4_CH1_BYT4[7:0]	0x00	Digital mixer 4, channel 1 coefficient byte[7:0]
0x3C	MIX4_CH2_BYT1[7:0]	0x00	Digital mixer 4, channel 2 coefficient byte[31:24]
0x3D	MIX4_CH2_BYT2[7:0]	0x00	Digital mixer 4, channel 2 coefficient byte[23:16]
0x3E	MIX4_CH2_BYT3[7:0]	0x00	Digital mixer 4, channel 2 coefficient byte[15:8]
0x3F	MIX4_CH2_BYT4[7:0]	0x00	Digital mixer 4, channel 2 coefficient byte[7:0]
0x40	MIX4_CH3_BYT1[7:0]	0x00	Digital mixer 4, channel 3 coefficient byte[31:24]
0x41	MIX4_CH3_BYT2[7:0]	0x00	Digital mixer 4, channel 3 coefficient byte[23:16]
0x42	MIX4_CH3_BYT3[7:0]	0x00	Digital mixer 4, channel 3 coefficient byte[15:8]
0x43	MIX4_CH3_BYT4[7:0]	0x00	Digital mixer 4, channel 3 coefficient byte[7:0]
0x44	MIX4_CH4_BYT1[7:0]	0x7F	Digital mixer 4, channel 4 coefficient byte[31:24]
0x45	MIX4_CH4_BYT2[7:0]	0xFF	Digital mixer 4, channel 4 coefficient byte[23:16]
0x46	MIX4_CH4_BYT3[7:0]	0xFF	Digital mixer 4, channel 4 coefficient byte[15:8]
0x47	MIX4_CH4_BYT4[7:0]	0xFF	Digital mixer 4, channel 4 coefficient byte[7:0]
0x48	IIR_N0_BYT1[7:0]	0x7F	Programmable first-order IIR, N0 coefficient byte[31:24]
0x49	IIR_N0_BYT2[7:0]	0xFF	Programmable first-order IIR, N0 coefficient byte[23:16]
0x4A	IIR_N0_BYT3[7:0]	0xFF	Programmable first-order IIR, N0 coefficient byte[15:8]
0x4B	IIR_N0_BYT4[7:0]	0xFF	Programmable first-order IIR, N0 coefficient byte[7:0]
0x4C	IIR_N1_BYT1[7:0]	0x00	Programmable first-order IIR, N1 coefficient byte[31:24]
0x4D	IIR_N1_BYT2[7:0]	0x00	Programmable first-order IIR, N1 coefficient byte[23:16]
0x4E	IIR_N1_BYT3[7:0]	0x00	Programmable first-order IIR, N1 coefficient byte[15:8]
0x4F	IIR_N1_BYT4[7:0]	0x00	Programmable first-order IIR, N1 coefficient byte[7:0]
0x50	IIR_D1_BYT1[7:0]	0x00	Programmable first-order IIR, D1 coefficient byte[31:24]
0x51	IIR_D1_BYT2[7:0]	0x00	Programmable first-order IIR, D1 coefficient byte[23:16]
0x52	IIR_D1_BYT3[7:0]	0x00	Programmable first-order IIR, D1 coefficient byte[15:8]
0x53	IIR_D1_BYT4[7:0]	0x00	Programmable first-order IIR, D1 coefficient byte[7:0]

9 Application and Implementation

NOTE

Information in the following applications sections is not part of the TI component specification, and TI does not warrant its accuracy or completeness. TI's customers are responsible for determining suitability of components for their purposes. Customers should validate and test their design implementation to confirm system functionality.

9.1 Application Information

The TLV320ADC6140 is a multichannel, high-performance audio analog-to-digital converter (ADC) that supports output sample rates of up to 768 kHz. The device supports either up to four analog microphones or up to eight digital pulse density modulation (PDM) microphones for simultaneous recording applications.

Communication to the TLV320ADC6140 for configuration of the control registers is supported using an I²C or SPI interface. The device supports a highly flexible, audio serial interface (TDM, I²S, and L_J) to transmit audio data seamlessly in the system across devices.

9.2 Typical Applications

9.2.1 Four-Channel Analog Microphone Recording

Figure 172 shows a typical configuration of the TLV320ADC6140 for an application using four analog microelectrical-mechanical system (MEMS) microphones for simultaneous recording operation with an I²C control interface and a time-division multiplexing (TDM) audio data slave interface. For best distortion performance, use input AC-coupling capacitors with a low-voltage coefficient.

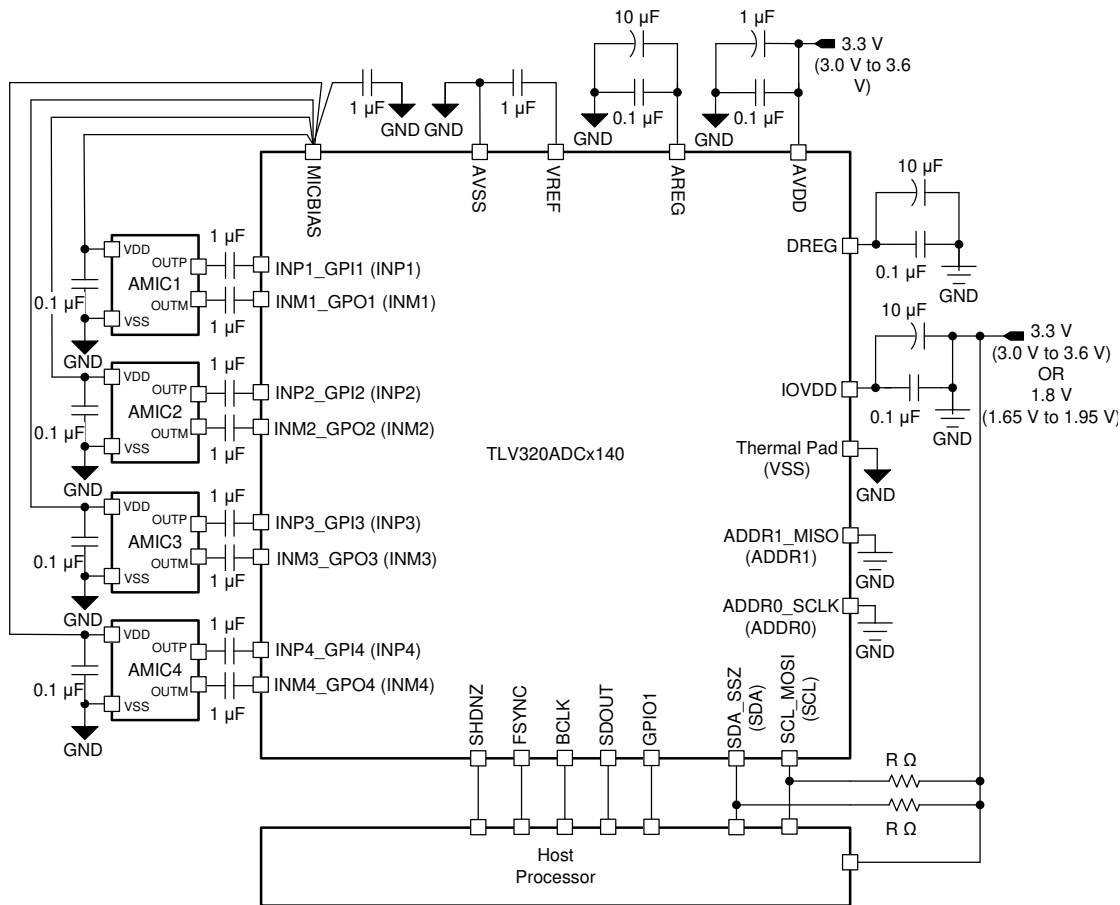

Figure 172. Four-Channel Analog Microphone Recording Diagram

Typical Applications (continued)

9.2.1.1 Design Requirements

Table 134 lists the design parameters for this application.

Table 134. Design Parameters

KEY PARAMETER	SPECIFICATION
AVDD	3.3 V
AVDD supply current consumption	> 23 mA (PLL on, four-channel recording, $f_S = 48$ kHz)
IOVDD	1.8 V or 3.3 V
Maximum MICBIAS current	10 mA (MICBIAS voltage is the same as AVDD)

9.2.1.2 Detailed Design Procedure

This section describes the necessary steps to configure the TLV320ADC6140 for this specific application. The following steps provide a sequence of items that must be executed in the time between powering the device up and reading data from the device or transitioning from one mode to another mode of operation.

1. Apply power to the device:
 - a. Power-up the IOVDD and AVDD power supplies, keeping the SHDNZ pin voltage low
 - b. The device now goes into hardware shutdown mode (ultra-low-power mode < 1 μ A)
2. Transition from hardware shutdown mode to sleep mode (or software shutdown mode):
 - a. Release SHDNZ only when the IOVDD and AVDD power supplies settle to the steady-state operating voltage
 - b. Wait for at least 1 ms to allow the device to initialize the internal registers
 - c. The device now goes into sleep mode (low-power mode < 10 μ A)
3. Transition from sleep mode to active mode whenever required for the recording operation:
 - a. Wake up the device by writing to P0_R2 to disable sleep mode
 - b. Wait for at least 1 ms to allow the device to complete the internal wake-up sequence
 - c. Override default configuration registers or programmable coefficients value as required (this step is optional)
 - d. Enable all desired input channels by writing to P0_R115
 - e. Enable all desired audio serial interface output channels by writing to P0_R116
 - f. Power-up the ADC, MICBIAS, and PLL by writing to P0_R117
 - g. Apply FSYNC and BCLK with the desired output sample rates and the BCLK to FSYNC ratio
This specific step can be done at any point in the sequence after step a.
See the [Phase-Locked Loop \(PLL\) and Clock Generation](#) section for supported sample rates and the BCLK to FSYNC ratio.
 - h. The device recording data are now sent to the host processor via the TDM audio serial data bus
4. Transition from active mode to sleep mode (again) as required in the system for low-power operation:
 - a. Enter sleep mode by writing to P0_R2 to enable sleep mode
 - b. Wait at least 6 ms (when FSYNC = 48 kHz) for the volume to ramp down and for all blocks to power down
 - c. Read P0_R119 to check the device shutdown and sleep mode status
 - d. If the device P0_R119_D7 status bit is 1'b1 then stop FSYNC and BCLK in the system
 - e. The device now goes into sleep mode (low-power mode < 10 μ A) and retains all register values
5. Transition from sleep mode to active mode (again) as required for the recording operation:
 - a. Wake up the device by writing to P0_R2 to disable sleep mode
 - b. Wait for at least 1 ms to allow the device to complete the internal wake-up sequence
 - c. Apply FSYNC and BCLK with the desired output sample rates and the BCLK to FSYNC ratio
 - d. The device recording data are now sent to the host processor via the TDM audio serial data bus

6. Repeat step 4 and step 5 as required for mode transitions
7. Assert the SHDNZ pin low to enter hardware shutdown mode (again) at any time
8. Follow step 2 onwards to exit hardware shutdown mode (again)

9.2.1.2.1 Example Device Register Configuration Script for EVM Setup

This section provides a typical EVM I²C register control script that shows how to set up the TLV320ADC6140 in a four-channel analog microphone recording mode with differential inputs.

```
# Key: w 98 XX YY ==> write to I2C address 0x98, to register 0xXX, data 0xYY
#           # ==> comment delimiter
#
# The following list gives an example sequence of items that must be executed in the time
# between powering the device up and reading data from the device. Note that there are
# other valid sequences depending on which features are used.
#
# See the TLV320ADC6140EVM user guide for jumper settings and audio connections.
#
# Differential 4-channel : INP1/INM1 - Ch1, INP2/INM2 - Ch2, INP3/INM3 - Ch3 and INP4/INM4 - Ch4
# FSYNC = 44.1 kHz (Output Data Sample Rate), BCLK = 11.2896 MHz (BCLK/FSYNC = 256)
#####
#
# Power up IOVDD and AVDD power supplies keeping SHDNZ pin voltage LOW
# Wait for IOVDD and AVDD power supplies to settle to steady state operating voltage range.
# Release SHDNZ to HIGH.
# Wait for 1ms.
#
# Wake-up device by I2C write into P0_R2 using internal AREG
w 98 02 81
#
# Enable Input Ch-1 to Ch-4 by I2C write into P0_R115
w 98 73 F0
#
# Enable ASI Output Ch-1 to Ch-4 slots by I2C write into P0_R116
w 98 74 F0
#
# Power-up ADC, MICBIAS and PLL by I2C write into P0_R117
w 98 75 E0
#
# Apply FSYNC = 44.1 kHz and BCLK = 11.2896 MHz and
# Start recording data by host on ASI bus with TDM protocol 32-bits channel wordlength
```

9.2.1.3 Application Curves

Measurements are done on the EVM by feeding the device analog input signal using audio precision.

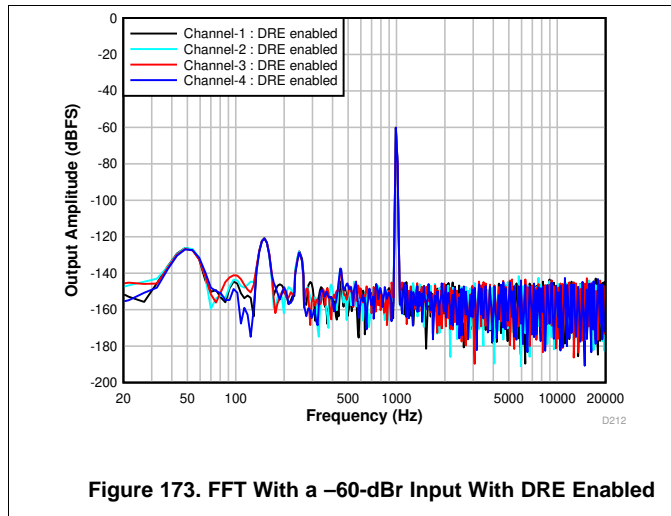

Figure 173. FFT With a -60-dBr Input With DRE Enabled

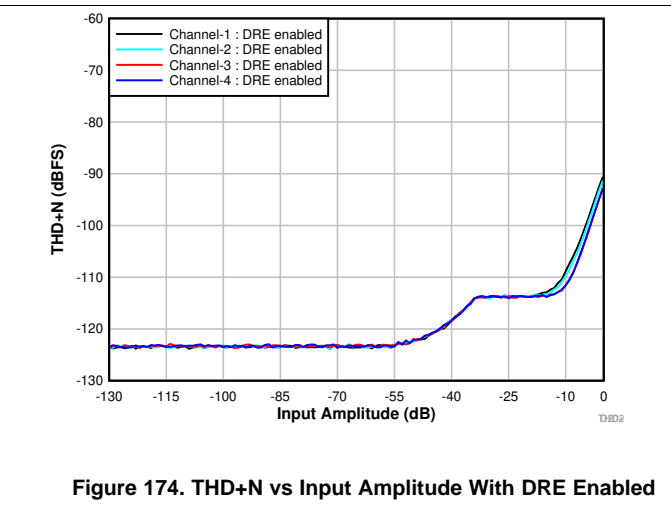

Figure 174. THD+N vs Input Amplitude With DRE Enabled

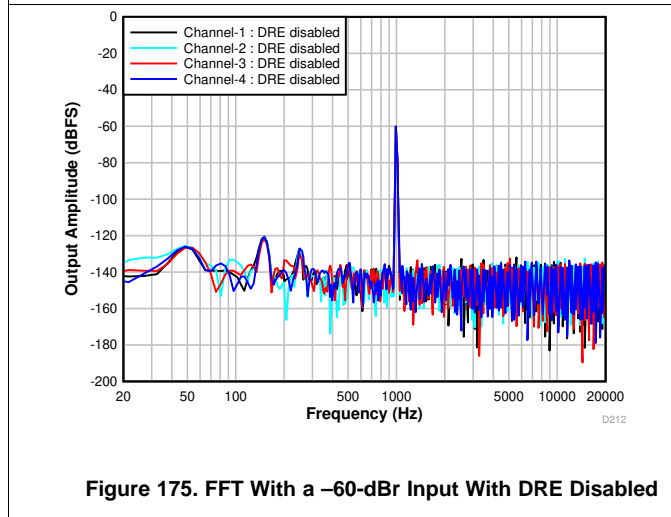

Figure 175. FFT With a -60-dBr Input With DRE Disabled

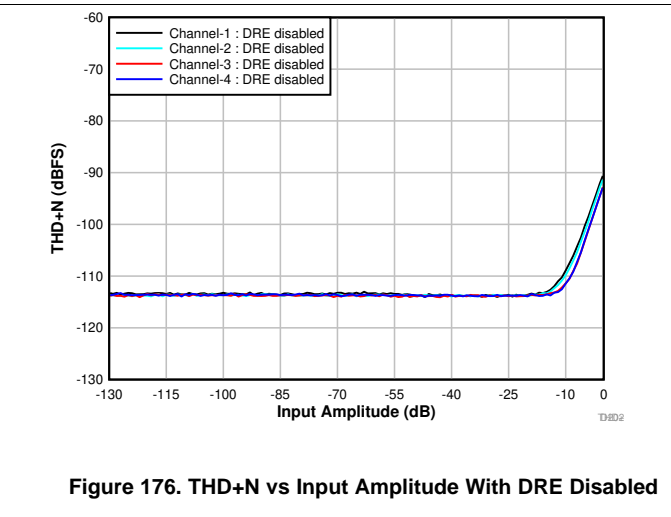

Figure 176. THD+N vs Input Amplitude With DRE Disabled

9.2.2 Eight-Channel Digital PDM Microphone Recording

Figure 172 shows a typical configuration of the TLV320ADC6140 for an application using eight digital PDM MEMS microphones with simultaneous recording operation using an I²C control interface and the TDM audio data slave interface.

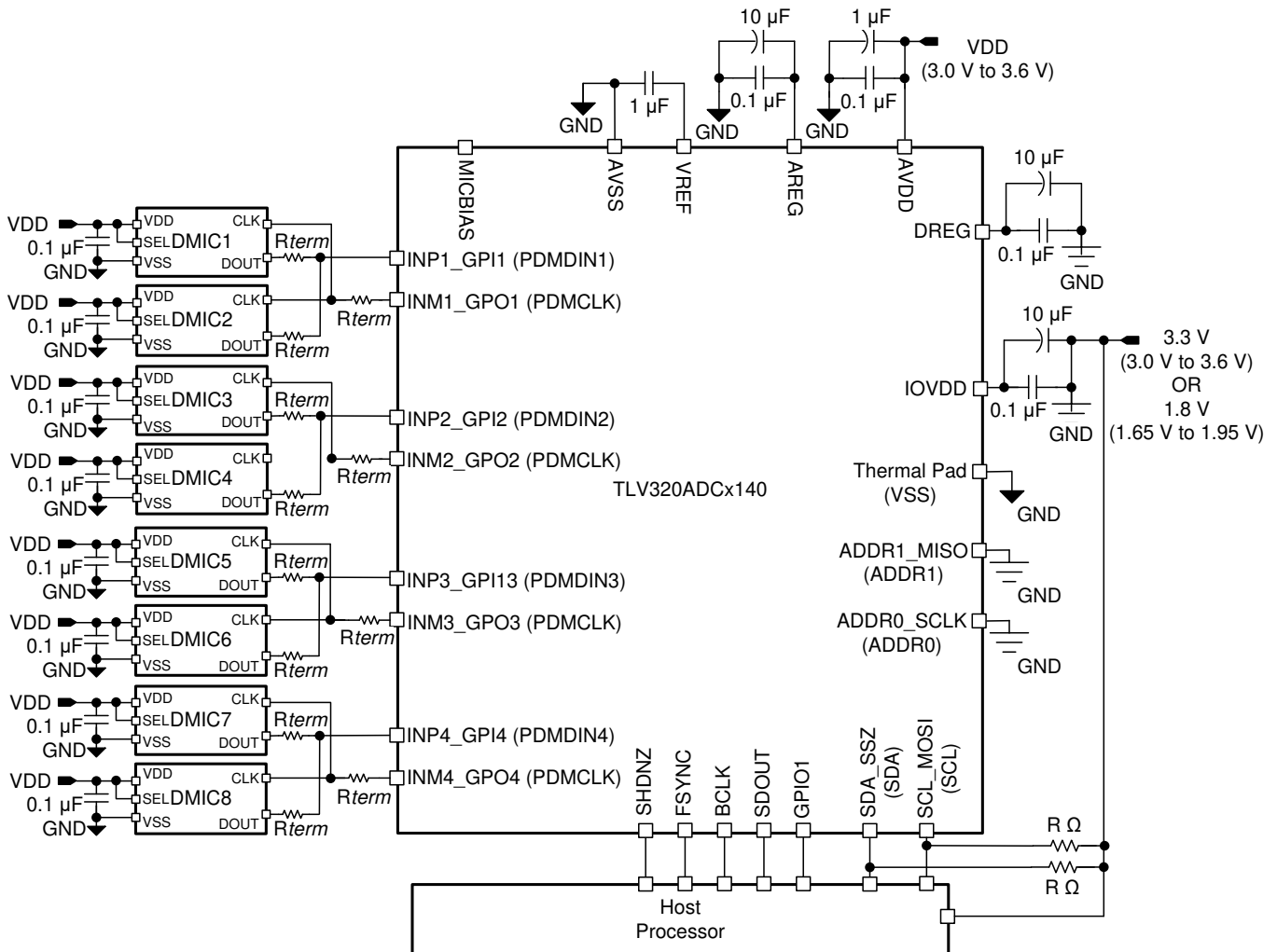

Figure 177. Eight-Channel Digital PDM Microphone Recording Diagram

9.2.2.1 Design Requirements

Table 135 lists the design parameters for this application.

Table 135. Design Parameters

KEY PARAMETER	SPECIFICATION
AVDD	3.3 V
AVDD supply current consumption	> 8 mA (PLL on, eight-channel recording, $f_S = 48$ kHz)
IOVDD	1.8 V or 3.3 V

9.2.2.2 Detailed Design Procedure

This section describes the necessary steps to configure the TLV320ADC6140 for this specific application. The following steps provide a sequence of items that must be executed in the time between powering the device up and reading data from the device or transitioning from one mode to another mode of operation.

1. Apply power to the device:
 - a. Power up the IOVDD and AVDD power supplies, keeping the SHDNZ pin voltage low
 - b. The device now goes into hardware shutdown mode (ultra-low-power mode < 1 μ A)
2. Transition from hardware shutdown mode to sleep mode (or software shutdown mode):
 - a. Release SHDNZ only when the IOVDD and AVDD power supplies settle to the steady-state operating voltage
 - b. Wait for at least 1 ms to allow the device to initialize the internal registers initialization
 - c. The device now goes into sleep mode (low-power mode < 10 μ A)
3. Transition from sleep mode to active mode whenever required for the recording operation:
 - a. Wake up the device by writing to P0_R2 to disable sleep mode
 - b. Wait for at least 1 ms to allow the device to complete the internal wake-up sequence
 - c. Override the default configuration registers or programmable coefficients value as required (this step is optional)
 - d. Configure channel 1 to channel 4 (CHx_INSRC) for the digital microphone as the input source for recording
 - e. Configure GPO1 to GPO4 (GPOx_CFG) as the PDMCLK output
 - f. Configure GPI1 to GPI4 (GPI1x_CFG) as PDMDIN1 to PDMDIN4, respectively
 - g. Enable all desired input channels by writing to P0_R115
 - h. Enable all desired audio serial interface output channels by writing to P0_R116
 - i. Power-up the ADC and PLL by writing to P0_R117
 - j. Apply FSYNC and BCLK with the desired output sample rates and the BCLK to FSYNC ratio
This specific step can be done at any point in the sequence after step a.
See the [Phase-Locked Loop \(PLL\) and Clock Generation](#) section for supported sample rates and the BCLK to FSYNC ratio.
 - k. The device recording data is now sent to the host processor using the TDM audio serial data bus
4. Transition from active mode to sleep mode (again) as required in the system for low-power operation:
 - a. Enter sleep mode by writing to P0_R2 to enable sleep mode
 - b. Wait at least 6 ms (when FSYNC = 48 kHz) for the volume to ramp down and for all blocks to power down
 - c. Read P0_R119 to check the device shutdown and sleep mode status
 - d. If the device P0_R119_D7 status bit is 1'b1 then stop FSYNC and BCLK in the system
 - e. The device now goes into sleep mode (low-power mode < 10 μ A) and retains all register values
5. Transition from sleep mode to active mode (again) as required for the recording operation:
 - a. Wake up the device by writing to P0_R2 to disable sleep mode
 - b. Wait at least 1 ms to allow the device to complete the internal wake-up sequence
 - c. Apply FSYNC and BCLK with the desired output sample rates and the BCLK to FSYNC ratio
 - d. The device recording data are now sent to the host processor using the TDM audio serial data bus
6. Repeat step 4 and step 5 as required for mode transitions
7. Assert the SHDNZ pin low to enter hardware shutdown mode (again) at any time
8. Follow step 2 onwards to exit hardware shutdown mode (again)

9.2.2.2.1 Example Device Register Configuration Script for EVM Setup

This section provides a typical EVM I²C register control script that shows how to set up the TLV320ADC6140 in an eight-channel digital PDM microphone recording mode.

```
# Key: w 98 XX YY ==> write to I2C address 0x98, to register 0xXX, data 0xYY
#           # ==> comment delimiter
#
# The following list gives an example sequence of items that must be executed in the time
# between powering the device up and reading data from the device. Note that there are
# other valid sequences depending on which features are used.
#
# See the TLV320ADC6140EVM user guide for jumper settings and audio connections.
#
# PDM 8-channel : PDMDIN1 - Ch1 and Ch2, PDMDIN2 - Ch3 and Ch4,
#                 PDMDIN3 - Ch5 and Ch6, PDMDIN4 - Ch7 and Ch8
# FSYNC = 44.1 kHz (Output Data Sample Rate), BCLK = 11.2896 MHz (BCLK/FSYNC = 256)
#####
#
# Power up IOVDD and AVDD power supplies keeping SHDNZ pin voltage LOW
# Wait for IOVDD and AVDD power supplies to settle to steady state operating voltage range.
# Release SHDNZ to HIGH.
# Wait for 1ms.
#
# Wake-up device by I2C write into P0_R2 using internal AREG
w 98 02 81
#
# Configure CH1_INSRC as Digital PDM Input by I2C write into P0_R60
w 98 3C 40
#
# Configure CH2_INSRC as Digital PDM Input by I2C write into P0_R65
w 98 41 40
#
# Configure CH3_INSRC as Digital PDM Input by I2C write into P0_R70
w 98 46 40
#
# Configure CH4_INSRC as Digital PDM Input by I2C write into P0_R75
w 98 4B 40
#
# Configure GPO1 as PDMCLK by I2C write into P0_R34
w 98 22 41
#
# Configure GPO2 as PDMCLK by I2C write into P0_R35
w 98 23 41
#
# Configure GPO3 as PDMCLK by I2C write into P0_R36
w 98 24 41
#
# Configure GPO4 as PDMCLK by I2C write into P0_R37
w 98 25 41
#
# Configure GPI1 and GPI2 as PDMDIN1 and PDMDIN2 by I2C write into P0_R43
w 98 2B 45
#
# Configure GPI3 and GPI4 as PDMDIN3 and PDMDIN4 by I2C write into P0_R44
w 98 2C 67
#
# Enable Input Ch-1 to Ch-8 by I2C write into P0_R115
w 98 73 FF
#
# Enable ASI Output Ch-1 to Ch-8 slots by I2C write into P0_R116
w 98 74 FF
#
# Power-up ADC and PLL by I2C write into P0_R117
w 98 75 60
#
# Apply FSYNC = 44.1 kHz and BCLK = 11.2896 MHz and
# Start recording data by host on ASI bus with TDM protocol 32-bits channel wordlength
```

9.3 What to Do and What Not to Do

In master mode operation with I²S or LJ format, the device generates FSYNC half a cycle earlier than the normal protocol timing behavior expected. This timing behavior can still function for most of the system, however for further details and a suggested workaround for this weakness, see the [Configuring and Operating the TLV320ADCx140 as an Audio Bus Master application report](#).

The automatic gain controller (AGC) feature has some limitation when using sampling rates lower than 44.1 kHz. For further details about this limitation, see the [Using the Automatic Gain Controller \(AGC\) in TLV320ADCx140 application report](#).

10 Power Supply Recommendations

The power-supply sequence between the IOVDD and AVDD rails can be applied in any order. However, keep the SHDNZ pin low until the IOVDD supply voltage settles to a stable and supported operating voltage range. After all supplies are stable, set the SHDNZ pin high to initialize the device.

For the supply power-up requirement, t_1 and t_2 must be at least 100 μ s. For the supply power-down requirement, t_3 and t_4 must be at least 10 ms. This timing (as shown in [Figure 178](#)) allows the device to ramp down the volume on the record data, power down the analog and digital blocks, and put the device into hardware shutdown mode. The device can also be immediately put into hardware shutdown mode from active mode if SHDNZ_CFG[1:0] is set to 2'b00 using the P0_R5_D[3:2] bits. In that case, t_3 and t_4 are required to be at least 100 μ s.

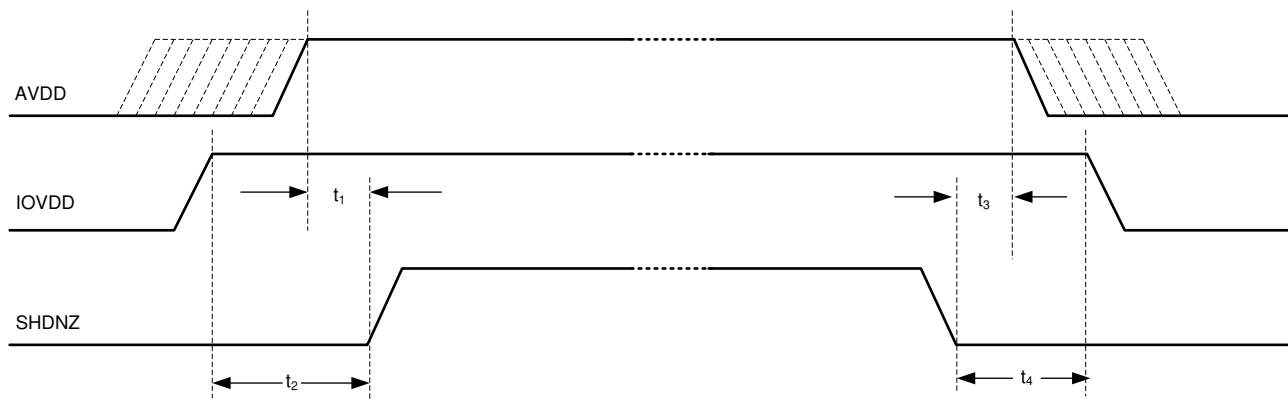

Figure 178. Power-Supply Sequencing Requirement Timing Diagram

Make sure that the supply ramp rate is slower than 1 V/ μ s and that the wait time between a power-down and a power-up event is at least 100 ms.

After releasing SHDNZ, or after a software reset, delay any additional I²C or SPI transactions to the device for at least 2 ms to allow the device to initialize the internal registers. See the [Device Functional Modes](#) section for details on how the device operates in various modes after the device power supplies are settled to the recommended operating voltage levels.

The TLV320ADC6140 supports a single AVDD supply operation by integrating an on-chip digital regulator, DREG, and an analog regulator, AREG. However, if the AVDD voltage is less than 1.98 V in the system, then short the AREG and AVDD pins onboard and do not enable the internal AREG by keeping the AREG_SELECT bit to 1b'0 (default value) of P0_R2. If the AVDD supply used in the system is higher than 2.7 V, then the host device can set AREG_SELECT to 1b'1 while exiting sleep mode to allow the device internal regulator to generate the AREG supply.

11 Layout

11.1 Layout Guidelines

Each system design and printed circuit board (PCB) layout is unique. The layout must be carefully reviewed in the context of a specific PCB design. However, the following guidelines can optimize the device performance:

- Connect the thermal pad to ground. Use a via pattern to connect the device thermal pad, which is the area directly under the device, to the ground planes. This connection helps dissipate heat from the device.
- The decoupling capacitors for the power supplies must be placed close to the device pins.
- Route the analog differential audio signals differentially on the PCB for better noise immunity. Avoid crossing digital and analog signals to prevent undesirable crosstalk.
- The device internal voltage references must be filtered using external capacitors. Place the filter capacitors near the VREF pin for optimal performance.
- Directly tap the MICBIAS pin to avoid common impedance when routing the biasing or supply traces for multiple microphones to avoid coupling across microphones.
- Directly short the VREF and MICBIAS external capacitors ground terminal to the AVSS pin without using any vias for this connection trace.
- Place the MICBIAS capacitor (with low equivalent series resistance) close to the device with minimal trace impedance.
- Use ground planes to provide the lowest impedance for power and signal current between the device and the decoupling capacitors. Treat the area directly under the device as a central ground area for the device, and all device grounds must be connected directly to that area.

11.2 Layout Example

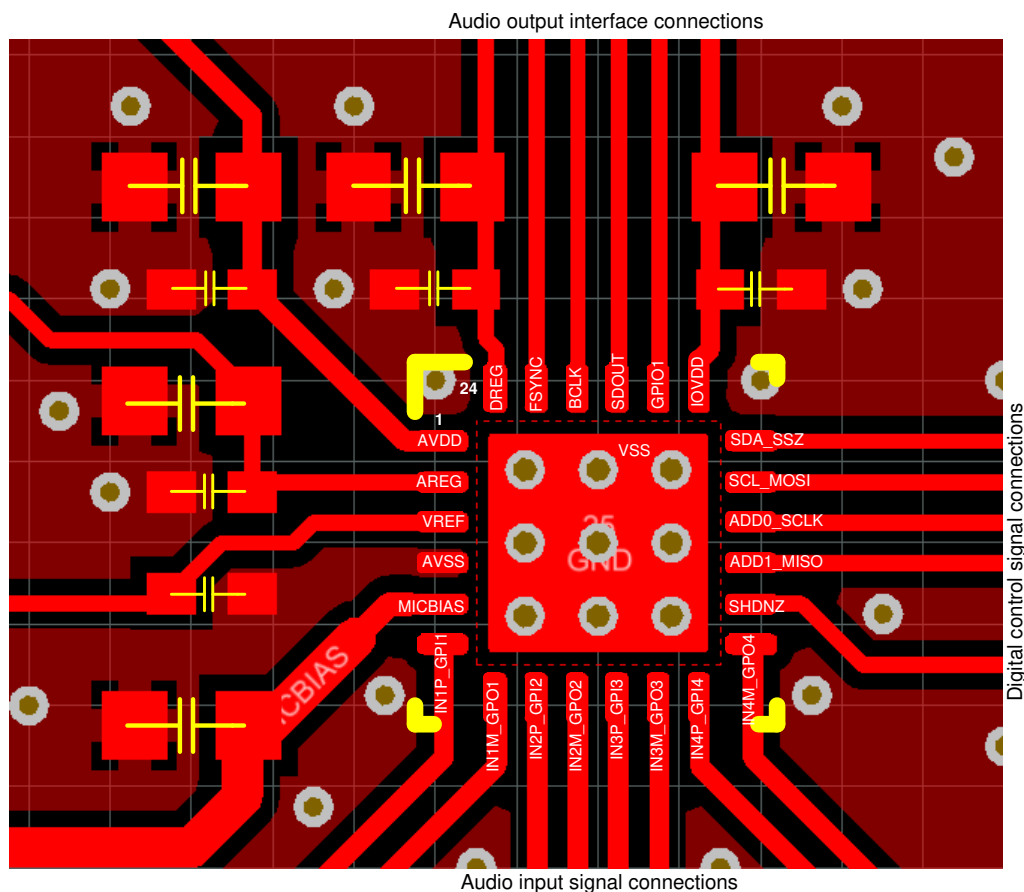

Figure 179. Layout Example

12 Device and Documentation Support

12.1 Documentation Support

12.1.1 Related Documentation

For related documentation see the following:

- Texas Instruments, [Multiple TLV320ADCx140 Devices With a Shared TDM and I²C Bus application report](#)
- Texas Instruments, [Configuring and Operating the TLV320ADCx140 as an Audio Bus Master application report](#)
- Texas Instruments, [TLV320ADCx140 Sampling Rates and Programmable Processing Blocks Supported application report](#)
- Texas Instruments, [TLV320ADCx140 Programmable Biquad Filter Configuration and Applications application report](#)
- Texas Instruments, [TLV320ADCx140 Operation for Low-Power Critical Applications application report](#)
- Texas Instruments, [TLV320ADCx140 Power Consumption Matrix Across Various Usage Scenarios application report](#)
- Texas Instruments, [TLV320ADCx140 Integrated Analog Antialiasing Filter and Flexible Digital Filter application report](#)
- Texas Instruments, [Using the Automatic Gain Controller \(AGC\) in TLV320ADCx140 application report](#)
- Texas Instruments, [Using the Dynamic Range Enhancer \(DRE\) in TLV320ADC5140/6140 application report](#)
- Texas Instruments, [TLV320ADCx140 Evaluation module user's guide](#)
- Texas Instruments, [PurePath™ Console Graphical Development Suite for Audio System Design and Development](#)

12.2 Receiving Notification of Documentation Updates

To receive notification of documentation updates, navigate to the device product folder on ti.com. In the upper right corner, click on *Alert me* to register and receive a weekly digest of any product information that has changed. For change details, review the revision history included in any revised document.

12.3 Community Resources

[TI E2E™ support forums](#) are an engineer's go-to source for fast, verified answers and design help — straight from the experts. Search existing answers or ask your own question to get the quick design help you need.

Linked content is provided "AS IS" by the respective contributors. They do not constitute TI specifications and do not necessarily reflect TI's views; see TI's [Terms of Use](#).

12.4 Trademarks

Burr-Brown, PurePath, E2E are trademarks of Texas Instruments. All other trademarks are the property of their respective owners.

12.5 Electrostatic Discharge Caution



This integrated circuit can be damaged by ESD. Texas Instruments recommends that all integrated circuits be handled with appropriate precautions. Failure to observe proper handling and installation procedures can cause damage.

ESD damage can range from subtle performance degradation to complete device failure. Precision integrated circuits may be more susceptible to damage because very small parametric changes could cause the device not to meet its published specifications.

12.6 Glossary

[SLYZ022](#) — *TI Glossary*.

This glossary lists and explains terms, acronyms, and definitions.

13 Mechanical, Packaging, and Orderable Information

The following pages include mechanical, packaging, and orderable information. This information is the most current data available for the designated devices. This data is subject to change without notice and revision of this document. For browser-based versions of this data sheet, refer to the left-hand navigation.

PACKAGING INFORMATION

Orderable part number	Status (1)	Material type (2)	Package Pins	Package qty Carrier	RoHS (3)	Lead finish/ Ball material (4)	MSL rating/ Peak reflow (5)	Op temp (°C)	Part marking (6)
6PADC6140IRTWTG4	Active	Production	WQFN (RTW) 24	250 SMALL T&R	Yes	NIPDAU	Level-1-260C-UNLIM	-40 to 125	ADC6140
6PADC6140IRTWTG4.A	Active	Production	WQFN (RTW) 24	250 SMALL T&R	Yes	NIPDAU	Level-1-260C-UNLIM	-40 to 125	ADC6140
TLV320ADC6140IRTW	Active	Production	WQFN (RTW) 24	3000 LARGE T&R	Yes	NIPDAU	Level-1-260C-UNLIM	-40 to 125	ADC6140
TLV320ADC6140IRTW.A	Active	Production	WQFN (RTW) 24	3000 LARGE T&R	Yes	NIPDAU	Level-1-260C-UNLIM	-40 to 125	ADC6140
TLV320ADC6140IRTW	Active	Production	WQFN (RTW) 24	250 SMALL T&R	Yes	NIPDAU	Level-1-260C-UNLIM	-40 to 125	ADC6140
TLV320ADC6140IRTW.A	Active	Production	WQFN (RTW) 24	250 SMALL T&R	Yes	NIPDAU	Level-1-260C-UNLIM	-40 to 125	ADC6140

(1) **Status:** For more details on status, see our [product life cycle](#).

(2) **Material type:** When designated, preproduction parts are prototypes/experimental devices, and are not yet approved or released for full production. Testing and final process, including without limitation quality assurance, reliability performance testing, and/or process qualification, may not yet be complete, and this item is subject to further changes or possible discontinuation. If available for ordering, purchases will be subject to an additional waiver at checkout, and are intended for early internal evaluation purposes only. These items are sold without warranties of any kind.

(3) **RoHS values:** Yes, No, RoHS Exempt. See the [TI RoHS Statement](#) for additional information and value definition.

(4) **Lead finish/Ball material:** Parts may have multiple material finish options. Finish options are separated by a vertical ruled line. Lead finish/Ball material values may wrap to two lines if the finish value exceeds the maximum column width.

(5) **MSL rating/Peak reflow:** The moisture sensitivity level ratings and peak solder (reflow) temperatures. In the event that a part has multiple moisture sensitivity ratings, only the lowest level per JEDEC standards is shown. Refer to the shipping label for the actual reflow temperature that will be used to mount the part to the printed circuit board.

(6) **Part marking:** There may be an additional marking, which relates to the logo, the lot trace code information, or the environmental category of the part.

Multiple part markings will be inside parentheses. Only one part marking contained in parentheses and separated by a "~" will appear on a part. If a line is indented then it is a continuation of the previous line and the two combined represent the entire part marking for that device.

Important Information and Disclaimer: The information provided on this page represents TI's knowledge and belief as of the date that it is provided. TI bases its knowledge and belief on information provided by third parties, and makes no representation or warranty as to the accuracy of such information. Efforts are underway to better integrate information from third parties. TI has taken and continues to take reasonable steps to provide representative and accurate information but may not have conducted destructive testing or chemical analysis on incoming materials and chemicals. TI and TI suppliers consider certain information to be proprietary, and thus CAS numbers and other limited information may not be available for release.

In no event shall TI's liability arising out of such information exceed the total purchase price of the TI part(s) at issue in this document sold by TI to Customer on an annual basis.

TAPE AND REEL INFORMATION

QUADRANT ASSIGNMENTS FOR PIN 1 ORIENTATION IN TAPE

*All dimensions are nominal

Device	Package Type	Package Drawing	Pins	SPQ	Reel Diameter (mm)	Reel Width W1 (mm)	A0 (mm)	B0 (mm)	K0 (mm)	P1 (mm)	W (mm)	Pin1 Quadrant
6PAD6140IRTWTG4	WQFN	RTW	24	250	180.0	12.4	4.25	4.25	1.15	8.0	12.0	Q2
TLV320ADC6140IRTWR	WQFN	RTW	24	3000	330.0	12.4	4.25	4.25	1.15	8.0	12.0	Q2
TLV320ADC6140IRTWT	WQFN	RTW	24	250	180.0	12.4	4.25	4.25	1.15	8.0	12.0	Q2

TAPE AND REEL BOX DIMENSIONS



*All dimensions are nominal

Device	Package Type	Package Drawing	Pins	SPQ	Length (mm)	Width (mm)	Height (mm)
6PAD6140IRTWTG4	WQFN	RTW	24	250	210.0	185.0	35.0
TLV320ADC6140IRTWR	WQFN	RTW	24	3000	367.0	367.0	35.0
TLV320ADC6140IRTWT	WQFN	RTW	24	250	210.0	185.0	35.0

GENERIC PACKAGE VIEW

RTW 24

WQFN - 0.8 mm max height

4 x 4, 0.5 mm pitch

PLASTIC QUAD FLATPACK - NO LEAD

This image is a representation of the package family, actual package may vary.
Refer to the product data sheet for package details.

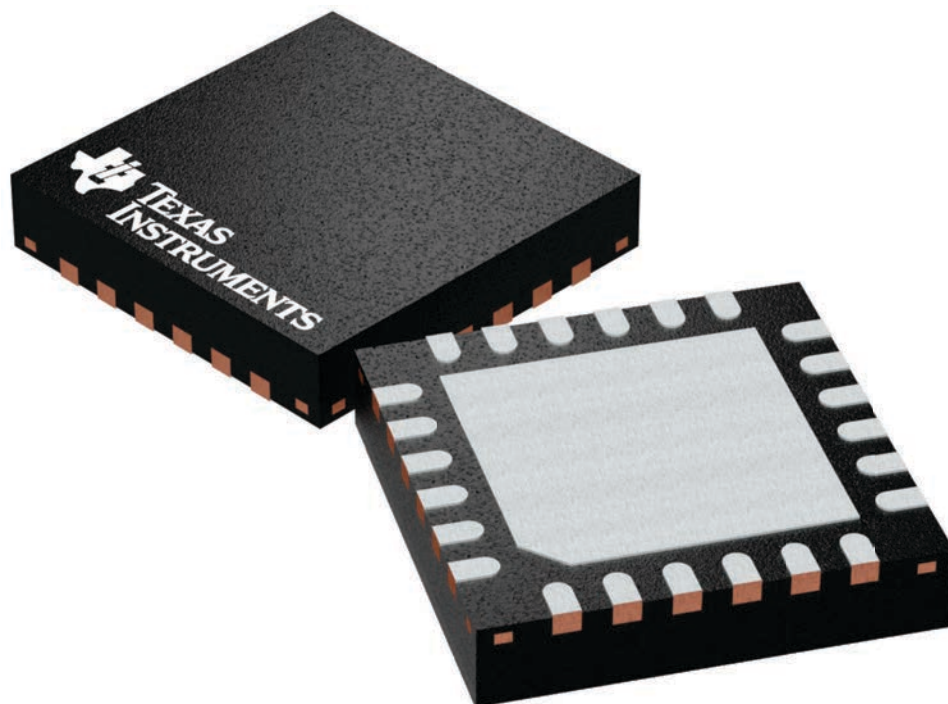

4224801/A

RTW (S-PWQFN-N24)

PLASTIC QUAD FLATPACK NO-LEAD

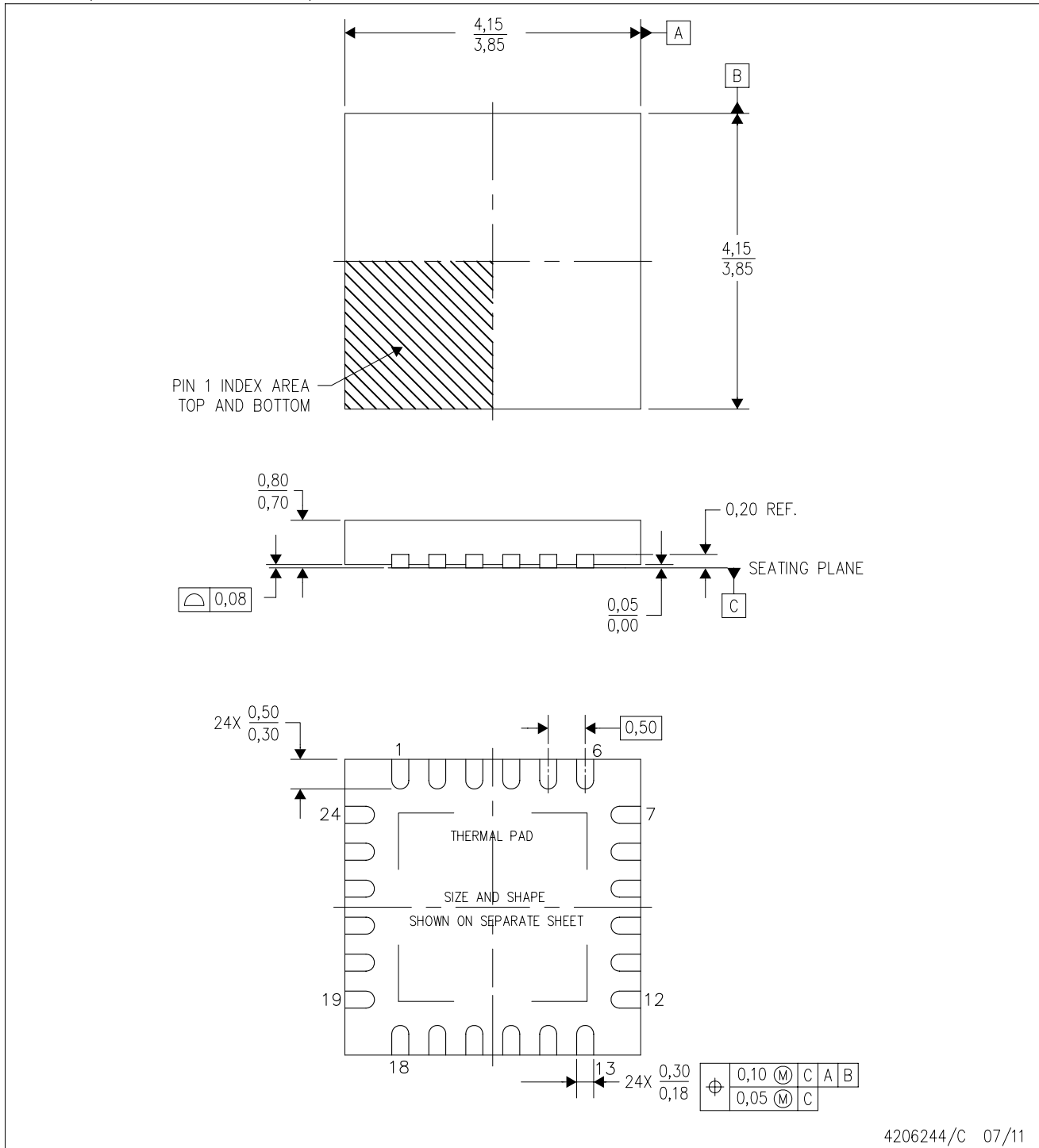

4206244/C 07/11

- NOTES:
- A. All linear dimensions are in millimeters. Dimensioning and tolerancing per ASME Y14.5M-1994.
 - B. This drawing is subject to change without notice.
 - C. Quad Flatpack, No-Leads (QFN) package configuration.
 - D. The package thermal pad must be soldered to the board for thermal and mechanical performance.
 - E. See the additional figure in the Product Data Sheet for details regarding the exposed thermal pad features and dimensions.
 - F. Falls within JEDEC MO-220.

THERMAL INFORMATION

This package incorporates an exposed thermal pad that is designed to be attached directly to an external heatsink. The thermal pad must be soldered directly to the printed circuit board (PCB). After soldering, the PCB can be used as a heatsink. In addition, through the use of thermal vias, the thermal pad can be attached directly to the appropriate copper plane shown in the electrical schematic for the device, or alternatively, can be attached to a special heatsink structure designed into the PCB. This design optimizes the heat transfer from the integrated circuit (IC).

For information on the Quad Flatpack No-Lead (QFN) package and its advantages, refer to Application Report, QFN/SON PCB Attachment, Texas Instruments Literature No. SLUA271. This document is available at www.ti.com.

The exposed thermal pad dimensions for this package are shown in the following illustration.

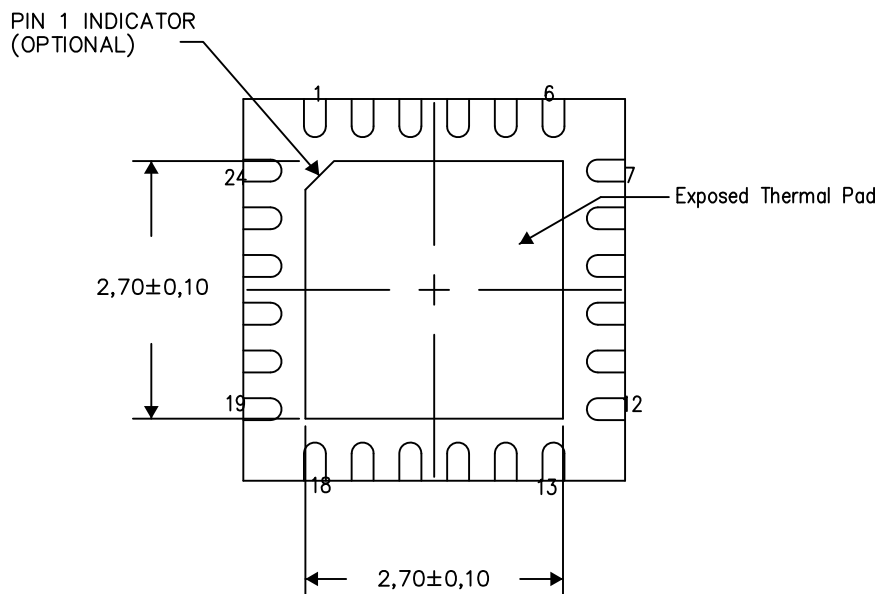

Bottom View

Exposed Thermal Pad Dimensions

4206249-5/P 05/15

NOTES: A. All linear dimensions are in millimeters

RTW (S-PWQFN-N24)

PLASTIC QUAD FLATPACK NO-LEAD

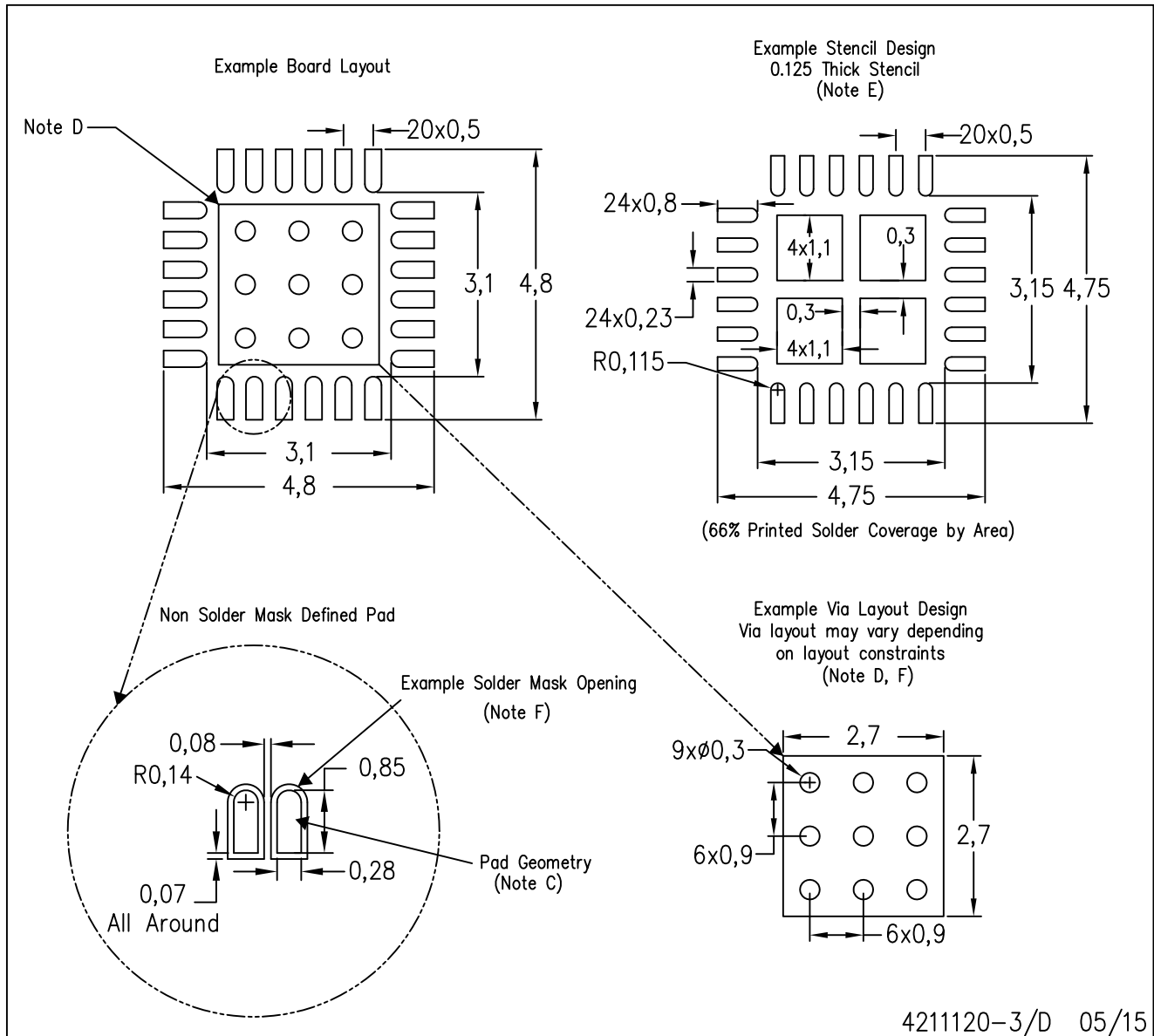

- NOTES:
- All linear dimensions are in millimeters.
 - This drawing is subject to change without notice.
 - Publication IPC-7351 is recommended for alternate designs.
 - This package is designed to be soldered to a thermal pad on the board. Refer to Application Note, Quad Flat-Pack Packages, Texas Instruments Literature No. SLUA271, and also the Product Data Sheets for specific thermal information, via requirements, and recommended board layout. These documents are available at www.ti.com <<http://www.ti.com>>.
 - Laser cutting apertures with trapezoidal walls and also rounding corners will offer better paste release. Customers should contact their board assembly site for stencil design recommendations. Refer to IPC 7525 for stencil design considerations.
 - Customers should contact their board fabrication site for recommended solder mask tolerances and via tenting recommendations for vias placed in the thermal pad.

IMPORTANT NOTICE AND DISCLAIMER

TI PROVIDES TECHNICAL AND RELIABILITY DATA (INCLUDING DATASHEETS), DESIGN RESOURCES (INCLUDING REFERENCE DESIGNS), APPLICATION OR OTHER DESIGN ADVICE, WEB TOOLS, SAFETY INFORMATION, AND OTHER RESOURCES "AS IS" AND WITH ALL FAULTS, AND DISCLAIMS ALL WARRANTIES, EXPRESS AND IMPLIED, INCLUDING WITHOUT LIMITATION ANY IMPLIED WARRANTIES OF MERCHANTABILITY, FITNESS FOR A PARTICULAR PURPOSE OR NON-INFRINGEMENT OF THIRD PARTY INTELLECTUAL PROPERTY RIGHTS.

These resources are intended for skilled developers designing with TI products. You are solely responsible for (1) selecting the appropriate TI products for your application, (2) designing, validating and testing your application, and (3) ensuring your application meets applicable standards, and any other safety, security, regulatory or other requirements.

These resources are subject to change without notice. TI grants you permission to use these resources only for development of an application that uses the TI products described in the resource. Other reproduction and display of these resources is prohibited. No license is granted to any other TI intellectual property right or to any third party intellectual property right. TI disclaims responsibility for, and you fully indemnify TI and its representatives against any claims, damages, costs, losses, and liabilities arising out of your use of these resources.

TI's products are provided subject to [TI's Terms of Sale](#), [TI's General Quality Guidelines](#), or other applicable terms available either on [ti.com](#) or provided in conjunction with such TI products. TI's provision of these resources does not expand or otherwise alter TI's applicable warranties or warranty disclaimers for TI products. Unless TI explicitly designates a product as custom or customer-specified, TI products are standard, catalog, general purpose devices.

TI objects to and rejects any additional or different terms you may propose.

Copyright © 2025, Texas Instruments Incorporated

Last updated 10/2025