

TLV1117LV 1-A, Positive Fixed-Voltage, Low-Dropout Regulator

1 Features

- Typical accuracy: 1.5%
- Low I_Q : 100 μ A (maximum)
 - 500 times lower than standard 1117 devices
- V_{IN} : 2 V to 5.5 V
 - Absolute maximum V_{IN} : 6 V
- Stable With 0-mA output current
- Low dropout: 455 mV at 1 A for $V_{OUT} = 3.3$ V
- High PSRR: 65 dB at 1 kHz
- Minimum specified current limit: 1.1 A
- Stable with cost-effective ceramic capacitors:
 - With 0- Ω ESR
- Temperature range: -40°C to $+125^\circ\text{C}$
- Thermal shutdown and overcurrent protection
- For drop-in replacement with upgraded functionality, see the [TLV761](#)
- Available in a SOT-223 package
 - See the [Mechanical, Packaging, and Orderable Information](#) section at the end of this document for a complete list of available voltage options.

2 Applications

- [Set-top boxes](#)
- [TVs and monitors](#)
- [PC peripherals, notebooks, motherboards](#)
- [Modems and other communication products](#)
- [Switching power supply post-regulation](#)

3 Description

The TLV1117LV low-dropout (LDO) linear regulator is a low input voltage version of the popular TLV1117 voltage regulator.

The TLV1117LV is an extremely low-power device that consumes 500 times lower quiescent current than traditional 1117 voltage regulators, making the device designed for applications that mandate very low standby current. The TLV1117LV LDO is also stable with 0 mA of load current; there is no minimum load requirement, making the device a good choice for applications where the regulator must power very small loads during standby in addition to large currents on the order of 1 A during normal operation. The TLV1117LV offers excellent line and load transient performance, resulting in very small magnitude undershoots and overshoots of output voltage when the load current requirement changes from less than 1 mA to more than 500 mA.

A precision band-gap and error amplifier provides 1.5% accuracy. A very high power-supply rejection ratio (PSRR) enables use of the device for post-regulation after a switching regulator. Other valuable features include low output noise and low-dropout voltage.

The device is internally compensated to be stable with 0- Ω equivalent series resistance (ESR) capacitors. These key advantages enable the use of cost-effective, small-size ceramic capacitors. Cost-effective capacitors that have higher bias voltages and temperature derating can also be used if desired.

The TLV1117LV is available in a SOT-223 package.

Package Information

PART NUMBER	PACKAGE ⁽¹⁾	BODY SIZE (NOM)
TLV1117LV	DCY (SOT-223, 4)	6.50 mm \times 3.50 mm

(1) For all available packages, see the orderable addendum at the end of the data sheet.

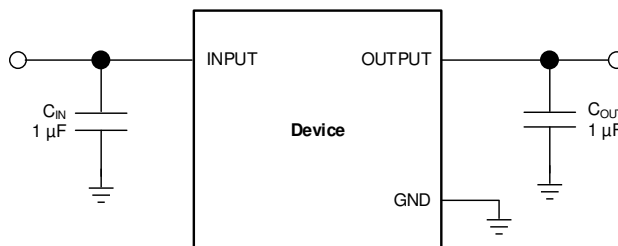

Typical Application Circuit



Table of Contents

1 Features	1	8 Application and Implementation	13
2 Applications	1	8.1 Application Information.....	13
3 Description	1	8.2 Typical Application.....	13
4 Revision History	2	8.3 Best Design Practices.....	14
5 Pin Configuration and Functions	3	8.4 Power Supply Recommendations.....	14
6 Specifications	4	8.5 Layout.....	14
6.1 Absolute Maximum Ratings.....	4	9 Device and Documentation Support	16
6.2 ESD Ratings.....	4	9.1 Device Support.....	16
6.3 Recommended Operating Conditions.....	4	9.2 Documentation Support.....	16
6.4 Thermal Information.....	4	9.3 Receiving Notification of Documentation Updates....	16
6.5 Electrical Characteristics.....	5	9.4 Support Resources.....	16
6.6 Typical Characteristics.....	6	9.5 Trademarks.....	16
7 Detailed Description	11	9.6 Electrostatic Discharge Caution.....	16
7.1 Overview.....	11	9.7 Glossary.....	16
7.2 Functional Block Diagram.....	11	10 Mechanical, Packaging, and Orderable	
7.3 Feature Description.....	11	Information	17
7.4 Device Functional Modes.....	12		

4 Revision History

NOTE: Page numbers for previous revisions may differ from page numbers in the current version.

Changes from Revision B (January 2015) to Revision C (January 2023)	Page
• Added drop-in replacement bullet to <i>Features</i> section.....	1

Changes from Revision A (September 2011) to Revision B (January 2015)	Page
• Added <i>ESD Ratings</i> table, <i>Feature Description</i> section, <i>Device Functional Modes</i> , <i>Application and Implementation</i> section, <i>Power Supply Recommendations</i> section, <i>Layout</i> section, <i>Device and Documentation Support</i> section, and <i>Mechanical, Packaging, and Orderable Information</i> section	1
• Replaced front-page figure	1
• Deleted <i>Dissipation Ratings</i> table.....	4

5 Pin Configuration and Functions

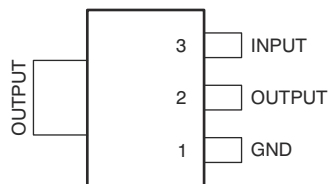

Figure 5-1. DCY Package, 4 Pins (SOT-223) (Top View)

Table 5-1. Pin Functions

PIN		I/O	DESCRIPTION
NAME	NO.		
IN	3	I	Input pin. See the Input and Output Capacitor Requirements section for more details.
OUT	2, Tab	O	Regulated output voltage pin. See the Input and Output Capacitor Requirements section for more details.
GND	1	—	Ground pin.

6 Specifications

6.1 Absolute Maximum Ratings

at $T_J = 25^\circ\text{C}$ (unless otherwise noted); all voltages are with respect to GND⁽¹⁾

		MIN	MAX	UNIT
Voltage	V_{IN}	-0.3	6	V
	V_{OUT}	-0.3	6	V
Current	I_{OUT}	Internally limited		
Output short-circuit duration		Indefinite		
Continuous total power dissipation	P_{DISS}	See Thermal Information		
Temperature	Operating junction, T_J	-55	150	$^\circ\text{C}$
	Storage, T_{stg}	-55	150	$^\circ\text{C}$

- (1) Stresses beyond those listed under *Absolute Maximum Ratings* may cause permanent damage to the device. These are stress ratings only, and functional operation of the device at these or any other conditions beyond those indicated under *Recommended Operating Conditions* is not implied. Exposure to absolute-maximum-rated conditions for extended periods may affect device reliability.

6.2 ESD Ratings

			VALUE	UNIT
$V_{(ESD)}$	Electrostatic discharge	Human body model (HBM), per ANSI/ESDA/JEDEC JS-001, all pins ⁽¹⁾	± 2000	V
		Charged device model (CDM), per JEDEC specification JESD22-C101, all pins ⁽²⁾	± 500	

- (1) JEDEC document JEP155 states that 500-V HBM allows safe manufacturing with a standard ESD control process.
 (2) JEDEC document JEP157 states that 250-V CDM allows safe manufacturing with a standard ESD control process.

6.3 Recommended Operating Conditions

over operating free-air temperature range (unless otherwise noted)

		MIN	NOM	MAX	UNIT
V_{IN}	Input voltage	2		5.5	V
V_{OUT}	Output voltage	0		5.5	V
I_{OUT}	Output current	0		1	A

6.4 Thermal Information

THERMAL METRIC ⁽¹⁾		TLV1117LV	UNIT
		DCY (SOT-223)	
		4 PINS	
$R_{\theta JA}$	Junction-to-ambient thermal resistance	62.9	$^\circ\text{C}/\text{W}$
$\theta_{JC(top)}$	Junction-to-case (top) thermal resistance	47.2	$^\circ\text{C}/\text{W}$
$R_{\theta JC(top)}$	Junction-to-board thermal resistance	12	$^\circ\text{C}/\text{W}$
Ψ_{JT}	Junction-to-top characterization parameter	6.1	$^\circ\text{C}/\text{W}$
Ψ_{JB}	Junction-to-board characterization parameter	11.9	$^\circ\text{C}/\text{W}$

- (1) For more information about traditional and new thermal metrics, see the [Semiconductor and IC Package Thermal Metrics application note](#).

6.5 Electrical Characteristics

at $V_{IN} = V_{OUT(nom)} + 1.5\text{ V}$; $I_{OUT} = 10\text{ mA}$, $C_{OUT} = 1.0\text{ }\mu\text{F}$, and $T_A = 25^\circ\text{C}$ (unless otherwise noted)

PARAMETER		TEST CONDITIONS		MIN	TYP	MAX	UNIT			
V_{IN}	Input voltage			2		5.5	V			
V_{OUT}	DC output accuracy	$V_{OUT} > 2\text{ V}$		-1.5%		1.5%				
		$1.5\text{ V} \leq V_{OUT} < 2\text{ V}$		-2%		2%				
		$1.2\text{ V} \leq V_{OUT} < 1.5\text{ V}$		-40		40	mV			
$\Delta V_{OUT(\Delta V_{IN})}$	Line regulation	$V_{OUT(nom)} + 0.5\text{ V} \leq V_{IN} \leq 5.5\text{ V}$, $I_{OUT} = 10\text{ mA}$			1	5	mV			
$\Delta V_{OUT(\Delta I_{OUT})}$	Load regulation	$0\text{ mA} \leq I_{OUT} \leq 1\text{ A}$			1	35	mV			
V_{DO}	Dropout voltage ⁽¹⁾	$V_{IN} = 0.98 \times V_{OUT(nom)}$	$V_{OUT} < 3.3\text{ V}$	$I_{OUT} = 200\text{ mA}$		115		mV		
				$I_{OUT} = 500\text{ mA}$		285				
				$I_{OUT} = 800\text{ mA}$		455				
				$I_{OUT} = 1\text{ A}$		570			800	
			$V_{OUT} \geq 3.3\text{ V}$	$I_{OUT} = 200\text{ mA}$		90				
				$I_{OUT} = 500\text{ mA}$		230				
				$I_{OUT} = 800\text{ mA}$		365				
				$I_{OUT} = 1\text{ A}$		455			700	
I_{CL}	Output current limit	$V_{OUT} = 0.9 \times V_{OUT(nom)}$		1.1		A				
I_Q	Quiescent current	$I_{OUT} = 0\text{ mA}$		50		100	μA			
PSRR	Power-supply rejection ratio	$V_{IN} = 3.3\text{ V}$, $V_{OUT} = 1.8\text{ V}$, $I_{OUT} = 500\text{ mA}$, $f = 100\text{ Hz}$		65		dB				
V_n	Output noise voltage	BW = 10 Hz to 100 kHz, $V_{IN} = 2.8\text{ V}$, $V_{OUT} = 1.8\text{ V}$, $I_{OUT} = 500\text{ mA}$		60		μV_{RMS}				
t_{STR}	Start-up time ⁽²⁾	$C_{OUT} = 1.0\text{ }\mu\text{F}$, $I_{OUT} = 1\text{ A}$		100		μs				
UVLO	Undervoltage lockout	V_{IN} rising		1.95		V				
T_{SD}	Thermal shutdown temperature	Shutdown, temperature increasing		165		°C				
		Reset, temperature decreasing		145						
T_J	Operating junction temperature			-40		125		°C		

(1) V_{DO} is measured for devices with $V_{OUT(nom)} = 2.5\text{ V}$ so that $V_{IN} = 2.45\text{ V}$.

(2) Start-up time = time from when V_{IN} asserts to when output is sustained at a value greater than or equal to $0.98 \times V_{OUT(nom)}$.

6.6 Typical Characteristics

at $V_{IN} = V_{OUT(nom)} + 1.5\text{ V}$, $I_{OUT} = 10\text{ mA}$, $C_{OUT} = 1.0\text{ }\mu\text{F}$, and $T_A = 25^\circ\text{C}$ (unless otherwise noted)

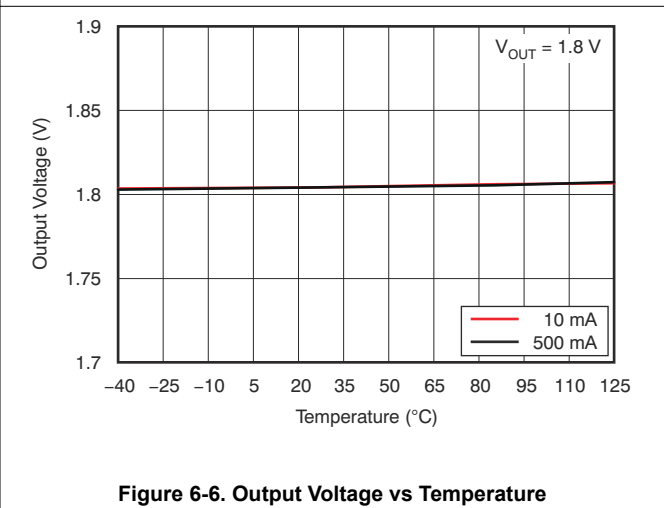
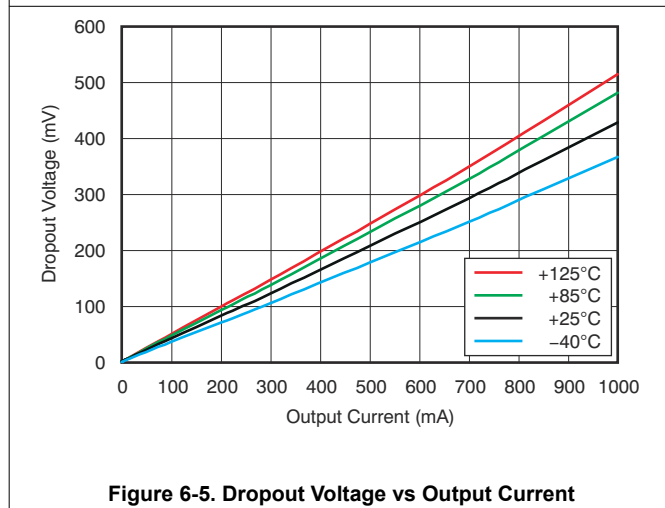
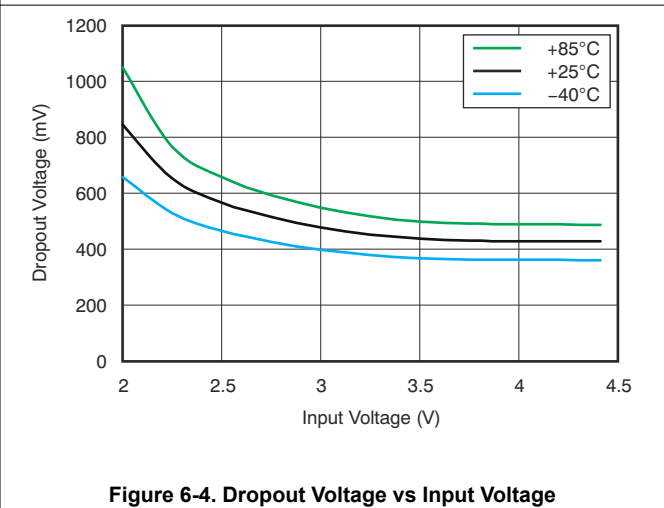
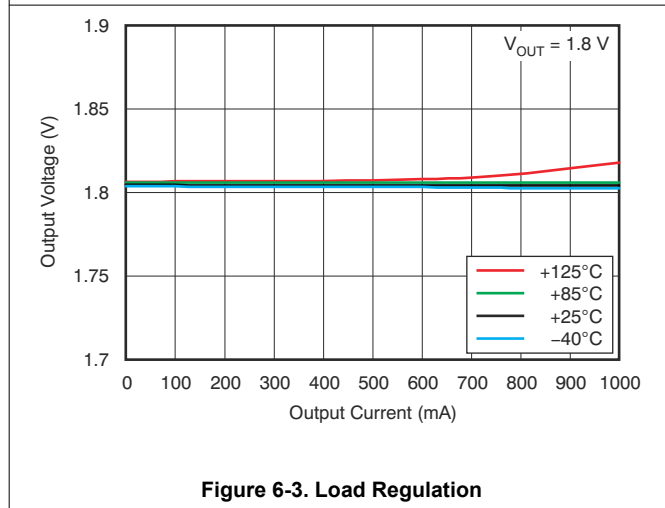
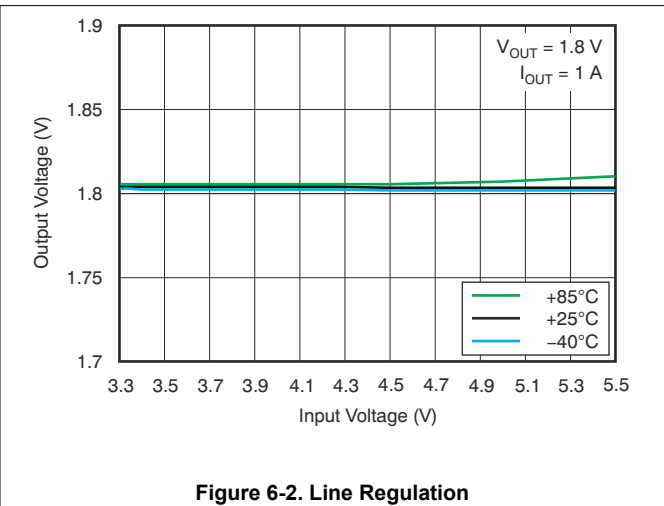
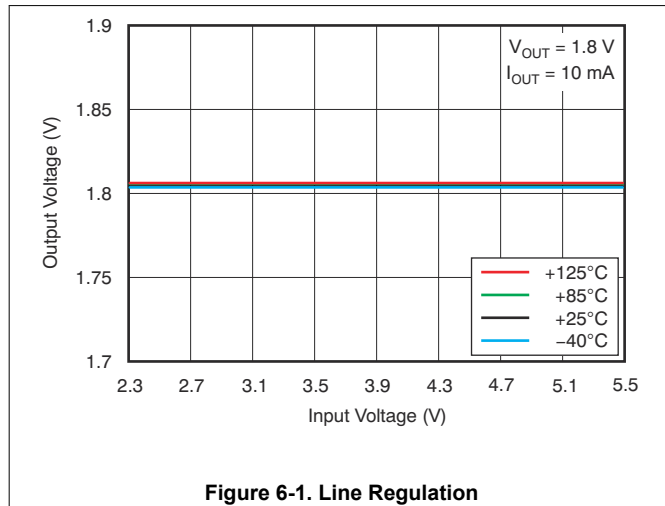

6.6 Typical Characteristics (continued)

at $V_{IN} = V_{OUT(nom)} + 1.5\text{ V}$, $I_{OUT} = 10\text{ mA}$, $C_{OUT} = 1.0\text{ }\mu\text{F}$, and $T_A = 25^\circ\text{C}$ (unless otherwise noted)

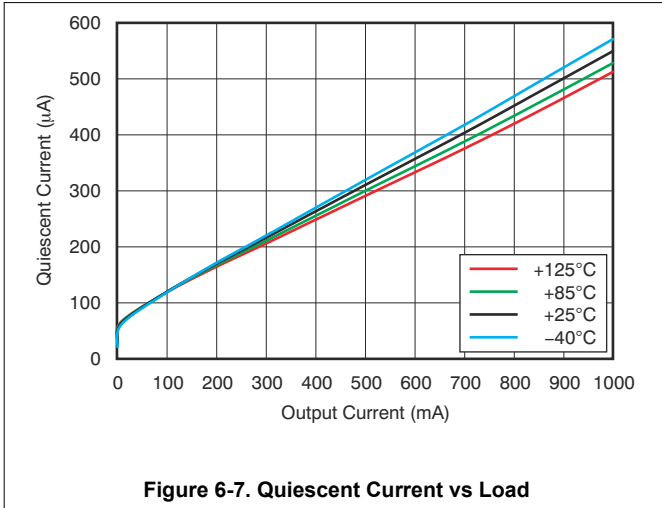

Figure 6-7. Quiescent Current vs Load

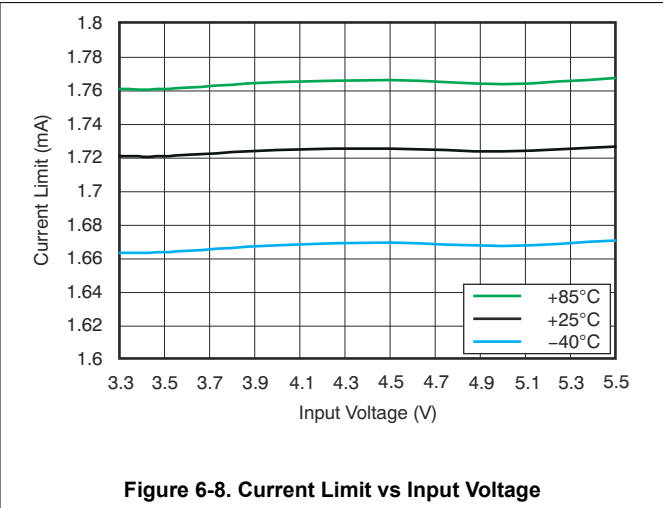

Figure 6-8. Current Limit vs Input Voltage

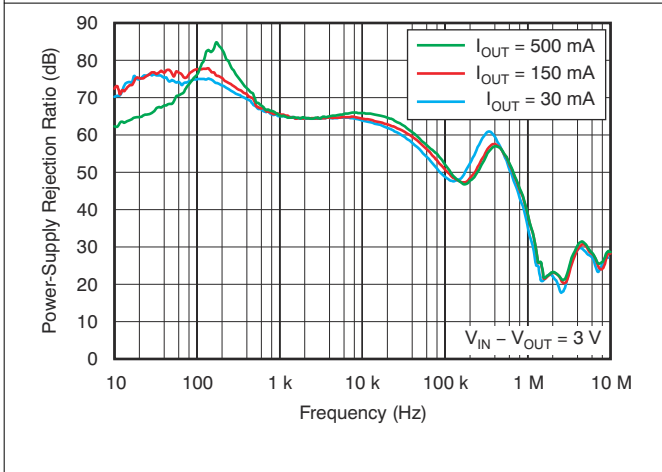

Figure 6-9. Power-Supply Rejection Ratio vs Frequency

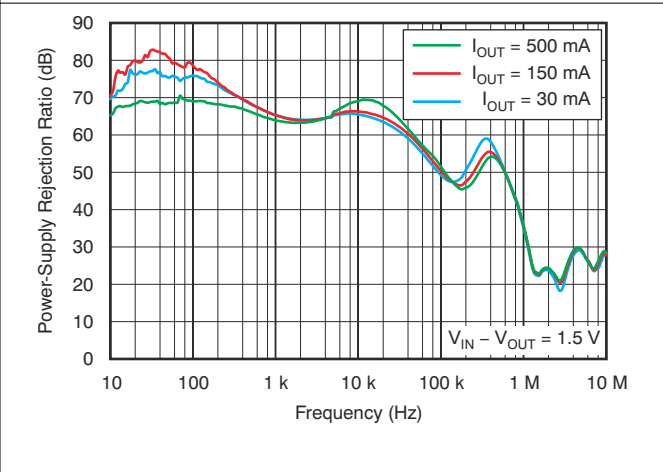

Figure 6-10. Power-Supply Rejection Ratio vs Frequency

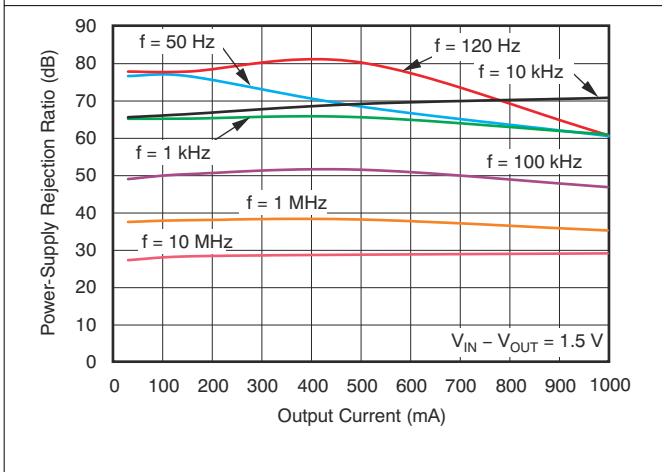

Figure 6-11. Power-Supply Rejection Ratio vs Output Current

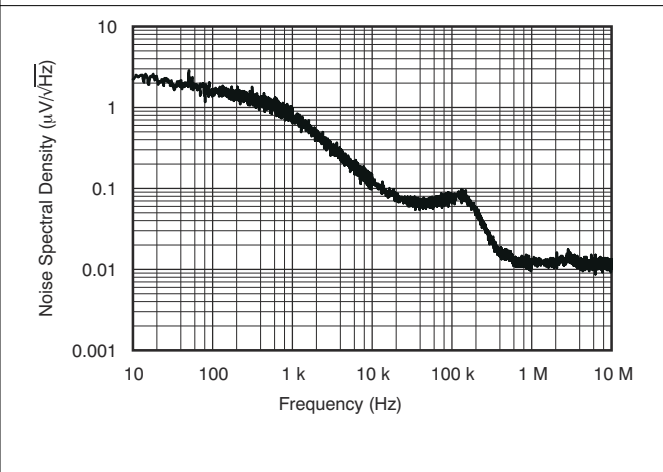
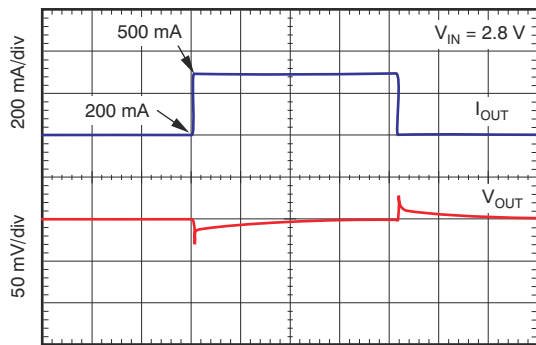

Figure 6-12. Spectral Noise Density vs Frequency

6.6 Typical Characteristics (continued)

at $V_{IN} = V_{OUT(nom)} + 1.5\text{ V}$, $I_{OUT} = 10\text{ mA}$, $C_{OUT} = 1.0\text{ }\mu\text{F}$, and $T_A = 25^\circ\text{C}$ (unless otherwise noted)



50 $\mu\text{s}/\text{div}$
 $C_{OUT} = 1\text{ }\mu\text{F}$

Figure 6-13. Load Transient Response 200 mA to 500 mA

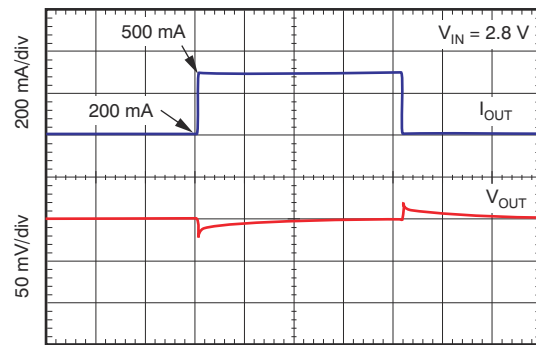

50 $\mu\text{s}/\text{div}$
 $C_{OUT} = 10\text{ }\mu\text{F}$

Figure 6-14. Load Transient Response 200 mA to 500 mA

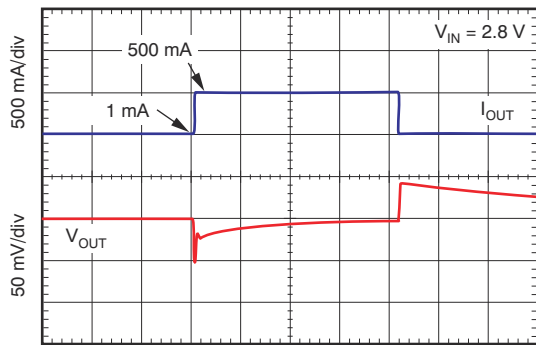

50 $\mu\text{s}/\text{div}$
 $C_{OUT} = 1\text{ }\mu\text{F}$

Figure 6-15. Load Transient Response 1 mA to 500 mA

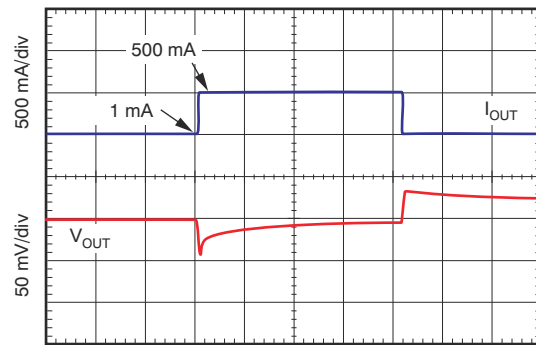

50 $\mu\text{s}/\text{div}$
 $C_{OUT} = 10\text{ }\mu\text{F}$

Figure 6-16. Load Transient Response 1 mA to 500 mA

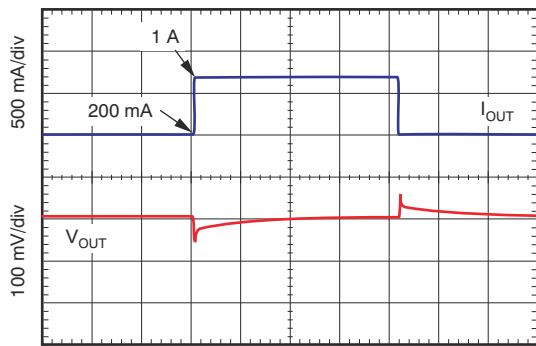

50 $\mu\text{s}/\text{div}$
 $C_{OUT} = 1\text{ }\mu\text{F}$

Figure 6-17. Load Transient Response 200 mA to 1 A

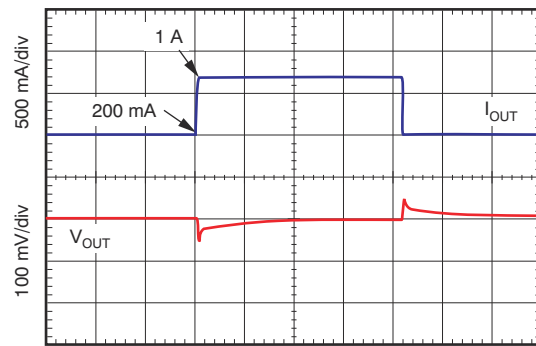

50 $\mu\text{s}/\text{div}$
 $C_{OUT} = 10\text{ }\mu\text{F}$

Figure 6-18. Load Transient Response 200 mA to 1 A

6.6 Typical Characteristics (continued)

at $V_{IN} = V_{OUT(nom)} + 1.5\text{ V}$, $I_{OUT} = 10\text{ mA}$, $C_{OUT} = 1.0\text{ }\mu\text{F}$, and $T_A = 25^\circ\text{C}$ (unless otherwise noted)

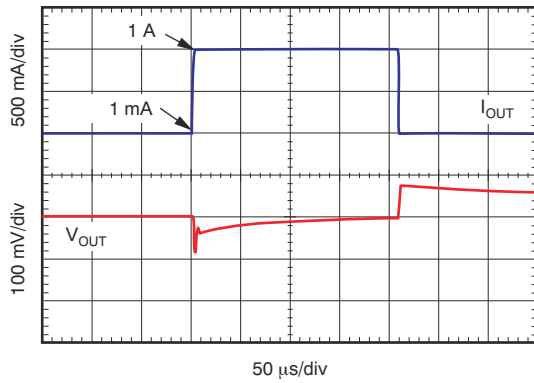

Figure 6-19. Load Transient Response 1 mA to 1 A

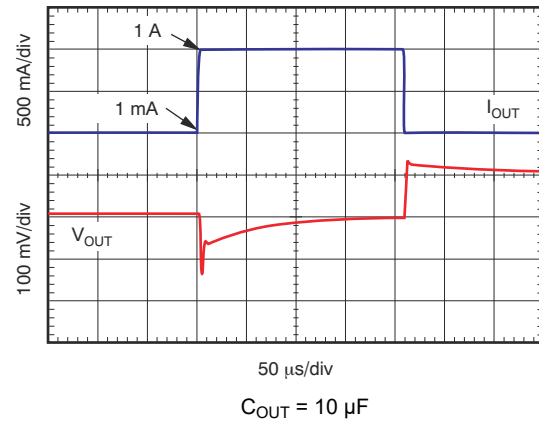

Figure 6-20. Load Transient Response 1 mA to 1 A

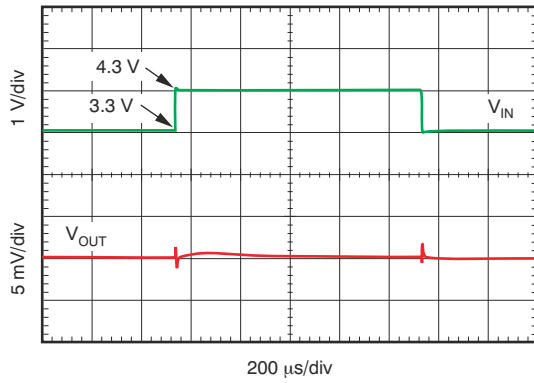

Figure 6-21. Line Transient Response

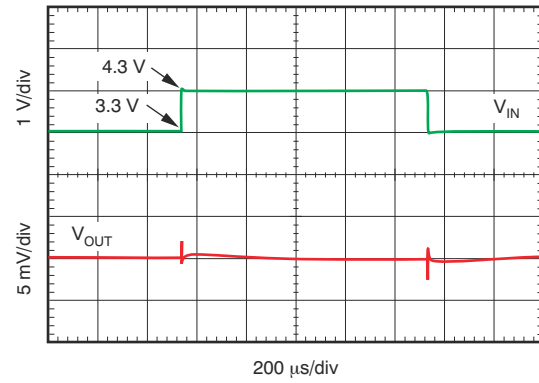

Figure 6-22. Line Transient Response

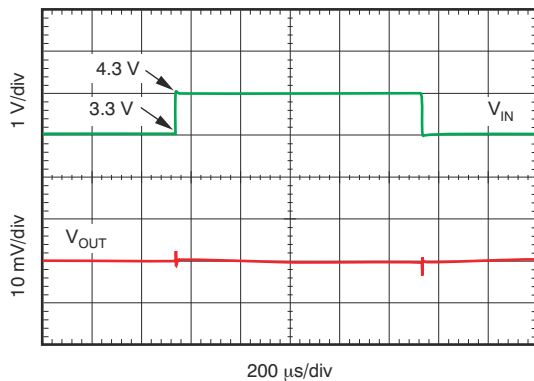

Figure 6-23. Line Transient Response

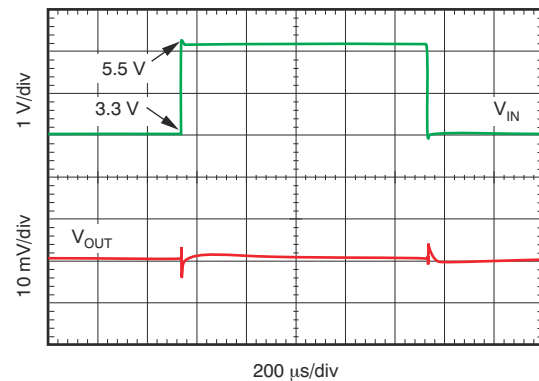
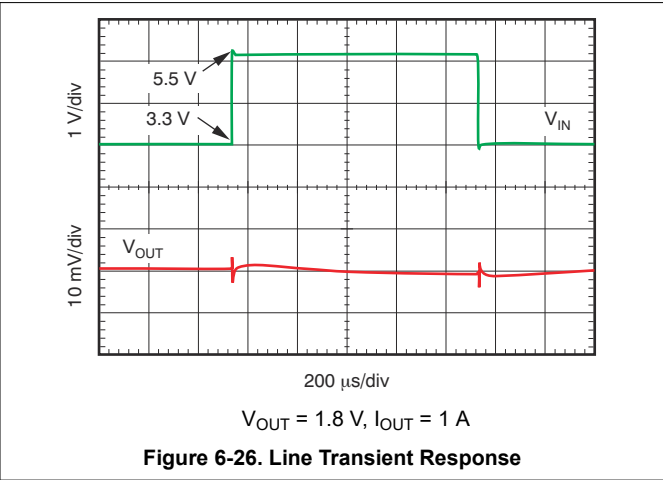
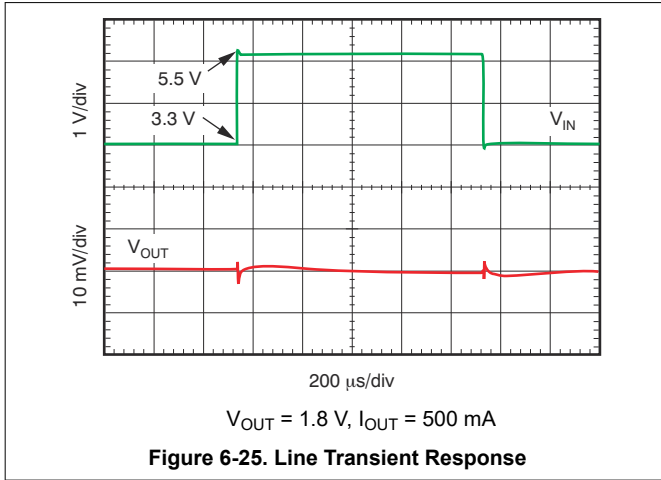

Figure 6-24. Line Transient Response

6.6 Typical Characteristics (continued)

at $V_{IN} = V_{OUT(nom)} + 1.5\text{ V}$, $I_{OUT} = 10\text{ mA}$, $C_{OUT} = 1.0\text{ }\mu\text{F}$, and $T_A = 25^\circ\text{C}$ (unless otherwise noted)



7 Detailed Description

7.1 Overview

The TLV1117LV is a low quiescent current, high PSRR LDO capable of handling up to 1 A of load current. This device features an integrated current limit, thermal shutdown, band-gap reference, and undervoltage lockout (UVLO) circuit blocks.

7.2 Functional Block Diagram

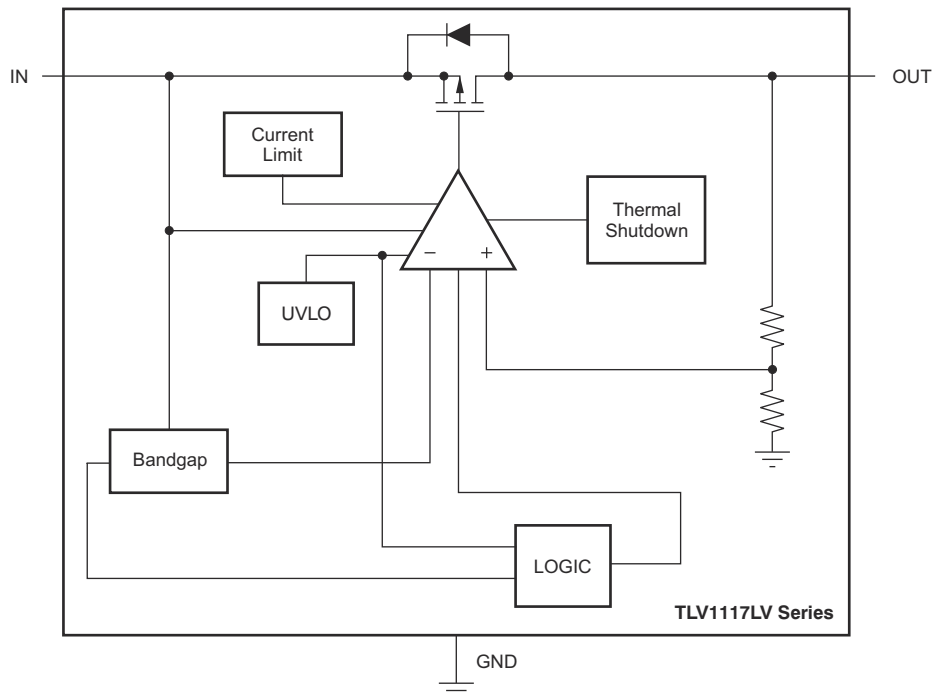

7.3 Feature Description

7.3.1 Internal Current Limit

The TLV1117LV internal current limit helps protect the regulator during fault conditions. During current limit, the output sources a fixed amount of current that is largely independent of the output voltage. In such a case, the output voltage is not regulated, and can be calculated by the formula: $V_{OUT} = I_{LIMIT} \times R_{LOAD}$. The PMOS pass transistor dissipates $(V_{IN} - V_{OUT}) \times I_{LIMIT}$ until thermal shutdown is triggered and the device turns off. When the device cools down, the internal thermal shutdown circuit turns the device back on. If the fault condition continues, the device cycles between current limit and thermal shutdown. See the [Thermal Protection](#) section for more details.

The PMOS pass transistor in the TLV1117LV has a built-in body diode that conducts current when the voltage at OUT exceeds the voltage at IN. This current is not limited; if extended reverse voltage operation is anticipated, external limiting to 5% of the rated output current is recommended.

7.3.2 Dropout Voltage

The TLV1117LV uses a PMOS pass transistor to achieve low dropout. When $(V_{IN} - V_{OUT})$ is less than the dropout voltage (V_{DO}), the PMOS pass transistor is in the linear region of operation and the input-to-output resistance is the $R_{DS(ON)}$ of the PMOS pass transistor. V_{DO} scales approximately with output current because the PMOS transistor behaves like a resistor in dropout.

As with any linear regulator, PSRR and transient response are degraded when $(V_{IN} - V_{OUT})$ approaches dropout.

7.3.3 Undervoltage Lockout

The TLV1117LV uses an undervoltage lockout (UVLO) circuit to keep the output shut off until internal circuitry is operating properly.

7.4 Device Functional Modes

7.4.1 Normal Operation

The device regulates to the nominal output voltage under the following conditions:

- The input voltage is greater than the nominal output voltage added to the dropout voltage
- The output current is less than the current limit
- The device die temperature is lower than the thermal shutdown temperature

7.4.2 Dropout Operation

If the input voltage is lower than the nominal output voltage plus the specified dropout voltage, but all other conditions are met for normal operation, the device operates in dropout mode. In this condition, the output voltage is the same the input voltage minus the dropout voltage. The transient performance of the device is significantly degraded because the pass transistor is in a triode state and no longer controls the current through the LDO. Line or load transients in dropout can result in large output voltage deviations.

Table 7-1 shows the conditions that lead to the different modes of operation.

Table 7-1. Device Functional Mode Comparison

OPERATING MODE	PARAMETER	
	V_{IN}	I_{OUT}
Normal mode	$V_{IN} > V_{OUT (nom)} + V_{DO}$	$I_{OUT} < I_{CL}$
Dropout mode	$V_{IN} < V_{OUT (nom)} + V_{DO}$	$I_{OUT} < I_{CL}$

8 Application and Implementation

Note

Information in the following applications sections is not part of the TI component specification, and TI does not warrant its accuracy or completeness. TI's customers are responsible for determining suitability of components for their purposes, as well as validating and testing their design implementation to confirm system functionality.

8.1 Application Information

The TLV1117LV is a low quiescent current linear regulator designed for high current applications. Unlike typical high current linear regulators, the TLV1117LV consumes significantly less quiescent current. This device delivers excellent line and load transient performance. The device is low noise, and exhibits a very good PSRR. As a result, this device is designed for high current applications that require very sensitive power-supply rails.

This regulators offer both current limit and thermal protection. The operating junction temperature range of the device is -40°C to $+125^{\circ}\text{C}$.

8.2 Typical Application

Figure 8-1 shows a typical application circuit.

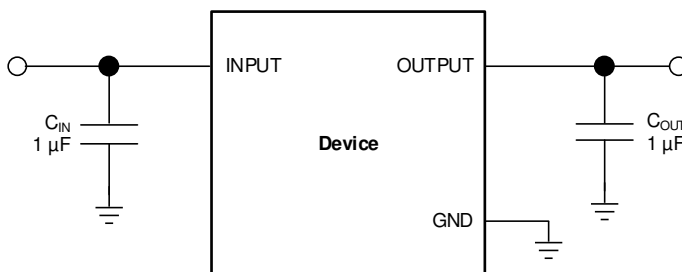

Figure 8-1. Typical Application Circuit

8.2.1 Design Requirements

For this design example, use the parameters listed in Table 8-1 as the input parameters.

Table 8-1. Design Parameters

PARAMETER	DESIGN REQUIREMENT
Input voltage	2.5 V to 3.3 V
Output voltage	1.8 V
Output current	500 mA

8.2.2 Detailed Design Procedure

8.2.2.1 Input and Output Capacitor Requirements

For stability, 1.0- μF ceramic capacitors are required at the output. Higher-valued capacitors improve transient performance. Use X5R- and X7R-type ceramic capacitors because these capacitors have minimal variation in value and equivalent series resistance (ESR) over temperature. Unlike traditional linear regulators that need a minimum ESR for stability, the TLV1117LV is specified to be stable with no ESR. Therefore, cost-effective ceramic capacitors can be used with this device. Effective output capacitance that takes bias, temperature, and aging effects into consideration must be greater than 0.5 μF to ensure stability of the device.

Although an input capacitor is not required for stability, good analog design practice is to connect a 0.1- μF to 1.0- μF , low-ESR capacitor across the IN pin and GND pin of the regulator. This capacitor counteracts reactive input sources and improves transient response, noise rejection, and ripple rejection. A higher-value capacitor can be necessary if large, fast rise-time load transients are anticipated, or if the device is not located physically

close to the power source. If source impedance is greater than $2\ \Omega$, a $0.1\text{-}\mu\text{F}$ input capacitor can also be necessary to ensure stability.

8.2.2.2 Transient Response

As with any regulator, increasing the size of the output capacitor reduces overshoot and undershoot magnitude.

8.2.3 Application Curves

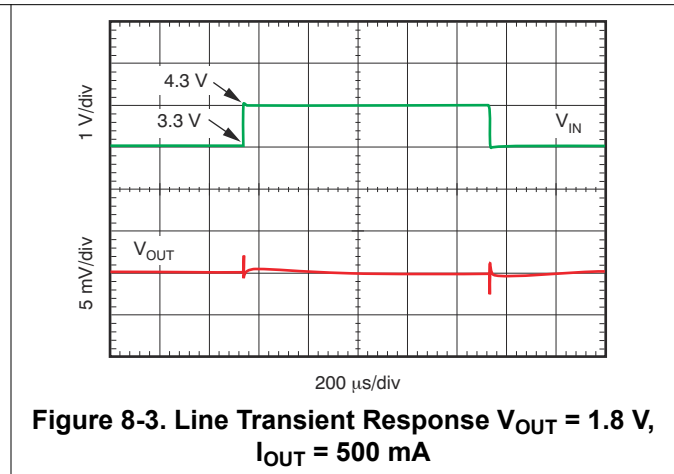
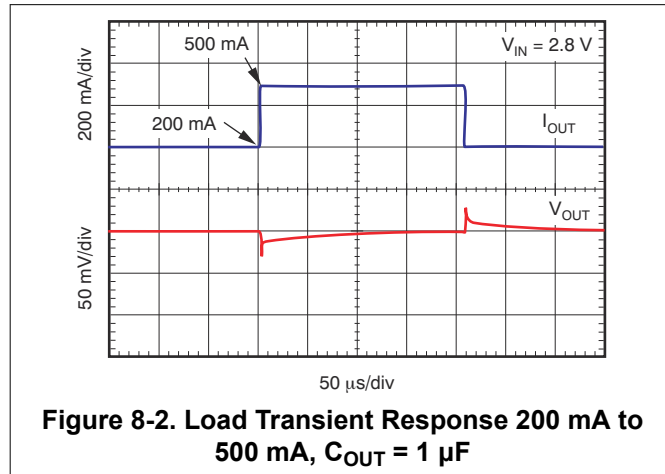

8.3 Best Design Practices

Place input and output capacitors as close to the device as possible.

Use a ceramic output capacitor.

Do not use an electrolytic output capacitor.

Do not exceed the device absolute maximum ratings.

8.4 Power Supply Recommendations

Connect a low output impedance power supply directly to the INPUT pin of the TLV1117LV. Inductive impedances between the input supply and the INPUT pin can create significant voltage excursions at the INPUT pin during start-up or load transient events.

8.5 Layout

8.5.1 Layout Guidelines

Place input and output capacitors as close to the device pins as possible. To improve characteristic AC performance (such as PSRR, output noise, and transient response), design the board with separate ground planes for V_{IN} and V_{OUT} , with the ground plane connected only at the GND pin of the device. In addition, the ground connection for the output capacitor must be connected directly to the GND pin of the device. Higher value ESR capacitors can degrade PSRR performance.

8.5.1.1 Thermal Protection

Thermal protection disables the output when the junction temperature rises to approximately 165°C , allowing the device to cool. When the junction temperature cools to approximately 145°C , the output circuitry is again enabled. Depending on power dissipation, thermal resistance, and ambient temperature, the thermal protection circuit can cycle on and off. This cycling limits the dissipation of the regulator, protecting the regulator from damage as a result of overheating.

Any tendency to activate the thermal protection circuit indicates excessive power dissipation or an inadequate heat sink. For reliable operation, limit junction temperature to 125°C maximum. To estimate the margin of safety in a complete design (including heat sink), increase the ambient temperature until the thermal protection is triggered; use worst-case loads and signal conditions.

The internal protection circuitry of the TLV1117LV is designed to protect against overload conditions. This circuitry is not intended to replace proper heat sinking. Continuously running the TLV1117LV into thermal shutdown degrades device reliability.

8.5.1.2 Power Dissipation

The ability to remove heat from the die is different for each package type, presenting different considerations in the printed circuit board (PCB) layout. The PCB area around the device that is free of other components moves the heat from the device to the ambient air. Performance data for JEDEC low and high-K boards are given in the [Thermal Information](#) table. Using heavier copper increases the effectiveness in removing heat from the device. The addition of plated through-holes to heat-dissipating layers also improves heat-sink effectiveness.

Power dissipation depends on input voltage and load conditions. Power dissipation (P_D) is equal to the product of the output current and the voltage drop across the output pass element, as shown in [Equation 1](#):

$$P_D = (V_{IN} - V_{OUT}) I_{OUT} \quad (1)$$

8.5.2 Layout Example

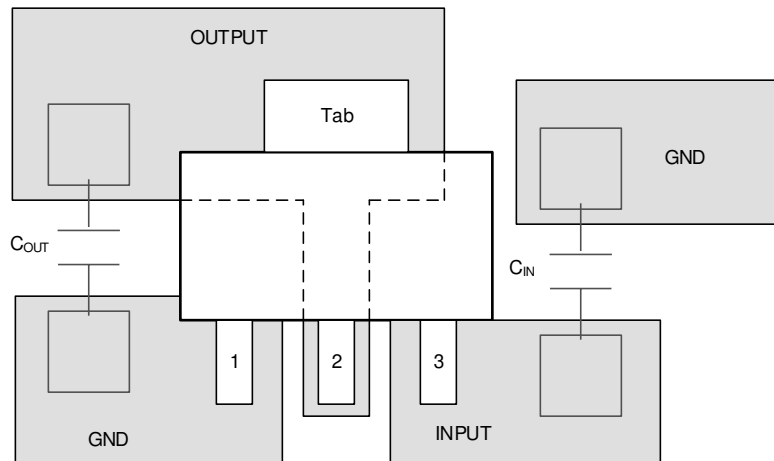

Figure 8-4. Layout Example

9 Device and Documentation Support

9.1 Device Support

9.1.1 Development Support

9.1.1.1 Evaluation Module

An evaluation module (EVM) is available to assist in the initial circuit performance evaluation using the TLV1117LV. The [TLV1117LV33EVM-714 evaluation module](#) (and [related user's guide](#)) can be requested at the TI website through the product folders or purchased directly from [the TI eStore](#).

9.1.1.2 Spice Models

Computer simulation of circuit performance using SPICE is often useful when analyzing the performance of analog circuits and systems. A SPICE model for the TLV1117LV is available through the product folders under *Tools & Software*.

9.1.2 Device Nomenclature

Table 9-1. Available Options⁽¹⁾

PRODUCT	V _{OUT}
TLV1117LVxxyyyz	xx is the nominal output voltage (for example 33 = 3.3 V). yyy is the package designator. z is the package quantity.

(1) For the most current package and ordering information, see the Package Option Addendum at the end of this document, or visit the device product folder at [www.ti.com](#).

9.2 Documentation Support

9.2.1 Related Documentation

For related documentation see the following:

- Texas Instruments, [TLV1117LVxxEVM-714 Evaluation Module user's guide](#)

9.3 Receiving Notification of Documentation Updates

To receive notification of documentation updates, navigate to the device product folder on [ti.com](#). Click on *Subscribe to updates* to register and receive a weekly digest of any product information that has changed. For change details, review the revision history included in any revised document.

9.4 Support Resources

[TI E2E™ support forums](#) are an engineer's go-to source for fast, verified answers and design help — straight from the experts. Search existing answers or ask your own question to get the quick design help you need.

Linked content is provided "AS IS" by the respective contributors. They do not constitute TI specifications and do not necessarily reflect TI's views; see TI's [Terms of Use](#).

9.5 Trademarks

TI E2E™ is a trademark of Texas Instruments.

All trademarks are the property of their respective owners.

9.6 Electrostatic Discharge Caution



This integrated circuit can be damaged by ESD. Texas Instruments recommends that all integrated circuits be handled with appropriate precautions. Failure to observe proper handling and installation procedures can cause damage.

ESD damage can range from subtle performance degradation to complete device failure. Precision integrated circuits may be more susceptible to damage because very small parametric changes could cause the device not to meet its published specifications.

9.7 Glossary

TI Glossary

This glossary lists and explains terms, acronyms, and definitions.

10 Mechanical, Packaging, and Orderable Information

The following pages include mechanical, packaging, and orderable information. This information is the most current data available for the designated devices. This data is subject to change without notice and revision of this document. For browser-based versions of this data sheet, refer to the left-hand navigation.

PACKAGING INFORMATION

Orderable part number	Status (1)	Material type (2)	Package Pins	Package qty Carrier	RoHS (3)	Lead finish/ Ball material (4)	MSL rating/ Peak reflow (5)	Op temp (°C)	Part marking (6)
TLV1117LV12DCYR	NRND	Production	SOT-223 (DCY) 4	2500 LARGE T&R	Yes	SN	Level-1-260C-UNLIM	-40 to 125	SI
TLV1117LV12DCYR.B	NRND	Production	SOT-223 (DCY) 4	2500 LARGE T&R	Yes	SN	Level-1-260C-UNLIM	-40 to 125	SI
TLV1117LV15DCYR	Active	Production	SOT-223 (DCY) 4	2500 LARGE T&R	Yes	SN	Level-1-260C-UNLIM	-40 to 125	VR
TLV1117LV15DCYR.B	Active	Production	SOT-223 (DCY) 4	2500 LARGE T&R	Yes	SN	Level-1-260C-UNLIM	-40 to 125	VR
TLV1117LV15DCYT	Obsolete	Production	SOT-223 (DCY) 4	-	-	Call TI	Call TI	-40 to 125	VR
TLV1117LV18DCYR	Active	Production	SOT-223 (DCY) 4	2500 LARGE T&R	Yes	SN	Level-1-260C-UNLIM	-40 to 125	SH
TLV1117LV18DCYR.B	Active	Production	SOT-223 (DCY) 4	2500 LARGE T&R	Yes	SN	Level-1-260C-UNLIM	-40 to 125	SH
TLV1117LV18DCYT	Active	Production	SOT-223 (DCY) 4	250 SMALL T&R	Yes	SN	Level-1-260C-UNLIM	-40 to 125	SH
TLV1117LV18DCYT.B	Active	Production	SOT-223 (DCY) 4	250 SMALL T&R	Yes	SN	Level-1-260C-UNLIM	-40 to 125	SH
TLV1117LV25DCYR	Active	Production	SOT-223 (DCY) 4	2500 LARGE T&R	Yes	SN	Level-1-260C-UNLIM	-40 to 125	VS
TLV1117LV25DCYR.B	Active	Production	SOT-223 (DCY) 4	2500 LARGE T&R	Yes	SN	Level-1-260C-UNLIM	-40 to 125	VS
TLV1117LV25DCYT	Active	Production	SOT-223 (DCY) 4	250 SMALL T&R	Yes	SN	Level-1-260C-UNLIM	-40 to 125	VS
TLV1117LV25DCYT.B	Active	Production	SOT-223 (DCY) 4	250 SMALL T&R	Yes	SN	Level-1-260C-UNLIM	-40 to 125	VS
TLV1117LV28DCYR	Active	Production	SOT-223 (DCY) 4	2500 LARGE T&R	Yes	SN	Level-1-260C-UNLIM	-40 to 125	VT
TLV1117LV28DCYR.B	Active	Production	SOT-223 (DCY) 4	2500 LARGE T&R	Yes	SN	Level-1-260C-UNLIM	-40 to 125	VT
TLV1117LV28DCYT	Obsolete	Production	SOT-223 (DCY) 4	-	-	Call TI	Call TI	-40 to 125	VT
TLV1117LV30DCYR	Active	Production	SOT-223 (DCY) 4	2500 LARGE T&R	Yes	SN	Level-1-260C-UNLIM	-40 to 125	VU
TLV1117LV30DCYR.B	Active	Production	SOT-223 (DCY) 4	2500 LARGE T&R	Yes	SN	Level-1-260C-UNLIM	-40 to 125	VU
TLV1117LV30DCYT	Obsolete	Production	SOT-223 (DCY) 4	-	-	Call TI	Call TI	-40 to 125	VU
TLV1117LV33DCYR	Active	Production	SOT-223 (DCY) 4	2500 LARGE T&R	Yes	SN	Level-1-260C-UNLIM	-40 to 125	TJ
TLV1117LV33DCYR.A	Active	Production	SOT-223 (DCY) 4	2500 LARGE T&R	Yes	SN	Level-1-260C-UNLIM	-40 to 125	TJ
TLV1117LV33DCYR.B	Active	Production	SOT-223 (DCY) 4	2500 LARGE T&R	Yes	SN	Level-1-260C-UNLIM	-40 to 125	TJ
TLV1117LV33DCYT	Obsolete	Production	SOT-223 (DCY) 4	-	-	SN	Level-1-260C-UNLIM	-40 to 125	TJ

(1) **Status:** For more details on status, see our [product life cycle](#).

(2) **Material type:** When designated, preproduction parts are prototypes/experimental devices, and are not yet approved or released for full production. Testing and final process, including without limitation quality assurance, reliability performance testing, and/or process qualification, may not yet be complete, and this item is subject to further changes or possible discontinuation. If available for ordering, purchases will be subject to an additional waiver at checkout, and are intended for early internal evaluation purposes only. These items are sold without warranties of any kind.

(3) **RoHS values:** Yes, No, RoHS Exempt. See the [TI RoHS Statement](#) for additional information and value definition.

(4) **Lead finish/Ball material:** Parts may have multiple material finish options. Finish options are separated by a vertical ruled line. Lead finish/Ball material values may wrap to two lines if the finish value exceeds the maximum column width.

(5) **MSL rating/Peak reflow:** The moisture sensitivity level ratings and peak solder (reflow) temperatures. In the event that a part has multiple moisture sensitivity ratings, only the lowest level per JEDEC standards is shown. Refer to the shipping label for the actual reflow temperature that will be used to mount the part to the printed circuit board.

(6) **Part marking:** There may be an additional marking, which relates to the logo, the lot trace code information, or the environmental category of the part.

Multiple part markings will be inside parentheses. Only one part marking contained in parentheses and separated by a "~" will appear on a part. If a line is indented then it is a continuation of the previous line and the two combined represent the entire part marking for that device.

Important Information and Disclaimer: The information provided on this page represents TI's knowledge and belief as of the date that it is provided. TI bases its knowledge and belief on information provided by third parties, and makes no representation or warranty as to the accuracy of such information. Efforts are underway to better integrate information from third parties. TI has taken and continues to take reasonable steps to provide representative and accurate information but may not have conducted destructive testing or chemical analysis on incoming materials and chemicals. TI and TI suppliers consider certain information to be proprietary, and thus CAS numbers and other limited information may not be available for release.

In no event shall TI's liability arising out of such information exceed the total purchase price of the TI part(s) at issue in this document sold by TI to Customer on an annual basis.

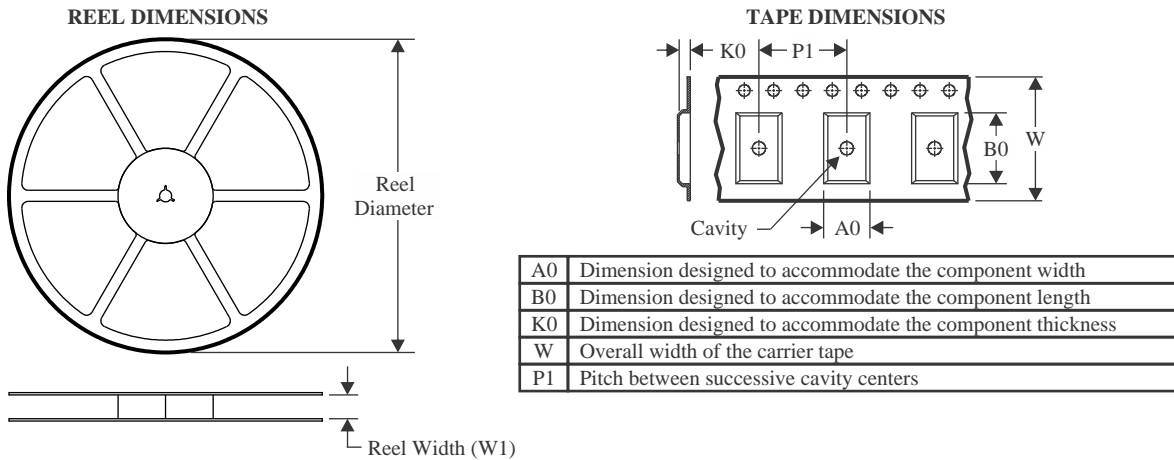
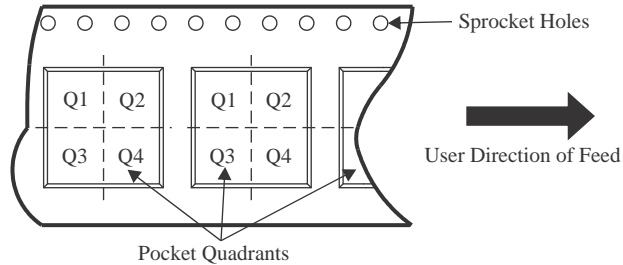
TAPE AND REEL INFORMATION

QUADRANT ASSIGNMENTS FOR PIN 1 ORIENTATION IN TAPE

*All dimensions are nominal

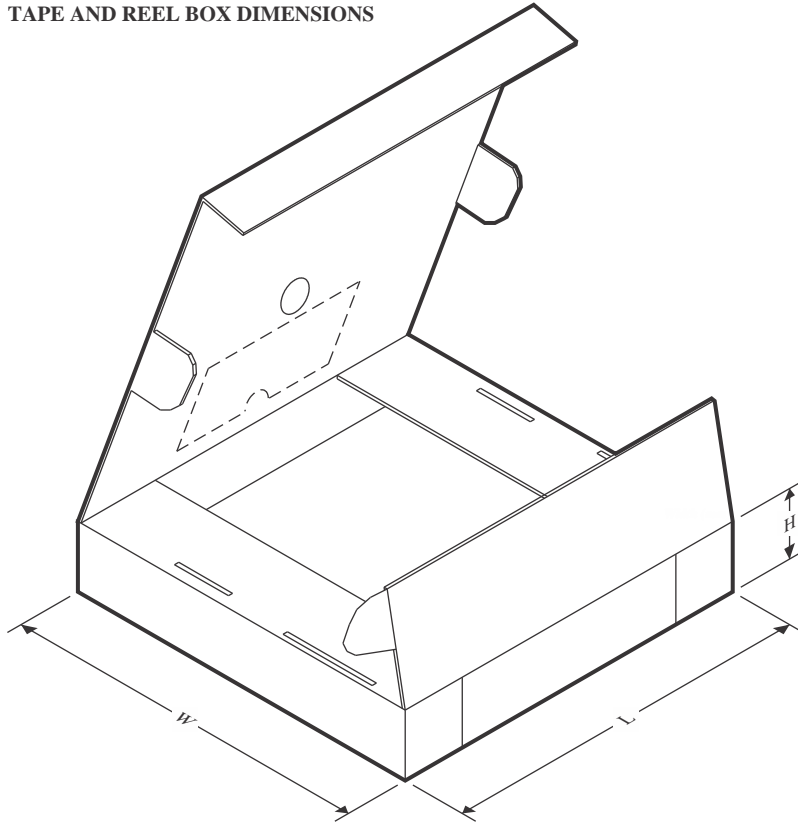
Device	Package Type	Package Drawing	Pins	SPQ	Reel Diameter (mm)	Reel Width W1 (mm)	A0 (mm)	B0 (mm)	K0 (mm)	P1 (mm)	W (mm)	Pin1 Quadrant
TLV1117LV12DCYR	SOT-223	DCY	4	2500	330.0	12.4	7.05	7.4	1.9	8.0	12.0	Q3
TLV1117LV15DCYR	SOT-223	DCY	4	2500	330.0	12.4	7.05	7.4	1.9	8.0	12.0	Q3
TLV1117LV18DCYR	SOT-223	DCY	4	2500	330.0	12.4	7.05	7.4	1.9	8.0	12.0	Q3
TLV1117LV18DCYT	SOT-223	DCY	4	250	180.0	12.4	7.05	7.4	1.9	8.0	12.0	Q3
TLV1117LV25DCYR	SOT-223	DCY	4	2500	330.0	12.4	7.05	7.4	1.9	8.0	12.0	Q3
TLV1117LV25DCYT	SOT-223	DCY	4	250	180.0	12.4	7.05	7.4	1.9	8.0	12.0	Q3
TLV1117LV28DCYR	SOT-223	DCY	4	2500	330.0	12.4	7.05	7.4	1.9	8.0	12.0	Q3
TLV1117LV30DCYR	SOT-223	DCY	4	2500	330.0	12.4	7.05	7.4	1.9	8.0	12.0	Q3
TLV1117LV33DCYR	SOT-223	DCY	4	2500	330.0	12.4	7.05	7.4	1.9	8.0	12.0	Q3
TLV1117LV33DCYT	SOT-223	DCY	4	0	330.0	12.4	7.05	7.4	1.9	8.0	12.0	Q3

TAPE AND REEL BOX DIMENSIONS

*All dimensions are nominal

Device	Package Type	Package Drawing	Pins	SPQ	Length (mm)	Width (mm)	Height (mm)
TLV1117LV12DCYR	SOT-223	DCY	4	2500	340.0	340.0	38.0
TLV1117LV15DCYR	SOT-223	DCY	4	2500	340.0	340.0	38.0
TLV1117LV18DCYR	SOT-223	DCY	4	2500	340.0	340.0	38.0
TLV1117LV18DCYT	SOT-223	DCY	4	250	340.0	340.0	38.0
TLV1117LV25DCYR	SOT-223	DCY	4	2500	340.0	340.0	38.0
TLV1117LV25DCYT	SOT-223	DCY	4	250	340.0	340.0	38.0
TLV1117LV28DCYR	SOT-223	DCY	4	2500	340.0	340.0	38.0
TLV1117LV30DCYR	SOT-223	DCY	4	2500	340.0	340.0	38.0
TLV1117LV33DCYR	SOT-223	DCY	4	2500	340.0	340.0	38.0
TLV1117LV33DCYT	SOT-223	DCY	4	0	340.0	340.0	38.0

DCY (R-PDSO-G4)

PLASTIC SMALL-OUTLINE

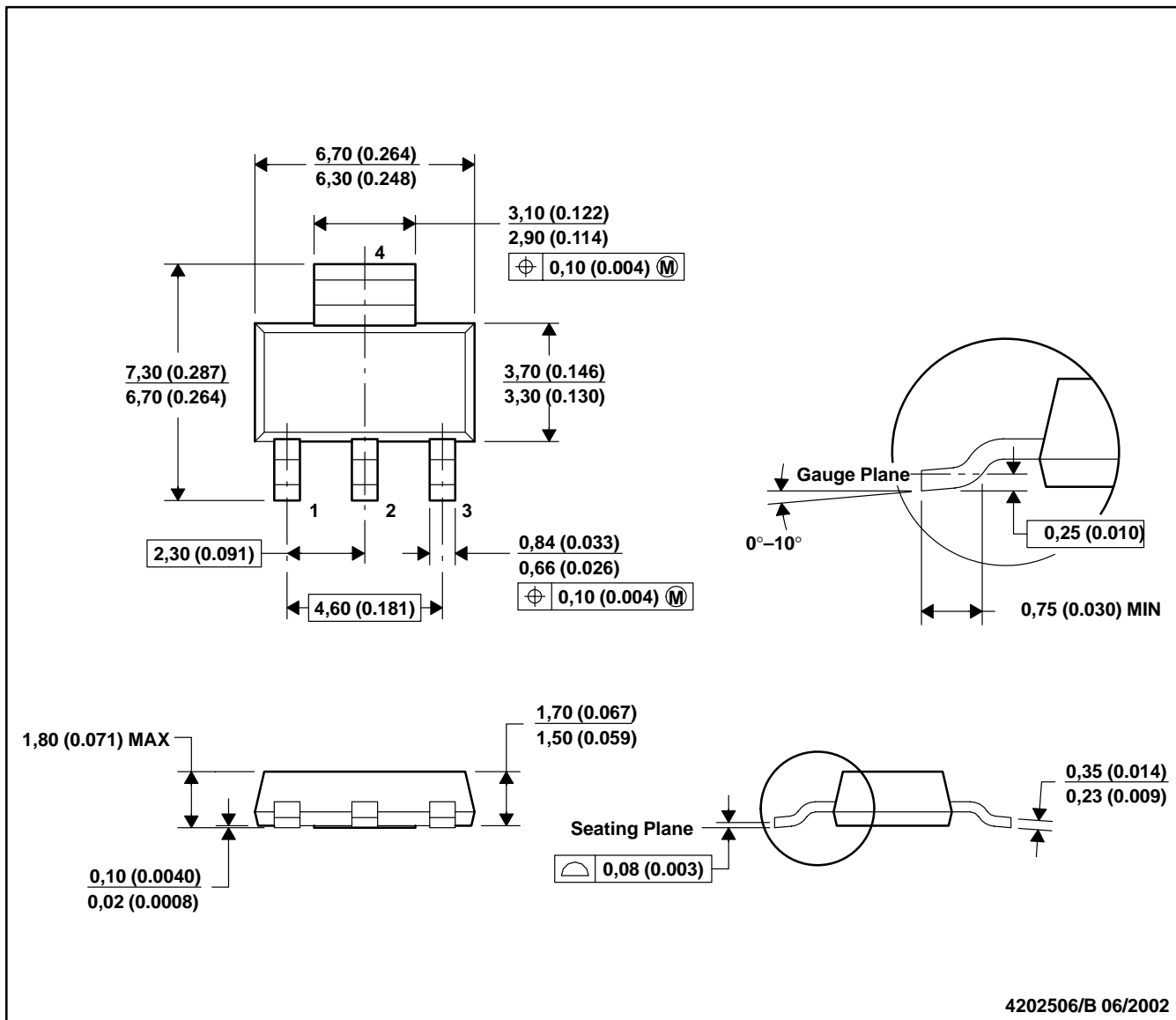

- NOTES: A. All linear dimensions are in millimeters (inches).
 B. This drawing is subject to change without notice.
 C. Body dimensions do not include mold flash or protrusion.
 D. Falls within JEDEC TO-261 Variation AA.

DCY (R-PDSO-G4)

PLASTIC SMALL OUTLINE

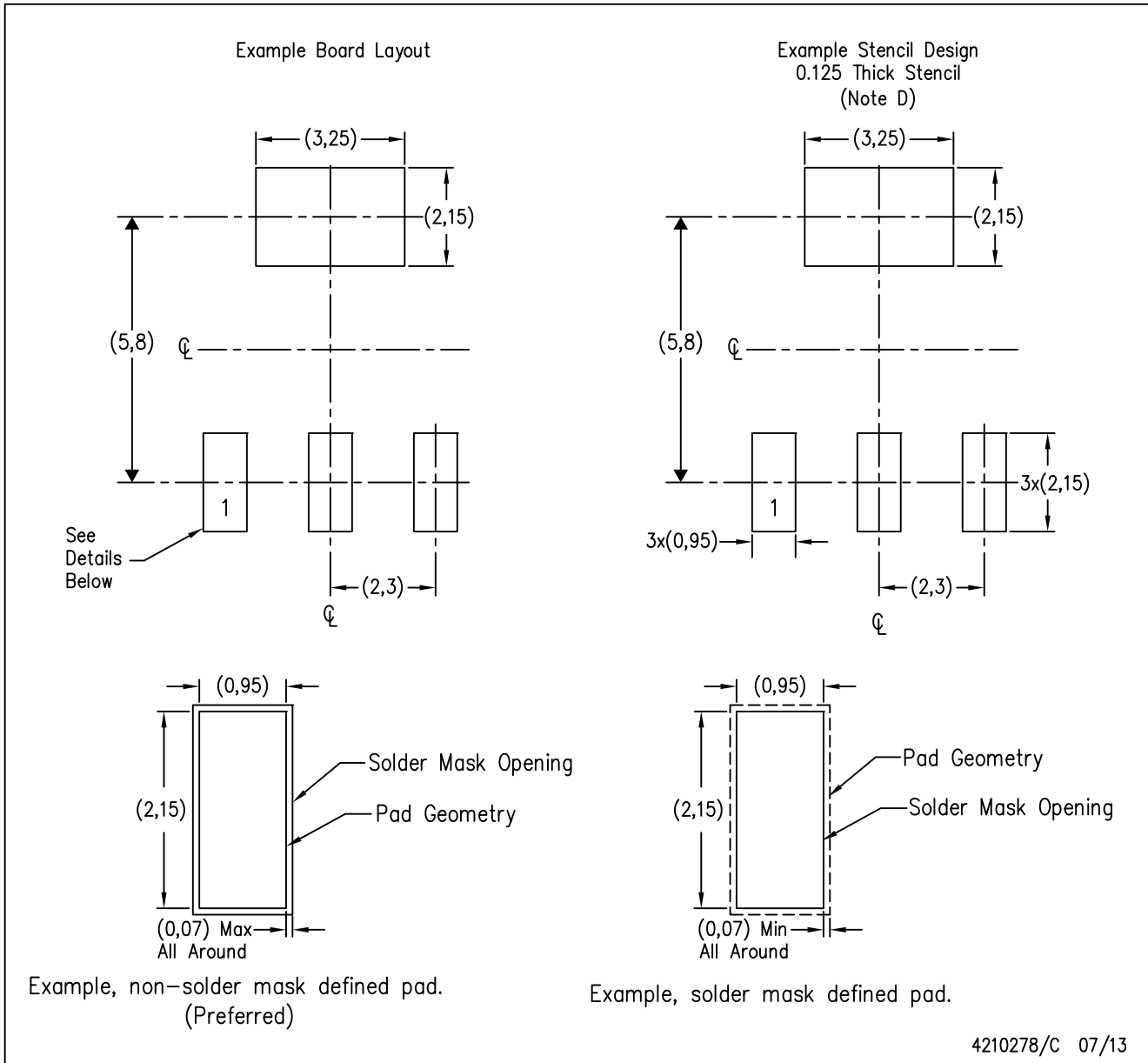

- NOTES:
- A. All linear dimensions are in millimeters.
 - B. This drawing is subject to change without notice.
 - C. Publication IPC-7351 is recommended for alternate designs.
 - D. Laser cutting apertures with trapezoidal walls and also rounding corners will offer better paste release. Customers should contact their board assembly site for stencil recommendations. Refer to IPC 7525 for stencil design considerations.

IMPORTANT NOTICE AND DISCLAIMER

TI PROVIDES TECHNICAL AND RELIABILITY DATA (INCLUDING DATASHEETS), DESIGN RESOURCES (INCLUDING REFERENCE DESIGNS), APPLICATION OR OTHER DESIGN ADVICE, WEB TOOLS, SAFETY INFORMATION, AND OTHER RESOURCES "AS IS" AND WITH ALL FAULTS, AND DISCLAIMS ALL WARRANTIES, EXPRESS AND IMPLIED, INCLUDING WITHOUT LIMITATION ANY IMPLIED WARRANTIES OF MERCHANTABILITY, FITNESS FOR A PARTICULAR PURPOSE OR NON-INFRINGEMENT OF THIRD PARTY INTELLECTUAL PROPERTY RIGHTS.

These resources are intended for skilled developers designing with TI products. You are solely responsible for (1) selecting the appropriate TI products for your application, (2) designing, validating and testing your application, and (3) ensuring your application meets applicable standards, and any other safety, security, regulatory or other requirements.

These resources are subject to change without notice. TI grants you permission to use these resources only for development of an application that uses the TI products described in the resource. Other reproduction and display of these resources is prohibited. No license is granted to any other TI intellectual property right or to any third party intellectual property right. TI disclaims responsibility for, and you fully indemnify TI and its representatives against any claims, damages, costs, losses, and liabilities arising out of your use of these resources.

TI's products are provided subject to [TI's Terms of Sale](#), [TI's General Quality Guidelines](#), or other applicable terms available either on ti.com or provided in conjunction with such TI products. TI's provision of these resources does not expand or otherwise alter TI's applicable warranties or warranty disclaimers for TI products. Unless TI explicitly designates a product as custom or customer-specified, TI products are standard, catalog, general purpose devices.

TI objects to and rejects any additional or different terms you may propose.

Copyright © 2026, Texas Instruments Incorporated

Last updated 10/2025