

TDES4940 4K V³Link Enhanced Video to Embedded DisplayPort Bridge Deserializer

1 Features

- DisplayPort (DP) / Embedded DisplayPort (eDP) Transmitter
 - VESA DP v1.4a/eDP v1.4b transmitter
 - HBR3/HBR2/HBR/RBR Link Bit Rates
 - Main link: 1, 2, or 4 lanes
 - Each lane up to 8.1Gbps
 - AUX CH 1Mbps
 - Hot Plug Detect (HPD)
 - Extracts aggregated video streams to local eDP display
 - Designed for 4 K @ 60 Hz video resolution
 - Stream synchronization and splitting
- V³Link enhanced video interface
 - 13.5/12.528/10.8/6.75/3.375 Gbps per Channel; Up to 27 Gbps over dual channels
 - Coax/STP interconnect support
 - Selectable 1, 2 channels
 - Daisy-chain and splitting
 - Adaptive equalization
- Ultra-low latency control channel
 - Two fast-mode plus I2C up to 1 MHz (up to 3.4 MHz local bus access)
 - High-speed GPIOs
 - Supports SPI and UART pass through GPIOs
- Compatibility
 - Integrated HDCP v1.4 with on-chip keys
 - V³Link video and V³Link enhanced video product families
- Image enhancement (white balance and dithering)
- Security and diagnostics
 - Voltage and temperature monitoring
 - BIST and pattern generation
 - CRC and error diagnostics
 - ECC on control bits
 - Unique ID for counterfeit protection
- Advanced link robustness and EMC control
 - Spread spectrum clocking generation (SSCG)
 - Adaptive Receiver Equalization (AEQ)

- Low power operation
 - 1.8V and 1.15V dual power supply
- Qualifications
 - ISO 10605 and IEC 61000-4-2 ESD compliant
 - Temperature: -20°C to +85°C

2 Applications

- High resolution display:
 - Operating room displays
 - Seat back entertainment displays
 - High resolution HMI

3 Description

The TDES4940 is a V³Link Enhanced Video to DisplayPort (DP) / Embedded DisplayPort (eDP) bridge device. In conjunction with a V³Link Enhanced Video serializer, the chipset receives a high-speed serialized interface over low-cost 50 Ω coax or STP/STQ cables. The TDES4940 is a VESA DP v1.4a/eDP v1.4b compatible device that supports advanced features such as HBR3, and SuperFrame formats. The device supports video resolutions of 4K 30-bit color and higher. The V³Link Enhanced Video supports video and audio data transmission and full duplex control, including I2C, and GPIO data over the same link. Consolidation of video data and control over V³Link Enhanced Video lanes reduces the interconnect size and weight and simplifies system design. EMI is minimized by the use of low voltage differential signaling, data scrambling, and randomization. In compatible V³Link mode, the device supports up to 2K resolutions with 24-bit color depth over a single/dual link as well as HDCP v1.4 support when paired with an HDCP capable serializer.

Device Information

PART NUMBER	PACKAGE (1)	BODY SIZE (NOM)
TDES4940	VQFN (88)	12 mm × 12 mm

(1) For all available packages, see the orderable addendum at the end of the data sheet.

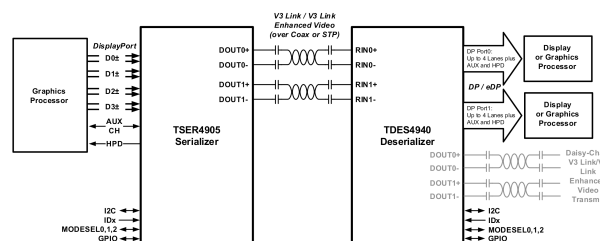

4 Device and Documentation Support

4.1 Documentation Support

4.1.1 Related Documentation

For related documentation see the following:

- *Soldering Specifications Application Report*, [SNOA549](#)
- *IC Package Thermal Metrics Application Report*, [SPRA953](#)
- *Leadless Leadframe Package (LLP) Application Report*, [SNOA401](#)

4.2 Support Resources

[TI E2E™ support forums](#) are an engineer's go-to source for fast, verified answers and design help — straight from the experts. Search existing answers or ask your own question to get the quick design help you need.

Linked content is provided "AS IS" by the respective contributors. They do not constitute TI specifications and do not necessarily reflect TI's views; see TI's [Terms of Use](#).

4.3 Trademarks

TI E2E™ is a trademark of Texas Instruments.

All trademarks are the property of their respective owners.

4.4 Electrostatic Discharge Caution



This integrated circuit can be damaged by ESD. Texas Instruments recommends that all integrated circuits be handled with appropriate precautions. Failure to observe proper handling and installation procedures can cause damage.

ESD damage can range from subtle performance degradation to complete device failure. Precision integrated circuits may be more susceptible to damage because very small parametric changes could cause the device not to meet its published specifications.

4.5 Glossary

[TI Glossary](#) This glossary lists and explains terms, acronyms, and definitions.

5 Mechanical, Packaging, and Orderable Information

The following pages include mechanical, packaging, and orderable information. This information is the most current data available for the designated devices. This data is subject to change without notice and revision of this document. For browser-based versions of this data sheet, refer to the left-hand navigation.

5.1 Package Option Addendum

Packaging Information

Orderable Device	Status	Package Type	Package Drawing	Pins	Package Qty	Eco Plan	Lead/Ball Finish	MSL Peak Temp	Op Temp (°C)	Device Marking
TDES4940RURTQ1	ACTIVE	VQFN	RUR0088D	88	250	RoHS & Green	NiPdAuAg	Level-3-260C-168 HR	-20 to 85	TDES4940
TDES4940RURRQ1	ACTIVE	VQFN	RUR0088D	88	2500	RoHS & Green	NiPdAuAg	Level-3-260C-168 HR	-20 to 85	TDES4940

Important Information and Disclaimer: The information provided on this page represents TI's knowledge and belief as of the date that it is provided. TI bases its knowledge and belief on information provided by third parties, and makes no representation or warranty as to the accuracy of such information. Efforts are underway to better integrate information from third parties. TI has taken and continues to take reasonable steps to provide representative and accurate information but may not have conducted destructive testing or chemical analysis on incoming materials and chemicals. TI and TI suppliers consider certain information to be proprietary, and thus CAS numbers and other limited information may not be available for release.

In no event shall TI's liability arising out of such information exceed the total purchase price of the TI part(s) at issue in this document sold by TI to Customer on an annual basis.

5.2 Tape and Reel Information

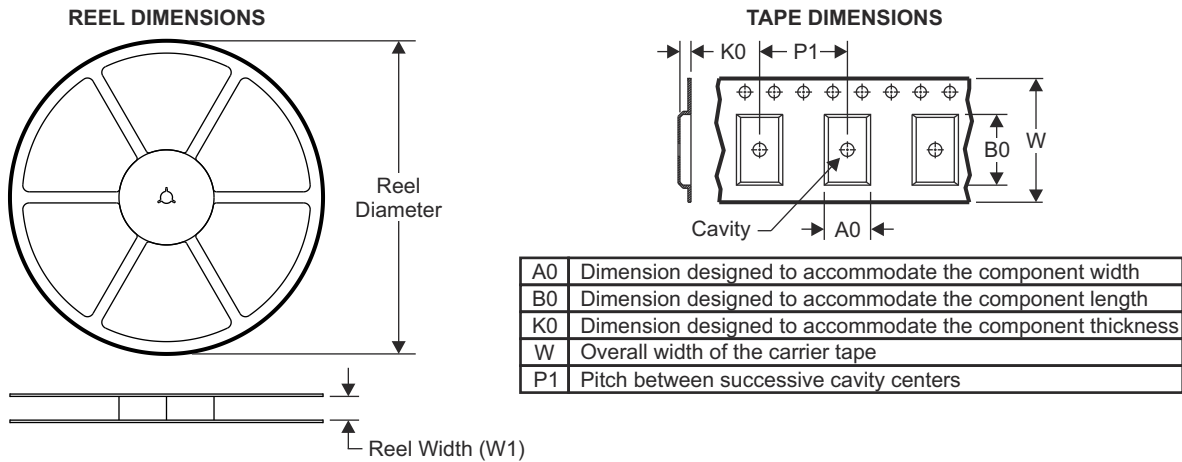

QUADRANT ASSIGNMENTS FOR PIN 1 ORIENTATION IN TAPE

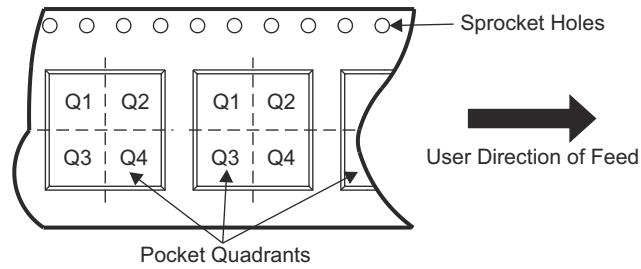

Device	Package Type	Package Drawing	Pins	SPQ	Reel Diameter (mm)	Reel Width W1 (mm)	A0 (mm)	B0 (mm)	K0 (mm)	P1 (mm)	W (mm)	Pin1 Quadrant
TDES4940RURQTQ1	VQFN	RUR0088 D	88	250	180	24.4	12.30	12.30	1.10	16.00	24.00	Q2
TDES4940RURRQ1	VQFN	RUR0088 D	88	2500	330	24.4	12.30	12.30	1.10	16.00	24.00	Q2

TAPE AND REEL BOX DIMENSIONS

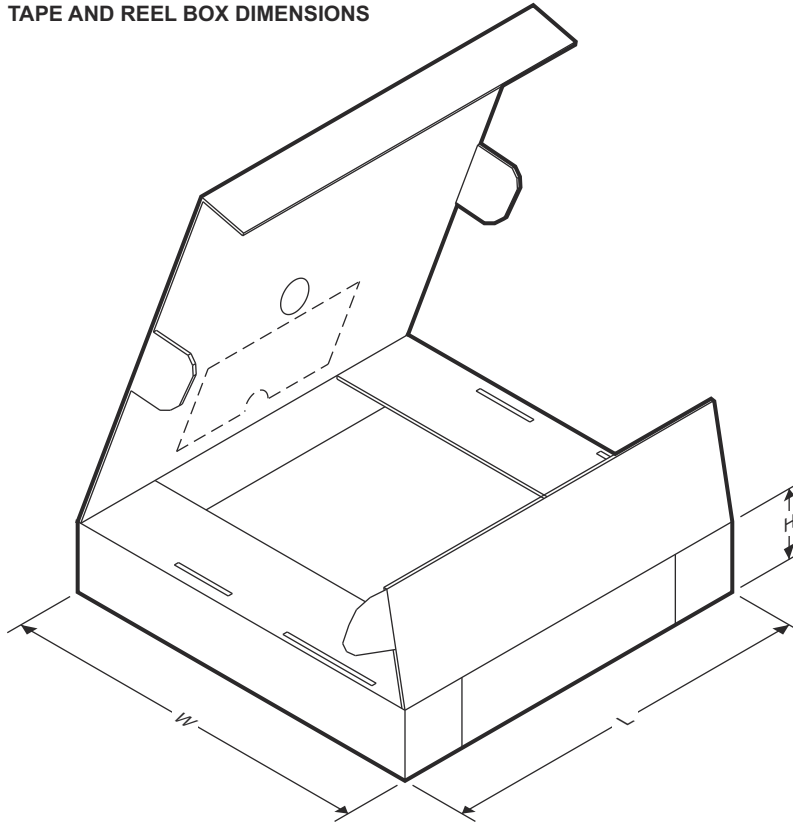

Device	Package Type	Package Drawing	Pins	SPQ	Length (mm)	Width (mm)	Height (mm)
TDES4940RURRTQ1	VQFN	RUR0088D	88	250	210	185	35
TDES4940RURRQ1	VQFN	RUR0088D	88	2500	360	360	36
TDES4940RURRQ1	VQFN	RUR0088D	88	2500	367	367	35

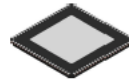

RUR0088D

PACKAGE OUTLINE

VQFN - 0.9 mm max height

PLASTIC QUAD FLATPACK - NO LEAD

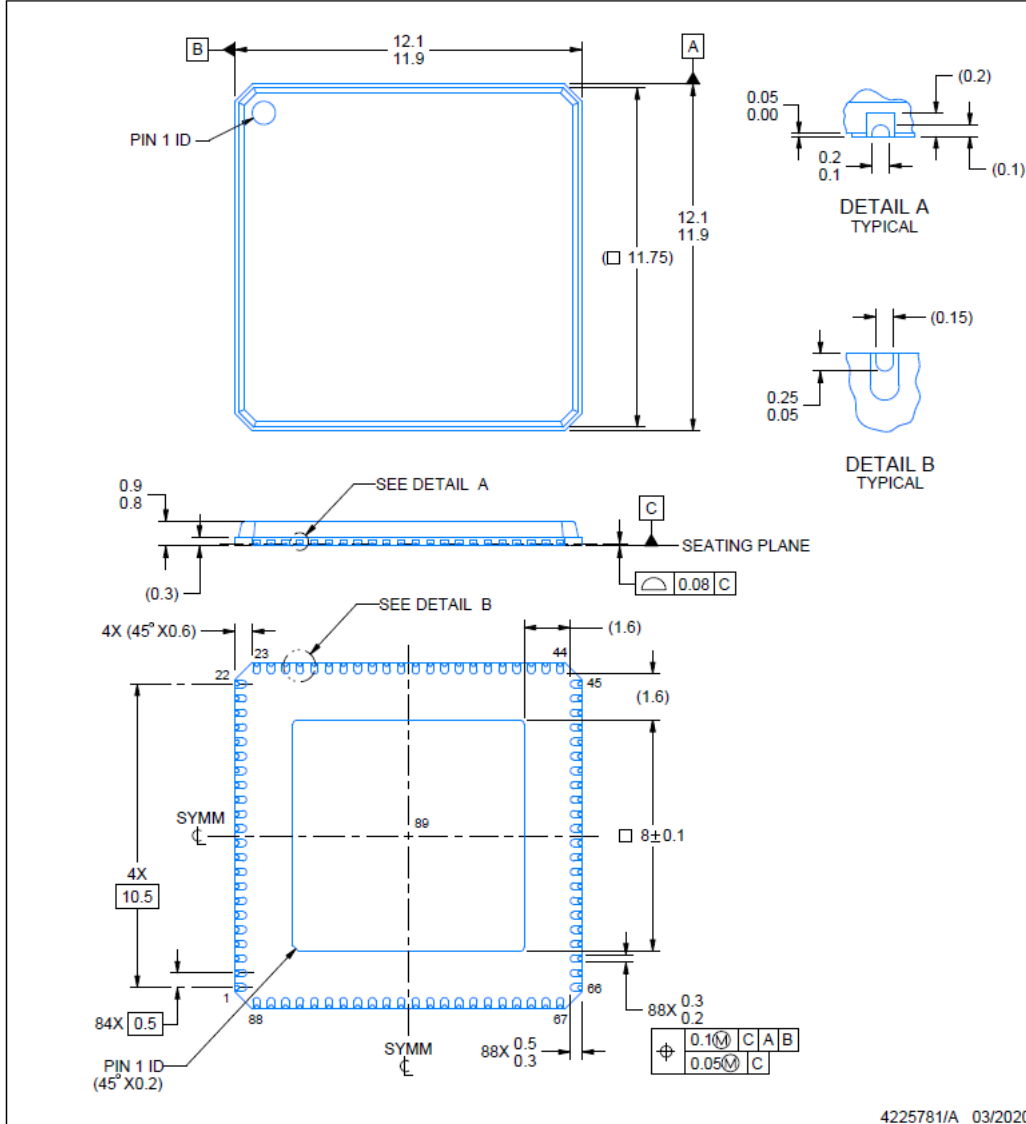

NOTES:

1. All linear dimensions are in millimeters. Any dimensions in parenthesis are for reference only. Dimensioning and tolerancing per ASME Y14.5M.
2. This drawing is subject to change without notice.
3. The package thermal pad must be soldered to the printed circuit board for thermal and mechanical performance.

EXAMPLE STENCIL DESIGN

RUR0088D

VQFN - 0.9 mm max height

PLASTIC QUAD FLATPACK - NO LEAD

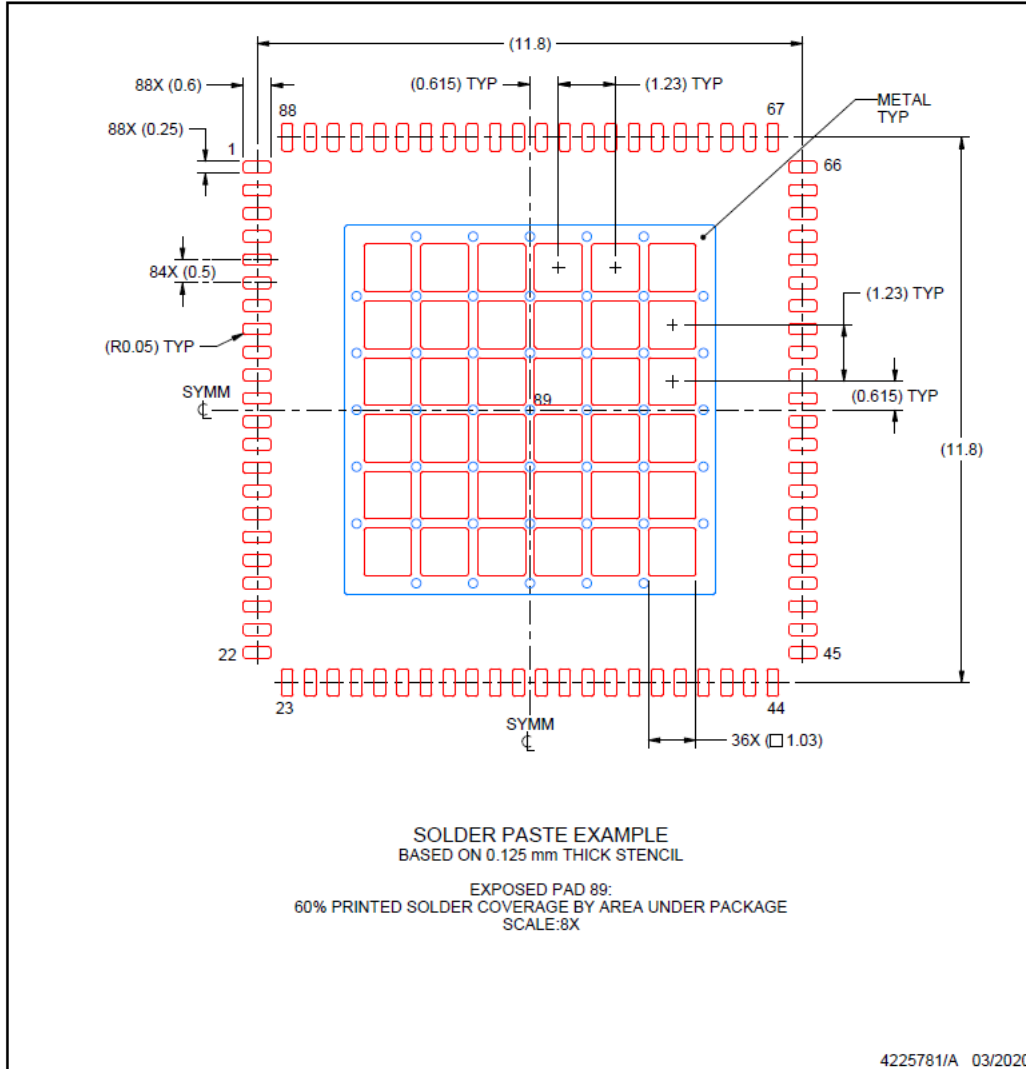

NOTES: (continued)

6. Laser cutting apertures with trapezoidal walls and rounded corners may offer better paste release. IPC-7525 may have alternate design recommendations.

PACKAGING INFORMATION

Orderable part number	Status (1)	Material type (2)	Package Pins	Package qty Carrier	RoHS (3)	Lead finish/ Ball material (4)	MSL rating/ Peak reflow (5)	Op temp (°C)	Part marking (6)
TDES4940RURR	Active	Production	VQFNP (RUR) 88	2500 LARGE T&R	Yes	Call TI Nipdauag	Level-3-260C-168 HR	-20 to 85	TDES4940
TDES4940RURR.A	Active	Production	VQFNP (RUR) 88	2500 LARGE T&R	Yes	Call TI	Level-3-260C-168 HR	-20 to 85	TDES4940
TDES4940RURT	Active	Production	VQFNP (RUR) 88	250 SMALL T&R	Yes	Call TI Nipdauag	Level-3-260C-168 HR	-20 to 85	TDES4940
TDES4940RURT.A	Active	Production	VQFNP (RUR) 88	250 SMALL T&R	Yes	Call TI	Level-3-260C-168 HR	-20 to 85	TDES4940

(1) **Status:** For more details on status, see our [product life cycle](#).

(2) **Material type:** When designated, preproduction parts are prototypes/experimental devices, and are not yet approved or released for full production. Testing and final process, including without limitation quality assurance, reliability performance testing, and/or process qualification, may not yet be complete, and this item is subject to further changes or possible discontinuation. If available for ordering, purchases will be subject to an additional waiver at checkout, and are intended for early internal evaluation purposes only. These items are sold without warranties of any kind.

(3) **RoHS values:** Yes, No, RoHS Exempt. See the [TI RoHS Statement](#) for additional information and value definition.

(4) **Lead finish/Ball material:** Parts may have multiple material finish options. Finish options are separated by a vertical ruled line. Lead finish/Ball material values may wrap to two lines if the finish value exceeds the maximum column width.

(5) **MSL rating/Peak reflow:** The moisture sensitivity level ratings and peak solder (reflow) temperatures. In the event that a part has multiple moisture sensitivity ratings, only the lowest level per JEDEC standards is shown. Refer to the shipping label for the actual reflow temperature that will be used to mount the part to the printed circuit board.

(6) **Part marking:** There may be an additional marking, which relates to the logo, the lot trace code information, or the environmental category of the part.

Multiple part markings will be inside parentheses. Only one part marking contained in parentheses and separated by a "~" will appear on a part. If a line is indented then it is a continuation of the previous line and the two combined represent the entire part marking for that device.

Important Information and Disclaimer: The information provided on this page represents TI's knowledge and belief as of the date that it is provided. TI bases its knowledge and belief on information provided by third parties, and makes no representation or warranty as to the accuracy of such information. Efforts are underway to better integrate information from third parties. TI has taken and continues to take reasonable steps to provide representative and accurate information but may not have conducted destructive testing or chemical analysis on incoming materials and chemicals. TI and TI suppliers consider certain information to be proprietary, and thus CAS numbers and other limited information may not be available for release.

In no event shall TI's liability arising out of such information exceed the total purchase price of the TI part(s) at issue in this document sold by TI to Customer on an annual basis.

GENERIC PACKAGE VIEW

RUR 88

VQFN - 0.9 mm max height

12 x 12, 0.5 mm pitch

PLASTIC QUAD FLATPACK - NO LEAD

This image is a representation of the package family, actual package may vary.
Refer to the product data sheet for package details.

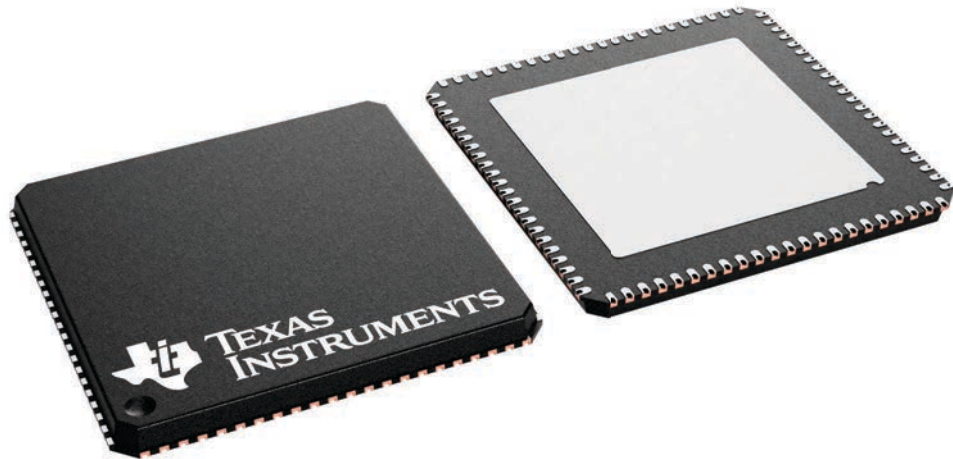

4228969/A

IMPORTANT NOTICE AND DISCLAIMER

TI PROVIDES TECHNICAL AND RELIABILITY DATA (INCLUDING DATASHEETS), DESIGN RESOURCES (INCLUDING REFERENCE DESIGNS), APPLICATION OR OTHER DESIGN ADVICE, WEB TOOLS, SAFETY INFORMATION, AND OTHER RESOURCES "AS IS" AND WITH ALL FAULTS, AND DISCLAIMS ALL WARRANTIES, EXPRESS AND IMPLIED, INCLUDING WITHOUT LIMITATION ANY IMPLIED WARRANTIES OF MERCHANTABILITY, FITNESS FOR A PARTICULAR PURPOSE OR NON-INFRINGEMENT OF THIRD PARTY INTELLECTUAL PROPERTY RIGHTS.

These resources are intended for skilled developers designing with TI products. You are solely responsible for (1) selecting the appropriate TI products for your application, (2) designing, validating and testing your application, and (3) ensuring your application meets applicable standards, and any other safety, security, regulatory or other requirements.

These resources are subject to change without notice. TI grants you permission to use these resources only for development of an application that uses the TI products described in the resource. Other reproduction and display of these resources is prohibited. No license is granted to any other TI intellectual property right or to any third party intellectual property right. TI disclaims responsibility for, and you fully indemnify TI and its representatives against any claims, damages, costs, losses, and liabilities arising out of your use of these resources.

TI's products are provided subject to [TI's Terms of Sale](#), [TI's General Quality Guidelines](#), or other applicable terms available either on ti.com or provided in conjunction with such TI products. TI's provision of these resources does not expand or otherwise alter TI's applicable warranties or warranty disclaimers for TI products. Unless TI explicitly designates a product as custom or customer-specified, TI products are standard, catalog, general purpose devices.

TI objects to and rejects any additional or different terms you may propose.

Copyright © 2026, Texas Instruments Incorporated

Last updated 10/2025