

REF35 Ultra Low-Power, High-Precision Voltage Reference

1 Features

- Ultra-low quiescent current:
 - 650nA (typical)
- Initial accuracy: $\pm 0.05\%$ (maximum)
- Temperature coefficient (maximum):
 - 12ppm/°C (–40°C to 105°C, SOT23 package)
 - 10ppm/°C (–40°C to 85°C, WCSP package)
- Output 1/f noise (0.1Hz to 10Hz): 3.3ppm_{p-p}
- NR pin to reduce noise
- EN pin to reduce shutdown current consumption
- Long-term stability: 40ppm at 1k hour
- Thermal hysteresis: 70ppm
- Operating temperature range: –55°C to +125°C
- Output current: +10mA, –5mA
- Input voltage: $V_{REF} + V_{DO}$ to 6V
- Output voltage options:
 - 1.024V, 1.2V, 1.25V, 1.6V, 1.8V, 2.048V, 2.5V, 3.0V, 3.3V, 4.096V, 5.0V
- Small footprint 6-pin SOT–23 package
- Smallest footprint 4-pin WCSP package

2 Applications

- Flow transmitter
- Blood glucose monitor
- Servo drive control module
- Power quality analyzer
- Fault indicator
- Oscilloscope
- Process analytics
- Optical Module

3 Description

The REF35 is a family of nanopower, low-drift, high-precision series reference devices. The REF35 family features $\pm 0.05\%$ initial accuracy with 650nA typical power consumption. The temperature coefficient (12ppm/°C) and long-term stability (40ppm at 1000 hours) of the device can help improve system stability and reliability. The low power consumption combined with high precision specifications are designed for a wide variety of portable and low current applications.

The REF35 supplies up to 10mA current with 3.3ppm_{p-p} noise and 20ppm/mA load regulation. With this feature set, REF35 creates a strong low-noise, high accuracy power supply for precision sensors and 12–16b data converters.

The family is specified for operation from –40°C to 105°C and is functional over –55°C to 125°C. The wide temperature is suited for industrial applications.

REF35 is available in wide output voltage variants starting from 1.024V to 5.0V. The device is offered in a space-saving, 6-pin SOT-23 and 4-pin WCSP package options. Contact your local TI sales representative for available voltage and package options.

Package Information

PART NUMBER	PACKAGE (1)	BODY SIZE (NOM) (2)
REF35xxx	SOT-23 (6)	2.90mm × 1.60mm
	WCSP (4)	1.05mm × 0.84mm

- (1) For all available voltage variants and packages, see the orderable addendum at the end of the data sheet.
- (2) The package size (length × width) is a nominal value and includes pins, where applicable.

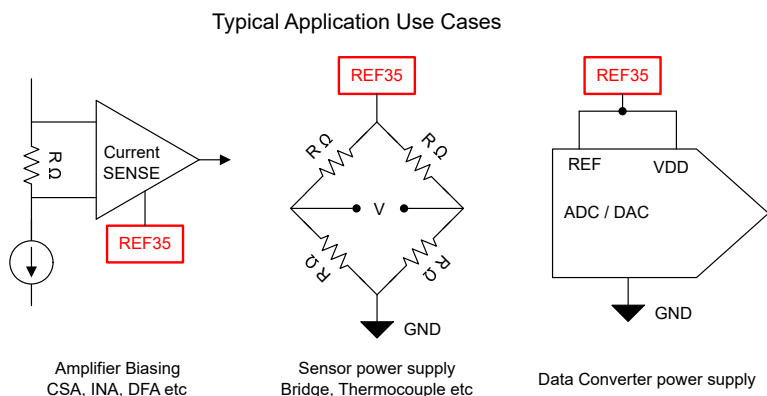
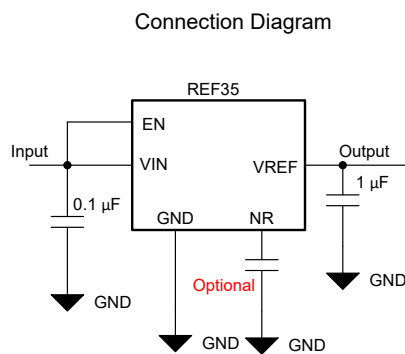

REF35 Use Case



Table of Contents

1 Features	1	8 Detailed Description	21
2 Applications	1	8.1 Overview.....	21
3 Description	1	8.2 Functional Block Diagram.....	21
4 Device Comparison	3	8.3 Feature Description.....	21
5 Pin Configuration and Functions	3	8.4 Device Functional Modes	22
6 Specifications	4	9 Application and Implementation	24
6.1 Absolute Maximum Ratings.....	4	9.1 Application Information.....	24
6.2 ESD Ratings.....	4	9.2 Typical Applications.....	24
6.3 Recommended Operating Conditions.....	4	9.3 Power Supply Recommendations.....	27
6.4 Thermal Information.....	4	9.4 Layout.....	27
6.5 Electrical Characteristics.....	5	10 Device and Documentation Support	29
6.6 Electrical Characteristics YBH package.....	6	10.1 Documentation Support.....	29
6.7 Typical Characteristics.....	8	10.2 Receiving Notification of Documentation Updates..	29
7 Parameter Measurement Information	15	10.3 Support Resources.....	29
7.1 Solder Heat Shift.....	15	10.4 Trademarks.....	29
7.2 Temperature Coefficient.....	16	10.5 Electrostatic Discharge Caution.....	29
7.3 Long-Term Stability.....	16	10.6 Glossary.....	29
7.4 Thermal Hysteresis.....	17	11 Revision History	29
7.5 Noise Performance.....	18	12 Mechanical, Packaging, and Orderable Information	30
7.6 Power Dissipation.....	20		

4 Device Comparison

PRODUCT		V _{REF}
SOT-23 (6)	WCSP (4)	
REF35102QDBVR	REF35102YBHR	1.024V
REF35120QDBVR	REF35120YBHR	1.2V
REF35125QDBVR	REF35125YBHR	1.25V
REF35160QDBVR	REF35160YBHR	1.6V
REF35170QDBVR	-	1.7V
REF35180QDBVR	REF35180YBHR	1.8V
REF35205QDBVR	-	2.048V
REF35250QDBVR	REF35250YBHR	2.5V
REF35300QDBVR	REF35300YBHR	3.0V
REF35330QDBVR	-	3.3V
REF35360QDBVR	-	3.6V
REF35409QDBVR	REF35409YBHR	4.096V
REF35500QDBVR	-	5.0V

5 Pin Configuration and Functions

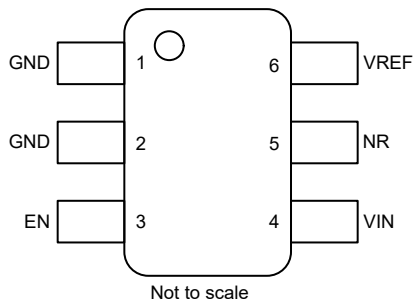

Not to scale
**Figure 5-1. DBV Package
6-Pin SOT-23
Top View**

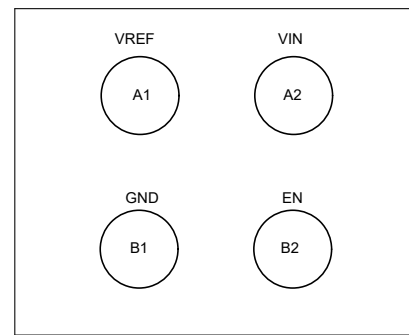

Not to scale
**Figure 5-2. YBH Package
4-Pin WCSP
Top View**

Table 5-1. Pin Functions

NAME	PIN		TYPE	DESCRIPTION
	SOT-23	WCSP		
GND	1	B1	Ground	Device ground connection. For DBV package pin 1 and pin 2 are internally short.
GND	2	-	Ground	Device ground connection.
EN	3	B2	Input	Enable connection. Enables or disables the device.
VIN	4	A2	Power	Input supply voltage connection.
NR	5	-	Output	Noise reduction pin. Connect a capacitor to reduce noise. This pin can be left floating.
VREF	6	A1	Output	Reference voltage output.

6 Specifications

6.1 Absolute Maximum Ratings

over operating free-air temperature range (unless otherwise noted) ⁽¹⁾

		MIN	MAX	UNIT
Input voltage	IN	-0.3	6.5	V
Enable voltage	EN	-0.3	IN + 0.3 ⁽²⁾	V
Output voltage	V _{REF}	-0.3	IN + 0.3 ⁽²⁾	V
Output short circuit current	I _{SC}		20	mA
Operating temperature range	T _A	-55	125	°C
Storage temperature range	T _{stg}	-65	170	°C

- (1) Operation outside the Absolute Maximum Ratings may cause permanent device damage. Absolute Maximum Ratings do not imply functional operation of the device at these or any other conditions beyond those listed under Recommended Operating Conditions. If used outside the Recommended Operating Conditions but within the Absolute Maximum Ratings, the device may not be fully functional, and this may affect device reliability, functionality, performance, and shorten the device lifetime.
- (2) IN + 0.3V or 6.5V, whichever is lower

6.2 ESD Ratings

			VALUE	UNIT
V _(ESD)	Electrostatic discharge	Human body model (HBM), per ANSI/ESDA/JEDEC JS-001, all pins ⁽¹⁾	±2000	V
		Charged device model (CDM), per ANSI/ESDA/JEDEC JS-002, all pins ⁽²⁾	±750	

- (1) JEDEC document JEP155 states that 500V HBM allows safe manufacturing with a standard ESD control process.
- (2) JEDEC document JEP157 states that 250V CDM allows safe manufacturing with a standard ESD control process.

6.3 Recommended Operating Conditions

over operating free-air temperature range (unless otherwise noted)

		MIN	NOM	MAX	UNIT
IN	Input voltage ⁽¹⁾	V _{OUT} + V _{DO} ⁽²⁾		6	V
EN	Enable voltage	0		IN	V
I _L	Output current	-5		10	mA
T _A	Operating temperature	-40	25	125	°C

- (1) For V_{REF} = 1.024V to 1.5V, minimum V_{IN} = 1.7V
- (2) V_{DO} = Dropout voltage

6.4 Thermal Information

THERMAL METRIC ⁽¹⁾		REF35		UNIT
		YBH (WCSP)	DBV (SOT-23)	
		4 PINS	6 PINS	
R _{θJA}	Junction-to-ambient thermal resistance	178.9	164.4	°C/W
R _{θJC(top)}	Junction-to-case (top) thermal resistance	1.1	102.5	°C/W
R _{θJB}	Junction-to-board thermal resistance	60.3	59.6	°C/W
Ψ _{JT}	Junction-to-top characterization parameter	0.5	44.0	°C/W
Ψ _{JB}	Junction-to-board characterization parameter	60.2	59.4	°C/W
R _{θJC(bot)}	Junction-to-case (bottom) thermal resistance	N/A	N/A	°C/W

- (1) For more information about traditional and new thermal metrics, see the [Semiconductor and IC Package Thermal Metrics](#) application report.

6.5 Electrical Characteristics

At $V_{IN} = V_{REF} + 0.5V$, $V_{EN} = V_{IN}$, $C_L = 10\mu F$, $C_{IN} = 0.1\mu F$, $I_L = 0mA$, minimum and maximum specifications at $T_A = -40^\circ C$ to $125^\circ C$, typical specifications $T_A = 25^\circ C$; unless otherwise noted

PARAMETER		TEST CONDITION		MIN	TYP	MAX	UNIT
ACCURACY AND DRIFT							
	Output voltage accuracy	$T_A = 25^\circ C$		-0.05		0.05	%
	Output voltage temperature coefficient	$-40^\circ C \leq T_A \leq 105^\circ C$				12	ppm/ $^\circ C$
LINE AND LOAD REGULATION							
$\frac{\Delta V_{REF}}{\Delta V_{IN}}$	Line regulation	$V_{REF} < 2.5V$; $V_{IN} = V_{REF} + V_{DO}$ to V_{INMAX} ; $-40^\circ C \leq T_A \leq 105^\circ C$			40	160	ppm/V
		$V_{REF} \geq 2.5V$; $V_{IN} = V_{REF} + V_{DO}$ to V_{INMAX} ; $-40^\circ C \leq T_A \leq 105^\circ C$			40	120	ppm/V
$\Delta V_{REF}/\Delta I_L$	Load regulation	$I_L = 0mA$ to $10mA$, $V_{IN} = V_{REF} + V_{DO}$	Source		20	60	ppm/mA
		$I_L = 0mA$ to $5mA$, $V_{IN} = V_{REF} + V_{DO}$	Sink		40	350	ppm/mA
POWER SUPPLY							
V_{IN}	Input voltage ⁽¹⁾			$V_{REF} + V_{DO}$		6	V
I_Q	Quiescent current	Active mode	$T_A = 25^\circ C$		0.65	0.9	μA
			$-40^\circ C \leq T_A \leq 85^\circ C$			1.3	
			$-40^\circ C \leq T_A \leq 125^\circ C$			2.6	
		Shutdown mode	$T_A = 25^\circ C$			0.1	
			$-40^\circ C \leq T_A \leq 125^\circ C$			0.5	
V_{EN}	Enable pin voltage	Active mode (EN = 1 or Float)		$0.7 \times V_{IN}$			V
		Shutdown mode (EN = 0)		$0.3 \times V_{IN}$			
I_{EN}	Enable pin current	$V_{EN} = V_{IN}$			0.05	0.1	μA
V_{DO}	Dropout voltage	$I_L = 5mA$				120	mV
		$I_L = 10mA$				250	
I_{SC}	Short circuit current, Sourcing	$V_{REF} = 0V$, $T_A = 25^\circ C$			33		mA
I_{SC}	Short circuit current, Sinking	$V_{REF} = V_{IN} V$, $T_A = 25^\circ C$			21		mA
TURN-ON TIME							
t_{ON}	Turn-on time ⁽²⁾	0.1% settling, $C_L = 1\mu F$, $V_{REF} = 2.5V$			2		ms
NOISE							
e_n	Output voltage noise	$f = 10Hz$ to $1kHz$, $C_L = 1\mu F$			0.7		ppm _{rms}
e_{np-p}	Low-frequency noise	$f = 0.1Hz$ to $10Hz$, $V_{REF} \geq 2.5V$			3.8		ppm _{p-p}
		$f = 0.1Hz$ to $10Hz$, $V_{REF} < 2.5V$			3.3		ppm _{p-p}
HYSTERESIS AND LONG-TERM STABILITY							
	Long-term stability	0 to 1000h at $35^\circ C$			40		ppm
	Output voltage hysteresis	$25^\circ C$, $-40^\circ C$, $105^\circ C$, $25^\circ C$ (cycle 1)			70		ppm
	Output voltage hysteresis	$25^\circ C$, $-40^\circ C$, $105^\circ C$, $25^\circ C$ (cycle 2)			20		ppm
	Output voltage hysteresis	$25^\circ C$, $-40^\circ C$, $85^\circ C$, $25^\circ C$ (cycle 1)			50		ppm
	Output voltage hysteresis	$25^\circ C$, $-40^\circ C$, $85^\circ C$, $25^\circ C$ (cycle 2)			13		ppm
STABLE CAPACITANCE RANGE							

6.5 Electrical Characteristics (continued)

At $V_{IN} = V_{REF} + 0.5V$, $V_{EN} = V_{IN}$, $C_L = 10\mu F$, $C_{IN} = 0.1\mu F$, $I_L = 0mA$, minimum and maximum specifications at $T_A = -40^\circ C$ to $125^\circ C$, typical specifications $T_A = 25^\circ C$; unless otherwise noted

PARAMETER	TEST CONDITION	MIN	TYP	MAX	UNIT
Input capacitor range		0.1			μF
Output capacitor range (3)		0.1		10	μF

(1) For $V_{REF} = 1.024V$ to $1.5V$, minimum $V_{IN} = 1.7V$

(2) Scales linearly with V_{REF} .

(3) ESR for the capacitor $\leq 400m\Omega$

6.6 Electrical Characteristics YBH package

At $V_{IN} = V_{REF} + 0.5V$, $V_{EN} = V_{IN}$, $C_{REF} = 10\mu F$, $C_{IN} = 0.1\mu F$, $I_L = 0mA$, minimum and maximum specifications at $T_A = -40^\circ C$ to $125^\circ C$, typical specifications $T_A = 25^\circ C$; unless otherwise noted

PARAMETER	TEST CONDITION	MIN	TYP	MAX	UNIT	
ACCURACY AND DRIFT						
Output voltage accuracy	$T_A = 25^\circ C$	-0.05		0.05	%	
Output voltage temperature coefficient	$-40^\circ C \leq T_A \leq 85^\circ C$			10	ppm/ $^\circ C$	
LINE AND LOAD REGULATION						
$\frac{\Delta V_{REF}}{\Delta V_{IN}}$	Line regulation	$V_{REF} < 2.5V$; $V_{IN} = V_{REF} + V_{DO}$ to V_{INMAX}		40	160	ppm/V
		$V_{REF} \geq 2.5V$; $V_{IN} = V_{REF} + V_{DO}$ to V_{INMAX}		40	80	ppm/V
$\frac{\Delta V_{REF}}{\Delta I_L}$	Load regulation	$I_L = 0mA$ to $10mA$, $V_{IN} = V_{REF} + V_{DO}$	Source	20	60	ppm/mA
		$I_L = 0mA$ to $5mA$, $V_{IN} = V_{REF} + V_{DO}$	Sink	40	350	ppm/mA
POWER SUPPLY						
V_{IN}	Input voltage (1)			$V_{REF} + V_{DO}$	6	V
I_Q	Quiescent current	Active mode	$T_A = 25^\circ C$	0.65	0.9	μA
			$-40^\circ C \leq T_A \leq 85^\circ C$		1.3	
			$-40^\circ C \leq T_A \leq 125^\circ C$		2.6	
		Shutdown mode	$T_A = 25^\circ C$		0.1	
$-40^\circ C \leq T_A \leq 125^\circ C$			0.5			
V_{EN}	Enable pin voltage	Active mode (EN = 1 or Float)		$0.7 \times V_{IN}$		V
		Shutdown mode (EN = 0)		$0.3 \times V_{IN}$		
I_{EN}	Enable pin current	$V_{EN} = V_{IN}$		0.05	0.1	μA
V_{DO}	Dropout voltage	$I_L = 5mA$			120	mV
		$I_L = 10mA$			250	
I_{SC}	Short circuit current, Sourcing	$V_{REF} = 0V$, $T_A = 25^\circ C$		30		mA
I_{SC}	Short circuit current, Sinking	$V_{REF} = V_{IN} V$, $T_A = 25^\circ C$		20		mA
TURNON TIME						
t_{ON}	Turn-on time (2)	0.1% settling, $C_{REF} = 1\mu F$, $V_{REF} = 2.048V$		2		ms
NOISE						
e_n	Output voltage noise	$f = 10Hz$ to $1kHz$		0.7		ppm _{rms}
e_{np-p}	Low frequency noise	$f = 0.1Hz$ to $10Hz$, $V_{REF} \geq 2.5V$		3.8		ppm _{p-p}
		$f = 0.1Hz$ to $10Hz$, $V_{REF} < 2.5V$		3.3		ppm _{p-p}
HYSTERESIS AND LONG-TERM STABILITY						
	Long-term stability	0 to 1000h at $35^\circ C$		40		ppm

6.6 Electrical Characteristics YBH package (continued)

At $V_{IN} = V_{REF} + 0.5V$, $V_{EN} = V_{IN}$, $C_{REF} = 10\mu F$, $C_{IN} = 0.1\mu F$, $I_L = 0mA$, minimum and maximum specifications at $T_A = -40^\circ C$ to $125^\circ C$, typical specifications $T_A = 25^\circ C$; unless otherwise noted

PARAMETER	TEST CONDITION	MIN	TYP	MAX	UNIT
Output voltage hysteresis	25°C, -40°C, 125°C, 25°C (cycle 1)		70		ppm
STABLE CAPACITANCE RANGE					
Input capacitor range		0.1			μF
Output capacitor range (3)		0.1		10	μF

- (1) For $V_{REF} = 1.024V$ to $1.5V$, minimum $V_{IN} = 1.7V$.
- (2) Scales linearly with V_{REF} .
- (3) ESR for the capacitor can range from $10m\Omega$ to $400m\Omega$.

6.7 Typical Characteristics

at $T_A = 25^\circ\text{C}$, $V_{IN} = V_{EN} = V_{REF} + 0.3\text{V}$, $I_L = 0\text{mA}$, $C_L = 10\mu\text{F}$, $C_{IN} = 0.1\mu\text{F}$ (unless otherwise noted)

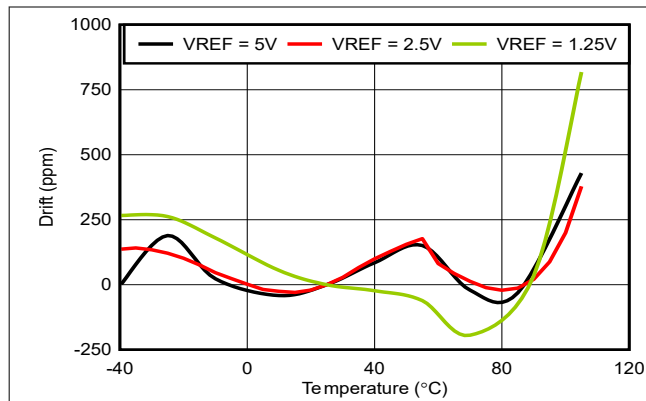

SOT23 Package

Figure 6-1. Output Voltage Drift vs Free-Air Temperature

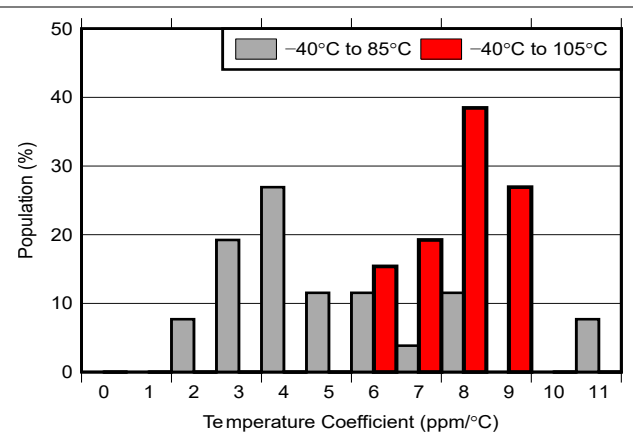

SOT23 Package

Figure 6-2. Temperature Coefficient Distribution ($V_{REF} = 1.25\text{V}$)

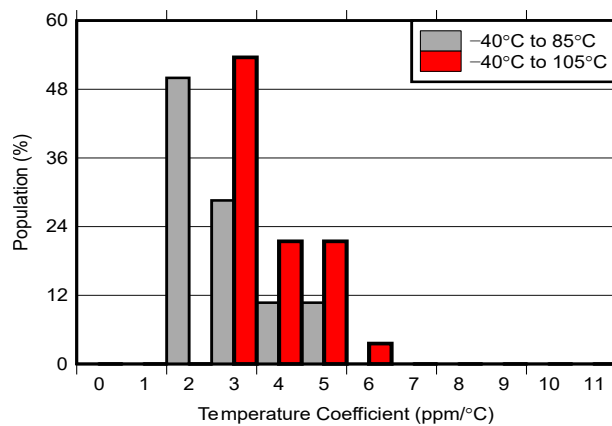

SOT23 Package

Figure 6-3. Temperature Coefficient Distribution ($V_{REF} = 2.5\text{V}$)

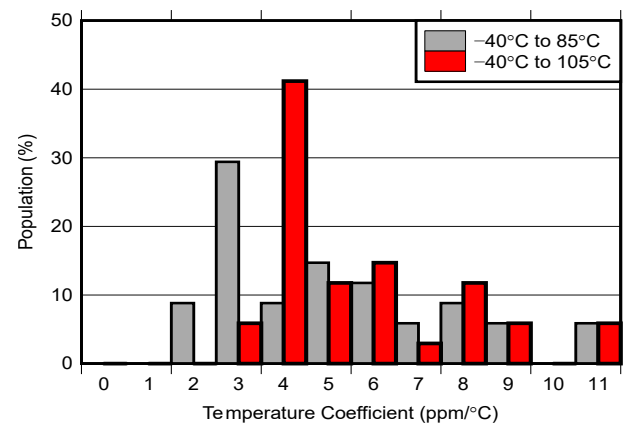

SOT23 Package

Figure 6-4. Temperature Coefficient Distribution ($V_{REF} = 5.0\text{V}$)

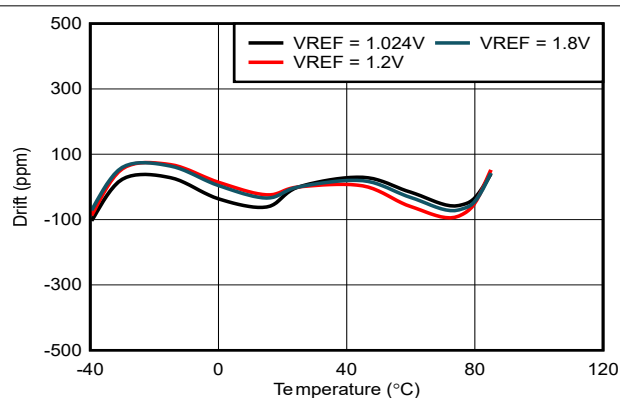

WSCP Package $V_{REF} < 2.5\text{V}$ (-40°C to 85°C)

Figure 6-5. Output Voltage Drift vs Free-Air Temperature

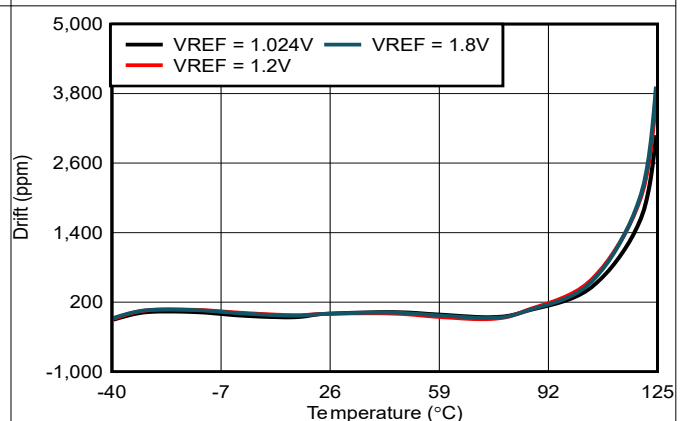

WSCP Package $V_{REF} < 2.5\text{V}$ (-40°C to 125°C)

Figure 6-6. Output Voltage Drift vs Free-Air Temperature

6.7 Typical Characteristics (continued)

at $T_A = 25^\circ\text{C}$, $V_{IN} = V_{EN} = V_{REF} + 0.3\text{V}$, $I_L = 0\text{mA}$, $C_L = 10\mu\text{F}$, $C_{IN} = 0.1\mu\text{F}$ (unless otherwise noted)

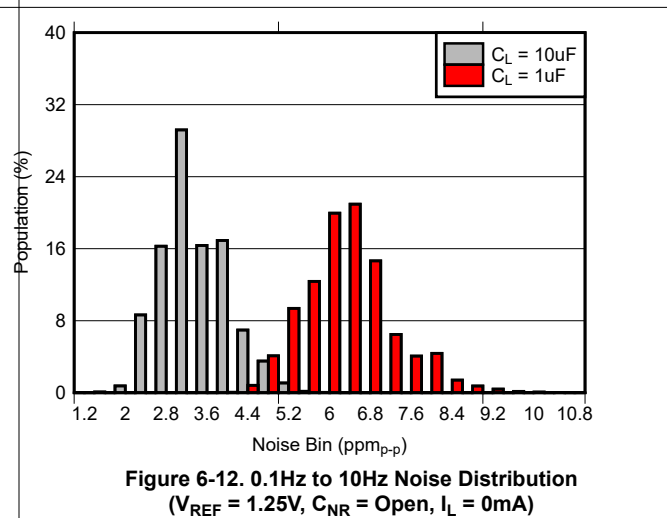
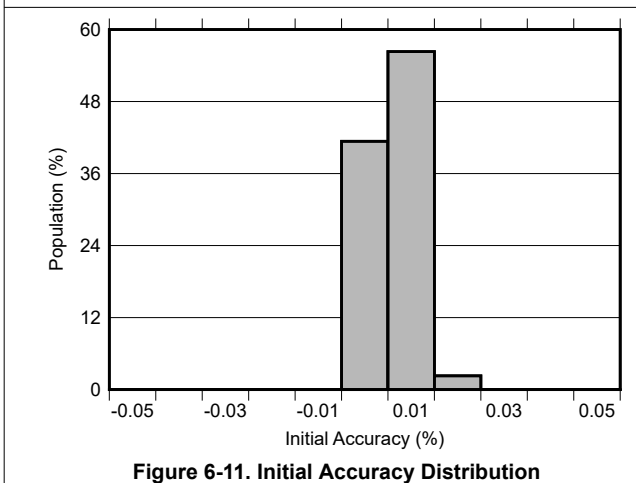
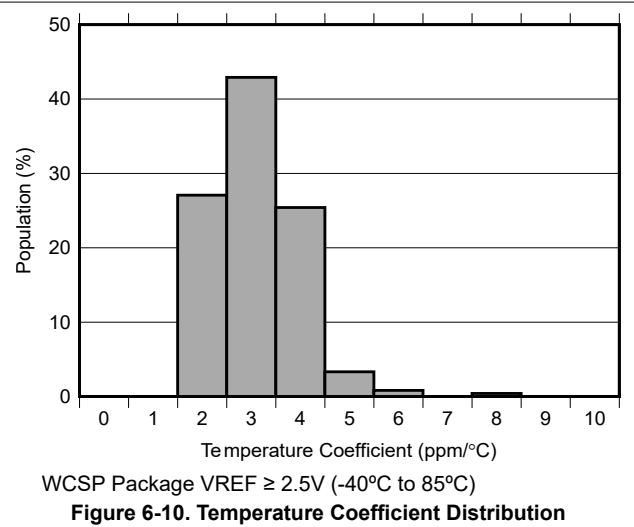
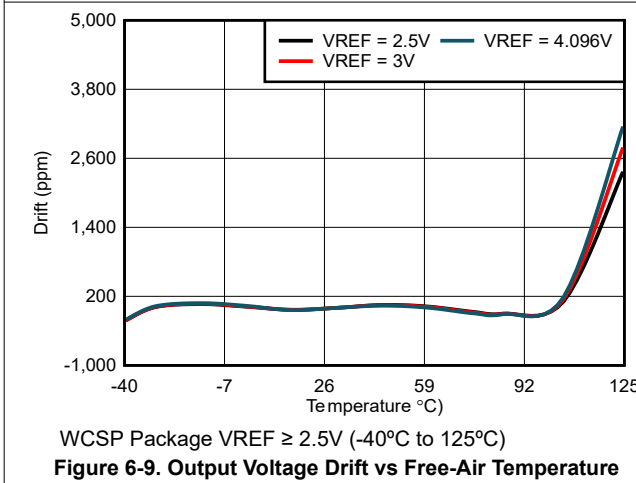
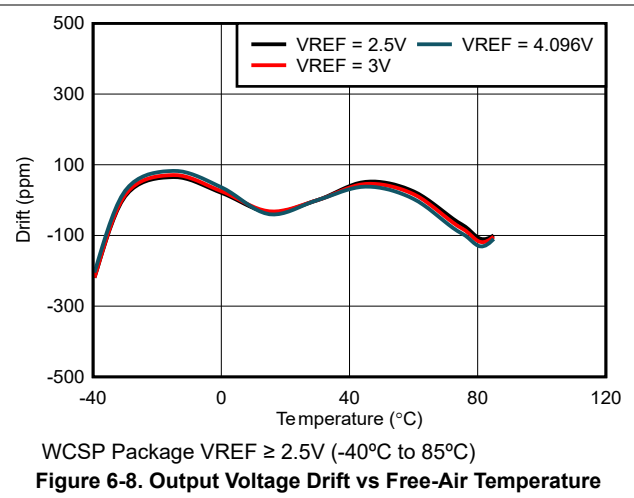
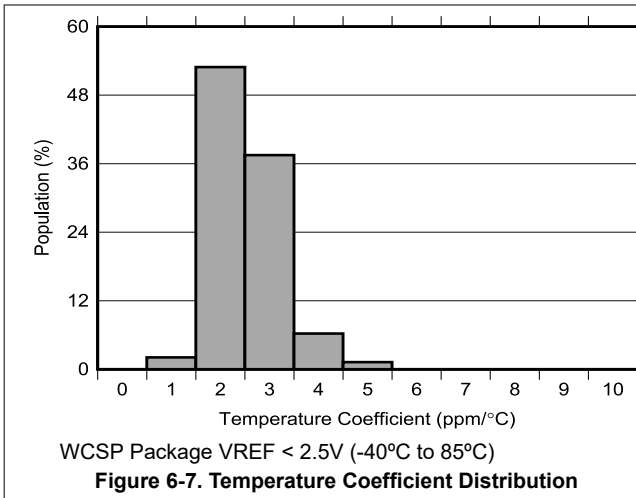

6.7 Typical Characteristics (continued)

at $T_A = 25^\circ\text{C}$, $V_{IN} = V_{EN} = V_{REF} + 0.3\text{V}$, $I_L = 0\text{mA}$, $C_L = 10\mu\text{F}$, $C_{IN} = 0.1\mu\text{F}$ (unless otherwise noted)

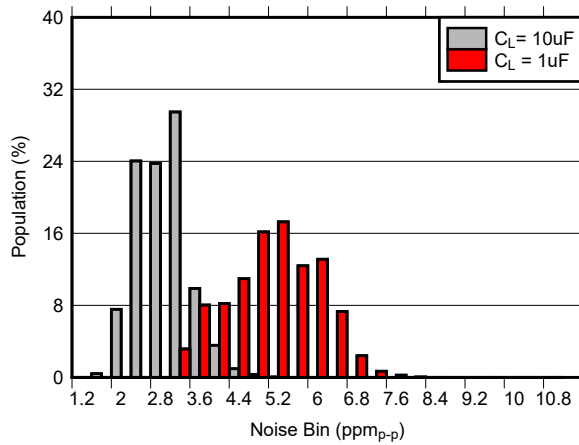

Figure 6-13. 0.1Hz to 10Hz Noise Distribution
($V_{REF} = 2.5\text{V}$, $C_{NR} = \text{Open}$, $I_L = 0\text{mA}$)

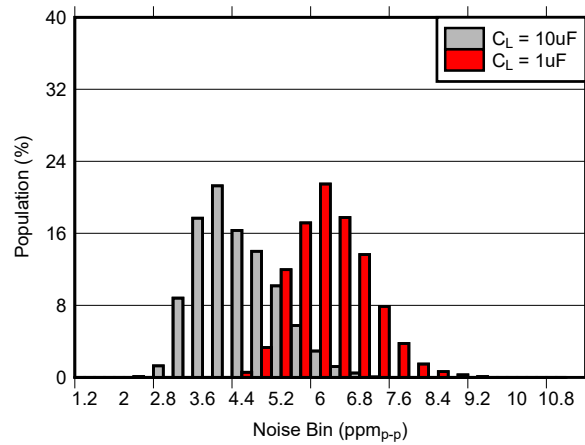

Figure 6-14. 0.1Hz to 10Hz Noise Distribution
($V_{REF} = 5\text{V}$, $C_{NR} = \text{Open}$, $I_L = 0\text{mA}$)

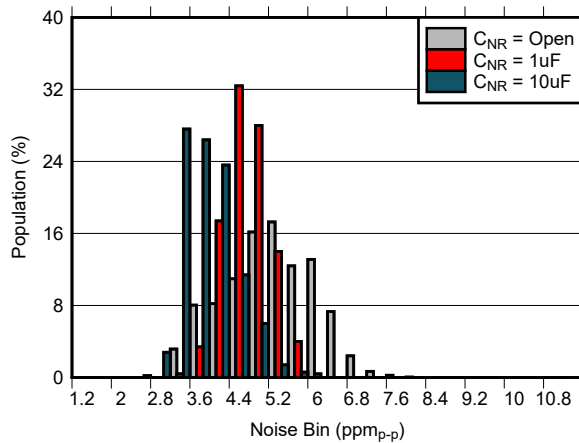

Figure 6-15. 0.1Hz to 10Hz Noise Distribution
($V_{REF} = 2.5\text{V}$, $C_L = 1\mu\text{F}$, $I_L = 0\text{mA}$)

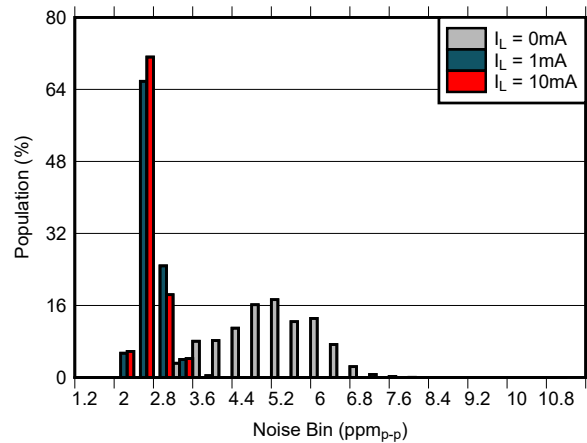

Figure 6-16. 0.1Hz to 10Hz Noise Distribution
($V_{REF} = 2.5\text{V}$, $C_L = 1\mu\text{F}$, $C_{NR} = \text{Open}$)

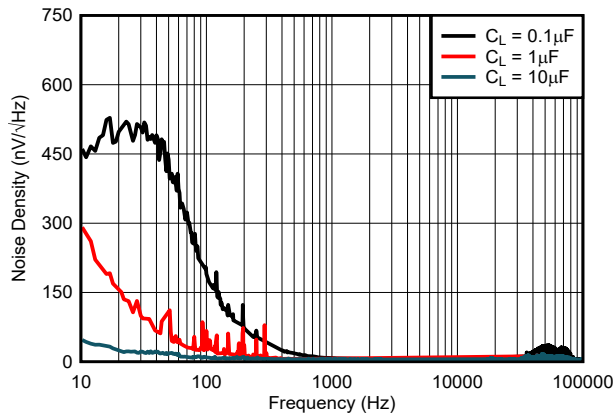

Figure 6-17. Noise Density vs Frequency
($V_{REF} = 1.25\text{V}$, $I_L = 0\text{mA}$)

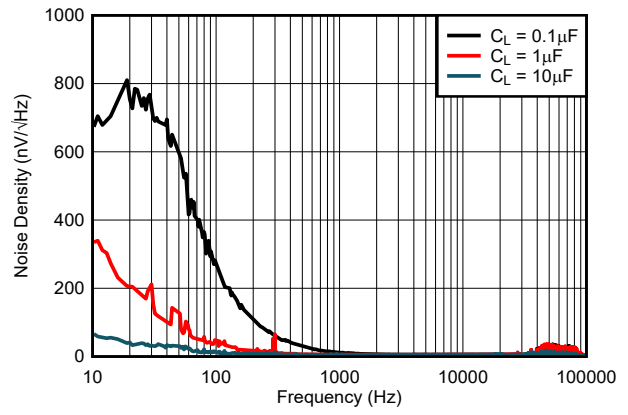

Figure 6-18. Noise Density vs Frequency
($V_{REF} = 2.5\text{V}$, $I_L = 0\text{mA}$)

6.7 Typical Characteristics (continued)

at $T_A = 25^\circ\text{C}$, $V_{IN} = V_{EN} = V_{REF} + 0.3\text{V}$, $I_L = 0\text{mA}$, $C_L = 10\mu\text{F}$, $C_{IN} = 0.1\mu\text{F}$ (unless otherwise noted)

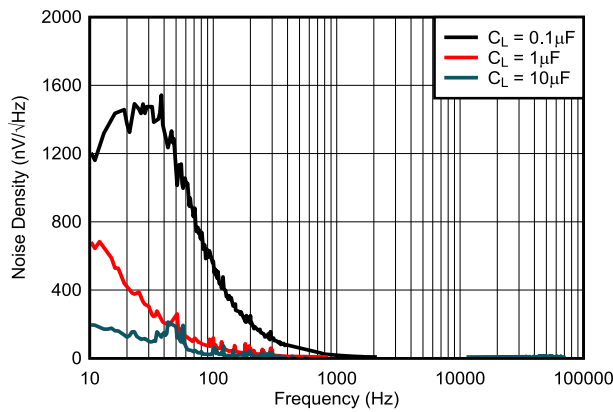

Figure 6-19. Noise Density vs Frequency
($V_{REF} = 5\text{V}$, $I_L = 0\text{mA}$)

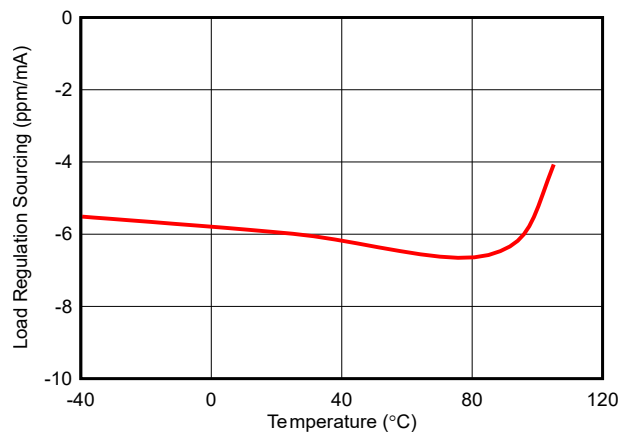

Figure 6-20. Load Regulation (Sourcing 10mA) vs Free-Air Temperature

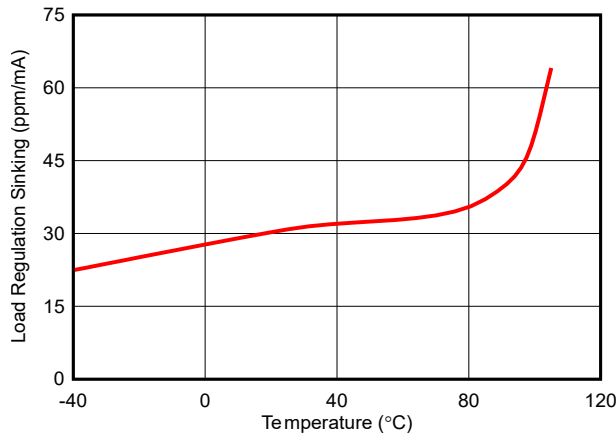

Figure 6-21. Load Regulation (Sinking 5mA) vs Free-Air Temperature

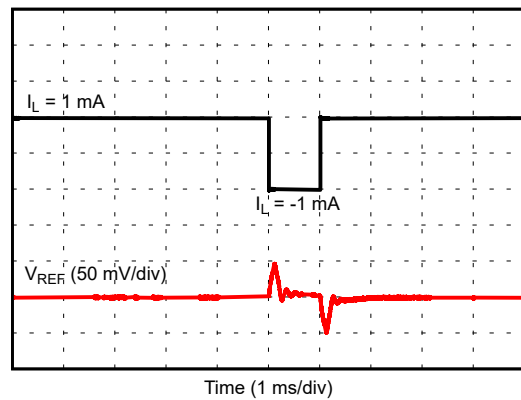

Figure 6-22. Load Transient Response
($V_{REF} = 2.5\text{V}$, $C_L = 10\mu\text{F}$)

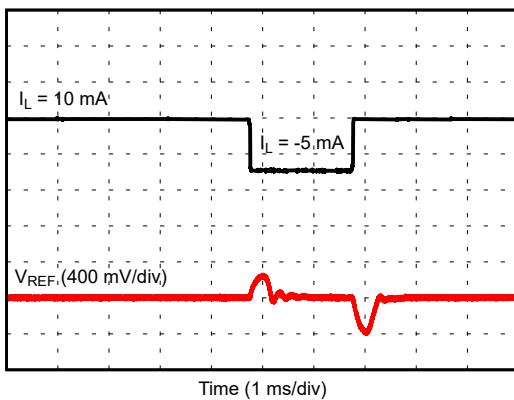

Figure 6-23. Load Transient Response
($V_{REF} = 2.5\text{V}$, $C_L = 10\mu\text{F}$)

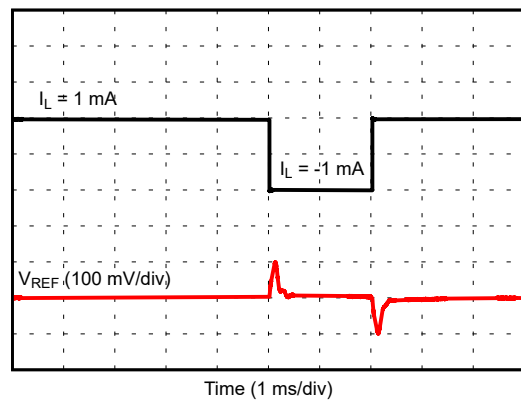

Figure 6-24. Load Transient Response
($V_{REF} = 2.5\text{V}$, $C_L = 1\mu\text{F}$)

6.7 Typical Characteristics (continued)

at $T_A = 25^\circ\text{C}$, $V_{IN} = V_{EN} = V_{REF} + 0.3\text{V}$, $I_L = 0\text{mA}$, $C_L = 10\mu\text{F}$, $C_{IN} = 0.1\mu\text{F}$ (unless otherwise noted)

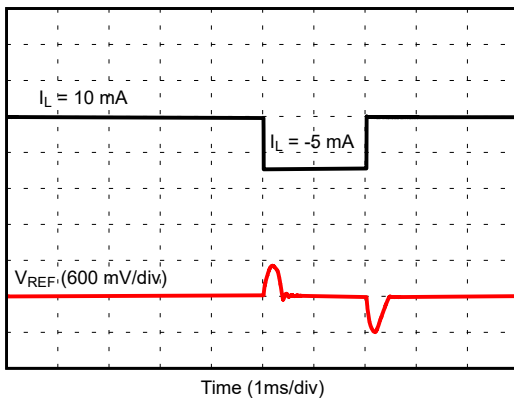

Figure 6-25. Load Transient Response
($V_{REF} = 2.5\text{V}$, $C_L = 1\mu\text{F}$)

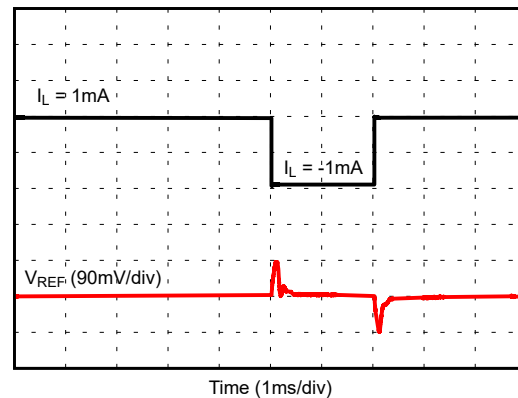

Figure 6-26. Load Transient Response
($V_{REF} = 1.25\text{V}$, $C_L = 1\mu\text{F}$)

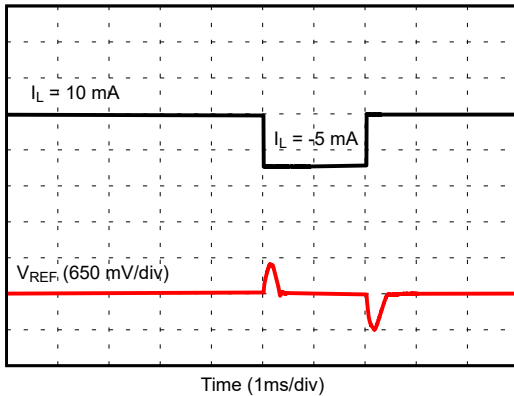

Figure 6-27. Load Transient Response
($V_{REF} = 1.25\text{V}$, $C_L = 1\mu\text{F}$)

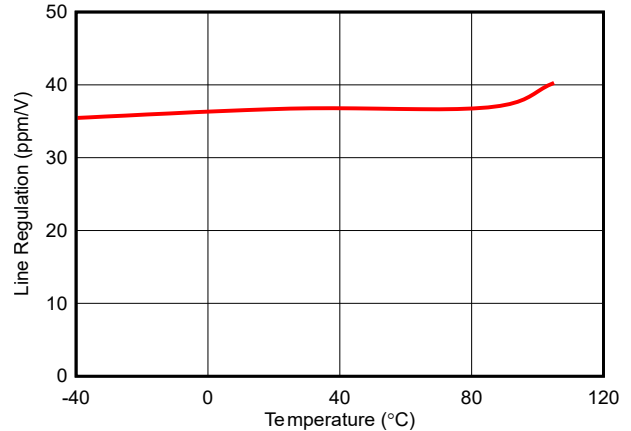

Figure 6-28. Line Regulation vs Free-Air Temperature

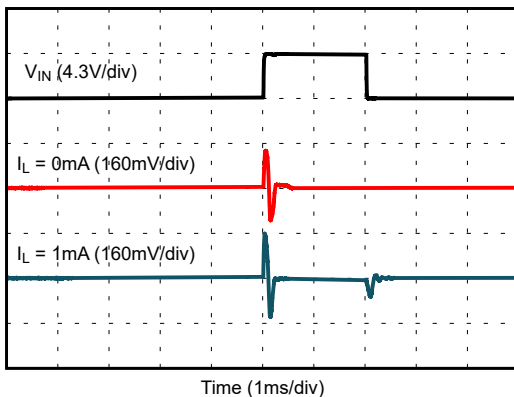

Figure 6-29. Line Transient Response
($V_{REF} = 1.25\text{V}$, $C_L = 1\mu\text{F}$)

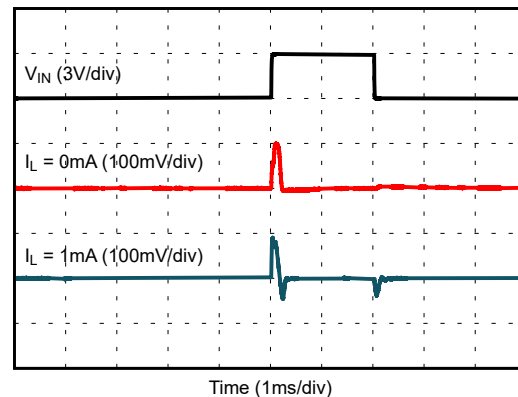
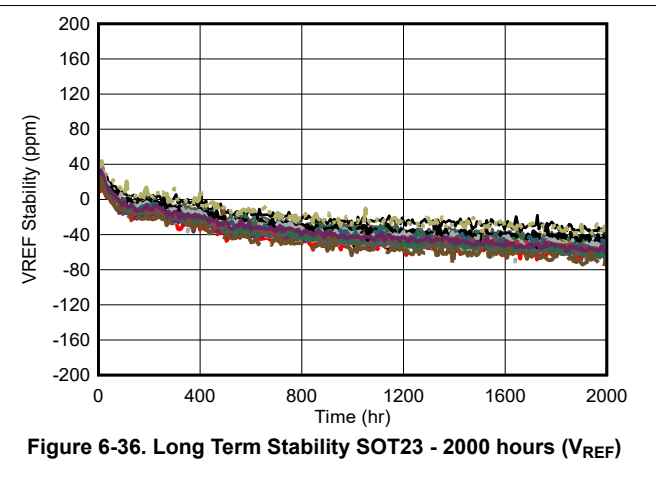
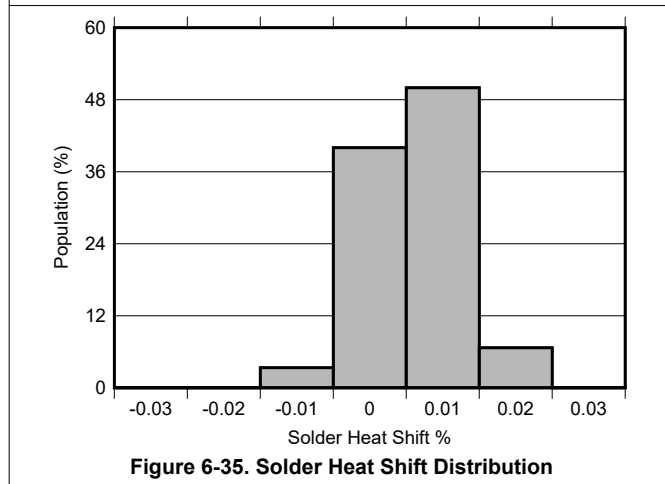
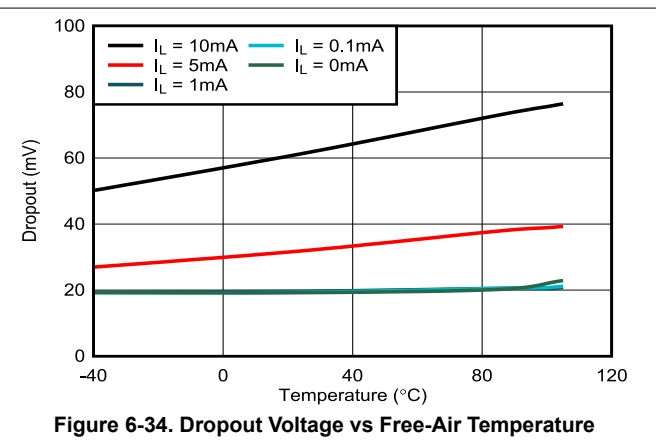
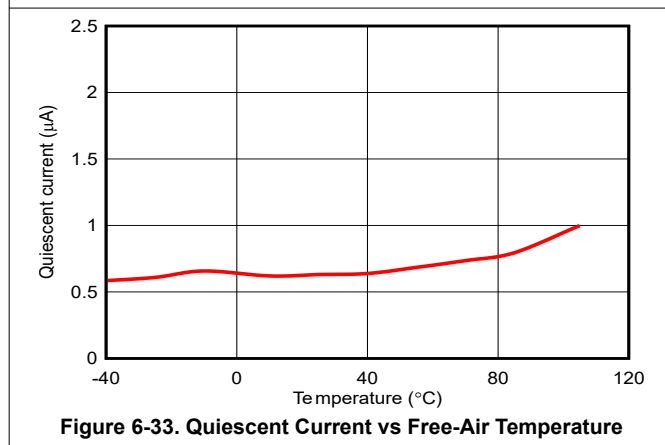
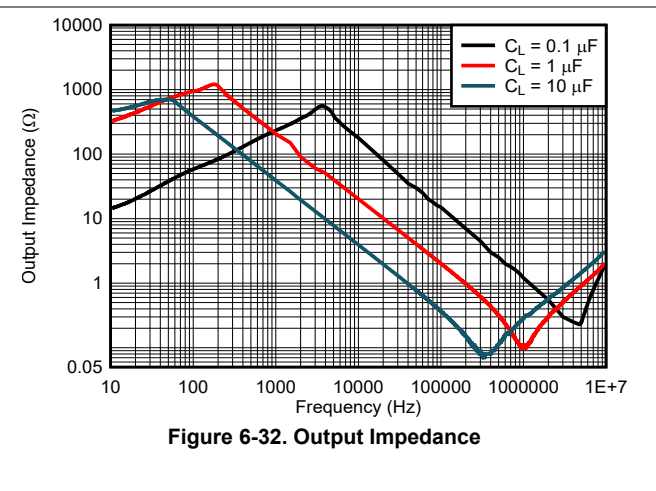
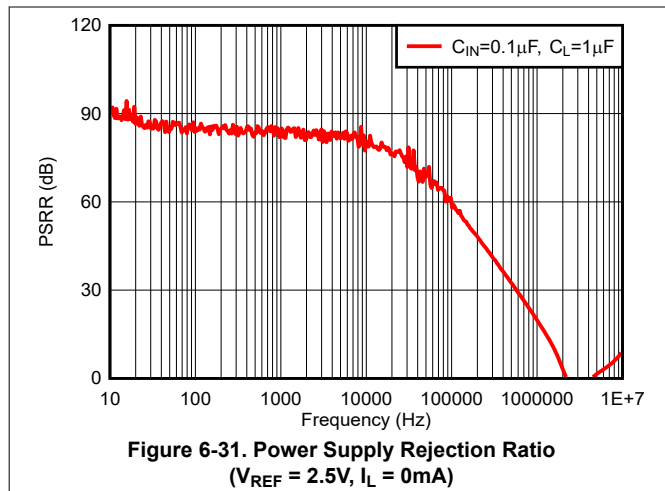

Figure 6-30. Line Transient Response
($V_{REF} = 2.5\text{V}$, $C_L = 1\mu\text{F}$)

6.7 Typical Characteristics (continued)

at $T_A = 25^\circ\text{C}$, $V_{IN} = V_{EN} = V_{REF} + 0.3\text{V}$, $I_L = 0\text{mA}$, $C_L = 10\mu\text{F}$, $C_{IN} = 0.1\mu\text{F}$ (unless otherwise noted)



6.7 Typical Characteristics (continued)

at $T_A = 25^\circ\text{C}$, $V_{IN} = V_{EN} = V_{REF} + 0.3\text{V}$, $I_L = 0\text{mA}$, $C_L = 10\mu\text{F}$, $C_{IN} = 0.1\mu\text{F}$ (unless otherwise noted)

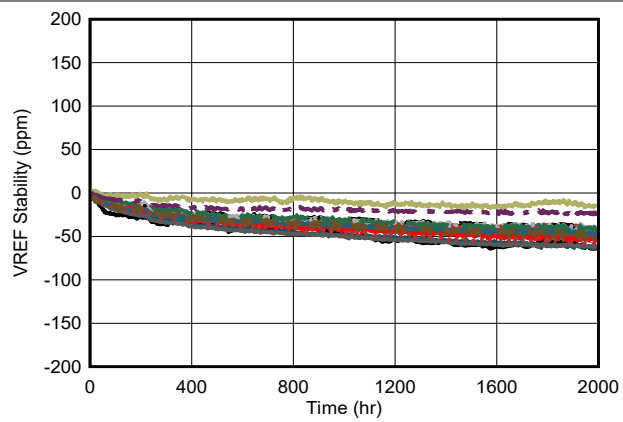

Figure 6-37. Long Term Stability WCSP - 2000 hours (V_{REF})

7 Parameter Measurement Information

7.1 Solder Heat Shift

The materials used in the manufacture of the REF35 have differing coefficients of thermal expansion, resulting in stress on the device die when the part is heated. Mechanical and thermal stress on the device die can cause the output voltages to shift, degrading the initial accuracy specifications of the product. Reflow soldering is a common cause of this error.

To illustrate this effect, a total of 32 devices were soldered on one printed circuit board using lead-free solder paste and the paste manufacturer suggested reflow profile. [Figure 7-1](#) shows the reflow profile. The printed circuit board is comprised of FR4 material. The board thickness is 1.66mm and the area is 174mm × 135mm.

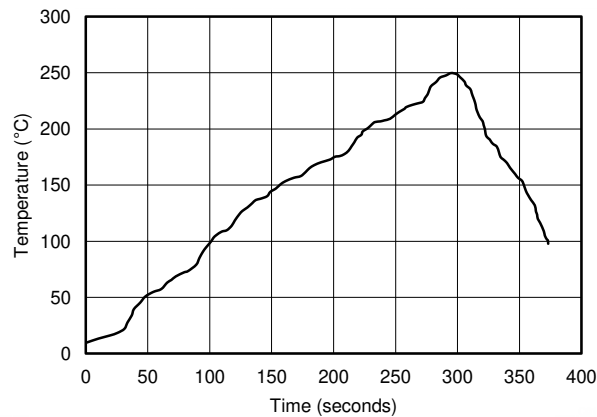

Figure 7-1. Reflow Profile

The reference output voltage is measured before and after the reflow process; [Figure 7-2](#) shows the typical shift. Although all tested units exhibit very low shifts (< 0.03%), higher shifts are also possible depending on the size, thickness, and material of the printed circuit board (PCB). An important note is that the histograms display the typical shift for exposure to a single reflow profile. Exposure to multiple reflows, as is common on PCBs with surface-mount components on both sides, causes additional shifts in the output bias voltage. If the PCB is exposed to multiple reflows, the device must be soldered in the last pass to minimize its exposure to thermal stress.

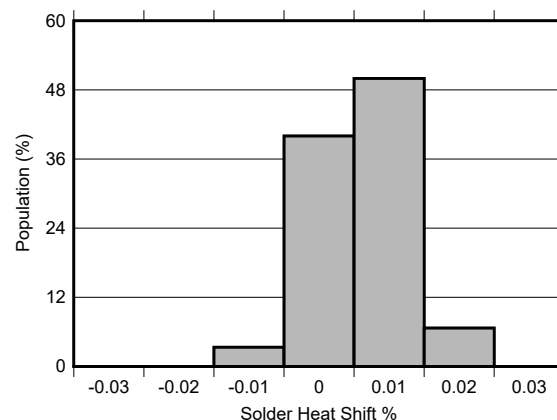

Figure 7-2. Solder Heat Shift Distribution, V_{REF} (%)

7.2 Temperature Coefficient

The REF35 is designed and tested for a low output voltage temperature coefficient. The temperature coefficient is defined as the change in output voltage over temperature. The temperature coefficient is calculated using the box method in which a box is formed by the minimum/maximum values for the nominal output voltage over the operating temperature range. REF35 has a low maximum temperature coefficient of 12ppm/°C from –40°C to +105°C. The box method specifies limits for the temperature error but does not specify the exact shape and slope of the device under test. Due to temperature curvature correction to achieve low-temperature drift, the temperature drift is expected to be non-linear. See TI's Analog Design Journal, [Precision voltage references](#), for more information on the box method. Use [Equation 1](#) for the box method.

$$\text{Drift} = \left(\frac{V_{\text{REF(MAX)}} - V_{\text{REF(MIN)}}}{V_{\text{REF(25}^\circ\text{C)}} \times \text{Temperature Range}} \right) \times 10^6 \quad (1)$$

[Figure 7-3](#) shows a typical voltage versus temperature curves for various reference voltages in SOT23 package. [Figure 7-4](#) shows the distribution of temperature coefficients for REF35250 devices in SOT23 package.

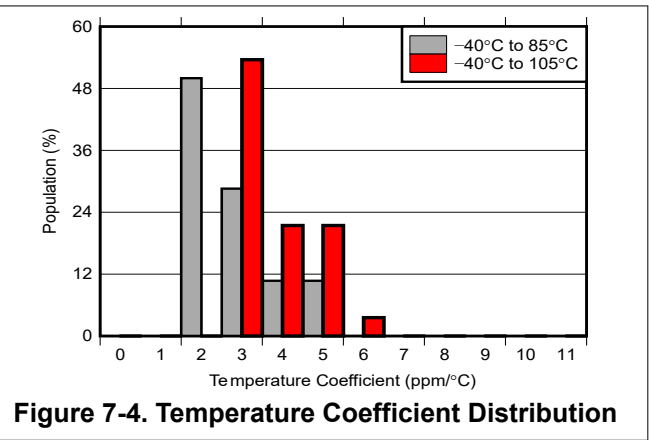
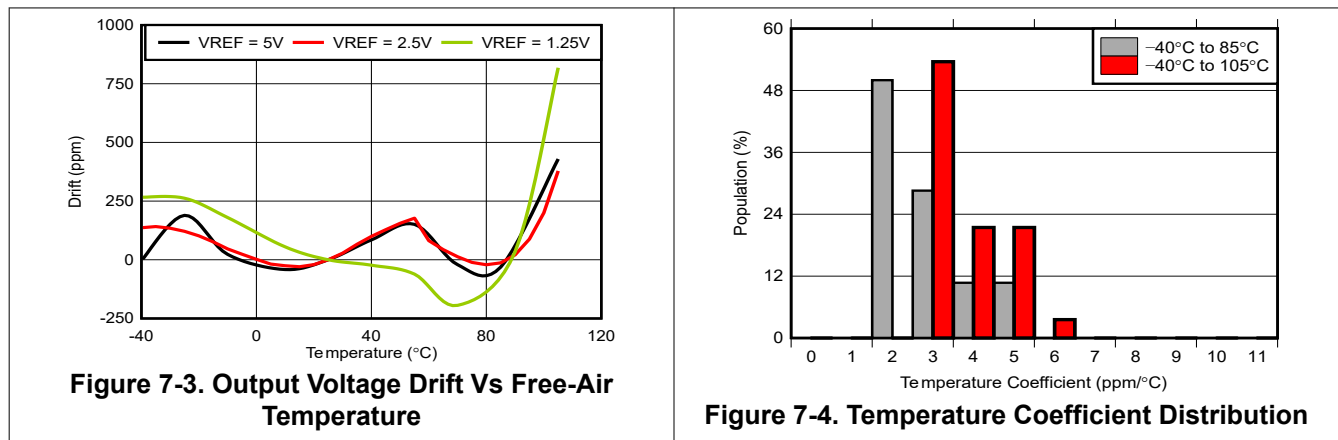

7.3 Long-Term Stability

One of the key performance parameters of the REF35 references is long-term stability also known as long-term drift. The long-term stability value is tested in a setup that reflects standard PCB board manufacturing practices. The boards are made of standard FR4 material and the board does not have special cuts or grooves around the devices to relieve the mechanical stress of the PCB. The devices and boards in this test do not undergo high temperature burn in post-soldering prior to testing. These conditions reflect a real world use case scenario and common manufacturing techniques.

During the long-term stability testing, precautions are taken to make sure that only the long-term stability drift is measured. The boards are maintained at 35°C in an oil bath. The oil bath makes sure that the temperature is constant across the device over time compared to an air oven. The measurements are captured every 30 minutes with a calibrated 8.5 digit multimeter.

The typical long-term stability characteristic is expressed as a deviation of the reference voltage output over time.

[Figure 7-5](#) shows that the typical drift value for the REF35 6-pin SOT-23 package is 40ppm from 0 to 1000 hours and 55ppm from 0 to 2000 hours. It is important to understand that long-term stability is not ensured by design and that the value is typical. The REF35 will experience the highest drift in the initial 1000 hr. Subsequent deviation is typically lower than first 1000 hr.

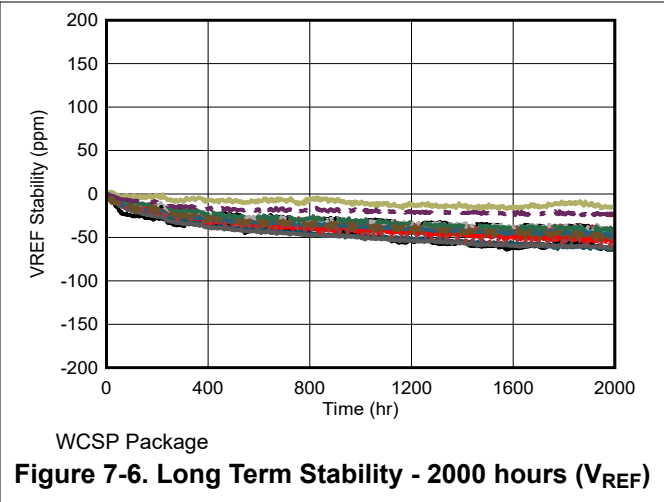
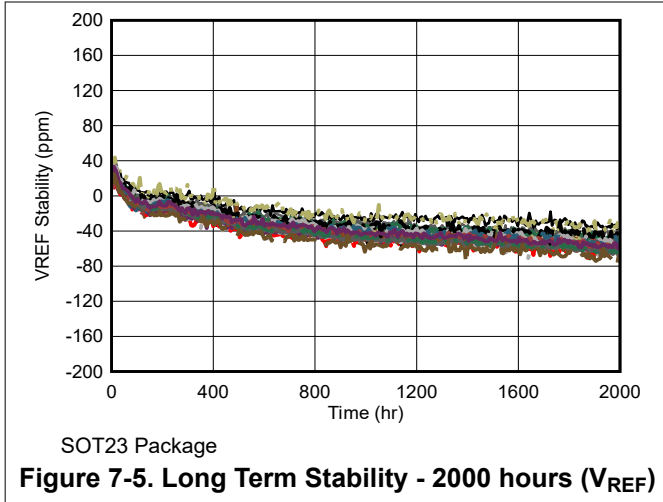

7.4 Thermal Hysteresis

Thermal hysteresis is measured with the REF35 soldered to a PCB, similar to a real-world application. Thermal hysteresis for the device is defined as the change in output voltage after operating the device at 25°C, cycling the device through the specified temperature range, and returning to 25°C. The PCB was baked at 150°C for 30 minutes before thermal hysteresis was measured. Use [Equation 2](#) to calculate the thermal hysteresis:

$$V_{HYST} = \left(\frac{|V_{PRE} - V_{POST}|}{V_{NOM}} \right) \times 10^6 \text{ (ppm)} \quad (2)$$

where

- V_{HYST} = thermal hysteresis (in units of ppm)
- V_{NOM} = the specified output voltage
- V_{PRE} = output voltage measured at 25°C pre-temperature cycling
- V_{POST} = output voltage measured after the device has cycled from 25°C through the specified temperature range of -40°C to +85°C or -40°C to +105°C and returns to 25°C.

The graphs below show the typical thermal hysteresis distribution across various temperature ranges in two cycles.

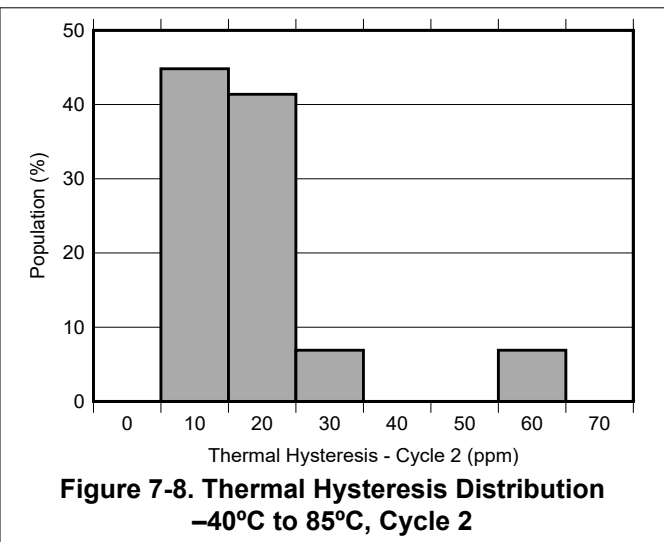
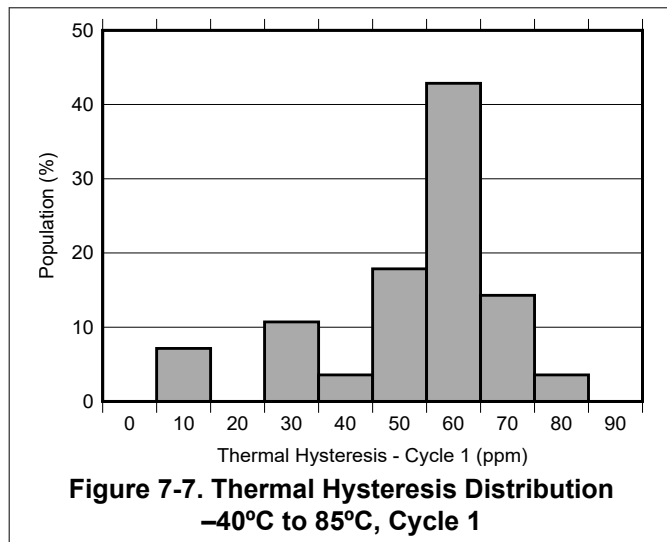

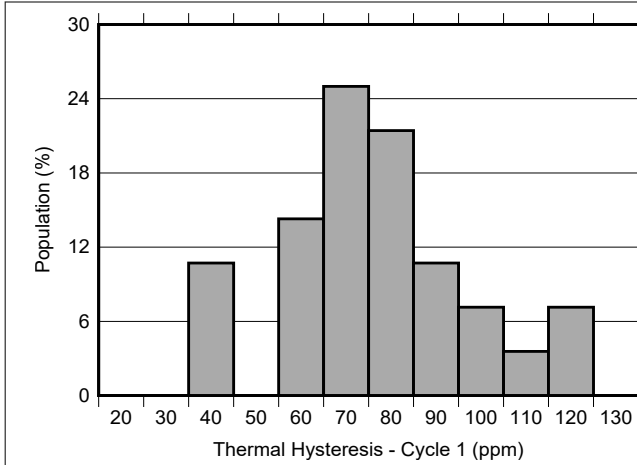

**Figure 7-9. Thermal Hysteresis Distribution
–40°C to 105°C, Cycle 1**

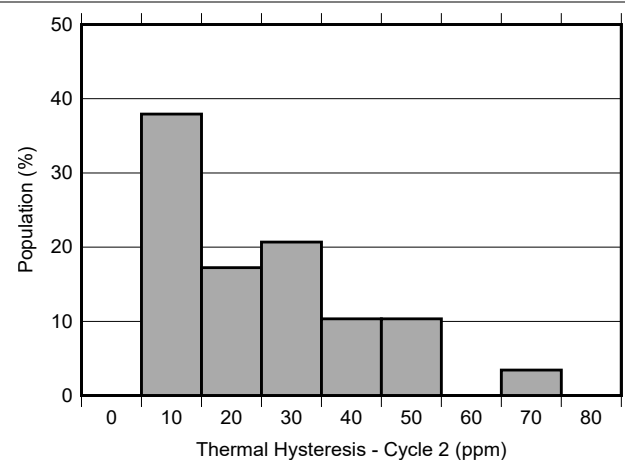

**Figure 7-10. Thermal Hysteresis Distribution
–40°C to 105°C, Cycle 2**

7.5 Noise Performance

The reference pin output noise is categorized as low frequency and broadband noise. The following sections describe these categories in detail.

7.5.1 Low-Frequency (1/f) Noise

Flicker noise, also known as 1/f noise, is a low-frequency noise that affects the device output voltage which can affect precision measurements in ADCs. This noise increases proportionally with output voltage and operating temperature. Noise is measured by filtering the output from 0.1Hz to 10Hz. The 1/f noise is an extremely low value, therefore the frequency of interest must be amplified and band-pass filtered. This is done by using a high-pass filter to block the DC voltage. The resulting noise is then amplified by a gain of 1000. The bandpass filter is created by a series of high-pass and low-pass filter that adds additional gain to make it more visible on an oscilloscope as shown in Figure 7-11. Figure 7-12 shows the effect of flicker noise over 10 second for REF35250. Flicker noise must be tested in a Faraday cage enclosure to block environmental noise.

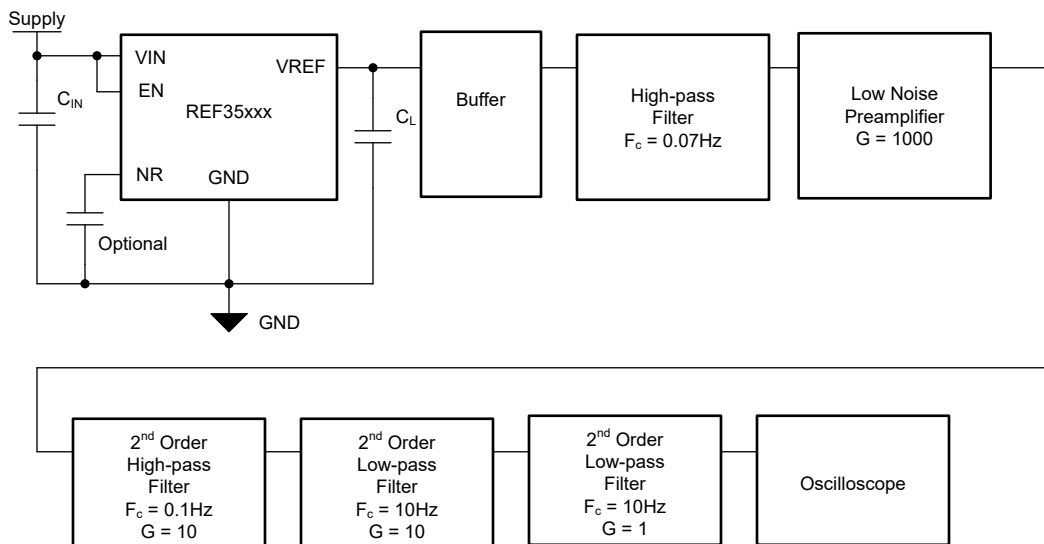

Figure 7-11. Low-Frequency (1/f) Noise Test Setup

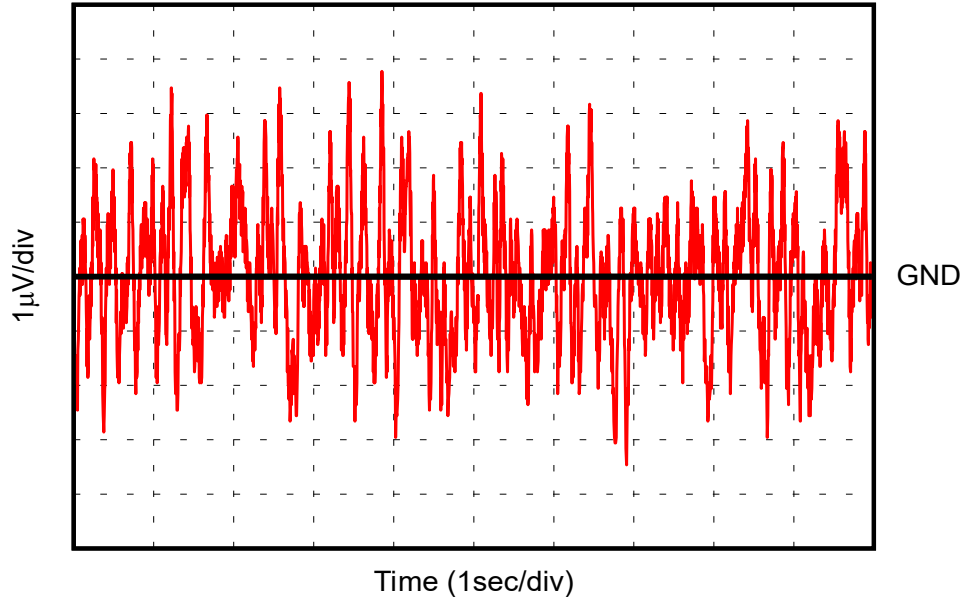

Figure 7-12. 0.1Hz to 10Hz Voltage Noise

Figure 7-13 shows the typical 1/f noise (0.1Hz to 10Hz) distribution across various load conditions. REF35 device also offers noise reduction functionality by adding an optional capacitor between NR (pin 5) and ground pins.

Figure 7-14 shows the typical 1/f noise (0.1Hz to 10Hz) distribution across REF35 devices with various capacitance between NR pin and GND.

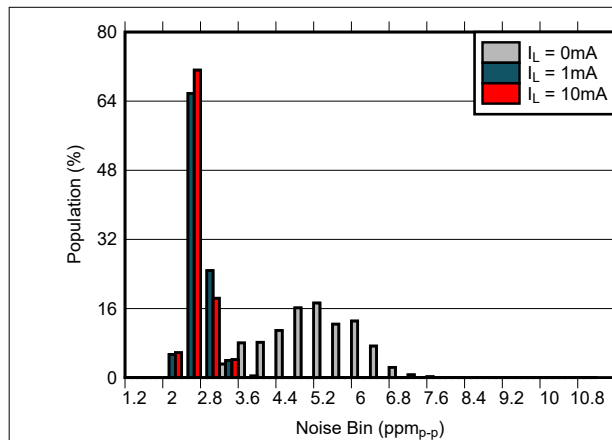

Figure 7-13. 0.1Hz to 10Hz Noise Distribution vs Load Conditions

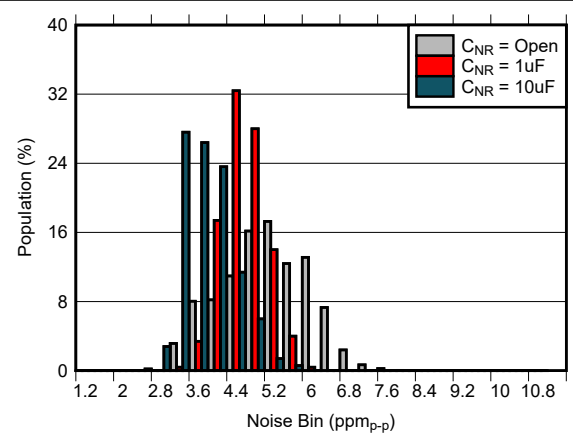

Figure 7-14. 0.1Hz to 10Hz Noise Distribution vs NR Capacitance

7.5.2 Broadband Noise

Broadband noise is a noise that appears at higher frequency compared to 1/f noise. The broadband noise is measured by high-pass filtering the output of the reference device, followed by a gain stage and measuring the result on a spectrum analyzer as shown in Figure 7-15.

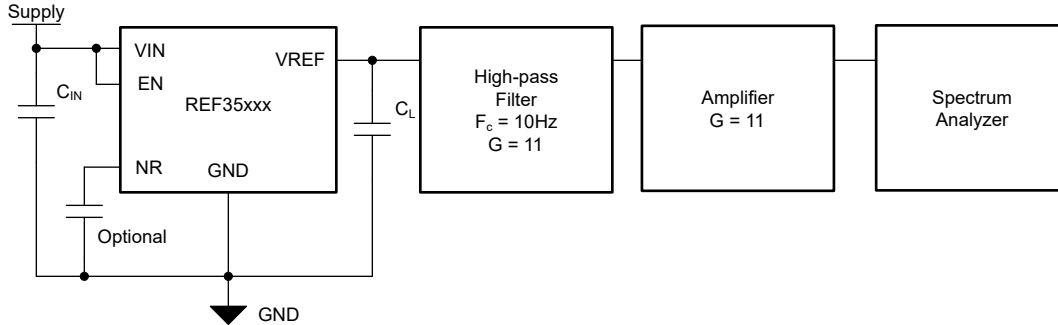

Figure 7-15. Broadband Noise Test Setup

For noise sensitive designs, a low-pass filter can be used to reduce broadband output noise. When designing a low-pass filter, take special care to make sure the output impedance of the filter does not degrade AC performance. This can occur in RC low-pass filters where a large series resistance can impact the load transients due to output current fluctuations. The REF35 device also offers noise reduction functionality by adding an optional capacitor between NR (pin 5) and ground pins. [Figure 7-16](#) and [Figure 7-17](#) show the noise spectrum for REF35250 and REF35500 devices respectively across various load capacitance.

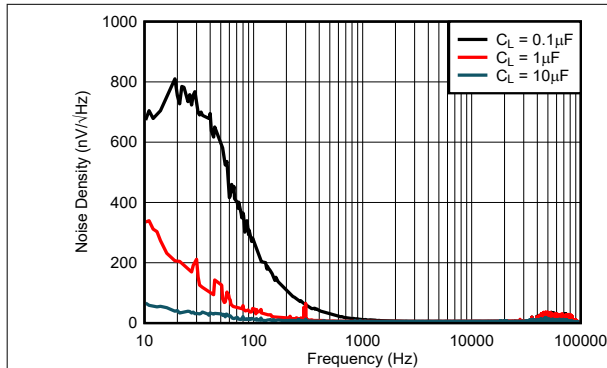

Figure 7-16. Noise Spectrum 10Hz to 100kHz ($V_{REF} = 2.5V$)

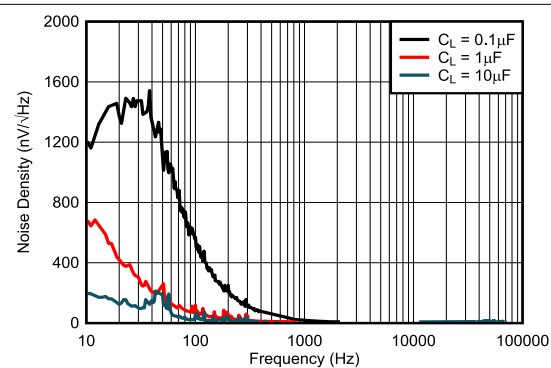

Figure 7-17. Noise Spectrum 10Hz to 100kHz ($V_{REF} = 5V$)

7.6 Power Dissipation

The REF35 voltage references are capable of source up to 10mA and sink up to 5mA of load current across the rated input voltage range. However, when used in applications subject to high ambient temperatures, the input voltage and load current must be carefully monitored to make sure that the device does not exceed its maximum power dissipation rating. The maximum power dissipation of the device can be calculated with [Equation 3](#):

$$T_J = T_A + P_D \times R_{\theta JA} \quad (3)$$

where

- P_D is the device power dissipation
- T_J is the device junction temperature
- T_A is the ambient temperature
- $R_{\theta JA}$ is the package (junction-to-air) thermal resistance

Because of this relationship, acceptable load current in high temperature conditions can be less than the maximum current-sourcing capability of the device. In no case must the device be operated outside of its maximum power rating because doing so can result in premature failure or permanent damage to the device.

8 Detailed Description

8.1 Overview

The REF35 is family of ultra-low current, low-noise, precision band-gap voltage references that are specifically designed for excellent initial voltage accuracy and drift. The [Functional Block Diagram](#) is a simplified block diagram of the REF35 showing basic band-gap topology.

8.2 Functional Block Diagram

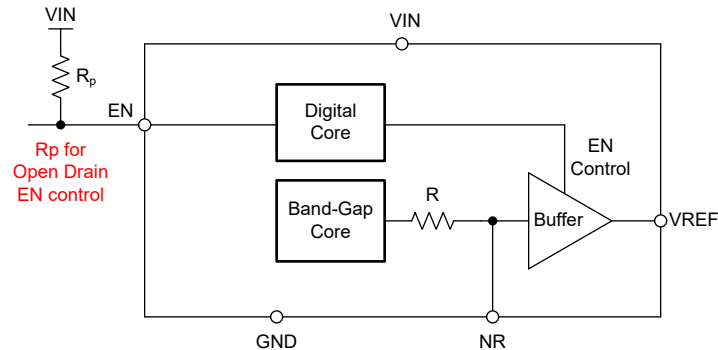

8.3 Feature Description

8.3.1 Supply Voltage

The REF35 family of references features an extremely low dropout voltage. For 10mA loaded conditions, a maximum dropout voltage is 250mV. [Figure 6-34](#) shows a typical dropout voltage (V_{DO}) versus load current. The device supports operation with input voltage range from $V_{REF} + V_{DO}$ to 6V. The typical quiescent current is 650nA and maximum quiescent current over temperature is only 2.6 μ A. The low dropout voltage coupled with ultra-low current enable the operation across multiple battery powered applications.

8.3.2 EN Pin

The REF35 family supports device enable and disable functionality through logic level control on EN pin. The EN pin of REF35 does not use an internal pull-up resistor. Instead, the pin uses new 'clean EN' technology. This allows the EN pin to be in a no connect condition at start-up, and no extra current is drawn from the supply when the EN pin is pulled low in shutdown mode. When EN pin is pulled high or left unconnected at start-up, the device is in active mode. When EN pin is driven by an open-drain output, a pull-up resistor to V_{IN} is required. The device must be in active mode for normal operation. The EN pin must not be pulled higher than V_{IN} supply voltage.

The device can be placed in shutdown mode by pulling the EN pin low. When in shutdown mode, the output of the device becomes high impedance and the quiescent current of the device drops to 100nA at room temperature. When changing the device state from shutdown to active state, make sure the EN pin is not left floating.

Also note that for applications where EN pin is no-connect, total parasitic capacitance on EN pin must be restricted within 30pF.

See the [Electrical Characteristics](#) table for logic high and logic low voltage levels.

8.3.3 NR Pin

The REF35 pin allows access to the band-gap through the NR pin. Placing a capacitor from the NR pin to GND creates a low-pass filter in combination with the internal resistance of 60 k Ω . Leakage of the capacitance directly impacts the accuracy and temperature drift. If NR functionality is used, choose a low leakage capacitor. A capacitance of 1 μ F creates a low-pass filter with corner frequency around 2.7Hz. Such a filter decreases the overall noise on the VREF pin. Higher capacitance results in a lower filter cut off frequency, further reducing output noise. Please note, using the capacitor on NR pin also increases start-up time.

8.4 Device Functional Modes

8.4.1 Basic Connections

Figure 8-1 shows the typical connections for the REF35. TI recommends a supply bypass capacitor (C_{IN}) ranging from 0.1 μ F to 10 μ F. A 0.1 μ F to 10 μ F output capacitor (C_L) must be connected from REF to GND. The equivalent series resistance (ESR) value of C_L must be lower than 400m Ω to verify output stability.

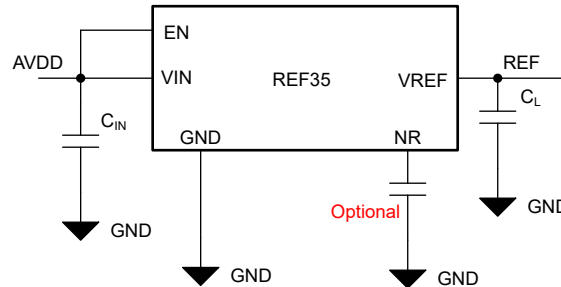

Figure 8-1. Basic Connections

8.4.2 Start-Up

Figure 8-2 shows the start-up behavior of REF35250 device with 1 μ F load capacitance. REF35 device verifies the output voltage settles to the expected output voltage within specified accuracy without oscillations. The start-up time is dependent on the output voltage variant, output capacitance and NR pin capacitance. Higher capacitance leads to longer start-up time.

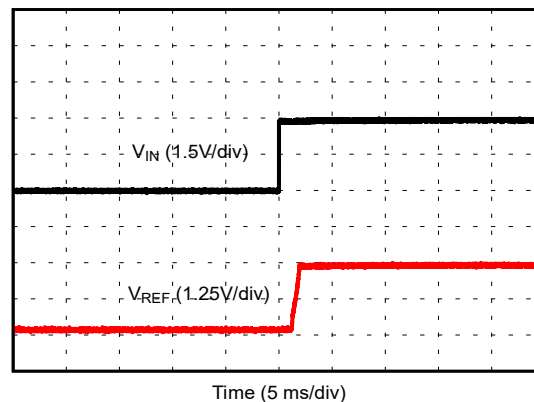
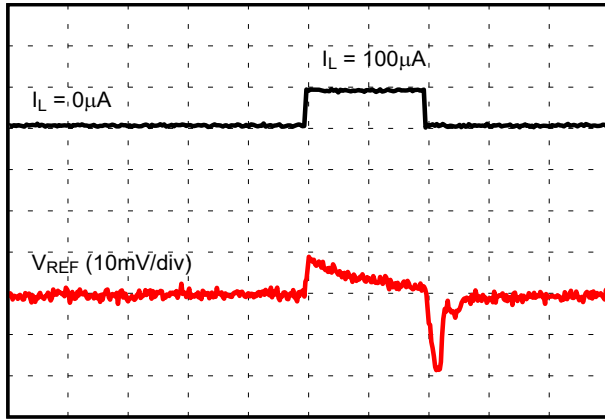

Figure 8-2. REF35250 Start-Up Behavior, $C_L = 1\mu$ F

8.4.3 Output Transient Behavior

The REF35 output buffer is capable of sourcing 10mA load current as well as sink 5mA of load current. The output stage is designed using class AB architecture with ultra-low quiescent current. This architecture avoids the dead zone around the no load condition. The output buffer uses a fast start-up implementation to achieve 2ms typical turn-on time at $C_L = 1\mu$ F and no-load current condition.

Figure 8-3 and Figure 8-4 show the output settling behavior for light load transient and high load transient respectively.



Time (1ms/div)

Figure 8-3. Load Transient Response 0µA to 100µA, C_L = 1µF

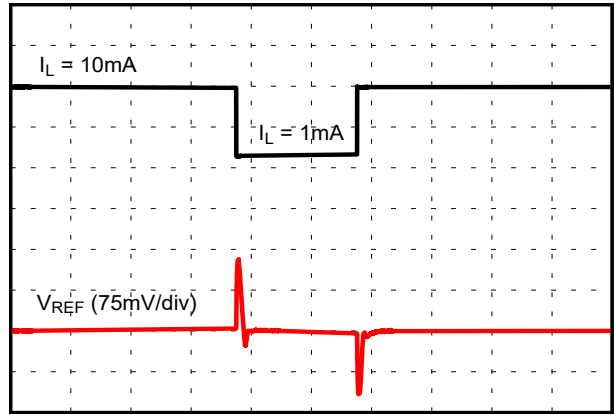

Time (1ms/div)

Figure 8-4. Load Transient Response 1mA to 10mA, C_L = 1µF

9 Application and Implementation

Note

Information in the following applications sections is not part of the TI component specification, and TI does not warrant its accuracy or completeness. TI's customers are responsible for determining suitability of components for their purposes. Customers should validate and test their design implementation to confirm system functionality.

9.1 Application Information

REF35 with low current consumption and class leading performance specifications is suitable reference for multiple applications. The device can also be used as a precision low noise power supply to sensor or data converter instead of traditional LDO or DC/DC based power supply. Basic applications includes positive/negative voltage reference and data acquisition systems. The table below shows the typical application of REF35 and its companion ADC/DAC.

Table 9-1. Typical Applications and Companion ADC/DAC

APPLICATIONS	ADC/DAC
PLC - DCS	ADS7028, DAC8881, ADS1287, ADS7953
Rack Server	ADS7028, ADS7128, ADS7138
Field Transmitters - Pressure, Flow	ADS124S08
Optical Module, Optical Line Card	ADS7066, ADS7138
Power quality analyzer	ADC3662
Thermal imaging	ADC3541

9.2 Typical Applications

9.2.1 Negative Reference Voltage

For applications requiring a negative and positive reference voltage, the REF35 and OPA735 can be used to provide a dual-supply reference from a 5V supply. [Figure 9-1](#) shows the REF35250 used to provide a 2.5V supply reference voltage. The low drift performance of the REF35250 complements the low offset voltage and zero drift of the OPA735 to provide an accurate solution for split-supply applications. Take care to match the temperature coefficients of R1 and R2.

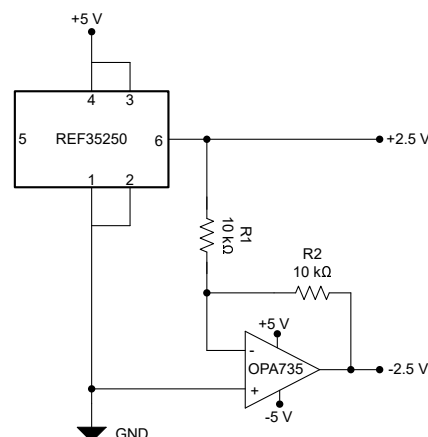

Figure 9-1. REF35 and OPA735 Create Positive and Negative Reference Voltages

9.2.2 Precision Power Supply and Reference

Figure 9-2 shows the basic configuration for the REF35 device as precision power supply to ADS7038 data converter which uses its power supply AVDD as reference. Connect bypass capacitors according to the guidelines in the *Input and Output Capacitors* section.

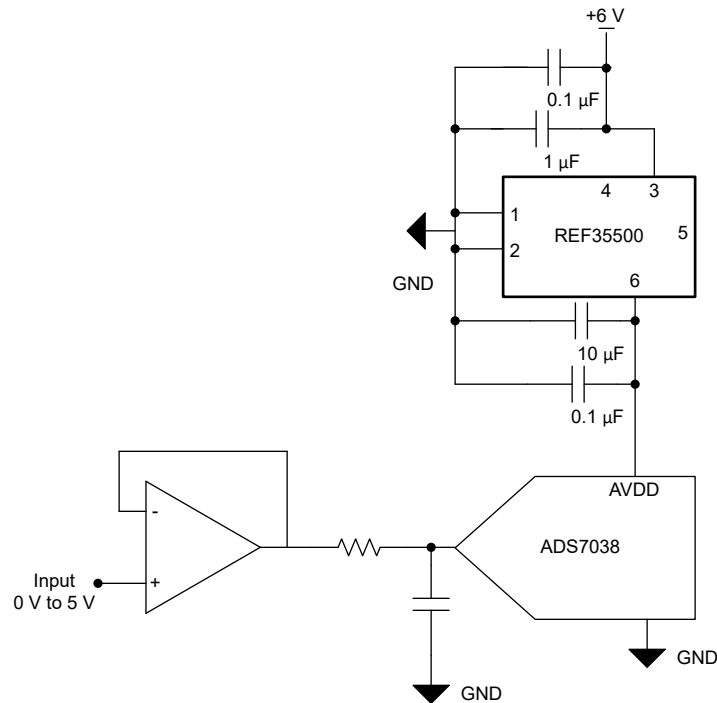

Figure 9-2. Basic Reference Connection

9.2.2.1 Design Requirements

A detailed design procedure is described based on a design example. For this design example, use the parameters listed in Table 9-2 as the input parameters.

Table 9-2. Design Example Parameters

DESIGN PARAMETER	VALUE
Input voltage range V_{IN}	0V - 5V
Output resolution	12-bit
REF35 input capacitor	1µF
REF35 output capacitor	10µF

9.2.2.2 Detailed Design Procedure

9.2.2.2.1 Selection of Reference

The REF35500 reference is selected for this design. The REF35500 device operates of very low quiescent current while offering $\pm 0.05\%$ initial accuracy and very low noise. These parameters help improve system accuracy as compared to external LDO based power supply. The 5V reference voltage supports the 0V to 5V input range specification.

9.2.2.2.2 Input and Output Capacitors

A 1µF to 10µF electrolytic or ceramic capacitor can be connected to the input to improve transient response in applications where the supply voltage may fluctuate.

A ceramic capacitor of at least a 0.1µF must be connected to the output to improve stability and help filter out high frequency noise. Add an additional 10µF capacitor in parallel to improve transient performance in response to sudden changes in load current; however, keep in mind that doing so increases the start-up time of the device.

Best performance and stability is attained with low-ESR, low-inductance ceramic chip-type output capacitors (X5R, X7R, or similar). If using an electrolytic capacitor on the output, place a 0.1µF ceramic capacitor in parallel to reduce overall ESR on the output. Place the input and output capacitors as close as possible to the device.

9.2.2.2.3 Selection of ADC

[ADS7038](#) 12-bit 8 channel multiplexed ADC is chosen for this application. The ADC offers low current operation with averaging mode to increase the resolution to 16-bit with internal averaging modes while operating with slow sampling speed.

9.2.2.3 Application Curves

[Table 9-3](#) and [Figure 9-3](#) show the captured measurement results for various DC inputs. The ADC output is captured and analyzed for output accuracy error and code spread with REF35500 as power supply versus LDO as power supply.

REF35 offers better accuracy and lower noise than the LDO device at lower quiescent current. This results in lower error in measurement as well as lower ADC output code variation across various OSR settings.

Table 9-3. DC Input Performance Test Results

INPUT V	ADC OSR SETTING	REF35500		LDO	
		ERROR	CODE SPREAD	ERROR	CODE SPREAD
1.0V	0	0.01mV	32 LSB	8.9mV	48 LSB
	8	0.3mV	10 LSB	9.21mV	16 LSB
	128	0.38mV	6 LSB	9.26mV	6 LSB
2.5V	0	0.69mV	32 LSB	22.89mV	64 LSB
	8	1.44mV	10 LSB	23.63mV	18 LSB
	128	1.17mV	3 LSB	23.41mV	5 LSB
4V	0	2.27mV	32 LSB	37.84mV	48 LSB
	8	3.01mV	24 LSB	38.62mV	24 LSB
	128	2.46mV	3 LSB	38.09mV	17 LSB

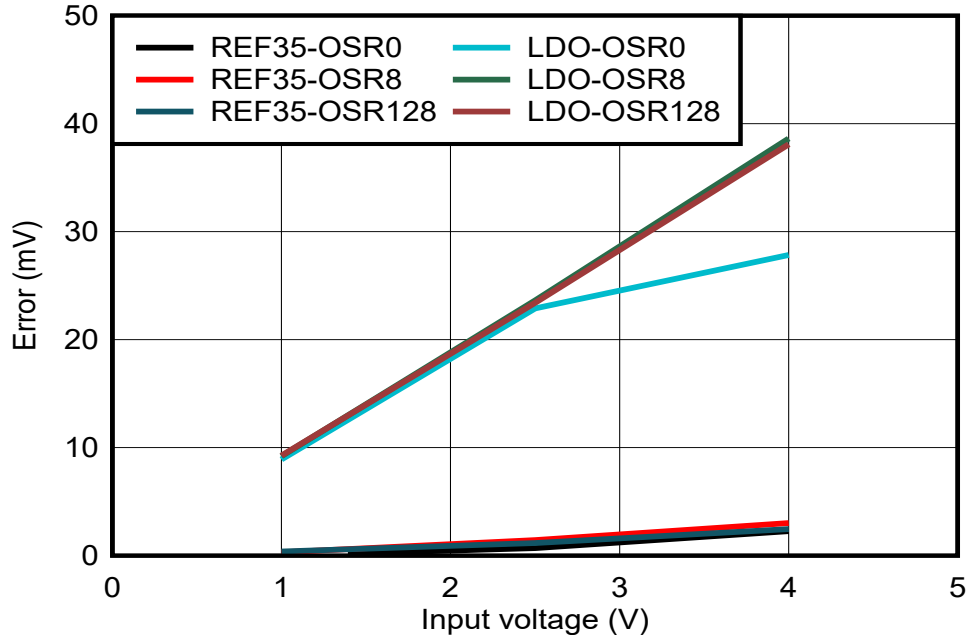

Figure 9-3. Error vs Input Voltage

9.3 Power Supply Recommendations

The REF35 family of references feature an extremely low-dropout voltage. These references can be operated with a supply of only 50mV above the output voltage at no load. TI recommends a supply bypass capacitor ranging between 0.1µF to 10µF.

9.4 Layout

9.4.1 Layout Guidelines

Figure 9-4 shows an example of a PCB layout for a data acquisition system using the REF35. Some key considerations are:

- Connect low-ESR, 0.1µF ceramic bypass capacitors at V_{IN} , V_{REF} of the REF35.
- Decouple other active devices in the system per the device specifications.
- Using a solid ground plane helps distribute heat and reduces electromagnetic interference (EMI) noise pickup.
- Place the external components as close to the device as possible.
- Do not run sensitive analog traces in parallel with digital traces. Avoid crossing digital and analog traces if possible, and only make perpendicular crossings when absolutely necessary.

Figure 9-5 shows the pin compatibility with TI REF30xx, REF31xx and REF33xx series references in the 3-pin SOT-23 package when using the REF35xxx family footprint. You must rotate the REF30xx, REF31xx and REF33xx reference devices by 180° before assembly.

9.4.2 Layout Examples

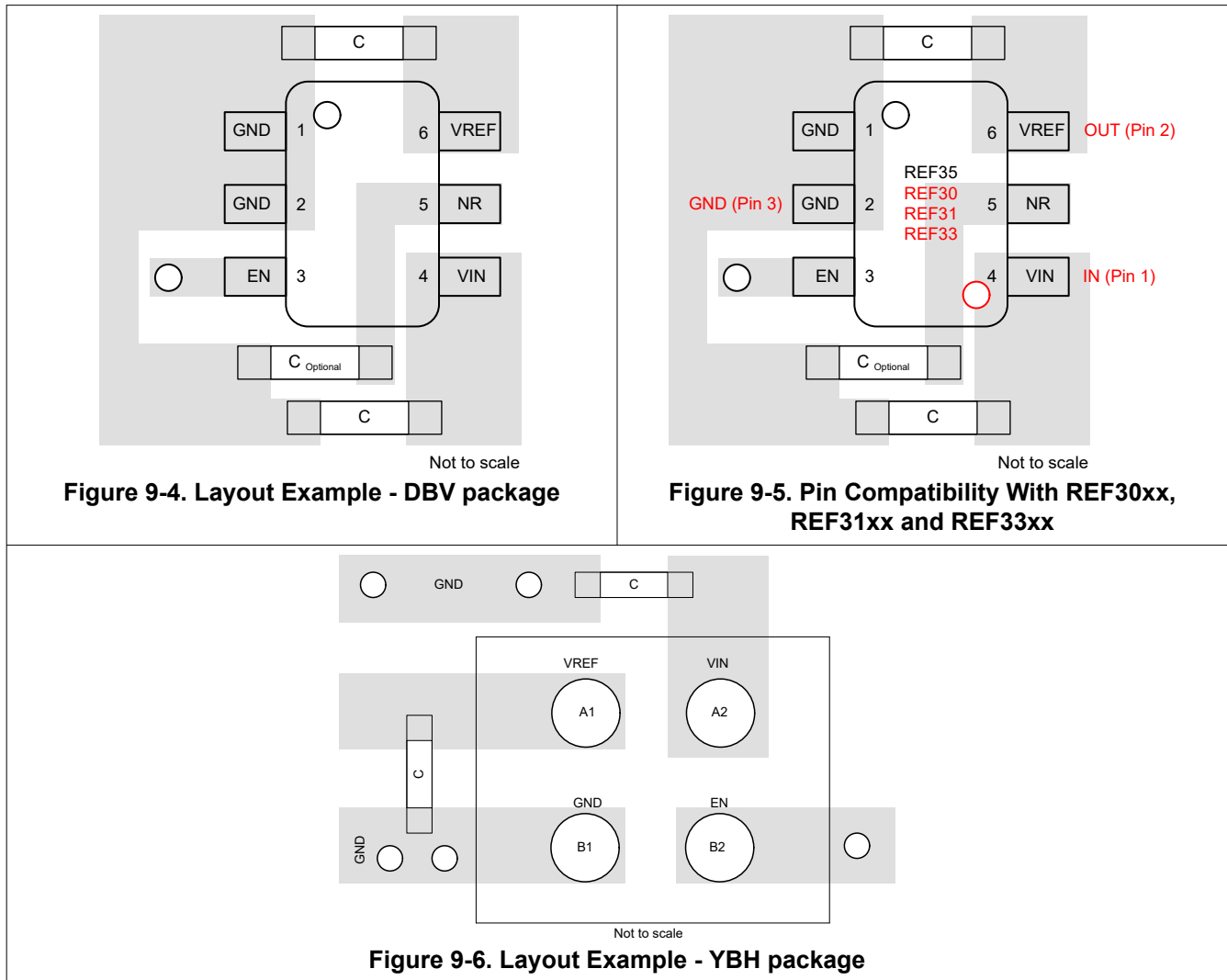

10 Device and Documentation Support

10.1 Documentation Support

10.1.1 Related Documentation

For related documentation see the following:

- Texas Instruments, [INA21x Voltage Output, Low- or High-Side Measurement, Bidirectional, Zero-Drift Series, Current-Shunt Monitors data sheet](#)
- Texas Instruments, [Low-Drift Bidirectional Single-Supply Low-Side Current Sensing Reference Design](#)
- Texas Instruments, [Precision voltage references Analog Design Journal](#)

10.2 Receiving Notification of Documentation Updates

To receive notification of documentation updates, navigate to the device product folder on [ti.com](#). Click on *Notifications* to register and receive a weekly digest of any product information that has changed. For change details, review the revision history included in any revised document.

10.3 Support Resources

[TI E2E™ support forums](#) are an engineer's go-to source for fast, verified answers and design help — straight from the experts. Search existing answers or ask your own question to get the quick design help you need.

Linked content is provided "AS IS" by the respective contributors. They do not constitute TI specifications and do not necessarily reflect TI's views; see TI's [Terms of Use](#).

10.4 Trademarks

TI E2E™ is a trademark of Texas Instruments.
All trademarks are the property of their respective owners.

10.5 Electrostatic Discharge Caution



This integrated circuit can be damaged by ESD. Texas Instruments recommends that all integrated circuits be handled with appropriate precautions. Failure to observe proper handling and installation procedures can cause damage.

ESD damage can range from subtle performance degradation to complete device failure. Precision integrated circuits may be more susceptible to damage because very small parametric changes could cause the device not to meet its published specifications.

10.6 Glossary

[TI Glossary](#) This glossary lists and explains terms, acronyms, and definitions.

11 Revision History

NOTE: Page numbers for previous revisions may differ from page numbers in the current version.

Changes from Revision B (April 2024) to Revision C (September 2024)	Page
• Updated YBH Package dimensions.....	30

Changes from Revision A (August 2022) to Revision B (April 2024)	Page
• Added features description for WCSP package.....	1
• Removed product preview status for WCSP package.....	1
• Added REF35170QBVR & REF35360QDBVR devices as released variant. Updated the WCSP device release options.....	3
• Added more details to device pin external connections.....	3
• Added YBH package performance details.....	6
• Added typical characteristics for WCSP package.....	8

Changes from Revision * (December 2021) to Revision A (August 2022)	Page
• Production data release.....	1

12 Mechanical, Packaging, and Orderable Information

The following pages include mechanical packaging and orderable information. This information is the most current data available for the designated devices. This data is subject to change without notice and revision of this document. For browser-based versions of this data sheet, refer to the left-hand navigation.

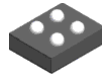

YBH0004-C01

PACKAGE OUTLINE
DSBGA - 0.4 mm max height

DIE SIZE BALL GRID ARRAY

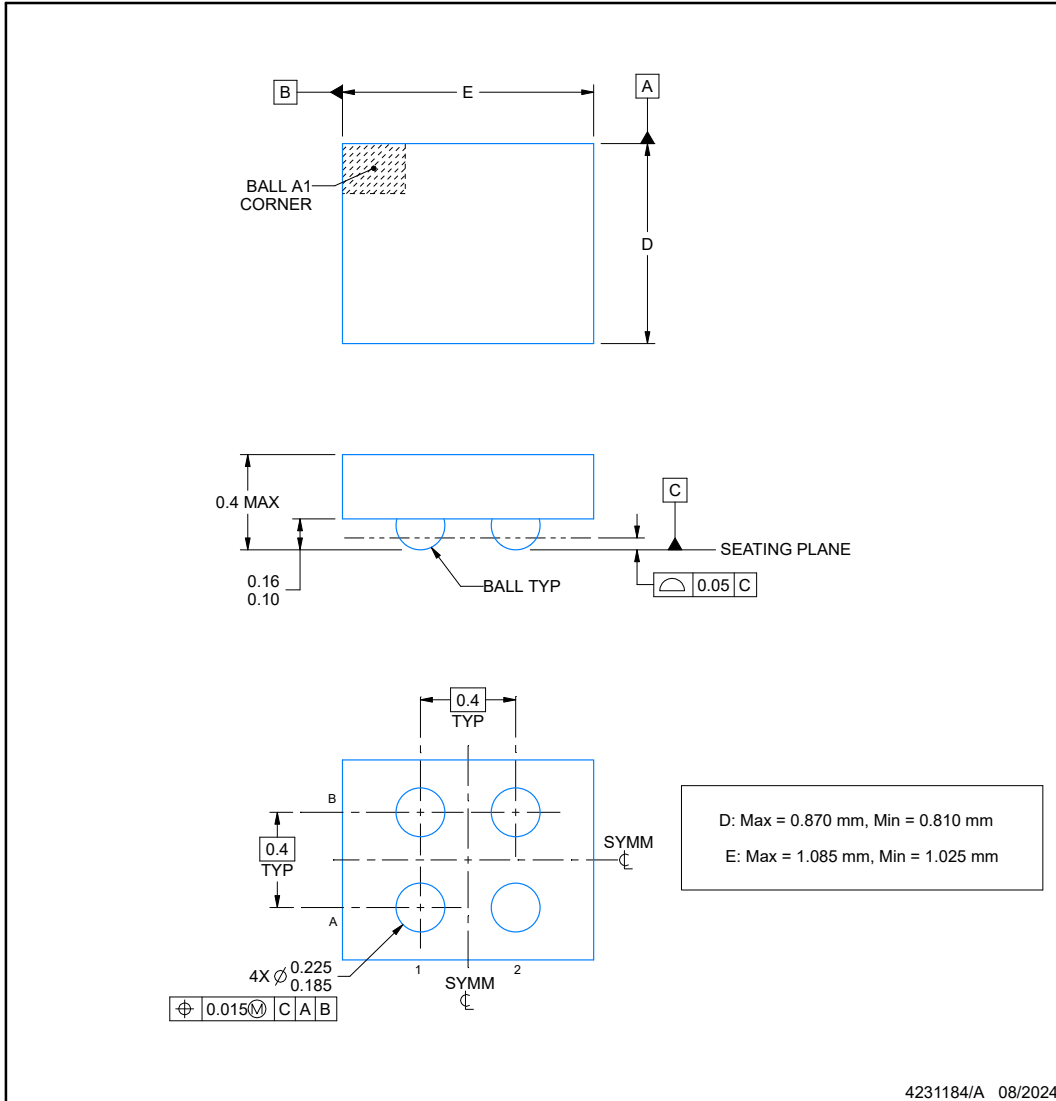

NOTES:

1. All linear dimensions are in millimeters. Any dimensions in parenthesis are for reference only. Dimensioning and tolerancing per ASME Y14.5M.
2. This drawing is subject to change without notice.

EXAMPLE BOARD LAYOUT

YBH0004-C01

DSBGA - 0.4 mm max height

DIE SIZE BALL GRID ARRAY

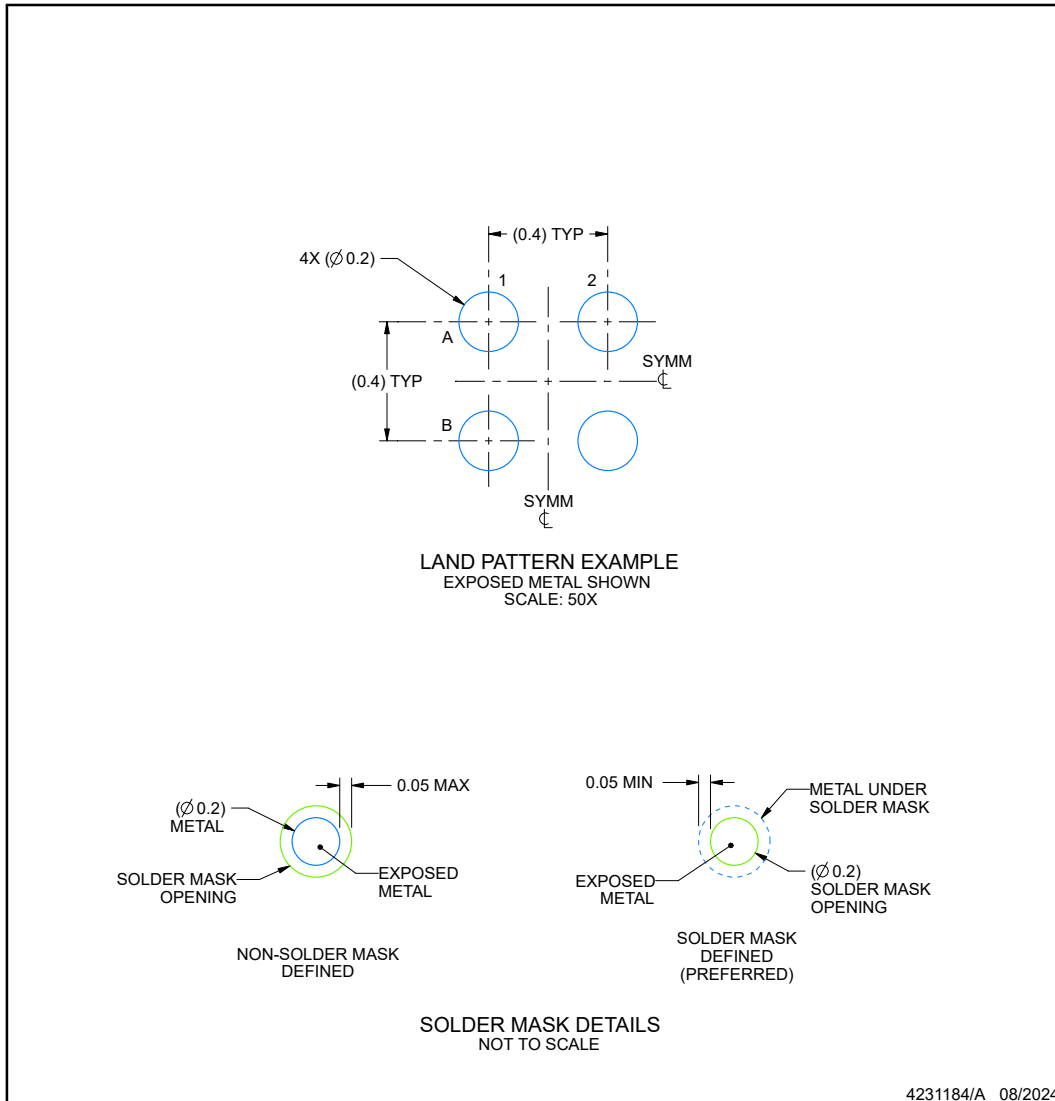

NOTES: (continued)

- Final dimensions may vary due to manufacturing tolerance considerations and also routing constraints. See Texas Instruments Literature No. SNVA009 (www.ti.com/lit/snva009).

EXAMPLE STENCIL DESIGN

YBH0004-C01

DSBGA - 0.4 mm max height

DIE SIZE BALL GRID ARRAY

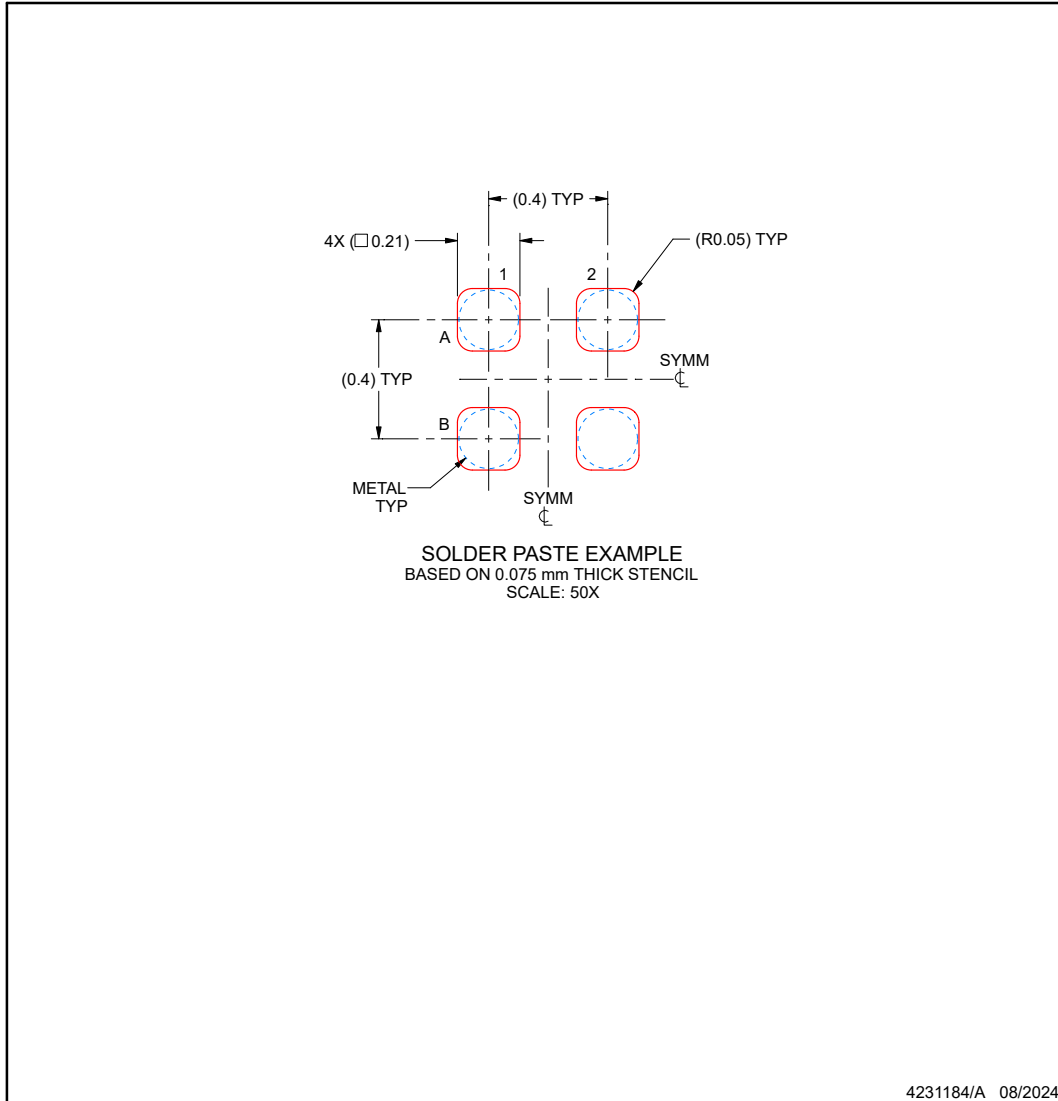

NOTES: (continued)

- 4. Laser cutting apertures with trapezoidal walls and rounded corners may offer better paste release.

PACKAGING INFORMATION

Orderable part number	Status (1)	Material type (2)	Package Pins	Package qty Carrier	RoHS (3)	Lead finish/ Ball material (4)	MSL rating/ Peak reflow (5)	Op temp (°C)	Part marking (6)
REF35102QDBVR	Active	Production	SOT-23 (DBV) 6	3000 LARGE T&R	Yes	NIPDAUAG	Level-2-260C-1 YEAR	-40 to 125	2RTI
REF35102QDBVR.A	Active	Production	SOT-23 (DBV) 6	3000 LARGE T&R	Yes	NIPDAUAG	Level-2-260C-1 YEAR	-40 to 125	2RTI
REF35102YBHR	Active	Production	DSBGA (YBH) 4	12000 LARGE T&R	Yes	SNAGCU	Level-1-260C-UNLIM	-40 to 125	M
REF35102YBHR.A	Active	Production	DSBGA (YBH) 4	12000 LARGE T&R	Yes	SNAGCU	Level-1-260C-UNLIM	-40 to 125	M
REF35120QDBVR	Active	Production	SOT-23 (DBV) 6	3000 LARGE T&R	Yes	NIPDAUAG	Level-2-260C-1 YEAR	-40 to 125	2RVI
REF35120QDBVR.A	Active	Production	SOT-23 (DBV) 6	3000 LARGE T&R	Yes	NIPDAUAG	Level-2-260C-1 YEAR	-40 to 125	2RVI
REF35120YBHR	Active	Production	DSBGA (YBH) 4	12000 LARGE T&R	Yes	SNAGCU	Level-1-260C-UNLIM	-40 to 125	A
REF35120YBHR.A	Active	Production	DSBGA (YBH) 4	12000 LARGE T&R	Yes	SNAGCU	Level-1-260C-UNLIM	-40 to 125	A
REF35125QDBVR	Active	Production	SOT-23 (DBV) 6	3000 LARGE T&R	Yes	NIPDAUAG	Level-2-260C-1 YEAR	-40 to 125	2RUI
REF35125QDBVR.A	Active	Production	SOT-23 (DBV) 6	3000 LARGE T&R	Yes	NIPDAUAG	Level-2-260C-1 YEAR	-40 to 125	2RUI
REF35125YBHR	Active	Production	DSBGA (YBH) 4	12000 LARGE T&R	Yes	SNAGCU	Level-1-260C-UNLIM	-40 to 125	L
REF35125YBHR.A	Active	Production	DSBGA (YBH) 4	12000 LARGE T&R	Yes	SNAGCU	Level-1-260C-UNLIM	-40 to 125	L
REF35160QDBVR	Active	Production	SOT-23 (DBV) 6	3000 LARGE T&R	Yes	NIPDAUAG	Level-2-260C-1 YEAR	-40 to 125	2UII
REF35160QDBVR.A	Active	Production	SOT-23 (DBV) 6	3000 LARGE T&R	Yes	NIPDAUAG	Level-2-260C-1 YEAR	-40 to 125	2UII
REF35160YBHR	Active	Production	DSBGA (YBH) 4	12000 LARGE T&R	Yes	SNAGCU	Level-1-260C-UNLIM	-40 to 125	C
REF35160YBHR.A	Active	Production	DSBGA (YBH) 4	12000 LARGE T&R	Yes	SNAGCU	Level-1-260C-UNLIM	-40 to 125	C
REF35170QDBVR	Active	Production	SOT-23 (DBV) 6	3000 LARGE T&R	Yes	NIPDAUAG	Level-2-260C-1 YEAR	-40 to 125	31QI
REF35170QDBVR.A	Active	Production	SOT-23 (DBV) 6	3000 LARGE T&R	Yes	NIPDAUAG	Level-2-260C-1 YEAR	-40 to 125	31QI
REF35180QDBVR	Active	Production	SOT-23 (DBV) 6	3000 LARGE T&R	Yes	NIPDAUAG	Level-2-260C-1 YEAR	-40 to 125	2J2I
REF35180QDBVR.A	Active	Production	SOT-23 (DBV) 6	3000 LARGE T&R	Yes	NIPDAUAG	Level-2-260C-1 YEAR	-40 to 125	2J2I
REF35180YBHR	Active	Production	DSBGA (YBH) 4	12000 LARGE T&R	Yes	SNAGCU	Level-1-260C-UNLIM	-40 to 125	9
REF35180YBHR.A	Active	Production	DSBGA (YBH) 4	12000 LARGE T&R	Yes	SNAGCU	Level-1-260C-UNLIM	-40 to 125	9
REF35205QDBVR	Active	Production	SOT-23 (DBV) 6	3000 LARGE T&R	Yes	NIPDAUAG	Level-2-260C-1 YEAR	-40 to 125	2UKI
REF35205QDBVR.A	Active	Production	SOT-23 (DBV) 6	3000 LARGE T&R	Yes	NIPDAUAG	Level-2-260C-1 YEAR	-40 to 125	2UKI
REF35250QDBVR	Active	Production	SOT-23 (DBV) 6	3000 LARGE T&R	Yes	NIPDAUAG	Level-2-260C-1 YEAR	-40 to 125	2RSI
REF35250QDBVR.A	Active	Production	SOT-23 (DBV) 6	3000 LARGE T&R	Yes	NIPDAUAG	Level-2-260C-1 YEAR	-40 to 125	2RSI
REF35250YBHR	Active	Production	DSBGA (YBH) 4	12000 LARGE T&R	Yes	SNAGCU	Level-1-260C-UNLIM	-40 to 125	B
REF35250YBHR.A	Active	Production	DSBGA (YBH) 4	12000 LARGE T&R	Yes	SNAGCU	Level-1-260C-UNLIM	-40 to 125	B
REF35300QDBVR	Active	Production	SOT-23 (DBV) 6	3000 LARGE T&R	Yes	NIPDAUAG	Level-2-260C-1 YEAR	-40 to 125	2SLI

Orderable part number	Status (1)	Material type (2)	Package Pins	Package qty Carrier	RoHS (3)	Lead finish/ Ball material (4)	MSL rating/ Peak reflow (5)	Op temp (°C)	Part marking (6)
REF35300QDBVR.A	Active	Production	SOT-23 (DBV) 6	3000 LARGE T&R	Yes	NIPDAUAG	Level-2-260C-1 YEAR	-40 to 125	2SLI
REF35300YBHR	Active	Production	DSBGA (YBH) 4	12000 LARGE T&R	Yes	SNAGCU	Level-1-260C-UNLIM	-40 to 125	S
REF35300YBHR.A	Active	Production	DSBGA (YBH) 4	12000 LARGE T&R	Yes	SNAGCU	Level-1-260C-UNLIM	-40 to 125	S
REF35330QDBVR	Active	Production	SOT-23 (DBV) 6	3000 LARGE T&R	Yes	NIPDAUAG	Level-2-260C-1 YEAR	-40 to 125	2ULI
REF35330QDBVR.A	Active	Production	SOT-23 (DBV) 6	3000 LARGE T&R	Yes	NIPDAUAG	Level-2-260C-1 YEAR	-40 to 125	2ULI
REF35360QDBVR	Active	Production	SOT-23 (DBV) 6	3000 LARGE T&R	Yes	NIPDAUAG	Level-2-260C-1 YEAR	-40 to 125	31RI
REF35360QDBVR.A	Active	Production	SOT-23 (DBV) 6	3000 LARGE T&R	Yes	NIPDAUAG	Level-2-260C-1 YEAR	-40 to 125	31RI
REF35409QDBVR	Active	Production	SOT-23 (DBV) 6	3000 LARGE T&R	Yes	NIPDAUAG	Level-2-260C-1 YEAR	-40 to 125	2UMI
REF35409QDBVR.A	Active	Production	SOT-23 (DBV) 6	3000 LARGE T&R	Yes	NIPDAUAG	Level-2-260C-1 YEAR	-40 to 125	2UMI
REF35409YBHR	Active	Production	DSBGA (YBH) 4	12000 LARGE T&R	Yes	SNAGCU	Level-1-260C-UNLIM	-40 to 125	T
REF35409YBHR.A	Active	Production	DSBGA (YBH) 4	12000 LARGE T&R	Yes	SNAGCU	Level-1-260C-UNLIM	-40 to 125	T
REF35500QDBVR	Active	Production	SOT-23 (DBV) 6	3000 LARGE T&R	Yes	NIPDAUAG	Level-2-260C-1 YEAR	-40 to 125	2RWI
REF35500QDBVR.A	Active	Production	SOT-23 (DBV) 6	3000 LARGE T&R	Yes	NIPDAUAG	Level-2-260C-1 YEAR	-40 to 125	2RWI

(1) **Status:** For more details on status, see our [product life cycle](#).

(2) **Material type:** When designated, preproduction parts are prototypes/experimental devices, and are not yet approved or released for full production. Testing and final process, including without limitation quality assurance, reliability performance testing, and/or process qualification, may not yet be complete, and this item is subject to further changes or possible discontinuation. If available for ordering, purchases will be subject to an additional waiver at checkout, and are intended for early internal evaluation purposes only. These items are sold without warranties of any kind.

(3) **RoHS values:** Yes, No, RoHS Exempt. See the [TI RoHS Statement](#) for additional information and value definition.

(4) **Lead finish/Ball material:** Parts may have multiple material finish options. Finish options are separated by a vertical ruled line. Lead finish/Ball material values may wrap to two lines if the finish value exceeds the maximum column width.

(5) **MSL rating/Peak reflow:** The moisture sensitivity level ratings and peak solder (reflow) temperatures. In the event that a part has multiple moisture sensitivity ratings, only the lowest level per JEDEC standards is shown. Refer to the shipping label for the actual reflow temperature that will be used to mount the part to the printed circuit board.

(6) **Part marking:** There may be an additional marking, which relates to the logo, the lot trace code information, or the environmental category of the part.

Multiple part markings will be inside parentheses. Only one part marking contained in parentheses and separated by a "-" will appear on a part. If a line is indented then it is a continuation of the previous line and the two combined represent the entire part marking for that device.

Important Information and Disclaimer: The information provided on this page represents TI's knowledge and belief as of the date that it is provided. TI bases its knowledge and belief on information provided by third parties, and makes no representation or warranty as to the accuracy of such information. Efforts are underway to better integrate information from third parties. TI has taken and continues to take reasonable steps to provide representative and accurate information but may not have conducted destructive testing or chemical analysis on incoming materials and chemicals. TI and TI suppliers consider certain information to be proprietary, and thus CAS numbers and other limited information may not be available for release.

In no event shall TI's liability arising out of such information exceed the total purchase price of the TI part(s) at issue in this document sold by TI to Customer on an annual basis.

OTHER QUALIFIED VERSIONS OF REF35 :

- Automotive : [REF35-Q1](#)

NOTE: Qualified Version Definitions:

- Automotive - Q100 devices qualified for high-reliability automotive applications targeting zero defects

TAPE AND REEL INFORMATION



QUADRANT ASSIGNMENTS FOR PIN 1 ORIENTATION IN TAPE



*All dimensions are nominal

Device	Package Type	Package Drawing	Pins	SPQ	Reel Diameter (mm)	Reel Width W1 (mm)	A0 (mm)	B0 (mm)	K0 (mm)	P1 (mm)	W (mm)	Pin1 Quadrant
REF35102QDBVR	SOT-23	DBV	6	3000	180.0	8.4	3.23	3.17	1.37	4.0	8.0	Q3
REF35102YBHR	DSBGA	YBH	4	12000	180.0	8.4	0.94	1.17	0.45	2.0	8.0	Q2
REF35120QDBVR	SOT-23	DBV	6	3000	180.0	8.4	3.23	3.17	1.37	4.0	8.0	Q3
REF35120YBHR	DSBGA	YBH	4	12000	180.0	8.4	0.94	1.17	0.45	2.0	8.0	Q2
REF35125QDBVR	SOT-23	DBV	6	3000	180.0	8.4	3.23	3.17	1.37	4.0	8.0	Q3
REF35125YBHR	DSBGA	YBH	4	12000	180.0	8.4	0.94	1.17	0.45	2.0	8.0	Q2
REF35160QDBVR	SOT-23	DBV	6	3000	180.0	8.4	3.23	3.17	1.37	4.0	8.0	Q3
REF35160YBHR	DSBGA	YBH	4	12000	180.0	8.4	0.94	1.17	0.45	2.0	8.0	Q2
REF35170QDBVR	SOT-23	DBV	6	3000	180.0	8.4	3.23	3.17	1.37	4.0	8.0	Q3
REF35180QDBVR	SOT-23	DBV	6	3000	180.0	8.4	3.23	3.17	1.37	4.0	8.0	Q3
REF35180YBHR	DSBGA	YBH	4	12000	180.0	8.4	0.94	1.17	0.45	2.0	8.0	Q2
REF35205QDBVR	SOT-23	DBV	6	3000	180.0	8.4	3.23	3.17	1.37	4.0	8.0	Q3
REF35250QDBVR	SOT-23	DBV	6	3000	180.0	8.4	3.23	3.17	1.37	4.0	8.0	Q3
REF35250YBHR	DSBGA	YBH	4	12000	180.0	8.4	0.94	1.17	0.45	2.0	8.0	Q2
REF35300QDBVR	SOT-23	DBV	6	3000	180.0	8.4	3.23	3.17	1.37	4.0	8.0	Q3
REF35300YBHR	DSBGA	YBH	4	12000	180.0	8.4	0.94	1.17	0.45	2.0	8.0	Q2

Device	Package Type	Package Drawing	Pins	SPQ	Reel Diameter (mm)	Reel Width W1 (mm)	A0 (mm)	B0 (mm)	K0 (mm)	P1 (mm)	W (mm)	Pin1 Quadrant
REF35330QDBVR	SOT-23	DBV	6	3000	180.0	8.4	3.23	3.17	1.37	4.0	8.0	Q3
REF35360QDBVR	SOT-23	DBV	6	3000	180.0	8.4	3.23	3.17	1.37	4.0	8.0	Q3
REF35409QDBVR	SOT-23	DBV	6	3000	180.0	8.4	3.23	3.17	1.37	4.0	8.0	Q3
REF35409YBHR	DSBGA	YBH	4	12000	180.0	8.4	0.94	1.17	0.45	2.0	8.0	Q2
REF35500QDBVR	SOT-23	DBV	6	3000	180.0	8.4	3.23	3.17	1.37	4.0	8.0	Q3

TAPE AND REEL BOX DIMENSIONS

*All dimensions are nominal

Device	Package Type	Package Drawing	Pins	SPQ	Length (mm)	Width (mm)	Height (mm)
REF35102QDBVR	SOT-23	DBV	6	3000	213.0	191.0	35.0
REF35102YBHR	DSBGA	YBH	4	12000	182.0	182.0	20.0
REF35120QDBVR	SOT-23	DBV	6	3000	213.0	191.0	35.0
REF35120YBHR	DSBGA	YBH	4	12000	182.0	182.0	20.0
REF35125QDBVR	SOT-23	DBV	6	3000	213.0	191.0	35.0
REF35125YBHR	DSBGA	YBH	4	12000	182.0	182.0	20.0
REF35160QDBVR	SOT-23	DBV	6	3000	213.0	191.0	35.0
REF35160YBHR	DSBGA	YBH	4	12000	182.0	182.0	20.0
REF35170QDBVR	SOT-23	DBV	6	3000	213.0	191.0	35.0
REF35180QDBVR	SOT-23	DBV	6	3000	213.0	191.0	35.0
REF35180YBHR	DSBGA	YBH	4	12000	182.0	182.0	20.0
REF35205QDBVR	SOT-23	DBV	6	3000	213.0	191.0	35.0
REF35250QDBVR	SOT-23	DBV	6	3000	213.0	191.0	35.0
REF35250YBHR	DSBGA	YBH	4	12000	182.0	182.0	20.0
REF35300QDBVR	SOT-23	DBV	6	3000	213.0	191.0	35.0
REF35300YBHR	DSBGA	YBH	4	12000	182.0	182.0	20.0
REF35330QDBVR	SOT-23	DBV	6	3000	213.0	191.0	35.0
REF35360QDBVR	SOT-23	DBV	6	3000	213.0	191.0	35.0

Device	Package Type	Package Drawing	Pins	SPQ	Length (mm)	Width (mm)	Height (mm)
REF35409QDBVR	SOT-23	DBV	6	3000	213.0	191.0	35.0
REF35409YBHR	DSBGA	YBH	4	12000	182.0	182.0	20.0
REF35500QDBVR	SOT-23	DBV	6	3000	213.0	191.0	35.0

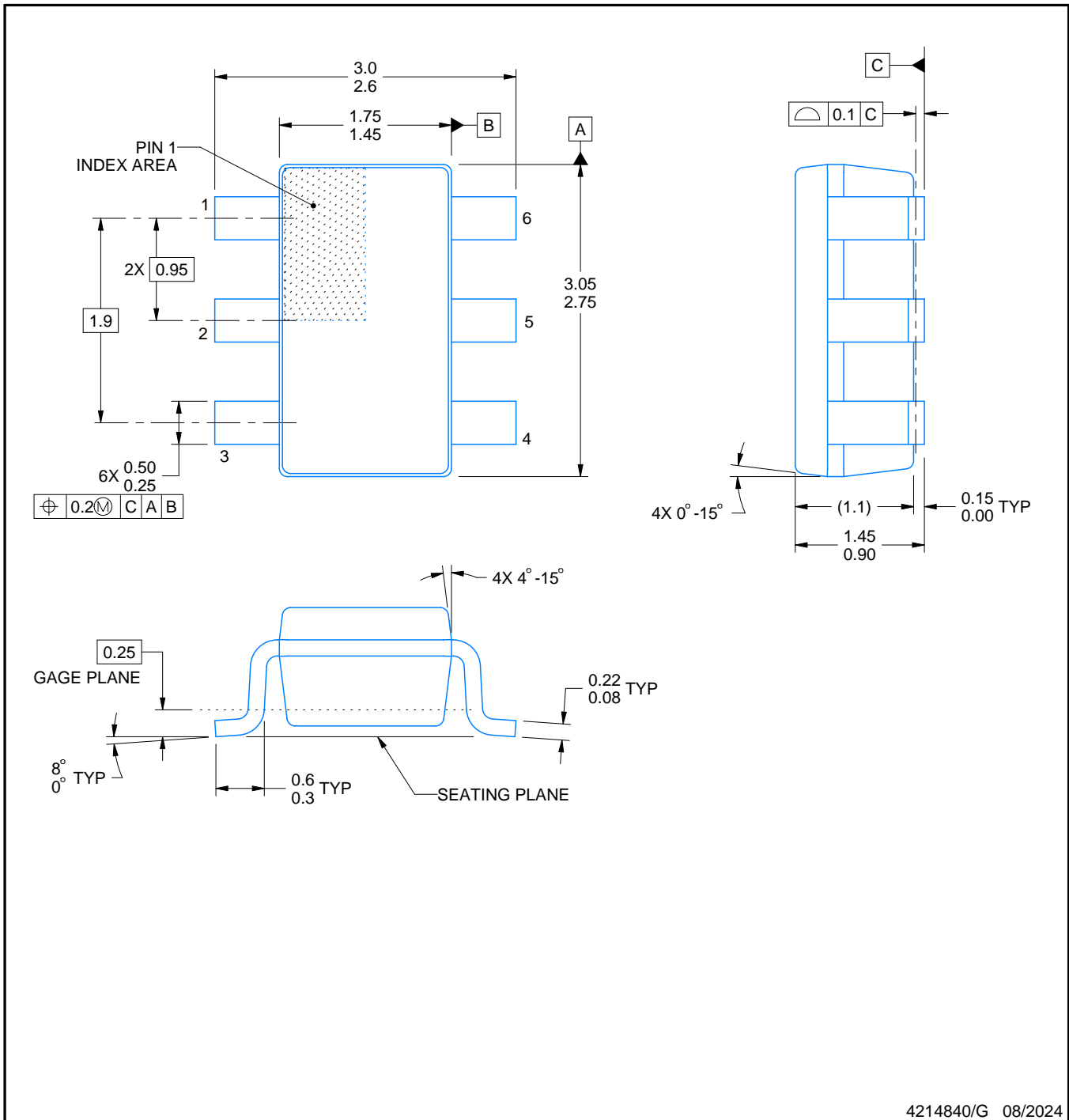

4214840/G 08/2024

NOTES:

1. All linear dimensions are in millimeters. Any dimensions in parenthesis are for reference only. Dimensioning and tolerancing per ASME Y14.5M.
2. This drawing is subject to change without notice.
3. Body dimensions do not include mold flash or protrusion. Mold flash and protrusion shall not exceed 0.25 per side.
4. Leads 1,2,3 may be wider than leads 4,5,6 for package orientation.
5. Reference JEDEC MO-178.

EXAMPLE BOARD LAYOUT

DBV0006A

SOT-23 - 1.45 mm max height

SMALL OUTLINE TRANSISTOR



LAND PATTERN EXAMPLE
EXPOSED METAL SHOWN
SCALE:15X

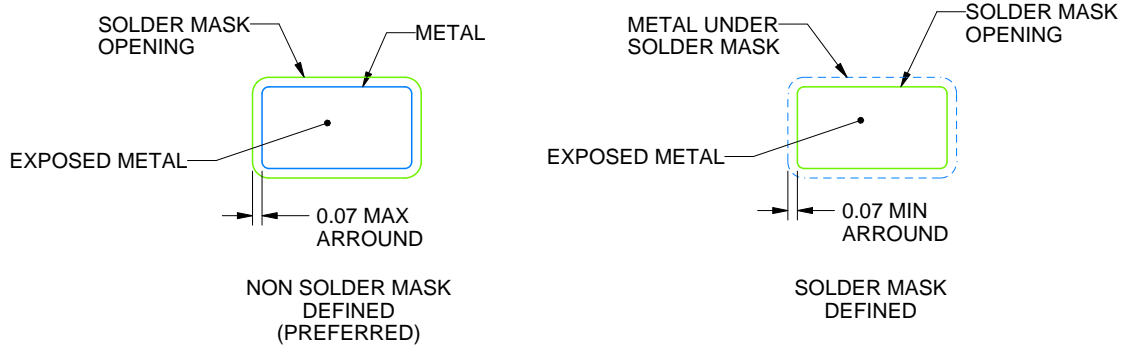

SOLDER MASK DETAILS

4214840/G 08/2024

NOTES: (continued)

6. Publication IPC-7351 may have alternate designs.
7. Solder mask tolerances between and around signal pads can vary based on board fabrication site.

EXAMPLE STENCIL DESIGN

DBV0006A

SOT-23 - 1.45 mm max height

SMALL OUTLINE TRANSISTOR



SOLDER PASTE EXAMPLE
BASED ON 0.125 mm THICK STENCIL
SCALE:15X

4214840/G 08/2024

NOTES: (continued)

8. Laser cutting apertures with trapezoidal walls and rounded corners may offer better paste release. IPC-7525 may have alternate design recommendations.
9. Board assembly site may have different recommendations for stencil design.

IMPORTANT NOTICE AND DISCLAIMER

TI PROVIDES TECHNICAL AND RELIABILITY DATA (INCLUDING DATASHEETS), DESIGN RESOURCES (INCLUDING REFERENCE DESIGNS), APPLICATION OR OTHER DESIGN ADVICE, WEB TOOLS, SAFETY INFORMATION, AND OTHER RESOURCES "AS IS" AND WITH ALL FAULTS, AND DISCLAIMS ALL WARRANTIES, EXPRESS AND IMPLIED, INCLUDING WITHOUT LIMITATION ANY IMPLIED WARRANTIES OF MERCHANTABILITY, FITNESS FOR A PARTICULAR PURPOSE OR NON-INFRINGEMENT OF THIRD PARTY INTELLECTUAL PROPERTY RIGHTS.

These resources are intended for skilled developers designing with TI products. You are solely responsible for (1) selecting the appropriate TI products for your application, (2) designing, validating and testing your application, and (3) ensuring your application meets applicable standards, and any other safety, security, regulatory or other requirements.

These resources are subject to change without notice. TI grants you permission to use these resources only for development of an application that uses the TI products described in the resource. Other reproduction and display of these resources is prohibited. No license is granted to any other TI intellectual property right or to any third party intellectual property right. TI disclaims responsibility for, and you fully indemnify TI and its representatives against any claims, damages, costs, losses, and liabilities arising out of your use of these resources.

TI's products are provided subject to [TI's Terms of Sale](#), [TI's General Quality Guidelines](#), or other applicable terms available either on ti.com or provided in conjunction with such TI products. TI's provision of these resources does not expand or otherwise alter TI's applicable warranties or warranty disclaimers for TI products. Unless TI explicitly designates a product as custom or customer-specified, TI products are standard, catalog, general purpose devices.

TI objects to and rejects any additional or different terms you may propose.

Copyright © 2026, Texas Instruments Incorporated

Last updated 10/2025