

# OPA2626 High-Speed, High-Precision, Low-Distortion, 16-Bit and 18-Bit Analog-to-Digital Converter (ADC) Driver

## 1 Features

- Excellent dynamic performance:
  - Low distortion:  $-122$  dBc for HD2 and  $-140$  dBc for HD3 at 100 kHz
  - Gain bandwidth (G = 100): 120 MHz
  - Slew rate: 115 V/ $\mu$ s
  - 16-bit settling at 4-V step: 280 ns
  - Low voltage noise: 2.5 nV/ $\sqrt{\text{Hz}}$  at 10 kHz
  - Low output impedance: 1  $\Omega$  at 1 MHz
- Excellent DC precision:
  - Offset voltage:  $\pm 100$   $\mu$ V (maximum)
  - Offset voltage drift:  $\pm 3$   $\mu$ V/ $^{\circ}$ C (maximum)
  - Low quiescent current: 2 mA (typical)
- Input common-mode range includes negative rail
- Rail-to-rail output
- Wide temperature range: fully specified from  $-40^{\circ}\text{C}$  to  $+125^{\circ}\text{C}$

## 2 Applications

- Precision SAR ADC drivers
- Precision voltage reference buffers
- Programmable logic controllers
- Test and measurement equipment
- Scientific instrumentation
- High throughput data acquisition systems
- High density, multiplexed data acquisition systems

## 3 Description

The OPA2626 operational amplifier is a 16-bit and 18-bit, high-precision, successive-approximation register (SAR) analog-to-digital converter (ADC) driver with low total harmonic distortion (THD) and noise. This op amp is fully characterized and specified with a 16-bit settling time of 280 ns that enables a true 16-bit effective number of bits (ENOB). With a high DC precision of only 100- $\mu$ V offset voltage, a wide gain-bandwidth product of 120 MHz, and a low wideband noise of 2.5 nV/ $\sqrt{\text{Hz}}$ , this device is optimized for driving high-throughput, high-resolution SAR ADCs in applications such as the ADS88xx family of SAR ADCs.

The OPA2626 is available in an 8-pin VSSOP package and is specified for operation from  $-40^{\circ}\text{C}$  to  $+125^{\circ}\text{C}$ .

### Device Information<sup>(1)</sup>

PART NUMBER	PACKAGE	BODY SIZE (NOM)
OPA2626	VSSOP (8)	3.00 mm $\times$ 3.00 mm

(1) For all available packages, see the package option addendum at the end of the data sheet.

### SAR ADC Driver

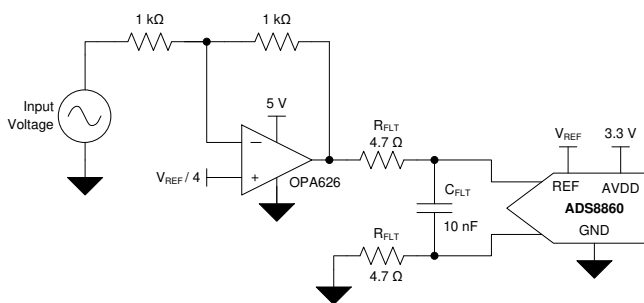

### High Fidelity Topology Improves Dynamic Performance ( $f_{\text{IN}} = 10\text{-kHz}$ , 1-MSPS FFT)

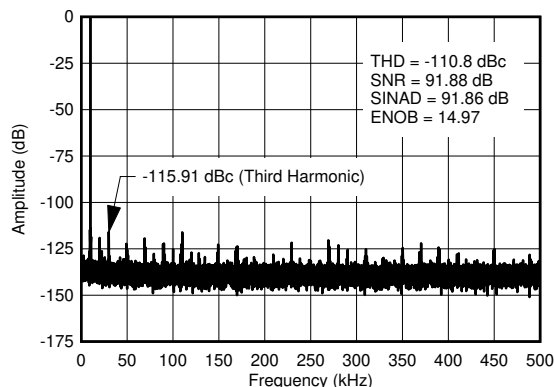

## Table of Contents

<b>1 Features</b> .....	<b>1</b>	8.2 Functional Block Diagram .....	21
<b>2 Applications</b> .....	<b>1</b>	8.3 Feature Description .....	22
<b>3 Description</b> .....	<b>1</b>	8.4 Device Functional Modes .....	23
<b>4 Revision History</b> .....	<b>2</b>	<b>9 Application and Implementation</b> .....	<b>23</b>
<b>5 Pin Configuration and Functions</b> .....	<b>3</b>	9.1 Application Information .....	23
<b>6 Specifications</b> .....	<b>4</b>	9.2 Typical Applications .....	23
6.1 Absolute Maximum Ratings .....	4	<b>10 Power Supply Recommendations</b> .....	<b>28</b>
6.2 ESD Ratings .....	4	<b>11 Layout</b> .....	<b>28</b>
6.3 Recommended Operating Conditions .....	4	11.1 Layout Guidelines .....	28
6.4 Thermal Information .....	5	11.2 Layout Example .....	29
6.5 Electrical Characteristics: High-Supply .....	5	<b>12 Device and Documentation Support</b> .....	<b>30</b>
6.6 Electrical Characteristics: Low-Supply .....	7	12.1 Device Support .....	30
6.7 Typical Characteristics .....	9	12.2 Documentation Support .....	30
<b>7 Parameter Measurement Information</b> .....	<b>18</b>	12.3 Receiving Notification of Documentation Updates .....	30
7.1 DC Parameter Measurements .....	18	12.4 Community Resources .....	30
7.2 Transient Parameter Measurements .....	19	12.5 Trademarks .....	30
7.3 AC Parameter Measurements .....	19	12.6 Electrostatic Discharge Caution .....	31
7.4 Noise Parameter Measurements .....	20	12.7 Glossary .....	31
<b>8 Detailed Description</b> .....	<b>21</b>	<b>13 Mechanical, Packaging, and Orderable Information</b> .....	<b>31</b>
8.1 Overview .....	21		

## 4 Revision History

Changes from Original (July 2016) to Revision A	Page
• Deleted OPA626 (5-pin SOT DBV package) from document .....	1
• Added 18-bit SAR ADC to amplifier description in <i>Overview</i> section .....	21
• Added 18-bit level to device description in <i>Application Information</i> section .....	23
• Added ( <i>pins 3 and 4</i> ) to input terminals in <i>Design Requirements</i> section of first typical application for clarity .....	24
• Changed description of slew and settle time in <i>Design Requirements</i> section of second typical application for clarity .....	26

## 5 Pin Configuration and Functions

**OPA2626 DGK Package  
8-Pin VSSOP  
Top View**

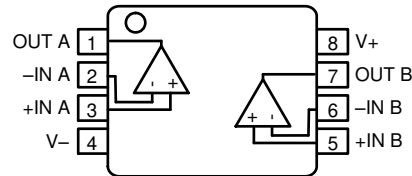

**Pin Functions: OPA2626**

PIN		I/O	DESCRIPTION
NAME	NO.		
+IN A	3	I	Noninverting input for channel A
-IN A	2	I	Inverting input for channel A
+IN B	5	I	Noninverting input for channel B
-IN B	6	I	Inverting input for channel B
OUT A	1	O	Output terminal for channel A
OUT B	7	O	Output terminal for channel B
V+	8	—	Positive supply voltage
V-	4	—	Negative supply voltage

## 6 Specifications

### 6.1 Absolute Maximum Ratings

over operating free-air temperature range (unless otherwise noted)<sup>(1)</sup>

		MIN	MAX	UNIT
Supply voltage, $V_S$	(V+) – (V–)	6		V
Input voltage <sup>(2)</sup>	+IN	(V–) – 0.3	(V+) + 0.3	V
	–IN	(V–) – 0.3	(V+) + 0.3	
Output voltage	OUT	(V–)	(V+)	V
Sink current	+IN	10		mA
	–IN	10		
	OUT	150		
Source current	+IN	10		mA
	–IN	10		
	OUT	150		
Temperature	Operating junction	–40	150	°C
	Operating free-air, $T_A$	–55	150	
	Storage, $T_{stg}$	–65	150	

- (1) Stresses beyond those listed under *Absolute Maximum Ratings* may cause permanent damage to the device. These are stress ratings only, which do not imply functional operation of the device at these or any other conditions beyond those indicated under *Recommended Operating Conditions*. Exposure to absolute-maximum-rated conditions for extended periods may affect device reliability.
- (2) For input voltages beyond the power-supply rails, voltage or current must be limited.

### 6.2 ESD Ratings

			VALUE	UNIT
$V_{(ESD)}$	Electrostatic discharge	Human-body model (HBM), per ANSI/ESDA/JEDEC JS-001 <sup>(1)</sup>	±3000	V
		Charged-device model (CDM), per JEDEC specification JESD22-C101 <sup>(2)</sup>	±1500	

- (1) JEDEC document JEP155 states that 500-V HBM allows safe manufacturing with a standard ESD control process.
- (2) JEDEC document JEP157 states that 250-V CDM allows safe manufacturing with a standard ESD control process.

### 6.3 Recommended Operating Conditions

over operating free-air temperature range (unless otherwise noted)

		MIN	NOM	MAX	UNIT
$V_S$	Supply input voltage, (V+) – (V–)	2.7		5.5	V
$V_I$	Input voltage	+IN		(V+) – 1.15	V
		–IN	(V–)	(V+) – 1.15	
$V_O$	Output voltage	(V–)		(V+)	V
$I_O$	Output current	–120		120	mA
$T_A$	Operating free-air temperature	–40		125	°C
$T_J$	Operating junction temperature	–40		125	°C

## 6.4 Thermal Information

THERMAL METRIC <sup>(1)</sup>		OPA2626	
		DGK (VSSOP)	UNIT
		8 PINS	
$R_{\theta JA}$	Junction-to-ambient thermal resistance	171.7	°C/W
$R_{\theta JC(top)}$	Junction-to-case (top) thermal resistance	68.4	°C/W
$R_{\theta JB}$	Junction-to-board thermal resistance	91.9	°C/W
$\Psi_{JT}$	Junction-to-top characterization parameter	9.4	°C/W
$\Psi_{JB}$	Junction-to-board characterization parameter	90.5	°C/W
$R_{\theta JC(bot)}$	Junction-to-case (bottom) thermal resistance	N/A	°C/W

(1) For more information about traditional and new thermal metrics, see the [Semiconductor and IC package thermal metrics application report](#).

## 6.5 Electrical Characteristics: High-Supply

at  $T_A = 25^\circ\text{C}$ ,  $V_+ = 5\text{ V}$ ,  $V_- = 0\text{ V}$ ,  $V_{COM} = V_O = 2.5\text{ V}$ , gain ( $G$ ) = 1,  $R_F = 1\text{ k}\Omega$ ,  $C_F = 2.7\text{ pF}$ ,  $C_{LOAD} = 20\text{ pF}$ , and  $R_{LOAD} = 2\text{ k}\Omega$  connected to 2.5 V (unless otherwise noted)

PARAMETER		TEST CONDITIONS		MIN	TYP	MAX	UNIT
<b>AC PERFORMANCE</b>							
	Unity gain frequency	$V_O = 10\text{ mV}_{PP}$			80		MHz
$\phi_m$	Phase margin				50		Degrees
GBW	Gain-bandwidth product	$G = 100$ , $V_O = 10\text{ mV}_{PP}$			120		MHz
SR	Slew rate	$V_O = 1\text{-V step}$ , $G = 1$			45		V/ $\mu\text{s}$
		$V_O = 4\text{-V step}$ , $G = 2$			115		
$t_{settle}$	Settling time	$V_O = 4\text{-V step}$ , $G = 2$	Settling time to 0.1% (10-bit accuracy)		80		ns
			to 0.005% (14-bit accuracy)		110		
			to 0.00153% (16-bit accuracy)		280		
	Overshoot	$V_O = 4\text{-V step}$ , $G = 2$			2.5%		
	Undershoot	$V_O = 4\text{-V step}$ , $G = 2$			3%		
HD2	Second-order harmonic distortion	$V_O = 2\text{ V}_{PP}$ , $G = 2$	$f = 10\text{ kHz}$		144		dBc
			$f = 100\text{ kHz}$		122		
			$f = 1\text{ MHz}$		80		
HD3	Third-order harmonic distortion	$V_O = 2\text{ V}_{PP}$ , $G = 2$	$f = 10\text{ kHz}$		155		dBc
			$f = 100\text{ kHz}$		140		
			$f = 1\text{ MHz}$		80		
	Second-order intermodulation distortion	$V_O = 2\text{ V}_{PP}$ , $f = 1\text{ MHz}$ , 200-kHz tone spacing			90		dBc
	Third-order intermodulation distortion	$V_O = 2\text{ V}_{PP}$ , $f = 1\text{ MHz}$ , 200-kHz tone spacing			100		dBc
$V_N$	Input noise voltage	$f = 0.1\text{ Hz to }10\text{ Hz}$ , peak-to-peak			0.8		$\mu\text{V}_{PP}$
		$f = 0.1\text{ Hz to }10\text{ Hz}$ , rms			120		$\text{nV}_{RMS}$
$V_n$	Input voltage noise density	$f = 1\text{ kHz}$			3.2		$\text{nV}/\sqrt{\text{Hz}}$
		$f = 10\text{ kHz}$			2.5		
$I_n$	Input current noise density	$f = 1\text{ kHz}$			6.6		$\text{pA}/\sqrt{\text{Hz}}$
		$f = 10\text{ kHz}$			3.5		
$t_{OR}$	Overload recovery time	$G = 5$			50		ns
$Z_o$	Open-loop output impedance	$f = 1\text{ MHz}$			1		$\Omega$
	Crosstalk	At DC			150		dB
		$f = 1\text{ MHz}$			127		
<b>DC PERFORMANCE</b>							

### Electrical Characteristics: High-Supply (continued)

at  $T_A = 25^\circ\text{C}$ ,  $V_+ = 5\text{ V}$ ,  $V_- = 0\text{ V}$ ,  $V_{\text{COM}} = V_O = 2.5\text{ V}$ , gain ( $G$ ) = 1,  $R_F = 1\text{ k}\Omega$ ,  $C_F = 2.7\text{ pF}$ ,  $C_{\text{LOAD}} = 20\text{ pF}$ , and  $R_{\text{LOAD}} = 2\text{ k}\Omega$  connected to 2.5 V (unless otherwise noted)

PARAMETER		TEST CONDITIONS		MIN	TYP	MAX	UNIT	
$V_{\text{OS}}$	Input offset voltage	$T_A = -40^\circ\text{C}$ to $125^\circ\text{C}$			15	$\pm 100$	$\mu\text{V}$	
						$\pm 300$		
$dV_{\text{OS}}/dT$	Input offset voltage drift	$T_A = -40^\circ\text{C}$ to $125^\circ\text{C}$			0.5	$\pm 3$	$\mu\text{V}/^\circ\text{C}$	
					0.6	$\pm 4$		
PSRR	Power-supply rejection ratio	$2.7\text{ V} \leq (V_+) \leq 5\text{ V}$	$T_A = -40^\circ\text{C}$ to $125^\circ\text{C}$	100			dB	
				90	120			
$I_B$	Input bias current	$T_A = -40^\circ\text{C}$ to $125^\circ\text{C}$			2	4	$\mu\text{A}$	
						5.7		
						6.5		
$dl_B/dT$	Input bias current drift	$T_A = -40^\circ\text{C}$ to $125^\circ\text{C}$			15		$\text{nA}/^\circ\text{C}$	
$I_{\text{OS}}$	Input offset current	$T_A = -40^\circ\text{C}$ to $125^\circ\text{C}$			20	120	nA	
						150		
						350		
$dl_{\text{OS}}/dT$	Input offset current drift	$T_A = -40^\circ\text{C}$ to $125^\circ\text{C}$			0.6		$\text{nA}/^\circ\text{C}$	
<b>OPEN LOOP GAIN</b>								
$A_{\text{OL}}$	Open-loop gain	$(V_-) + 0.2\text{ V} < V_O < (V_+) - 0.2\text{ V}$ , $R_{\text{LOAD}} = 600\ \Omega$		110			dB	
		$(V_-) + 0.15\text{ V} < V_O < (V_+) - 0.15\text{ V}$ , $R_{\text{LOAD}} = 10\text{ k}\Omega$		114				
		$T_A = -40^\circ\text{C}$ to $125^\circ\text{C}$	$(V_-) + 0.2\text{ V} < V_O < (V_+) - 0.2\text{ V}$ , $R_{\text{LOAD}} = 600\ \Omega$		106	128		
			$(V_-) + 0.15\text{ V} < V_O < (V_+) - 0.15\text{ V}$ , $R_{\text{LOAD}} = 10\text{ k}\Omega$		110	132		
<b>INPUT VOLTAGE</b>								
$V_{\text{CM}}$	Common-mode voltage range	$T_A = -40^\circ\text{C}$ to $125^\circ\text{C}$		(V-)		(V+) – 1.15	V	
CMRR	Common-mode rejection ratio	$(V_-) < V_{\text{COM}} < (V_+) - 1.15\text{ V}$	$T_A = -40^\circ\text{C}$ to $125^\circ\text{C}$	100	117		dB	
				90	115			
<b>INPUT IMPEDANCE</b>								
$Z_{\text{ID}}$	Differential input impedance			27    1.2			$\text{k}\Omega$    $\text{pF}$	
$Z_{\text{IC}}$	Common-mode input impedance			47    1.5			$\text{M}\Omega$    $\text{pF}$	
<b>OUTPUT</b>								
	Output voltage swing to the rail	$R_{\text{LOAD}} = 600\ \Omega$	$T_A = -40^\circ\text{C}$ to $125^\circ\text{C}$	60	80		mV	
						100		
		$R_{\text{LOAD}} = 10\text{ k}\Omega$	$T_A = -40^\circ\text{C}$ to $125^\circ\text{C}$	20	35			
						40		
$I_{\text{sc}}$	Short-circuit current			130			mA	
$C_{\text{LOAD}}$	Capacitive load drive			See <a href="#">Typical Characteristics</a>				
<b>POWER SUPPLY</b>								
$I_Q$	Quiescent current per amplifier	$I_O = 0\text{ mA}$	$T_A = -40^\circ\text{C}$ to $125^\circ\text{C}$	2	2.2		mA	
						3.1		

## 6.6 Electrical Characteristics: Low-Supply

at  $T_A = 25^\circ\text{C}$ ,  $V_+ = 2.7\text{ V}$ ,  $V_- = 0\text{ V}$ ,  $V_{\text{COM}} = V_O = 1.35\text{ V}$ , gain ( $G$ ) = 1,  $R_F = 1\text{ k}\Omega$ ,  $C_F = 2.7\text{ pF}$ ,  $C_{\text{LOAD}} = 20\text{ pF}$ , and  $R_{\text{LOAD}} = 1\text{ k}\Omega$  connected to  $1.35\text{ V}$  (unless otherwise noted)

PARAMETER		TEST CONDITIONS		MIN	TYP	MAX	UNIT
<b>AC PERFORMANCE</b>							
	Unity gain frequency	$V_O = 10\text{ mV}_{\text{PP}}$			76		MHz
$\phi_m$	Phase margin				50		Degrees
GBW	Gain-bandwidth product	$G = 100$ , $V_O = 10\text{ mV}_{\text{PP}}$			110		MHz
SR	Slew rate	$V_O = 1\text{-V step}$ , $G = 2$			45		V/ $\mu\text{s}$
$t_{\text{settle}}$	Settling time	$V_O = 1\text{-V step}$ , $G = 2$	to 0.1%		80		ns
			to 0.01%		170		
			to 0.000763% (17-bit accuracy)		250		
	Overshoot	$V_O = 1\text{-V step}$ , $G = 2$			6%		
	Undershoot	$V_O = 1\text{-V step}$ , $G = 2$			5%		
HD2	Second-order harmonic distortion	$(V_+ = 3.3\text{ V}, V_- = 0\text{ V}, V_{\text{COM}} = 1.1\text{ V}, V_O = 2\text{ V}_{\text{PP}})$	$f = 10\text{ kHz}$		136		dBc
			$f = 100\text{ kHz}$		118		
			$f = 1\text{ MHz}$		80		
HD3	Third-order harmonic distortion	$(V_+ = 3.3\text{ V}, V_- = 0\text{ V}, V_{\text{COM}} = 1.1\text{ V}, V_O = 2\text{ V}_{\text{PP}})$	$f = 10\text{ kHz}$		143		dBc
			$f = 10\text{ kHz}$		143		
			$f = 100\text{ kHz}$		130		
			$f = 100\text{ kHz}$		125		
			$f = 1\text{ MHz}$		85		
			$f = 1\text{ MHz}$		74		
	Second-order intermodulation distortion	$(V_+ = 3.3\text{ V}, V_- = 0\text{ V}, V_{\text{COM}} = 1.1\text{ V}, V_O = 2\text{ V}_{\text{PP}}, f = 1\text{ MHz}, 200\text{-kHz tone spacing})$			95		dBc
	Third-order intermodulation distortion	$(V_+ = 3.3\text{ V}, V_- = 0\text{ V}, V_{\text{COM}} = 1.1\text{ V}, V_O = 1\text{ V}_{\text{PP}}, f = 1\text{ MHz}, 200\text{-kHz tone spacing})$			104		dBc
$V_N$	Input noise voltage	$f = 0.1\text{ Hz to }10\text{ Hz}$ , peak-to-peak			0.8		$\mu\text{V}_{\text{PP}}$
		$f = 0.1\text{ Hz to }10\text{ Hz}$ , rms			120		$\text{nV}_{\text{RMS}}$
$V_n$	Input voltage noise density	$f = 10\text{ kHz}$			2.5		$\text{nV}/\sqrt{\text{Hz}}$
$I_n$	Input current noise density	$f = 10\text{ kHz}$			3.5		$\text{pA}/\sqrt{\text{Hz}}$
$t_{\text{OR}}$	Overload recovery time	$G = 5$			35		ns
$Z_o$	Open-loop output impedance	$f = 1\text{ MHz}$			1.3		$\Omega$
	Crosstalk	At DC			150		dB
		$f = 1\text{ MHz}$			127		
<b>DC PERFORMANCE</b>							
$V_{\text{OS}}$	Input offset voltage				15	$\pm 100$	$\mu\text{V}$
		$T_A = -40^\circ\text{C to }125^\circ\text{C}$				$\pm 300$	
$dV_{\text{OS}}/dT$	Input offset voltage drift	$T_A = -40^\circ\text{C to }125^\circ\text{C}$			0.5	$\pm 3.1$	$\mu\text{V}/^\circ\text{C}$
					0.6	$\pm 4$	
$I_B$	Input bias current				2	4	$\mu\text{A}$
		$T_A = -40^\circ\text{C to }125^\circ\text{C}$				5.7	
						6.5	
$dI_B/dT$	Input bias current drift	$T_A = -40^\circ\text{C to }125^\circ\text{C}$			15		$\text{nA}/^\circ\text{C}$
$I_{\text{OS}}$	Input offset current				20	120	nA
		$T_A = -40^\circ\text{C to }125^\circ\text{C}$				150	
						200	
$dI_{\text{OS}}/dT$	Input offset current drift	$T_A = -40^\circ\text{C to }125^\circ\text{C}$			80		$\text{pA}/^\circ\text{C}$
<b>OPEN-LOOP GAIN</b>							

### Electrical Characteristics: Low-Supply (continued)

at  $T_A = 25^\circ\text{C}$ ,  $V_+ = 2.7\text{ V}$ ,  $V_- = 0\text{ V}$ ,  $V_{\text{COM}} = V_O = 1.35\text{ V}$ , gain ( $G$ ) = 1,  $R_F = 1\text{ k}\Omega$ ,  $C_F = 2.7\text{ pF}$ ,  $C_{\text{LOAD}} = 20\text{ pF}$ , and  $R_{\text{LOAD}} = 1\text{ k}\Omega$  connected to  $1.35\text{ V}$  (unless otherwise noted)

PARAMETER		TEST CONDITIONS		MIN	TYP	MAX	UNIT	
A <sub>OL</sub>	Open-loop gain	$(V_-) + 0.2\text{ V} < V_O < (V_+) - 0.2\text{ V}$ , $R_{\text{LOAD}} = 600\ \Omega$		110		dB		
		$(V_-) + 0.15\text{ V} < V_O < (V_+) - 0.15\text{ V}$ , $R_{\text{LOAD}} = 10\text{ k}\Omega$		114				
		$T_A = -40^\circ\text{C}$ to $125^\circ\text{C}$	$(V_-) + 0.2\text{ V} < V_O < (V_+) - 0.2\text{ V}$ , $R_{\text{LOAD}} = 600\ \Omega$		100			128
			$(V_-) + 0.15\text{ V} < V_O < (V_+) - 0.15\text{ V}$ , $R_{\text{LOAD}} = 10\text{ k}\Omega$		104			132
<b>INPUT VOLTAGE</b>								
V <sub>CM</sub>	Common-mode voltage range	$T_A = -40^\circ\text{C}$ to $125^\circ\text{C}$		(V <sub>-</sub> )		(V <sub>+</sub> ) – 1.15	V	
CMRR	Common-mode rejection ratio	$(V_-) < V_{\text{COM}} < (V_+) - 1.15\text{ V}$ $T_A = -40^\circ\text{C}$ to $125^\circ\text{C}$		100	117		dB	
				90	115			
<b>INPUT IMPEDANCE</b>								
Z <sub>ID</sub>	Differential input impedance			27    0.8			K $\Omega$    pF	
Z <sub>IC</sub>	Common-mode input impedance			47    1.2			M $\Omega$    pF	
<b>OUTPUT</b>								
	Output voltage swing to the rail	$R_{\text{LOAD}} = 600\ \Omega$			60	80	mV	
			$T_A = -40^\circ\text{C}$ to $125^\circ\text{C}$		100			
		$R_{\text{LOAD}} = 10\text{ k}\Omega$			20	35		
			$T_A = -40^\circ\text{C}$ to $125^\circ\text{C}$		40			
I <sub>SC</sub>	Short-circuit current			80		mA		
C <sub>LOAD</sub>	Capacitive load drive			See <a href="#">Typical Characteristics</a>				
<b>POWER SUPPLY</b>								
I <sub>Q</sub>	Quiescent current per amplifier	I <sub>O</sub> = 0 mA $T_A = -40^\circ\text{C}$ to $125^\circ\text{C}$		2		2.1	mA	
						2.8		



### 6.7 Typical Characteristics

at  $T_A = 25^\circ\text{C}$ ,  $V_+ = 5\text{ V}$ ,  $V_- = 0\text{ V}$ ,  $V_{\text{COM}} = V_O = 2.5\text{ V}$ , gain ( $G$ ) = 2,  $R_F = 1\text{ k}\Omega$ ,  $C_F = 2.7\text{ pF}$ ,  $C_{\text{LOAD}} = 20\text{ pF}$ , and  $R_{\text{LOAD}} = 2\text{ k}\Omega$  connected to  $2.5\text{ V}$  (unless otherwise noted)

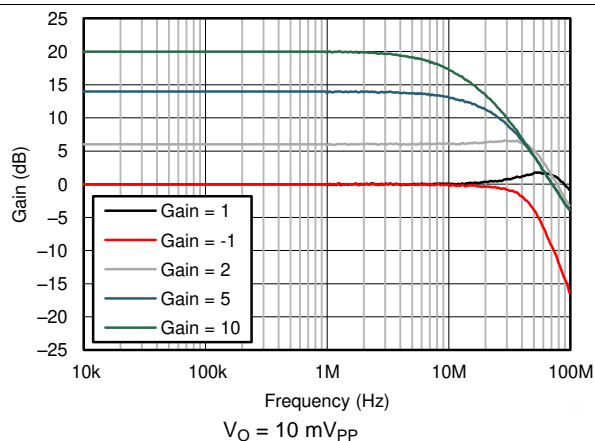

Figure 1. Small-Signal Frequency Response for Various Gains

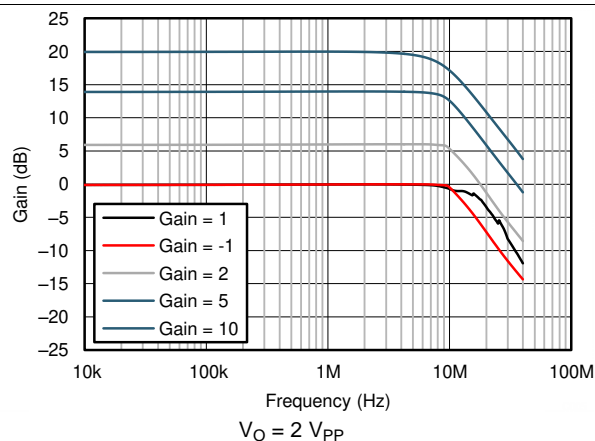

Figure 2. Large-Signal Frequency Response for Various Gains

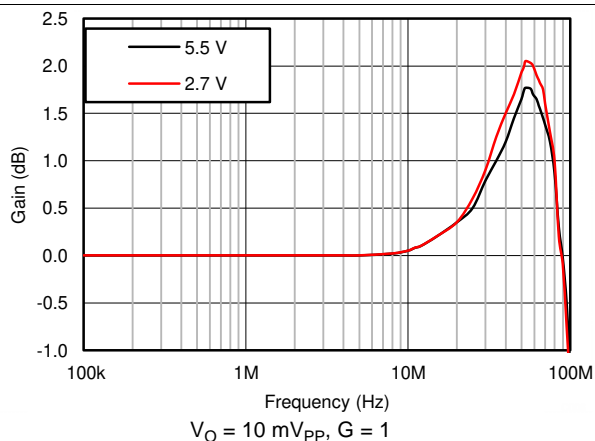

Figure 3. Small-Signal Frequency Response for Various Power Supply Voltages

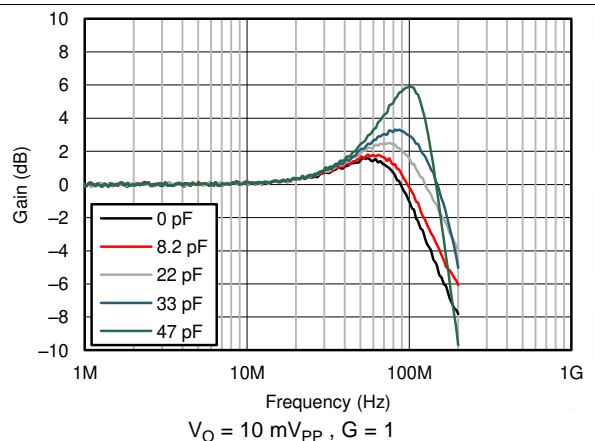

Figure 4. Small-Signal Frequency Response for Various Capacitive Loads

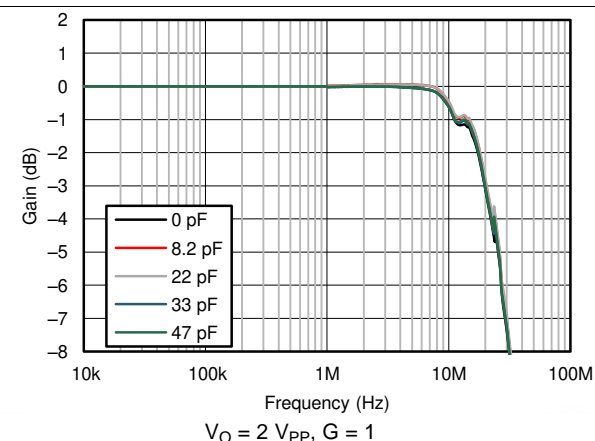

Figure 5. Large-Signal Frequency Response for Various Capacitive Loads

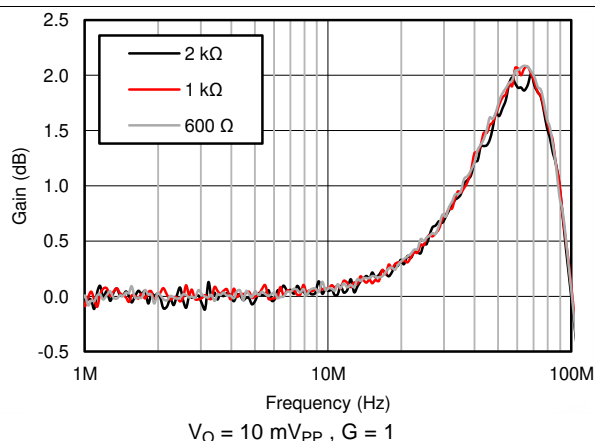

Figure 6. Small-Signal Frequency Response for Various Resistive Loads

### Typical Characteristics (continued)

at  $T_A = 25^\circ\text{C}$ ,  $V_+ = 5\text{ V}$ ,  $V_- = 0\text{ V}$ ,  $V_{\text{COM}} = V_O = 2.5\text{ V}$ , gain ( $G$ ) = 2,  $R_F = 1\text{ k}\Omega$ ,  $C_F = 2.7\text{ pF}$ ,  $C_{\text{LOAD}} = 20\text{ pF}$ , and  $R_{\text{LOAD}} = 2\text{ k}\Omega$  connected to 2.5 V (unless otherwise noted)

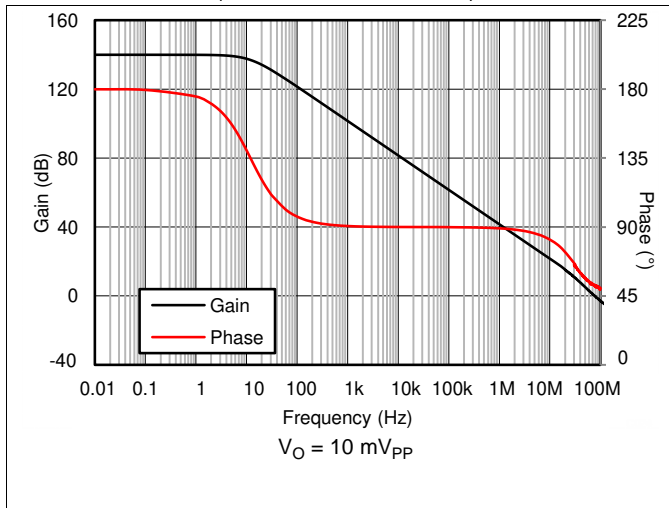

Figure 7. Open-Loop Gain and Phase vs Frequency

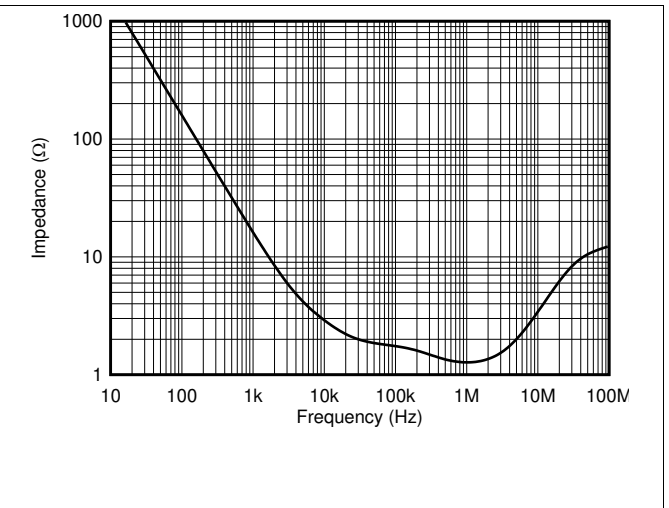

Figure 8. Open-Loop Output Impedance vs Frequency

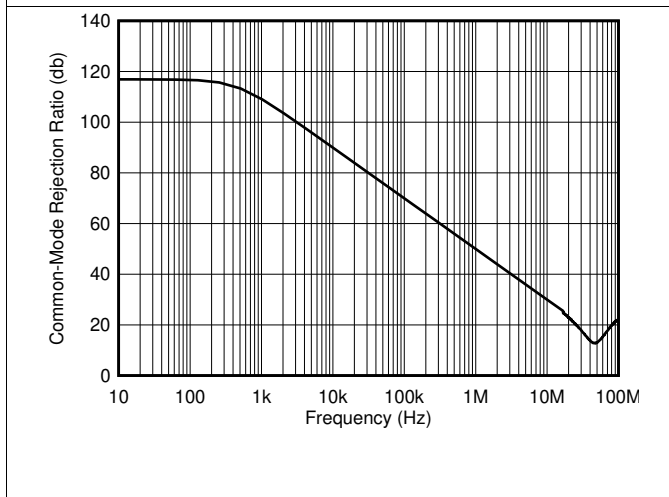

Figure 9. Common-Mode Rejection Ratio vs Frequency

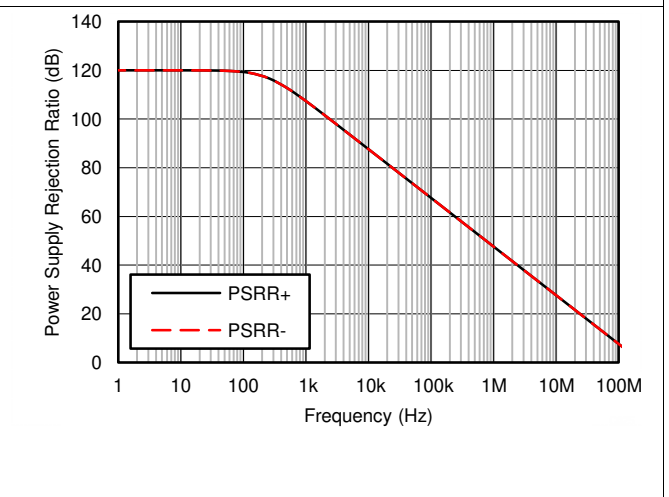

Figure 10. Power-Supply Rejection Ratio vs Frequency

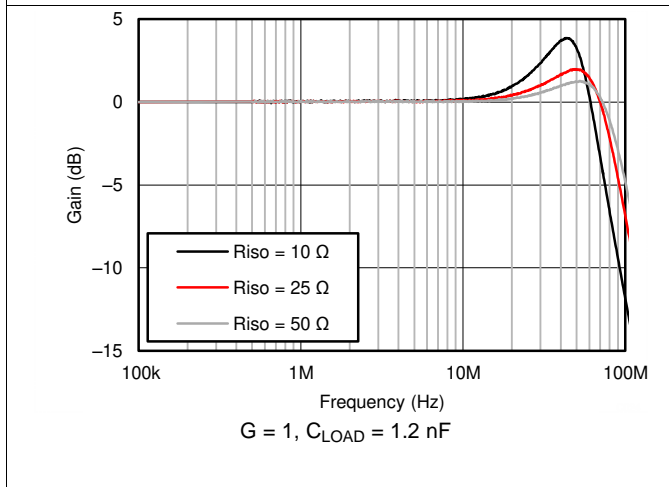

Figure 11. Series Resistance for Capacitive Load Stability

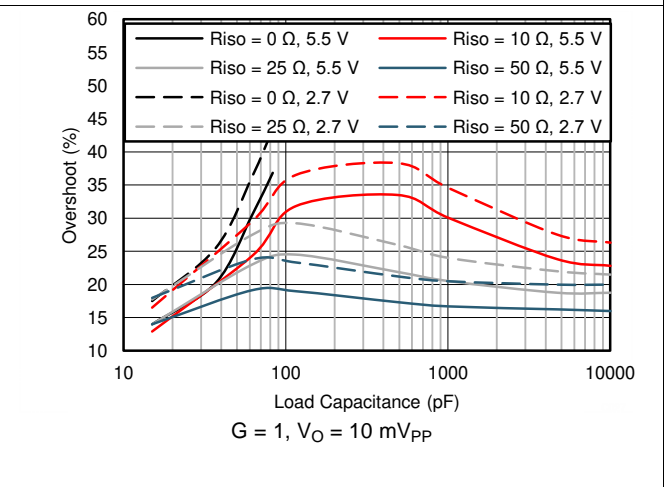

Figure 12. Overshoot vs Capacitive Load,  $G = 1$

Typical Characteristics (continued)

at  $T_A = 25^\circ\text{C}$ ,  $V_+ = 5\text{ V}$ ,  $V_- = 0\text{ V}$ ,  $V_{\text{COM}} = V_O = 2.5\text{ V}$ , gain ( $G$ ) = 2,  $R_F = 1\text{ k}\Omega$ ,  $C_F = 2.7\text{ pF}$ ,  $C_{\text{LOAD}} = 20\text{ pF}$ , and  $R_{\text{LOAD}} = 2\text{ k}\Omega$  connected to 2.5 V (unless otherwise noted)

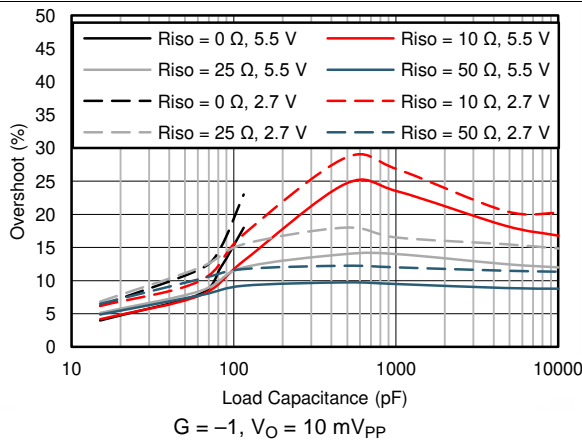

Figure 13. Overshoot vs Capacitive Load,  $G = -1$

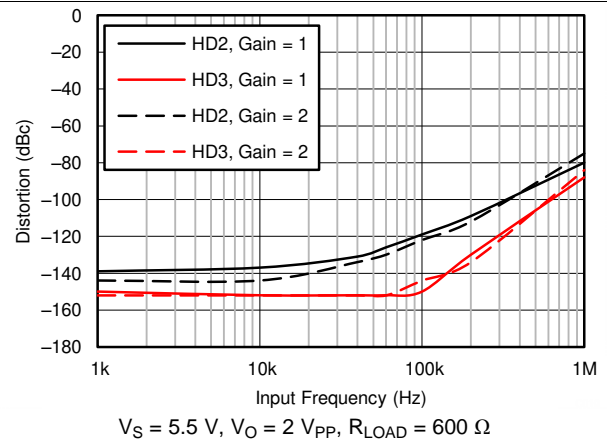

Figure 14. Distortion vs Frequency for Various Gains

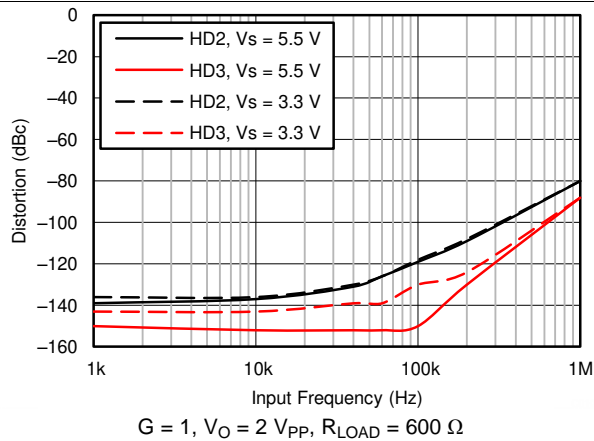

Figure 15. Distortion vs Frequency for Various Power Supplies

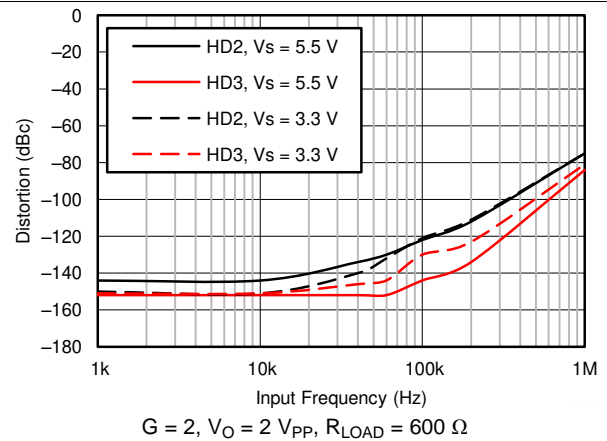

Figure 16. Distortion vs Frequency for Various Power Supplies

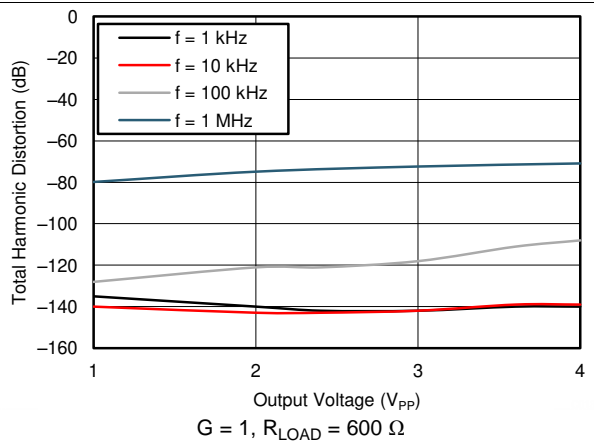

Figure 17. Total Harmonic Distortion vs Output Voltage for Various Frequencies

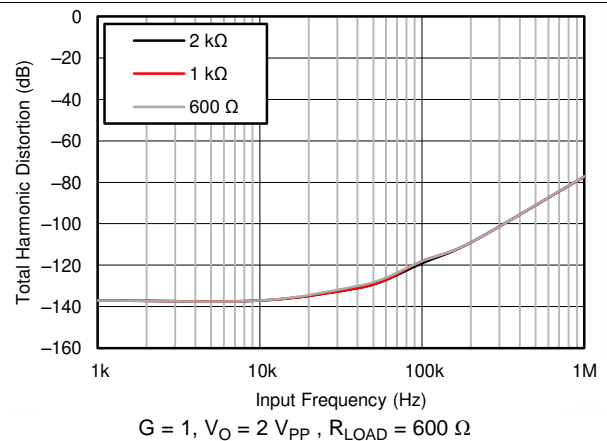

Figure 18. Total Harmonic Distortion vs Frequency for Various Loads

### Typical Characteristics (continued)

at  $T_A = 25^\circ\text{C}$ ,  $V_+ = 5\text{ V}$ ,  $V_- = 0\text{ V}$ ,  $V_{\text{COM}} = V_O = 2.5\text{ V}$ , gain ( $G$ ) = 2,  $R_F = 1\text{ k}\Omega$ ,  $C_F = 2.7\text{ pF}$ ,  $C_{\text{LOAD}} = 20\text{ pF}$ , and  $R_{\text{LOAD}} = 2\text{ k}\Omega$  connected to 2.5 V (unless otherwise noted)

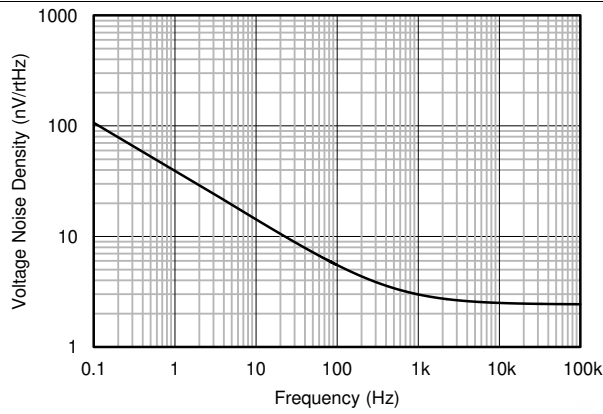

Figure 19. Voltage Noise Density vs Frequency

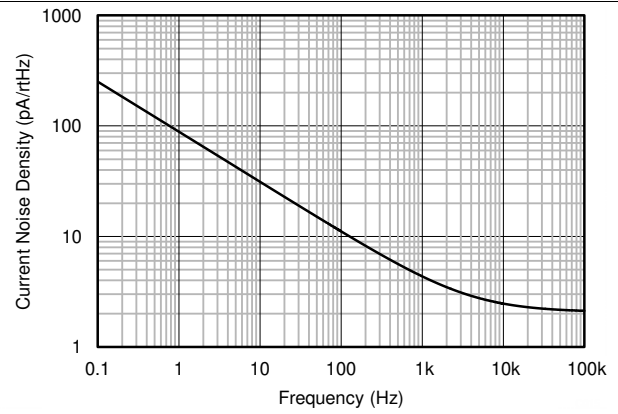

Figure 20. Current Noise Density vs Frequency

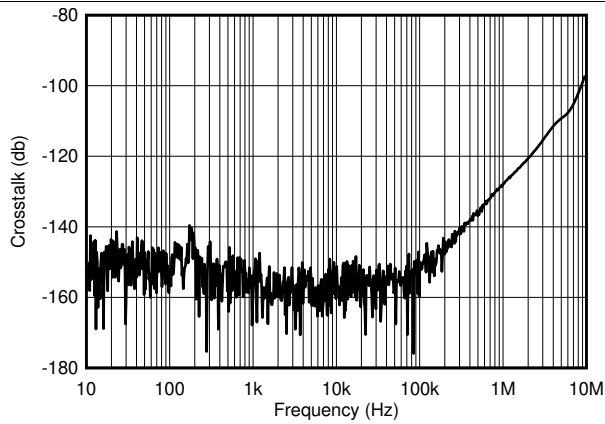

Figure 21. Crosstalk vs Frequency

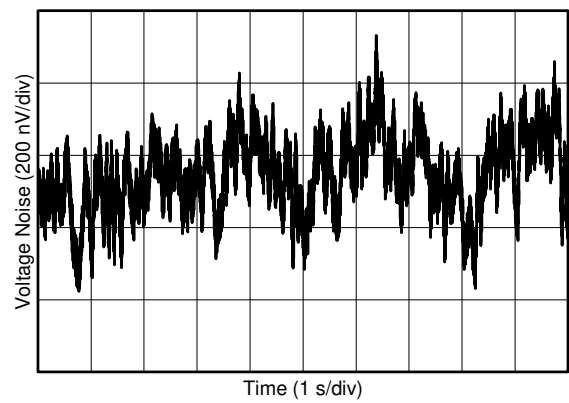

Figure 22. 0.1-Hz to 10-Hz Voltage Noise

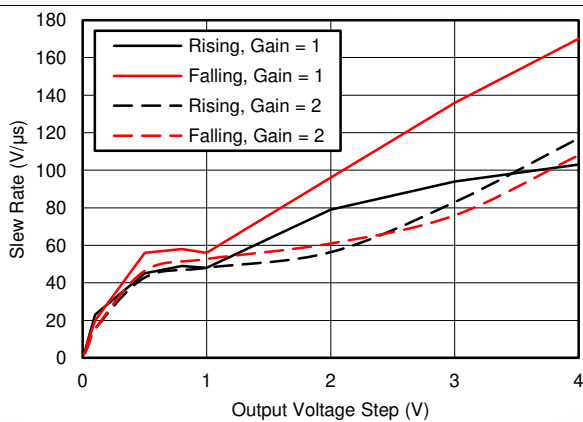

Figure 23. Slew Rate vs Output Step Size

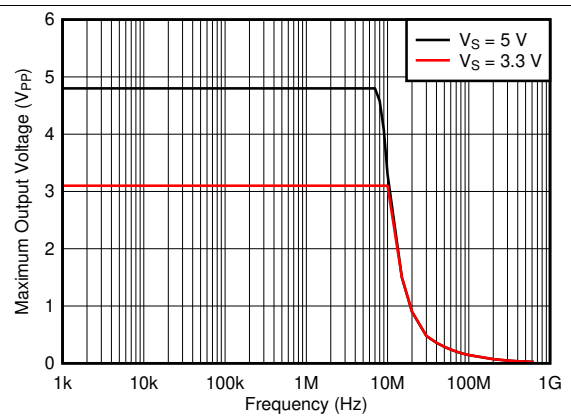
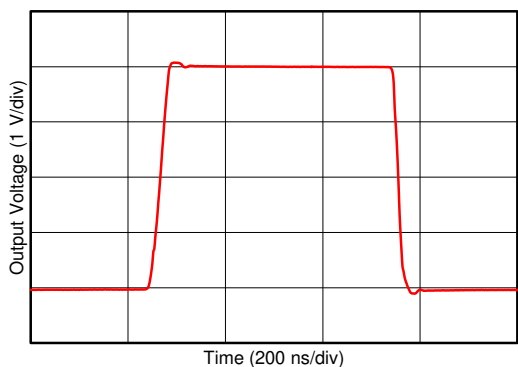

Figure 24. Maximum Output Voltage vs Frequency

Typical Characteristics (continued)

at  $T_A = 25^\circ\text{C}$ ,  $V_+ = 5\text{ V}$ ,  $V_- = 0\text{ V}$ ,  $V_{\text{COM}} = V_O = 2.5\text{ V}$ , gain ( $G$ ) = 2,  $R_F = 1\text{ k}\Omega$ ,  $C_F = 2.7\text{ pF}$ ,  $C_{\text{LOAD}} = 20\text{ pF}$ , and  $R_{\text{LOAD}} = 2\text{ k}\Omega$  connected to 2.5 V (unless otherwise noted)



$G = 1$ ,  $V_O = 4\text{-V}$  step

Figure 25. Large-Signal Pulse Response

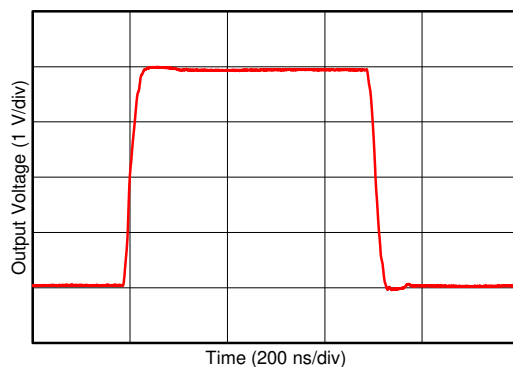

$G = -1$ ,  $V_O = 4\text{-V}$  step

Figure 26. Large-Signal Pulse Response

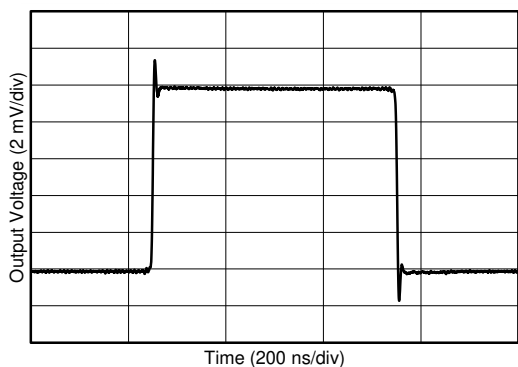

$G = 1$ ,  $V_O = 10\text{-mV}$  step

Figure 27. Small-Signal Pulse Response

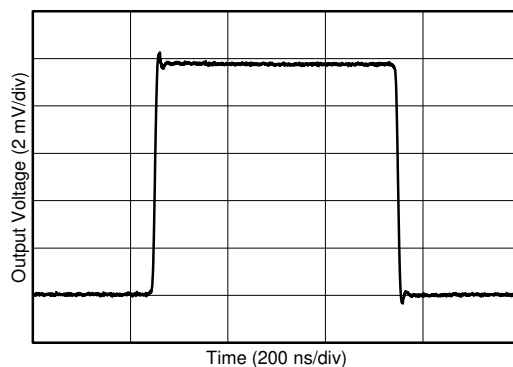

$G = -1$ ,  $V_O = 10\text{-mV}$  step

Figure 28. Small-Signal Pulse Response

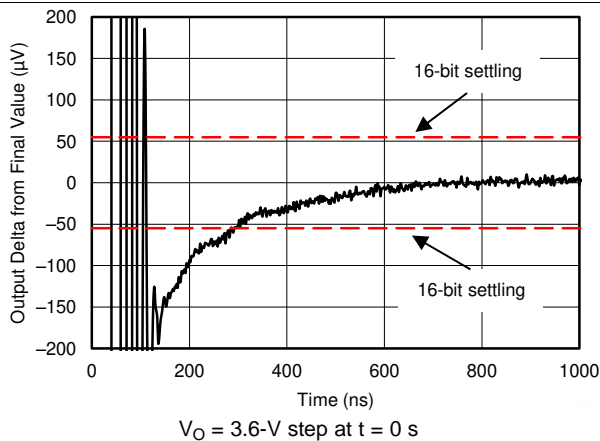

$V_O = 3.6\text{-V}$  step at  $t = 0\text{ s}$

Figure 29. 16-Bit Negative Settling Time

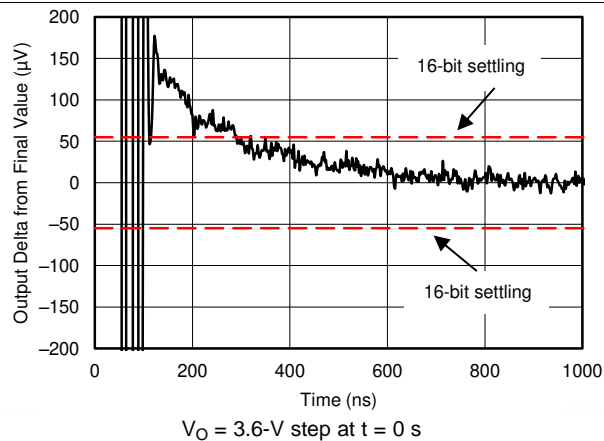

$V_O = 3.6\text{-V}$  step at  $t = 0\text{ s}$

Figure 30. 16-Bit Positive Settling Time

### Typical Characteristics (continued)

at  $T_A = 25^\circ\text{C}$ ,  $V_+ = 5\text{ V}$ ,  $V_- = 0\text{ V}$ ,  $V_{\text{COM}} = V_O = 2.5\text{ V}$ , gain ( $G$ ) = 2,  $R_F = 1\text{ k}\Omega$ ,  $C_F = 2.7\text{ pF}$ ,  $C_{\text{LOAD}} = 20\text{ pF}$ , and  $R_{\text{LOAD}} = 2\text{ k}\Omega$  connected to 2.5 V (unless otherwise noted)

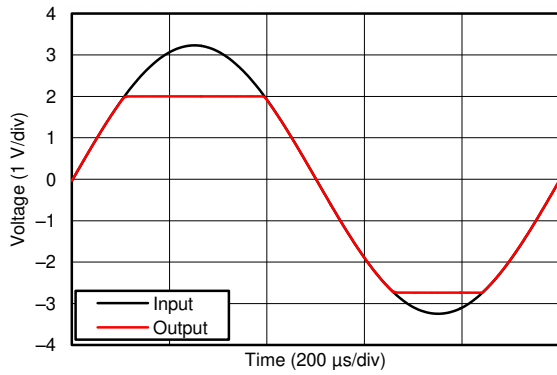

$V_S = \pm 2.75\text{ V}$ ,  $G = 1$

Figure 31. No Phase Reversal

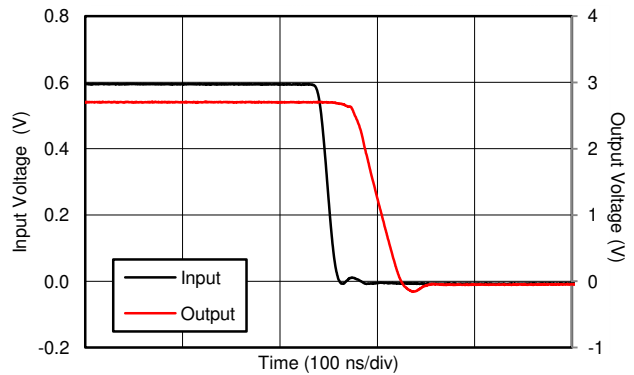

$V_S = \pm 2.75\text{ V}$ ,  $G = 5$

Figure 32. Positive Overload Recovery

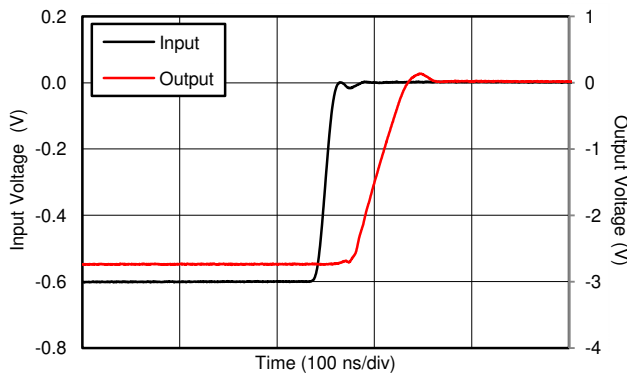

$V_S = \pm 2.75\text{ V}$ ,  $G = 5$

Figure 33. Negative Overload Recovery

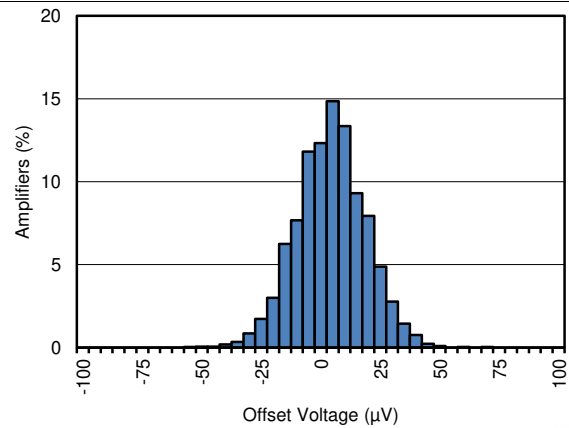

Distribution taken from 3139 amplifiers,  $T_A = 25^\circ\text{C}$

Figure 34. Input Offset Voltage Distribution

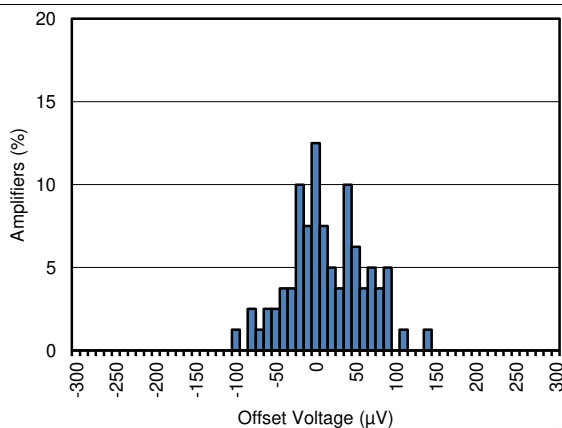

Distribution taken from 80 amplifiers,  $T_A = 125^\circ\text{C}$

Figure 35. Input Offset Voltage Distribution

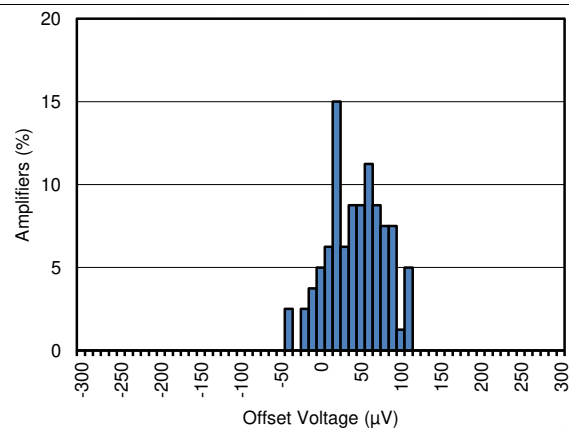

Distribution taken from 80 amplifiers,  $T_A = -40^\circ\text{C}$

Figure 36. Input Offset Voltage Distribution

### Typical Characteristics (continued)

at  $T_A = 25^\circ\text{C}$ ,  $V_+ = 5\text{ V}$ ,  $V_- = 0\text{ V}$ ,  $V_{\text{COM}} = V_O = 2.5\text{ V}$ , gain ( $G$ ) = 2,  $R_F = 1\text{ k}\Omega$ ,  $C_F = 2.7\text{ pF}$ ,  $C_{\text{LOAD}} = 20\text{ pF}$ , and  $R_{\text{LOAD}} = 2\text{ k}\Omega$  connected to 2.5 V (unless otherwise noted)

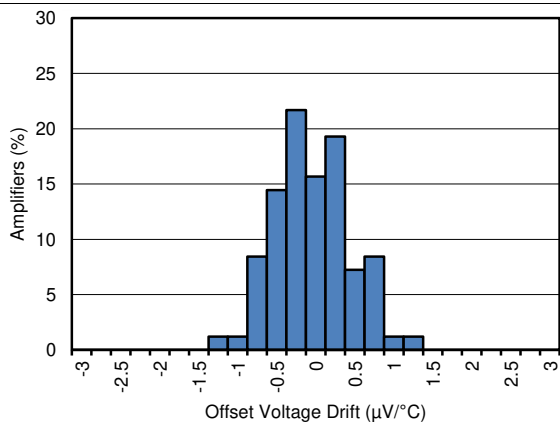

Distribution taken from 75 amplifiers,  $T_A = -40^\circ\text{C}$  to  $+125^\circ\text{C}$

Figure 37. Input Offset Voltage Drift Distribution

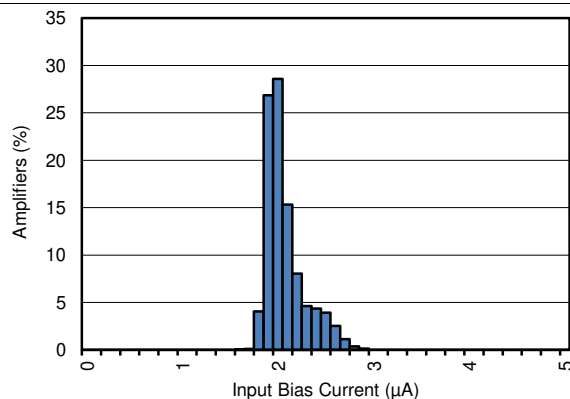

Distribution taken from 3139 amplifiers

Figure 38. Input Bias Current Distribution

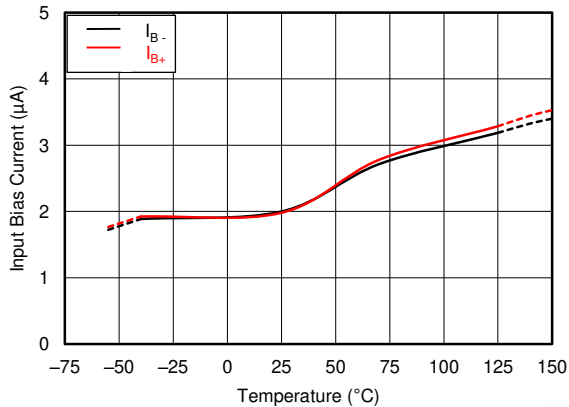
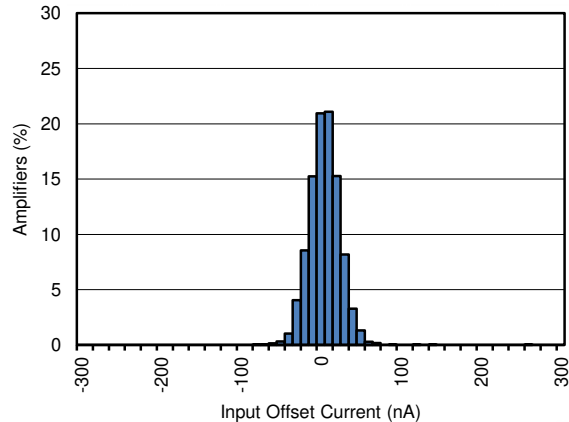

Figure 39. Input Bias Current vs Temperature



Distribution taken from 3139 amplifiers

Figure 40. Input Offset Current Distribution

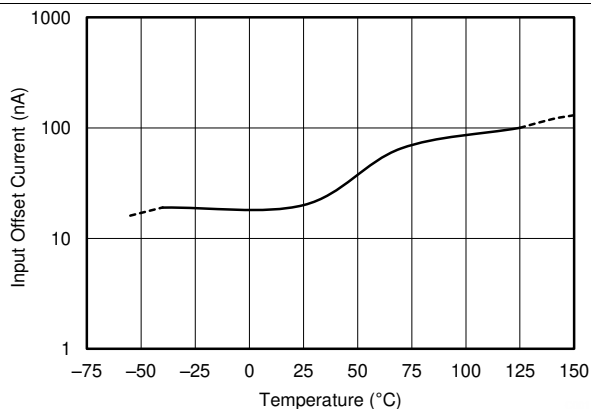

Figure 41. Input Offset Current vs Temperature

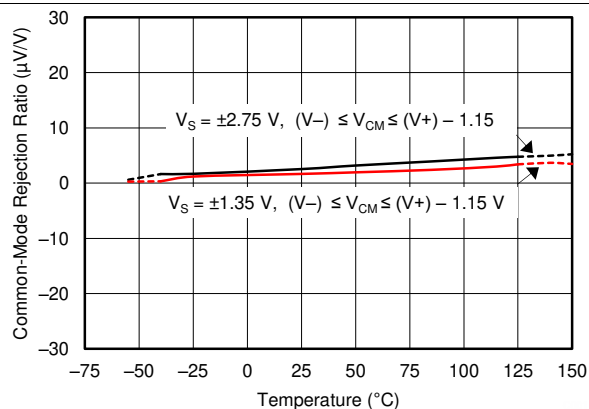

Figure 42. Common-Mode Rejection Ratio vs Temperature

### Typical Characteristics (continued)

at  $T_A = 25^\circ\text{C}$ ,  $V_+ = 5\text{ V}$ ,  $V_- = 0\text{ V}$ ,  $V_{\text{COM}} = V_O = 2.5\text{ V}$ , gain ( $G$ ) = 2,  $R_F = 1\text{ k}\Omega$ ,  $C_F = 2.7\text{ pF}$ ,  $C_{\text{LOAD}} = 20\text{ pF}$ , and  $R_{\text{LOAD}} = 2\text{ k}\Omega$  connected to 2.5 V (unless otherwise noted)

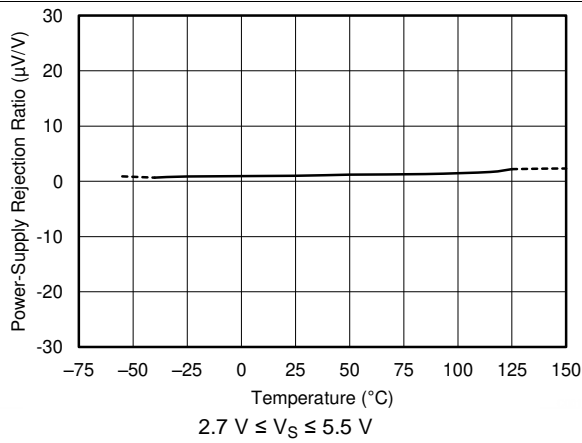

Figure 43. Power-Supply Rejection Ratio vs Temperature

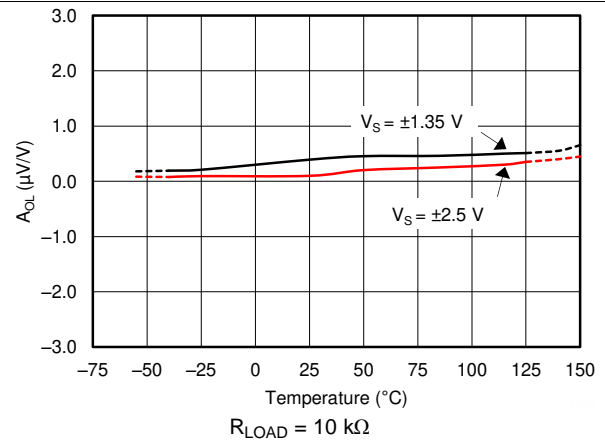

Figure 44. Open-Loop Gain vs Temperature With 10-kΩ Load

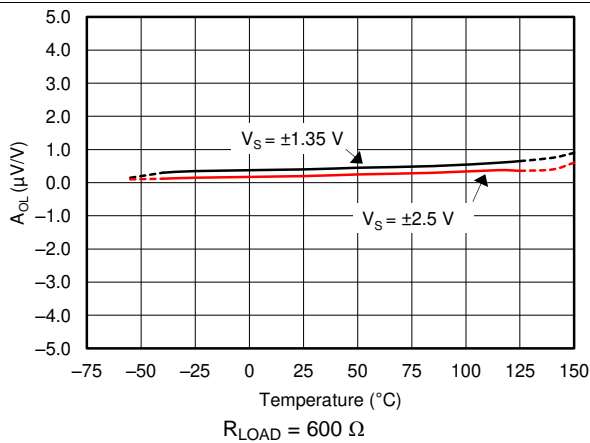

Figure 45. Open-Loop Gain vs Temperature With 600-Ω Load

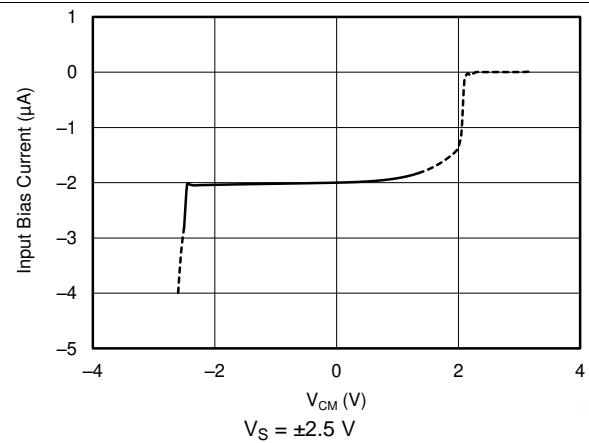

Figure 46. Input Bias Current vs Input Common-Mode Voltage

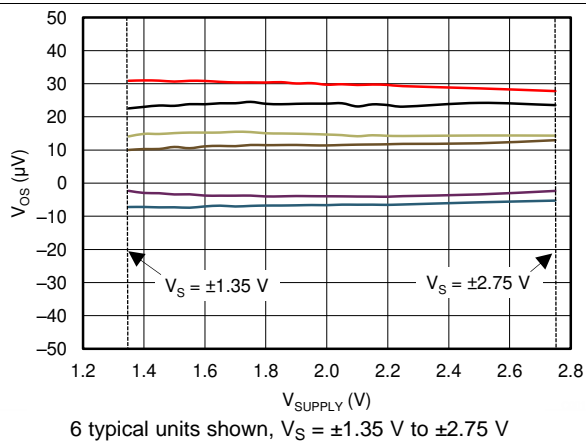

Figure 47. Input Offset Voltage vs Power-Supply Voltage

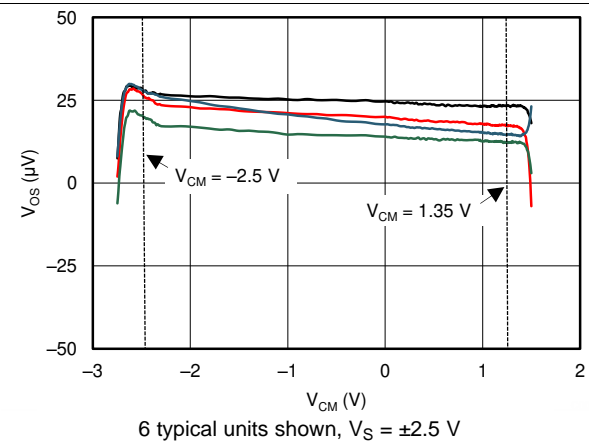
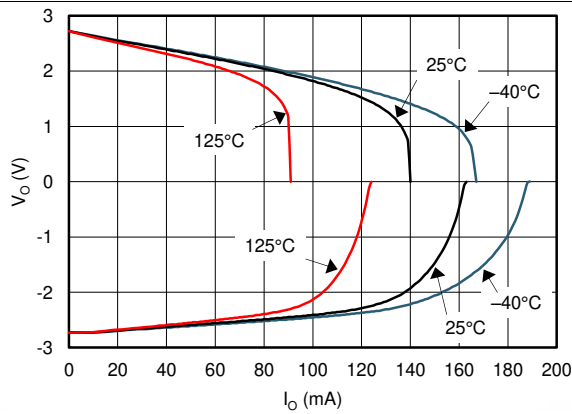

Figure 48. Input Offset Voltage vs Common-Mode Voltage



**Typical Characteristics (continued)**

at  $T_A = 25^\circ\text{C}$ ,  $V_+ = 5\text{ V}$ ,  $V_- = 0\text{ V}$ ,  $V_{\text{COM}} = V_O = 2.5\text{ V}$ , gain ( $G$ ) = 2,  $R_F = 1\text{ k}\Omega$ ,  $C_F = 2.7\text{ pF}$ ,  $C_{\text{LOAD}} = 20\text{ pF}$ , and  $R_{\text{LOAD}} = 2\text{ k}\Omega$  connected to 2.5 V (unless otherwise noted)



**Figure 49. Output Voltage vs Output Current**

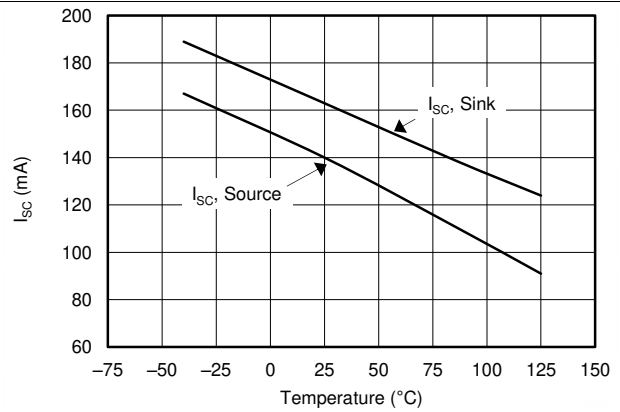

**Figure 50. Short-Circuit Current vs Temperature**

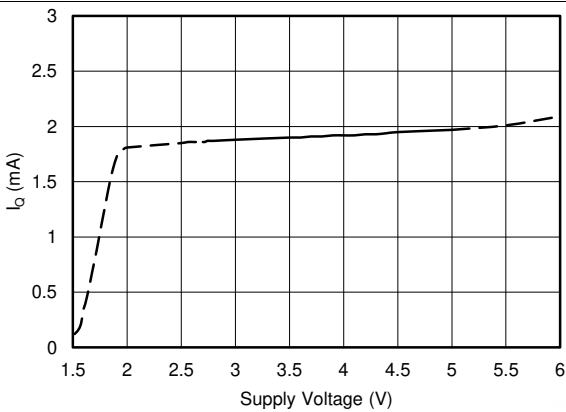

**Figure 51. Quiescent Current vs Power-Supply Voltage**

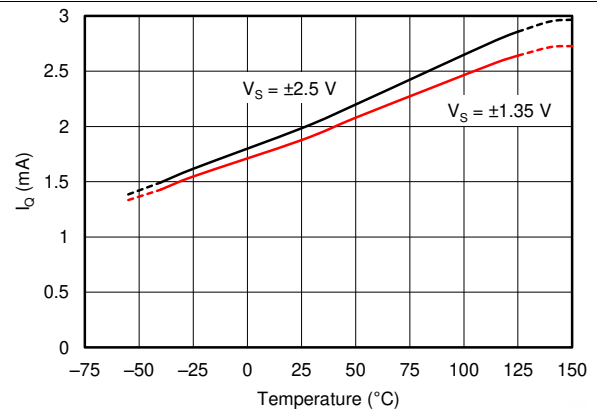

**Figure 52. Quiescent Current vs Temperature**

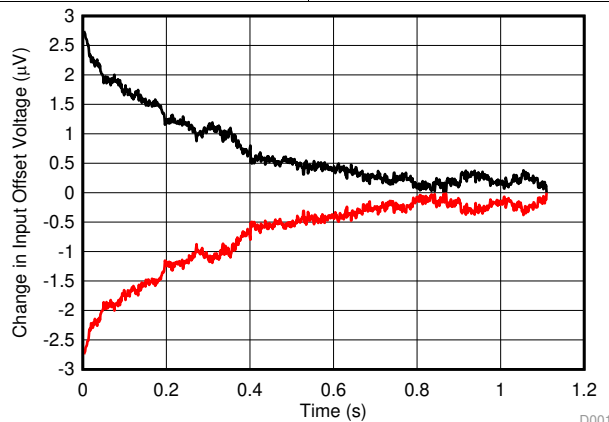

Powered on at  $t = 0\text{ s}$ , PCB dimensions: 4 in<sup>2</sup>, 2 layer, FR4

**Figure 53. Warm-Up Time**

## 7 Parameter Measurement Information

### 7.1 DC Parameter Measurements

The circuit shown in [Figure 54](#) measures the dc input offset related parameters of the OPA2626. Input offset voltage, power-supply rejection ratio, common-mode rejection ratio, and open-loop gain can be measured with this circuit. The basic test procedure requires setting the inputs (the power-supply voltage,  $V_S$ , and the common-mode voltage,  $V_{CM}$ ), to the desired values.  $V_O$  is set to the desired value by adjusting the loop-drive voltage while measuring  $V_O$ . After all inputs are configured, measure the input offset at the  $V_X$  measurement point. Calculate the input offset voltage by dividing the measured result by 101. Changing the voltages on the various inputs changes the input offset voltage. The input parameters can be measured according to the relationships illustrated in [Equation 1](#) through [Equation 5](#).

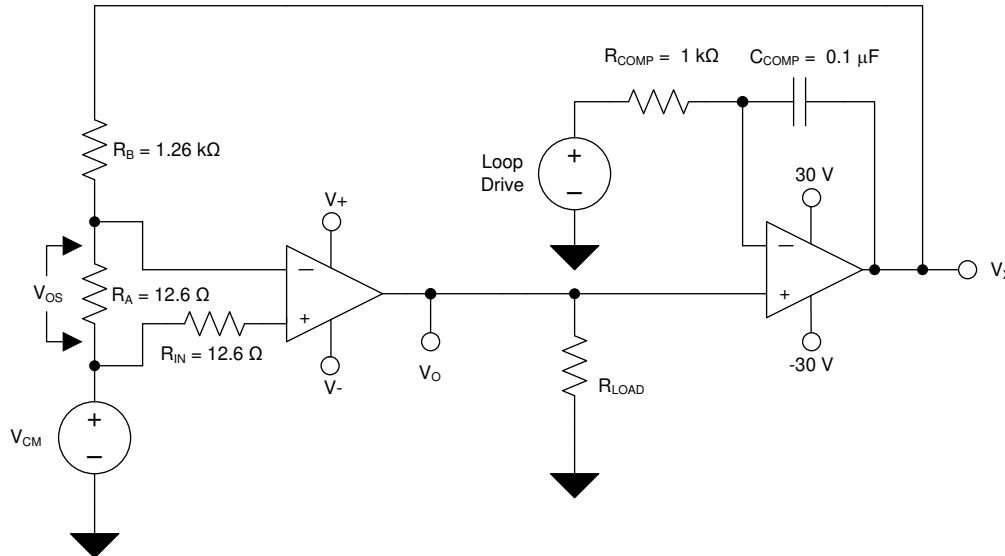

**Figure 54. DC-Parameters Measurement Circuit**

$$V_{OS} = \frac{V_X}{101} \quad (1)$$

$$V_{OS\text{Drift}} = \frac{\Delta V_{OS}}{\Delta \text{Temperature}} \quad (2)$$

$$\text{PSRR} = \frac{\Delta V_{OS}}{\Delta V_{\text{SUPPLY}}} \quad (3)$$

$$\text{CMRR} = \frac{\Delta V_{OS}}{\Delta V_{CM}} \quad (4)$$

$$\text{AOL} = \frac{\Delta V_O}{\Delta V_{OS}} \quad (5)$$

### 7.2 Transient Parameter Measurements

The circuit shown in Figure 55 measures the transient response of the OPA2626. Configure  $V+$ ,  $V-$ ,  $R_{ISO}$ ,  $R_{LOAD}$ , and  $C_{LOAD}$  as desired. Monitor the input and output voltages on an oscilloscope or other signal analyzer. Use this circuit to measure large-signal and small-signal transient response, slew rate, overshoot, and capacitive-load stability.

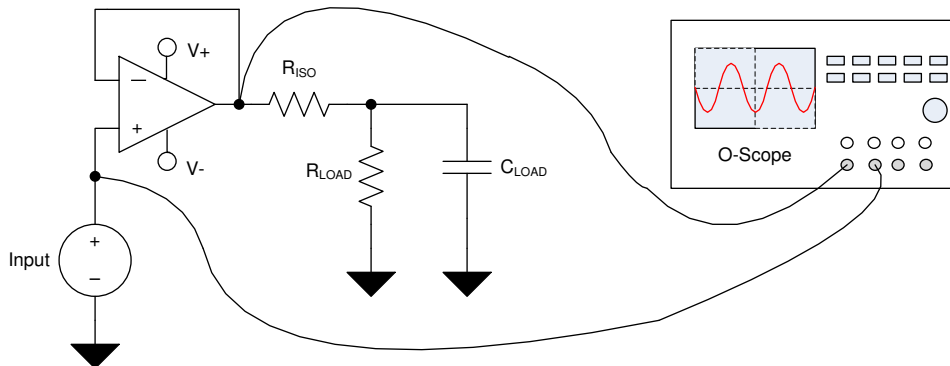

Figure 55. Pulse-Response Measurement Circuit

### 7.3 AC Parameter Measurements

The circuit shown in Figure 56 measures the ac parameters of the OPA2626. Configure  $V+$ ,  $V-$ , and  $C_{LOAD}$  as desired. The THS4271 family is used to buffer the input and output of the OPA2626 to prevent loading by the gain phase analyzer. Monitor the input and output voltages on a gain phase analyzer. Use this circuit to measure the gain bandwidth product, and open-loop gain versus frequency versus capacitive load.

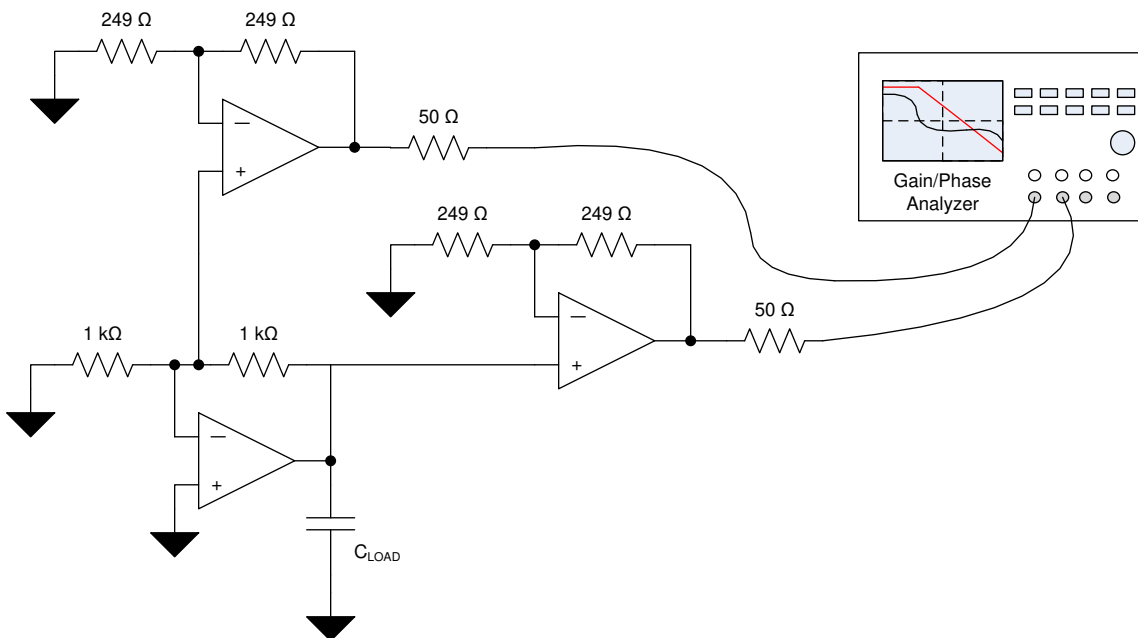
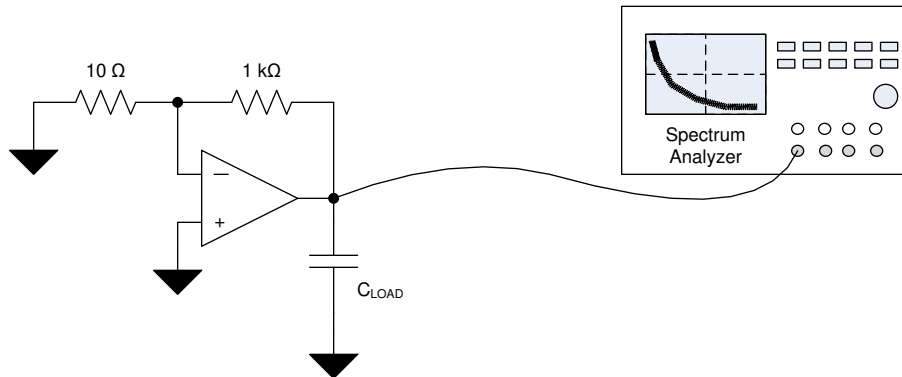

Figure 56. AC-Parameters Measurement Circuit

### 7.4 Noise Parameter Measurements

The circuit shown in [Figure 57](#) measures the voltage noise of the OPA2626. Configure V+, V–, and C<sub>LOAD</sub> as desired.



**Figure 57. Voltage Noise Measurement Circuit**

The circuit shown in [Figure 58](#) measures the current noise of the OPA2626. Configure V+, V– and C<sub>LOAD</sub> as desired.

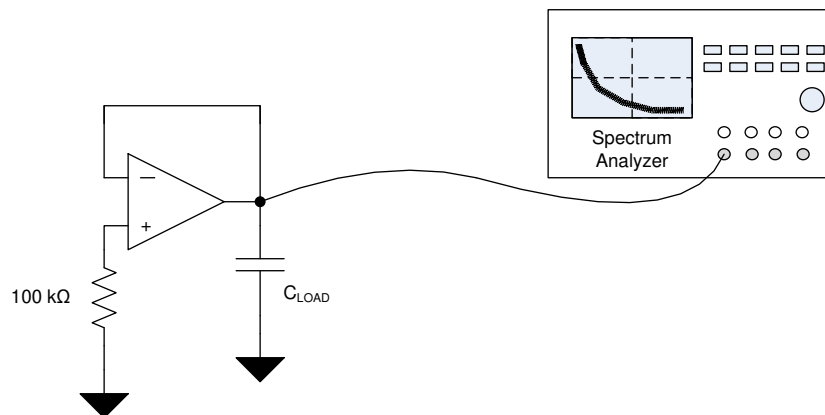

**Figure 58. Current Noise Measurement Circuit**

The circuit shown in [Figure 59](#) measures the 0.1-Hz to 10-Hz voltage noise of the OPA2626. Configure V+, V–, and C<sub>LOAD</sub> as desired.

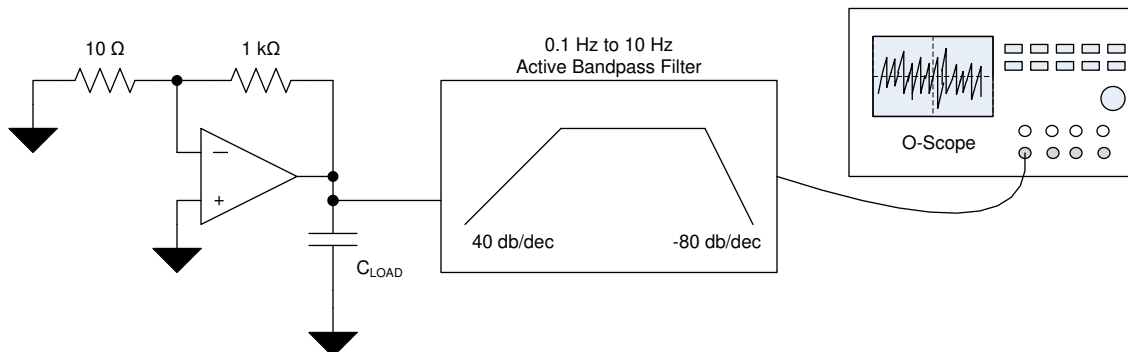

**Figure 59. 0.1-Hz to 10-Hz Voltage-Noise Measurement Circuit**

## 8 Detailed Description

### 8.1 Overview

The OPA2626 is a fast-settling, high slew rate, high-bandwidth, voltage-feedback operational amplifier. Low offset and low offset drift combine with the superior dynamic performance and low output impedance of this device, resulting in an amplifier suited for driving 16-bit and 18-bit SAR ADCs, and buffering precision voltage references in industrial applications. The OPA2626 includes low-noise input, slew boost, and rail-to-rail output stages.

### 8.2 Functional Block Diagram

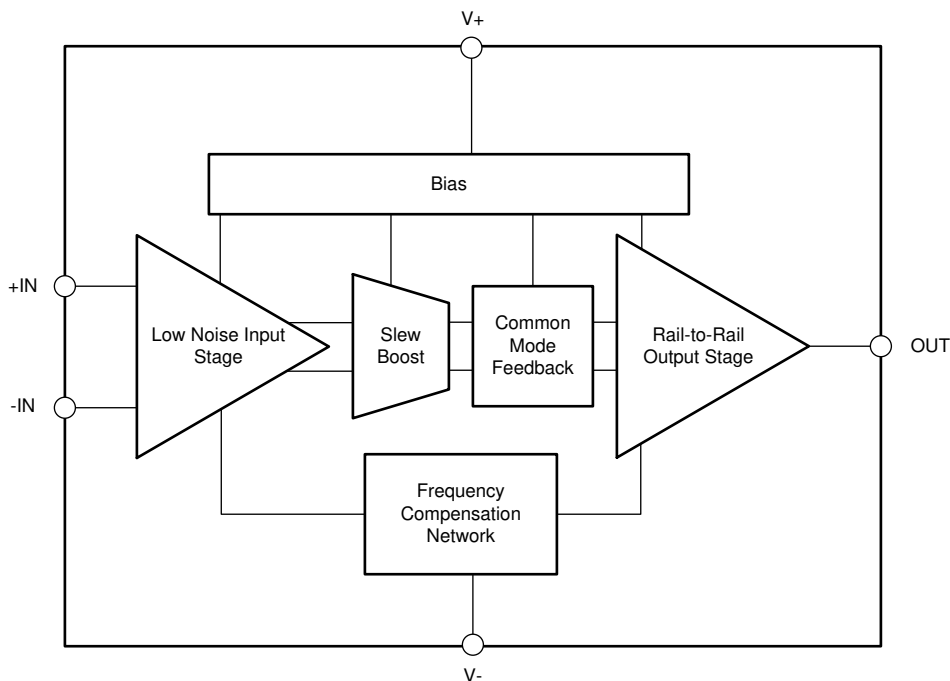

## 8.3 Feature Description

### 8.3.1 SAR ADC Driver

The OPA2626 is designed to drive precision (16-bit and 18-bit) SAR ADCs at sample rates up to 1 MSPS. The combination of low output impedance, low THD, low noise, and fast settling time make the OPA2626 the ideal choice for driving both the SAR ADC inputs, as well as the reference input to the ADC. Internal slew boost circuitry increases the slew rate as a function of the input signal magnitude, resulting in settling from a 4-V step input to 16-bit levels within 280 ns. Low output impedance ( $1\ \Omega$  at 1 MHz) ensures capacitive load stability with minimal overshoot.

### 8.3.2 Electrical Overstress

Designers often ask questions about the capability of an operational amplifier to withstand electrical overstress (EOS). These questions tend to focus on the device inputs, but may involve the supply voltage pins or even the output pin. Each of these different pin functions have electrical stress limits determined by the voltage breakdown characteristics of the particular semiconductor fabrication process and specific circuits connected to the pin. Additionally, internal electrostatic discharge (ESD) protection is built into these circuits to protect them from accidental ESD events both before and during product assembly. A good understanding of this basic ESD circuitry and how the ESD circuitry relates to an electrical overstress event is helpful. Figure 60 provides a diagram of the ESD circuits contained in the OPA2626. The ESD protection circuitry involves several current-steering diodes connected from the input and output pins and routed back to the internal power-supply lines, where the diodes meet at an absorption device or the power-supply ESD cell, internal to the operational amplifier. This protection circuitry is intended to remain inactive during normal circuit operation.

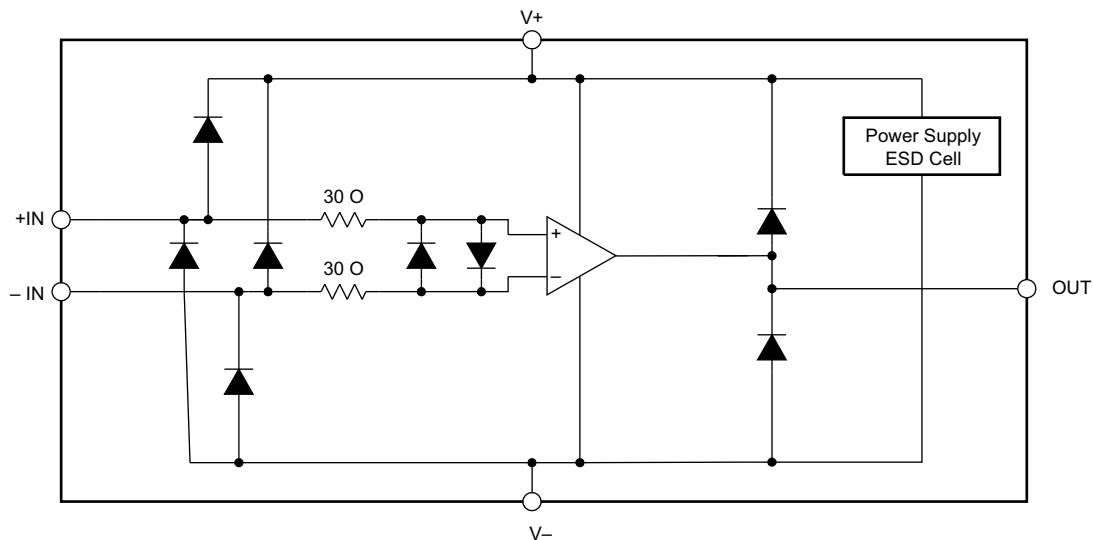

**Figure 60. Simplified ESD Circuit**

## 8.4 Device Functional Modes

The OPA2626 has a single functional mode and is operational when the power supply voltage,  $V_S$ , is between 2.7 V ( $\pm 1.35$  V) and 5.5 V ( $\pm 2.75$  V).

### 8.4.1 High-Drive Mode

The OPA2626 has a 120-MHz gain bandwidth, 2.5-nV/ $\sqrt{\text{Hz}}$  input-referred noise, and consumes 2 mA of quiescent current. Additionally, the OPA2626 has an offset voltage of 100  $\mu\text{V}$  (maximum) and an offset voltage drift of 1  $\mu\text{V}/^\circ\text{C}$  (typical). This combination of high precision, high speed, and low noise makes this device suitable for use as an input driver for high-precision, high-throughput SAR ADCs such as the ADS88xx family of SAR ADCs, as illustrated in Figure 61.

## 9 Application and Implementation

### NOTE

Information in the following applications sections is not part of the TI component specification, and TI does not warrant its accuracy or completeness. TI's customers are responsible for determining suitability of components for their purposes. Customers should validate and test their design implementation to confirm system functionality.

### 9.1 Application Information

The OPA2626 consists of precision, high-speed, voltage-feedback operational amplifiers. Fast settling to 16-bit and 18-bit levels, low THD, and low noise make the OPA2626 suitable for driving SAR ADC inputs and buffering precision voltage references. With a wide power-supply voltage range from 2.7 V to 5.5 V, and operating from  $-40^\circ\text{C}$  to  $+125^\circ\text{C}$ , the OPA2626 is suitable for a variety of high-speed, industrial applications. The following sections show application information for the OPA2626. For simplicity, power-supply decoupling capacitors are not shown in these diagrams.

### 9.2 Typical Applications

#### 9.2.1 Single-Supply, 16-Bit, 1-MSPS SAR ADC Driver

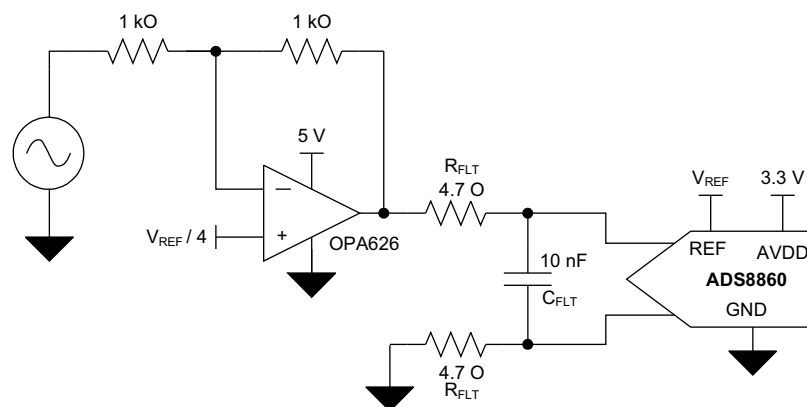
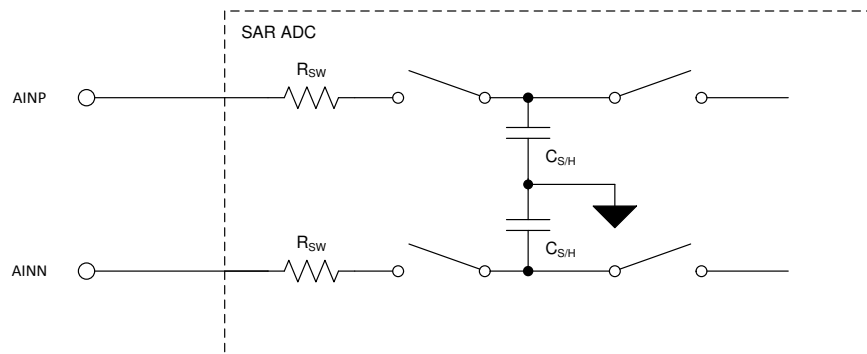

Figure 61. Single-Supply, 16-Bit, 1-MSPS SAR ADC Driver

## Typical Applications (continued)

### 9.2.1.1 Design Requirements

A SAR ADC, such as the [ADS8860](#) device, uses sampling capacitors on the data converter input. During the signal acquisition phase, these sampling capacitors are connected to the ADC analog input terminals AINP and AINN (pins 3 and 4), through a set of switches. After the acquisition period has elapsed, the internal sampling capacitors are disconnected from the input terminals (pins 3 and 4) and connected to the ADC input through a second set of switches, during this period the ADC is performing the analog-to-digital conversion. [Figure 62](#) shows this architecture.



**Figure 62. Simplified SAR ADC Input**

The SAR ADC inputs and sampling capacitors must be driven by the OPA2626 to 16-bit levels within the acquisition time of the ADC. For the example illustrated in [Figure 61](#), the OPA2626 is used to drive the ADS8860 at a sample rate of 1 MSPS.

### 9.2.1.2 Detailed Design Procedure

The circuit illustrated in [Figure 61](#) consists of the SAR ADC driver, a low-pass filter, and the SAR ADC. The SAR ADC driver circuit consists of an OPA2626 configured in an inverting gain of 1. The filter consists of  $R_{FLT}$  and  $C_{FLT}$ , connected between the OPA2626 output and the ADS8860 input. Selecting the proper values for each of these passive components is critical to obtain the best performance from the ADC. Capacitor  $C_{FLT}$  serves as a charge reservoir, providing the necessary charge to the ADC sampling capacitors. The dynamic load presented by the ADC creates a glitch on the filter capacitor,  $C_{FLT}$ . To minimize the magnitude of this glitch, choose a value for  $C_{FLT}$  large enough to maintain a glitch amplitude of less than 100 mV. Maintaining such a low glitch amplitude at the amplifier output makes sure that the amplifier remains in the linear operating region, and results in a minimum settling time. Using [Equation 6](#), a 10-nF capacitor is selected for  $C_{FLT}$ .

$$C_{FLT} \geq 15 \times C_{SH} \quad (6)$$

Connecting a 10-nF capacitor directly to the OPA2626 output degrades the OPA2626 phase margin and results in stability and settling-time problems. To properly drive the 10-nF capacitor, use a series resistor ( $R_{FLT}$ ) to isolate the capacitor,  $C_{FLT}$ , from the OPA2626.  $R_{FLT}$  must be sized based upon several constraints. To determine a suitable value for  $R_{FLT}$ , consider the impact upon the THD resulting from the voltage divider effect from  $R_{FLT}$  reacting with the switch resistance ( $R_{SW}$ ) of the ADC input circuit, as well as the impact of the output impedance upon amplifier stability. In this example, 4.7- $\Omega$  resistors are selected. In this design example, [Figure 13](#) can be used to estimate a suitable value for  $R_{ISO}$ .  $R_{ISO}$  represents the total resistance in series with  $C_{FLT}$ , and in this example is equivalent to  $2 \times R_{FLT}$ .

For step-by-step design procedure, circuit schematics, bill of materials, printed circuit board (PCB) files, simulation results, and test results, refer to the [Power-optimized 16-bit 1MSPS Data Acquisition Block for Lowest Distortion and Noise Reference Design reference guide](#).



**9.2.1.3 Application Curve**

Figure 63 shows the performance of the circuit in Figure 61.

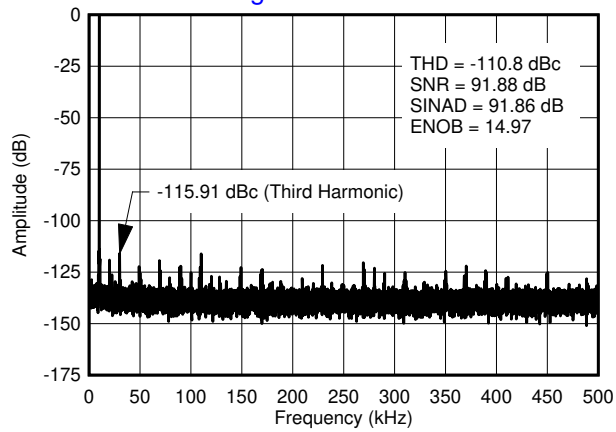

4096-point FFT at 1 MSPS,  $f_{IN} = 10 \text{ kHz}$ ,  $V_{IN} = 1.5 V_{RMS}$

**Figure 63. ADC Output FFT for Figure 61**

### 9.2.2 Single-Supply, 16-Bit, 1-MSPS, Multiplexed, SAR ADC Driver

In order to operate a high-resolution, 16-bit ADC at its maximum throughput, the full-scale voltage step must settle to better than 16-bit accuracy at the ADC inputs within the minimum specified acquisition time ( $t_{ACQ}$ ). This settling imposes very stringent requirements on the driver amplifier in terms of large-signal bandwidth, slew rate, and settling time. Figure 64 shows a typical multiplexed ADC driver application using the OPA2626.

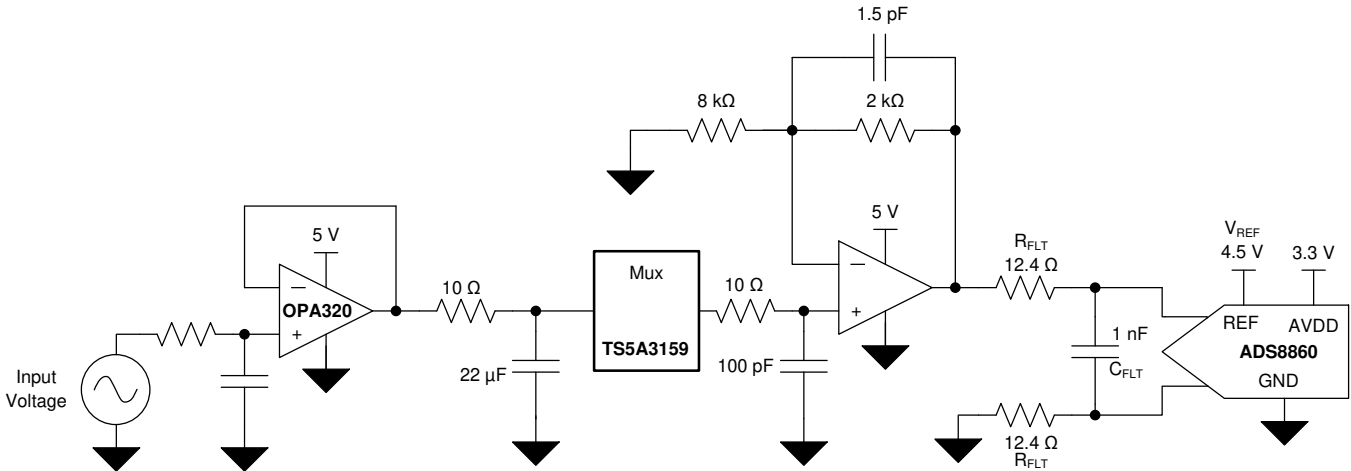

Figure 64. Single-Supply, 16-Bit, 1-MSPS, Multiplexed, SAR ADC Driver

#### 9.2.2.1 Design Requirements

To optimize this circuit for performance, this design does not allow any large signal input transients at the driver circuit inputs for a small quiet-time period ( $t_{QT}$ ) towards the end of the previous conversion. The input step voltage can appear anytime from the beginning of conversion (CONVST rising edge) until the elapse of a half cycle time ( $0.5 \times t_{CYC}$ ). This timing constraint on the input step allows a minimum settling time of ( $t_{QT} + t_{ACQ}$ ) for the ADC input to settle within the required accuracy, in the worst-case scenario.  $t_{QT} + t_{ACQ}$  is the total time in which the output of the amplifier has to slew and settle within the required accuracy before the next conversion starts. Figure 65 shows this timing sequence.

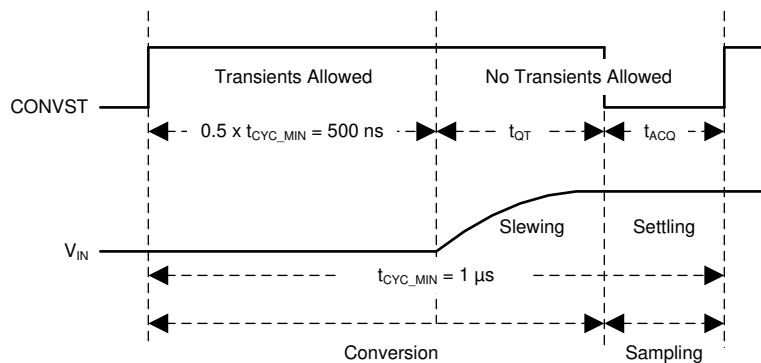

Figure 65. Timing Diagram for Input Signals

### 9.2.2.2 Detailed Design Procedure

An ADC input driver circuit consists of two parts: a driving amplifier and a fly-wheel RC filter. The amplifier is used for signal conditioning of the input voltage and the low output impedance provides a buffer between the signal source and the ADC input. The RC filter helps attenuate the sampling charge-injection from the switched-capacitor input stage of the ADC and acts as an antialiasing filter to band-limit the wideband noise contributed by the front-end circuit. The design of the ADC input driver involves optimizing the bandwidth of the circuit, driven by the following requirements:

- The  $R_{FLT}$  and  $C_{FLT}$  filter bandwidth must be low to band-limit the noise fed into the input of the ADC, thereby increasing the signal-to-noise ratio (SNR) of the system
- The overall system bandwidth must be large enough to accommodate optimal settling of the input signal at the ADC input before the conversion starts

$C_{FLT}$  is chosen based upon Equation 7.  $C_{FLT}$  is chosen to be 1 nF.

$$C_{FLT} \geq 15 \times C_{SH} \quad (7)$$

Connecting a 1-nF capacitor directly to the output of the OPA2626 degrades the OPA2626 phase margin and results in stability and settling time problems. To properly drive the 1-nF capacitor, a series resistor,  $R_{FLT}$ , is used to isolate the capacitor,  $C_{FLT}$ , from the OPA2626.  $R_{FLT}$  must be sized based upon several constraints. To determine a suitable value for  $R_{FLT}$ , the system designer must consider the impact upon the THD resulting from the voltage divider effect from  $R_{FLT}$  reacting with the switch resistance,  $R_{SW}$ , of the ADC input circuit as well as the impact of the output impedance upon amplifier stability. In this example 12.4- $\Omega$  resistors are selected. In this design example, Figure 12 can be used to estimate a suitable value for  $R_{ISO}$ .  $R_{ISO}$  represents the total resistance in series with  $C_{FLT}$ , which in this example is equivalent to  $2 \times R_{FLT}$ .

**For step-by-step design procedure**, circuit schematics, bill of materials, printed circuit board (PCB) files, simulation results, and test results, refer to the [18-Bit Data Acquisition \(DAQ\) Block Optimized for 1- \$\mu\$ s Full-Scale Step Response reference guide](#).

### 9.2.2.3 Application Curves

Figure 66 and Figure 67 show the performance of the circuit in Figure 64.

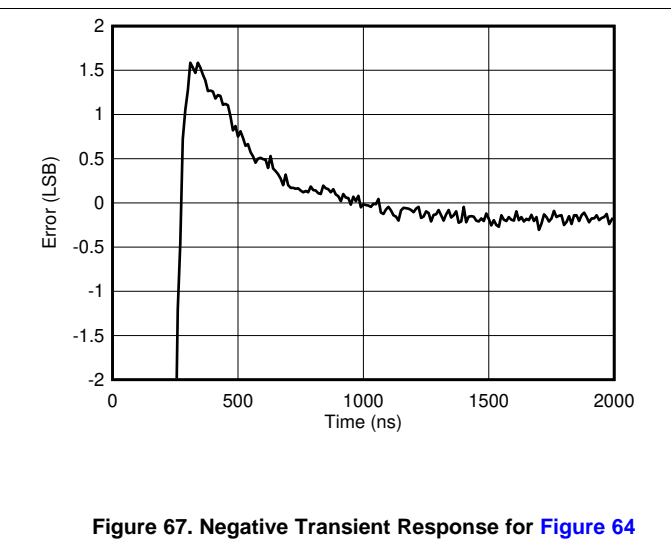
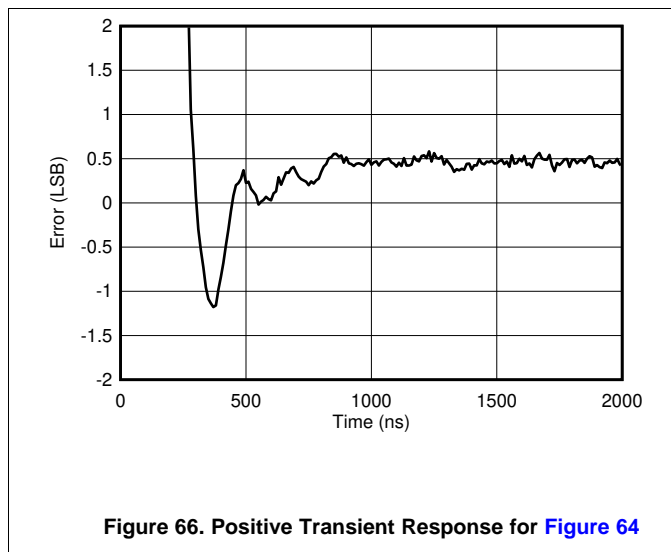

## 10 Power Supply Recommendations

The OPA2626 is specified for operation from 2.7 V to 5.5 V ( $\pm 1.35$  V to  $\pm 2.75$  V); many specifications apply from  $-40^{\circ}\text{C}$  to  $+125^{\circ}\text{C}$ . Parameters that can exhibit significant variance with regard to operating voltage or temperature are presented in the [Typical Characteristics](#) section. Place bypass capacitors close to the power-supply pins to reduce errors coupling in from noisy or high-impedance power supplies. For more detailed information on bypass capacitor placement, see the [Layout](#) section.

### CAUTION

Supply voltages larger than 6 V can cause permanent damage to the device. See the [Absolute Maximum Ratings](#) section.

## 11 Layout

### 11.1 Layout Guidelines

For best operational performance of the device, use good PCB layout practices, including:

- Use bypass capacitors to reduce the noise coupled from the power supply. Connect low ESR, ceramic, bypass capacitors between the power-supply pins (V+ and V-) and the ground plane. Place the bypass capacitors as close to the device as possible with the 100-nF capacitor closest to the device, as indicated in [Figure 68](#). For single-supply applications, bypass capacitors on the V- pin are not required.
- Separate grounding for analog and digital portions of the circuitry is one of the simplest and most-effective methods of noise suppression. One or more layers on multilayer PCBs are usually devoted to ground planes. A ground plane helps distribute heat and reduces electromagnetic interference (EMI) noise pickup. Make sure to physically separate digital and analog grounds paying attention to the flow of the ground current. (For more details, see the [Circuit Board Layout Techniques chapter extract](#).)
- In order to reduce parasitic coupling, run the input traces as far away from the supply or output traces as possible. If the traces cannot be kept separate, crossing the sensitive trace perpendicular is better as opposed to in parallel with the noisy trace.
- Minimize parasitic coupling between +IN and OUT for best ac performance.
- Place the external components as close to the device as possible. As illustrated in [Figure 68](#), keeping RF, CF, and RG close to the inverting input minimizes parasitic capacitance.
- Keep the length of input traces as short as possible. Always remember that the input traces are the most sensitive part of the circuit.
- Cleaning the PCB following board assembly is recommended for best performance.
- Any precision integrated circuit can experience performance shifts resulting from moisture ingress into the plastic package. Following any aqueous PCB cleaning process, bake the PCB assembly to remove moisture introduced into the device packaging during the cleaning process. A low-temperature, post-cleaning bake at  $85^{\circ}\text{C}$  for 30 minutes is sufficient for most circumstances.

## 11.2 Layout Example

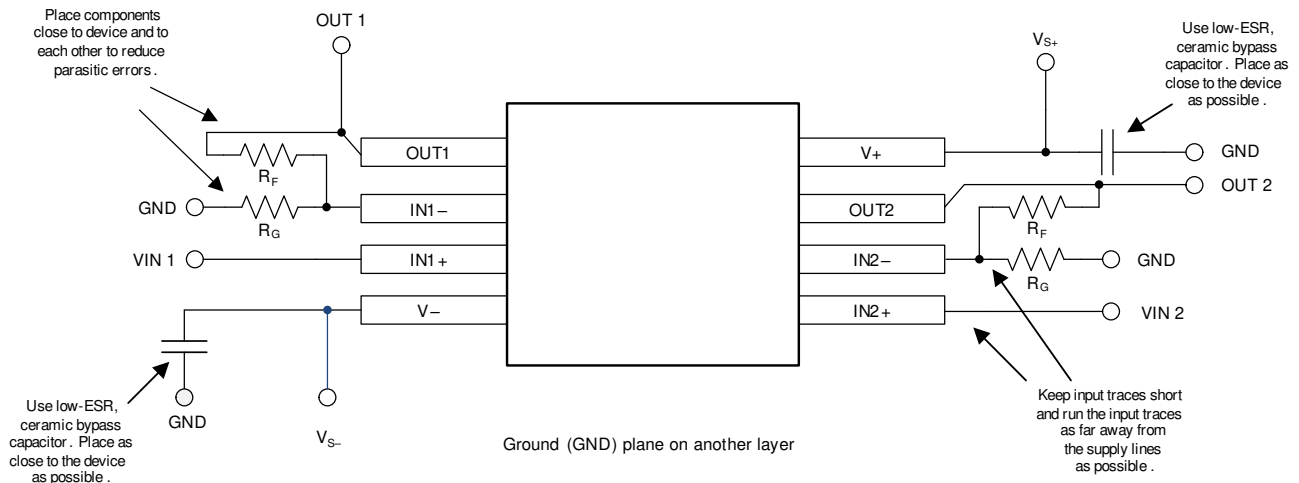

**Figure 68. PCB Layout Example**

## 12 Device and Documentation Support

### 12.1 Device Support

#### 12.1.1 Development Support

##### 12.1.1.1 TINA-TI™ (Free Software Download)

TINA™ is a simple, powerful, and easy-to-use circuit simulation program based on a SPICE engine. TINA-TI is a free, fully-functional version of the TINA software, preloaded with a library of macro models in addition to a range of both passive and active models. TINA-TI provides all the conventional dc, transient, and frequency domain analysis of SPICE, as well as additional design capabilities.

Available as a [free download](#) from the Analog eLab Design Center, TINA-TI offers extensive post-processing capability that allows users to format results in a variety of ways. Virtual instruments offer the ability to select input waveforms and probe circuit nodes, voltages, and waveforms, creating a dynamic quick-start tool.

##### 12.1.1.2 TI Precision Designs

TI Precision Designs are available online at <http://www.ti.com/ww/en/analog/precision-designs/>. TI Precision Designs are analog solutions created by TI's precision analog applications experts and offer the theory of operation, component selection, simulation, complete PCB schematic and layout, bill of materials, and measured performance of many useful circuits.

### 12.2 Documentation Support

#### 12.2.1 Related Documentation

For related documentation see the following:

- Texas Instruments, [Fast Settling 16-bit 1MSPS Multiplexed Data Acquisition Reference Design design guide](#)
- Texas Instruments, [Power-optimized 16-bit 1MSPS Data Acquisition Block for Lowest Distortion and Noise Reference Design reference guide](#)
- Texas Instruments, [18-Bit Data Acquisition \(DAQ\) Block Optimized for 1- \$\mu\$ s Full-Scale Step Response reference guide](#)
- Texas Instruments, [Circuit Board Layout Techniques chapter extract](#)
- Texas Instruments, [THS427x Low Noise, High Slew Rate, Unity Gain Stable Voltage Feedback Amplifier data sheet](#)
- Texas Instruments, [ADS8860 16-bit, 1-MSPS, serial interface, micropower, miniature, single-ended input, SAR analog-to-digital converter data sheet](#)

#### 12.3 Receiving Notification of Documentation Updates

To receive notification of documentation updates, navigate to the device product folder on ti.com. In the upper right corner, click on *Alert me* to register and receive a weekly digest of any product information that has changed. For change details, review the revision history included in any revised document.

#### 12.4 Community Resources

TI E2E™ [support forums](#) are an engineer's go-to source for fast, verified answers and design help — straight from the experts. Search existing answers or ask your own question to get the quick design help you need.

Linked content is provided "AS IS" by the respective contributors. They do not constitute TI specifications and do not necessarily reflect TI's views; see TI's [Terms of Use](#).

#### 12.5 Trademarks

E2E is a trademark of Texas Instruments.

TINA-TI is a trademark of Texas Instruments, Inc and DesignSoft, Inc.

TINA is a trademark of DesignSoft, Inc.

All other trademarks are the property of their respective owners.

## 12.6 Electrostatic Discharge Caution



This integrated circuit can be damaged by ESD. Texas Instruments recommends that all integrated circuits be handled with appropriate precautions. Failure to observe proper handling and installation procedures can cause damage.

ESD damage can range from subtle performance degradation to complete device failure. Precision integrated circuits may be more susceptible to damage because very small parametric changes could cause the device not to meet its published specifications.

## 12.7 Glossary

[SLYZ022](#) — *TI Glossary*.

This glossary lists and explains terms, acronyms, and definitions.

## 13 Mechanical, Packaging, and Orderable Information

The following pages include mechanical, packaging, and orderable information. This information is the most current data available for the designated devices. This data is subject to change without notice and revision of this document. For browser-based versions of this data sheet, refer to the left-hand navigation.

**PACKAGING INFORMATION**

Orderable part number	Status (1)	Material type (2)	Package   Pins	Package qty   Carrier	RoHS (3)	Lead finish/ Ball material (4)	MSL rating/ Peak reflow (5)	Op temp (°C)	Part marking (6)
<a href="#">OPA2626IDGKR</a>	Active	Production	VSSOP (DGK)   8	2500   LARGE T&R	Yes	NIPDAU   NIPDAUAG	Level-2-260C-1 YEAR	-40 to 125	16R6
OPA2626IDGKR.B	Active	Production	VSSOP (DGK)   8	2500   LARGE T&R	Yes	NIPDAU	Level-2-260C-1 YEAR	-40 to 125	16R6
<a href="#">OPA2626IDGKT</a>	Active	Production	VSSOP (DGK)   8	250   SMALL T&R	Yes	NIPDAU   NIPDAUAG	Level-2-260C-1 YEAR	-40 to 125	16R6
OPA2626IDGKT.B	Active	Production	VSSOP (DGK)   8	250   SMALL T&R	Yes	NIPDAU	Level-2-260C-1 YEAR	-40 to 125	16R6

(1) **Status:** For more details on status, see our [product life cycle](#).

(2) **Material type:** When designated, preproduction parts are prototypes/experimental devices, and are not yet approved or released for full production. Testing and final process, including without limitation quality assurance, reliability performance testing, and/or process qualification, may not yet be complete, and this item is subject to further changes or possible discontinuation. If available for ordering, purchases will be subject to an additional waiver at checkout, and are intended for early internal evaluation purposes only. These items are sold without warranties of any kind.

(3) **RoHS values:** Yes, No, RoHS Exempt. See the [TI RoHS Statement](#) for additional information and value definition.

(4) **Lead finish/Ball material:** Parts may have multiple material finish options. Finish options are separated by a vertical ruled line. Lead finish/Ball material values may wrap to two lines if the finish value exceeds the maximum column width.

(5) **MSL rating/Peak reflow:** The moisture sensitivity level ratings and peak solder (reflow) temperatures. In the event that a part has multiple moisture sensitivity ratings, only the lowest level per JEDEC standards is shown. Refer to the shipping label for the actual reflow temperature that will be used to mount the part to the printed circuit board.

(6) **Part marking:** There may be an additional marking, which relates to the logo, the lot trace code information, or the environmental category of the part.

Multiple part markings will be inside parentheses. Only one part marking contained in parentheses and separated by a "~" will appear on a part. If a line is indented then it is a continuation of the previous line and the two combined represent the entire part marking for that device.

**Important Information and Disclaimer:** The information provided on this page represents TI's knowledge and belief as of the date that it is provided. TI bases its knowledge and belief on information provided by third parties, and makes no representation or warranty as to the accuracy of such information. Efforts are underway to better integrate information from third parties. TI has taken and continues to take reasonable steps to provide representative and accurate information but may not have conducted destructive testing or chemical analysis on incoming materials and chemicals. TI and TI suppliers consider certain information to be proprietary, and thus CAS numbers and other limited information may not be available for release.

In no event shall TI's liability arising out of such information exceed the total purchase price of the TI part(s) at issue in this document sold by TI to Customer on an annual basis.



**TAPE AND REEL INFORMATION**

**QUADRANT ASSIGNMENTS FOR PIN 1 ORIENTATION IN TAPE**

\*All dimensions are nominal

Device	Package Type	Package Drawing	Pins	SPQ	Reel Diameter (mm)	Reel Width W1 (mm)	A0 (mm)	B0 (mm)	K0 (mm)	P1 (mm)	W (mm)	Pin1 Quadrant
OPA2626IDGKR	VSSOP	DGK	8	2500	330.0	12.4	5.3	3.4	1.4	8.0	12.0	Q1
OPA2626IDGKR	VSSOP	DGK	8	2500	330.0	12.4	5.3	3.4	1.4	8.0	12.0	Q1
OPA2626IDGKT	VSSOP	DGK	8	250	330.0	12.4	5.3	3.4	1.4	8.0	12.0	Q1

**TAPE AND REEL BOX DIMENSIONS**

\*All dimensions are nominal

Device	Package Type	Package Drawing	Pins	SPQ	Length (mm)	Width (mm)	Height (mm)
OPA2626IDGKR	VSSOP	DGK	8	2500	366.0	364.0	50.0
OPA2626IDGKR	VSSOP	DGK	8	2500	353.0	353.0	32.0
OPA2626IDGKT	VSSOP	DGK	8	250	366.0	364.0	50.0

# DGK0008A



# PACKAGE OUTLINE

VSSOP - 1.1 mm max height

SMALL OUTLINE PACKAGE



4214862/A 04/2023

**NOTES:**

PowerPAD is a trademark of Texas Instruments.

1. All linear dimensions are in millimeters. Any dimensions in parenthesis are for reference only. Dimensioning and tolerancing per ASME Y14.5M.
2. This drawing is subject to change without notice.
3. This dimension does not include mold flash, protrusions, or gate burrs. Mold flash, protrusions, or gate burrs shall not exceed 0.15 mm per side.
4. This dimension does not include interlead flash. Interlead flash shall not exceed 0.25 mm per side.
5. Reference JEDEC registration MO-187.

# EXAMPLE BOARD LAYOUT

DGK0008A

™ VSSOP - 1.1 mm max height

SMALL OUTLINE PACKAGE



LAND PATTERN EXAMPLE  
EXPOSED METAL SHOWN  
SCALE: 15X



4214862/A 04/2023

NOTES: (continued)

6. Publication IPC-7351 may have alternate designs.
7. Solder mask tolerances between and around signal pads can vary based on board fabrication site.
8. Vias are optional depending on application, refer to device data sheet. If any vias are implemented, refer to their locations shown on this view. It is recommended that vias under paste be filled, plugged or tented.
9. Size of metal pad may vary due to creepage requirement.

# EXAMPLE STENCIL DESIGN

DGK0008A

<sup>TM</sup> VSSOP - 1.1 mm max height

SMALL OUTLINE PACKAGE



SOLDER PASTE EXAMPLE  
SCALE: 15X

4214862/A 04/2023

NOTES: (continued)

11. Laser cutting apertures with trapezoidal walls and rounded corners may offer better paste release. IPC-7525 may have alternate design recommendations.
12. Board assembly site may have different recommendations for stencil design.

## IMPORTANT NOTICE AND DISCLAIMER

TI PROVIDES TECHNICAL AND RELIABILITY DATA (INCLUDING DATASHEETS), DESIGN RESOURCES (INCLUDING REFERENCE DESIGNS), APPLICATION OR OTHER DESIGN ADVICE, WEB TOOLS, SAFETY INFORMATION, AND OTHER RESOURCES "AS IS" AND WITH ALL FAULTS, AND DISCLAIMS ALL WARRANTIES, EXPRESS AND IMPLIED, INCLUDING WITHOUT LIMITATION ANY IMPLIED WARRANTIES OF MERCHANTABILITY, FITNESS FOR A PARTICULAR PURPOSE OR NON-INFRINGEMENT OF THIRD PARTY INTELLECTUAL PROPERTY RIGHTS.

These resources are intended for skilled developers designing with TI products. You are solely responsible for (1) selecting the appropriate TI products for your application, (2) designing, validating and testing your application, and (3) ensuring your application meets applicable standards, and any other safety, security, regulatory or other requirements.

These resources are subject to change without notice. TI grants you permission to use these resources only for development of an application that uses the TI products described in the resource. Other reproduction and display of these resources is prohibited. No license is granted to any other TI intellectual property right or to any third party intellectual property right. TI disclaims responsibility for, and you fully indemnify TI and its representatives against any claims, damages, costs, losses, and liabilities arising out of your use of these resources.

TI's products are provided subject to [TI's Terms of Sale](#), [TI's General Quality Guidelines](#), or other applicable terms available either on [ti.com](#) or provided in conjunction with such TI products. TI's provision of these resources does not expand or otherwise alter TI's applicable warranties or warranty disclaimers for TI products. Unless TI explicitly designates a product as custom or customer-specified, TI products are standard, catalog, general purpose devices.

TI objects to and rejects any additional or different terms you may propose.

Copyright © 2026, Texas Instruments Incorporated

Last updated 10/2025