

36-V, SINGLE-SUPPLY, LOW-POWER OPERATIONAL AMPLIFIER

Check for Samples: [OPA170-EP](#)

FEATURES

- **Supply Range: +2.7V to +36V, ±1.35V to ±18V**
- **Low Noise: 19nV/√Hz**
- **RFI Filtered Inputs**
- **Input Range Includes the Negative Supply**
- **Input Range Operates to Positive Supply**
- **Rail-to-Rail Output**
- **Gain Bandwidth: 1.2MHz**
- **Low Quiescent Current: 110µA per Amplifier**
- **High Common-Mode Rejection: 120dB**
- **Low Bias Current: 15pA (max)**
- **microPackage:**
 - Single in 5-Pin SOT553

APPLICATIONS

- Tracking Amplifier in Power Modules
- Merchant Power Supplies
- Transducer Amplifiers
- Bridge Amplifiers
- Temperature Measurements
- Strain Gauge Amplifiers
- Precision Integrators
- Battery-Powered Instruments
- Test Equipment

SUPPORTS DEFENSE, AEROSPACE, AND MEDICAL APPLICATIONS

- **Controlled Baseline**
- **One Assembly or Test Site**
- **One Fabrication Site**
- **Available in Extended (–40°C to 150°C) Temperature Range ⁽¹⁾**
- **Extended Product Life Cycle**
- **Extended Product-Change Notification**
- **Product Traceability**

(1) Additional temperature ranges available - contact factory

DESCRIPTION

The OPA170 is a 36-V, single-supply, low-noise operational amplifier that features a micro package with the ability to operate on supplies ranging from +2.7V (±1.35V) to +36V (±18V). It offers good offset, drift, and bandwidth with low quiescent current.

Unlike most op amps, which are specified at only one supply voltage, the OPA170 is specified from +2.7V to +36V. Input signals beyond the supply rails do not cause phase reversal. The OPA170 is stable with capacitive loads up to 300pF. The input can operate 100mV below the negative rail and within 2V of the positive rail for normal operation. Note that these devices can operate with full rail-to-rail input 100mV beyond the positive rail, but with reduced performance within 2V of the positive rail.

The OPA170 is available in the SOT553-5 package and is specified from –40°C to +150°C.

Package Footprint (to Scale)



Package Height (to Scale)



DRL (SOT553)

Smallest Packaging for 36V Op Amps



Please be aware that an important notice concerning availability, standard warranty, and use in critical applications of Texas Instruments semiconductor products and disclaimers thereto appears at the end of this data sheet.

All trademarks are the property of their respective owners.



This integrated circuit can be damaged by ESD. Texas Instruments recommends that all integrated circuits be handled with appropriate precautions. Failure to observe proper handling and installation procedures can cause damage.

ESD damage can range from subtle performance degradation to complete device failure. Precision integrated circuits may be more susceptible to damage because very small parametric changes could cause the device not to meet its published specifications.

ORDERING INFORMATION⁽¹⁾

T _A	PACKAGE	ORDERABLE PART NUMBER	TOP-SIDE MARKING	VID NUMBER
-40°C to 150°C	SOT553-5 - DRL	OPA170ASDRLTEP	SHN	V62/12627-01XE

(1) For the most current package and ordering information, see the Package Option Addendum at the end of this document, or see the TI website at www.ti.com.

PIN CONFIGURATIONS

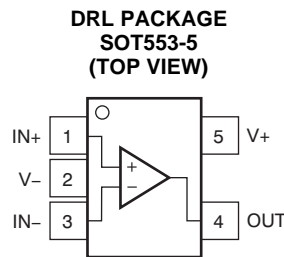

ABSOLUTE MAXIMUM RATINGS⁽¹⁾

Over operating free-air temperature range, unless otherwise noted.

			UNIT
Supply voltage		±20, +40 (single supply)	V
Signal input terminals	Voltage	(V-) - 0.5 to (V+) + 0.5	V
	Current	±10	mA
Output short circuit ⁽²⁾		Continuous	
Operating temperature		-40 to +150	°C
Storage temperature		-65 to +150	°C
Junction temperature		+150	°C
ESD ratings	Human body model (HBM)	4	kV
	Charged device model (CDM)	750	V

(1) Stresses above these ratings may cause permanent damage. Exposure to absolute maximum conditions for extended periods may degrade device reliability. These are stress ratings only, and functional operation of the device at these or any other conditions beyond those specified is not implied.

(2) Short-circuit to ground, one amplifier per package.

THERMAL INFORMATION

THERMAL METRIC ⁽¹⁾		OPA170	UNITS
		DRL (SOT553)	
		5 PINS	
θ _{JA}	Junction-to-ambient thermal resistance	226.8	°C/W
θ _{JC(top)}	Junction-to-case(top) thermal resistance	80.3	
θ _{JB}	Junction-to-board thermal resistance	42.9	
ψ _{JT}	Junction-to-top characterization parameter	3.2	
ψ _{JB}	Junction-to-board characterization parameter	42.5	
θ _{JC(bottom)}	Junction-to-case(bottom) thermal resistance	N/A	

(1) For more information about traditional and new thermal metrics, see the *IC Package Thermal Metrics* application report, [SPRA953](#).

ELECTRICAL CHARACTERISTICS

Boldface limits apply over the specified temperature range, $T_A = -40^\circ\text{C}$ to $+150^\circ\text{C}$.

At $T_A = +25^\circ\text{C}$, $V_{CM} = V_{OUT} = V_S/2$, and $R_L = 10\text{k}\Omega$ connected to $V_S/2$, unless otherwise noted.

PARAMETER	TEST CONDITIONS	MIN	TYP	MAX	UNIT
OFFSET VOLTAGE					
Input offset voltage	V_{OS}		0.25	± 1.8	mV
Over temperature	$T_A = -40^\circ\text{C}$ to $+150^\circ\text{C}$			± 2.5	mV
Drift	dV_{OS}/dT		± 0.3		$\mu\text{V}/^\circ\text{C}$
vs power supply	PSRR	$V_S = +4\text{V}$ to $+36\text{V}$	1	± 5	$\mu\text{V}/\text{V}$
Channel separation, dc	dc		5		$\mu\text{V}/\text{V}$
INPUT BIAS CURRENT					
Input bias current	I_B		± 8	± 15	pA
Over temperature	$T_A = -40^\circ\text{C}$ to $+150^\circ\text{C}$			± 8	nA
Input offset current	I_{OS}		± 4	± 15	pA
Over temperature	$T_A = -40^\circ\text{C}$ to $+150^\circ\text{C}$			± 8	nA
NOISE					
Input voltage noise	$f = 0.1\text{Hz}$ to 10Hz		2		μV_{PP}
Input voltage noise density	e_n	$f = 100\text{Hz}$	22		$\text{nV}/\sqrt{\text{Hz}}$
		$f = 1\text{kHz}$	19		$\text{nV}/\sqrt{\text{Hz}}$
INPUT VOLTAGE					
Common-mode voltage range ⁽¹⁾	V_{CM}	$(V-) - 0.1\text{V}$		$(V+) - 2\text{V}$	V
Common-mode rejection ratio	CMRR	$V_S = \pm 2\text{V}, (V-) - 0.1\text{V} < V_{CM} < (V+) - 2\text{V}$	87	104	dB
		$V_S = \pm 18\text{V}, (V-) - 0.1\text{V} < V_{CM} < (V+) - 2\text{V}$	100	120	dB
INPUT IMPEDANCE					
Differential			$100 \parallel 3$		$\text{M}\Omega \parallel \text{pF}$
Common-mode			$6 \parallel 3$		$10^{12} \Omega \parallel \text{pF}$
OPEN-LOOP GAIN					
Open-loop voltage gain	A_{OL}	$V_S = +4\text{V}$ to $+36\text{V}, (V-) + 0.35\text{V} < V_O < (V+) - 0.35\text{V}$	107	130	dB
FREQUENCY RESPONSE					
Gain bandwidth product	GBP		1.2		MHz
Slew rate	SR	$G = +1$	0.4		$\text{V}/\mu\text{s}$
Settling time	t_s	To 0.1%, $V_S = \pm 18\text{V}, G = +1, 10\text{V}$ step	20		μs
		To 0.01% (12 bit), $V_S = \pm 18\text{V}, G = +1, 10\text{V}$ step	28		μs
Overload recovery time		$V_{IN} \times \text{Gain} > V_S$	2		μs
Total harmonic distortion + noise	THD+N	$G = +1, f = 1\text{kHz}, V_O = 3V_{RMS}$	0.0002		%

(1) The input range can be extended beyond $(V+) - 2\text{V}$ up to $V+$. See the [Typical Characteristics](#) and [Application Information](#) sections for additional information.

ELECTRICAL CHARACTERISTICS (continued)

Boldface limits apply over the specified temperature range, $T_A = -40^{\circ}\text{C}$ to $+150^{\circ}\text{C}$.

At $T_A = +25^{\circ}\text{C}$, $V_{CM} = V_{OUT} = V_S/2$, and $R_L = 10\text{k}\Omega$ connected to $V_S/2$, unless otherwise noted.

PARAMETER	TEST CONDITIONS	MIN	TYP	MAX	UNIT
OUTPUT					
Voltage output swing from rail	V_O				
Positive rail	$I_L = 0\text{mA}$, $V_S = +4\text{V}$ to $+36\text{V}$	10			mV
	I_L sourcing 1mA , $V_S = +4\text{V}$ to $+36\text{V}$	130			mV
Negative Rail	$I_L = 0\text{mA}$, $V_S = +4\text{V}$ to $+36\text{V}$			8	mV
	I_L sinking 1mA , $V_S = +4\text{V}$ to $+36\text{V}$			72	mV
Over temperature	$V_S = 5\text{V}$, $R_L = 10\text{k}\Omega$	$(V-) + 0.03$		$(V+) - 0.05$	V
	$R_L = 10\text{k}\Omega$, $A_{OL} \geq 107\text{dB}$	$(V-) + 0.35$		$(V+) - 0.35$	V
Short-circuit current	I_{SC}		+17/-20		mA
Capacitive load drive	C_{LOAD}		See Typical Characteristics		pF
Open-loop output resistance	R_O	$f = 1\text{MHz}$, $I_O = 0\text{A}$	900		Ω
POWER SUPPLY					
Specified voltage range	V_S		+2.7	+36	V
Quiescent current per amplifier	I_Q	$I_O = 0\text{A}$	110	145	μA
Over temperature		$I_O = 0\text{A}$		160	μA
TEMPERATURE					
Specified range		-40		+125	$^{\circ}\text{C}$
Operating range		-40		+150	$^{\circ}\text{C}$

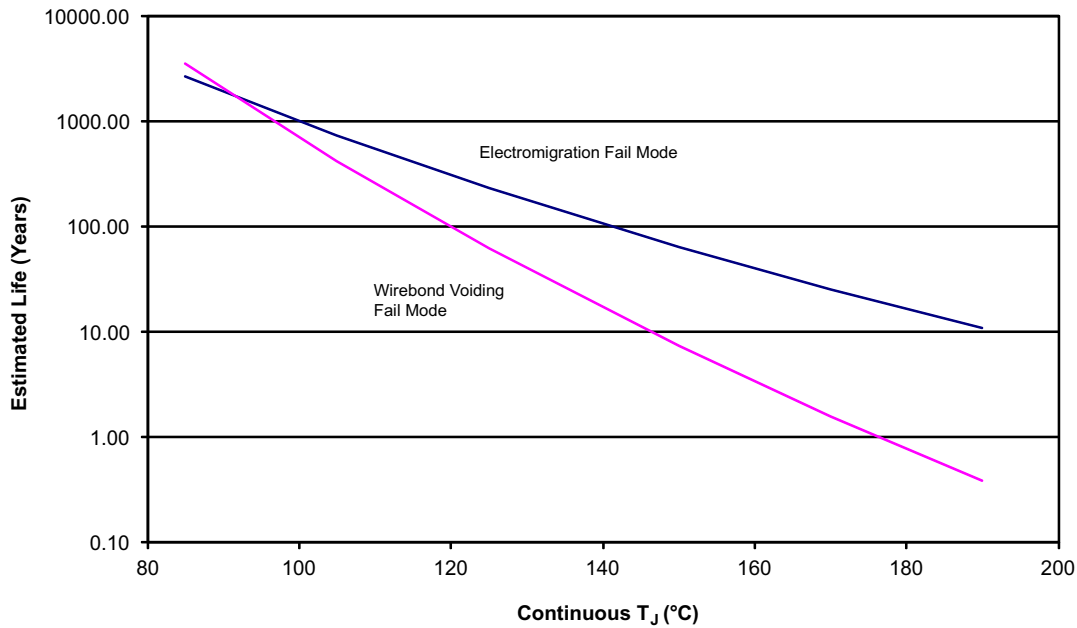

- (1) See datasheet for absolute maximum and minimum recommended operating conditions.
- (2) Silicon operating life design goal is 10 years at 105°C junction temperature (does not include package interconnect life).
- (3) Enhanced plastic product disclaimer applies.

Figure 1. OPA170-EP Operating Life Derating Chart

TYPICAL CHARACTERISTICS

$V_S = \pm 18V$, $V_{CM} = V_S/2$, $R_{LOAD} = 10k\Omega$ connected to $V_S/2$, and $C_L = 100pF$, unless otherwise noted.

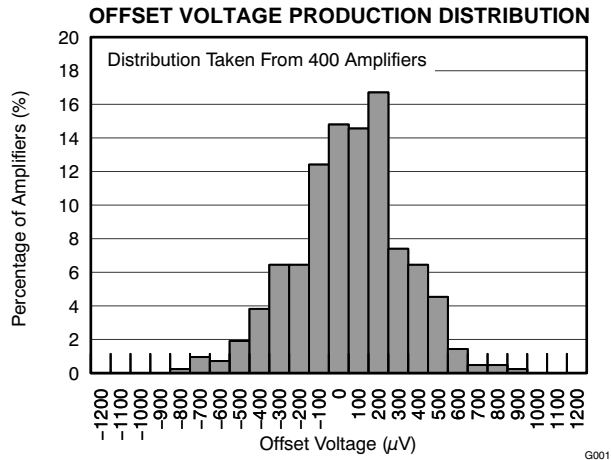

Figure 2.

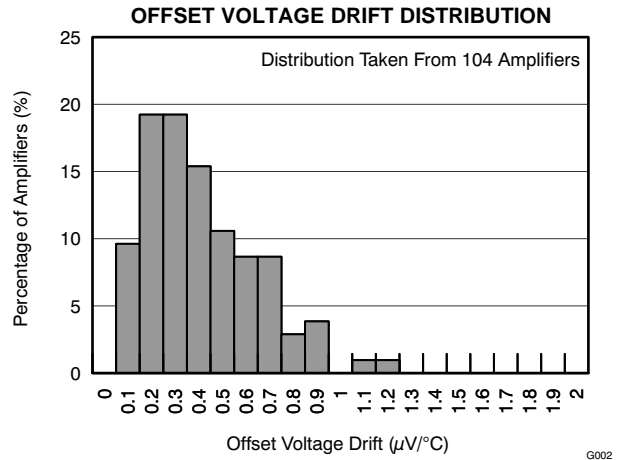

Figure 3.

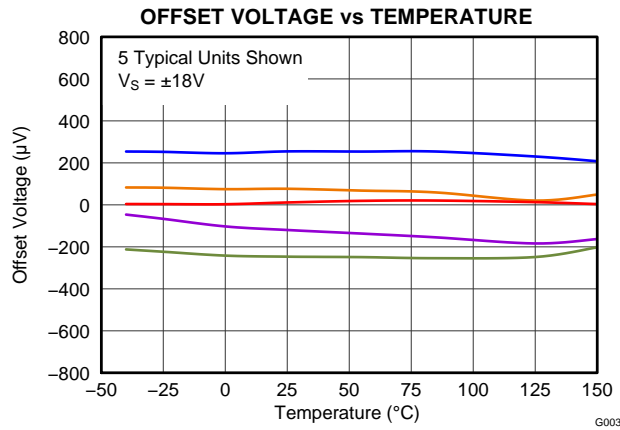

Figure 4.

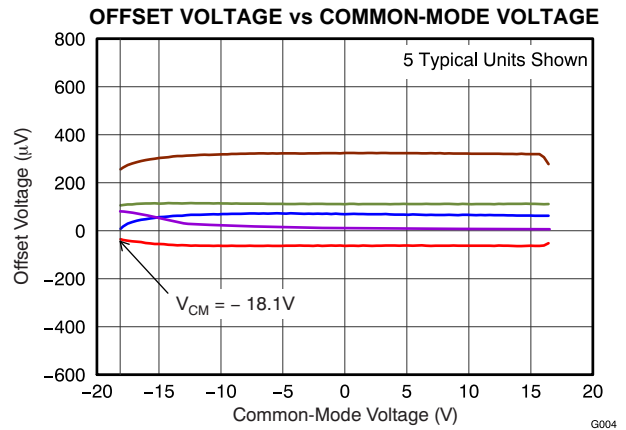

Figure 5.

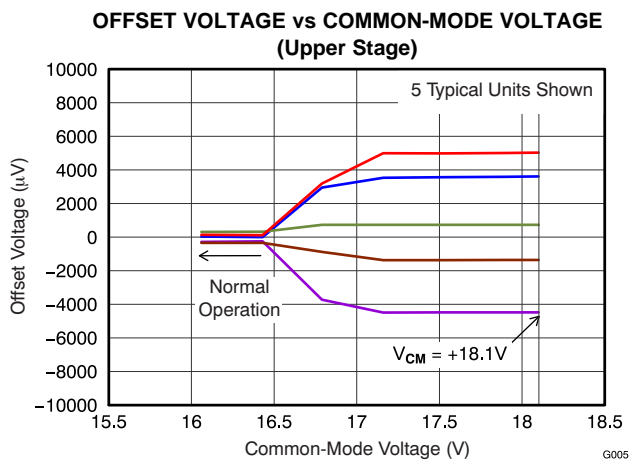

Figure 6.

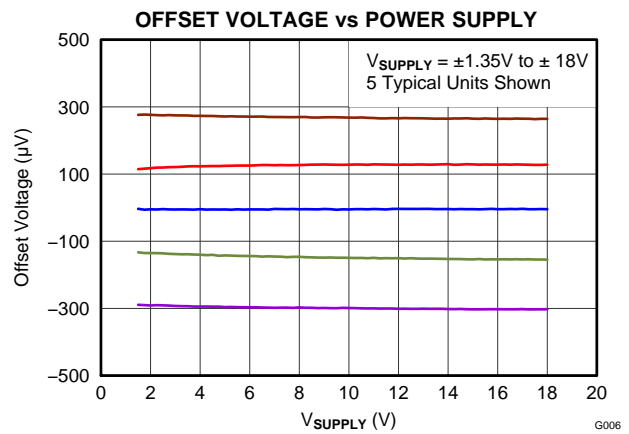

Figure 7.

TYPICAL CHARACTERISTICS (continued)

$V_S = \pm 18V$, $V_{CM} = V_S/2$, $R_{LOAD} = 10k\Omega$ connected to $V_S/2$, and $C_L = 100pF$, unless otherwise noted.

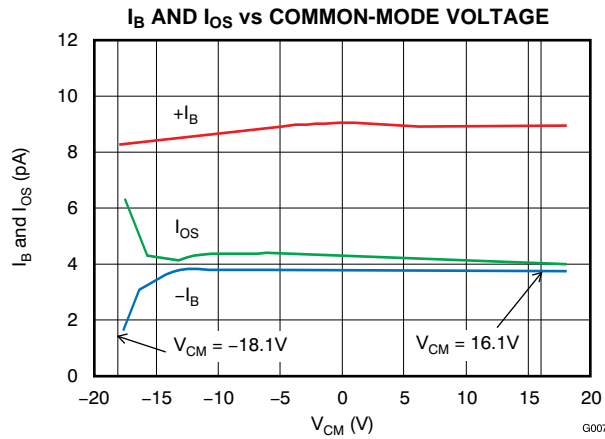

Figure 8.

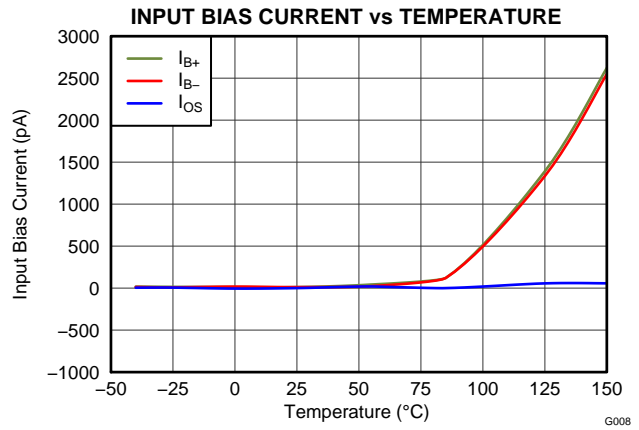

Figure 9.

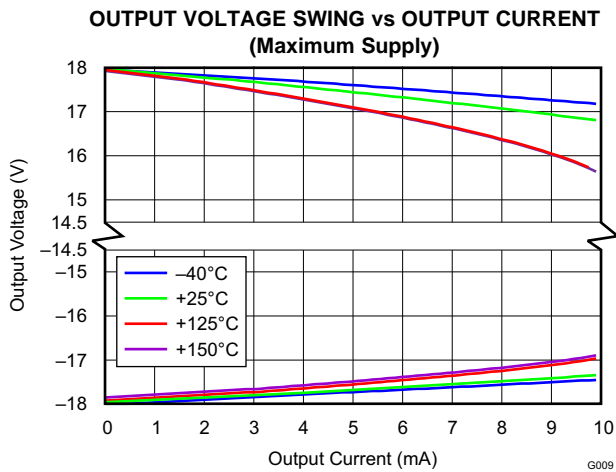

Figure 10.

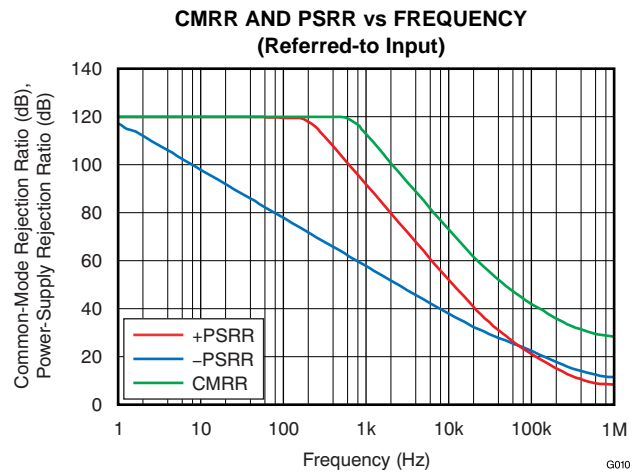

Figure 11.

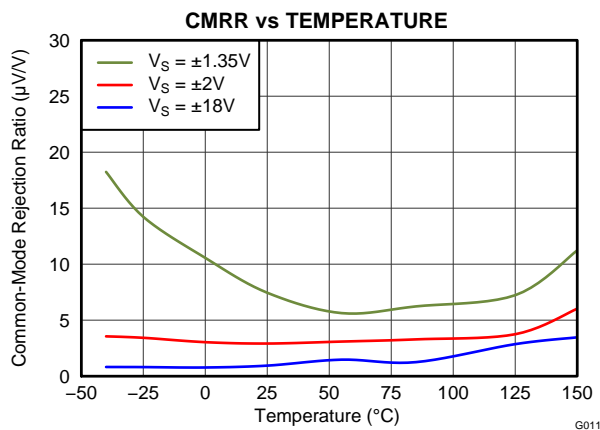

Figure 12.

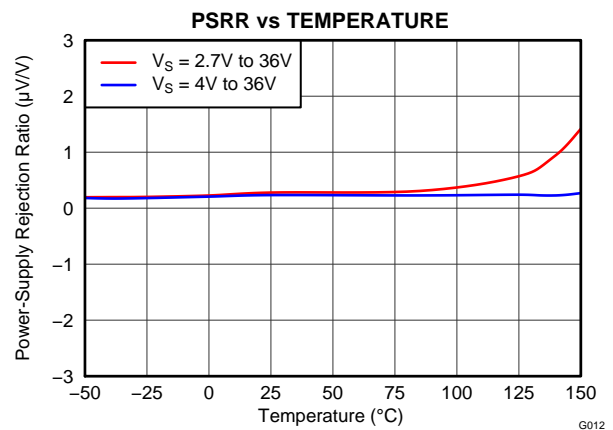

Figure 13.

TYPICAL CHARACTERISTICS (continued)

$V_S = \pm 18V$, $V_{CM} = V_S/2$, $R_{LOAD} = 10k\Omega$ connected to $V_S/2$, and $C_L = 100pF$, unless otherwise noted.

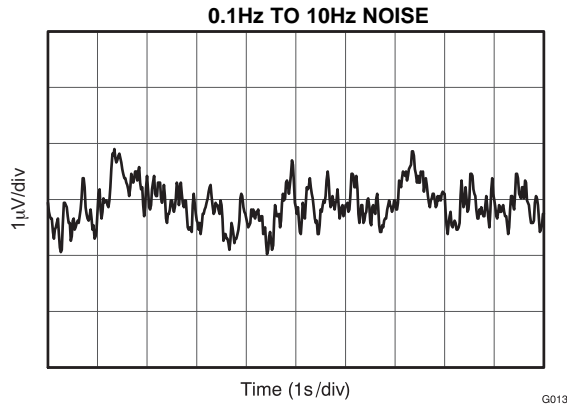

Figure 14.

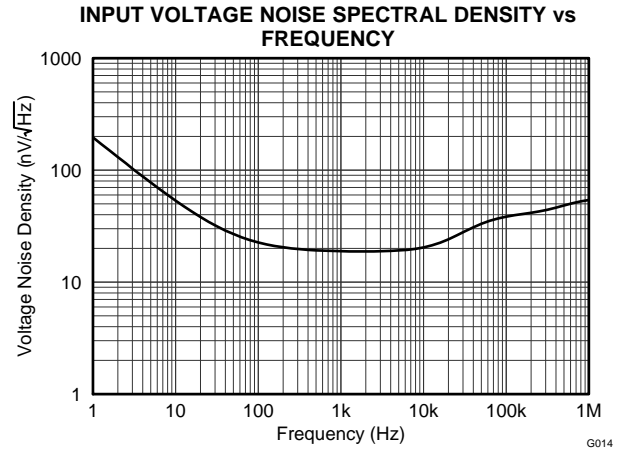

Figure 15.

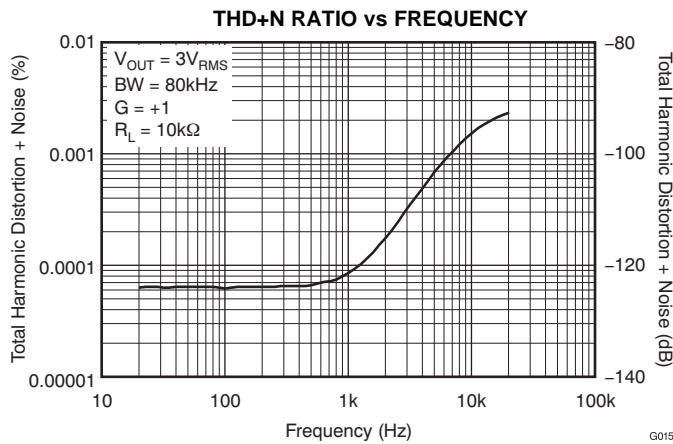

Figure 16.

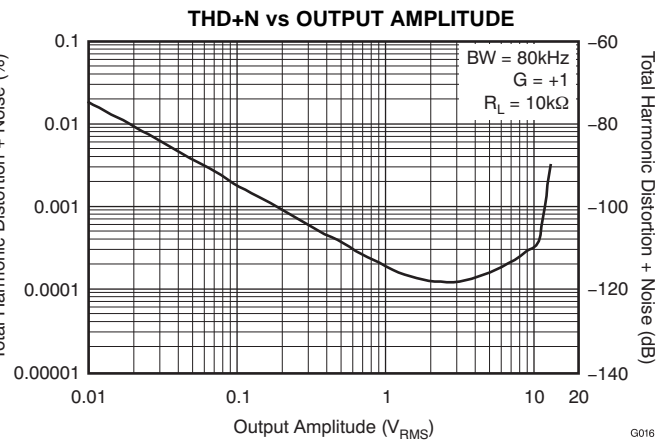

Figure 17.

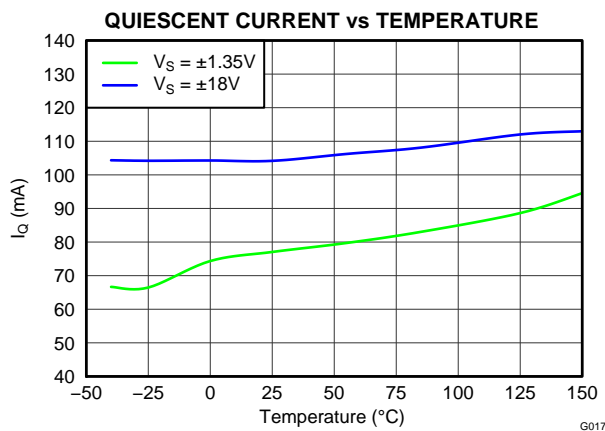

Figure 18.

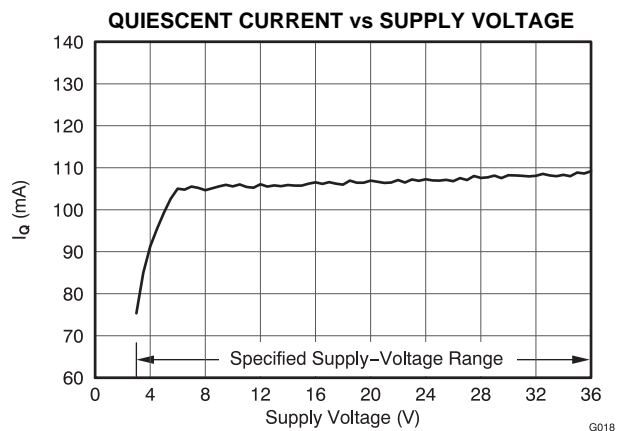

Figure 19.

TYPICAL CHARACTERISTICS (continued)

$V_S = \pm 18V$, $V_{CM} = V_S/2$, $R_{LOAD} = 10k\Omega$ connected to $V_S/2$, and $C_L = 100pF$, unless otherwise noted.

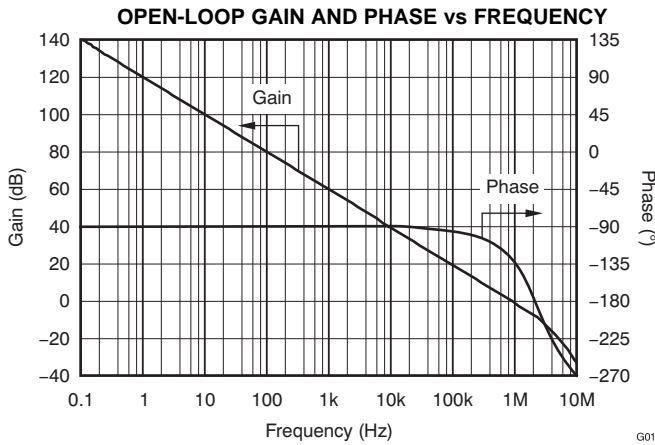

Figure 20.

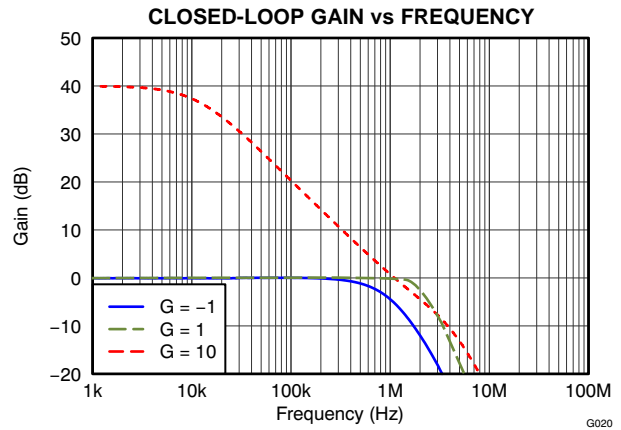

Figure 21.

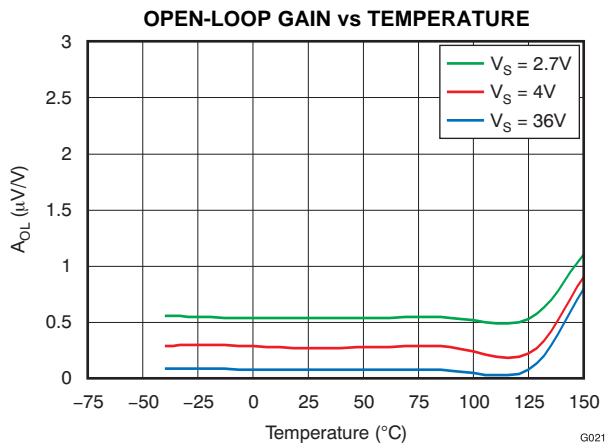

Figure 22.

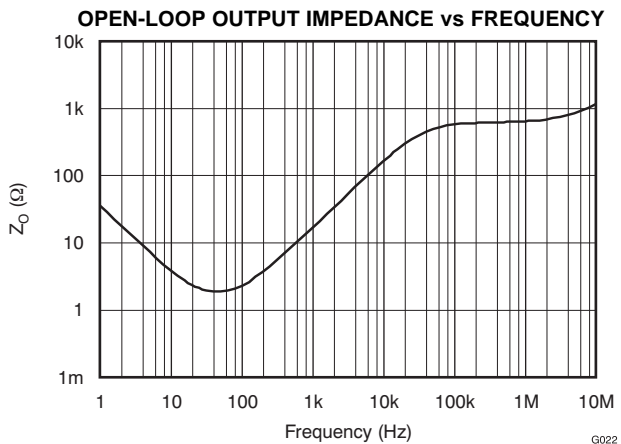

Figure 23.

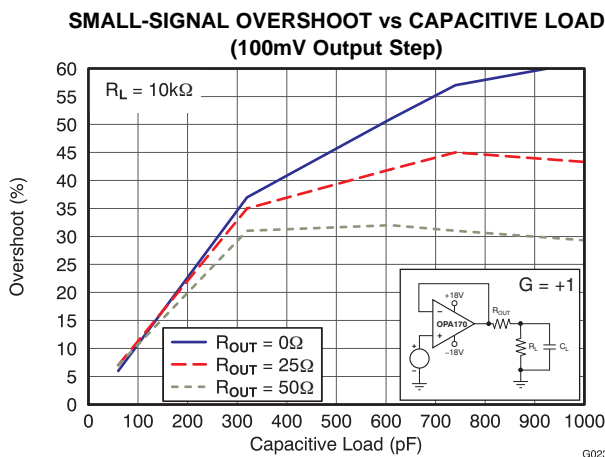

Figure 24.

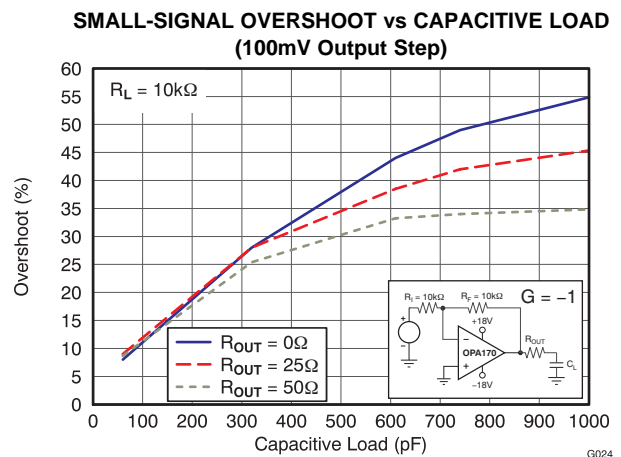

Figure 25.

TYPICAL CHARACTERISTICS (continued)

$V_S = \pm 18V$, $V_{CM} = V_S/2$, $R_{LOAD} = 10k\Omega$ connected to $V_S/2$, and $C_L = 100pF$, unless otherwise noted.

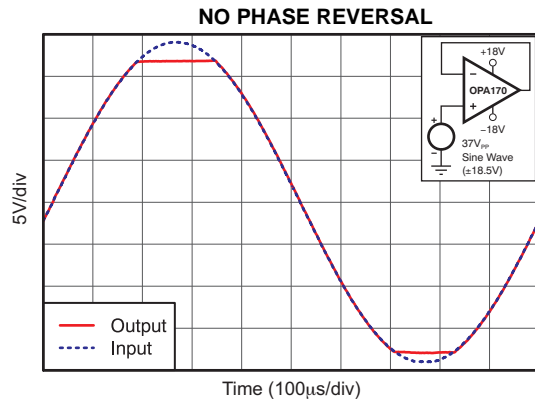

Figure 26.

G025

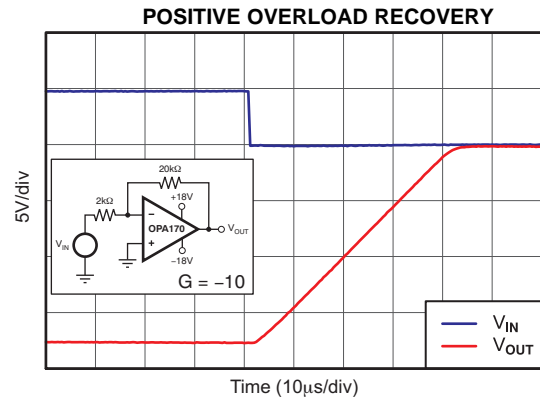

Figure 27.

G026

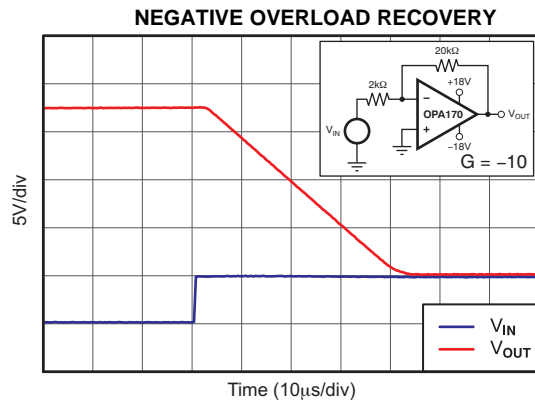

Figure 28.

G027

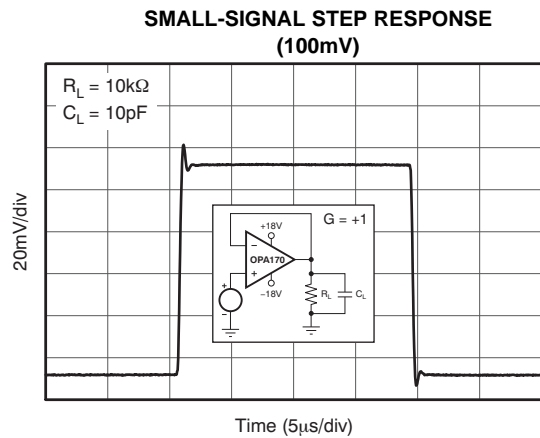

Figure 29.

G028

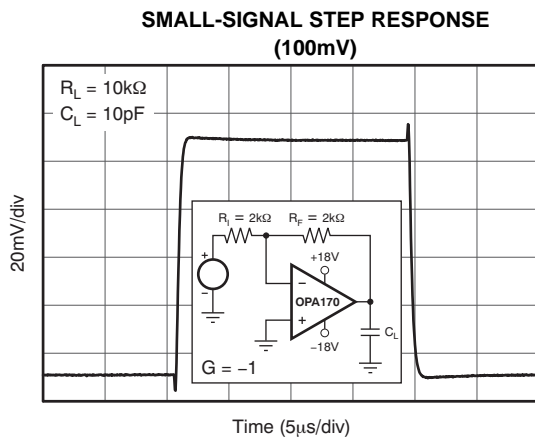

Figure 30.

G029

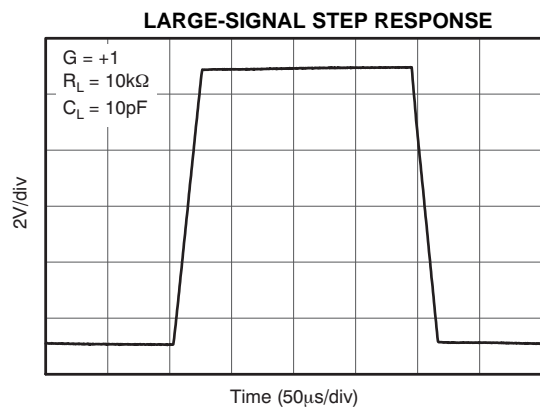

Figure 31.

G030

TYPICAL CHARACTERISTICS (continued)

$V_S = \pm 18V$, $V_{CM} = V_S/2$, $R_{LOAD} = 10k\Omega$ connected to $V_S/2$, and $C_L = 100pF$, unless otherwise noted.

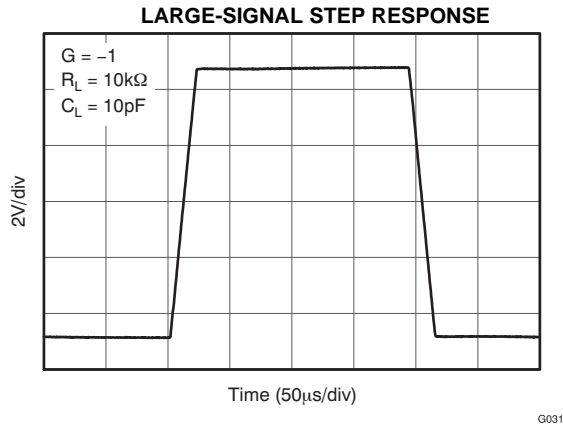

Figure 32.

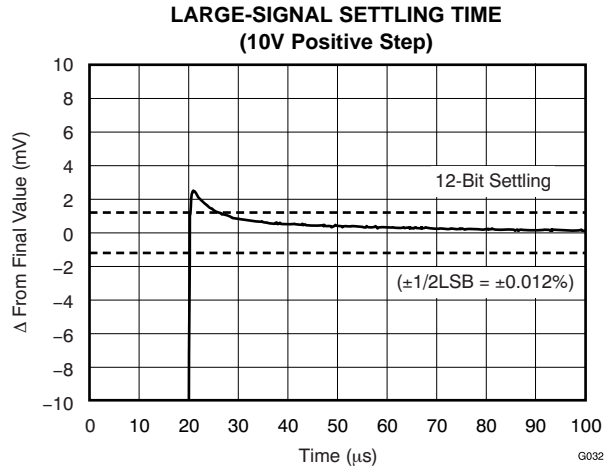

Figure 33.

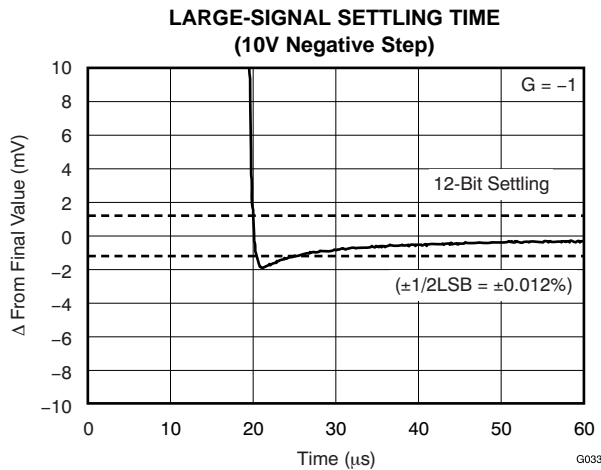

Figure 34.

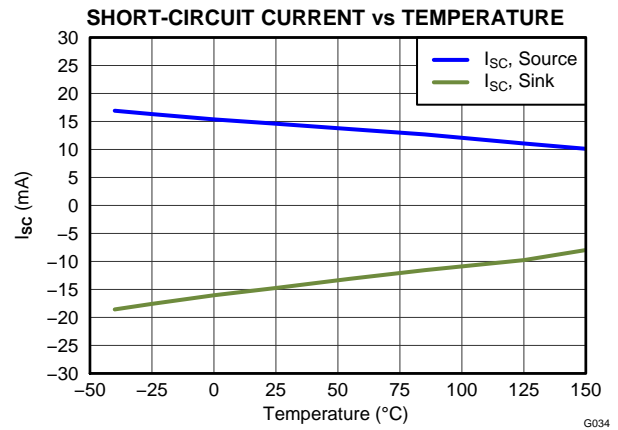

Figure 35.

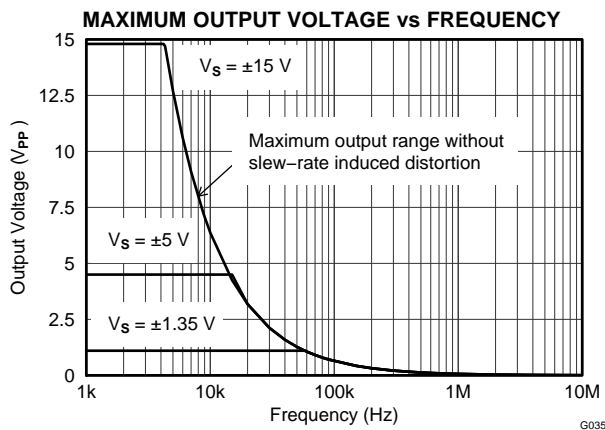

Figure 36.

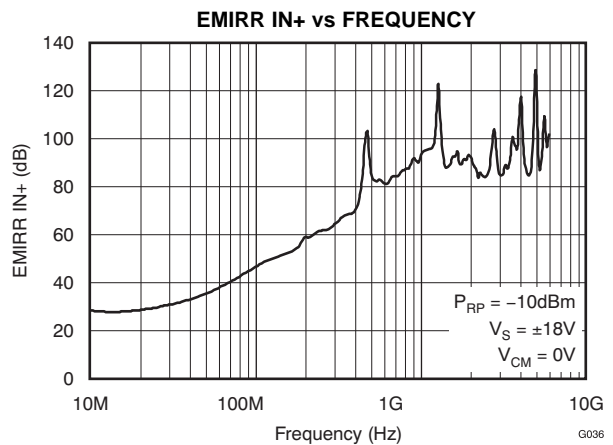

Figure 37.

APPLICATION INFORMATION

The OPA170 operational amplifier provides high overall performance. This device is ideal for many general-purpose applications. The excellent offset drift of only $2\mu\text{V}/^\circ\text{C}$ provides excellent stability over the entire temperature range. In addition, the device offers very good overall performance with high CMRR, PSRR, and A_{OL} . As with all amplifiers, applications with noisy or high-impedance power supplies require decoupling capacitors placed close to the device pins. In most cases, $0.1\mu\text{F}$ capacitors are adequate.

OPERATING CHARACTERISTICS

The OPA170 is specified for operation from 2.7V to 36V ($\pm 1.35\text{V}$ to $\pm 18\text{V}$). Many of the specifications apply from -40°C to $+150^\circ\text{C}$. Parameters that can exhibit significant variance with regard to operating voltage or temperature are presented in the [Typical Characteristics](#).

GENERAL LAYOUT GUIDELINES

For best operational performance of the device, good printed circuit board (PCB) layout practices are recommended. Low-loss, $0.1\mu\text{F}$ bypass capacitors should be connected between each supply pin and ground, placed as close to the device as possible. A single bypass capacitor from $V+$ to ground is applicable to single-supply applications.

COMMON-MODE VOLTAGE RANGE

The input common-mode voltage range of the OPA170 extends 100mV below the negative rail and within 2V of the positive rail for normal operation.

This device can operate with full rail-to-rail input 100mV beyond the positive rail, but with reduced performance within 2V of the positive rail. The typical performance in this range is summarized in [Table 1](#).

PHASE-REVERSAL PROTECTION

The OPA170 has an internal phase-reversal protection. Many op amps exhibit a phase reversal when the input is driven beyond its linear common-mode range. This condition is most often encountered in noninverting circuits when the input is driven beyond the specified common-mode voltage range, causing the output to reverse into the opposite rail. The input of the OPA170 prevents phase reversal with excessive common-mode voltage. Instead, the output limits into the appropriate rail. This performance is shown in [Figure 38](#).

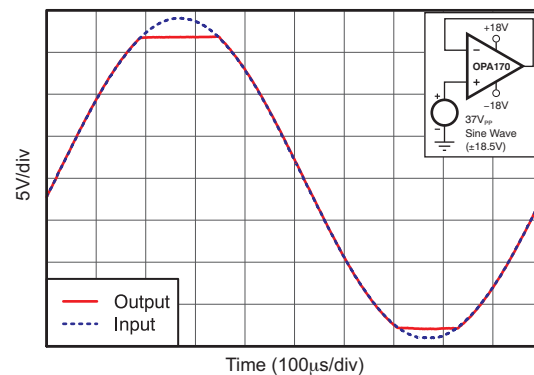

G025

Figure 38. No Phase Reversal

Table 1. Typical Performance Range

PARAMETER	MIN	TYP	MAX	UNIT
Input Common-Mode Voltage	$(V+) - 2$		$(V+) + 0.1$	V
Offset voltage		7		mV
vs Temperature		12		$\mu\text{V}/^\circ\text{C}$
Common-mode rejection		65		dB
Open-loop gain		60		dB
Gain-bandwidth product		0.3		MHz
Slew rate		0.3		$\text{V}/\mu\text{s}$

CAPACITIVE LOAD AND STABILITY

The dynamic characteristics of the OPA170 have been optimized for common operating conditions. The combination of low closed-loop gain and high capacitive loads decreases the phase margin of the amplifier and can lead to gain peaking or oscillations. As a result, heavier capacitive loads must be isolated from the output. The simplest way to achieve this isolation is to add a small resistor (for example, R_{OUT} equal to 50Ω) in series with the output. Figure 39 and Figure 40 illustrate graphs of small-signal overshoot versus capacitive load for several values of R_{OUT} . Also, refer to Applications Bulletin AB-028, *Feedback Plots Define Op Amp AC Performance* (literature number SBOA015, available for download from the TI website), for details of analysis techniques and application circuits.

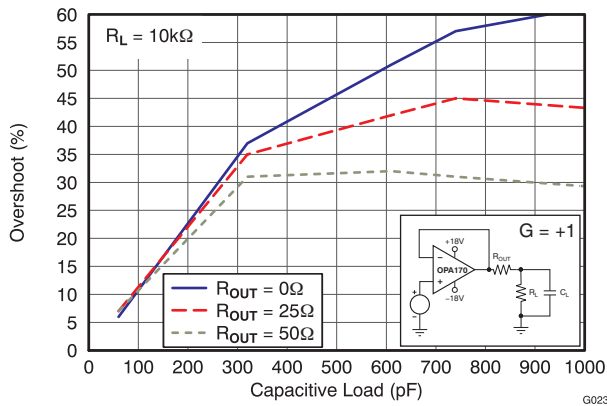

Figure 39. Small-Signal Overshoot versus Capacitive Load (100mV Output Step, G = +1)

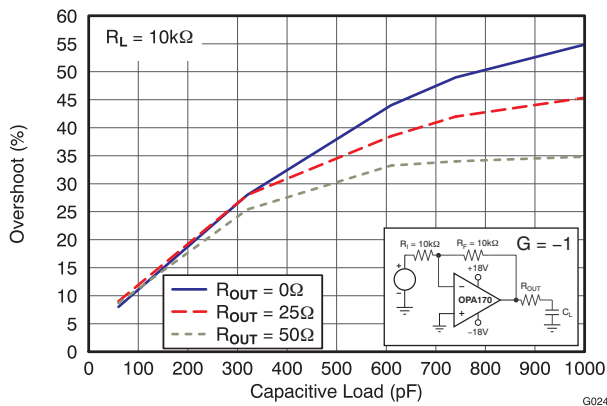

Figure 40. Small-Signal Overshoot versus Capacitive Load (100mV Output Step, G = -1)

ELECTRICAL OVERSTRESS

Designers often ask questions about the capability of an operational amplifier to withstand electrical overstress. These questions tend to focus on the device inputs, but may involve the supply voltage pins or even the output pin. Each of these different pin functions have electrical stress limits determined by the voltage breakdown characteristics of the particular semiconductor fabrication process and specific circuits connected to the pin. Additionally, internal electrostatic discharge (ESD) protection is built into these circuits to protect them from accidental ESD events both before and during product assembly.

These ESD protection diodes also provide in-circuit, input overdrive protection, as long as the current is limited to 10mA as stated in the Absolute Maximum Ratings. Figure 41 shows how a series input resistor may be added to the driven input to limit the input current. The added resistor contributes thermal noise at the amplifier input and its value should be kept to a minimum in noise-sensitive applications.

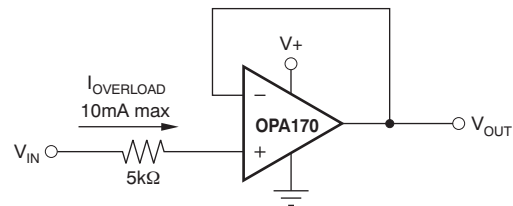

Figure 41. Input Current Protection

An ESD event produces a short duration, high-voltage pulse that is transformed into a short duration, high-current pulse as it discharges through a semiconductor device. The ESD protection circuits are designed to provide a current path around the operational amplifier core to prevent it from being damaged. The energy absorbed by the protection circuitry is then dissipated as heat.

When the operational amplifier connects into a circuit, the ESD protection components are intended to remain inactive and not become involved in the application circuit operation. However, circumstances may arise where an applied voltage exceeds the operating voltage range of a given pin. Should this condition occur, there is a risk that some of the internal ESD protection circuits may be biased on, and conduct current. Any such current flow occurs through ESD cells and rarely involves the absorption device.

If there is an uncertainty about the ability of the supply to absorb this current, external zener diodes may be added to the supply pins. The zener voltage must be selected such that the diode does not turn on during normal operation. However, its zener voltage should be low enough so that the zener diode conducts if the supply pin begins to rise above the safe operating supply voltage level.

PACKAGING INFORMATION

Orderable part number	Status (1)	Material type (2)	Package Pins	Package qty Carrier	RoHS (3)	Lead finish/ Ball material (4)	MSL rating/ Peak reflow (5)	Op temp (°C)	Part marking (6)
OPA170ASDRLTEP	Active	Production	SOT-5X3 (DRL) 5	250 SMALL T&R	Yes	NIPDAUAG	Level-1-260C-UNLIM	-40 to 150	DAQ
OPA170ASDRLTEP.A	Active	Production	SOT-5X3 (DRL) 5	250 SMALL T&R	Yes	NIPDAUAG	Level-1-260C-UNLIM	-40 to 150	DAQ
V62/12627-01XE	Active	Production	SOT-5X3 (DRL) 5	250 SMALL T&R	Yes	NIPDAUAG	Level-1-260C-UNLIM	-40 to 150	DAQ

(1) **Status:** For more details on status, see our [product life cycle](#).

(2) **Material type:** When designated, preproduction parts are prototypes/experimental devices, and are not yet approved or released for full production. Testing and final process, including without limitation quality assurance, reliability performance testing, and/or process qualification, may not yet be complete, and this item is subject to further changes or possible discontinuation. If available for ordering, purchases will be subject to an additional waiver at checkout, and are intended for early internal evaluation purposes only. These items are sold without warranties of any kind.

(3) **RoHS values:** Yes, No, RoHS Exempt. See the [TI RoHS Statement](#) for additional information and value definition.

(4) **Lead finish/Ball material:** Parts may have multiple material finish options. Finish options are separated by a vertical ruled line. Lead finish/Ball material values may wrap to two lines if the finish value exceeds the maximum column width.

(5) **MSL rating/Peak reflow:** The moisture sensitivity level ratings and peak solder (reflow) temperatures. In the event that a part has multiple moisture sensitivity ratings, only the lowest level per JEDEC standards is shown. Refer to the shipping label for the actual reflow temperature that will be used to mount the part to the printed circuit board.

(6) **Part marking:** There may be an additional marking, which relates to the logo, the lot trace code information, or the environmental category of the part.

Multiple part markings will be inside parentheses. Only one part marking contained in parentheses and separated by a "-" will appear on a part. If a line is indented then it is a continuation of the previous line and the two combined represent the entire part marking for that device.

Important Information and Disclaimer: The information provided on this page represents TI's knowledge and belief as of the date that it is provided. TI bases its knowledge and belief on information provided by third parties, and makes no representation or warranty as to the accuracy of such information. Efforts are underway to better integrate information from third parties. TI has taken and continues to take reasonable steps to provide representative and accurate information but may not have conducted destructive testing or chemical analysis on incoming materials and chemicals. TI and TI suppliers consider certain information to be proprietary, and thus CAS numbers and other limited information may not be available for release.

In no event shall TI's liability arising out of such information exceed the total purchase price of the TI part(s) at issue in this document sold by TI to Customer on an annual basis.

OTHER QUALIFIED VERSIONS OF OPA170-EP :

- Catalog : [OPA170](#)

- Automotive : [OPA170-Q1](#)

NOTE: Qualified Version Definitions:

- Catalog - TI's standard catalog product
- Automotive - Q100 devices qualified for high-reliability automotive applications targeting zero defects

TAPE AND REEL INFORMATION



QUADRANT ASSIGNMENTS FOR PIN 1 ORIENTATION IN TAPE



*All dimensions are nominal

Device	Package Type	Package Drawing	Pins	SPQ	Reel Diameter (mm)	Reel Width W1 (mm)	A0 (mm)	B0 (mm)	K0 (mm)	P1 (mm)	W (mm)	Pin1 Quadrant
OPA170ASDRLTEP	SOT-5X3	DRL	5	250	180.0	8.4	1.98	1.78	0.69	4.0	8.0	Q3

TAPE AND REEL BOX DIMENSIONS



*All dimensions are nominal

Device	Package Type	Package Drawing	Pins	SPQ	Length (mm)	Width (mm)	Height (mm)
OPA170ASDRLTEP	SOT-5X3	DRL	5	250	202.0	201.0	28.0

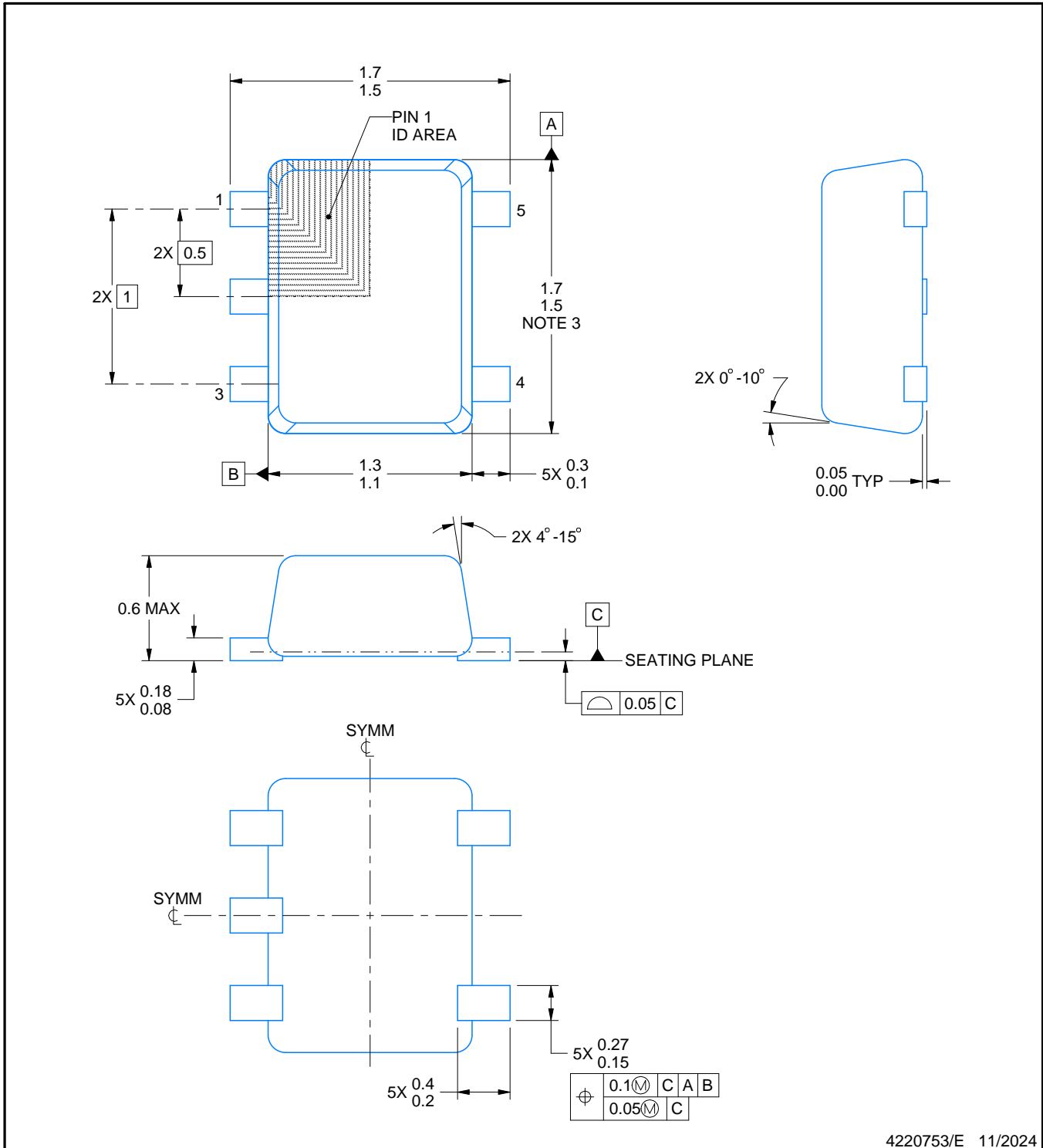
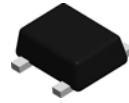

4220753/E 11/2024

NOTES:

1. All linear dimensions are in millimeters. Any dimensions in parenthesis are for reference only. Dimensioning and tolerancing per ASME Y14.5M.
2. This drawing is subject to change without notice.
3. This dimension does not include mold flash, protrusions, or gate burrs. Mold flash, protrusions, or gate burrs shall not exceed 0.15 mm per side.
4. Reference JEDEC registration MO-293 Variation UAAD-1

EXAMPLE BOARD LAYOUT

DRL0005A

SOT - 0.6 mm max height

PLASTIC SMALL OUTLINE

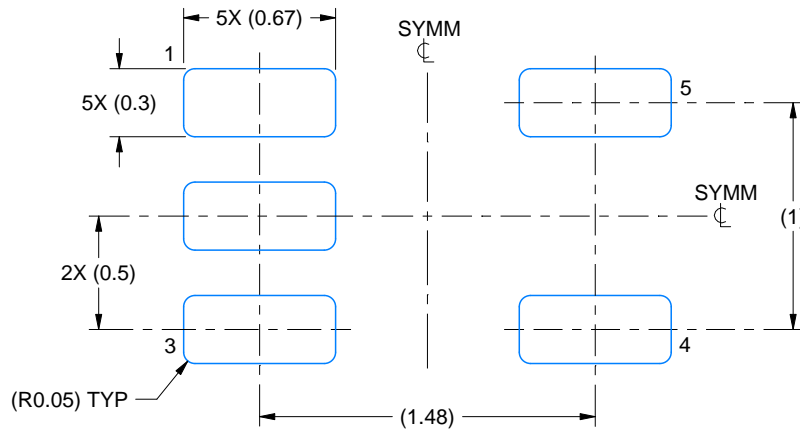

LAND PATTERN EXAMPLE
SCALE:30X

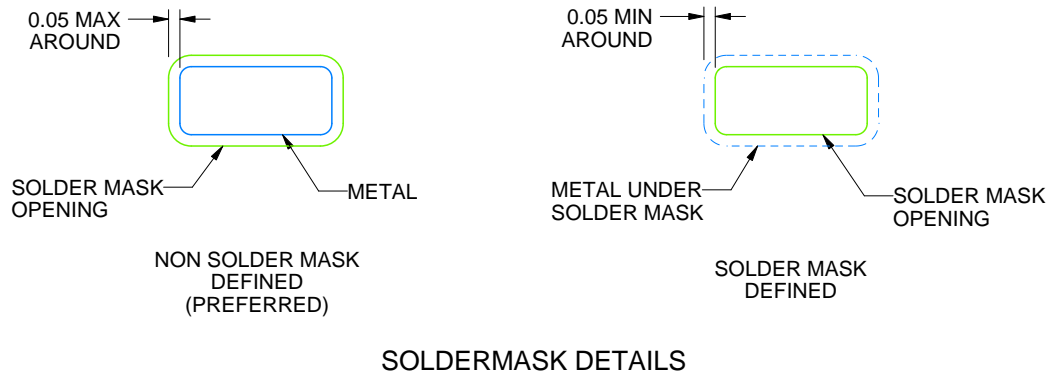

SOLDERMASK DETAILS

4220753/E 11/2024

NOTES: (continued)

- 5. Publication IPC-7351 may have alternate designs.
- 6. Solder mask tolerances between and around signal pads can vary based on board fabrication site.

EXAMPLE STENCIL DESIGN

DRL0005A

SOT - 0.6 mm max height

PLASTIC SMALL OUTLINE

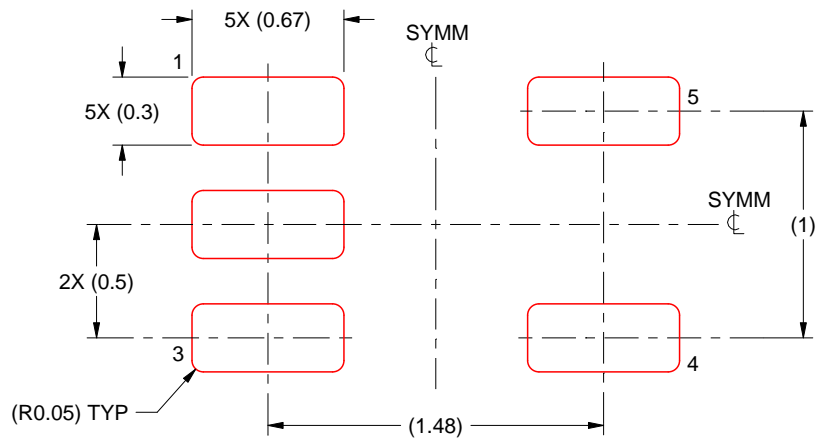

SOLDER PASTE EXAMPLE
BASED ON 0.1 mm THICK STENCIL
SCALE:30X

4220753/E 11/2024

NOTES: (continued)

7. Laser cutting apertures with trapezoidal walls and rounded corners may offer better paste release. IPC-7525 may have alternate design recommendations.
8. Board assembly site may have different recommendations for stencil design.

IMPORTANT NOTICE AND DISCLAIMER

TI PROVIDES TECHNICAL AND RELIABILITY DATA (INCLUDING DATASHEETS), DESIGN RESOURCES (INCLUDING REFERENCE DESIGNS), APPLICATION OR OTHER DESIGN ADVICE, WEB TOOLS, SAFETY INFORMATION, AND OTHER RESOURCES "AS IS" AND WITH ALL FAULTS, AND DISCLAIMS ALL WARRANTIES, EXPRESS AND IMPLIED, INCLUDING WITHOUT LIMITATION ANY IMPLIED WARRANTIES OF MERCHANTABILITY, FITNESS FOR A PARTICULAR PURPOSE OR NON-INFRINGEMENT OF THIRD PARTY INTELLECTUAL PROPERTY RIGHTS.

These resources are intended for skilled developers designing with TI products. You are solely responsible for (1) selecting the appropriate TI products for your application, (2) designing, validating and testing your application, and (3) ensuring your application meets applicable standards, and any other safety, security, regulatory or other requirements.

These resources are subject to change without notice. TI grants you permission to use these resources only for development of an application that uses the TI products described in the resource. Other reproduction and display of these resources is prohibited. No license is granted to any other TI intellectual property right or to any third party intellectual property right. TI disclaims responsibility for, and you fully indemnify TI and its representatives against any claims, damages, costs, losses, and liabilities arising out of your use of these resources.

TI's products are provided subject to [TI's Terms of Sale](#), [TI's General Quality Guidelines](#), or other applicable terms available either on [ti.com](#) or provided in conjunction with such TI products. TI's provision of these resources does not expand or otherwise alter TI's applicable warranties or warranty disclaimers for TI products. Unless TI explicitly designates a product as custom or customer-specified, TI products are standard, catalog, general purpose devices.

TI objects to and rejects any additional or different terms you may propose.

Copyright © 2025, Texas Instruments Incorporated

Last updated 10/2025