

LM2903-Q1 and LM2903B-Q1 Automotive Dual Comparators

Features

- Qualified for automotive applications
- AEC-Q100 qualified with the following results:
 - Device temperature grade 0: –40°C to 150°C ambient operating temperature range (LM2903E-Q1)
 - Device temperature grade 1: –40°C to 125°C ambient operating temperature range
 - Device HBM ESD classification level H1C
 - Device CDM ESD classification level C4B
- Improved 2kV HBM ESD for "B" device
- Tri-Temp testing available for "B" device
- Single supply or dual supplies
- Low supply-current independent of supply voltage 200uA typical per comparator ("B" Versions)
- Low input bias current 3.5nA typical ("B" device)
- Low input offset current 0.5nA typical ("B" device)
- Low input offset voltage ±0.37mV typical ("B" device)
- Common-mode input voltage range includes ground
- Differential input voltage range equal to maximum-rated supply voltage ±36 V
- Output compatible with TTL, MOS, and CMOS
- **Functional Safety-Capable**
 - [Documentation available to aid functional safety system design](#)

Applications

- **Automotive**
 - [HEV/EV and power train](#)
 - [Infotainment and cluster](#)
 - [Body control module](#)
- **Industrial**
- **Appliances**

Description

The LM2903B-Q1 device is the next generation version of the industry-standard LM2903-Q1 comparator family. This next generation family provides outstanding value for cost-sensitive applications, with features including lower offset voltage, higher supply voltage capability, lower supply current, lower input bias current, lower propagation delay, and improved 2kV ESD performance with drop-in replacement convenience.

All devices consist of two independent voltage comparators that are designed to operate over a wide range of voltages. Operation from dual supplies also is possible as long as the difference between the two supplies is within 2V to 36V, and VCC is at least 1.5V more positive than the input common-mode voltage. The outputs can be connected to other open-collector outputs.

The LM2903-Q1 and LM2903B-Q1 are qualified for the AEC-Q100 Grade 1 temperature range of –40°C to +125°C. The LM2903E-Q1 is Qualified for the Grade 0 extended temperature range of –40°C to +150°C.

Device Information

PART NUMBER	PACKAGE ⁽¹⁾	BODY SIZE (NOM)
LM2903B-Q1	SOIC (8)	4.90mm × 3.91mm
	TSSOP (8)	3.00mm × 4.40mm
	VSSOP(8)	3.00mm × 3.00mm
	WSON (8)	2.00mm × 2.00mm
	SOT-23 (8)	1.60mm × 2.90mm
LM2903-Q1	SOIC (8)	4.90mm × 3.91mm
	TSSOP (8)	3.00mm × 4.40mm
	VSSOP(8)	3.00mm × 3.00mm
LM2903E-Q1	TSSOP (8)	3.00mm × 4.40mm

(1) For all available packages, see the orderable addendum at the end of the data sheet.

Family Comparison Table

Specification	LM2903B-Q1	LM2903-Q1	LM2903-Q1 "A" Devices	LM2903-Q1 "AV" Devices	LM2903E-Q1	Units
Specified Supply Voltage	2 to 36	2 to 30	2 to 30	2 to 32	2 to 30	V
Total Supply Current (5V to V _S max)	0.6 to 0.8	1 to 2.5	1 to 2.5	1 to 2.5	1 to 2.5	mA
Temperature Range	–40 to 125	–40 to 125	–40 to 125	–40 to 125	–40 to 150	°C
ESD (HBM / CDM)	2k / 1k	1k / 750	1k / 750	1k / 750	1k / 750	V
Offset Voltage (max over temp)	± 4	± 15	± 4	± 4	± 15	mV
Input Bias Current (typ / max)	3.5 / 25	25 / 250	25 / 250	25 / 250	25 / 250	nA
Response Time (typ)	1	1.3	1.3	1.3	1.3	µsec



Table of Contents

Features	1	2.13 Switching Characteristics, LM2903-Q1 and LM2903E-Q1.....	7
Applications	1	2.14 Typical Characteristics.....	8
Description	1	3 Detailed Description	14
1 Pin Configuration and Functions	3	3.1 Overview.....	14
1.1 Pin Functions.....	3	3.2 Functional Block Diagram.....	14
2 Specifications	4	3.3 Feature Description.....	14
2.1 Absolute Maximum Ratings, LM2903-Q1 and LM2903E-Q1.....	4	3.4 Device Functional Modes.....	15
2.2 Absolute Maximum Ratings, LM2903B-Q1.....	4	4 Application and Implementation	16
2.3 ESD Ratings, LM2903-Q1 and LM2903E-Q1.....	4	4.1 Application Information.....	16
2.4 ESD Ratings, LM2903B-Q1.....	4	4.2 Typical Application.....	16
2.5 Recommended Operating Conditions, LM2903B-Q1.....	5	4.3 Power Supply Recommendations.....	18
2.6 Recommended Operating Conditions, LM2903-Q1.....	5	4.4 Layout.....	18
2.7 Recommended Operating Conditions, LM2903E-Q1.....	5	5 Device and Documentation Support	18
2.8 Thermal Information.....	5	5.1 Documentation Support.....	18
2.9 Electrical Characteristics LM2903B - Q1.....	6	5.2 Receiving Notification of Documentation Updates.....	18
2.10 Switching Characteristics LM2903B - Q1.....	6	5.3 Support Resources.....	18
2.11 LM2903B-Q1 "T", "R" and "H" Temperature Test Options.....	6	5.4 Trademarks.....	18
2.12 Electrical Characteristics, LM2903-Q1 and LM2903E-Q1.....	7	5.5 Electrostatic Discharge Caution.....	19
		5.6 Glossary.....	19
		6 Revision History	20
		7 Mechanical, Packaging, and Orderable Information ..	21

1 Pin Configuration and Functions

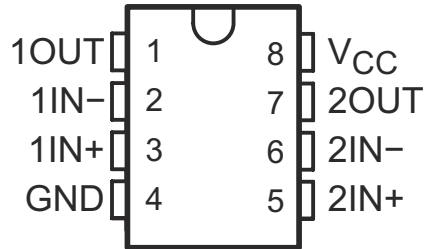
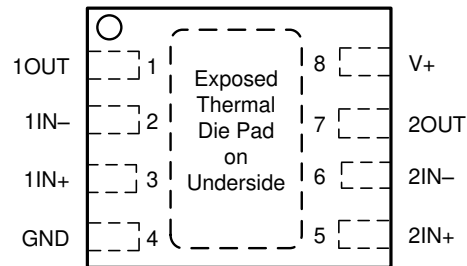

Figure 1-1. D, DGK, DDF OR PW PACKAGE
Top View



Connect thermal pad directly to GND pin.

Figure 1-2. DSG Package
8-Pin WSON With Exposed Pad
Top View

1.1 Pin Functions

NAME	PIN		I/O	DESCRIPTION
	SOIC, VSSOP, PDIP, SO, DDF and TSSOP	DSG		
1OUT	1	1	Output	Output pin of comparator 1
1IN-	2	2	Input	Negative input pin of comparator 1
1IN+	3	3	Input	Positive input pin of comparator 1
GND	4	4	—	Ground
2IN+	5	5	Input	Positive input pin of comparator 2
2IN-	6	6	Input	Negative input pin of comparator 2
2OUT	7	7	Output	Output pin of comparator 2
V _{CC}	8	8	—	Positive Supply
Thermal Pad	—	PAD	—	Connect directly to GND pin

2 Specifications

2.1 Absolute Maximum Ratings, LM2903-Q1 and LM2903E-Q1

over operating free-air temperature range (unless otherwise noted) ⁽¹⁾

		MIN	MAX	UNIT
V _{CC}	Supply voltage ⁽²⁾		36	V
V _{CC}	Supply voltage, LM2903E-Q1 Only ⁽²⁾		32	V
V _{ID}	Differential input voltage ⁽³⁾	-36	36	V
V _I	Input voltage range (either input)	-0.3	36	V
V _O	Output voltage		36	V
I _O	Output current		20	mA
T _J	Operating virtual-junction temperature		150	°C
T _{SCG}	Duration of output short-circuit to ground		Unlimited	s

(1) Stresses beyond those listed under *Absolute Maximum Ratings* can cause permanent damage to the device. These are stress ratings only, and functional operation of the device at these or any other conditions beyond those indicated under *Recommended Operating Conditions* is not implied. Exposure to absolute-maximum-rated conditions for extended periods can affect device reliability.

(2) All voltage values, except differential voltages, are with respect to GND.

(3) Differential voltages are at IN+ with respect to IN-.

2.2 Absolute Maximum Ratings, LM2903B-Q1

over operating free-air temperature range (unless otherwise noted)⁽¹⁾

		MIN	MAX	UNIT
Supply voltage: V _S = (V+) – (V-)		-0.3	38	V
Differential input voltage : V _{ID} ⁽²⁾			±38	V
Input pins (IN+, IN-)		-0.3	38	V
Current into input pins (IN+, IN-)			-50	mA
Output pin (OUT)		-0.3	38	V
Output sink current			25	mA
Operating virtual-junction temperature			150	°C
Output short-circuit duration ⁽³⁾			Unlimited	s

(1) Stresses beyond those listed under *Absolute Maximum Ratings* can cause permanent damage to the device. These are stress ratings only, which do not imply functional operation of the device at these or any other conditions beyond those indicated under *Recommended Operating Conditions*. Exposure to absolute-maximum-rated conditions for extended periods can affect device reliability.

(2) Differential voltages are at IN+ with respect to IN-

(3) Short circuits from outputs to V+ can cause excessive heating and eventual destruction.

2.3 ESD Ratings, LM2903-Q1 and LM2903E-Q1

			MIN	MAX	UNIT
T _{stg}	Storage temperature range	LM2903-Q1 Only	-65	150	°C
V _(ESD)	Electrostatic discharge	Human body model (HBM), per AEC Q100-002 ⁽¹⁾	-1000	1000	V
		Charged device model (CDM), per AEC Q100-011	All pins	-750	

(1) AEC Q100-002 indicates HBM stressing is done in accordance with the ANSI/ESDA/JEDEC JS-001 specification.

2.4 ESD Ratings, LM2903B-Q1

			MIN	MAX	UNIT
T _{stg}	Storage temperature range		-65	150	°C
V _(ESD)	Electrostatic discharge	Human body model (HBM), per AEC Q100-002 ⁽¹⁾	-2000	2000	V
		Charged device model (CDM), per AEC Q100-011	All pins	-1000	

(1) AEC Q100-002 indicates HBM stressing is done in accordance with the ANSI/ESDA/JEDEC JS-001 specification.

2.5 Recommended Operating Conditions, LM2903B-Q1

over operating free-air temperature range (unless otherwise noted)

	MIN	MAX	UNIT
Supply voltage: $V_S = (V+) - (V-)$	2	36	V
Ambient temperature, T_A , LM2903B	-40	125	°C
Input voltage range, V_{IVR}	-0.1	(V+) - 2	V

2.6 Recommended Operating Conditions, LM2903-Q1

over operating free-air temperature range (unless otherwise noted)

	MIN	MAX	UNIT
V_{CC} (non-V devices)	2	30	V
V_{CC} (V devices)	2	32	V
T_J Junction Temperature	-40	125	°C

2.7 Recommended Operating Conditions, LM2903E-Q1

over operating free-air temperature range (unless otherwise noted)

	MIN	MAX	UNIT
V_{CC}	2	30	V
T_J Junction Temperature	-40	150	°C

2.8 Thermal Information

THERMAL METRIC ⁽¹⁾	LM2903x-Q1					UNIT
	D (SOIC)	DGK (VSSOP)	PW (TSSOP)	DSG (WSON)	DDF (SOT-23)	
	8 PINS	8 PINS	8 PINS	8 PINS	8 PINS	
$R_{\theta JA}$ Junction-to-ambient thermal resistance	154.1	176.5	182.9	102.1	197.9	°C/W
$R_{\theta JC(top)}$ Junction-to-case (top) thermal resistance	96.5	85.5	87.1	126.0	119.2	
$R_{\theta JB}$ Junction-to-board thermal resistance	97.7	112.4	123.2	68.6	115.4	
Ψ_{JT} Junction-to-top characterization parameter	45.7	17.3	16.7	15.9	19.4	
Ψ_{JB} Junction-to-board characterization parameter	96.9	110.1	120.4	68.4	113.7	
$R_{\theta JC(bot)}$ Junction-to-case (bottom) thermal resistance	-	-	-	43.9	-	

(1) For more information about traditional and new thermal metrics, see the [Semiconductor and IC Package Thermal Metrics](#) application report.

2.9 Electrical Characteristics LM2903B - Q1

$V_S = 5V$, $V_{CM} = (V-)$; $T_A = 25^\circ C$ (unless otherwise noted).

PARAMETER			TEST CONDITIONS	MIN	TYP	MAX	UNIT
V_{IO}	Input offset voltage, DGK package only	Input offset voltage, DGK package only	$V_S = 5$ to 36V	-3.5	± 0.37	3.5	mV
V_{IO}	Input offset voltage, DGK package only	Input offset voltage, DGK package only	$V_S = 5$ to 36V, $T_A = -40^\circ C$ to $+125^\circ C$	-5		5	mV
V_{IO}	Input offset voltage		$V_S = 5$ to 36V	-2.5	± 0.37	2.5	mV
			$V_S = 5$ to 36V, $T_A = -40^\circ C$ to $+125^\circ C$	-4		4	mV
I_B	Input bias current			-25	-3.5		nA
			$T_A = -40^\circ C$ to $+125^\circ C$	-50			nA
I_{OS}	Input offset current			-10	± 0.5	10	nA
			$T_A = -40^\circ C$ to $+125^\circ C$	-25		25	nA
V_{CM}	Common mode range ⁽¹⁾		$V_S = 3$ to 36V	(V-)		(V+) - 1.5	V
			$V_S = 3$ to 36V, $T_A = -40^\circ C$ to $+125^\circ C$	(V-)		(V+) - 2.0	V
A_{VD}	Large signal differential voltage amplification		$V_S = 15V$, $V_O = 1.4V$ to 11.4V; $R_L \geq 15k$ to (V+)	50	200		V/mV
V_{OL}	Low level output Voltage (swing from (V-))		$I_{SINK} \leq 4mA$, $V_{ID} = -1V$		110	400	mV
			$I_{SINK} \leq 4mA$, $V_{ID} = -1V$ $T_A = -40^\circ C$ to $+125^\circ C$			550	mV
I_{OH-LKG}	High-level output leakage current		(V+) = $V_O = 5V$; $V_{ID} = 1V$		0.1	20	nA
			(V+) = $V_O = 36V$; $V_{ID} = 1V$		0.3	50	nA
I_{OL}	Low level output current		$V_{OL} = 1.5V$; $V_{ID} = -1V$; $V_S = 5V$	6	21		mA
I_Q	Quiescent current (all comparators)		$V_S = 5V$, no load		400	600	μA
			$V_S = 36V$, no load, $T_A = -40^\circ C$ to $+125^\circ C$		550	800	μA

(1) The voltage at any input should not be allowed to go negative by more than 0.3V. The upper end of the input voltage range is $V_{CC} - 1.5V$ for one input, and the other input can exceed the V_{CC} level; the comparator provides a proper output state. Either or both inputs can go to 36V without damage.

2.10 Switching Characteristics LM2903B - Q1

$V_S = 5V$, V_O PULLUP = 5V, $V_{CM} = V_S/2$, $C_L = 15pF$, $R_L = 5.1k\Omega$, $T_A = 25^\circ C$ (unless otherwise noted).

PARAMETER			TEST CONDITIONS	MIN	TYP	MAX	UNIT
$t_{response}$	Propagation delay time, high-to-low; TTL input signal ⁽¹⁾		TTL input with $V_{ref} = 1.4V$		300		ns
$t_{response}$	Propagation delay time, high-to-low; Small scale input signal ⁽¹⁾		Input overdrive = 5mV, Input step = 100mV		1000		ns

(1) High-to-low and low-to-high refers to the transition at the input.

2.11 LM2903B-Q1 "T", "R" and "H" Temperature Test Options

The following table describes the production temperature testing for the LM2903B-Q1 "H", "R" and "T" options. Specifications are the same as the LM2903B-Q1 above.

Test	LM2903B-Q1	LM2903BR-Q1	LM2903BH-Q1	LM2903BT-Q1
Probe (Wafer)	-	25°C	125°C	-40°C and 125°C
Final (Packaged)	25°C	25°C	25°C	25°C

2.12 Electrical Characteristics, LM2903-Q1 and LM2903E-Q1

at specified free-air temperature, $V_{CC} = 5V$ (unless otherwise noted)

PARAMETER	TEST CONDITIONS		T_A (1)	MIN	TYP	MAX	UNIT	
V_{IO} Input offset voltage	$V_O = 1.4V$, $V_{IC} = V_{IC(min)}$, $V_{CC} = 5V$ to $MAX^{(2)}$	Non-A devices	25°C	2	7		mV	
			Full range			15		
		A-suffix devices	25°C		1	2		
			Full range					4
I_{IO} Input offset current	$V_O = 1.4V$		25°C		5	50	nA	
			Full range					200
I_{IB} Input bias current	$V_O = 1.4V$		25°C		-25	-250	nA	
			Full range					-500
V_{ICR} Common-mode input voltage range(3)			25°C	0 to $V_{CC}-1.5$			V	
			Full range	0 to $V_{CC}-2$				
A_{VD} Large-signal differential-voltage amplification	$V_{CC} = 15V$, $V_O = 1.4V$ to $11.4V$, $R_L \geq 15k\Omega$ to V_{CC}		25°C	25	100		V/mV	
I_{OH} High-level output current	$V_{OH} = 5V$	$V_{ID} = 1V$	25°C		0.1	50	nA	
	$V_{OH} = V_{CC} MAX^{(2)}$		Full range				1	μA
V_{OL} Low-level output voltage	$I_{OL} = 4mA$,	$V_{ID} = -1V$	25°C		150	400	mV	
			Full range					700
I_{OL} Low-level output current	$V_{OL} = 1.5V$,	$V_{ID} = -1V$	25°C		6		mA	
I_{CC} Supply current	$R_L = \infty$		$V_{CC} = 5V$	25°C		0.8	1	mA
			$V_{CC} = MAX^{(2)}$	Full range				

- (1) Full range (MIN or MAX) for LM2903-Q1 is $-40^\circ C$ to $125^\circ C$ and $-40^\circ C$ to $150^\circ C$ for the LM2903E-Q1. All characteristics are measured with zero common-mode input voltage, unless otherwise specified.
- (2) $V_{CC} MAX = 30V$ for non-V devices and $32V$ for V-suffix devices.
- (3) The voltage at either input or common-mode can not be allowed to go negative by more than $0.3V$. The upper end of the common-mode voltage range is $V_{CC} + -1.5V$ for the inverting input (-), and the non-inverting input (+) can exceed the V_{CC} level; the comparator provides a proper output state. Either or both inputs can go to $30V$ ($32V$ for V-suffix devices) without damage.

2.13 Switching Characteristics, LM2903-Q1 and LM2903E-Q1

$V_{CC} = 5V$, $T_A = 25^\circ C$

PARAMETER	TEST CONDITIONS		TYP	UNIT
Response time	R_L connected to $5V$ through $5.1k\Omega$,	100m input step with $5mV$ overdrive	1.3	μs
	$C_L = 15pF^{(1)}$ (2)	TTL-level input step	0.3	

- (1) C_L includes probe and jig capacitance.
- (2) The response time specified is the interval between the input step function and the instant when the output crosses $1.4V$.

2.14 Typical Characteristics

$T_A = 25^\circ\text{C}$, $V_S = 5\text{V}$, $R_{\text{PULLUP}} = 5.1\text{k}$, $C_L = 15\text{pF}$, $V_{\text{CM}} = 0\text{V}$, $V_{\text{UNDERDRIVE}} = 100\text{mV}$, $V_{\text{OVERDRIVE}} = 100\text{mV}$ unless otherwise noted.

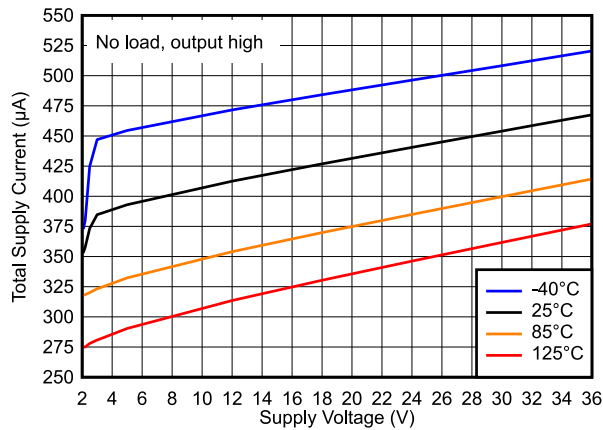

Figure 2-1. Total Supply Current vs. Supply Voltage

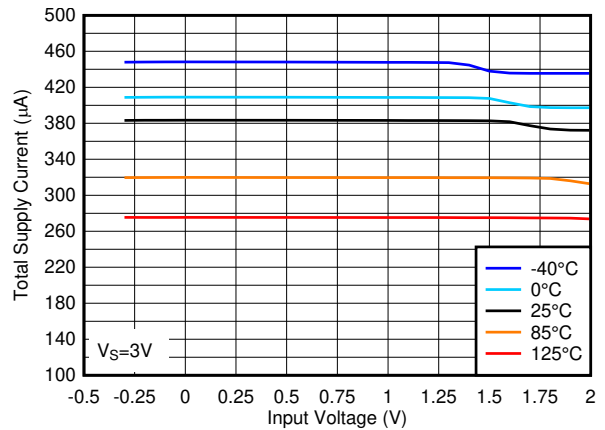

Figure 2-2. Total Supply Current vs. Input Voltage at 3V

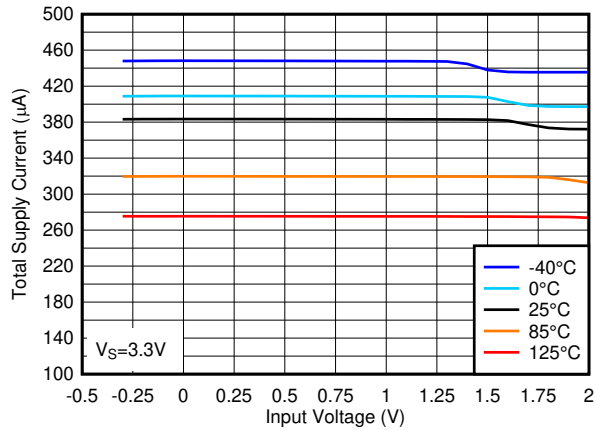

Figure 2-3. Total Supply Current vs. Input Voltage at 3.3V

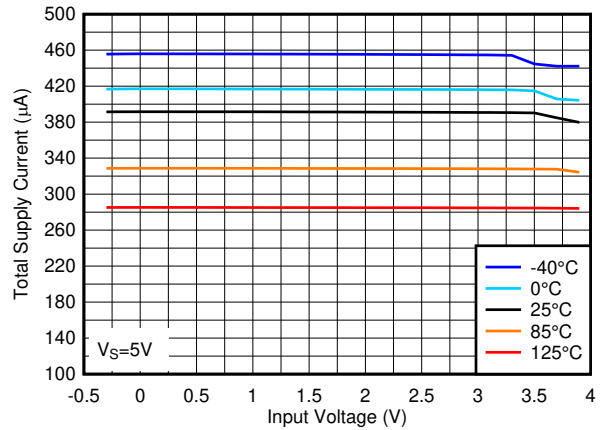

Figure 2-4. Total Supply Current vs. Input Voltage at 5V

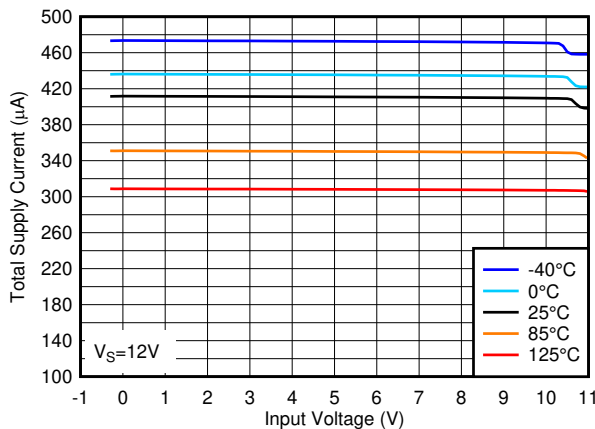

Figure 2-5. Total Supply Current vs. Input Voltage at 12V

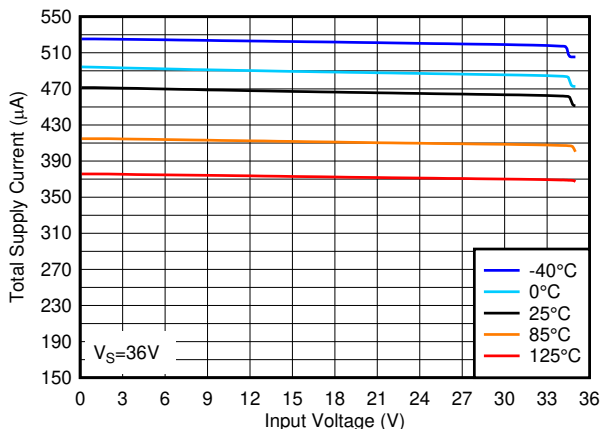

Figure 2-6. Total Supply Current vs. Input Voltage at 36V

2.14 Typical Characteristics (continued)

$T_A = 25^\circ\text{C}$, $V_S = 5\text{V}$, $R_{\text{PULLUP}} = 5.1\text{k}$, $C_L = 15\text{pF}$, $V_{\text{CM}} = 0\text{V}$, $V_{\text{UNDERDRIVE}} = 100\text{mV}$, $V_{\text{OVERDRIVE}} = 100\text{mV}$ unless otherwise noted.

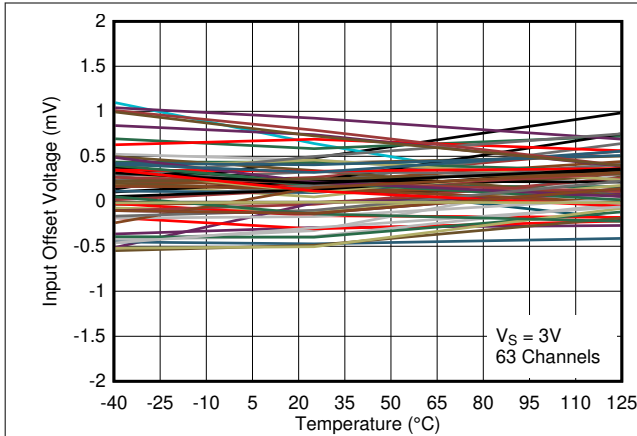

Figure 2-7. Input Offset Voltage vs. Temperature at 3V

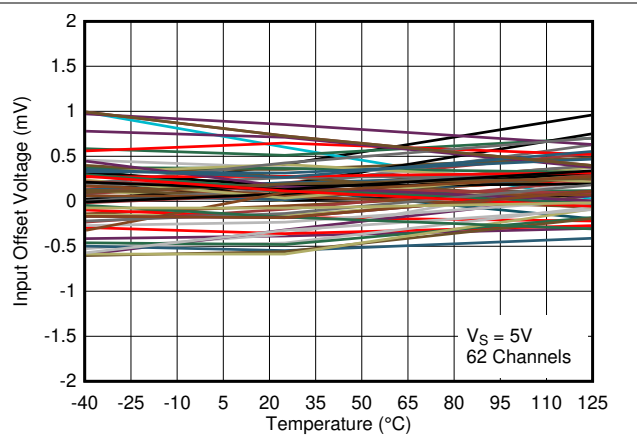

Figure 2-8. Input Offset Voltage vs. Temperature at 5V

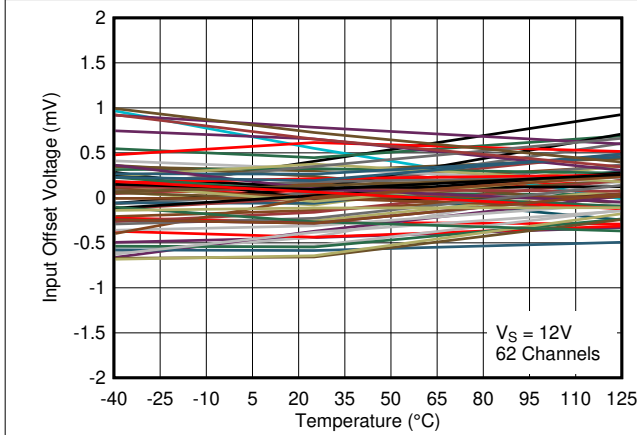

Figure 2-9. Input Offset Voltage vs. Temperature at 12V

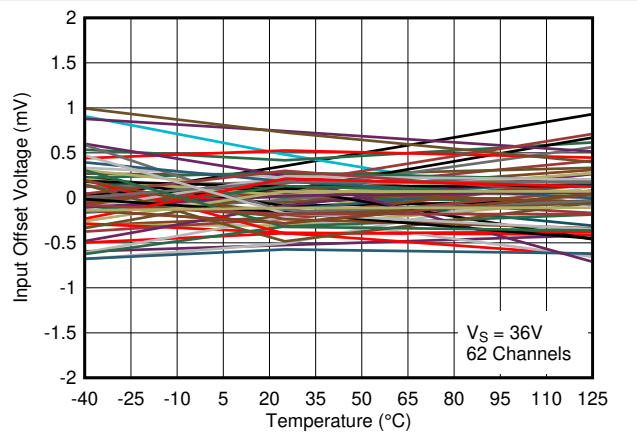

Figure 2-10. Input Offset Voltage vs. Temperature at 36V

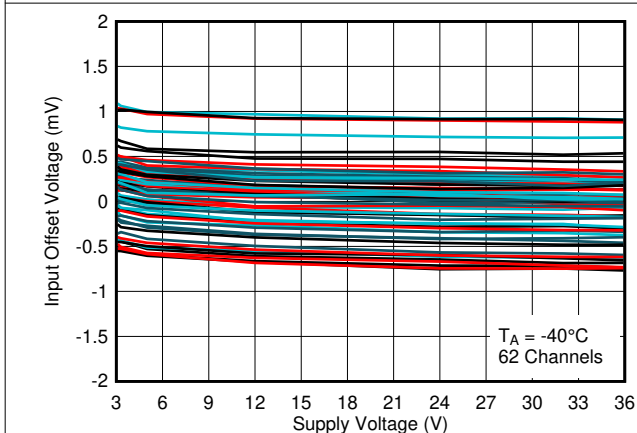

Figure 2-11. Input Offset Voltage vs. Supply Voltage at -40°C

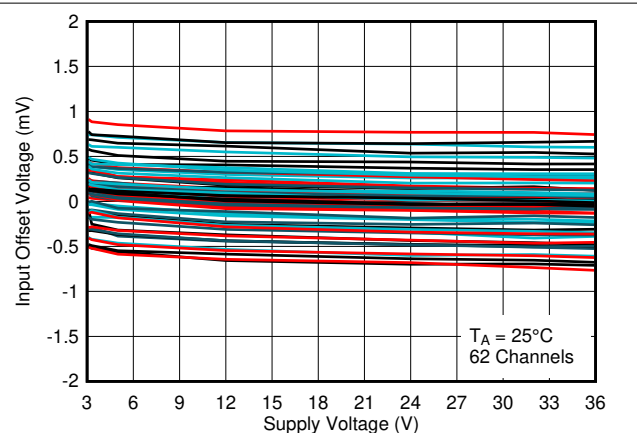

Figure 2-12. Input Offset Voltage vs. Supply Voltage at 25°C

2.14 Typical Characteristics (continued)

$T_A = 25^\circ\text{C}$, $V_S = 5\text{V}$, $R_{\text{PULLUP}} = 5.1\text{k}$, $C_L = 15\text{pF}$, $V_{\text{CM}} = 0\text{V}$, $V_{\text{UNDERDRIVE}} = 100\text{mV}$, $V_{\text{OVERDRIVE}} = 100\text{mV}$ unless otherwise noted.

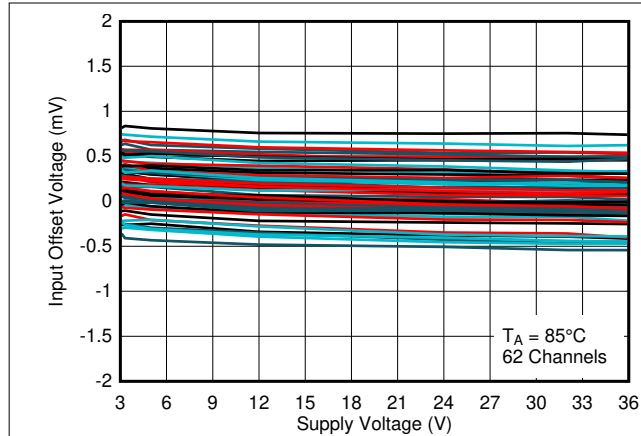

Figure 2-13. Input Offset Voltage vs. Supply Voltage at 85°C

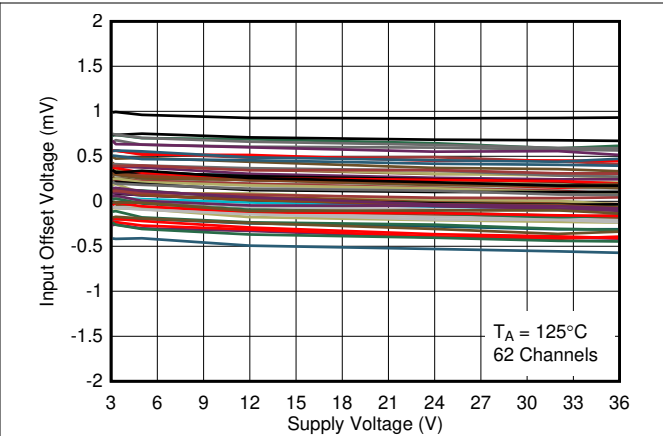

Figure 2-14. Input Offset Voltage vs. Supply Voltage at 125°C

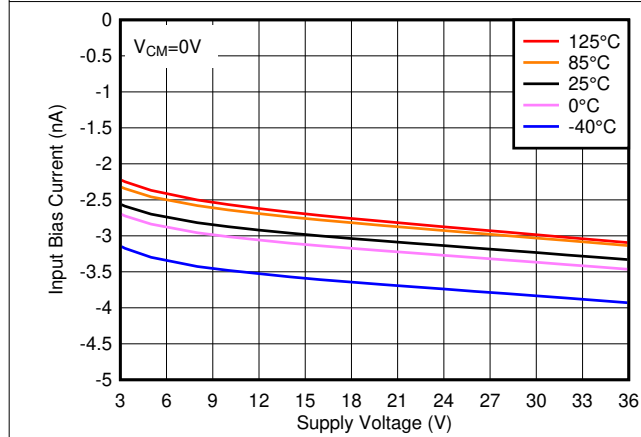

Figure 2-15. Input Bias Current vs. Supply Voltage

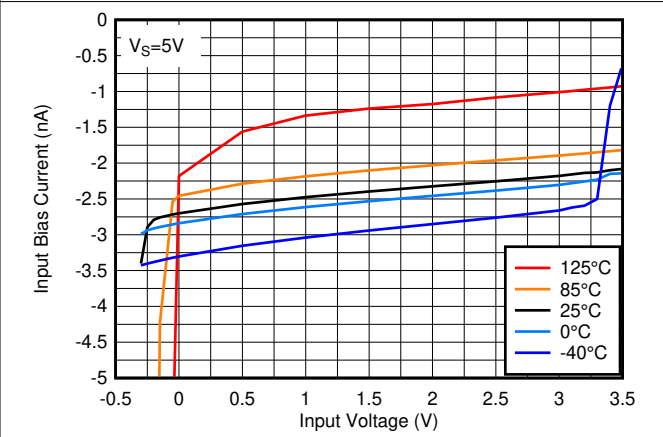

Figure 2-16. Input Bias Current vs. Input Voltage at 5V

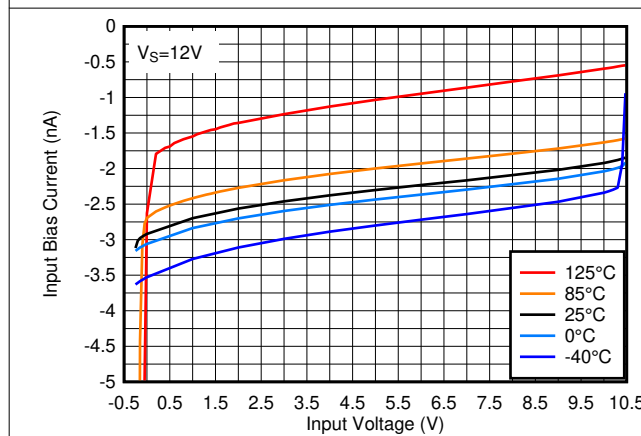

Figure 2-17. Input Bias Current vs. Input Voltage at 12V

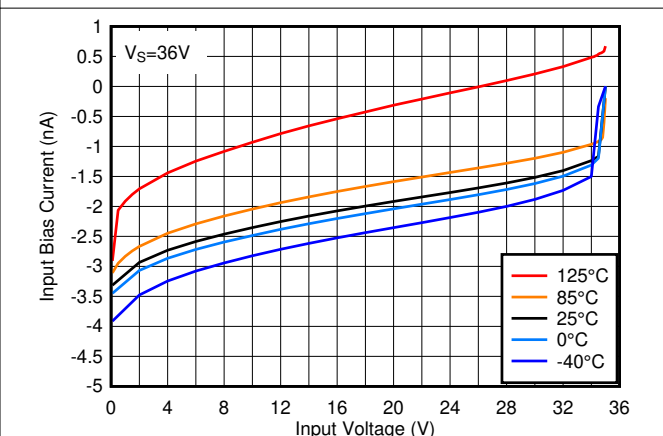

Figure 2-18. Input Bias Current vs. Input Voltage at 36V

2.14 Typical Characteristics (continued)

$T_A = 25^\circ\text{C}$, $V_S = 5\text{V}$, $R_{\text{PULLUP}} = 5.1\text{k}$, $C_L = 15\text{pF}$, $V_{\text{CM}} = 0\text{V}$, $V_{\text{UNDERDRIVE}} = 100\text{mV}$, $V_{\text{OVERDRIVE}} = 100\text{mV}$ unless otherwise noted.

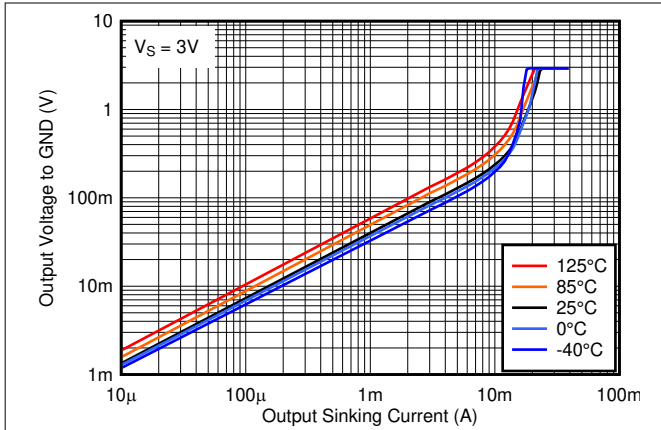

Figure 2-19. Output Low Voltage vs. Output Sinking Current at 3V

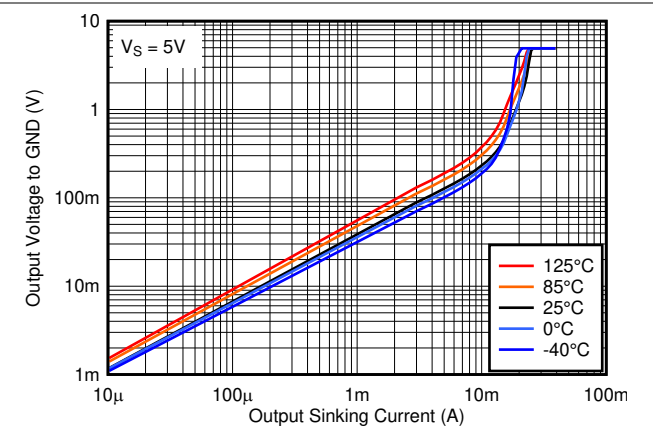

Figure 2-20. Output Low Voltage vs. Output Sinking Current at 5V

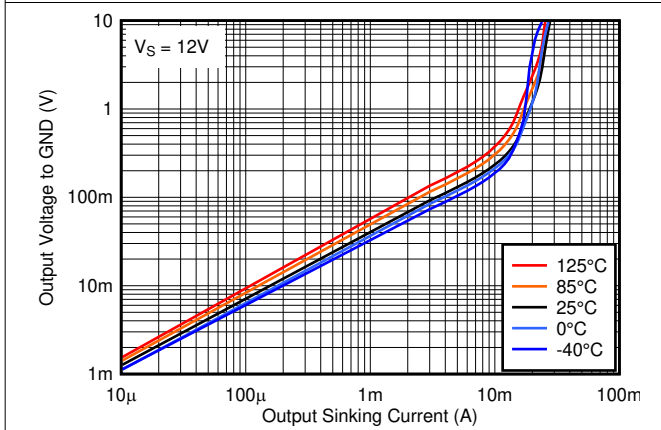

Figure 2-21. Output Low Voltage vs. Output Sinking Current at 12V

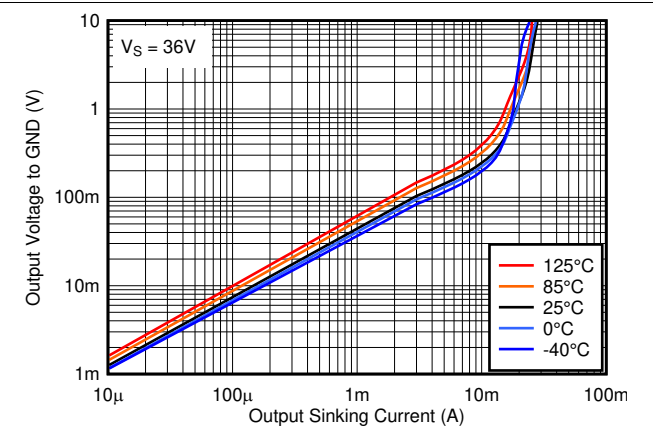

Figure 2-22. Output Low Voltage vs. Output Sinking Current at 36V

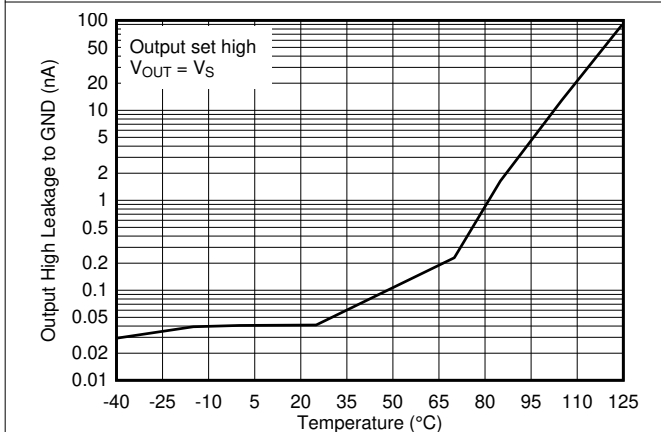

Figure 2-23. Output High Leakage Current vs. Temperature at 5V

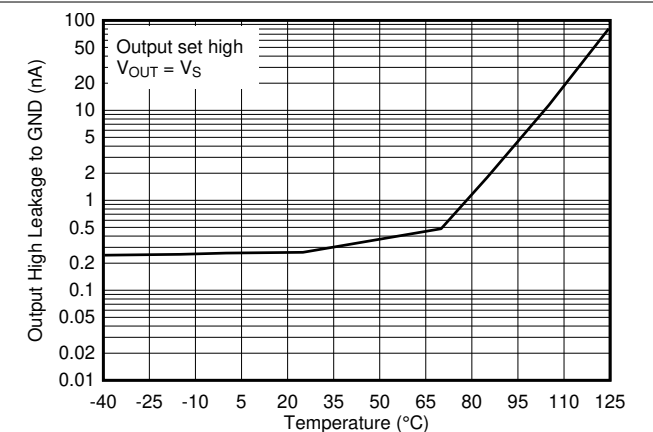

Figure 2-24. Output High Leakage Current vs. Temperature at 36V

2.14 Typical Characteristics (continued)

$T_A = 25^\circ\text{C}$, $V_S = 5\text{V}$, $R_{\text{PULLUP}} = 5.1\text{k}$, $C_L = 15\text{pF}$, $V_{\text{CM}} = 0\text{V}$, $V_{\text{UNDERDRIVE}} = 100\text{mV}$, $V_{\text{OVERDRIVE}} = 100\text{mV}$ unless otherwise noted.

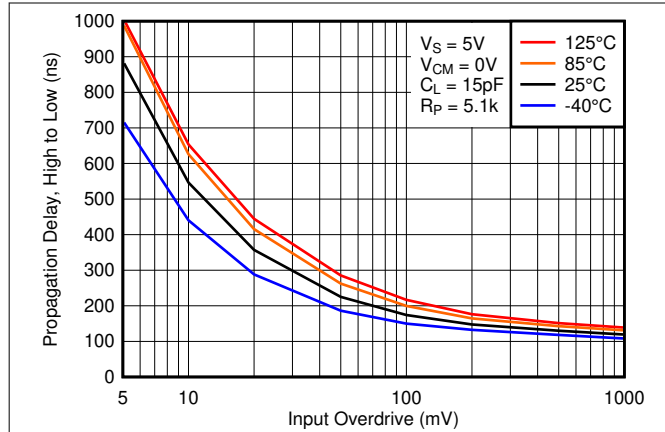

Figure 2-25. High to Low Propagation Delay vs. Input Overdrive Voltage, 5V

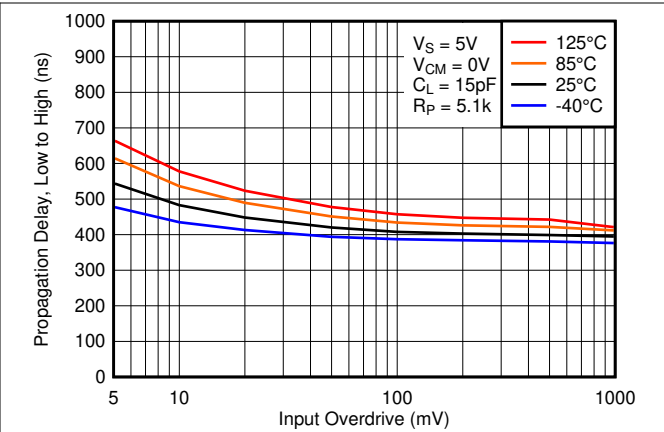

Figure 2-26. Low to High Propagation Delay vs. Input Overdrive Voltage, 5V

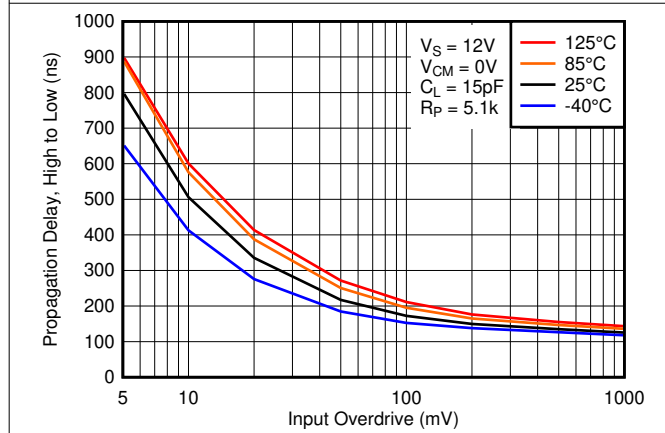

Figure 2-27. High to Low Propagation Delay vs. Input Overdrive Voltage, 12V

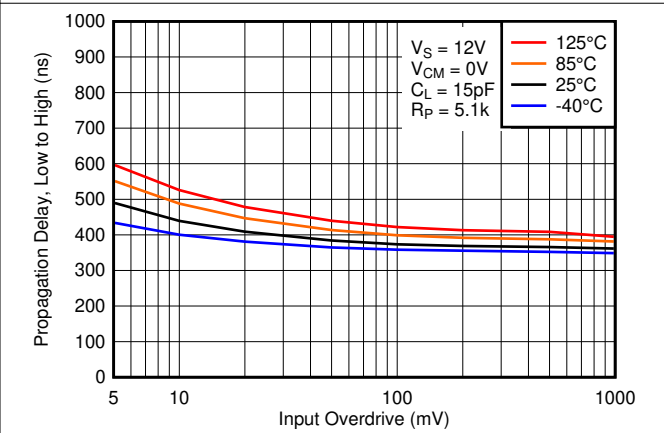

Figure 2-28. Low to High Propagation Delay vs. Input Overdrive Voltage, 12V

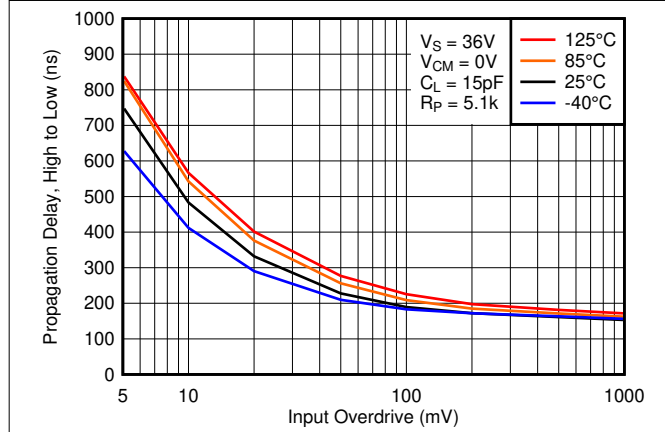

Figure 2-29. High to Low Propagation Delay vs. Input Overdrive Voltage, 36V

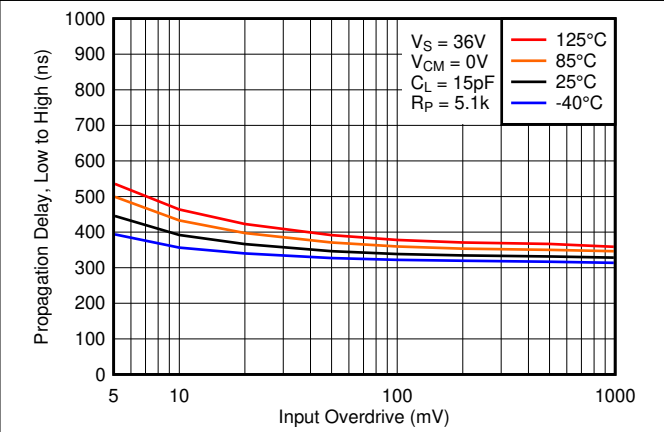

Figure 2-30. Low to High Propagation Delay vs. Input Overdrive Voltage, 36V

2.14 Typical Characteristics (continued)

$T_A = 25^\circ\text{C}$, $V_S = 5\text{V}$, $R_{\text{PULLUP}} = 5.1\text{k}$, $C_L = 15\text{pF}$, $V_{\text{CM}} = 0\text{V}$, $V_{\text{UNDERDRIVE}} = 100\text{mV}$, $V_{\text{OVERDRIVE}} = 100\text{mV}$ unless otherwise noted.

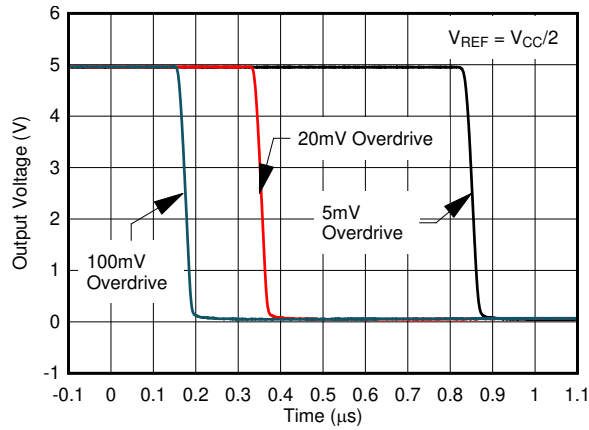

Figure 2-31. Response Time for Various Overdrives, High-to-Low Transition

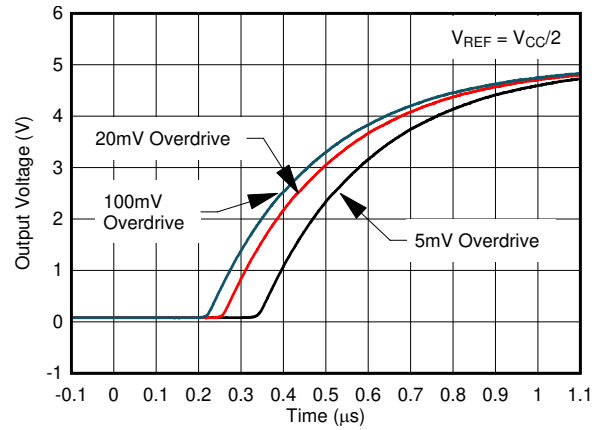

Figure 2-32. Response Time for Various Overdrives, Low-to-High Transition

3 Detailed Description

3.1 Overview

The LM2903-Q1 family is a dual comparator with the ability to operate up to 36V on the supply pin. This standard device has proven ubiquity and versatility across a wide range of applications. This is due to its very wide supply voltages range (2V to 36V), low I_q and fast response.

This device is AEC-Q100 qualified and can operate over a wide temperature range of -40°C to 125°C (LM2903-Q1 and LM2903B-Q1) or -40°C to 150°C (LM2903E-Q1).

The open-drain output allows the user to configure the output's logic low voltage (V_{OL}) and can be utilized to enable the comparator to be used in AND functionality.

The "B" versions add dedicated ESD protections on all the pins for improved ESD performance as well as improved negative input voltage handling. Please see Application Note [SNOAA35](#) for more information

3.2 Functional Block Diagram

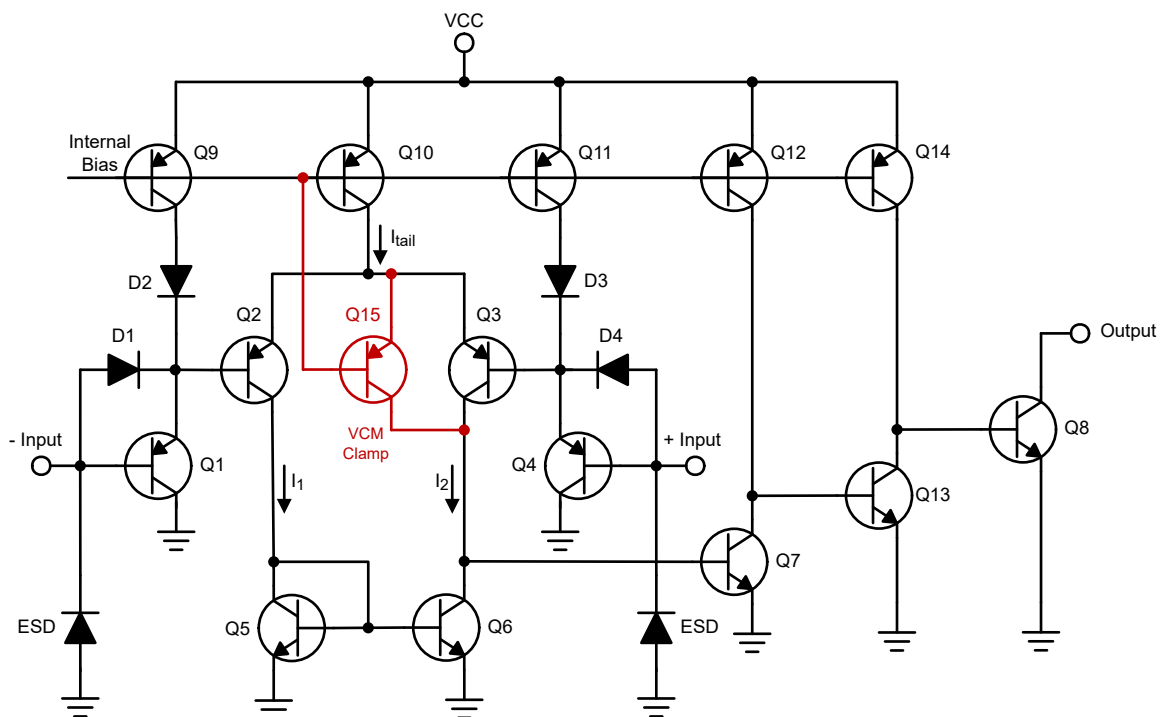

Figure 3-1. Schematic (Each Comparator)

3.3 Feature Description

LM2903-Q1 family consists of a PNP darlington pair input, allowing the device to operate with very high gain and fast response with minimal input bias current. The input Darlington pair creates a limit on the input common mode voltage capability, allowing LM2903-Q1 to accurately function from ground to $V_{CC}-1.5\text{V}$ differential input. This enables much head room for modern day supplies of 3.3V and 5.0V. A clamp (Q15) was added around Q3 to force the output low when both inputs are taken above the VCM range.

The output consists of an open drain NPN (pull-down or low side) transistor. The output NPN sinks current when the negative input voltage is higher than the positive input voltage and the offset voltage. The V_{OL} is resistive and scales with the output current. Please see [Output Low Voltage vs. Output Sinking Current at 5V](#) in the [Typical Characteristics](#) section for V_{OL} values with respect to the output current.

3.4 Device Functional Modes

3.4.1 Voltage Comparison

The LM2903-Q1 family operates solely as a voltage comparator, comparing the differential voltage between the positive and negative pins and outputting a logic low or high impedance (logic high with pull-up) based on the input differential polarity.

4 Application and Implementation

Note

Information in the following applications sections is not part of the TI component specification, and TI does not warrant its accuracy or completeness. TI's customers are responsible for determining suitability of components for their purposes, as well as validating and testing their design implementation to confirm system functionality.

4.1 Application Information

LM2903-Q1 will typically be used to compare a single signal to a reference or two signals against each other. Many users take advantage of the open drain output to drive the comparison logic output to a logic voltage level to an MCU or logic device. The wide supply range and high voltage capability makes LM2903Q1 optimal for level shifting to a higher or lower voltage.

4.2 Typical Application

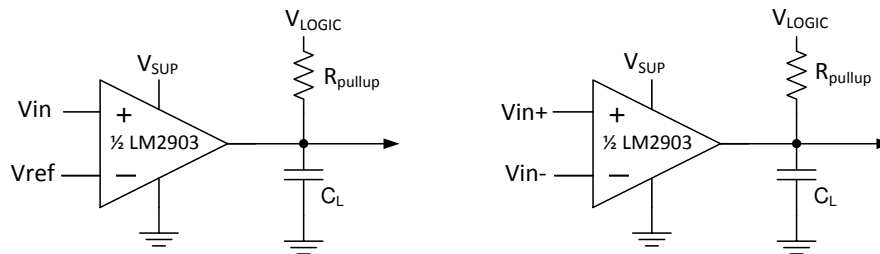

Figure 4-1. Single-ended and Differential Comparator Configurations

4.2.1 Design Requirements

For this design example, use the parameters listed in [Table 4-1](#) as the input parameters.

Table 4-1. Design Parameters

DESIGN PARAMETER	EXAMPLE VALUE
Input Voltage Range	0V to Vsup-1.5V
Supply Voltage	2V to 36V
Logic Supply Voltage	2V to 36V
Output Current (R _{PULLUP})	1μA to 20mA
Input Overdrive Voltage	100mV
Reference Voltage	2.5V
Load Capacitance (C _L)	15pF

4.2.2 Detailed Design Procedure

When using LM2903-Q1 family in a general comparator application, determine the following:

- Input Voltage Range
- Minimum Overdrive Voltage
- Output and Drive Current
- Response Time

4.2.2.1 Input Voltage Range

When choosing the input voltage range, the input common mode voltage range (V_{ICR}) must be taken in to account. If temperature operation is above or below 25°C the V_{ICR} can range from 0V to $V_{CC} - 2V$. This limits the input voltage range to as high as $V_{CC} - 2.0V$ and as low as 0V. Operation outside of this range can yield incorrect comparisons.

Below is a list of input voltage situation and the outcomes:

1. When both IN- and IN+ are both within the common mode range:
 - a. If IN- is higher than IN+ and the offset voltage, the output is low and the output transistor is sinking current
 - b. If IN- is lower than IN+ and the offset voltage, the output is high impedance and the output transistor is not conducting
2. When IN- is higher than common mode and IN+ is within common mode, the output is low and the output transistor is sinking current
3. When IN+ is higher than common mode and IN- is within common mode, the output is high impedance and the output transistor is not conducting
4. When IN- and IN+ are both higher than common mode, see Section 2 of [Application Design Guidelines for LM339, LM393, TL331 Family Comparators Including the New B-versions](#)

4.2.2.2 Minimum Overdrive Voltage

Overdrive Voltage is the differential voltage produced between the positive and negative inputs of the comparator over the offset voltage (V_{IO}). To make an accurate comparison the Overdrive Voltage (V_{OD}) must be higher than the input offset voltage (V_{IO}). Overdrive voltage can also determine the response time of the comparator, with the response time decreasing with increasing overdrive. [Figure 4-2](#) and [Figure 4-3](#) show positive and negative response times with respect to overdrive voltage.

4.2.2.3 Output and Drive Current

Output current is determined by the load/pull-up resistance and logic/pull-up voltage. The output current produces a output low voltage (V_{OL}) from the comparator. In which V_{OL} is proportional to the output current. Use [Figure 2-21](#) to determine V_{OL} based on the output current.

The output current can also effect the transient response. More explanation is in the next section.

4.2.2.4 Response Time

The transient response can be determined by the load capacitance (C_L), load/pull-up resistance (R_{PULLUP}) and equivalent collector-emitter resistance (R_{CE}).

- The positive response time (T_P) is approximately $T_P = R_{PULLUP} \times C_L$
- The negative response time (T_N) is approximately $T_N = R_{CE} \times C_L$
 - R_{CE} can be determine by taking the slope of [Figure 2-21](#) in it's linear region at the desired temperature, or by dividing the V_{OL} by I_{out}

4.2.3 Application Curves

The following curves were generated with 5V on V_{CC} and V_{Logic} , $R_{PULLUP} = 5.1k\Omega$, and 50pF scope probe.

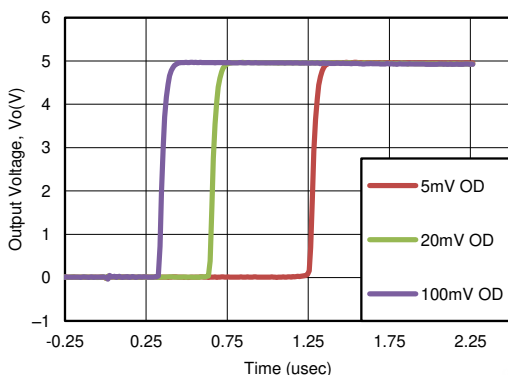

Figure 4-2. Response Time for Various Overdrives (Positive Transition)

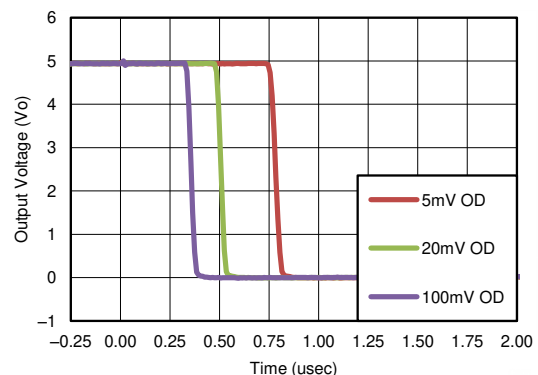

Figure 4-3. Response Time for Various Overdrives (Negative Transition)

4.3 Power Supply Recommendations

A bypass capacitor is recommended on the supply pin to reject any variation on the supply voltage. This variation can eat into the comparator's input common mode range and create an inaccurate comparison.

4.4 Layout

4.4.1 Layout Guidelines

For accurate comparator applications without hysteresis, a stable power supply with minimal noise must be maintained. To achieve this, the best practice is to add a bypass capacitor between the supply voltage and ground. This can be implemented on the positive power supply and negative supply (if available). If a negative supply is not being used, do not put a capacitor between the IC's GND pin and system ground.

4.4.2 Layout Example

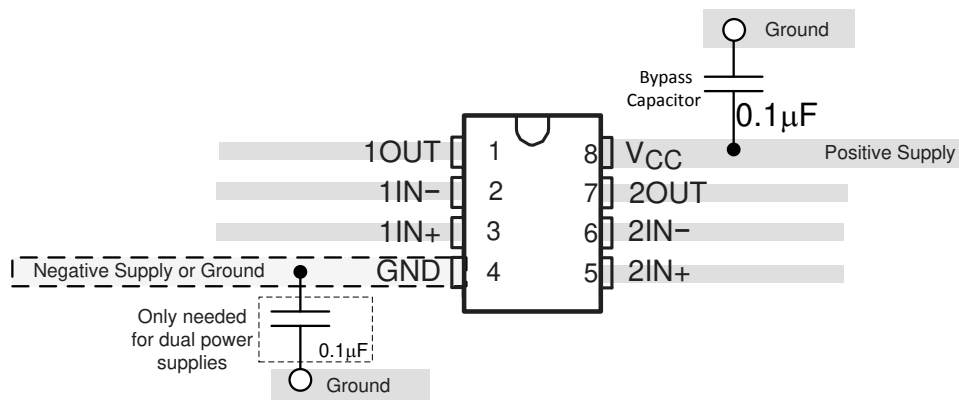

Figure 4-4. LM2903Q1 Layout Example

5 Device and Documentation Support

5.1 Documentation Support

5.1.1 Related Documentation

[LM2903B-Q1 Functional Safety FIT Rate, FMD and Pin FMA](#) - SLCA005

[Application Design Guidelines for LM339, LM393, TL331 Family Comparators](#) - SNOAA35

[Analog Engineers Circuit Cookbook: Amplifiers \(See Comparators section\)](#) - SLYY137

5.2 Receiving Notification of Documentation Updates

To receive notification of documentation updates, navigate to the device product folder on ti.com. In the upper right corner, click on *Alert me* to register and receive a weekly digest of any product information that has changed. For change details, review the revision history included in any revised document.

5.3 Support Resources

[TI E2E™ support forums](#) are an engineer's go-to source for fast, verified answers and design help — straight from the experts. Search existing answers or ask your own question to get the quick design help you need.

Linked content is provided "AS IS" by the respective contributors. They do not constitute TI specifications and do not necessarily reflect TI's views; see TI's [Terms of Use](#).

5.4 Trademarks

TI E2E™ is a trademark of Texas Instruments.

All trademarks are the property of their respective owners.

5.5 Electrostatic Discharge Caution



This integrated circuit can be damaged by ESD. Texas Instruments recommends that all integrated circuits be handled with appropriate precautions. Failure to observe proper handling and installation procedures can cause damage.

ESD damage can range from subtle performance degradation to complete device failure. Precision integrated circuits may be more susceptible to damage because very small parametric changes could cause the device not to meet its published specifications.

5.6 Glossary

[TI Glossary](#)

This glossary lists and explains terms, acronyms, and definitions.

6 Revision History

NOTE: Page numbers for previous revisions may differ from page numbers in the current version.

Changes from Revision L (August 2023) to Revision M (December 2024)	Page
• Updated thermal table	5
• Updated Typical Characteristics.....	8
• Updated Functional Block Diagram.....	14

Changes from Revision K (August 2022) to Revision L (August 2023)	Page
• Added reference to Application Note.....	16

Changes from Revision J (November 2020) to Revision K (August 2022)	Page
• Added T, R and H Temp Test Options table.....	6

Changes from Revision I (June 2020) to Revision J (November 2020)	Page
• Changed LM2903B-Q1 Minimum Recommended Supply Voltage to 2V throughout the data sheet.....	1
• Added Operating Virtual Temp to Abs Max Table for both versions.....	4
• Updated Supply Voltage vs Supply Current graph for 2V.....	4

Changes from Revision G (November 2018) to Revision H (January 2020)	Page
• Added LM2903B-Q1 to data sheet.....	1
• Added Device Information table.	1
• Added "B" device graphs	8
• Changed incorrect input text in Feature Description in Apps Section.....	14

Changes from Revision F (May 2018) to Revision G (November 2018)	Page
---	-------------

Changes from Revision H (January 2020) to Revision I (June 2020)	Page
• Added Functional Safety text and links.....	1
• Added VSSOP package to Device Info list for "B".....	1
• Added DGK to "B" Thermal Table.....	5
• Added text to Apps Overview section for ESD.....	14

7 Mechanical, Packaging, and Orderable Information

The following pages include mechanical, packaging, and orderable information. This information is the most current data available for the designated devices. This data is subject to change without notice and revision of this document. For browser-based versions of this data sheet, refer to the left-hand navigation.

PACKAGING INFORMATION

Orderable part number	Status (1)	Material type (2)	Package Pins	Package qty Carrier	RoHS (3)	Lead finish/ Ball material (4)	MSL rating/ Peak reflow (5)	Op temp (°C)	Part marking (6)
LM2903AVQDRG4Q1	Active	Production	SOIC (D) 8	2500 LARGE T&R	Yes	NIPDAU	Level-1-260C-UNLIM	-40 to 125	2903AVQ
LM2903AVQDRG4Q1.A	Active	Production	SOIC (D) 8	2500 LARGE T&R	Yes	NIPDAU	Level-1-260C-UNLIM	-40 to 125	2903AVQ
LM2903AVQDRG4Q1.B	Active	Production	SOIC (D) 8	2500 LARGE T&R	Yes	NIPDAU	Level-1-260C-UNLIM	-40 to 125	2903AVQ
LM2903AVQDRQ1	Active	Production	SOIC (D) 8	2500 LARGE T&R	Yes	NIPDAU	Level-1-260C-UNLIM	-40 to 125	(2903AVQ, 903AVQ)
LM2903AVQDRQ1.A	Active	Production	SOIC (D) 8	2500 LARGE T&R	Yes	NIPDAU	Level-1-260C-UNLIM	-40 to 125	(2903AVQ, 903AVQ)
LM2903AVQDRQ1.B	Active	Production	SOIC (D) 8	2500 LARGE T&R	Yes	NIPDAU	Level-1-260C-UNLIM	-40 to 125	(2903AVQ, 903AVQ)
LM2903AVQPWRG4Q1	Active	Production	TSSOP (PW) 8	2000 LARGE T&R	Yes	NIPDAU	Level-1-260C-UNLIM	-40 to 125	2903AVQ
LM2903AVQPWRG4Q1.A	Active	Production	TSSOP (PW) 8	2000 LARGE T&R	Yes	NIPDAU	Level-1-260C-UNLIM	-40 to 125	2903AVQ
LM2903AVQPWRQ1	Active	Production	TSSOP (PW) 8	2000 LARGE T&R	Yes	NIPDAU	Level-1-260C-UNLIM	-40 to 125	2903AVQ
LM2903AVQPWRQ1.A	Active	Production	TSSOP (PW) 8	2000 LARGE T&R	Yes	NIPDAU	Level-1-260C-UNLIM	-40 to 125	2903AVQ
LM2903BHQDGKRQ1	Active	Production	VSSOP (DGK) 8	2500 LARGE T&R	Yes	NIPDAU	Level-1-260C-UNLIM	-40 to 125	3BHQ
LM2903BHQDGKRQ1.A	Active	Production	VSSOP (DGK) 8	2500 LARGE T&R	Yes	NIPDAU	Level-1-260C-UNLIM	-40 to 125	3BHQ
LM2903BHQDGKRQ1.B	Active	Production	VSSOP (DGK) 8	2500 LARGE T&R	Yes	NIPDAU	Level-1-260C-UNLIM	-40 to 125	3BHQ
LM2903BHQDRQ1	Active	Production	SOIC (D) 8	3000 LARGE T&R	Yes	NIPDAU	Level-1-260C-UNLIM	-40 to 125	903BHQ
LM2903BHQDRQ1.A	Active	Production	SOIC (D) 8	3000 LARGE T&R	Yes	NIPDAU	Level-1-260C-UNLIM	-40 to 125	903BHQ
LM2903BHQDRQ1.B	Active	Production	SOIC (D) 8	3000 LARGE T&R	Yes	NIPDAU	Level-1-260C-UNLIM	-40 to 125	903BHQ
LM2903BHQPWRQ1	Active	Production	TSSOP (PW) 8	3000 LARGE T&R	Yes	NIPDAU	Level-1-260C-UNLIM	-40 to 125	2903BH
LM2903BHQPWRQ1.A	Active	Production	TSSOP (PW) 8	3000 LARGE T&R	Yes	NIPDAU	Level-1-260C-UNLIM	-40 to 125	2903BH
LM2903BHQPWRQ1.B	Active	Production	TSSOP (PW) 8	3000 LARGE T&R	Yes	NIPDAU	Level-1-260C-UNLIM	-40 to 125	2903BH
LM2903BQDDFRQ1	Active	Production	SOT-23-THIN (DDF) 8	3000 LARGE T&R	Yes	NIPDAU	Level-1-260C-UNLIM	-40 to 125	903BQ
LM2903BQDDFRQ1.B	Active	Production	SOT-23-THIN (DDF) 8	3000 LARGE T&R	Yes	NIPDAU	Level-1-260C-UNLIM	-40 to 125	903BQ
LM2903BQDGKRQ1	Active	Production	VSSOP (DGK) 8	2500 LARGE T&R	Yes	NIPDAU	Level-1-260C-UNLIM	-40 to 125	03BQ
LM2903BQDGKRQ1.A	Active	Production	VSSOP (DGK) 8	2500 LARGE T&R	Yes	NIPDAU	Level-1-260C-UNLIM	-40 to 125	03BQ
LM2903BQDGKRQ1.B	Active	Production	VSSOP (DGK) 8	2500 LARGE T&R	Yes	NIPDAU	Level-1-260C-UNLIM	-40 to 125	03BQ
LM2903BQDRQ1	Active	Production	SOIC (D) 8	2500 LARGE T&R	Yes	NIPDAU	Level-1-260C-UNLIM	-40 to 125	2903BQ
LM2903BQDRQ1.A	Active	Production	SOIC (D) 8	2500 LARGE T&R	Yes	NIPDAU	Level-1-260C-UNLIM	-40 to 125	2903BQ
LM2903BQDRQ1.B	Active	Production	SOIC (D) 8	2500 LARGE T&R	Yes	NIPDAU	Level-1-260C-UNLIM	-40 to 125	2903BQ
LM2903BQPWRQ1	Active	Production	TSSOP (PW) 8	2000 LARGE T&R	Yes	NIPDAU	Level-1-260C-UNLIM	-40 to 125	2903BQ
LM2903BQPWRQ1.A	Active	Production	TSSOP (PW) 8	2000 LARGE T&R	Yes	NIPDAU	Level-1-260C-UNLIM	-40 to 125	2903BQ

Orderable part number	Status (1)	Material type (2)	Package Pins	Package qty Carrier	RoHS (3)	Lead finish/ Ball material (4)	MSL rating/ Peak reflow (5)	Op temp (°C)	Part marking (6)
LM2903BQPWRQ1.B	Active	Production	TSSOP (PW) 8	2000 LARGE T&R	Yes	NIPDAU	Level-1-260C-UNLIM	-40 to 125	2903BQ
LM2903BRQDGKRQ1	Active	Production	VSSOP (DGK) 8	2500 LARGE T&R	Yes	NIPDAU	Level-1-260C-UNLIM	-40 to 125	3BRQ
LM2903BRQDGKRQ1.A	Active	Production	VSSOP (DGK) 8	2500 LARGE T&R	Yes	NIPDAU	Level-1-260C-UNLIM	-40 to 125	3BRQ
LM2903BRQDGKRQ1.B	Active	Production	VSSOP (DGK) 8	2500 LARGE T&R	Yes	NIPDAU	Level-1-260C-UNLIM	-40 to 125	3BRQ
LM2903BRQDRQ1	Active	Production	SOIC (D) 8	3000 LARGE T&R	Yes	NIPDAU	Level-1-260C-UNLIM	-40 to 125	903BRQ
LM2903BRQDRQ1.A	Active	Production	SOIC (D) 8	3000 LARGE T&R	Yes	NIPDAU	Level-1-260C-UNLIM	-40 to 125	903BRQ
LM2903BRQDRQ1.B	Active	Production	SOIC (D) 8	3000 LARGE T&R	Yes	NIPDAU	Level-1-260C-UNLIM	-40 to 125	903BRQ
LM2903BRQPWRQ1	Active	Production	TSSOP (PW) 8	3000 LARGE T&R	Yes	NIPDAU	Level-1-260C-UNLIM	-40 to 125	2903BR
LM2903BRQPWRQ1.A	Active	Production	TSSOP (PW) 8	3000 LARGE T&R	Yes	NIPDAU	Level-1-260C-UNLIM	-40 to 125	2903BR
LM2903BRQPWRQ1.B	Active	Production	TSSOP (PW) 8	3000 LARGE T&R	Yes	NIPDAU	Level-1-260C-UNLIM	-40 to 125	2903BR
LM2903BTQDGKRQ1	Active	Production	VSSOP (DGK) 8	2500 LARGE T&R	Yes	NIPDAU	Level-1-260C-UNLIM	-40 to 125	3BTQ
LM2903BTQDGKRQ1.A	Active	Production	VSSOP (DGK) 8	2500 LARGE T&R	Yes	NIPDAU	Level-1-260C-UNLIM	-40 to 125	3BTQ
LM2903BTQDGKRQ1.B	Active	Production	VSSOP (DGK) 8	2500 LARGE T&R	Yes	NIPDAU	Level-1-260C-UNLIM	-40 to 125	3BTQ
LM2903BTQDRQ1	Active	Production	SOIC (D) 8	3000 LARGE T&R	Yes	NIPDAU	Level-1-260C-UNLIM	-40 to 125	903BTQ
LM2903BTQDRQ1.A	Active	Production	SOIC (D) 8	3000 LARGE T&R	Yes	NIPDAU	Level-1-260C-UNLIM	-40 to 125	903BTQ
LM2903BTQDRQ1.B	Active	Production	SOIC (D) 8	3000 LARGE T&R	Yes	NIPDAU	Level-1-260C-UNLIM	-40 to 125	903BTQ
LM2903BTQPWRQ1	Active	Production	TSSOP (PW) 8	3000 LARGE T&R	Yes	NIPDAU	Level-1-260C-UNLIM	-40 to 125	2903BT
LM2903BTQPWRQ1.A	Active	Production	TSSOP (PW) 8	3000 LARGE T&R	Yes	NIPDAU	Level-1-260C-UNLIM	-40 to 125	2903BT
LM2903BTQPWRQ1.B	Active	Production	TSSOP (PW) 8	3000 LARGE T&R	Yes	NIPDAU	Level-1-260C-UNLIM	-40 to 125	2903BT
LM2903BWDSGRQ1	Active	Production	WSON (DSG) 8	3000 LARGE T&R	Yes	Call TI Sn	Level-2-260C-1 YEAR	-40 to 125	3BWQ
LM2903BWDSGRQ1.A	Active	Production	WSON (DSG) 8	3000 LARGE T&R	Yes	SN	Level-2-260C-1 YEAR	-40 to 125	3BWQ
LM2903BWDSGRQ1.B	Active	Production	WSON (DSG) 8	3000 LARGE T&R	Yes	SN	Level-2-260C-1 YEAR	-40 to 125	3BWQ
LM2903EPWRQ1	Active	Production	TSSOP (PW) 8	2000 LARGE T&R	Yes	NIPDAU	Level-2-260C-1 YEAR	-40 to 150	2903Q0
LM2903EPWRQ1.A	Active	Production	TSSOP (PW) 8	2000 LARGE T&R	Yes	NIPDAU	Level-2-260C-1 YEAR	-40 to 150	2903Q0
LM2903QDGKRQ1	Active	Production	VSSOP (DGK) 8	2500 LARGE T&R	Yes	NIPDAU	Level-1-260C-UNLIM	-40 to 125	KACQ
LM2903QDGKRQ1.A	Active	Production	VSSOP (DGK) 8	2500 LARGE T&R	Yes	NIPDAU	Level-1-260C-UNLIM	-40 to 125	KACQ
LM2903QDRG4Q1	Active	Production	SOIC (D) 8	2500 LARGE T&R	Yes	NIPDAU	Level-1-260C-UNLIM	-40 to 125	2903Q1
LM2903QDRG4Q1.A	Active	Production	SOIC (D) 8	2500 LARGE T&R	Yes	NIPDAU	Level-1-260C-UNLIM	-40 to 125	2903Q1
LM2903QDRQ1	Active	Production	SOIC (D) 8	2500 LARGE T&R	Yes	NIPDAU	Level-1-260C-UNLIM	-40 to 125	2903Q1
LM2903QDRQ1.A	Active	Production	SOIC (D) 8	2500 LARGE T&R	Yes	NIPDAU	Level-1-260C-UNLIM	-40 to 125	2903Q1
LM2903QDRQ1.B	Active	Production	SOIC (D) 8	2500 LARGE T&R	Yes	NIPDAU	Level-1-260C-UNLIM	-40 to 125	2903Q1

Orderable part number	Status (1)	Material type (2)	Package Pins	Package qty Carrier	RoHS (3)	Lead finish/ Ball material (4)	MSL rating/ Peak reflow (5)	Op temp (°C)	Part marking (6)
LM2903QPWRG4Q1	Active	Production	TSSOP (PW) 8	2000 LARGE T&R	Yes	NIPDAU	Level-1-260C-UNLIM	-40 to 125	2903Q1
LM2903QPWRG4Q1.A	Active	Production	TSSOP (PW) 8	2000 LARGE T&R	Yes	NIPDAU	Level-1-260C-UNLIM	-40 to 125	2903Q1
LM2903QPWRQ1	Active	Production	TSSOP (PW) 8	2000 LARGE T&R	Yes	NIPDAU	Level-1-260C-UNLIM	-40 to 125	2903Q1
LM2903QPWRQ1.A	Active	Production	TSSOP (PW) 8	2000 LARGE T&R	Yes	NIPDAU	Level-1-260C-UNLIM	-40 to 125	2903Q1
LM2903VQDRG4Q1	Obsolete	Production	SOIC (D) 8	-	-	Call TI	Call TI	-40 to 125	2903VQ1
LM2903VQDRQ1	Active	Production	SOIC (D) 8	2500 LARGE T&R	Yes	NIPDAU	Level-1-260C-UNLIM	-40 to 125	2903VQ1
LM2903VQDRQ1.A	Active	Production	SOIC (D) 8	2500 LARGE T&R	Yes	NIPDAU	Level-1-260C-UNLIM	-40 to 125	2903VQ1
LM2903VQDRQ1.B	Active	Production	SOIC (D) 8	2500 LARGE T&R	Yes	NIPDAU	Level-1-260C-UNLIM	-40 to 125	2903VQ1
LM2903VQPWRG4Q1	Active	Production	TSSOP (PW) 8	2000 LARGE T&R	Yes	NIPDAU	Level-1-260C-UNLIM	-40 to 125	2903VQ
LM2903VQPWRG4Q1.A	Active	Production	TSSOP (PW) 8	2000 LARGE T&R	Yes	NIPDAU	Level-1-260C-UNLIM	-40 to 125	2903VQ
LM2903VQPWRG4Q1.B	Active	Production	TSSOP (PW) 8	2000 LARGE T&R	Yes	NIPDAU	Level-1-260C-UNLIM	-40 to 125	2903VQ
LM2903VQPWRQ1	Active	Production	TSSOP (PW) 8	2000 LARGE T&R	Yes	NIPDAU	Level-1-260C-UNLIM	-40 to 125	2903VQ
LM2903VQPWRQ1.A	Active	Production	TSSOP (PW) 8	2000 LARGE T&R	Yes	NIPDAU	Level-1-260C-UNLIM	-40 to 125	2903VQ
LM2903VQPWRQ1.B	Active	Production	TSSOP (PW) 8	2000 LARGE T&R	Yes	NIPDAU	Level-1-260C-UNLIM	-40 to 125	2903VQ

(1) **Status:** For more details on status, see our [product life cycle](#).

(2) **Material type:** When designated, preproduction parts are prototypes/experimental devices, and are not yet approved or released for full production. Testing and final process, including without limitation quality assurance, reliability performance testing, and/or process qualification, may not yet be complete, and this item is subject to further changes or possible discontinuation. If available for ordering, purchases will be subject to an additional waiver at checkout, and are intended for early internal evaluation purposes only. These items are sold without warranties of any kind.

(3) **RoHS values:** Yes, No, RoHS Exempt. See the [TI RoHS Statement](#) for additional information and value definition.

(4) **Lead finish/Ball material:** Parts may have multiple material finish options. Finish options are separated by a vertical ruled line. Lead finish/Ball material values may wrap to two lines if the finish value exceeds the maximum column width.

(5) **MSL rating/Peak reflow:** The moisture sensitivity level ratings and peak solder (reflow) temperatures. In the event that a part has multiple moisture sensitivity ratings, only the lowest level per JEDEC standards is shown. Refer to the shipping label for the actual reflow temperature that will be used to mount the part to the printed circuit board.

(6) **Part marking:** There may be an additional marking, which relates to the logo, the lot trace code information, or the environmental category of the part.

Multiple part markings will be inside parentheses. Only one part marking contained in parentheses and separated by a "-" will appear on a part. If a line is indented then it is a continuation of the previous line and the two combined represent the entire part marking for that device.

Important Information and Disclaimer:The information provided on this page represents TI's knowledge and belief as of the date that it is provided. TI bases its knowledge and belief on information provided by third parties, and makes no representation or warranty as to the accuracy of such information. Efforts are underway to better integrate information from third parties. TI has taken and continues to take reasonable steps to provide representative and accurate information but may not have conducted destructive testing or chemical analysis on incoming materials and chemicals. TI and TI suppliers consider certain information to be proprietary, and thus CAS numbers and other limited information may not be available for release.

In no event shall TI's liability arising out of such information exceed the total purchase price of the TI part(s) at issue in this document sold by TI to Customer on an annual basis.

OTHER QUALIFIED VERSIONS OF LM2903-Q1, LM2903B-Q1 :

- Catalog : [LM2903](#), [LM2903B](#)

NOTE: Qualified Version Definitions:

- Catalog - TI's standard catalog product

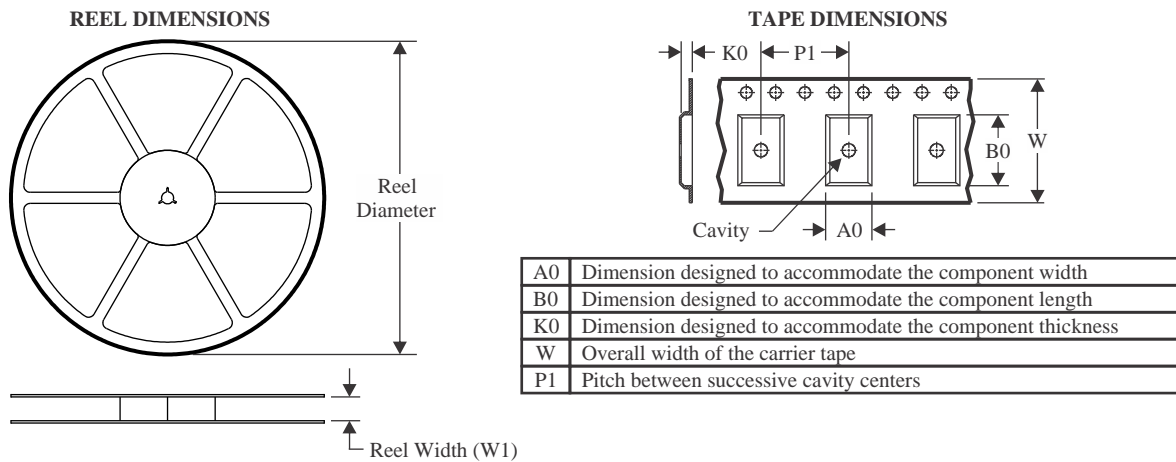
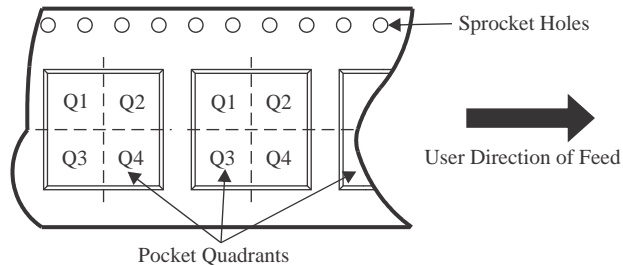
TAPE AND REEL INFORMATION

QUADRANT ASSIGNMENTS FOR PIN 1 ORIENTATION IN TAPE

*All dimensions are nominal

Device	Package Type	Package Drawing	Pins	SPQ	Reel Diameter (mm)	Reel Width W1 (mm)	A0 (mm)	B0 (mm)	K0 (mm)	P1 (mm)	W (mm)	Pin1 Quadrant
LM2903AVQDRG4Q1	SOIC	D	8	2500	330.0	12.4	6.4	5.2	2.1	8.0	12.0	Q1
LM2903AVQDRG4Q1	SOIC	D	8	2500	330.0	12.4	6.4	5.2	2.1	8.0	12.0	Q1
LM2903AVQDRQ1	SOIC	D	8	2500	330.0	12.4	6.4	5.2	2.1	8.0	12.0	Q1
LM2903AVQDRQ1	SOIC	D	8	2500	330.0	12.5	6.4	5.2	2.1	8.0	12.0	Q1
LM2903AVQPWRG4Q1	TSSOP	PW	8	2000	330.0	12.4	7.0	3.6	1.6	8.0	12.0	Q1
LM2903AVQPWRQ1	TSSOP	PW	8	2000	330.0	12.4	7.0	3.6	1.6	8.0	12.0	Q1
LM2903BHQDGKRQ1	VSSOP	DGK	8	2500	330.0	12.4	5.25	3.35	1.25	8.0	12.0	Q1
LM2903BHQDRQ1	SOIC	D	8	3000	330.0	12.4	6.4	5.2	2.1	8.0	12.0	Q1
LM2903BHQPWRQ1	TSSOP	PW	8	3000	330.0	12.4	7.0	3.6	1.6	8.0	12.0	Q1
LM2903BQDDFRQ1	SOT-23-THIN	DDF	8	3000	180.0	8.4	3.2	3.2	1.4	4.0	8.0	Q3
LM2903BQDGKRQ1	VSSOP	DGK	8	2500	330.0	12.4	5.3	3.4	1.4	8.0	12.0	Q1
LM2903BQDRQ1	SOIC	D	8	2500	330.0	12.4	6.4	5.2	2.1	8.0	12.0	Q1
LM2903BQPWRQ1	TSSOP	PW	8	2000	330.0	12.4	7.0	3.6	1.6	8.0	12.0	Q1
LM2903BRQDGKRQ1	VSSOP	DGK	8	2500	330.0	12.4	5.25	3.35	1.25	8.0	12.0	Q1
LM2903BRQDRQ1	SOIC	D	8	3000	330.0	12.4	6.4	5.2	2.1	8.0	12.0	Q1

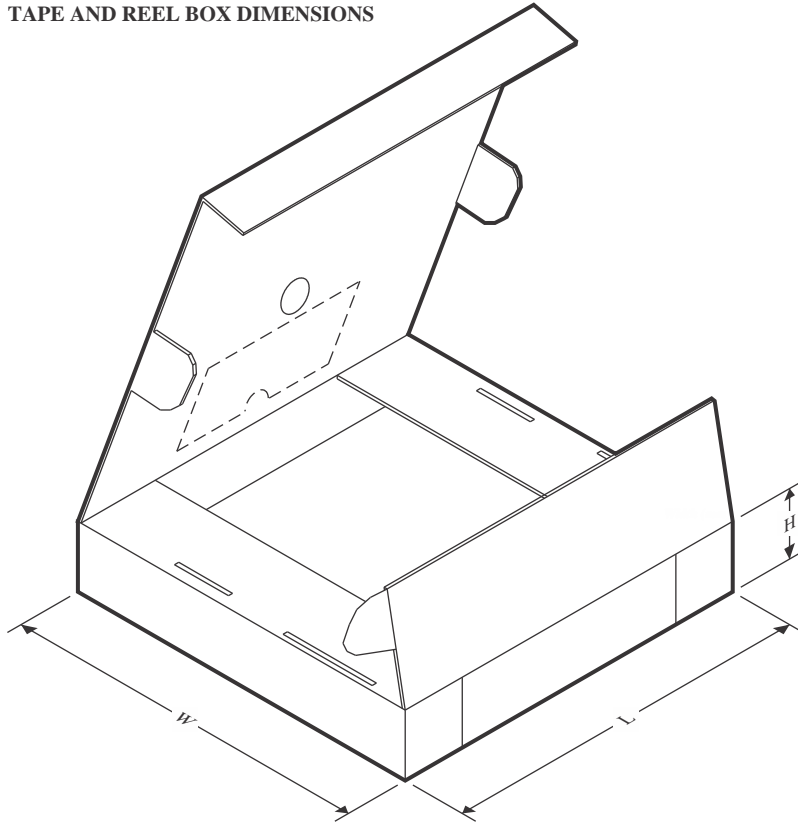
Device	Package Type	Package Drawing	Pins	SPQ	Reel Diameter (mm)	Reel Width W1 (mm)	A0 (mm)	B0 (mm)	K0 (mm)	P1 (mm)	W (mm)	Pin1 Quadrant
LM2903BRQPWRQ1	TSSOP	PW	8	3000	330.0	12.4	7.0	3.6	1.6	8.0	12.0	Q1
LM2903BTQDGKRQ1	VSSOP	DGK	8	2500	330.0	12.4	5.25	3.35	1.25	8.0	12.0	Q1
LM2903BTQDRQ1	SOIC	D	8	3000	330.0	12.4	6.4	5.2	2.1	8.0	12.0	Q1
LM2903BTQPWRQ1	TSSOP	PW	8	3000	330.0	12.4	7.0	3.6	1.6	8.0	12.0	Q1
LM2903BWDSGRQ1	WSON	DSG	8	3000	180.0	8.4	2.2	2.2	1.2	4.0	8.0	Q2
LM2903EPWRQ1	TSSOP	PW	8	2000	330.0	12.4	7.0	3.6	1.6	8.0	12.0	Q1
LM2903QDGKRQ1	VSSOP	DGK	8	2500	330.0	12.4	6.4	5.2	2.1	8.0	12.0	Q1
LM2903QDRG4Q1	SOIC	D	8	2500	330.0	12.4	6.4	5.2	2.1	8.0	12.0	Q1
LM2903QDRQ1	SOIC	D	8	2500	330.0	12.4	6.4	5.2	2.1	8.0	12.0	Q1
LM2903QPWRG4Q1	TSSOP	PW	8	2000	330.0	12.4	7.0	3.6	1.6	8.0	12.0	Q1
LM2903QPWRQ1	TSSOP	PW	8	2000	330.0	12.4	7.0	3.6	1.6	8.0	12.0	Q1
LM2903VQDRQ1	SOIC	D	8	2500	330.0	12.4	6.4	5.2	2.1	8.0	12.0	Q1
LM2903VQPWRG4Q1	TSSOP	PW	8	2000	330.0	12.4	7.0	3.6	1.6	8.0	12.0	Q1
LM2903VQPWRQ1	TSSOP	PW	8	2000	330.0	12.4	7.0	3.6	1.6	8.0	12.0	Q1

TAPE AND REEL BOX DIMENSIONS

*All dimensions are nominal

Device	Package Type	Package Drawing	Pins	SPQ	Length (mm)	Width (mm)	Height (mm)
LM2903AVQDRG4Q1	SOIC	D	8	2500	353.0	353.0	32.0
LM2903AVQDRG4Q1	SOIC	D	8	2500	340.5	338.1	20.6
LM2903AVQDRQ1	SOIC	D	8	2500	340.5	338.1	20.6
LM2903AVQDRQ1	SOIC	D	8	2500	353.0	353.0	32.0
LM2903AVQPWRG4Q1	TSSOP	PW	8	2000	353.0	353.0	32.0
LM2903AVQPWRQ1	TSSOP	PW	8	2000	353.0	353.0	32.0
LM2903BHQDGKRQ1	VSSOP	DGK	8	2500	366.0	364.0	50.0
LM2903BHQDRQ1	SOIC	D	8	3000	340.5	338.1	20.6
LM2903BHPWRQ1	TSSOP	PW	8	3000	353.0	353.0	32.0
LM2903BQDDFRQ1	SOT-23-THIN	DDF	8	3000	210.0	185.0	35.0
LM2903BQDGKRQ1	VSSOP	DGK	8	2500	353.0	353.0	32.0
LM2903BQDRQ1	SOIC	D	8	2500	353.0	353.0	32.0
LM2903BQPWRQ1	TSSOP	PW	8	2000	353.0	353.0	32.0
LM2903BRQDGKRQ1	VSSOP	DGK	8	2500	366.0	364.0	50.0
LM2903BRQDRQ1	SOIC	D	8	3000	340.5	338.1	20.6
LM2903BRQPWRQ1	TSSOP	PW	8	3000	353.0	353.0	32.0
LM2903BTQDGKRQ1	VSSOP	DGK	8	2500	366.0	364.0	50.0
LM2903BTQDRQ1	SOIC	D	8	3000	340.5	338.1	20.6

Device	Package Type	Package Drawing	Pins	SPQ	Length (mm)	Width (mm)	Height (mm)
LM2903BTQPWRQ1	TSSOP	PW	8	3000	353.0	353.0	32.0
LM2903BWDSGRQ1	WSON	DSG	8	3000	213.0	191.0	35.0
LM2903EPWRQ1	TSSOP	PW	8	2000	353.0	353.0	32.0
LM2903QDGKRQ1	VSSOP	DGK	8	2500	353.0	353.0	32.0
LM2903QDRG4Q1	SOIC	D	8	2500	353.0	353.0	32.0
LM2903QDRQ1	SOIC	D	8	2500	353.0	353.0	32.0
LM2903QPWRG4Q1	TSSOP	PW	8	2000	353.0	353.0	32.0
LM2903QPWRQ1	TSSOP	PW	8	2000	353.0	353.0	32.0
LM2903VQDRQ1	SOIC	D	8	2500	353.0	353.0	32.0
LM2903VQPWRG4Q1	TSSOP	PW	8	2000	353.0	353.0	32.0
LM2903VQPWRQ1	TSSOP	PW	8	2000	353.0	353.0	32.0

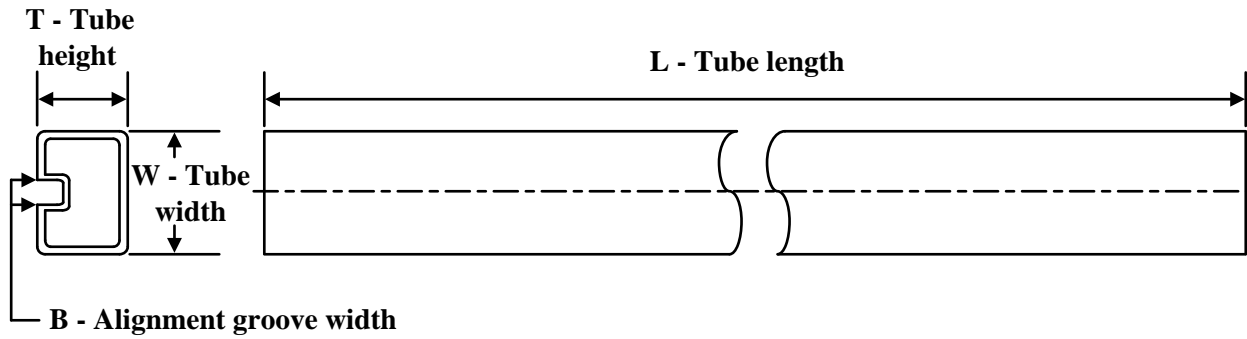
TUBE

*All dimensions are nominal

Device	Package Name	Package Type	Pins	SPQ	L (mm)	W (mm)	T (μm)	B (mm)
LM2903BQDGKRQ1	DGK	VSSOP	8	2500	328	7.98	550	NA
LM2903BQDGKRQ1.A	DGK	VSSOP	8	2500	328	7.98	550	NA
LM2903BQDGKRQ1.B	DGK	VSSOP	8	2500	328	7.98	550	NA

DGK0008A

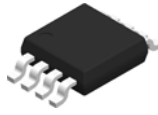

PACKAGE OUTLINE

VSSOP - 1.1 mm max height

SMALL OUTLINE PACKAGE

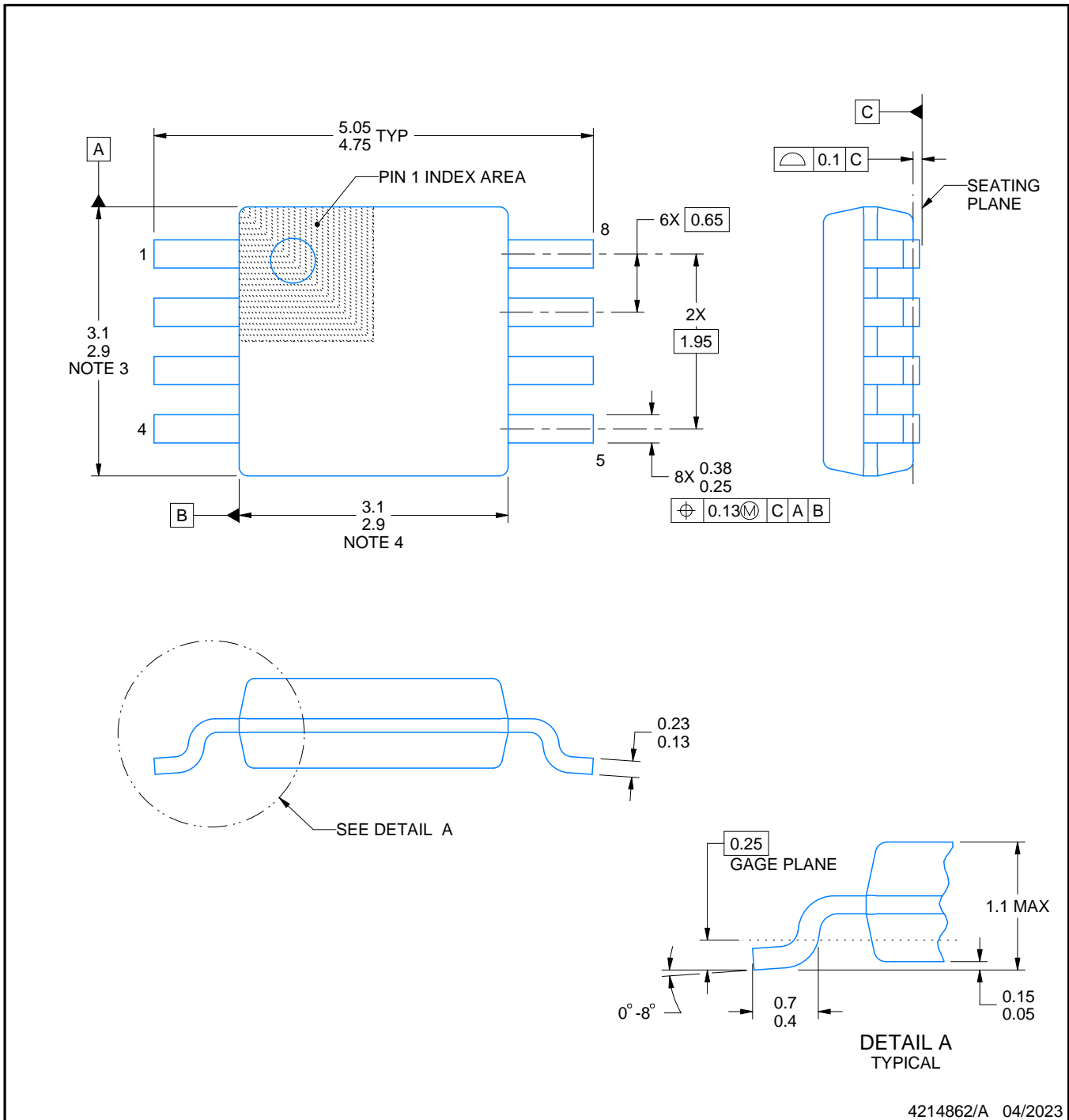

4214862/A 04/2023

NOTES:

PowerPAD is a trademark of Texas Instruments.

1. All linear dimensions are in millimeters. Any dimensions in parenthesis are for reference only. Dimensioning and tolerancing per ASME Y14.5M.
2. This drawing is subject to change without notice.
3. This dimension does not include mold flash, protrusions, or gate burrs. Mold flash, protrusions, or gate burrs shall not exceed 0.15 mm per side.
4. This dimension does not include interlead flash. Interlead flash shall not exceed 0.25 mm per side.
5. Reference JEDEC registration MO-187.

EXAMPLE BOARD LAYOUT

DGK0008A

™ VSSOP - 1.1 mm max height

SMALL OUTLINE PACKAGE

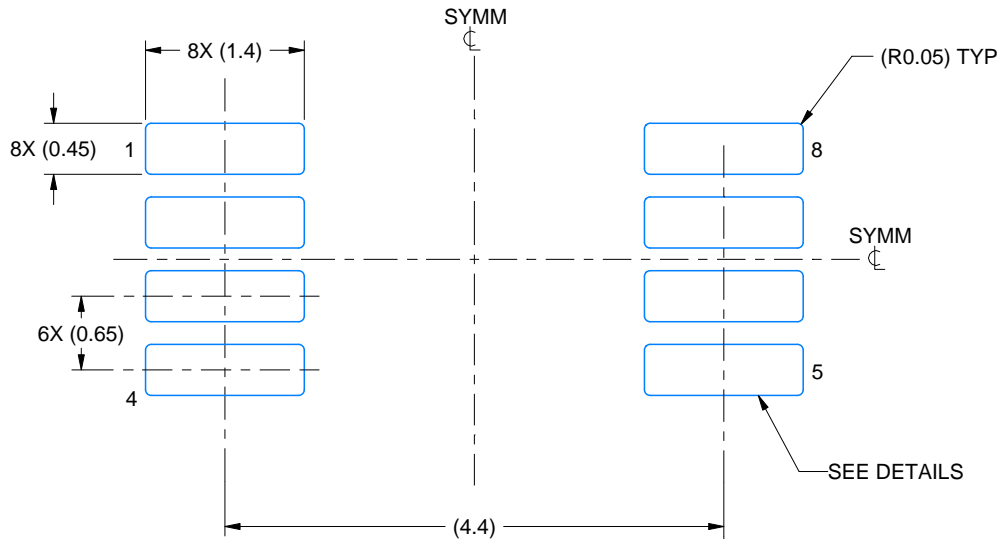

LAND PATTERN EXAMPLE
EXPOSED METAL SHOWN
SCALE: 15X

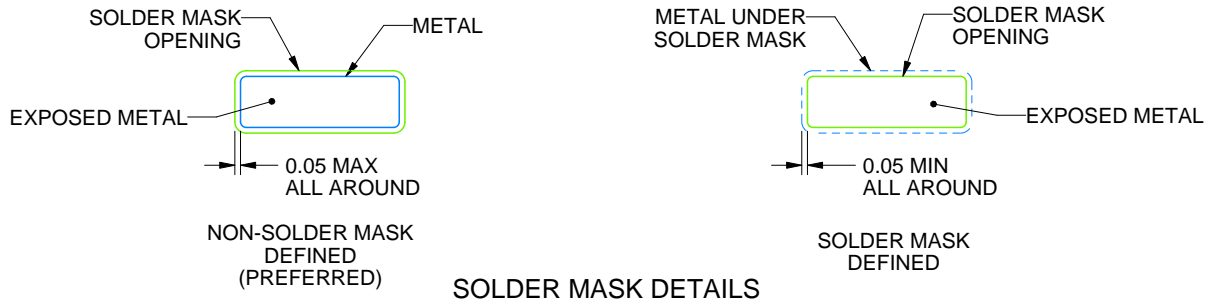

SOLDER MASK DETAILS

4214862/A 04/2023

NOTES: (continued)

6. Publication IPC-7351 may have alternate designs.
7. Solder mask tolerances between and around signal pads can vary based on board fabrication site.
8. Vias are optional depending on application, refer to device data sheet. If any vias are implemented, refer to their locations shown on this view. It is recommended that vias under paste be filled, plugged or tented.
9. Size of metal pad may vary due to creepage requirement.

EXAMPLE STENCIL DESIGN

DGK0008A

TM VSSOP - 1.1 mm max height

SMALL OUTLINE PACKAGE

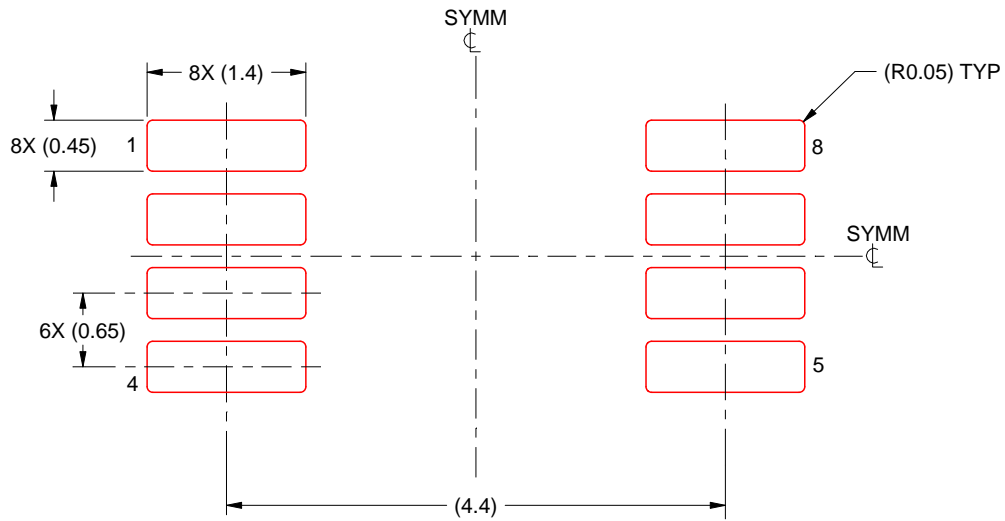

SOLDER PASTE EXAMPLE
SCALE: 15X

4214862/A 04/2023

NOTES: (continued)

11. Laser cutting apertures with trapezoidal walls and rounded corners may offer better paste release. IPC-7525 may have alternate design recommendations.
12. Board assembly site may have different recommendations for stencil design.

EXAMPLE BOARD LAYOUT

DDF0008A

SOT-23-THIN - 1.1 mm max height

PLASTIC SMALL OUTLINE

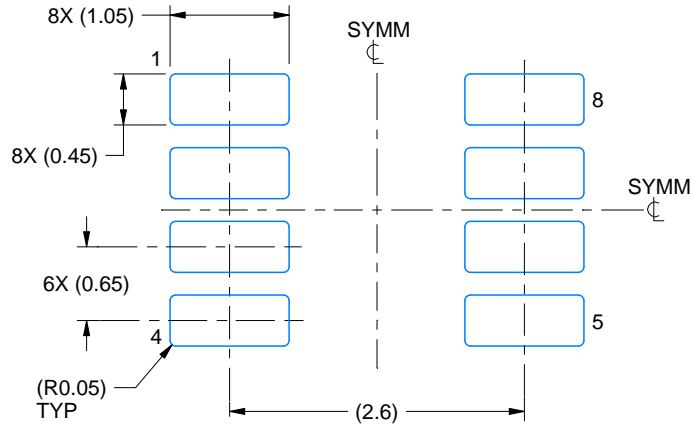

LAND PATTERN EXAMPLE
EXPOSED METAL SHOWN
SCALE:15X

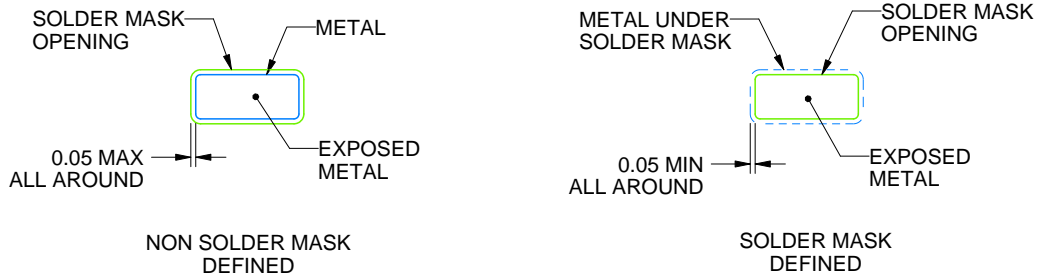

SOLDER MASK DETAILS

4222047/E 07/2024

NOTES: (continued)

- 4. Publication IPC-7351 may have alternate designs.
- 5. Solder mask tolerances between and around signal pads can vary based on board fabrication site.

EXAMPLE STENCIL DESIGN

DDF0008A

SOT-23-THIN - 1.1 mm max height

PLASTIC SMALL OUTLINE

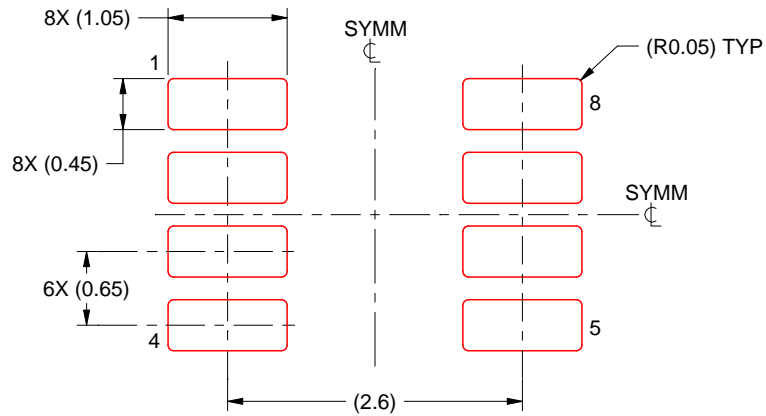

SOLDER PASTE EXAMPLE
BASED ON 0.125 mm THICK STENCIL
SCALE:15X

4222047/E 07/2024

NOTES: (continued)

6. Laser cutting apertures with trapezoidal walls and rounded corners may offer better paste release. IPC-7525 may have alternate design recommendations.
7. Board assembly site may have different recommendations for stencil design.

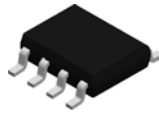

D0008A

PACKAGE OUTLINE

SOIC - 1.75 mm max height

SMALL OUTLINE INTEGRATED CIRCUIT

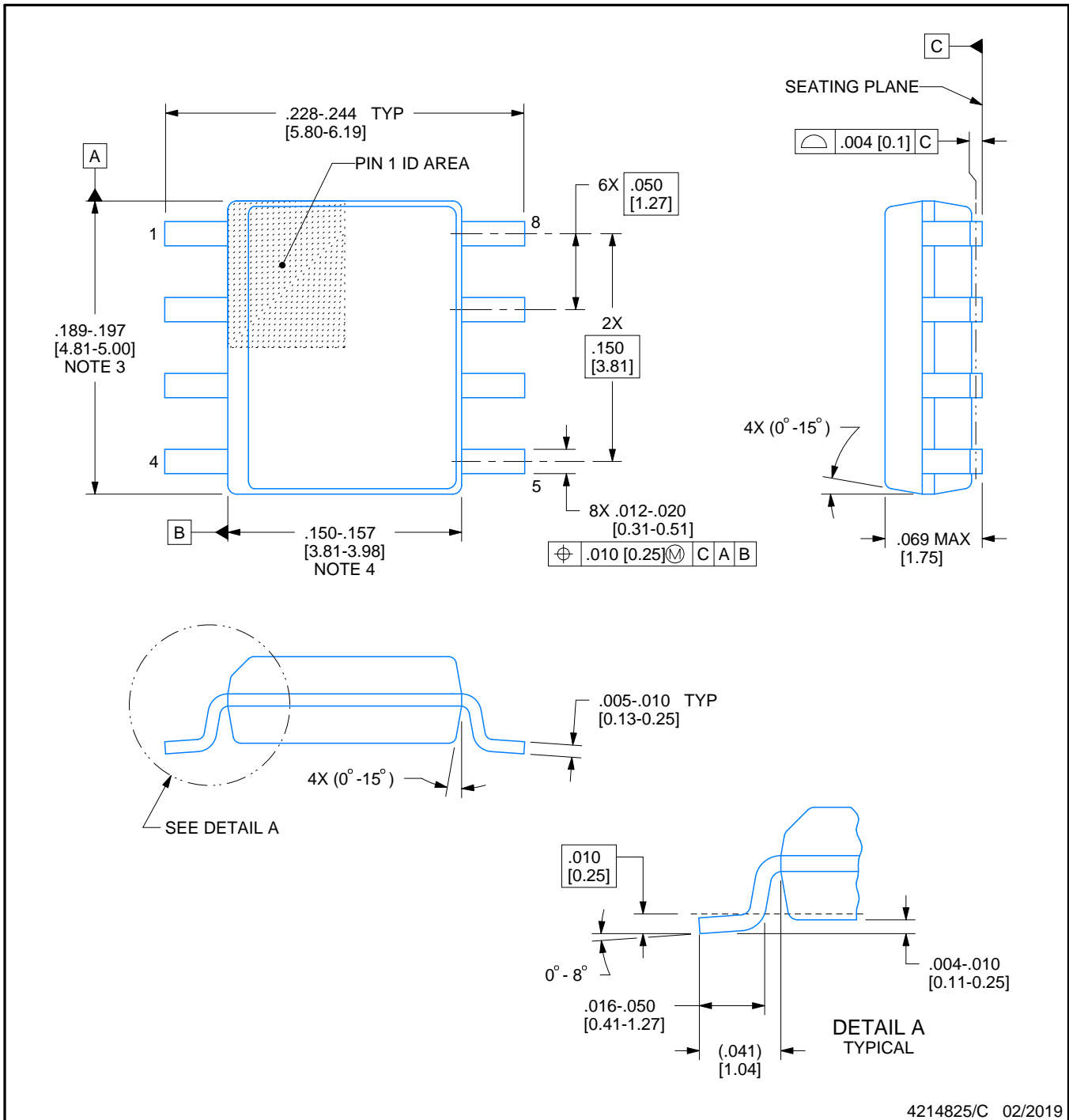

4214825/C 02/2019

NOTES:

- Linear dimensions are in inches [millimeters]. Dimensions in parenthesis are for reference only. Controlling dimensions are in inches. Dimensioning and tolerancing per ASME Y14.5M.
- This drawing is subject to change without notice.
- This dimension does not include mold flash, protrusions, or gate burrs. Mold flash, protrusions, or gate burrs shall not exceed $.006$ [0.15] per side.
- This dimension does not include interlead flash.
- Reference JEDEC registration MS-012, variation AA.

EXAMPLE BOARD LAYOUT

D0008A

SOIC - 1.75 mm max height

SMALL OUTLINE INTEGRATED CIRCUIT

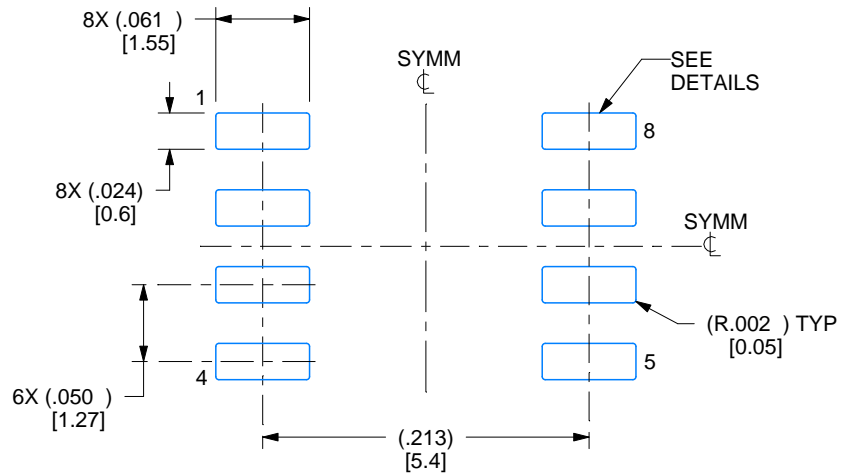

LAND PATTERN EXAMPLE
EXPOSED METAL SHOWN
SCALE:8X

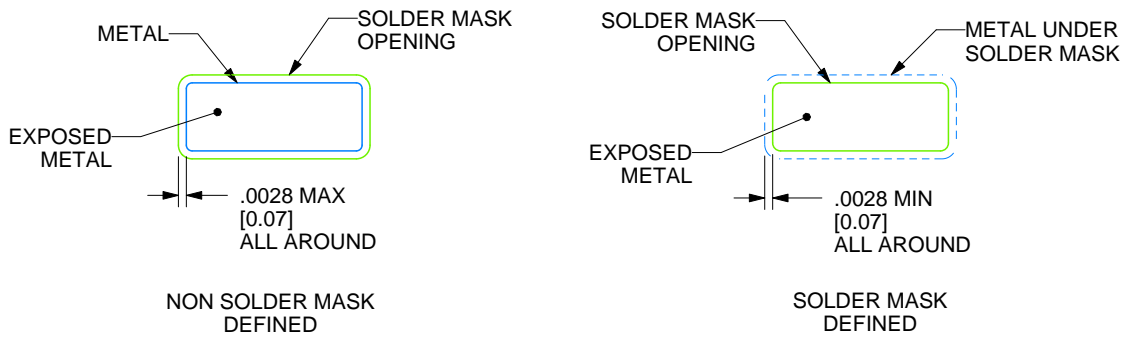

SOLDER MASK DETAILS

4214825/C 02/2019

NOTES: (continued)

- 6. Publication IPC-7351 may have alternate designs.
- 7. Solder mask tolerances between and around signal pads can vary based on board fabrication site.

EXAMPLE STENCIL DESIGN

D0008A

SOIC - 1.75 mm max height

SMALL OUTLINE INTEGRATED CIRCUIT

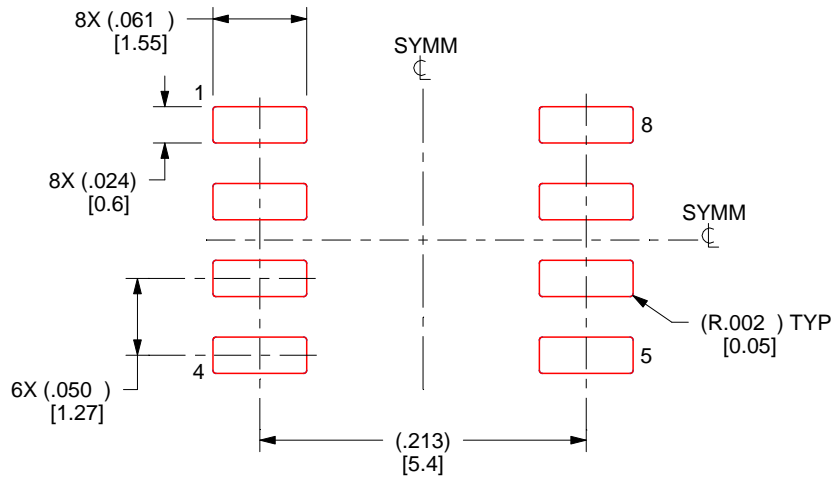

SOLDER PASTE EXAMPLE
BASED ON .005 INCH [0.125 MM] THICK STENCIL
SCALE:8X

4214825/C 02/2019

NOTES: (continued)

8. Laser cutting apertures with trapezoidal walls and rounded corners may offer better paste release. IPC-7525 may have alternate design recommendations.
9. Board assembly site may have different recommendations for stencil design.

GENERIC PACKAGE VIEW

DSG 8

WSON - 0.8 mm max height

2 x 2, 0.5 mm pitch

PLASTIC SMALL OUTLINE - NO LEAD

This image is a representation of the package family, actual package may vary.
Refer to the product data sheet for package details.

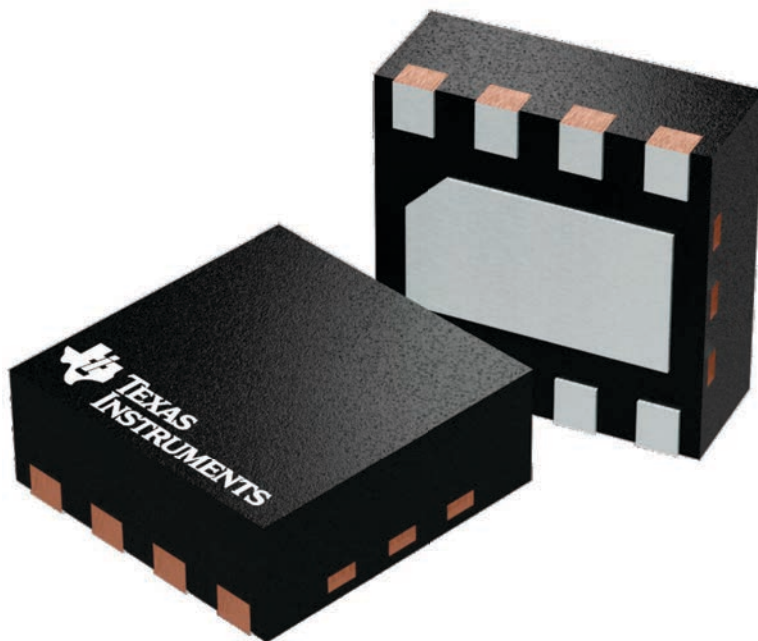

4224783/A

DSG0008B

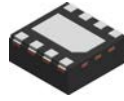

PACKAGE OUTLINE

WSON - 0.8 mm max height

PLASTIC SMALL OUTLINE - NO LEAD

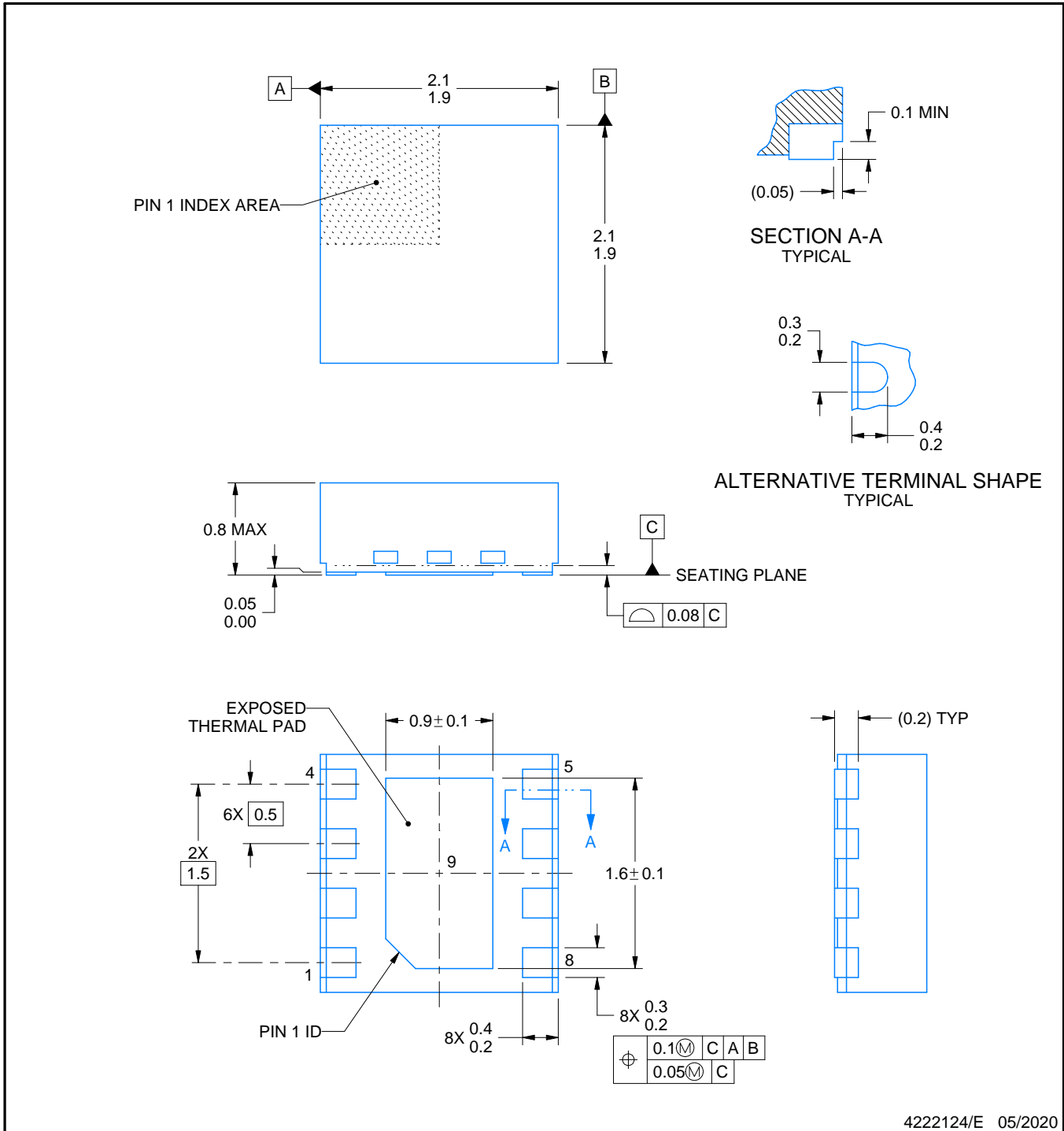

4222124/E 05/2020

NOTES:

1. All linear dimensions are in millimeters. Any dimensions in parenthesis are for reference only. Dimensioning and tolerancing per ASME Y14.5M.
2. This drawing is subject to change without notice.
3. The package thermal pad must be soldered to the printed circuit board for thermal and mechanical performance.

EXAMPLE STENCIL DESIGN

DSG0008B

WSON - 0.8 mm max height

PLASTIC SMALL OUTLINE - NO LEAD

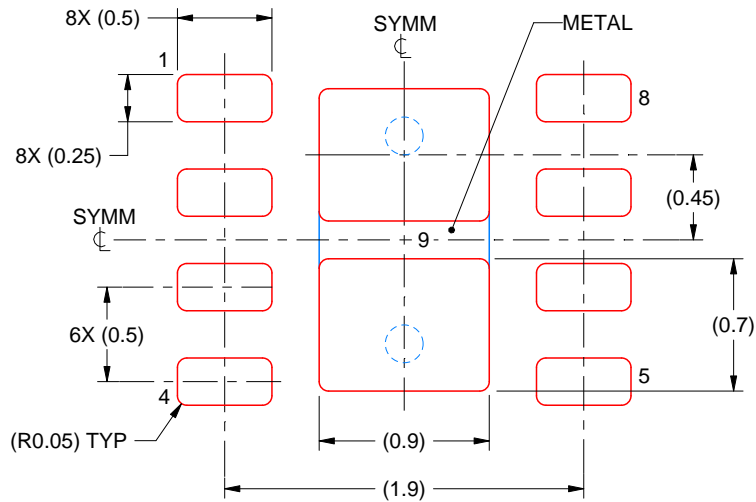

SOLDER PASTE EXAMPLE
BASED ON 0.125 mm THICK STENCIL

EXPOSED PAD 9:
87% PRINTED SOLDER COVERAGE BY AREA UNDER PACKAGE
SCALE:25X

4222124/E 05/2020

NOTES: (continued)

6. Laser cutting apertures with trapezoidal walls and rounded corners may offer better paste release. IPC-7525 may have alternate design recommendations.

PW0008A



PACKAGE OUTLINE
TSSOP - 1.2 mm max height

SMALL OUTLINE PACKAGE

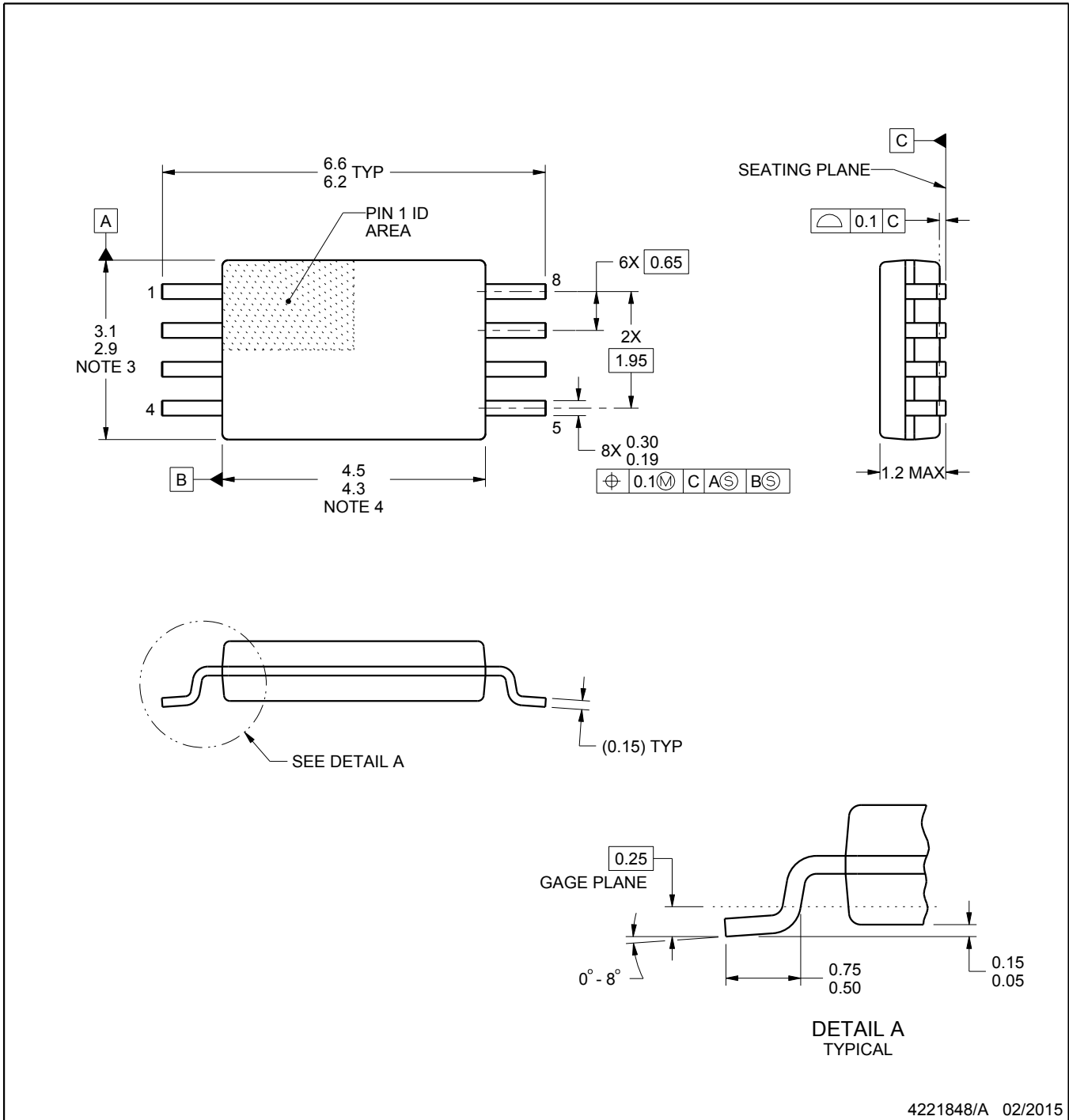

4221848/A 02/2015

NOTES:

1. All linear dimensions are in millimeters. Any dimensions in parenthesis are for reference only. Dimensioning and tolerancing per ASME Y14.5M.
2. This drawing is subject to change without notice.
3. This dimension does not include mold flash, protrusions, or gate burrs. Mold flash, protrusions, or gate burrs shall not exceed 0.15 mm per side.
4. This dimension does not include interlead flash. Interlead flash shall not exceed 0.25 mm per side.
5. Reference JEDEC registration MO-153, variation AA.

EXAMPLE BOARD LAYOUT

PW0008A

TSSOP - 1.2 mm max height

SMALL OUTLINE PACKAGE

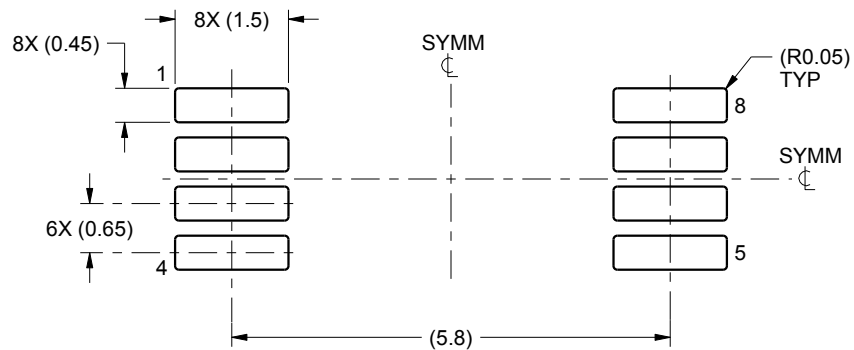

LAND PATTERN EXAMPLE
SCALE:10X

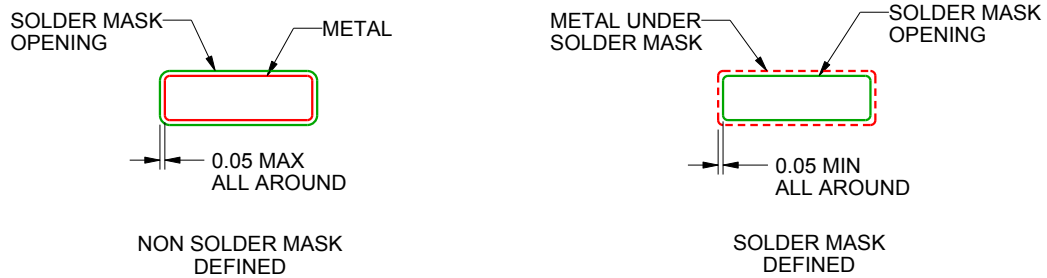

SOLDER MASK DETAILS
NOT TO SCALE

4221848/A 02/2015

NOTES: (continued)

- 6. Publication IPC-7351 may have alternate designs.
- 7. Solder mask tolerances between and around signal pads can vary based on board fabrication site.

EXAMPLE STENCIL DESIGN

PW0008A

TSSOP - 1.2 mm max height

SMALL OUTLINE PACKAGE

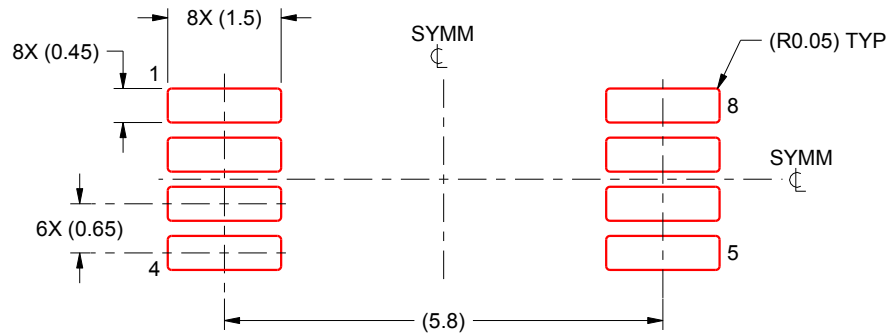

SOLDER PASTE EXAMPLE
BASED ON 0.125 mm THICK STENCIL
SCALE:10X

4221848/A 02/2015

NOTES: (continued)

8. Laser cutting apertures with trapezoidal walls and rounded corners may offer better paste release. IPC-7525 may have alternate design recommendations.
9. Board assembly site may have different recommendations for stencil design.

IMPORTANT NOTICE AND DISCLAIMER

TI PROVIDES TECHNICAL AND RELIABILITY DATA (INCLUDING DATASHEETS), DESIGN RESOURCES (INCLUDING REFERENCE DESIGNS), APPLICATION OR OTHER DESIGN ADVICE, WEB TOOLS, SAFETY INFORMATION, AND OTHER RESOURCES "AS IS" AND WITH ALL FAULTS, AND DISCLAIMS ALL WARRANTIES, EXPRESS AND IMPLIED, INCLUDING WITHOUT LIMITATION ANY IMPLIED WARRANTIES OF MERCHANTABILITY, FITNESS FOR A PARTICULAR PURPOSE OR NON-INFRINGEMENT OF THIRD PARTY INTELLECTUAL PROPERTY RIGHTS.

These resources are intended for skilled developers designing with TI products. You are solely responsible for (1) selecting the appropriate TI products for your application, (2) designing, validating and testing your application, and (3) ensuring your application meets applicable standards, and any other safety, security, regulatory or other requirements.

These resources are subject to change without notice. TI grants you permission to use these resources only for development of an application that uses the TI products described in the resource. Other reproduction and display of these resources is prohibited. No license is granted to any other TI intellectual property right or to any third party intellectual property right. TI disclaims responsibility for, and you fully indemnify TI and its representatives against any claims, damages, costs, losses, and liabilities arising out of your use of these resources.

TI's products are provided subject to [TI's Terms of Sale](#), [TI's General Quality Guidelines](#), or other applicable terms available either on ti.com or provided in conjunction with such TI products. TI's provision of these resources does not expand or otherwise alter TI's applicable warranties or warranty disclaimers for TI products. Unless TI explicitly designates a product as custom or customer-specified, TI products are standard, catalog, general purpose devices.

TI objects to and rejects any additional or different terms you may propose.

Copyright © 2026, Texas Instruments Incorporated

Last updated 10/2025