

INAx290 2.7-V to 120-V, 1.1-MHz, Ultra-Precise, Current-Sense Amplifier

1 Features

- Wide common-mode voltage:
 - Operational voltage: 2.7 V to 120 V
 - Survival voltage: –20 V to +122 V
- Excellent CMRR:
 - 160-dB DC
 - 85-dB AC at 50 kHz
- Accuracy
 - Gain:
 - Gain error: $\pm 0.1\%$ (maximum)
 - Gain drift: ± 5 ppm/ $^{\circ}\text{C}$ (maximum)
 - Offset:
 - Offset voltage: ± 12 μV (maximum)
 - Offset drift: ± 0.2 $\mu\text{V}/^{\circ}\text{C}$ (maximum)
- Available gains:
 - A1 devices: 20 V/V
 - A2 devices: 50 V/V
 - A3 devices: 100 V/V
 - A4 devices: 200 V/V
 - A5 devices: 500 V/V
- High bandwidth: 1.1 MHz
- Slew rate: 2 V/ μs
- Quiescent current: 370 μA (per channel)

2 Applications

- Active antenna system mMIMO (AAS)
- Macro remote radio unit (RRU)
- 48-V rack server
- 48-V merchant network & server power supply
- Test and measurement

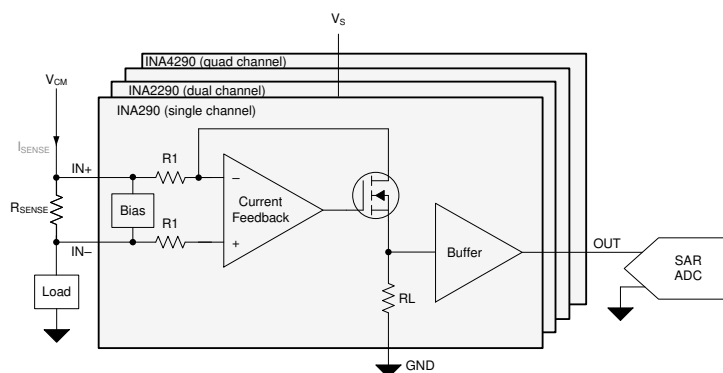

Typical Application

3 Description

The INAx290 is an ultra-precise, current-sense amplifier that can measure voltage drops across shunt resistors over a wide common-mode range from 2.7 V to 120 V. The ultra-precise current measurement accuracy is achieved thanks to the combination of an ultra-low offset voltage of ± 12 μV (maximum), a small gain error of $\pm 0.1\%$ (maximum), and a high DC CMRR of 160 dB (typical). The INAx290 is not only designed for DC current measurement, but also for high-speed applications (such as fast overcurrent protection, for example) with a high bandwidth of 1.1 MHz (at gain of 20 V/V) and an 85-dB AC CMRR (at 50 kHz).

The INAx290 provides the capability to make ultra-precise current measurements by sensing the voltage drop across a shunt resistor over a wide common-mode range from 2.7 V to 120 V. The INAx290 devices come in highly space-efficient packages. The single-channel INA290 device is featured in the SC-70 package, the dual-channel INA2290 device is available in the MSOP-8 package, and the quad-channel INA4290 device is available in the 4 mm x 4 mm QFN package.

The INAx290 operates from a single 2.7-V to 20-V supply with the single channel device only drawing 370- μA supply current per channel (typical). The devices are available with five gain options: 20 V/V, 50 V/V, 100 V/V, 200 V/V, and 500 V/V. The low offset of the zero-drift architecture enables current sensing with low ohmic shunts as specified over the extended operating temperature range (-40°C to $+125^{\circ}\text{C}$).

Device Information⁽¹⁾

PART NUMBER	PACKAGE	BODY SIZE (NOM)
INA290	SC-70 (5)	2.00 mm × 1.25 mm
INA2290	VSSOP (8)	3.00 mm × 3.00 mm
INA4290	QFN (16)	4.00 mm × 4.00 mm

- (1) For all available packages, see the package option addendum at the end of the data sheet.



Table of Contents

1 Features	1	8 Application and Implementation	19
2 Applications	1	8.1 Application Information.....	19
3 Description	1	8.2 Typical Application.....	21
4 Revision History	2	9 Power Supply Recommendations	23
5 Pin Configuration and Functions	3	10 Layout	23
6 Specifications	5	10.1 Layout Guidelines.....	23
6.1 Absolute Maximum Ratings	5	10.2 Layout Examples.....	23
6.2 ESD Ratings	5	11 Device and Documentation Support	26
6.3 Recommended Operating Conditions	5	11.1 Documentation Support.....	26
6.4 Thermal Information	5	11.2 Receiving Notification of Documentation Updates..	26
6.5 Electrical Characteristics.....	6	11.3 Support Resources.....	26
6.6 Typical Characteristics.....	7	11.4 Trademarks.....	26
7 Detailed Description	15	11.5 Electrostatic Discharge Caution.....	26
7.1 Overview.....	15	11.6 Glossary.....	26
7.2 Functional Block Diagram.....	15	12 Mechanical, Packaging, and Orderable	
7.3 Feature Description.....	16	Information	26
7.4 Device Functional Modes.....	18		

4 Revision History

NOTE: Page numbers for previous revisions may differ from page numbers in the current version.

Changes from Revision B (December 2020) to Revision C (June 2021)	Page
• Added INA4290 device information.....	1

Changes from Revision A (September 2020) to Revision B (December 2020)	Page
• Changed the INA2290 device status from Advanced Information to Production Data.....	1
• Added Channel Separation vs. Frequency, Multichannel Devices	7

Changes from Revision * (June 2020) to Revision A (August 2020)	Page
• Changed the data sheet status from Production Data to Production Mixed.....	1
• Added INA2290 advanced information to the document.....	1

5 Pin Configuration and Functions

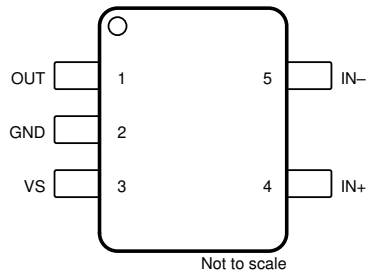

Figure 5-1. INA290: DCK Package 5-Pin SC-70 Top View

Table 5-1. Pin Functions: INA290 (Single Channel)

PIN		TYPE	DESCRIPTION
NAME	NO.		
GND	2	Ground	Ground
IN–	5	Input	Connect to load side of shunt resistor.
IN+	4	Input	Connect to supply side of shunt resistor.
OUT	1	Output	Output voltage
VS	3	Power	Power supply

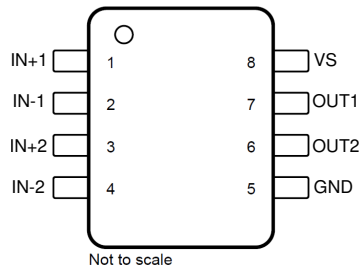
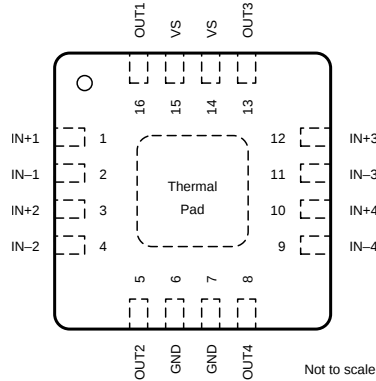

Figure 5-2. INA2290: DGK Package 8-Pin VSSOP Top View

Table 5-2. Pin Functions: INA2290 (Dual Channel)

PIN		TYPE	DESCRIPTION
NAME	NO.		
GND	5	Ground	Ground
IN–1	2	Input	Current-sense amplifier negative input for channel 1. Connect to load side of channel 1 sense resistor.
IN+1	1	Input	Current-sense amplifier positive input for channel 1. Connect to bus-voltage side of channel 1 sense resistor.
IN–2	4	Input	Current-sense amplifier negative input for channel 2. Connect to load side of channel 2 sense resistor.
IN+2	3	Input	Current-sense amplifier positive input for channel 2. Connect to bus-voltage side of channel 2 sense resistor.
OUT1	7	Output	Channel 1 output voltage
OUT2	6	Output	Channel 2 output voltage
VS	8	Power	Power supply



A. Thermal Pad can be left floating or connected to GND.

Figure 5-3. INA4290: RGV Package 16-Pin QFN Top View

Table 5-3. Pin Functions: INA4290 (Quad Channel)

PIN		TYPE	DESCRIPTION
NAME	NO.		
GND	6, 7	Ground	Ground
IN-1	2	Input	Current-sense amplifier negative input for channel 1. Connect to load side of channel-1 sense resistor.
IN+1	1	Input	Current-sense amplifier positive input for channel 1. Connect to bus-voltage side of channel-1 sense resistor.
IN-2	4	Input	Current-sense amplifier negative input for channel 2. Connect to load side of channel-2 sense resistor.
IN+2	3	Input	Current-sense amplifier positive input for channel 2. Connect to bus-voltage side of channel-2 sense resistor.
IN-3	11	Input	Current-sense amplifier negative input for channel 3. Connect to load side of channel-3 sense resistor.
IN+3	12	Input	Current-sense amplifier positive input for channel 3. Connect to bus-voltage side of channel-3 sense resistor.
IN-4	9	Input	Current-sense amplifier negative input for channel 4. Connect to load side of channel-4 sense resistor.
IN+4	10	Input	Current-sense amplifier positive input for channel 4. Connect to bus-voltage side of channel-4 sense resistor.
OUT1	16	Output	Channel 1 output voltage
OUT2	5	Output	Channel 2 output voltage
OUT3	13	Output	Channel 3 output voltage
OUT4	8	Output	Channel 4 output voltage
VS	14, 15	Power	Power supply

6 Specifications

6.1 Absolute Maximum Ratings

over operating free-air temperature range (unless otherwise noted)⁽¹⁾

		MIN	MAX	UNIT
V _S	Supply voltage	-0.3	22	V
V _{IN+} , V _{IN-} ⁽²⁾	Analog inputs, differential (V _{IN+}) – (V _{IN-})	-30	30	V
	Analog inputs, common mode (V _{IN+} or V _{IN-})	-20	122	
V _{OUTx}	Analog outputs, output voltage	GND – 0.3	V _S + 0.3	V
T _A	Operating temperature	-55	150	°C
T _J	Junction temperature		150	°C
T _{stg}	Storage temperature	-65	150	°C

- (1) Stresses beyond those listed under Absolute Maximum Ratings may cause permanent damage to the device. These are stress ratings only, which do not imply functional operation of the device at these or any other conditions beyond those indicated under Recommended Operating Conditions. Exposure to absolute-maximum-rated conditions for extended periods may affect device reliability.
- (2) V_{IN+} and V_{IN-} are the voltages at the V_{IN+} and V_{IN-} pins, respectively.

6.2 ESD Ratings

			VALUE	UNIT
V _(ESD)	Electrostatic discharge	Human body model (HBM), per ANSI/ESDA/JEDEC JS-001, all pins ⁽¹⁾	±2000	V
		Charged device model (CDM), per JEDEC specification JESD22-C101, all pins ⁽²⁾	±1000	V

- (1) JEDEC document JEP155 states that 500-V HBM allows safe manufacturing with a standard ESD control process.
- (2) JEDEC document JEP157 states that 250-V CDM allows safe manufacturing with a standard ESD control process.

6.3 Recommended Operating Conditions

over operating free-air temperature range (unless otherwise noted)

		MIN	NOM	MAX	UNIT
V _{CM}	Common-mode input range ⁽¹⁾	V _S	48	120	V
V _S	Operating supply range	2.7	5	20	V
T _A	Ambient temperature	-40		125	°C

- (1) Common-mode voltage can go below V_S under certain conditions. See [Figure 7-1](#) for additional information on operating range.

6.4 Thermal Information

THERMAL METRIC ⁽¹⁾		INA4290	INA2290	INA290	UNIT
		RGV (QFN)	DGK (VSSOP)	DCK (SC-70)	
		16 PINS	8 PINS	5 PINS	
R _{θJA}	Junction-to-ambient thermal resistance	45.9	169.3	191.6	°C/W
R _{θJC(top)}	Junction-to-case (top) thermal resistance	41.6	60.1	144.4	°C/W
R _{θJB}	Junction-to-board thermal resistance	21.0	91.3	69.2	°C/W
Ψ _{JT}	Junction-to-top characterization parameter	1.0	8.3	46.2	°C/W
Ψ _{JB}	Junction-to-board characterization parameter	21.0	89.7	69.0	°C/W
R _{θJC(bot)}	Junction-to-case (bottom) thermal resistance	6.4	N/A	N/A	°C/W

- (1) For more information about traditional and new thermal metrics, see the [Semiconductor and IC Package Thermal Metrics](#) application report.

6.5 Electrical Characteristics

at $T_A = 25\text{ }^\circ\text{C}$, $V_S = 5\text{ V}$, $V_{\text{SENSE}} = V_{\text{IN}+} - V_{\text{IN}-} = 0.5\text{ V / Gain}$, $V_{\text{CM}} = V_{\text{IN}-} = 48\text{ V}$ (unless otherwise noted)

PARAMETER		TEST CONDITIONS	MIN	TYP	MAX	UNIT
INPUT						
CMRR	Common-mode rejection ratio	$V_{\text{CM}} = 2.7\text{ V to }120\text{ V}$, $T_A = -40\text{ }^\circ\text{C to }+125\text{ }^\circ\text{C}$ $f = 50\text{ kHz}$	140	160		dB
				85		
V_{os}	Offset voltage, input referred	A1 devices, INA290, INA2290		6	± 25	μV
		A1 devices, INA4290		6	± 32	
		A2 devices		3	± 20	
		A3 devices		3	± 15	
		A4, A5 devices		2	± 12	
dV_{os}/dT	Offset voltage drift	$T_A = -40\text{ }^\circ\text{C to }+125\text{ }^\circ\text{C}$			0.2	$\mu\text{V}/^\circ\text{C}$
PSRR	Power supply rejection ratio, input referred	$V_S = 2.7\text{ V to }20\text{ V}$, $T_A = -40\text{ }^\circ\text{C to }+125\text{ }^\circ\text{C}$		0.05	± 0.5	$\mu\text{V/V}$
I_B	Input bias current	I_{B+} , $V_{\text{SENSE}} = 0\text{ mV}$	10	20	30	μA
		I_{B-} , $V_{\text{SENSE}} = 0\text{ mV}$	10	20	30	
OUTPUT						
G	Gain	A1 devices		20		V/V
		A2 devices		50		
		A3 devices		100		
		A4 devices		200		
		A5 devices		500		
	Gain error	A1, A2, A3 devices, $\text{GND} + 50\text{ mV} \leq V_{\text{OUT}} \leq V_S - 200\text{ mV}$		0.02	± 0.1	%
		A4, A5 devices, $\text{GND} + 50\text{ mV} \leq V_{\text{OUT}} \leq V_S - 200\text{ mV}$		0.02	± 0.15	
	Gain error drift	$T_A = -40\text{ }^\circ\text{C to }+125\text{ }^\circ\text{C}$		1.5	5	ppm/ $^\circ\text{C}$
	Nonlinearity error			0.01		%
	Maximum capacitive load	No sustained oscillations, no isolation resistor		500		pF
VOLTAGE OUTPUT						
	Swing to V_S power supply rail	$R_{\text{LOAD}} = 10\text{ k}\Omega$, $T_A = -40\text{ }^\circ\text{C to }+125\text{ }^\circ\text{C}$		$V_S - 0.07$	$V_S - 0.2$	V
	Swing to ground	$R_{\text{LOAD}} = 10\text{ k}\Omega$, $V_{\text{SENSE}} = 0\text{ V}$, $T_A = -40\text{ }^\circ\text{C to }+125\text{ }^\circ\text{C}$		0.005	0.025	V
FREQUENCY RESPONSE						
BW	Bandwidth	A1 devices, $C_{\text{LOAD}} = 5\text{ pF}$, $V_{\text{SENSE}} = 200\text{ mV}$		1100		kHz
		A2 devices, $C_{\text{LOAD}} = 5\text{ pF}$, $V_{\text{SENSE}} = 80\text{ mV}$		1100		
		A3 devices, $C_{\text{LOAD}} = 5\text{ pF}$, $V_{\text{SENSE}} = 40\text{ mV}$		900		
		A4 devices, $C_{\text{LOAD}} = 5\text{ pF}$, $V_{\text{SENSE}} = 20\text{ mV}$		850		
		A5 devices, $C_{\text{LOAD}} = 5\text{ pF}$, $V_{\text{SENSE}} = 8\text{ mV}$		800		
SR	Slew rate			2		V/ μs
	Settling time	$V_{\text{OUT}} = 4\text{ V} \pm 0.1\text{ V}$ step, output settles to 0.5%		9		μs
		$V_{\text{OUT}} = 4\text{ V} \pm 0.1\text{ V}$ step, output settles to 1%		5		
NOISE						
V_{en}	Voltage noise density			50		nV/ $\sqrt{\text{Hz}}$

at $T_A = 25^\circ\text{C}$, $V_S = 5\text{ V}$, $V_{\text{SENSE}} = V_{\text{IN}+} - V_{\text{IN}-} = 0.5\text{ V / Gain}$, $V_{\text{CM}} = V_{\text{IN}-} = 48\text{ V}$ (unless otherwise noted)

PARAMETER		TEST CONDITIONS	MIN	TYP	MAX	UNIT
POWER SUPPLY						
V_S	Supply voltage	$T_A = -40^\circ\text{C to } +125^\circ\text{C}$	2.7		20	V
I_Q	Quiescent current, INA290	$T_A = -40^\circ\text{C to } +125^\circ\text{C}$		370	500	μA
I_Q	Quiescent current, INA2290	$T_A = -40^\circ\text{C to } +125^\circ\text{C}$		680	900	μA
I_Q	Quiescent current, INA4290	$T_A = -40^\circ\text{C to } +125^\circ\text{C}$		1250	1600	μA
					1800	

6.6 Typical Characteristics

all specifications at $T_A = 25^\circ\text{C}$, $V_S = 5\text{ V}$, $V_{\text{SENSE}} = V_{\text{IN}+} - V_{\text{IN}-} = 0.5\text{ V / Gain}$, and $V_{\text{CM}} = V_{\text{IN}-} = 48\text{ V}$ (unless otherwise noted).

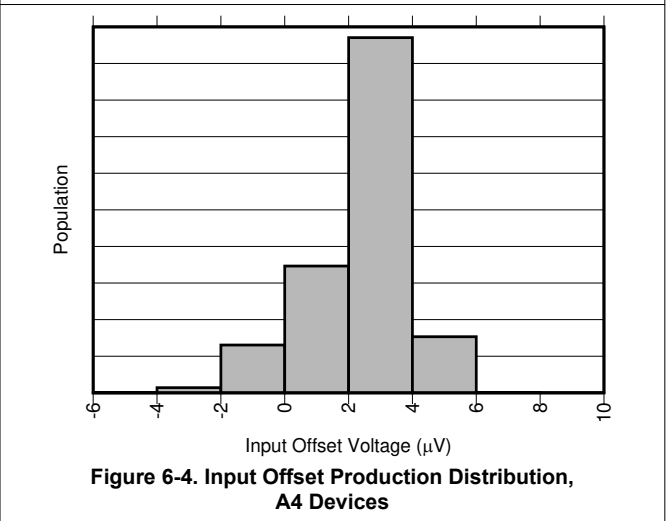
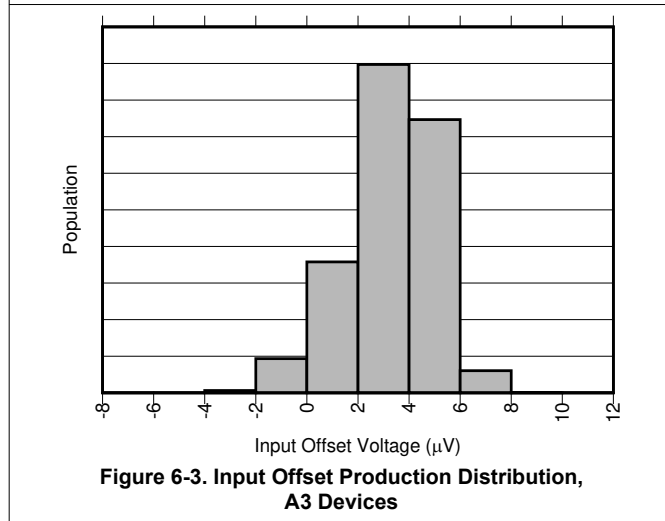
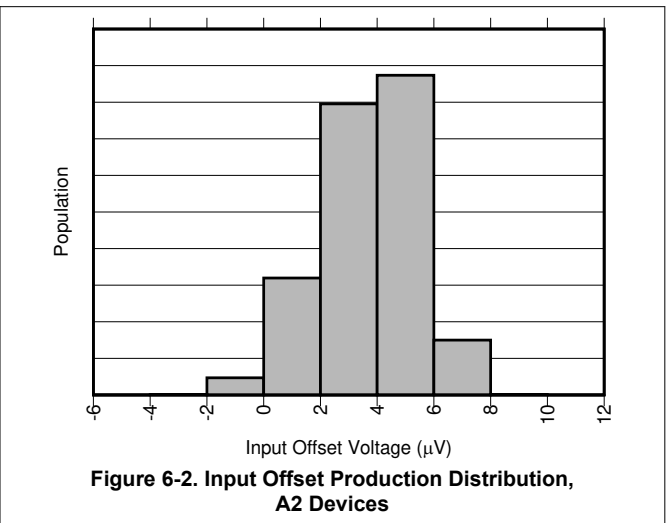
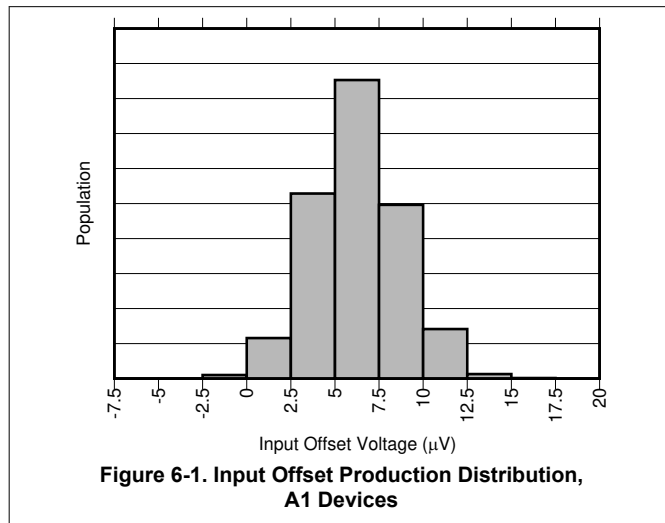

6.6 Typical Characteristics (continued)

al specifications at $T_A = 25^\circ\text{C}$, $V_S = 5\text{ V}$, $V_{\text{SENSE}} = V_{\text{IN}+} - V_{\text{IN}-} = 0.5\text{ V} / \text{Gain}$, and $V_{\text{CM}} = V_{\text{IN}-} = 48\text{ V}$ (unless otherwise noted).

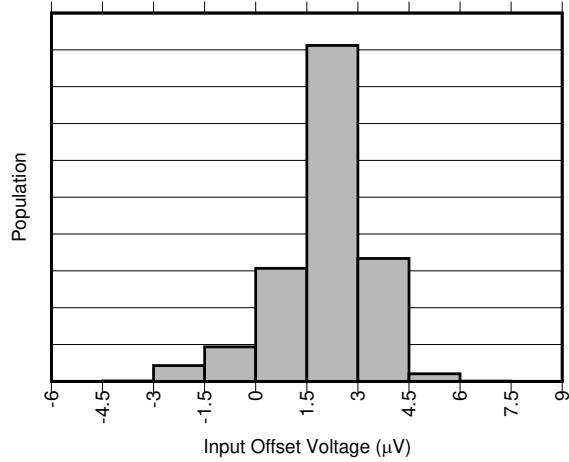

Figure 6-5. Input Offset Production Distribution, A5 Devices

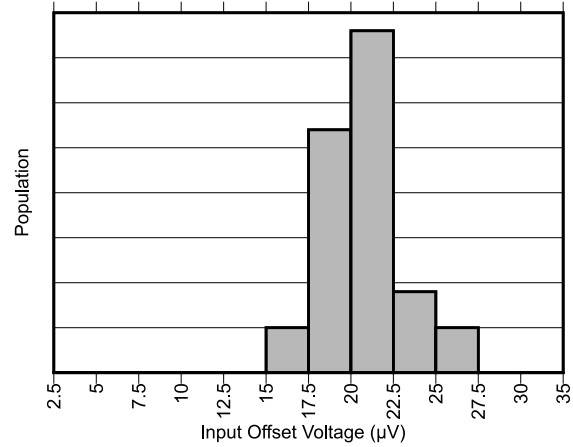

Figure 6-6. Input Offset Production Distribution, A1 Devices (INA4290)

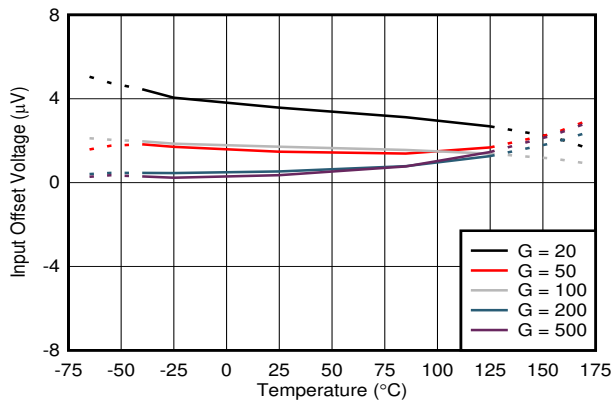

Figure 6-7. Input Offset Voltage vs. Temperature

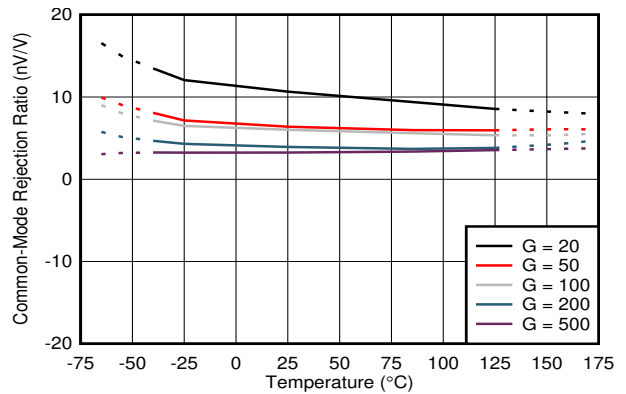

Figure 6-8. Common-Mode Rejection Ratio vs. Temperature

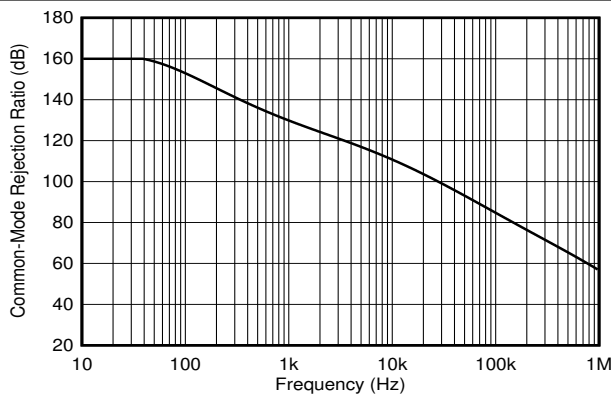
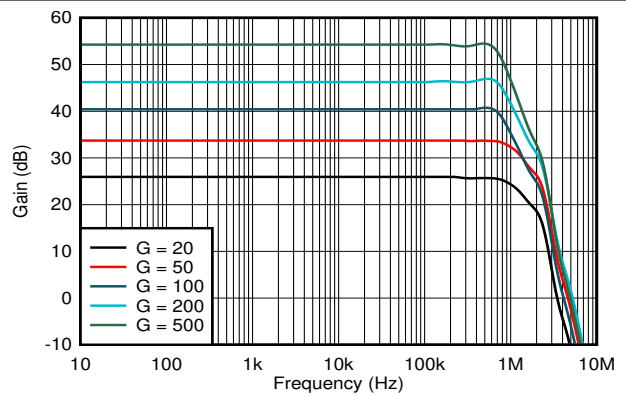

Figure 6-9. Common-Mode Rejection Ratio vs. Frequency



$V_{\text{SENSE}} = 4\text{ V} / \text{Gain}$

Figure 6-10. Gain vs. Frequency

6.6 Typical Characteristics (continued)

all specifications at $T_A = 25^\circ\text{C}$, $V_S = 5\text{ V}$, $V_{\text{SENSE}} = V_{\text{IN}+} - V_{\text{IN}-} = 0.5\text{ V} / \text{Gain}$, and $V_{\text{CM}} = V_{\text{IN}-} = 48\text{ V}$ (unless otherwise noted).

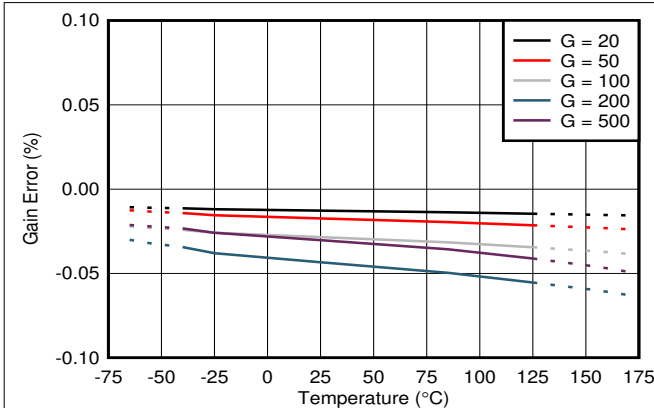

Figure 6-11. Gain Error vs. Temperature

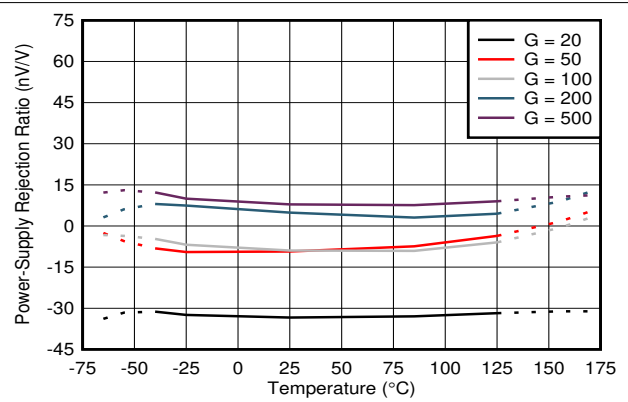

Figure 6-12. Power-Supply Rejection Ratio vs. Temperature

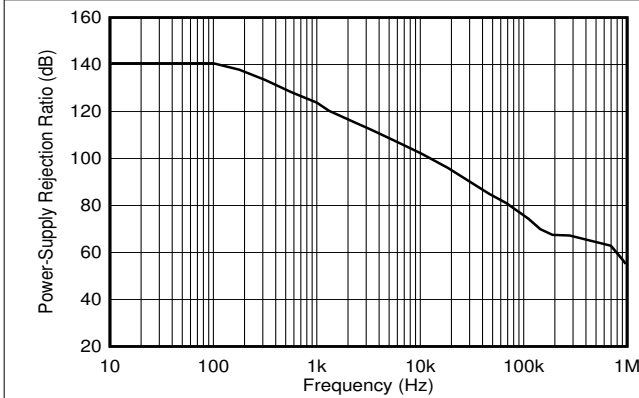

Figure 6-13. Power-Supply Rejection Ratio vs. Frequency

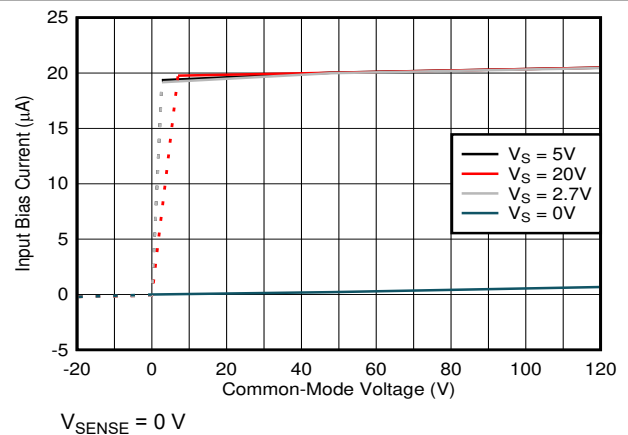

Figure 6-14. Input Bias Current vs. Common-Mode Voltage

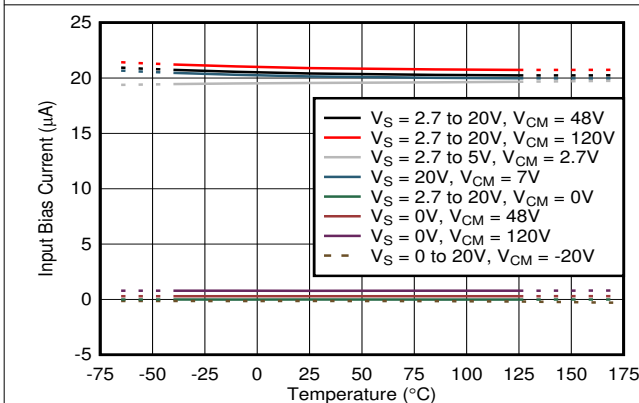

Figure 6-15. Input Bias Current vs. Temperature

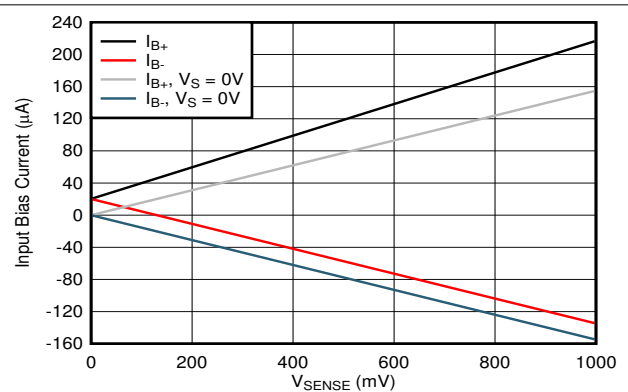

Figure 6-16. Input Bias Current vs. V_{SENSE}
A1 Devices

6.6 Typical Characteristics (continued)

all specifications at $T_A = 25^\circ\text{C}$, $V_S = 5\text{ V}$, $V_{\text{SENSE}} = V_{\text{IN}+} - V_{\text{IN}-} = 0.5\text{ V} / \text{Gain}$, and $V_{\text{CM}} = V_{\text{IN}-} = 48\text{ V}$ (unless otherwise noted).

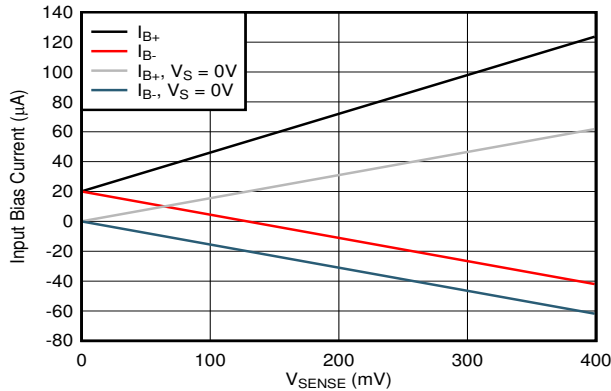

Figure 6-17. Input Bias Current vs. V_{SENSE} , A2 and A3 Devices

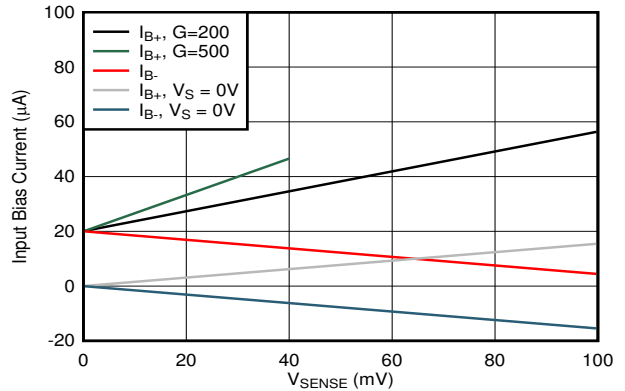
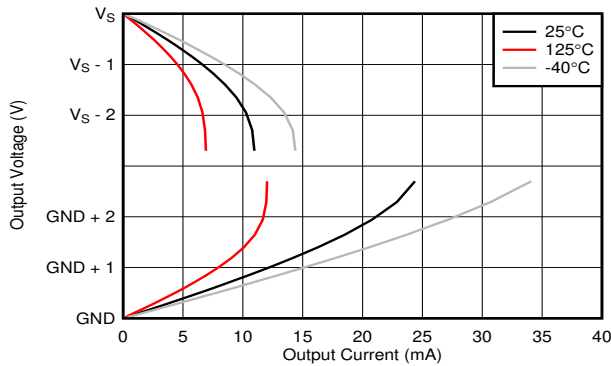
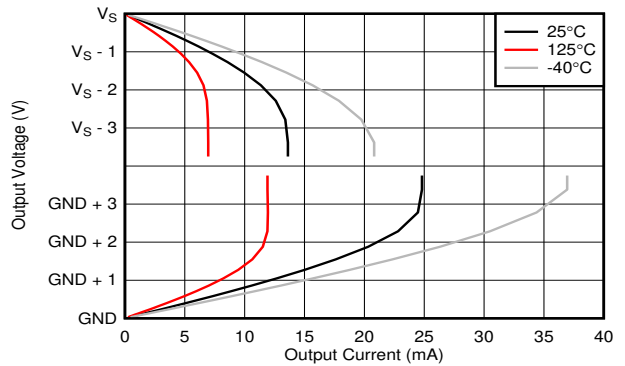

Figure 6-18. Input Bias Current vs. V_{SENSE} , A4 and A5 Devices



$V_S = 2.7\text{ V}$

Figure 6-19. Output Voltage vs. Output Current



$V_S = 5\text{ V}$

Figure 6-20. Output Voltage vs. Output Current

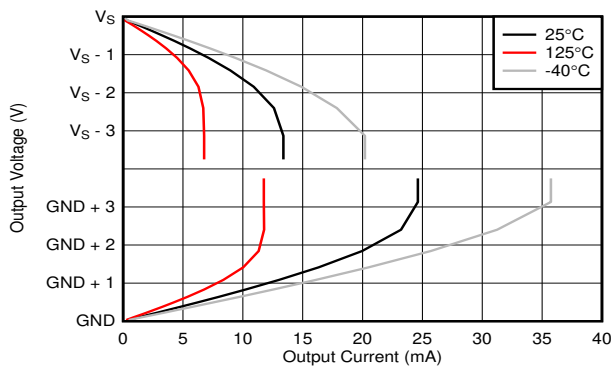

$V_S = 20\text{ V}$

Figure 6-21. Output Voltage vs. Output Current

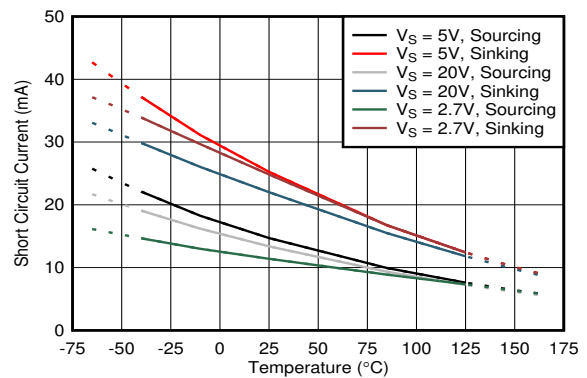

Figure 6-22. Short-Circuit Current vs. Temperature

6.6 Typical Characteristics (continued)

al specifications at $T_A = 25^\circ\text{C}$, $V_S = 5\text{ V}$, $V_{\text{SENSE}} = V_{\text{IN}+} - V_{\text{IN}-} = 0.5\text{ V} / \text{Gain}$, and $V_{\text{CM}} = V_{\text{IN}-} = 48\text{ V}$ (unless otherwise noted).

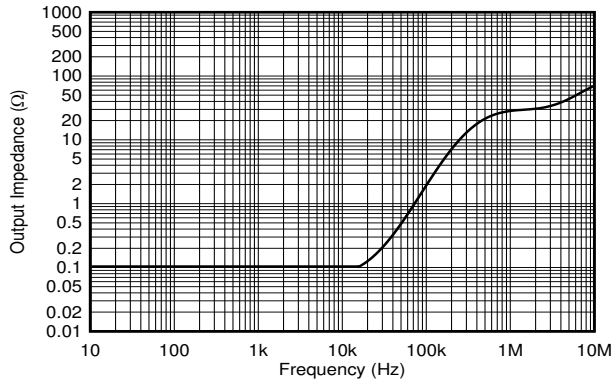
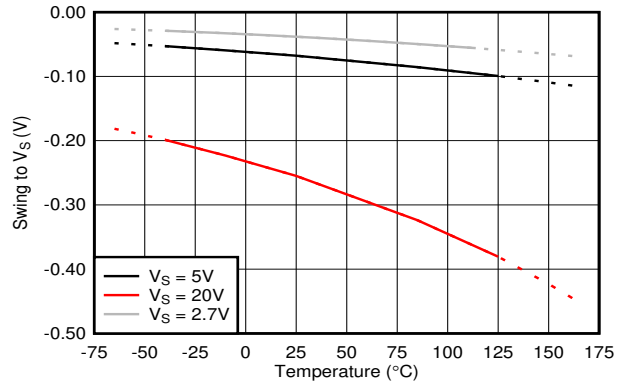
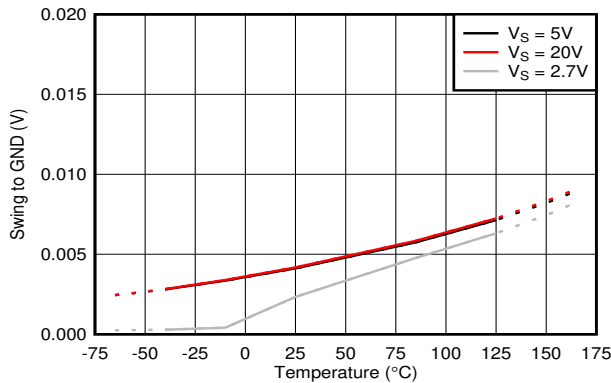

Figure 6-23. Output Impedance vs. Frequency



$R_L = 10\text{ k}\Omega$

Figure 6-24. Swing to Supply vs. Temperature



$R_L = 10\text{ k}\Omega$

Figure 6-25. Swing to GND vs. Temperature

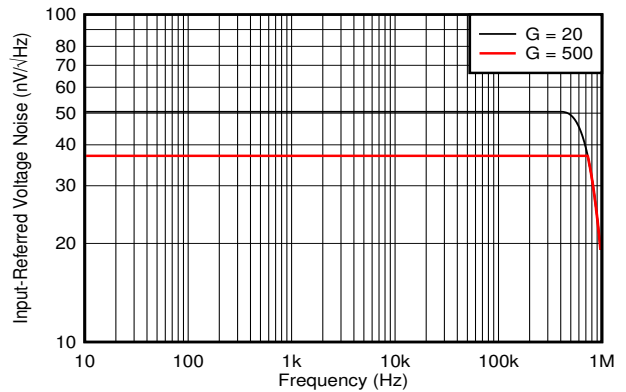

Figure 6-26. Input-Referred Noise vs. Frequency

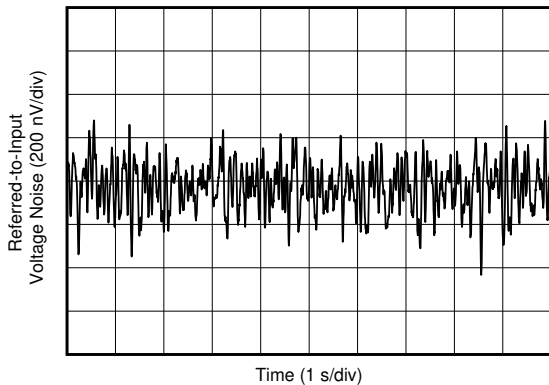

Figure 6-27. Input-Referred Noise

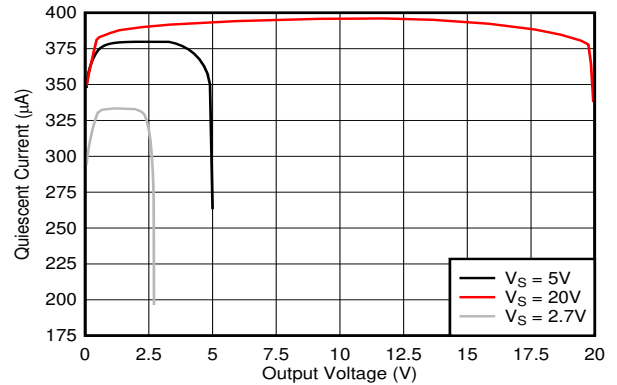

Figure 6-28. Quiescent Current vs. Output Voltage, INA290

6.6 Typical Characteristics (continued)

al specifications at $T_A = 25^\circ\text{C}$, $V_S = 5\text{ V}$, $V_{\text{SENSE}} = V_{\text{IN}+} - V_{\text{IN}-} = 0.5\text{ V} / \text{Gain}$, and $V_{\text{CM}} = V_{\text{IN}-} = 48\text{ V}$ (unless otherwise noted).

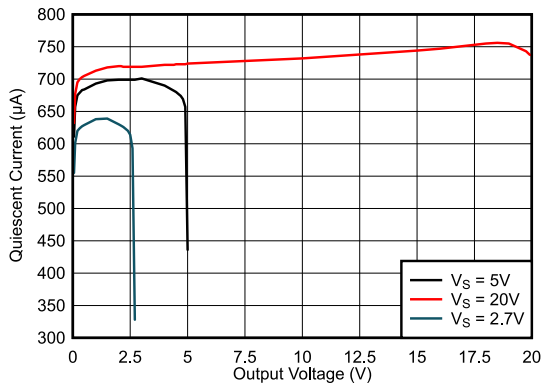

Figure 6-29. Quiescent Current vs. Output Voltage, INA2290

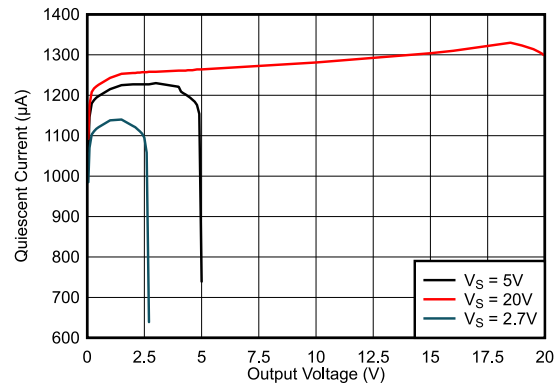

Figure 6-30. Quiescent Current vs. Output Voltage, INA4290

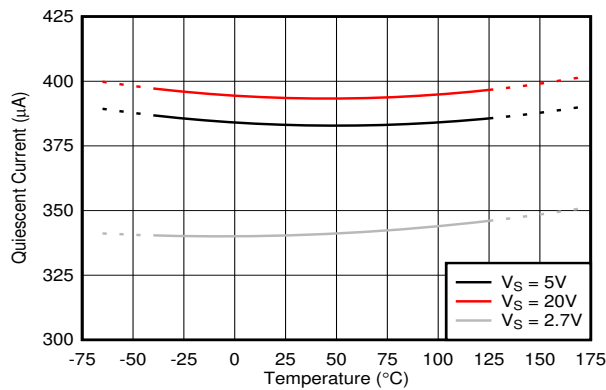

Figure 6-31. Quiescent Current vs. Temperature, INA290

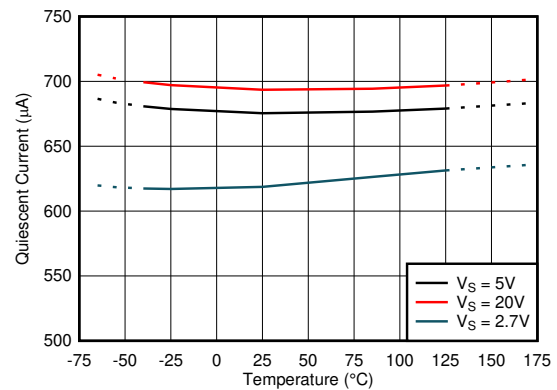

Figure 6-32. Quiescent Current vs. Temperature, INA2290

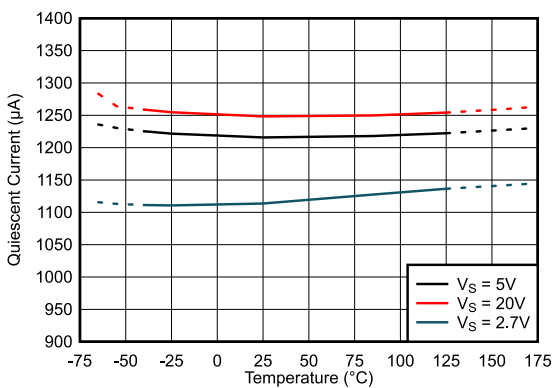

Figure 6-33. Quiescent Current vs. Temperature, INA4290

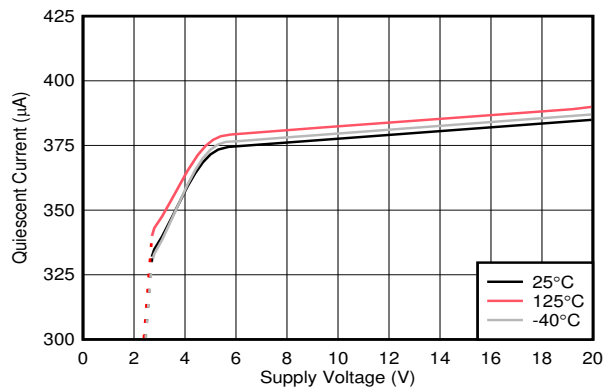

Figure 6-34. Quiescent Current vs. Supply Voltage, INA290

6.6 Typical Characteristics (continued)

al specifications at $T_A = 25^\circ\text{C}$, $V_S = 5\text{ V}$, $V_{\text{SENSE}} = V_{\text{IN}+} - V_{\text{IN}-} = 0.5\text{ V} / \text{Gain}$, and $V_{\text{CM}} = V_{\text{IN}-} = 48\text{ V}$ (unless otherwise noted).

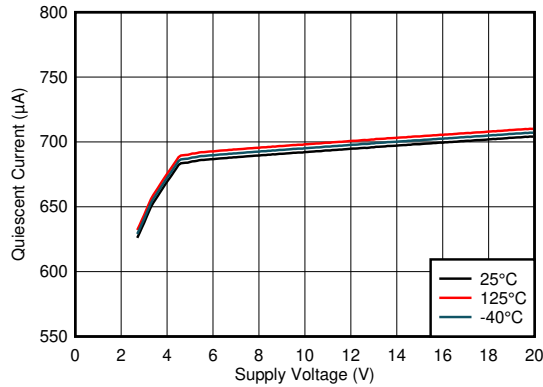

Figure 6-35. Quiescent Current vs. Supply Voltage, INA2290

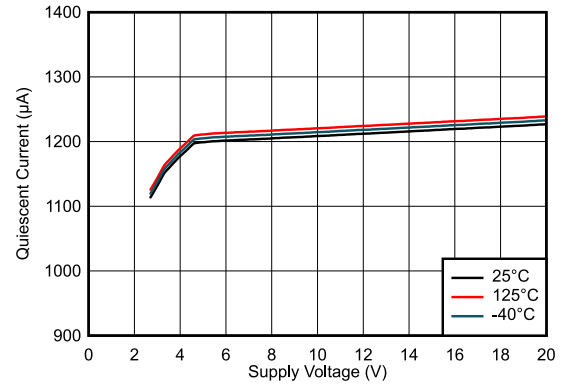

Figure 6-36. Quiescent Current vs. Supply Voltage, INA4290

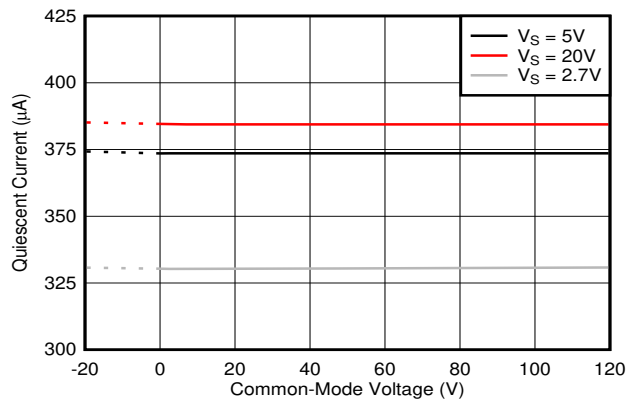

Figure 6-37. Quiescent Current vs. Common-Mode Voltage, INA290

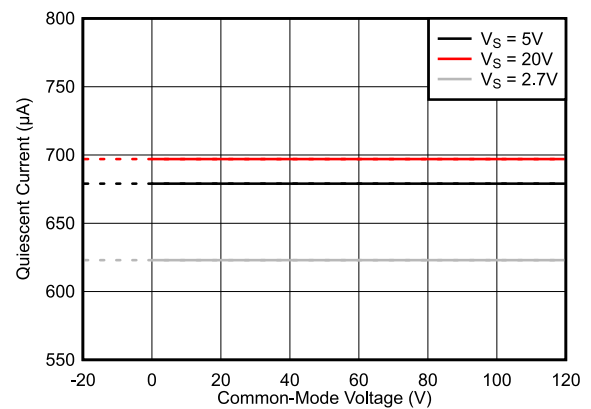

Figure 6-38. Quiescent Current vs. Common-Mode Voltage, INA2290

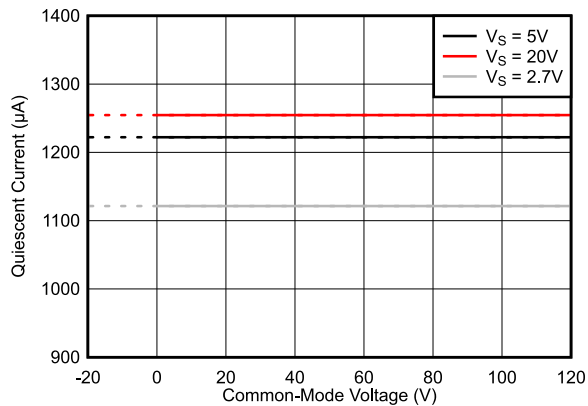

Figure 6-39. Quiescent Current vs. Common-Mode Voltage, INA4290

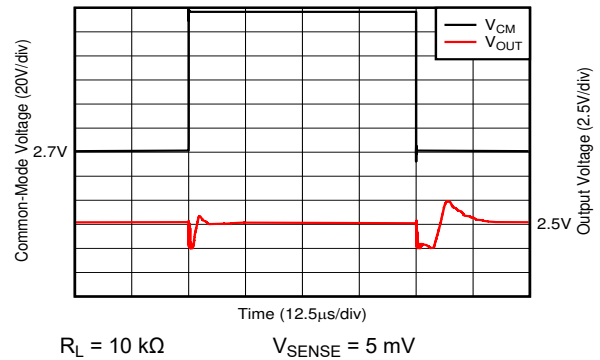

Figure 6-40. Common-Mode Voltage Fast Transient Pulse, A5 Devices

6.6 Typical Characteristics (continued)

al specifications at $T_A = 25^\circ\text{C}$, $V_S = 5\text{ V}$, $V_{\text{SENSE}} = V_{\text{IN}+} - V_{\text{IN}-} = 0.5\text{ V} / \text{Gain}$, and $V_{\text{CM}} = V_{\text{IN}-} = 48\text{ V}$ (unless otherwise noted).

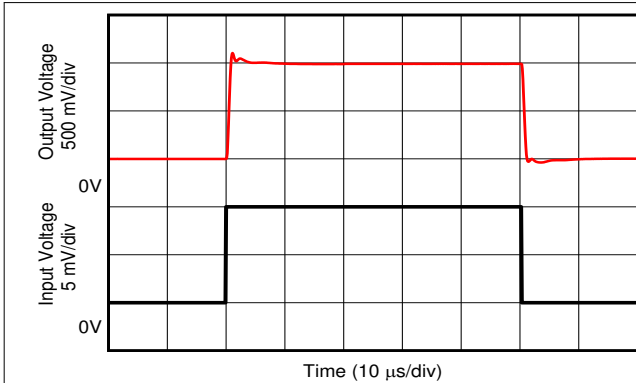
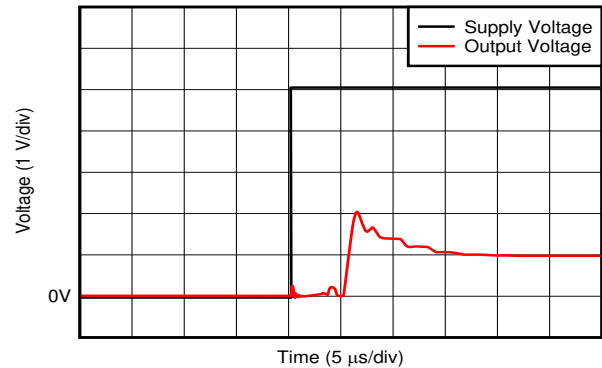
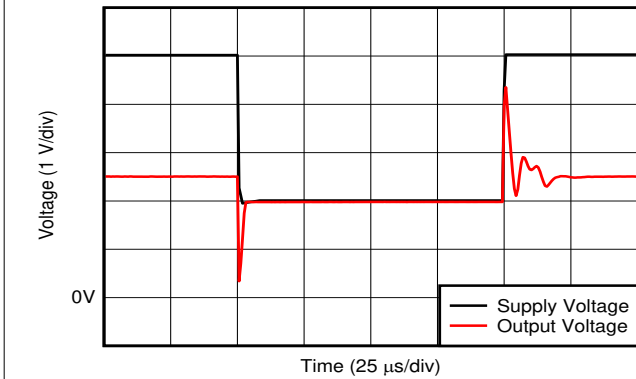

Figure 6-41. Step Response, A3 Devices



$V_{\text{SENSE}} = 0\text{ mV}$

Figure 6-42. Start-Up Response



$V_{\text{SENSE}} = 5\text{ mV}$

Figure 6-43. Supply Transient Response, A5 Devices

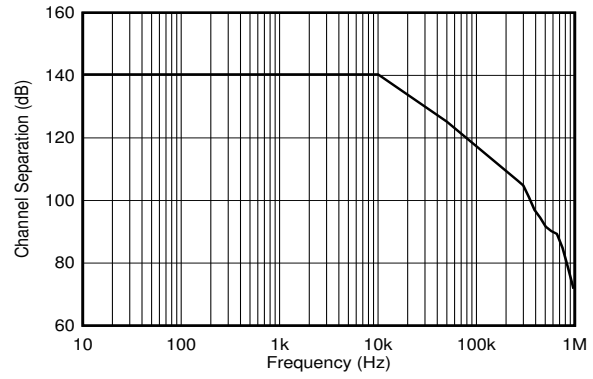

Any channel to any other channel

Figure 6-44. Channel Separation vs. Frequency, Multichannel Devices

7 Detailed Description

7.1 Overview

The INAx290 is a high-side only current-sense amplifier that offers a wide common-mode range, precision zero-drift topology, excellent common-mode rejection ratio (CMRR), high bandwidth, and fast slew rate. Different gain versions are available to optimize the output dynamic range based on the application. The INAx290 is designed using a transconductance architecture with a current-feedback amplifier that enables low bias currents of 20 μA and a common-mode voltage of 120 V.

7.2 Functional Block Diagram

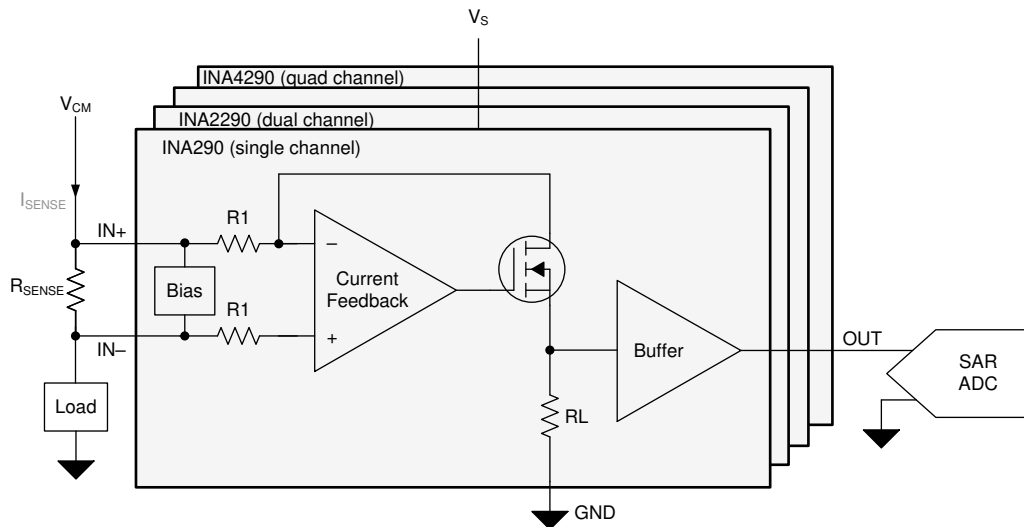

7.3 Feature Description

7.3.1 Amplifier Input Common-Mode Range

The INAx290 supports large input common-mode voltages from 2.7 V to 120 V and features a high DC CMRR of 160 dB (typical) and a 85-dB AC CMRR at 50 kHz. The minimum common-mode voltage as shown in [Figure 7-1](#) is restricted by the supply voltage. The topology of the internal amplifiers INAx290 restricts operation to high-side, current-sensing applications.

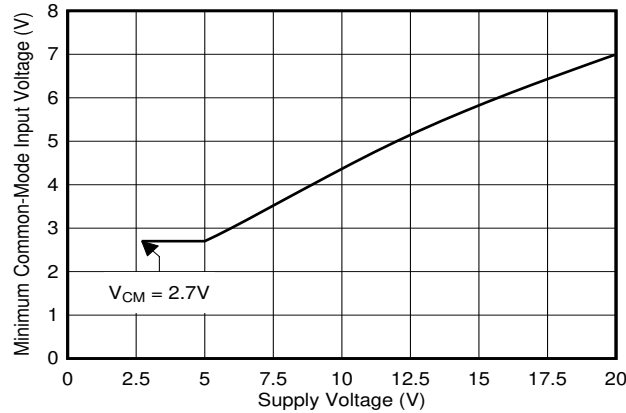

Figure 7-1. Minimum Common-Mode Voltage vs Supply

7.3.2 Input-Signal Bandwidth

[Gain vs. Frequency](#) shows the INAx290 –3-dB bandwidth is gain-dependent with gain options of 20 V/V, 50 V/V, 100 V/V, 200 V/V, and 500 V/V. The unique multistage design enables the amplifier to achieve high bandwidth at all gains. This high bandwidth provides the throughput and fast response required for rapid detection and processing of overcurrent events.

The device bandwidth also depends on the applied V_{SENSE} voltage. [Figure 7-2](#) shows the bandwidth performance profile of the device over frequency as output voltage increases for each gain variation. As shown in [Figure 7-2](#), the device exhibits the highest bandwidth with higher V_{SENSE} voltages, and the bandwidth is higher with lower device gain options. Individual requirements determine the acceptable limits of error for high-frequency, current-sensing applications. Testing and evaluation in the end application or circuit is required to determine the acceptance criteria and validate whether or not the performance levels meet the system specifications.

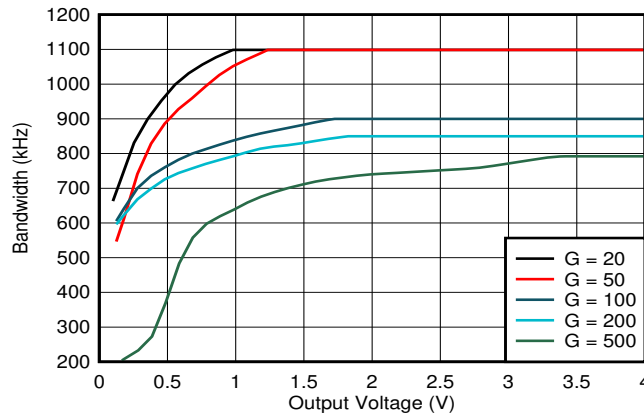

Figure 7-2. Bandwidth vs Output Voltage

7.3.3 Low Input Bias Current

The INAx290 input bias current draws 20 μA (typical) even with common-mode voltages as high as 120 V. This current enables precision current sensing in applications where the sensed current is small or in applications that require lower input leakage current.

7.3.4 Low V_{SENSE} Operation

The INAx290 enables accurate current measurement across the entire valid V_{SENSE} range. The zero-drift input architecture of the INAx290 provides the low offset voltage and low offset drift required to measure low V_{SENSE} levels accurately across the wide operating temperature of -40°C to $+125^{\circ}\text{C}$. The capability to measure low sense voltages enables accurate measurements at lower load currents, and also allows reduction of the sense resistor value for a given operating current, which minimizes the power loss in the current-sensing element. For multichannel devices, the offset voltage and offset drift characteristics can vary from channel to channel; however, all channels meet the maximum values specified in [Electrical Characteristics](#).

7.3.5 Wide Fixed-Gain Output

The INAx290 gain error is $< 0.1\%$ at room temperature for most gain options, with a maximum drift of 5 ppm/ $^{\circ}\text{C}$ over the full temperature range of -40°C to $+125^{\circ}\text{C}$. The INAx290 is available in multiple gain options of 20 V/V, 50 V/V, 100 V/V, 200 V/V, and 500 V/V, which is selected based on the desired signal-to-noise ratio and other system requirements of the design.

The INAx290 closed-loop gain is set by a precision, low-drift internal resistor network. The ratio of these resistors are excellently matched, although the absolute values can vary significantly. TI does not recommend adding additional resistance around the INAx290 to change the effective gain because of this variation. [Table 7-1](#) describes the typical values of the internal gain resistors seen in the functional diagram above.

Table 7-1. Fixed Gain Resistor

GAIN	R1	RL
20 (V/V)	25 k Ω	500 k Ω
50 (V/V)	10 k Ω	500 k Ω
100 (V/V)	10 k Ω	1000 k Ω
200 (V/V)	5 k Ω	1000 k Ω
500 (V/V)	2 k Ω	1000 k Ω

7.3.6 Wide Supply Range

The INAx290 operates with a wide supply range from a 2.7 V to 20 V. The output stage supports a full-scale output voltage range of up to V_{S} . A wide output range can enable very-wide dynamic range current measurements. For a gain of 20 V/V, the maximum acceptable differential input is 1 V.

The INAx290A1 gain offset is $\pm 25 \mu\text{V}$ and this device is capable of measuring a wide dynamic range of current up to 92 dB.

7.4 Device Functional Modes

7.4.1 Unidirectional Operation

The INAx290 measures the differential voltage developed by current flowing through a resistor that is commonly referred to as a *current-sensing resistor* or a *current-shunt resistor*. Figure 7-3 shows that the INAx290 operates in unidirectional mode only, meaning the device only senses current sourced from a power supply to a system load.

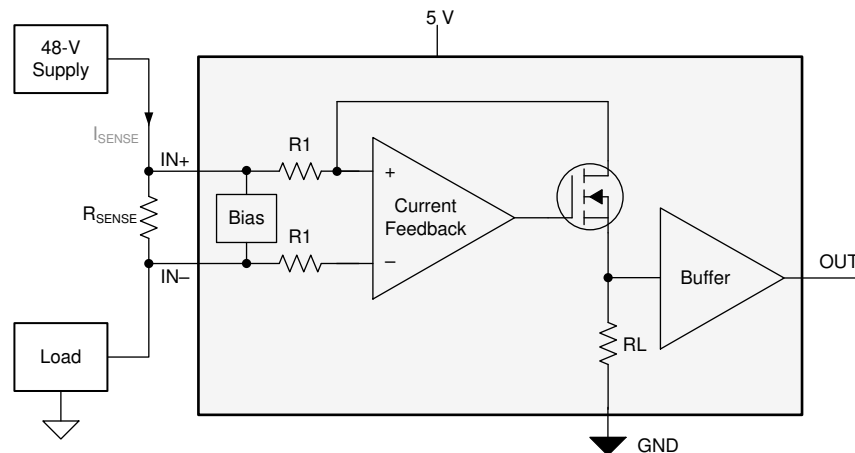

Figure 7-3. Unidirectional Application (Single-Channel Device)

The linear range of the output stage is limited to how close the output voltage can approach ground under zero-input conditions. The zero current output voltage of the INAx290 is very small, with a maximum of GND + 25 mV. Apply a sense voltage of (25 mV / Gain) or greater to keep the INAx290 output in the linear region of operation.

7.4.2 High Signal Throughput

With a bandwidth of 1.1 MHz at a gain of 20 V/V and a slew rate of 2 V/ μ s, the INAx290 is specifically designed for detecting and protecting applications from fast inrush currents. As shown in Table 7-2, the INAx290 responds in less than 2 μ s for a system measuring a 75-A threshold on a 2-m Ω shunt.

Table 7-2. Response Time

PARAMETER		EQUATION	INAx290 AT $V_S = 5\text{ V}$
G	Gain		20 V/V
I_{MAX}	Maximum current		100 A
$I_{Threshold}$	Threshold current		75 A
R_{SENSE}	Current sense resistor value		2 m Ω
V_{OUT_MAX}	Output voltage at maximum current	$V_{OUT} = I_{MAX} \times R_{SENSE} \times G$	4 V
V_{OUT_THR}	Output voltage at threshold current	$V_{OUT_THR} = I_{THR} \times R_{SENSE} \times G$	3 V
SR	Slew rate		2 V/ μ s
	Output response time	$T_{response} = V_{OUT_THR} / SR$	< 2 μ s

8 Application and Implementation

Note

Information in the following applications sections is not part of the TI component specification, and TI does not warrant its accuracy or completeness. TI's customers are responsible for determining suitability of components for their purposes, as well as validating and testing their design implementation to confirm system functionality.

8.1 Application Information

The INAx290 amplifies the voltage developed across a current-sensing resistor as current flows through the resistor to the load. The wide input common-mode voltage range and high common-mode rejection of the INAx290 allows use over a wide range of voltage rails while still maintaining an accurate current measurement.

8.1.1 R_{SENSE} and Device Gain Selection

The accuracy of any current-sense amplifier is maximized by choosing the current-sense resistor to be as large as possible. A large sense resistor maximizes the differential input signal for a given amount of current flow and reduces the error contribution of the offset voltage. However, there are practical limits as to how large the current-sense resistor can be in a given application because of the resistor size and maximum allowable power dissipation. Equation 1 gives the maximum value for the current-sense resistor for a given power dissipation budget:

$$R_{\text{SENSE}} < \frac{PD_{\text{MAX}}}{I_{\text{MAX}}^2} \quad (1)$$

where:

- PD_{MAX} is the maximum allowable power dissipation in R_{SENSE}.
- I_{MAX} is the maximum current that flows through R_{SENSE}.

An additional limitation on the size of the current-sense resistor and device gain results from the power-supply voltage, V_S, and device swing-to-rail limitations. To ensure that the current-sense signal is properly passed to the output, both positive and negative output swing limitations must be examined. Equation 2 provides the maximum values of R_{SENSE} and GAIN to keep the device from exceeding the positive swing limitation.

$$I_{\text{MAX}} \times R_{\text{SENSE}} \times \text{GAIN} < V_{\text{SP}} \quad (2)$$

where:

- I_{MAX} is the maximum current that flows through R_{SENSE}.
- GAIN is the gain of the current-sense amplifier.
- V_{SP} is the positive output swing as specified in this data sheet.

To avoid positive output swing limitations when selecting the value of R_{SENSE}, there is always a trade-off between the value of the sense resistor and the gain of the device under consideration. If the sense resistor selected for the maximum power dissipation is too large, then selecting a lower gain device is possible to avoid positive swing limitations.

The negative swing limitation places a limit on how small the sense resistor value can be for a given application. Equation 3 provides the limit on the minimum value of the sense resistor.

$$I_{\text{MIN}} \times R_{\text{SENSE}} \times \text{GAIN} > V_{\text{SN}} \quad (3)$$

where:

- I_{MIN} is the minimum current that flows through R_{SENSE}.
- GAIN is the gain of the current-sense amplifier.

- V_{SN} is the negative output swing of the device.

Table 8-1 shows an example of the different results obtained from using five different gain versions of the INAx290. From the table data, the highest gain device allows a smaller current-shunt resistor and decreased power dissipation in the element.

Table 8-1. R_{SENSE} Selection and Power Dissipation

PARAMETER ⁽¹⁾		EQUATION	RESULTS AT $V_S = 5\text{ V}$				
			INAx290A1	INAx290A2	INAx290A3	INAx290A4	INAx290A5
G	Gain		20 V/V	50 V/V	100 V/V	200 V/V	500 V/V
V_{SENSE}	Ideal differential input voltage (Ignores swing limitation and power-supply variation.)	$V_{SENSE} = V_{OUT} / G$	250 mV	100 mV	50 mV	25 mV	10 mV
R_{SENSE}	Current-sense resistor value	$R_{SENSE} = V_{SENSE} / I_{MAX}$	25 mΩ	10 mΩ	5 mΩ	2.5 mΩ	1 mΩ
P_{SENSE}	Current-sense resistor power dissipation	$R_{SENSE} \times I_{MAX}^2$	2.5 W	1 W	0.5W	0.25 W	0.1 W

(1) Design example with 10-A, full-scale current with maximum output voltage set to 5 V.

8.1.2 Input Filtering

Note

Input filters are not required for accurate measurements using the INAx290, and use of filters in this location is not recommended. If filter components are used on the input of the amplifier, follow the guidelines in this section to minimize the effects on performance.

Based strictly on user design requirements, external filtering of the current signal may be desired. The initial location that can be considered for the filter is at the output of the current-sense amplifier. Although placing the filter at the output satisfies the filtering requirements, this location changes the low output impedance measured by any circuitry connected to the output voltage pin. The other location for filter placement is at the current-sense amplifier input pins. This location also satisfies the filtering requirement, but the components must be carefully selected to minimally impact device performance. Figure 8-1 shows a filter placed at the input pins.

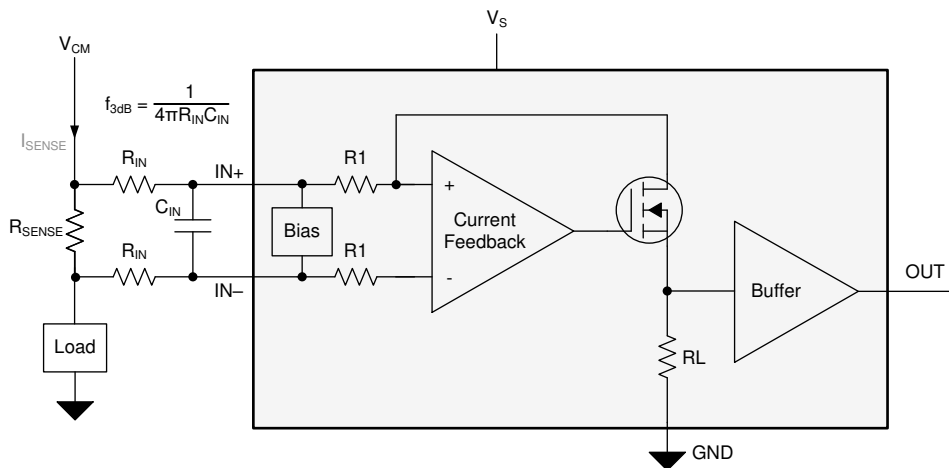

Figure 8-1. Filter at Input Pins (Single Channel Shown for Simplicity)

External series resistance provides a source of additional measurement error, so keep the value of these series resistors to 10 Ω or less to reduce loss of accuracy. The internal bias network shown in Figure 8-1 creates a mismatch in input bias currents (see Figure 6-16, Figure 6-17, and Figure 6-18) when a differential voltage is applied between the input pins. If additional external series filter resistors are added to the circuit, a mismatch is created in the voltage drop across the filter resistors. This voltage is a differential error voltage in the shunt resistor voltage. In addition to the absolute resistor value, mismatch resulting from resistor tolerance can significantly impact the error because this value is calculated based on the actual measured resistance.

Use [Equation 4](#) to calculate the measurement error expected from the additional external filter resistors, and use [Equation 5](#) to calculate the gain error factor.

$$\text{Gain Error (\%)} = 100 \times (\text{Gain Error Factor} - 1) \tag{4}$$

$$\text{Gain Error Factor} = \frac{R_B \times R_1}{(R_B \times R_1) + (R_B \times R_{IN}) + (2 \times R_{IN} \times R_1)} \tag{5}$$

Where:

- R_{IN} is the external filter resistance value.
- R_1 is the INAx290 input resistance value specified in [Table 7-1](#).
- R_B is the internal bias resistance, which is $6600 \Omega \pm 20\%$.

The gain error factor, shown in [Equation 4](#), can be calculated to determine the gain error introduced by the additional external series resistance. [Equation 4](#) calculates the deviation of the shunt voltage, resulting from the attenuation and imbalance created by the added external filter resistance. [Table 8-2](#) provides the gain error factor and gain error for several resistor values.

Table 8-2. Example Gain Error Factor and Gain Error for 10-Ω External Filter Input Resistors

DEVICE (GAIN)	GAIN ERROR FACTOR	GAIN ERROR (%)
A1 devices (20)	0.99658	-0.34185
A2 devices (50)	0.99598	-0.40141
A3 devices (100)	0.99598	-0.40141
A4 devices (200)	0.99499	-0.50051
A5 devices (500)	0.99203	-0.79663

8.2 Typical Application

The INAx290 is a unidirectional, current-sense amplifier capable of measuring currents through a resistive shunt with shunt common-mode voltages from 2.7 V to 120 V. [Figure 8-2](#) shows the circuit configuration for monitoring current in a high-side radio frequency (RF) power amplifier (PA) application.

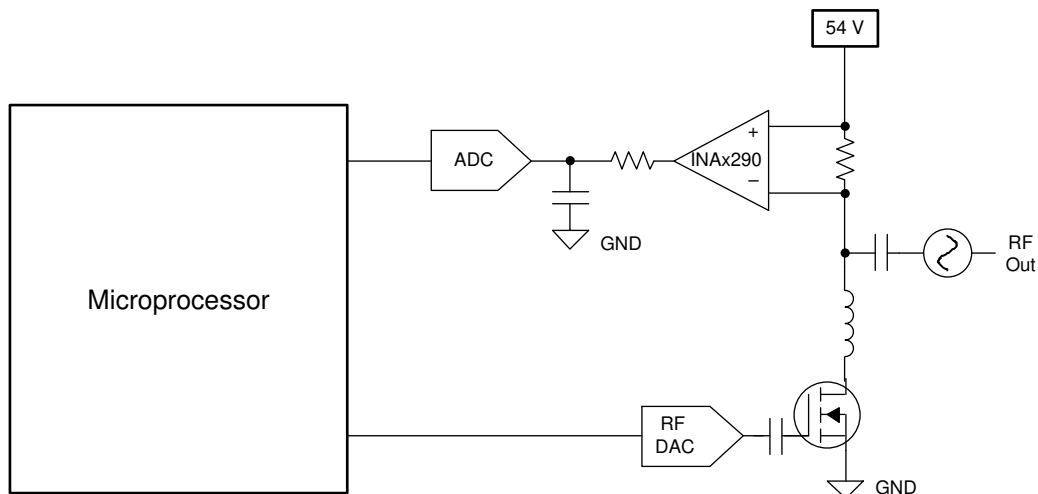

Figure 8-2. Current Sensing in a PA Application (Single-Channel Device)

8.2.1 Design Requirements

V_{SUPPLY} is set to 5 V and the common-mode voltage set to 54 V. Table 8-3 lists the design setup for this application.

Table 8-3. Design Parameters

DESIGN PARAMETERS	EXAMPLE VALUE
INAx290 supply voltage	5 V
High-side supply voltage	5 V
Maximum sense current (I_{MAX})	5 A
Gain option	50 V/V

8.2.2 Detailed Design Procedure

The maximum value of the current-sense resistor is calculated based on the choice of gain, value of the maximum current to be sensed (I_{MAX}), and the power-supply voltage (V_{S}). When operating at the maximum current, the output voltage must not exceed the positive output swing specification, V_{SP} . Under the given design parameters, Equation 6 calculates the maximum value for R_{SENSE} as 19.2 m Ω .

$$R_{\text{SENSE}} < \frac{V_{\text{SP}}}{I_{\text{MAX}} \times \text{GAIN}} \quad (6)$$

Although 15 m Ω is less than the maximum value calculated, 15 m Ω is selected for this design example because this value is still large enough to provide an adequate signal at the current-sense amplifier output.

8.2.2.1 Overload Recovery With Negative V_{SENSE}

The INAx290 is a unidirectional current-sense amplifier that is meant to operate with a positive differential input voltage (V_{SENSE}). If negative V_{SENSE} is applied, the device is placed in an overload condition and requires time to recover when V_{SENSE} returns positive. The required overload recovery time increases with more negative V_{SENSE} .

8.2.3 Application Curve

Figure 8-3 shows the output response of the device to a high-frequency sinusoidal current.

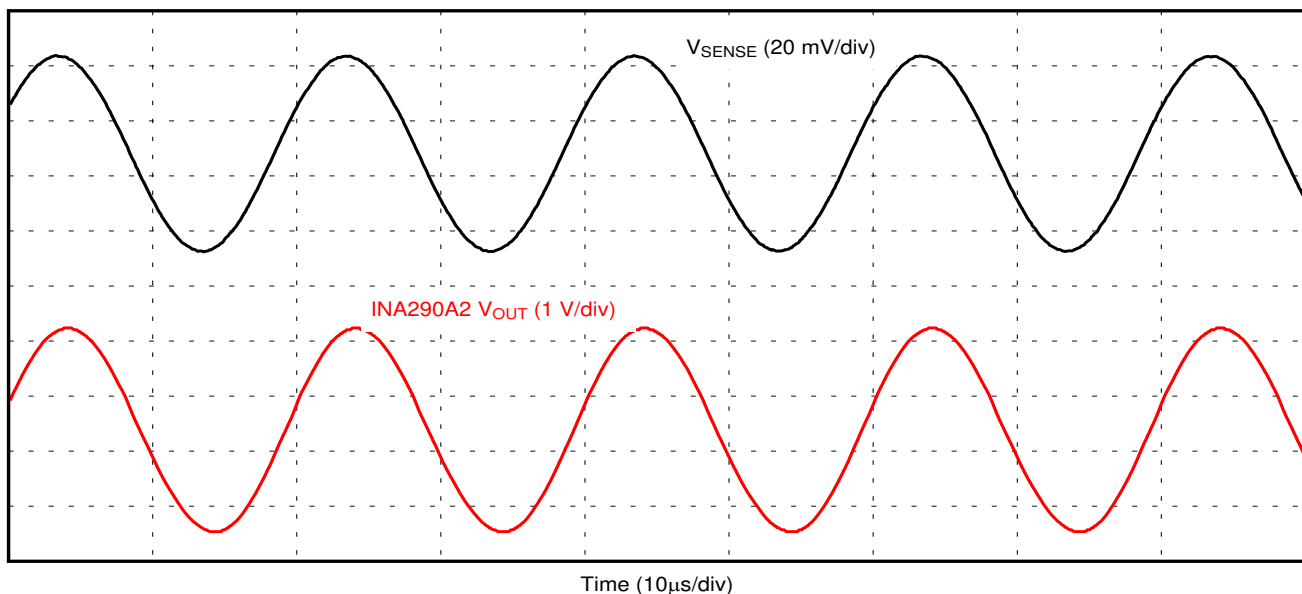

Figure 8-3. INAx290 Output Response

9 Power Supply Recommendations

The input circuitry of the INAx290 can accurately measure beyond the power-supply voltage. The power supply can be 20 V, whereas the load power-supply voltage at IN+ and IN– can go up to 120 V. The output voltage range of the OUT pin is limited by the voltage on the VS pin and the device swing to the supply specification.

10 Layout

10.1 Layout Guidelines

TI always recommends to follow good layout practices:

- Connect the input pins to the sensing resistor using a Kelvin or 4-wire connection. This connection technique makes sure that only the current-sensing resistor impedance is detected between the input pins. Poor routing of the current-sensing resistor commonly results in additional resistance present between the input pins. Given the very low ohmic value of the current resistor, any additional high-current carrying impedance can cause significant measurement errors.
- Place the power-supply bypass capacitor as close to the device power supply and ground pins as possible. The recommended value of this bypass capacitor is 0.1 μF . Additional decoupling capacitance can be added to compensate for noisy or high-impedance power supplies.
- When routing the connections from the current-sense resistor to the device, keep the trace lengths as short as possible.

10.2 Layout Examples

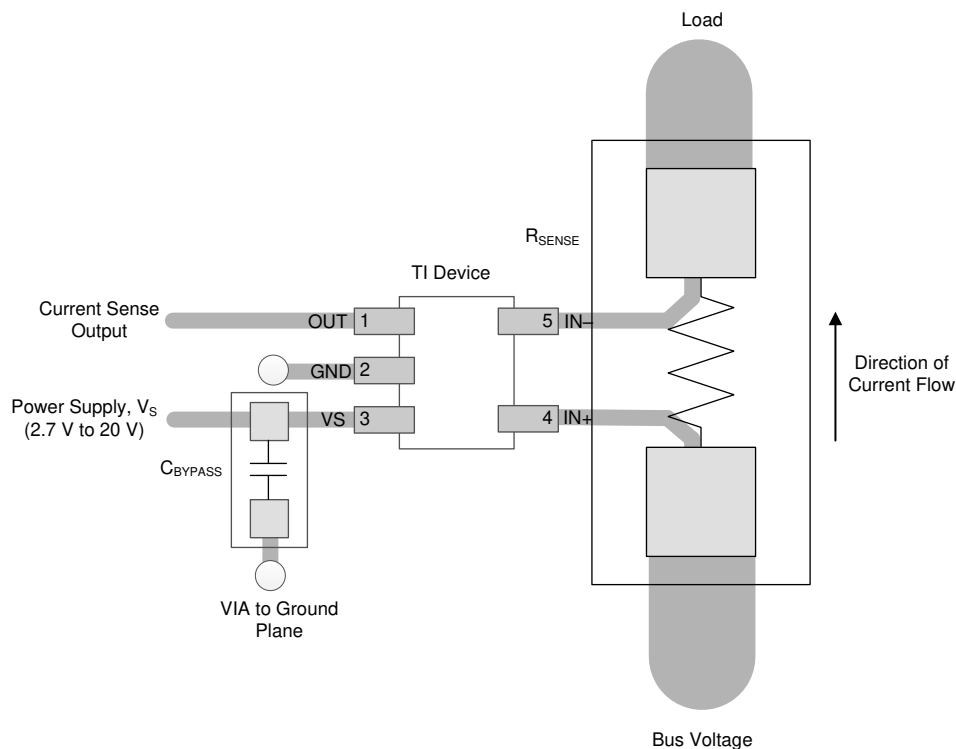

Figure 10-1. Recommended Layout for the INA290

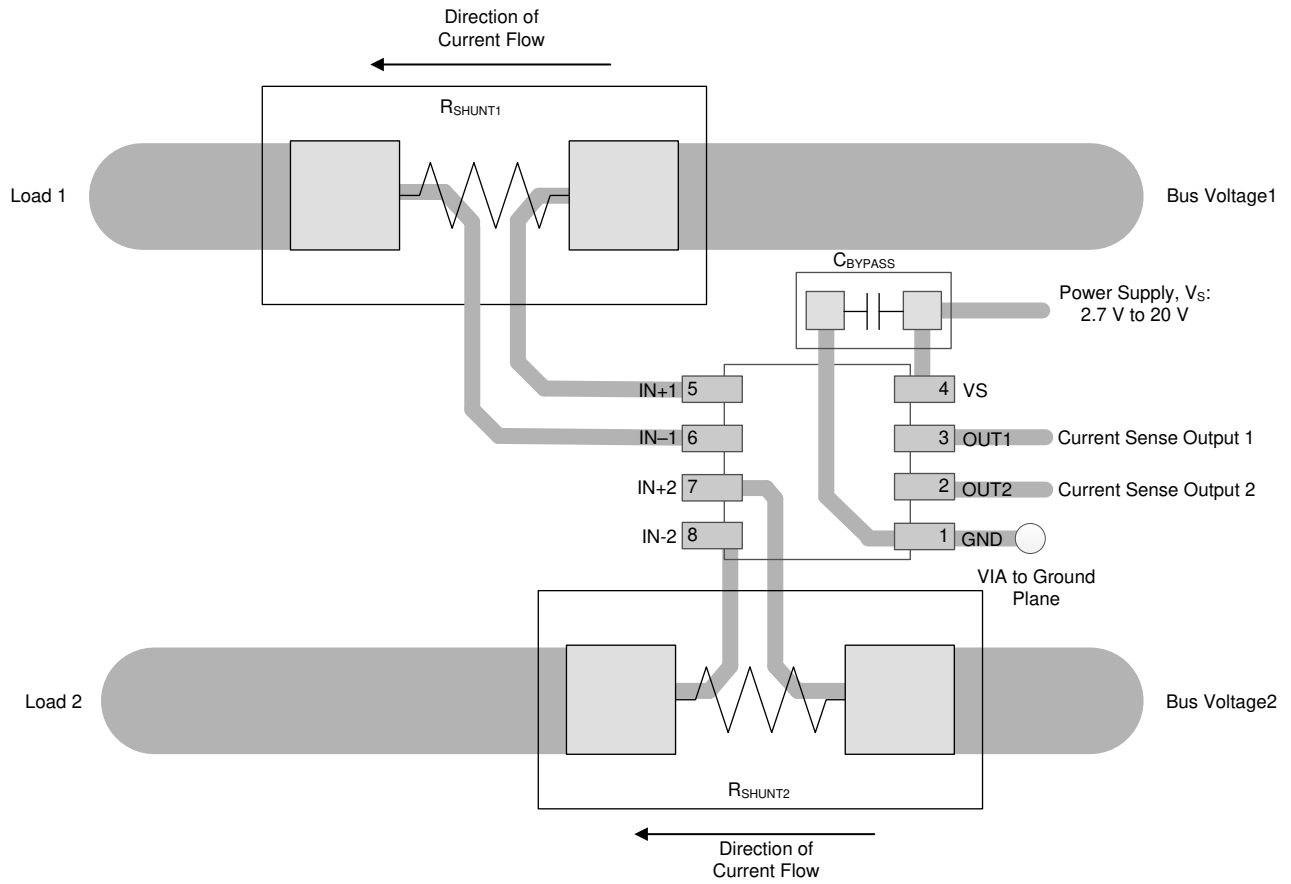

Figure 10-2. Recommended Layout for the INA2290

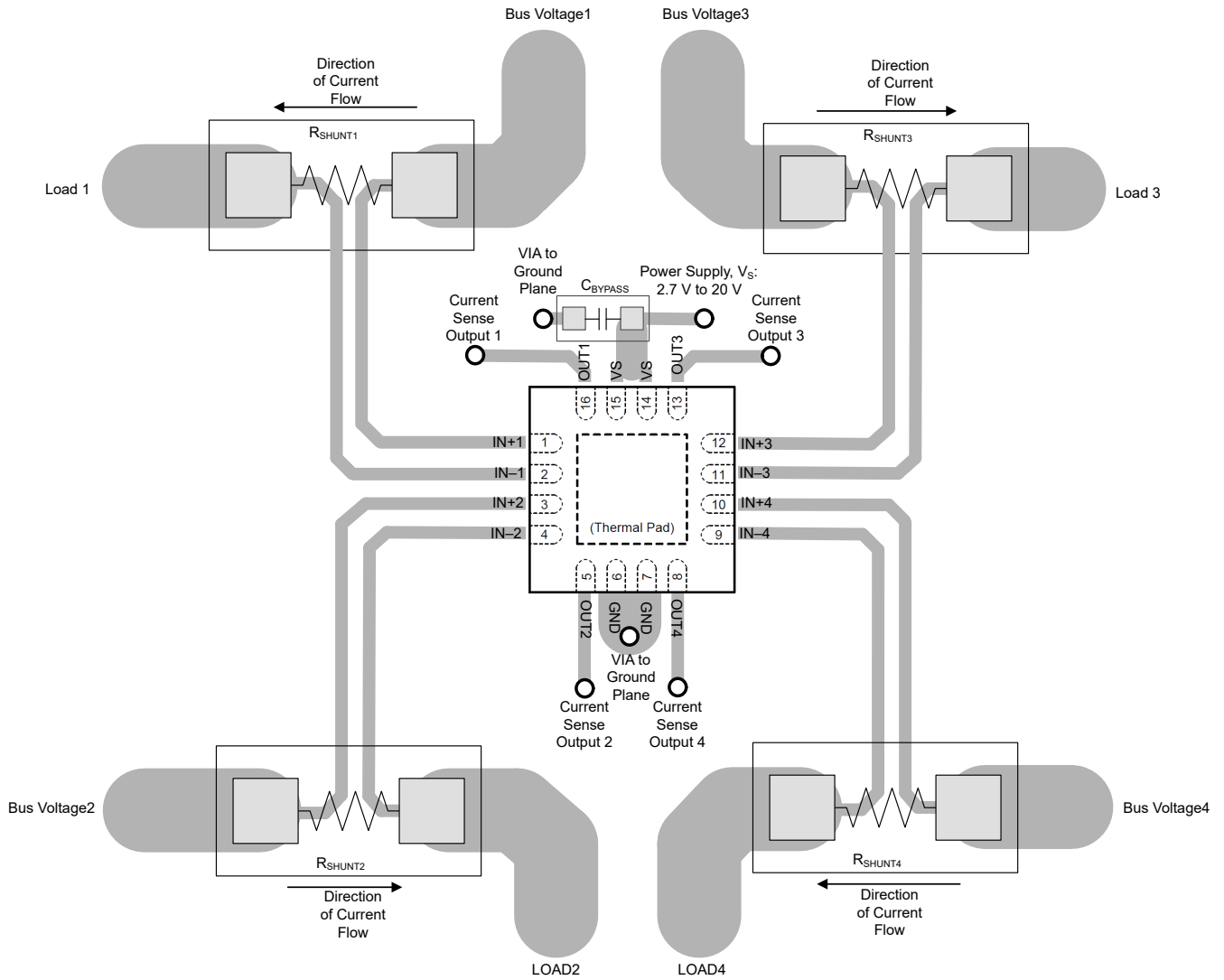

Figure 10-3. Recommended Layout for the INA4290

11 Device and Documentation Support

11.1 Documentation Support

11.1.1 Related Documentation

For related documentation, see the following:

- Texas Instruments, [INA290EVM User's Guide](#) (SBOU230)
- Texas Instruments, [INA2290EVM User's Guide](#) (SBOU243)
- Texas Instruments, [INA4290EVM User's Guide](#) (SBOU258)

11.2 Receiving Notification of Documentation Updates

To receive notification of documentation updates, navigate to the device product folder on [ti.com](#). Click on *Subscribe to updates* to register and receive a weekly digest of any product information that has changed. For change details, review the revision history included in any revised document.

11.3 Support Resources

[TI E2E™ support forums](#) are an engineer's go-to source for fast, verified answers and design help — straight from the experts. Search existing answers or ask your own question to get the quick design help you need.

Linked content is provided "AS IS" by the respective contributors. They do not constitute TI specifications and do not necessarily reflect TI's views; see TI's [Terms of Use](#).

11.4 Trademarks

TI E2E™ is a trademark of Texas Instruments.

All trademarks are the property of their respective owners.

11.5 Electrostatic Discharge Caution



This integrated circuit can be damaged by ESD. Texas Instruments recommends that all integrated circuits be handled with appropriate precautions. Failure to observe proper handling and installation procedures can cause damage.

ESD damage can range from subtle performance degradation to complete device failure. Precision integrated circuits may be more susceptible to damage because very small parametric changes could cause the device not to meet its published specifications.

11.6 Glossary

[TI Glossary](#) This glossary lists and explains terms, acronyms, and definitions.

12 Mechanical, Packaging, and Orderable Information

The following pages include mechanical, packaging, and orderable information. This information is the most current data available for the designated devices. This data is subject to change without notice and revision of this document. For browser-based versions of this data sheet, refer to the left-hand navigation.

PACKAGING INFORMATION

Orderable part number	Status (1)	Material type (2)	Package Pins	Package qty Carrier	RoHS (3)	Lead finish/ Ball material (4)	MSL rating/ Peak reflow (5)	Op temp (°C)	Part marking (6)
INA2290A1IDGKR	Active	Production	VSSOP (DGK) 8	2500 LARGE T&R	Yes	NIPDAU	Level-2-260C-1 YEAR	-40 to 125	2FAQ
INA2290A1IDGKR.B	Active	Production	VSSOP (DGK) 8	2500 LARGE T&R	Yes	NIPDAU	Level-2-260C-1 YEAR	-40 to 125	2FAQ
INA2290A1IDGKRG4	Active	Production	VSSOP (DGK) 8	2500 LARGE T&R	Yes	NIPDAU	Level-2-260C-1 YEAR	-40 to 125	2FAQ
INA2290A1IDGKRG4.B	Active	Production	VSSOP (DGK) 8	2500 LARGE T&R	Yes	NIPDAU	Level-2-260C-1 YEAR	-40 to 125	2FAQ
INA2290A1IDGKT	Obsolete	Production	VSSOP (DGK) 8	-	-	Call TI	Call TI	-40 to 125	2FAQ
INA2290A2IDGKR	Active	Production	VSSOP (DGK) 8	2500 LARGE T&R	Yes	NIPDAU	Level-2-260C-1 YEAR	-40 to 125	2FBQ
INA2290A2IDGKR.B	Active	Production	VSSOP (DGK) 8	2500 LARGE T&R	Yes	NIPDAU	Level-2-260C-1 YEAR	-40 to 125	2FBQ
INA2290A2IDGKT	Obsolete	Production	VSSOP (DGK) 8	-	-	Call TI	Call TI	-40 to 125	2FBQ
INA2290A3IDGKR	Active	Production	VSSOP (DGK) 8	2500 LARGE T&R	Yes	NIPDAU	Level-2-260C-1 YEAR	-40 to 125	2FCQ
INA2290A3IDGKR.B	Active	Production	VSSOP (DGK) 8	2500 LARGE T&R	Yes	NIPDAU	Level-2-260C-1 YEAR	-40 to 125	2FCQ
INA2290A3IDGKT	Obsolete	Production	VSSOP (DGK) 8	-	-	Call TI	Call TI	-40 to 125	2FCQ
INA2290A4IDGKR	Active	Production	VSSOP (DGK) 8	2500 LARGE T&R	Yes	NIPDAU	Level-2-260C-1 YEAR	-40 to 125	2FDQ
INA2290A4IDGKR.B	Active	Production	VSSOP (DGK) 8	2500 LARGE T&R	Yes	NIPDAU	Level-2-260C-1 YEAR	-40 to 125	2FDQ
INA2290A4IDGKT	Obsolete	Production	VSSOP (DGK) 8	-	-	Call TI	Call TI	-40 to 125	2FDQ
INA2290A5IDGKR	Active	Production	VSSOP (DGK) 8	2500 LARGE T&R	Yes	NIPDAU	Level-2-260C-1 YEAR	-40 to 125	2FEQ
INA2290A5IDGKR.B	Active	Production	VSSOP (DGK) 8	2500 LARGE T&R	Yes	NIPDAU	Level-2-260C-1 YEAR	-40 to 125	2FEQ
INA2290A5IDGKT	Obsolete	Production	VSSOP (DGK) 8	-	-	Call TI	Call TI	-40 to 125	2FEQ
INA290A1IDCKR	Active	Production	SC70 (DCK) 5	3000 LARGE T&R	Yes	NIPDAU	Level-1-260C-UNLIM	-40 to 125	1FQ
INA290A1IDCKR.B	Active	Production	SC70 (DCK) 5	3000 LARGE T&R	Yes	NIPDAU	Level-1-260C-UNLIM	-40 to 125	1FQ
INA290A1IDCKRG4	Active	Production	SC70 (DCK) 5	3000 LARGE T&R	Yes	NIPDAU	Level-1-260C-UNLIM	-40 to 125	1FQ
INA290A1IDCKRG4.B	Active	Production	SC70 (DCK) 5	3000 LARGE T&R	Yes	NIPDAU	Level-1-260C-UNLIM	-40 to 125	1FQ
INA290A1IDCKT	Obsolete	Production	SC70 (DCK) 5	-	-	Call TI	Call TI	-40 to 125	1FQ
INA290A2IDCKR	Active	Production	SC70 (DCK) 5	3000 LARGE T&R	Yes	NIPDAU	Level-1-260C-UNLIM	-40 to 125	1FR
INA290A2IDCKR.B	Active	Production	SC70 (DCK) 5	3000 LARGE T&R	Yes	NIPDAU	Level-1-260C-UNLIM	-40 to 125	1FR
INA290A2IDCKRG4	Active	Production	SC70 (DCK) 5	3000 LARGE T&R	Yes	NIPDAU	Level-1-260C-UNLIM	-40 to 125	1FR
INA290A2IDCKRG4.B	Active	Production	SC70 (DCK) 5	3000 LARGE T&R	Yes	NIPDAU	Level-1-260C-UNLIM	-40 to 125	1FR
INA290A2IDCKT	Active	Production	SC70 (DCK) 5	250 SMALL T&R	Yes	NIPDAU	Level-1-260C-UNLIM	-40 to 125	1FR
INA290A2IDCKT.B	Active	Production	SC70 (DCK) 5	250 SMALL T&R	Yes	NIPDAU	Level-1-260C-UNLIM	-40 to 125	1FR
INA290A3IDCKR	Active	Production	SC70 (DCK) 5	3000 LARGE T&R	Yes	NIPDAU	Level-1-260C-UNLIM	-40 to 125	1FS

Orderable part number	Status (1)	Material type (2)	Package Pins	Package qty Carrier	RoHS (3)	Lead finish/ Ball material (4)	MSL rating/ Peak reflow (5)	Op temp (°C)	Part marking (6)
INA290A3IDCKR.B	Active	Production	SC70 (DCK) 5	3000 LARGE T&R	Yes	NIPDAU	Level-1-260C-UNLIM	-40 to 125	1FS
INA290A3IDCKRG4	Active	Production	SC70 (DCK) 5	3000 LARGE T&R	Yes	NIPDAU	Level-1-260C-UNLIM	-40 to 125	1FS
INA290A3IDCKRG4.B	Active	Production	SC70 (DCK) 5	3000 LARGE T&R	Yes	NIPDAU	Level-1-260C-UNLIM	-40 to 125	1FS
INA290A3IDCKT	Active	Production	SC70 (DCK) 5	250 SMALL T&R	Yes	NIPDAU	Level-1-260C-UNLIM	-40 to 125	1FS
INA290A3IDCKT.B	Active	Production	SC70 (DCK) 5	250 SMALL T&R	Yes	NIPDAU	Level-1-260C-UNLIM	-40 to 125	1FS
INA290A4IDCKR	Active	Production	SC70 (DCK) 5	3000 LARGE T&R	Yes	NIPDAU	Level-1-260C-UNLIM	-40 to 125	1FT
INA290A4IDCKR.B	Active	Production	SC70 (DCK) 5	3000 LARGE T&R	Yes	NIPDAU	Level-1-260C-UNLIM	-40 to 125	1FT
INA290A4IDCKT	Obsolete	Production	SC70 (DCK) 5	-	-	Call TI	Call TI	-40 to 125	1FT
INA290A5IDCKR	Active	Production	SC70 (DCK) 5	3000 LARGE T&R	Yes	NIPDAU	Level-1-260C-UNLIM	-40 to 125	1FU
INA290A5IDCKR.B	Active	Production	SC70 (DCK) 5	3000 LARGE T&R	Yes	NIPDAU	Level-1-260C-UNLIM	-40 to 125	1FU
INA290A5IDCKT	Obsolete	Production	SC70 (DCK) 5	-	-	Call TI	Call TI	-40 to 125	1FU
INA4290A1IRGVR	Active	Production	VQFN (RGV) 16	2500 LARGE T&R	Yes	SN	Level-1-260C-UNLIM	-40 to 125	INA 4290A1
INA4290A1IRGVR.B	Active	Production	VQFN (RGV) 16	2500 LARGE T&R	Yes	SN	Level-1-260C-UNLIM	-40 to 125	INA 4290A1
INA4290A1IRGVRG4	Active	Production	VQFN (RGV) 16	2500 LARGE T&R	Yes	NIPDAU	Level-1-260C-UNLIM	-40 to 125	INA 4290A1
INA4290A1IRGVRG4.B	Active	Production	VQFN (RGV) 16	2500 LARGE T&R	Yes	NIPDAU	Level-1-260C-UNLIM	-40 to 125	INA 4290A1
INA4290A1IRGVT	Obsolete	Production	VQFN (RGV) 16	-	-	Call TI	Call TI	-40 to 125	INA 4290A1
INA4290A2IRGVR	Active	Production	VQFN (RGV) 16	2500 LARGE T&R	Yes	SN	Level-1-260C-UNLIM	-40 to 125	INA 4290A2
INA4290A2IRGVR.B	Active	Production	VQFN (RGV) 16	2500 LARGE T&R	Yes	SN	Level-1-260C-UNLIM	-40 to 125	INA 4290A2
INA4290A2IRGVT	Obsolete	Production	VQFN (RGV) 16	-	-	Call TI	Call TI	-40 to 125	INA 4290A2
INA4290A3IRGVR	Active	Production	VQFN (RGV) 16	2500 LARGE T&R	Yes	SN	Level-1-260C-UNLIM	-40 to 125	INA 4290A3
INA4290A3IRGVR.B	Active	Production	VQFN (RGV) 16	2500 LARGE T&R	Yes	SN	Level-1-260C-UNLIM	-40 to 125	INA 4290A3
INA4290A3IRGVT	Obsolete	Production	VQFN (RGV) 16	-	-	Call TI	Call TI	-40 to 125	INA 4290A3

Orderable part number	Status (1)	Material type (2)	Package Pins	Package qty Carrier	RoHS (3)	Lead finish/ Ball material (4)	MSL rating/ Peak reflow (5)	Op temp (°C)	Part marking (6)
INA4290A4IRGVR	Active	Production	VQFN (RGV) 16	2500 LARGE T&R	Yes	SN	Level-1-260C-UNLIM	-40 to 125	INA 4290A4
INA4290A4IRGVR.B	Active	Production	VQFN (RGV) 16	2500 LARGE T&R	Yes	SN	Level-1-260C-UNLIM	-40 to 125	INA 4290A4
INA4290A4IRGVT	Obsolete	Production	VQFN (RGV) 16	-	-	Call TI	Call TI	-40 to 125	INA 4290A4
INA4290A5IRGVR	Active	Production	VQFN (RGV) 16	2500 LARGE T&R	Yes	SN	Level-1-260C-UNLIM	-40 to 125	INA 4290A5
INA4290A5IRGVR.B	Active	Production	VQFN (RGV) 16	2500 LARGE T&R	Yes	SN	Level-1-260C-UNLIM	-40 to 125	INA 4290A5
INA4290A5IRGVT	Active	Production	VQFN (RGV) 16	250 SMALL T&R	Yes	SN	Level-1-260C-UNLIM	-40 to 125	INA 4290A5
INA4290A5IRGVT.B	Active	Production	VQFN (RGV) 16	250 SMALL T&R	Yes	SN	Level-1-260C-UNLIM	-40 to 125	INA 4290A5

(1) **Status:** For more details on status, see our [product life cycle](#).

(2) **Material type:** When designated, preproduction parts are prototypes/experimental devices, and are not yet approved or released for full production. Testing and final process, including without limitation quality assurance, reliability performance testing, and/or process qualification, may not yet be complete, and this item is subject to further changes or possible discontinuation. If available for ordering, purchases will be subject to an additional waiver at checkout, and are intended for early internal evaluation purposes only. These items are sold without warranties of any kind.

(3) **RoHS values:** Yes, No, RoHS Exempt. See the [TI RoHS Statement](#) for additional information and value definition.

(4) **Lead finish/Ball material:** Parts may have multiple material finish options. Finish options are separated by a vertical ruled line. Lead finish/Ball material values may wrap to two lines if the finish value exceeds the maximum column width.

(5) **MSL rating/Peak reflow:** The moisture sensitivity level ratings and peak solder (reflow) temperatures. In the event that a part has multiple moisture sensitivity ratings, only the lowest level per JEDEC standards is shown. Refer to the shipping label for the actual reflow temperature that will be used to mount the part to the printed circuit board.

(6) **Part marking:** There may be an additional marking, which relates to the logo, the lot trace code information, or the environmental category of the part.

Multiple part markings will be inside parentheses. Only one part marking contained in parentheses and separated by a "~" will appear on a part. If a line is indented then it is a continuation of the previous line and the two combined represent the entire part marking for that device.

Important Information and Disclaimer: The information provided on this page represents TI's knowledge and belief as of the date that it is provided. TI bases its knowledge and belief on information provided by third parties, and makes no representation or warranty as to the accuracy of such information. Efforts are underway to better integrate information from third parties. TI has taken and continues to take reasonable steps to provide representative and accurate information but may not have conducted destructive testing or chemical analysis on incoming materials and chemicals. TI and TI suppliers consider certain information to be proprietary, and thus CAS numbers and other limited information may not be available for release.

In no event shall TI's liability arising out of such information exceed the total purchase price of the TI part(s) at issue in this document sold by TI to Customer on an annual basis.

OTHER QUALIFIED VERSIONS OF INA290 :

- Automotive : [INA290-Q1](#)

NOTE: Qualified Version Definitions:

- Automotive - Q100 devices qualified for high-reliability automotive applications targeting zero defects

TAPE AND REEL INFORMATION

QUADRANT ASSIGNMENTS FOR PIN 1 ORIENTATION IN TAPE

*All dimensions are nominal

Device	Package Type	Package Drawing	Pins	SPQ	Reel Diameter (mm)	Reel Width W1 (mm)	A0 (mm)	B0 (mm)	K0 (mm)	P1 (mm)	W (mm)	Pin1 Quadrant
INA2290A1IDGKR	VSSOP	DGK	8	2500	330.0	12.4	5.25	3.35	1.25	8.0	12.0	Q1
INA2290A1IDGKRG4	VSSOP	DGK	8	2500	330.0	12.4	5.25	3.35	1.25	8.0	12.0	Q1
INA2290A2IDGKR	VSSOP	DGK	8	2500	330.0	12.4	5.25	3.35	1.25	8.0	12.0	Q1
INA2290A3IDGKR	VSSOP	DGK	8	2500	330.0	12.4	5.25	3.35	1.25	8.0	12.0	Q1
INA2290A4IDGKR	VSSOP	DGK	8	2500	330.0	12.4	5.25	3.35	1.25	8.0	12.0	Q1
INA2290A5IDGKR	VSSOP	DGK	8	2500	330.0	12.4	5.25	3.35	1.25	8.0	12.0	Q1
INA290A1IDCKR	SC70	DCK	5	3000	180.0	8.4	2.47	2.3	1.25	4.0	8.0	Q3
INA290A1IDCKRG4	SC70	DCK	5	3000	180.0	8.4	2.47	2.3	1.25	4.0	8.0	Q3
INA290A2IDCKR	SC70	DCK	5	3000	180.0	8.4	2.47	2.3	1.25	4.0	8.0	Q3
INA290A2IDCKRG4	SC70	DCK	5	3000	180.0	8.4	2.47	2.3	1.25	4.0	8.0	Q3
INA290A2IDCKT	SC70	DCK	5	250	180.0	8.4	2.47	2.3	1.25	4.0	8.0	Q3
INA290A3IDCKR	SC70	DCK	5	3000	180.0	8.4	2.47	2.3	1.25	4.0	8.0	Q3
INA290A3IDCKRG4	SC70	DCK	5	3000	180.0	8.4	2.47	2.3	1.25	4.0	8.0	Q3
INA290A3IDCKT	SC70	DCK	5	250	180.0	8.4	2.47	2.3	1.25	4.0	8.0	Q3
INA290A4IDCKR	SC70	DCK	5	3000	180.0	8.4	2.47	2.3	1.25	4.0	8.0	Q3
INA290A5IDCKR	SC70	DCK	5	3000	180.0	8.4	2.47	2.3	1.25	4.0	8.0	Q3

Device	Package Type	Package Drawing	Pins	SPQ	Reel Diameter (mm)	Reel Width W1 (mm)	A0 (mm)	B0 (mm)	K0 (mm)	P1 (mm)	W (mm)	Pin1 Quadrant
INA4290A1IRGVR	VQFN	RGV	16	2500	330.0	12.4	4.25	4.25	1.15	8.0	12.0	Q2
INA4290A1IRGVRG4	VQFN	RGV	16	2500	330.0	12.4	4.25	4.25	1.15	8.0	12.0	Q2
INA4290A2IRGVR	VQFN	RGV	16	2500	330.0	12.4	4.25	4.25	1.15	8.0	12.0	Q2
INA4290A3IRGVR	VQFN	RGV	16	2500	330.0	12.4	4.25	4.25	1.15	8.0	12.0	Q2
INA4290A4IRGVR	VQFN	RGV	16	2500	330.0	12.4	4.25	4.25	1.15	8.0	12.0	Q2
INA4290A5IRGVR	VQFN	RGV	16	2500	330.0	12.4	4.25	4.25	1.15	8.0	12.0	Q2
INA4290A5IRGVT	VQFN	RGV	16	250	180.0	12.4	4.25	4.25	1.15	8.0	12.0	Q2

TAPE AND REEL BOX DIMENSIONS



*All dimensions are nominal

Device	Package Type	Package Drawing	Pins	SPQ	Length (mm)	Width (mm)	Height (mm)
INA2290A1IDGKR	VSSOP	DGK	8	2500	366.0	364.0	50.0
INA2290A1IDGKRG4	VSSOP	DGK	8	2500	366.0	364.0	50.0
INA2290A2IDGKR	VSSOP	DGK	8	2500	366.0	364.0	50.0
INA2290A3IDGKR	VSSOP	DGK	8	2500	366.0	364.0	50.0
INA2290A4IDGKR	VSSOP	DGK	8	2500	366.0	364.0	50.0
INA2290A5IDGKR	VSSOP	DGK	8	2500	366.0	364.0	50.0
INA290A1IDCKR	SC70	DCK	5	3000	183.0	183.0	20.0
INA290A1IDCKRG4	SC70	DCK	5	3000	183.0	183.0	20.0
INA290A2IDCKR	SC70	DCK	5	3000	183.0	183.0	20.0
INA290A2IDCKRG4	SC70	DCK	5	3000	183.0	183.0	20.0
INA290A2IDCKT	SC70	DCK	5	250	183.0	183.0	20.0
INA290A3IDCKR	SC70	DCK	5	3000	183.0	183.0	20.0
INA290A3IDCKRG4	SC70	DCK	5	3000	183.0	183.0	20.0
INA290A3IDCKT	SC70	DCK	5	250	183.0	183.0	20.0
INA290A4IDCKR	SC70	DCK	5	3000	183.0	183.0	20.0
INA290A5IDCKR	SC70	DCK	5	3000	183.0	183.0	20.0
INA4290A1IRGVR	VQFN	RGV	16	2500	367.0	367.0	35.0
INA4290A1IRGVRG4	VQFN	RGV	16	2500	367.0	367.0	35.0

Device	Package Type	Package Drawing	Pins	SPQ	Length (mm)	Width (mm)	Height (mm)
INA4290A2IRGVR	VQFN	RGV	16	2500	367.0	367.0	35.0
INA4290A3IRGVR	VQFN	RGV	16	2500	367.0	367.0	35.0
INA4290A4IRGVR	VQFN	RGV	16	2500	367.0	367.0	35.0
INA4290A5IRGVR	VQFN	RGV	16	2500	367.0	367.0	35.0
INA4290A5IRGVT	VQFN	RGV	16	250	210.0	185.0	35.0

DCK0005A



PACKAGE OUTLINE

SOT - 1.1 max height

SMALL OUTLINE TRANSISTOR



4214834/G 11/2024

NOTES:

1. All linear dimensions are in millimeters. Any dimensions in parenthesis are for reference only. Dimensioning and tolerancing per ASME Y14.5M.
2. This drawing is subject to change without notice.
3. Reference JEDEC MO-203.
4. Support pin may differ or may not be present.
5. Lead width does not comply with JEDEC.
6. Body dimensions do not include mold flash, protrusions, or gate burrs. Mold flash, protrusions, or gate burrs shall not exceed 0.25mm per side

EXAMPLE BOARD LAYOUT

DCK0005A

SOT - 1.1 max height

SMALL OUTLINE TRANSISTOR



LAND PATTERN EXAMPLE
EXPOSED METAL SHOWN
SCALE:18X



SOLDER MASK DETAILS

4214834/G 11/2024

NOTES: (continued)

- 7. Publication IPC-7351 may have alternate designs.
- 8. Solder mask tolerances between and around signal pads can vary based on board fabrication site.

EXAMPLE STENCIL DESIGN

DCK0005A

SOT - 1.1 max height

SMALL OUTLINE TRANSISTOR



SOLDER PASTE EXAMPLE
BASED ON 0.125 THICK STENCIL
SCALE:18X

4214834/G 11/2024

NOTES: (continued)

9. Laser cutting apertures with trapezoidal walls and rounded corners may offer better paste release. IPC-7525 may have alternate design recommendations.
10. Board assembly site may have different recommendations for stencil design.

DGK0008A



PACKAGE OUTLINE

VSSOP - 1.1 mm max height

SMALL OUTLINE PACKAGE



4214862/A 04/2023

NOTES:

PowerPAD is a trademark of Texas Instruments.

1. All linear dimensions are in millimeters. Any dimensions in parenthesis are for reference only. Dimensioning and tolerancing per ASME Y14.5M.
2. This drawing is subject to change without notice.
3. This dimension does not include mold flash, protrusions, or gate burrs. Mold flash, protrusions, or gate burrs shall not exceed 0.15 mm per side.
4. This dimension does not include interlead flash. Interlead flash shall not exceed 0.25 mm per side.
5. Reference JEDEC registration MO-187.

EXAMPLE BOARD LAYOUT

DGK0008A

™ VSSOP - 1.1 mm max height

SMALL OUTLINE PACKAGE



LAND PATTERN EXAMPLE
EXPOSED METAL SHOWN
SCALE: 15X

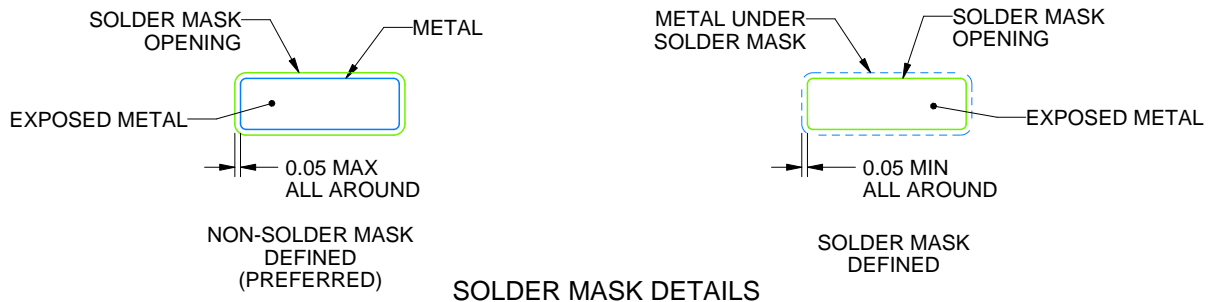

SOLDER MASK DETAILS

4214862/A 04/2023

NOTES: (continued)

6. Publication IPC-7351 may have alternate designs.
7. Solder mask tolerances between and around signal pads can vary based on board fabrication site.
8. Vias are optional depending on application, refer to device data sheet. If any vias are implemented, refer to their locations shown on this view. It is recommended that vias under paste be filled, plugged or tented.
9. Size of metal pad may vary due to creepage requirement.

EXAMPLE STENCIL DESIGN

DGK0008A

TM VSSOP - 1.1 mm max height

SMALL OUTLINE PACKAGE



SOLDER PASTE EXAMPLE
SCALE: 15X

4214862/A 04/2023

NOTES: (continued)

11. Laser cutting apertures with trapezoidal walls and rounded corners may offer better paste release. IPC-7525 may have alternate design recommendations.
12. Board assembly site may have different recommendations for stencil design.

GENERIC PACKAGE VIEW

RGV 16

VQFN - 1 mm max height

4 x 4, 0.65 mm pitch

PLASTIC QUAD FLATPACK - NO LEAD

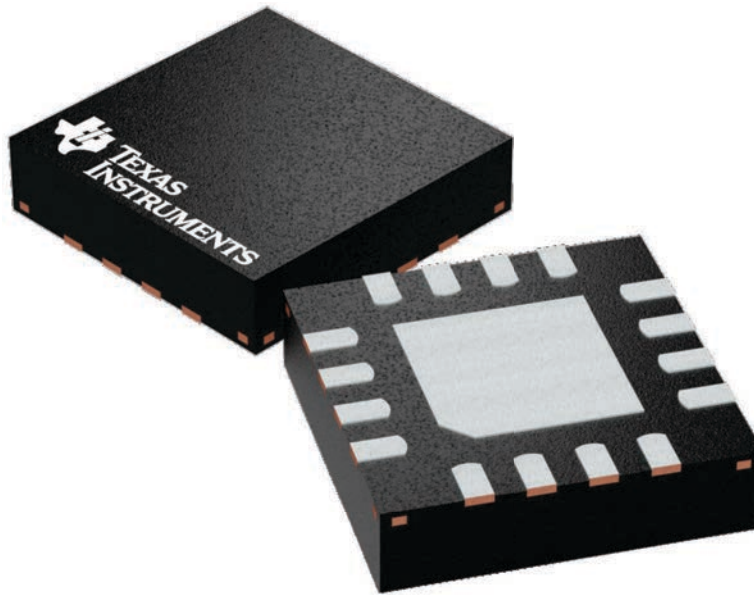

Images above are just a representation of the package family, actual package may vary.
Refer to the product data sheet for package details.

4224748/A

EXAMPLE STENCIL DESIGN

RGV0016A

VQFN - 1 mm max height

PLASTIC QUAD FLATPACK - NO LEAD

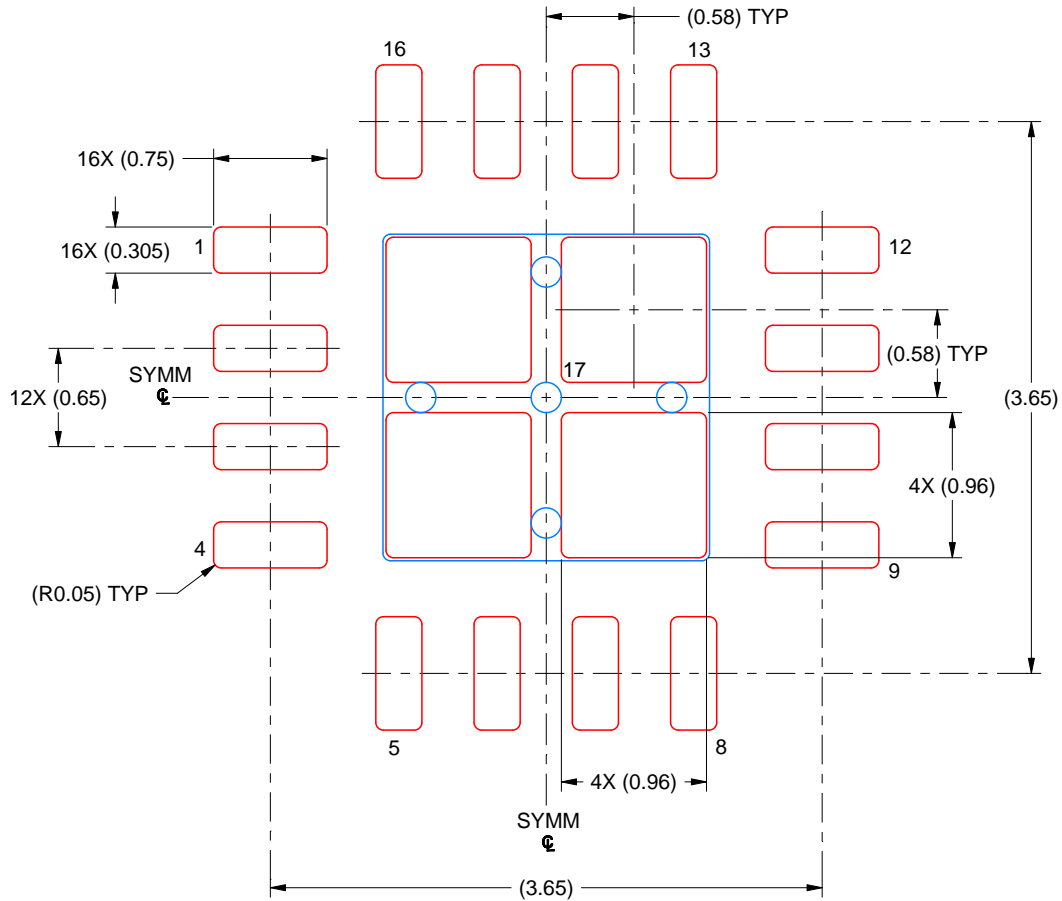

SOLDER PASTE EXAMPLE
BASED ON 0.125 MM THICK STENCIL
SCALE: 20X

EXPOSED PAD 17
79% PRINTED SOLDER COVERAGE BY AREA UNDER PACKAGE

4219037/A 06/2019

NOTES: (continued)

6. Laser cutting apertures with trapezoidal walls and rounded corners may offer better paste release. IPC-7525 may have alternate design recommendations.

IMPORTANT NOTICE AND DISCLAIMER

TI PROVIDES TECHNICAL AND RELIABILITY DATA (INCLUDING DATASHEETS), DESIGN RESOURCES (INCLUDING REFERENCE DESIGNS), APPLICATION OR OTHER DESIGN ADVICE, WEB TOOLS, SAFETY INFORMATION, AND OTHER RESOURCES "AS IS" AND WITH ALL FAULTS, AND DISCLAIMS ALL WARRANTIES, EXPRESS AND IMPLIED, INCLUDING WITHOUT LIMITATION ANY IMPLIED WARRANTIES OF MERCHANTABILITY, FITNESS FOR A PARTICULAR PURPOSE OR NON-INFRINGEMENT OF THIRD PARTY INTELLECTUAL PROPERTY RIGHTS.

These resources are intended for skilled developers designing with TI products. You are solely responsible for (1) selecting the appropriate TI products for your application, (2) designing, validating and testing your application, and (3) ensuring your application meets applicable standards, and any other safety, security, regulatory or other requirements.

These resources are subject to change without notice. TI grants you permission to use these resources only for development of an application that uses the TI products described in the resource. Other reproduction and display of these resources is prohibited. No license is granted to any other TI intellectual property right or to any third party intellectual property right. TI disclaims responsibility for, and you fully indemnify TI and its representatives against any claims, damages, costs, losses, and liabilities arising out of your use of these resources.

TI's products are provided subject to [TI's Terms of Sale](#), [TI's General Quality Guidelines](#), or other applicable terms available either on ti.com or provided in conjunction with such TI products. TI's provision of these resources does not expand or otherwise alter TI's applicable warranties or warranty disclaimers for TI products. Unless TI explicitly designates a product as custom or customer-specified, TI products are standard, catalog, general purpose devices.

TI objects to and rejects any additional or different terms you may propose.

Copyright © 2026, Texas Instruments Incorporated

Last updated 10/2025