

# AFE7950-x 4T6R RF Sampling AFE with 12GSPS DACs and 3GSPS ADCs

## 1 Features

- [Request full data sheet](#)
- Radiation hardness assured AFE7950-SP:
  - Single-event latch up (SEL): 70MeV-cm<sup>2</sup>/mg
  - RLAT Total ionizing dose (TID): 100krad (Si)
- Radiation tolerant AFE7950-SEP:
  - Single-event latch up (SEL): 43MeV-cm<sup>2</sup>/mg
  - RLAT Total ionizing dose (TID): 30krad (Si)
- Four RF sampling 12GSPS TX DACs
- Six RF sampling 3GSPS RX ADCs
- Maximum RF signal bandwidth: 1200MHz (or 2400MHz for 2TX)
- RF frequency range:
  - TX: 600MHz to 12GHz
  - RX: 5MHz to 12GHz
- Digital Step Attenuators (DSA):
  - TX: 40dB range, 0.125dB steps
  - RX or FB: 25dB range, 0.5dB steps
- Single or dual-band DUC or DDCs for TX and RX
- SerDes data interface:
  - 8 SerDes transceivers up to 24.75Gbps
  - JESD204B/C subclass 1 compatible
- Package: 17mm × 17mm FCBGA, 0.8mm pitch
- Space screening and assurance:
  - Meets ASTM E595 outgassing specification (AFE7950-SP, AFE7950-SEP)
  - One fabrication, assembly, and test site
  - Wafer lot traceability
  - Extended product life cycle
  - Radiation lot acceptance test (RLAT) (AFE7950-SP, AFE7950-SEP)
  - Production burn-in (AFE7950-SP)
- This device contains non-encapsulated chip-caps with tin (Sn) finish of >97% purity. See reliability report for more information

## 2 Applications

- [Satellite communications payload downlink](#)
- [Satellite telemetry payload downlink](#)

## 3 Description

The AFE7950-x is a high performance, wide bandwidth multi-channel transceiver, integrating four RF sampling transmitter chains, four RF sampling receiver chains and two RF sampling feedback chains (six RF sampling ADCs total). With operation up to 12GHz, this device enables direct RF sampling in the L, S, C and X-band frequency ranges without the need for additional frequency conversions stages. This improvement in density and flexibility enables high-channel-count, multi-mission systems.

The TX signal paths support interpolation and digital up conversion options that deliver up to 1200MHz of signal bandwidth for four TX or 2400MHz for two TX. The output of the DUCs drives a 12GSPS DAC (digital to analog converter) with a mixed mode output option to enhance 2<sup>nd</sup> Nyquist operation. The DAC output includes a variable gain amplifier (TX DSA) with 40dB range and 1dB analog and 0.125dB digital steps.

Each receiver chain includes a 25dB range Digital Step Attenuator (DSA), followed by a 3GSPS ADC (analog-to-digital converter). Each receiver channel has an analog peak power detector and various digital power detectors to assist an external or internal autonomous automatic gain controller, and RF overload detectors for device reliability protection. Flexible decimation options provide optimization of data bandwidth up to 1200MHz for four RX without FB paths or 600MHz with two FB paths (1200MHz BW each).

### Device Information

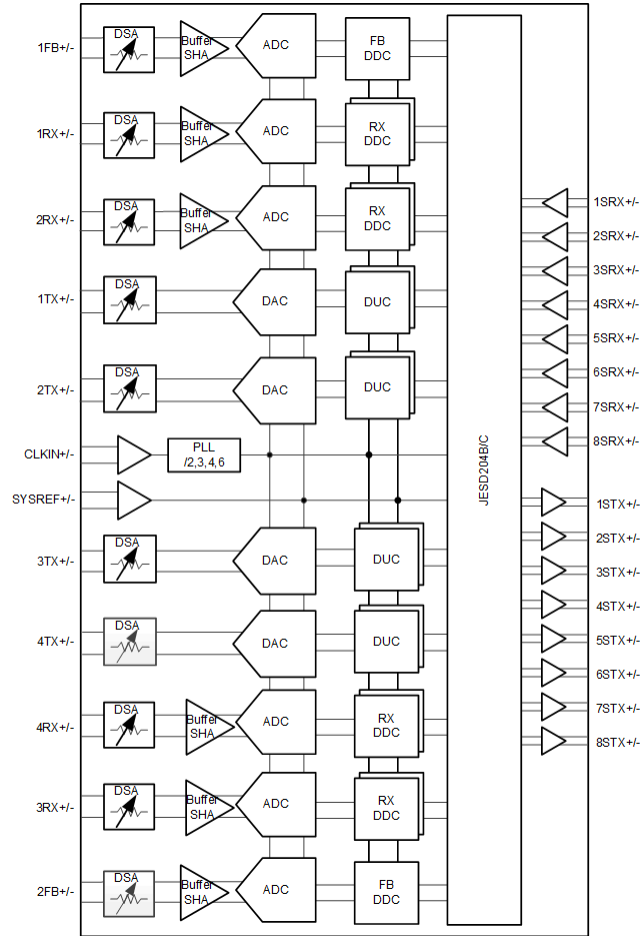
| PART NUMBER               | GRADE                                     | PACKAGE SIZE <sup>(1)</sup><br><sup>(2)</sup> |
|---------------------------|---|---|
| AFE7950-SP                | Radiation-hardness-assured space (RHA)    | 17mm × 17mm plastic substrate                 |
| AFE7950-SEP               | Radiation-tolerant Space Enhanced Product | FC-BGA<br>400 SnPb balls<br>0.8mm pitch       |
| AFE7950-EP <sup>(3)</sup> | Enhanced Product                          |   |

(1) For more information, see [Section 7](#).

(2) The package size (length × width) is a nominal value and includes pins, where applicable.

(3) Product preview





**Functional Block Diagram**

## Table of Contents

|   |    |   |     |
|---|----|---|-----|
| <b>1 Features</b> .....                           | 1  | 4.9 Power Supply Electrical Characteristics.....          | 21  |
| <b>2 Applications</b> .....                       | 1  | 4.10 Timing Requirements.....                             | 27  |
| <b>3 Description</b> .....                        | 1  | 4.11 Switching Characteristics.....                       | 28  |
| <b>4 Specifications</b> .....                     | 4  | 4.12 Typical Characteristics.....                         | 29  |
| 4.1 Absolute Maximum Ratings.....                 | 4  | <b>5 Device and Documentation Support</b> .....           | 123 |
| 4.2 ESD Ratings.....                              | 4  | 5.1 Receiving Notification of Documentation Updates..     | 123 |
| 4.3 Recommended Operating Conditions.....         | 5  | 5.2 Support Resources.....                                | 123 |
| 4.4 Thermal Information.....                      | 5  | 5.3 Trademarks.....                                       | 123 |
| 4.5 Transmitter Electrical Characteristics.....   | 6  | 5.4 Electrostatic Discharge Caution.....                  | 123 |
| 4.6 RF ADC Electrical Characteristics.....        | 13 | 5.5 Glossary.....   | 123 |
| 4.7 PLL/VCO/Clock Electrical Characteristics..... | 18 | <b>6 Revision History</b> .....                           | 123 |
| 4.8 Digital Electrical Characteristics.....       | 20 | <b>7 Mechanical, Packaging, and Orderable Information</b> | 123 |

## 4 Specifications

### 4.1 Absolute Maximum Ratings

over operating free-air temperature range (unless otherwise noted)<sup>(1)</sup>

|                      |  | MIN         | MAX              | UNIT |
|----------------------|--|-------------|------------------|------|
| Supply Voltage Range | DVDD0P9, VDDT0P9   | -0.3        | 1.2              | V    |
|                      | VDD1P2RX, VDD1P2TXCLK, VDD1P2TXENC, VDD1P2PLL, VDD1P2PLLCLKREF, VDD1P2FB, VDD1P2FBCML, VDD1P2RXCML                             | -0.3        | 1.4              | V    |
|                      | VDD1P8RX, VDD1P8RXCLK, VDD1P8TX, VDD1P8TXDAC, VDD1P8TXENC, VDD1P8PLL, VDD1P8PLLVCO, VDD1P8FB, VDD1P8FBCML, VDD1P8GPIO, VDDA1P8 | -0.5        | 2.1              | V    |
| Pin Voltage Range    | {1/2/3/4}RXIN+/-   | -0.5        | VDDR1P8+0.3      | V    |
|                      | 1FBIN+/-, 2FB+/-   | -0.5        | VDDFB1P8+0.3     | V    |
|                      | {1/2/3/4}TXOUT+/-  | -0.5        | VDDTX1P8+0.3     | V    |
|                      | REFCLK+/-, SYSREF+/-   | -0.3        | 1.4              | V    |
|                      | {1:8}SRX+/-  | -0.3        | 1.4              | V    |
|                      | {1:8}STX+/-  | -0.3        | 1.4              | V    |
|                      | GPIO{B/C/D/E}x, SPICLK, SPISDIO, SPISDO, SPISEN, RESETZ, BISTB0, BISTB1  | -0.5        | VDD1P8GPIO + 0.3 | V    |
|                      | IFORCE, VSENSE   | -0.3        | VDDCLK1P8 + 0.3  | V    |
| SRDAMUX1, SRDAMUX2   | -0.3   | VDDA1P8+0.3 | V                |      |
| Peak Input Current   | any input  |             | 20               | mA   |
| T <sub>J</sub>       | Junction temperature   |             | 150              | °C   |
| T <sub>stg</sub>     | Storage temperature  | -65         | 150              | °C   |

- (1) Stresses beyond those listed under *Absolute Maximum Rating* may cause permanent damage to the device. These are stress ratings only, which do not imply functional operation of the device at these or any other conditions beyond those indicated under *Recommended Operating Condition*. Exposure to absolute-maximum-rated conditions for extended periods may affect device reliability.

### 4.2 ESD Ratings

|                    |                         | VALUE  | UNIT |
|--------------------|-------------------------|--|------|
| V <sub>(ESD)</sub> | Electrostatic discharge | Human body model (HBM), per ANSI/ESDA/ JEDEC JS-001, all pins <sup>(1)</sup> | 1000 |
|                    |                         | Charged device model (CDM), per ANSI/ESDA/ JEDEC JS-002, all pins            | 150  |

- (1) JEDEC document JEP155 states that 500-V HBM allows safe manufacturing with a standard ESD control process.

### 4.3 Recommended Operating Conditions

over operating free-air temperature range (unless otherwise noted)

|  |                                | MIN  | NOM   | MAX  | UNIT |
|--|--------------------------------|------|-------|------|------|
| DVDD0P9, VDDT0P9   | Supply voltage 0.9V            | 0.9  | 0.925 | 0.95 | V    |
| VDD1P2{RX/TXCLK/TXENC/FB/PLL/<br>PLLCLKREF/FBCML/RXCML}                  | Supply voltage 1.2V            | 1.15 | 1.2   | 1.25 | V    |
| VDD1P8{RX/RXCLK/TX/TXDAC/<br>TXENC/PLL/PLLCO/FB/FBCLK/<br>GPIO}, VDDA1P8 | Supply voltage 1.8V            | 1.75 | 1.8   | 1.85 | V    |
| T <sub>A</sub>   | Ambient temperature            | -45  |       | 85   | °C   |
| T <sub>J</sub>   | Operating Junction Temperature |      |       | 105  | °C   |

### 4.4 Thermal Information

| THERMAL METRIC <sup>(1)</sup> |  | FC-BGA   | UNIT |
|-------------------------------|--|----------|------|
|                               |  | 400 PINS |      |
| R <sub>θJA</sub>              | Junction-to-ambient thermal resistance       | 15.3     | °C/W |
| R <sub>θJC(top)</sub>         | Junction-to-case (top) thermal resistance    | 0.44     | °C/W |
| R <sub>θJB</sub>              | Junction-to-board thermal resistance         | 4.8      | °C/W |
| Ψ <sub>JB</sub>               | Junction-to-board characterization parameter | 4.5      | °C/W |

- (1) For more information about traditional and new thermal metrics, see the [Semiconductor and IC Package Thermal Metrics](#) application report.

## 4.5 Transmitter Electrical Characteristics

Typical values at  $T_A = +25^\circ\text{C}$ , full temperature range is  $T_{A,\text{MIN}} = -40^\circ\text{C}$  to  $T_{J,\text{MAX}} = +110^\circ\text{C}$ ; TX Input Rate = 491.52MSPS below 6GHz and 1474.56MSPS above 6GHz,  $f_{\text{DAC}} = 11796.48\text{MSPS}$ ; PLL clock mode below 6GHz output frequency and External clock mode above 6GHz output frequency; interleave mode for 1<sup>st</sup> Nyquist, non-interleave mix mode for 2<sup>nd</sup> Nyquist, nominal power supplies; 1 tone at -1 dBFS; DSA Attenuation = 0dB; SerDes rate = 16.22Gbps, unless otherwise noted.

| PARAMETER   |  | TEST CONDITIONS   | MIN | TYP   | MAX | UNIT |
|---|--|---|-----|-------|-----|------|
| DAC <sub>RES</sub>                                | DAC resolution   |   |     | 14    |     | bits |
| F <sub>DAC</sub>                                  | DAC Sample Rate  |   | 9   |       | 12  | GSFS |
| f <sub>RFout_MIN</sub>                            | RF output frequency range                                    | Requires PCB matching based on frequency range  |     | 600   |     | MHz  |
| f <sub>RFout_MAX</sub>                            | RF output frequency range                                    | Requires PCB matching based on frequency range  |     | 12000 |     | MHz  |
| P <sub>max_FS</sub>                               | Max Full Scale Output Power, max gain 1 tone, at device pins | f <sub>out</sub> = 850 MHz, f <sub>DAC</sub> = 5898.24 MSPS, -0.5dBFS                 |     | 4.2   |     | dBm  |
|   |  | f <sub>out</sub> = 1800 MHz, f <sub>DAC</sub> = 5898.24 MSPS, -0.5dBFS                |     | 4.6   |     | dBm  |
|   |  | f <sub>out</sub> = 2600 MHz, f <sub>DAC</sub> = 8847.36 MSPS, -0.5dBFS                |     | 4.0   |     | dBm  |
|   |  | f <sub>out</sub> = 3500 MHz, -0.5dBFS   |     | 3.9   |     | dBm  |
|   |  | f <sub>out</sub> = 4900 MHz, -0.5dBFS   |     | 3.1   |     | dBm  |
|   |  | f <sub>out</sub> = 3500 MHz, f <sub>DAC</sub> = 5898.24 MSPS, -0.5dBFS, straight mode |     | 1.0   |     | dBm  |
|   |  | f <sub>out</sub> = 4900 MHz, f <sub>DAC</sub> = 5898.24 MSPS, -0.5dBFS, straight mode |     | 0.1   |     | dBm  |
|   |  | f <sub>out</sub> = 4900 MHz, f <sub>DAC</sub> = 8847.36 MSPS, -0.5dBFS, straight mode |     | -0.7  |     | dBm  |
|   |  | f <sub>out</sub> = 8100 MHz, -0.1dBFS, mixed mode                                     |     | -2.8  |     | dBm  |
| f <sub>out</sub> = 9600 MHz, -0.1dBFS, mixed mode |  | -4.3  |     | dBm   |     |      |
| R <sub>TERM</sub>                                 | Output termination resistor                                  | Default setting   |     | 50    |     | Ω    |
| ATT <sub>range</sub>                              | DSA Attenuation range  |   |     | 40    |     | dB   |
| ATT <sub>step</sub>                               | DSA Analog Attenuation step                                  |   |     | 1.0   |     | dB   |
|   | DSA Attenuation step accuracy (DNL)                          | 0 < Atten < 40dB, before calibration  |     | ±0.2  |     | dB   |
|   | DSA Attenuation step accuracy (DNL)                          | 0 < Atten < 40dB, after calibration   |     | ±0.1  |     | dB   |
| ATT <sub>phase-err</sub>                          | DSA Gain Steps Phase accuracy, any 8dB range                 | f <sub>out</sub> = 850MHz <sup>(2)</sup>  |     | ±1    |     | deg  |
|   |  | f <sub>out</sub> = 1800MHz <sup>(2)</sup>   |     | ±1    |     | deg  |
|   |  | f <sub>out</sub> = 2600MHz <sup>(2)</sup>   |     | ±1    |     | deg  |
|   |  | f <sub>out</sub> = 3500MHz <sup>(2)</sup>   |     | ±1    |     | deg  |
|   |  | f <sub>out</sub> = 4900MHz <sup>(2)</sup>   |     | ±1    |     | deg  |
|   |  | f <sub>out</sub> = 8100MHz <sup>(2)</sup>   |     | ±2    |     | deg  |
|   |  | f <sub>out</sub> = 9600MHz <sup>(2)</sup>   |     | ±2    |     | deg  |
| G <sub>flat</sub>                                 | Gain flatness  | any 20MHz   |     | 0.1   |     | dB   |
|   |  | 600MHz BW, F <sub>out</sub> < 4.9G  |     | 1.2   |     |      |

Typical values at  $T_A = +25^\circ\text{C}$ , full temperature range is  $T_{A,\text{MIN}} = -40^\circ\text{C}$  to  $T_{J,\text{MAX}} = +110^\circ\text{C}$ ; TX Input Rate = 491.52MSPS below 6GHz and 1474.56MSPS above 6GHz,  $f_{\text{DAC}} = 11796.48\text{MSPS}$ ; PLL clock mode below 6GHz output frequency and External clock mode above 6GHz output frequency; interleave mode for 1<sup>st</sup> Nyquist, non-interleave mix mode for 2<sup>nd</sup> Nyquist, nominal power supplies; 1 tone at -1 dBFS; DSA Attenuation = 0dB; SerDes rate = 16.22Gbps, unless otherwise noted.

| PARAMETER   |   | TEST CONDITIONS  | MIN | TYP | MAX | UNIT |
|---|---|--|-----|-----|-----|------|
| IMD3  | 3rd Order Intermodulation distortion, 2 tones at $f_{\text{IF}} \pm 10$ MHz | $f_{\text{out}} = 850\text{MHz}$ , -7dBFS each tone            |     | -66 |     | dBc  |
|   |   | $f_{\text{out}} = 1800\text{MHz}$ , -7dBFS each tone           |     | -63 |     | dBc  |
|   |   | $f_{\text{out}} = 2600\text{MHz}$ , -7dBFS each tone           |     | -62 |     | dBc  |
|   |   | $f_{\text{out}} = 3500\text{MHz}$ , -7dBFS each tone           |     | -61 |     | dBc  |
|   |   | $f_{\text{out}} = 4900\text{MHz}$ , -7dBFS each tone           |     | -57 |     | dBc  |
|   |   | $f_{\text{out}} = 8100\text{MHz}$ , -7dBFS each tone           |     | -55 |     | dBc  |
|   |   | $f_{\text{out}} = 9600\text{MHz}$ , -7dBFS each tone           |     | -52 |     | dBc  |
|   |   | $f_{\text{out}} = 850\text{MHz}$ , -13dBFS each tone           |     | -74 |     | dBc  |
|   |   | $f_{\text{out}} = 1800\text{MHz}$ , -13dBFS each tone          |     | -71 |     | dBc  |
|   |   | $f_{\text{out}} = 2501\text{MHz}$ , -12dBFS each tone          |     | -67 | -60 | dBc  |
|   |   | $f_{\text{out}} = 2600\text{MHz}$ , -13dBFS each tone          |     | -73 |     | dBc  |
|   |   | $f_{\text{out}} = 3500\text{MHz}$ , -13dBFS each tone          |     | -72 |     | dBc  |
|   |   | $f_{\text{out}} = 4900\text{MHz}$ , -13dBFS each tone          |     | -68 |     | dBc  |
|   |   | $f_{\text{out}} = 8100\text{MHz}$ , -13dBFS each tone          |     | -64 |     | dBc  |
| $f_{\text{out}} = 9600\text{MHz}$ , -13dBFS each tone |   | -68  |     | dBc |     |      |
| SFDR  | Spurious Free Dynamic Range (within Nyquist zone)                           | $f_{\text{out}} = 850$ MHz                                     |     | 51  |     | dBc  |
|   |   | $f_{\text{out}} = 1800$ MHz                                    |     | 52  |     | dBc  |
|   |   | $f_{\text{out}} = 2600$ MHz                                    |     | 42  |     | dBc  |
|   |   | $f_{\text{out}} = 3500$ MHz                                    |     | 44  |     | dBc  |
|   |   | $f_{\text{out}} = 4900$ MHz                                    |     | 46  |     | dBc  |
| $f_{\text{s}}/2 - f_{\text{OUT}}$                     | Interleaving Image  | $f_{\text{DAC}} = 5898.24\text{MSPS}$ , interleave mode        |     | -52 |     | dBc  |
|   |   | $f_{\text{DAC}} = 8847.36$ MSPS, interleave mode               |     | -46 |     | dBc  |
|   |   | $f_{\text{DAC}} = 11796.48\text{MSPS}$ , interleave mode       |     | -42 |     | dBc  |
| HD2   | 2nd Harmonic Distortion (within Nyquist zone)                               | $f_{\text{out}} = 850$ MHz                                     |     | -49 |     | dBc  |
|   |   | $f_{\text{out}} = 1800$ MHz                                    |     | -53 |     | dBc  |
|   |   | $f_{\text{out}} = 2600$ MHz                                    |     | -50 |     | dBc  |
|   |   | $f_{\text{out}} = 3500$ MHz                                    |     | -48 |     | dBc  |
|   |   | $f_{\text{out}} = 4900$ MHz                                    |     | -47 |     | dBc  |
|   |   | $f_{\text{out}} = 8100$ MHz                                    |     | -50 |     | dBc  |
|   |   | $f_{\text{out}} = 9600$ MHz                                    |     | -53 |     | dBc  |
|   |   | $f_{\text{out}} = 850$ MHz, $A_{\text{OUT}} = -12\text{dBFS}$  |     | -60 |     | dBc  |
|   |   | $f_{\text{out}} = 1800$ MHz, $A_{\text{OUT}} = -12\text{dBFS}$ |     | -64 |     | dBc  |
|   |   | $f_{\text{out}} = 2600$ MHz, $A_{\text{OUT}} = -12\text{dBFS}$ |     | -45 |     | dBc  |
|   |   | $f_{\text{out}} = 3500$ MHz, $A_{\text{OUT}} = -12\text{dBFS}$ |     | -57 |     | dBc  |
|   |   | $f_{\text{out}} = 4900$ MHz, $A_{\text{OUT}} = -12\text{dBFS}$ |     | -58 |     | dBc  |
|   |   | $f_{\text{out}} = 8100$ MHz, $A_{\text{OUT}} = -12\text{dBFS}$ |     | -60 |     | dBc  |
|   |   | $f_{\text{out}} = 9600$ MHz, $A_{\text{OUT}} = -12\text{dBFS}$ |     | -62 |     | dBc  |

**AFE7950-SP, AFE7950-SEP**

SBASAG7B – MARCH 2024 – REVISED JUNE 2026

Typical values at  $T_A = +25^\circ\text{C}$ , full temperature range is  $T_{A,\text{MIN}} = -40^\circ\text{C}$  to  $T_{J,\text{MAX}} = +110^\circ\text{C}$ ; TX Input Rate = 491.52MSPS below 6GHz and 1474.56MSPS above 6GHz,  $f_{\text{DAC}} = 11796.48\text{MSPS}$ ; PLL clock mode below 6GHz output frequency and External clock mode above 6GHz output frequency; interleave mode for 1<sup>st</sup> Nyquist, non-interleave mix mode for 2<sup>nd</sup> Nyquist, nominal power supplies; 1 tone at -1 dBFS; DSA Attenuation = 0dB; SerDes rate = 16.22Gbps, unless otherwise noted.

| PARAMETER  |  | TEST CONDITIONS  | MIN | TYP | MAX | UNIT |
|--|--|--|-----|-----|-----|------|
| HD3  | 3rd Harmonic Distortion (within Nyquist zone)    | $f_{\text{out}} = 850 \text{ MHz}$                                   |     | -62 |     | dBc  |
|  |  | $f_{\text{out}} = 1800 \text{ MHz}$                                  |     | -55 |     | dBc  |
|  |  | $f_{\text{out}} = 2600 \text{ MHz}$                                  |     | -57 |     | dBc  |
|  |  | $f_{\text{out}} = 3500 \text{ MHz}$                                  |     | -60 |     | dBc  |
|  |  | $f_{\text{out}} = 4900 \text{ MHz}$                                  |     | -54 |     | dBc  |
|  |  | $f_{\text{out}} = 8100 \text{ MHz}$                                  |     | -54 |     | dBc  |
|  |  | $f_{\text{out}} = 9600 \text{ MHz}$                                  |     | -56 |     | dBc  |
|  |  | $f_{\text{out}} = 850 \text{ MHz}, A_{\text{OUT}} = -12\text{dBFS}$  |     | -80 |     | dBc  |
|  |  | $f_{\text{out}} = 1800 \text{ MHz}, A_{\text{OUT}} = -12\text{dBFS}$ |     | -79 |     | dBc  |
|  |  | $f_{\text{out}} = 2600 \text{ MHz}, A_{\text{OUT}} = -12\text{dBFS}$ |     | -77 |     | dBc  |
|  |  | $f_{\text{out}} = 3500 \text{ MHz}, A_{\text{OUT}} = -12\text{dBFS}$ |     | -77 |     | dBc  |
|  |  | $f_{\text{out}} = 4900 \text{ MHz}, A_{\text{OUT}} = -12\text{dBFS}$ |     | -78 |     | dBc  |
|  |  | $f_{\text{out}} = 8100 \text{ MHz}, A_{\text{OUT}} = -12\text{dBFS}$ |     | -82 |     | dBc  |
| $f_{\text{out}} = 9600 \text{ MHz}, A_{\text{OUT}} = -12\text{dBFS}$ |  | -80  |     | dBc |     |      |
| HDn, n >= 4  | Harmonic Distortion n >= 4 (within Nyquist zone) | $f_{\text{out}} = 850 \text{ MHz}$                                   |     | -81 |     | dBc  |
|  |  | $f_{\text{out}} = 1800 \text{ MHz}$                                  |     | -88 |     | dBc  |
|  |  | $f_{\text{out}} = 2600 \text{ MHz}$                                  |     | -86 |     | dBc  |
|  |  | $f_{\text{out}} = 3500 \text{ MHz}$                                  |     | -79 |     | dBc  |
|  |  | $f_{\text{out}} = 4900 \text{ MHz}$                                  |     | -86 |     | dBc  |
|  |  | $f_{\text{out}} = 8100 \text{ MHz}$                                  |     | -87 |     | dBc  |
|  |  | $f_{\text{out}} = 9600 \text{ MHz}$                                  |     | -85 |     | dBc  |
|  |  | $f_{\text{out}} = 850 \text{ MHz}, A_{\text{OUT}} = -12\text{dBFS}$  |     | -93 |     | dBc  |
|  |  | $f_{\text{out}} = 1800 \text{ MHz}, A_{\text{OUT}} = -12\text{dBFS}$ |     | -98 |     | dBc  |
|  |  | $f_{\text{out}} = 2600 \text{ MHz}, A_{\text{OUT}} = -12\text{dBFS}$ |     | -84 |     | dBc  |
|  |  | $f_{\text{out}} = 3500 \text{ MHz}, A_{\text{OUT}} = -12\text{dBFS}$ |     | -87 |     | dBc  |
|  |  | $f_{\text{out}} = 4900 \text{ MHz}, A_{\text{OUT}} = -12\text{dBFS}$ |     | -87 |     | dBc  |
|  |  | $f_{\text{out}} = 8100 \text{ MHz}, A_{\text{OUT}} = -12\text{dBFS}$ |     | -87 |     | dBc  |
| $f_{\text{out}} = 9600 \text{ MHz}, A_{\text{OUT}} = -12\text{dBFS}$ |  | -87  |     | dBc |     |      |
| SFDR +/- 250 MHz   | Spurious Free Dynamic Range within +/- 250 MHz   | $f_{\text{out}} = 850 \text{ MHz}$                                   |     | 69  |     | dBc  |
|  |  | $f_{\text{out}} = 1800 \text{ MHz}$                                  |     | 79  |     | dBc  |
|  |  | $f_{\text{out}} = 2600 \text{ MHz}$                                  |     | 77  |     | dBc  |
|  |  | $f_{\text{out}} = 3500 \text{ MHz}$                                  |     | 75  |     | dBc  |
|  |  | $f_{\text{out}} = 4900 \text{ MHz}$                                  |     | 76  |     | dBc  |
|  |  | $f_{\text{out}} = 8100 \text{ MHz}$                                  |     | 61  |     | dBc  |
|  |  | $f_{\text{out}} = 9600 \text{ MHz}$                                  |     | 64  |     | dBc  |
| $f_s/4$  | Fixed Spur                                       | $f_{\text{DAC}} = 5898.24\text{MSPS}$                                |     | -64 |     | dBFS |
|  |  | $f_{\text{DAC}} = 8847.36\text{MSPS}$                                |     | -75 |     | dBFS |
|  |  | $f_{\text{DAC}} = 11796.48\text{MSPS}$                               |     | -67 |     | dBFS |
| $f_s/2$  | Fixed Spur                                       | $f_{\text{DAC}} = 5898.24\text{MSPS}$                                |     | -49 |     | dBFS |
|  |  | $f_{\text{DAC}} = 8847.36\text{MSPS}$                                |     | -48 |     | dBFS |
|  |  | $f_{\text{DAC}} = 11796.48 \text{ MSPS}$                             |     | -48 |     | dBFS |

Typical values at  $T_A = +25^\circ\text{C}$ , full temperature range is  $T_{A,\text{MIN}} = -40^\circ\text{C}$  to  $T_{J,\text{MAX}} = +110^\circ\text{C}$ ; TX Input Rate = 491.52MSPS below 6GHz and 1474.56MSPS above 6GHz,  $f_{\text{DAC}} = 11796.48\text{MSPS}$ ; PLL clock mode below 6GHz output frequency and External clock mode above 6GHz output frequency; interleave mode for 1<sup>st</sup> Nyquist, non-interleave mix mode for 2<sup>nd</sup> Nyquist, nominal power supplies; 1 tone at -1 dBFS; DSA Attenuation = 0dB; SerDes rate = 16.22Gbps, unless otherwise noted.

| PARAMETER              |   | TEST CONDITIONS                              | MIN | TYP   | MAX | UNIT |
|------------------------|---|--|-----|-------|-----|------|
| 3*f <sub>S</sub> /4    | Fixed Spur  | 2nd Nyquist, f <sub>DAC</sub> = 5898.24MSPS  |     | -76   |     | dBFS |
|                        |   | 2nd Nyquist, f <sub>DAC</sub> = 8847.36MSPS  |     | -89   |     | dBFS |
|                        |   | 2nd Nyquist, f <sub>DAC</sub> = 11796.48MSPS |     | -63   |     | dBFS |
| ACPR <sub>1xcarr</sub> | ACPR - 1 carrier, LTE 20MHz E-TM1.1 carrier f <sub>out</sub> = 0.85 GHz   | Atten=0dB, Pout=-13dBFS                      |     | -68.5 |     | dBc  |
|                        |   | Atten=20dB, Pout=-13dBFS                     |     | -67.2 |     | dBc  |
|                        |   | Atten=28dB, Pout=-13dBFS                     |     | -64.5 |     | dBc  |
|                        |   | Atten=39dB, Pout=-13dBFS                     |     | -53.9 |     | dBc  |
| ACPR <sub>1xcarr</sub> | ACPR - 1 carrier, LTE 20MHz E-TM1.1 carrier f <sub>out</sub> = 1.8425 GHz | Atten=0dB, Pout=-13dBFS                      |     | -70.7 |     | dBc  |
|                        |   | Atten=20dB, Pout=-13dBFS                     |     | -68.3 |     | dBc  |
|                        |   | Atten=28dB, Pout=-13dBFS                     |     | -62.9 |     | dBc  |
|                        |   | Atten=39dB, Pout=-13dBFS                     |     | -52.0 |     | dBc  |
| ACPR <sub>1xcarr</sub> | ACPR - 1 carrier, LTE 20MHz E-TM1.1 carrier f <sub>out</sub> = 2.6 GHz    | Atten=0dB, Pout=-13dBFS                      |     | -71   |     | dBc  |
|                        |   | Atten=20dB, Pout=-13dBFS                     |     | -68   |     | dBc  |
|                        |   | Atten=28dB, Pout=-13dBFS                     |     | -62   |     | dBc  |
|                        |   | Atten=39dB, Pout=-13dBFS                     |     | -51.3 |     | dBc  |
| ACPR <sub>1xcarr</sub> | ACPR - 1 carrier, LTE 20MHz E-TM1.1 carrier f <sub>out</sub> = 3.5 GHz    | Atten=0dB, Pout=-13dBFS                      |     | -70   |     | dBc  |
|                        |   | Atten=20dB, Pout=-13dBFS                     |     | -67   |     | dBc  |
|                        |   | Atten=28dB, Pout=-13dBFS                     |     | -60   |     | dBc  |
|                        |   | Atten=39dB, Pout=-13dBFS                     |     | -49.8 |     | dBc  |
| ACPR <sub>1xcarr</sub> | ACPR - 1 carrier, LTE 20MHz E-TM1.1 carrier f <sub>out</sub> = 4.9 GHz    | Atten=0dB, Pout=-13dBFS                      |     | -68.8 |     | dBc  |
|                        |   | Atten=20dB, Pout=-13dBFS                     |     | -65.9 |     | dBc  |
|                        |   | Atten=28dB, Pout=-13dBFS                     |     | -60.6 |     | dBc  |
|                        |   | Atten=39dB, Pout=-13dBFS                     |     | -49.5 |     | dBc  |
| ACPR <sub>1xcarr</sub> | ACPR - 1 carrier, NR 100MHz E-TM1.1 carrier f <sub>out</sub> = 2.6 GHz    | Atten=0dB, Pout=-13dBFS                      |     | -65   |     | dBc  |
|                        |   | Atten=20dB, Pout=-13dBFS                     |     | -62   |     | dBc  |
|                        |   | Atten=20dB, Pout=-13dBFS                     |     | -55   |     | dBc  |
|                        |   | Atten=39dB, Pout=-13dBFS                     |     | -44.3 |     | dBc  |
| ACPR <sub>1xcarr</sub> | ACPR - 1 carrier, NR 100MHz E-TM1.1 carrier f <sub>out</sub> = 3.5 GHz    | Atten=0dB, Pout=-13dBFS                      |     | -64   |     | dBc  |
|                        |   | Atten=20dB, Pout=-13dBFS                     |     | -59   |     | dBc  |
|                        |   | Atten=28dB, Pout=-13dBFS                     |     | -52   |     | dBc  |
|                        |   | Atten=39dB, Pout=-13dBFS                     |     | -41.1 |     | dBc  |
| ACPR <sub>1xcarr</sub> | ACPR - 1 carrier, NR 100MHz E-TM1.1 carrier f <sub>out</sub> = 4.9 GHz    | Atten=0dB, Pout=-13dBFS                      |     | -64.1 |     | dBc  |
|                        |   | Atten=20dB, Pout=-13dBFS                     |     | -60.4 |     | dBc  |
|                        |   | Atten=28dB, Pout=-13dBFS                     |     | -53.5 |     | dBc  |
|                        |   | Atten=39dB, Pout=-13dBFS                     |     | -42.5 |     | dBc  |
| ACPR <sub>1xcarr</sub> | ACPR - 1 carrier, NR 100MHz E-TM1.1 carrier f <sub>out</sub> = 8.1 GHz    | Atten=0dB, Pout=-13dBFS                      |     | -58   |     | dBc  |
|                        |   | Atten=20dB, Pout=-13dBFS                     |     | -53   |     | dBc  |
|                        |   | Atten=28dB, Pout=-13dBFS                     |     | -46   |     | dBc  |
|                        |   | Atten=39dB, Pout=-13dBFS                     |     | -36   |     | dBc  |
| ACPR <sub>1xcarr</sub> | ACPR - 1 carrier, NR 100MHz E-TM1.1 carrier f <sub>out</sub> = 9.6 GHz    | Atten=0dB, Pout=-13dBFS                      |     | -57   |     | dBc  |
|                        |   | Atten=20dB, Pout=-13dBFS                     |     | -50   |     | dBc  |
|                        |   | Atten=28dB, Pout=-13dBFS                     |     | -42   |     | dBc  |
|                        |   | Atten=39dB, Pout=-13dBFS                     |     | -31   |     | dBc  |

**AFE7950-SP, AFE7950-SEP**

SBASAG7B – MARCH 2024 – REVISED JUNE 2026

Typical values at  $T_A = +25^\circ\text{C}$ , full temperature range is  $T_{A,\text{MIN}} = -40^\circ\text{C}$  to  $T_{J,\text{MAX}} = +110^\circ\text{C}$ ; TX Input Rate = 491.52MSPS below 6GHz and 1474.56MSPS above 6GHz,  $f_{\text{DAC}} = 11796.48\text{MSPS}$ ; PLL clock mode below 6GHz output frequency and External clock mode above 6GHz output frequency; interleave mode for 1<sup>st</sup> Nyquist, non-interleave mix mode for 2<sup>nd</sup> Nyquist, nominal power supplies; 1 tone at -1 dBFS; DSA Attenuation = 0dB; SerDes rate = 16.22Gbps, unless otherwise noted.

| PARAMETER           |   | TEST CONDITIONS  | MIN | TYP  | MAX | UNIT        |
|---------------------|---|--|-----|------|-----|-------------|
| EVM                 | Error Vector Magnitude, 1x 20MHz E-TM3.1/3.1a, no ref. clock noise        | $F_{\text{out}} = 0.85\text{ GHz}$ , $P_{\text{OUT}} = -13\text{dBFS}$                   |     | 0.16 |     | %           |
|                     |   | $F_{\text{out}} = 1.8425\text{ GHz}$ , $P_{\text{OUT}} = -13\text{dBFS}$                 |     | 0.29 |     | %           |
|                     |   | $F_{\text{out}} = 2.6\text{ GHz}$ , $P_{\text{OUT}} = -13\text{dBFS}$                    |     | 0.28 |     | %           |
|                     |   | $F_{\text{out}} = 3.5\text{ GHz}$ , $P_{\text{OUT}} = -13\text{dBFS}$                    |     | 0.38 |     | %           |
|                     |   | $F_{\text{out}} = 4.9\text{ GHz}$ , $P_{\text{OUT}} = -13\text{dBFS}$                    |     | 0.43 |     | %           |
| NSD <sub>dBFS</sub> | Noise Spectral Density 20MHz offset<br>$f_{\text{OUT}} = 0.85\text{ GHz}$ | Atten=0dB, $f_{\text{DAC}} = 5898.24\text{MSPS}$ ,<br>$P_{\text{out}} = -13\text{dBFS}$  |     | -156 |     | dBFS/<br>Hz |
|                     |   | Atten=20dB, $f_{\text{DAC}} = 5898.24\text{MSPS}$ ,<br>$P_{\text{out}} = -13\text{dBFS}$ |     | -151 |     | dBFS/<br>Hz |
|                     |   | Atten=28dB, $f_{\text{DAC}} = 5898.24\text{MSPS}$ ,<br>$P_{\text{out}} = -13\text{dBFS}$ |     | -145 |     | dBFS/<br>Hz |
|                     |   | Atten=39dB, $f_{\text{DAC}} = 5898.24\text{MSPS}$ ,<br>$P_{\text{out}} = -13\text{dBFS}$ |     | -134 |     | dBFS/<br>Hz |
| NSD <sub>dBFS</sub> | Noise Spectral Density 20MHz offset<br>$f_{\text{OUT}} = 1.8\text{ GHz}$  | Atten=0dB, $f_{\text{DAC}} = 5898.24\text{MSPS}$ ,<br>$P_{\text{out}} = -13\text{dBFS}$  |     | -158 |     | dBFS/<br>Hz |
|                     |   | Atten=20dB, $f_{\text{DAC}} = 5898.24\text{MSPS}$ ,<br>$P_{\text{out}} = -13\text{dBFS}$ |     | -152 |     | dBFS/<br>Hz |
|                     |   | Atten=28dB, $f_{\text{DAC}} = 5898.24\text{MSPS}$ ,<br>$P_{\text{out}} = -13\text{dBFS}$ |     | -146 |     | dBFS/<br>Hz |
|                     |   | Atten=39dB, $f_{\text{DAC}} = 5898.24\text{MSPS}$ ,<br>$P_{\text{out}} = -13\text{dBFS}$ |     | -135 |     | dBFS/<br>Hz |
| NSD <sub>dBFS</sub> | Noise Spectral Density 20MHz offset<br>$f_{\text{OUT}} = 2.6\text{ GHz}$  | Atten=0dB, $f_{\text{DAC}} = 8847.36\text{MSPS}$ ,<br>$P_{\text{out}} = -13\text{dBFS}$  |     | -157 |     | dBFS/<br>Hz |
|                     |   | Atten=20dB, $f_{\text{DAC}} = 8847.36\text{MSPS}$ ,<br>$P_{\text{out}} = -13\text{dBFS}$ |     | -151 |     | dBFS/<br>Hz |
|                     |   | Atten=28dB, $f_{\text{DAC}} = 8847.36\text{MSPS}$ ,<br>$P_{\text{out}} = -13\text{dBFS}$ |     | -144 |     | dBFS/<br>Hz |
|                     |   | Atten=39dB, $f_{\text{DAC}} = 8847.36\text{MSPS}$ ,<br>$P_{\text{out}} = -13\text{dBFS}$ |     | -133 |     | dBFS/<br>Hz |
| NSD <sub>dBFS</sub> | Noise Spectral Density 20MHz offset<br>$F_{\text{out}} = 3.5\text{ GHz}$  | Atten=0dB, $P_{\text{out}} = -13\text{dBFS}$   |     | -158 |     | dBFS/<br>Hz |
|                     |   | Atten=20dB, $P_{\text{out}} = -13\text{dBFS}$  |     | -150 |     | dBFS/<br>Hz |
|                     |   | Atten=28dB, $P_{\text{out}} = -13\text{dBFS}$  |     | -143 |     | dBFS/<br>Hz |
|                     |   | Atten=39dB, $P_{\text{out}} = -13\text{dBFS}$  |     | -132 |     | dBFS/<br>Hz |
| NSD <sub>dBFS</sub> | Noise Spectral Density 20MHz offset<br>$F_{\text{out}} = 4.9\text{ GHz}$  | Atten=0dB, $P_{\text{out}} = -13\text{dBFS}$   |     | -155 |     | dBFS/<br>Hz |
|                     |   | Atten=20dB, $P_{\text{out}} = -13\text{dBFS}$  |     | -148 |     | dBFS/<br>Hz |
|                     |   | Atten=28dB, $P_{\text{out}} = -13\text{dBFS}$  |     | -141 |     | dBFS/<br>Hz |
|                     |   | Atten=39dB, $P_{\text{out}} = -13\text{dBFS}$  |     | -130 |     | dBFS/<br>Hz |

Typical values at  $T_A = +25^\circ\text{C}$ , full temperature range is  $T_{A,\text{MIN}} = -40^\circ\text{C}$  to  $T_{J,\text{MAX}} = +110^\circ\text{C}$ ; TX Input Rate = 491.52MSPS below 6GHz and 1474.56MSPS above 6GHz,  $f_{\text{DAC}} = 11796.48\text{MSPS}$ ; PLL clock mode below 6GHz output frequency and External clock mode above 6GHz output frequency; interleave mode for 1<sup>st</sup> Nyquist, non-interleave mix mode for 2<sup>nd</sup> Nyquist, nominal power supplies; 1 tone at -1 dBFS; DSA Attenuation = 0dB; SerDes rate = 16.22Gbps, unless otherwise noted.

| PARAMETER           |  | TEST CONDITIONS  | MIN | TYP  | MAX | UNIT        |
|---------------------|--|--|-----|------|-----|-------------|
| NSD <sub>dBFS</sub> | Noise Spectral Density 50MHz offset<br>$F_{\text{out}} = 8.1\text{ GHz}$ | Atten=0dB, Pout=-13dBFS  |     | -149 |     | dBFS/<br>Hz |
|                     |  | Atten=20dB, Pout=-13dBFS   |     | -147 |     | dBFS/<br>Hz |
|                     |  | Atten=28dB, Pout=-13dBFS   |     | -141 |     | dBFS/<br>Hz |
|                     |  | Atten=39dB, Pout=-13dBFS   |     | -130 |     | dBFS/<br>Hz |
| NSD <sub>dBFS</sub> | Noise Spectral Density 50MHz offset<br>$F_{\text{out}} = 9.6\text{ GHz}$ | Atten=0dB, Pout=-13dBFS  |     | -148 |     | dBFS/<br>Hz |
|                     |  | Atten=20dB, Pout=-13dBFS   |     | -144 |     | dBFS/<br>Hz |
|                     |  | Atten=28dB, Pout=-13dBFS   |     | -137 |     | dBFS/<br>Hz |
|                     |  | Atten=39dB, Pout=-13dBFS   |     | -126 |     | dBFS/<br>Hz |
| S22                 | Output Return Loss, <6GHz, +/- fc * 10%                                  | with matching  |     | -17  |     | dB          |
|                     | Output Return Loss, >8GHz, +/- fc * 10%                                  | with matching  |     | -13  |     | dB          |
| Isolation           | Near Channel:<br>1TXOUT to 2TXOUT or 3TXOUT to 4TXOUT <sup>(1)</sup>     | $f_{\text{out}} = 900\text{ MHz}$ , $f_{\text{DAC}} = 8847.36\text{MSPS}$ , straight mode  |     | -49  |     | dB          |
|                     |  | $f_{\text{out}} = 1850\text{ MHz}$ , $f_{\text{DAC}} = 8847.36\text{MSPS}$ , straight mode |     | -59  |     | dB          |
|                     |  | $f_{\text{out}} = 2600\text{ MHz}$ , $f_{\text{DAC}} = 8847.36\text{MSPS}$ , straight mode |     | -64  |     | dB          |
|                     |  | $f_{\text{out}} = 3500\text{ MHz}$ , $f_{\text{DAC}} = 8847.36\text{MSPS}$ , straight mode |     | -66  |     | dB          |
|                     |  | $f_{\text{out}} = 4900\text{ MHz}$ , $f_{\text{DAC}} = 8847.36\text{MSPS}$ , straight mode |     | -60  |     | dB          |
|                     |  | $f_{\text{out}} = 900\text{ MHz}$ , $f_{\text{DAC}} = 8847.36\text{MSPS}$ , straight mode  |     | -90  |     | dB          |
|                     |  | $f_{\text{out}} = 1850\text{ MHz}$ , $f_{\text{DAC}} = 8847.36\text{MSPS}$ , straight mode |     | -91  |     | dB          |
|                     |  | $f_{\text{out}} = 2600\text{ MHz}$ , $f_{\text{DAC}} = 8847.36\text{MSPS}$ , straight mode |     | -93  |     | dB          |
|                     |  | $f_{\text{out}} = 3500\text{ MHz}$ , $f_{\text{DAC}} = 8847.36\text{MSPS}$ , straight mode |     | -94  |     | dB          |
|                     |  | $f_{\text{out}} = 4900\text{ MHz}$ , $f_{\text{DAC}} = 8847.36\text{MSPS}$ , straight mode |     | -83  |     | dB          |
|                     |  | $f_{\text{out}} = 8100\text{ MHz}$   |     | -47  |     | dB          |
|                     |  | $f_{\text{out}} = 9600\text{ MHz}$   |     | -60  |     | dB          |
|                     | Far Channel:<br>1/2TXOUT to 3/4TXOUT                                     | $f_{\text{out}} = 8100\text{ MHz}$   |     | -80  |     | dB          |

Typical values at  $T_A = +25^\circ\text{C}$ , full temperature range is  $T_{A,\text{MIN}} = -40^\circ\text{C}$  to  $T_{J,\text{MAX}} = +110^\circ\text{C}$ ; TX Input Rate = 491.52MSPS below 6GHz and 1474.56MSPS above 6GHz,  $f_{\text{DAC}} = 11796.48\text{MSPS}$ ; PLL clock mode below 6GHz output frequency and External clock mode above 6GHz output frequency; interleave mode for 1<sup>st</sup> Nyquist, non-interleave mix mode for 2<sup>nd</sup> Nyquist, nominal power supplies; 1 tone at -1 dBFS; DSA Attenuation = 0dB; SerDes rate = 16.22Gbps, unless otherwise noted.

| PARAMETER           |   | TEST CONDITIONS   | MIN | TYP  | MAX | UNIT   |
|---------------------|---|---|-----|------|-----|--------|
| PN <sub>TXADD</sub> | Additive Phase Noise External Clock Mode <sup>(3)</sup> | $f_{\text{out}} = 9.6\text{GHz}, f_{\text{OFFSET}} = 100\text{Hz}$  |     | -88  |     | dBc/Hz |
|                     |   | $f_{\text{out}} = 9.6\text{GHz}, f_{\text{OFFSET}} = 1\text{kHz}$   |     | -102 |     | dBc/Hz |
|                     |   | $f_{\text{out}} = 9.6\text{GHz}, f_{\text{OFFSET}} = 10\text{kHz}$  |     | -110 |     | dBc/Hz |
|                     |   | $f_{\text{out}} = 9.6\text{GHz}, f_{\text{OFFSET}} = 100\text{kHz}$ |     | -123 |     | dBc/Hz |
|                     |   | $f_{\text{out}} = 9.6\text{GHz}, f_{\text{OFFSET}} = 1\text{MHz}$   |     | -136 |     | dBc/Hz |
|                     |   | $f_{\text{out}} = 9.6\text{GHz}, f_{\text{OFFSET}} = 10\text{MHz}$  |     | -143 |     | dBc/Hz |
|                     |   | $f_{\text{out}} = 9.6\text{GHz}, f_{\text{OFFSET}} = 100\text{MHz}$ |     | -146 |     | dBc/Hz |

- (1) Measured with differential 50 ohm across TxP/M. The DC bias to 1.8V to each TxP/M at each pin remains and is not removed. Other external components on the TX paths are disconnected.
- (2) After DSA calibration procedure
- (3) Single side band, input clock phase noise subtracted.

#### 4.6 RF ADC Electrical Characteristics

Typical values at  $T_A = +25^\circ\text{C}$ , full temperature range is  $T_{A,\text{MIN}} = -40^\circ\text{C}$  to  $T_{J,\text{MAX}} = +110^\circ\text{C}$ ; RX Output Rate = 491.52MSPS below 6GHz input frequency and 1474.56MSPS above 6GHz input frequency,  $f_{\text{ADC}} = 2949.12\text{MSPS}$ ; PLL clock mode with  $f_{\text{REF}} = 491.52\text{MHz}$  below 6GHz input frequency and External clock mode with  $f_{\text{CLK}} = 11796.48\text{MHz}$  above 6GHz input frequency; nominal power supplies; DSA Setting = 4dB below 6GHz and 3dB above 6GHz; SerDes rate =24.33Gbps; unless otherwise noted.

| PARAMETER                       |  | TEST CONDITIONS   | MIN | TYP   | MAX | UNIT |
|---------------------------------|--|---|-----|-------|-----|------|
| ADC <sub>RES</sub>              | ADC resolution   |   |     | 14    |     | bits |
| F <sub>ADC</sub>                | ADC Sample Rate  |   | 1.5 |       | 3   | GSPS |
| F <sub>RF<sub>in</sub>MAX</sub> | RF input frequency range   | Requires PCB matching based on frequency range                          |     | 12000 |     | MHz  |
| F <sub>RF<sub>in</sub>MIN</sub> | RF input frequency range   | Requires PCB matching based on frequency range                          |     | 5     |     | MHz  |
| P <sub>FS_CW,min</sub>          | Min Full scale input power, at device pins (1)                   | f <sub>IN</sub> = 830 MHz, DSA=0dB                                      |     | -2.9  |     | dBm  |
|                                 |  | f <sub>IN</sub> = 1760 MHz, DSA=0dB                                     |     | -2.8  |     | dBm  |
|                                 |  | f <sub>IN</sub> = 2610 MHz, DSA=0dB                                     |     | -1.8  |     | dBm  |
|                                 |  | f <sub>IN</sub> = 3610 MHz, DSA=0dB                                     |     | -0.4  |     | dBm  |
|                                 |  | f <sub>IN</sub> = 4910 MHz, DSA=0dB                                     |     | 0.1   |     | dBm  |
|                                 |  | f <sub>IN</sub> = 8150 MHz, DSA=0dB                                     |     | 2.1   |     | dBm  |
|                                 |  | f <sub>IN</sub> = 9610 MHz, DSA=0dB                                     |     | 4.3   |     | dBm  |
| P <sub>FS_CW,MAX</sub>          | MAX Full scale input power - reliability limited, at device pins | f <sub>IN</sub> = 830 MHz, DSA = 20dB                                   |     | 16.7  |     | dBm  |
|                                 |  | f <sub>IN</sub> = 1760 MHz, DSA = 20dB                                  |     | 17.0  |     | dBm  |
|                                 |  | f <sub>IN</sub> = 2610 MHz, DSA = 20dB                                  |     | 18    |     | dBm  |
|                                 |  | f <sub>IN</sub> = 3610 MHz, DSA = 20dB                                  |     | 18.5  |     | dBm  |
|                                 |  | f <sub>IN</sub> = 4910 MHz, DSA = 20dB                                  |     | 19.3  |     | dBm  |
|                                 |  | f <sub>IN</sub> = 8150 MHz, DSA = 20dB                                  |     | 21.3  |     | dBm  |
|                                 |  | f <sub>IN</sub> = 9610 MHz, DSA = 20dB                                  |     | 23.5  |     | dBm  |
| S11                             | Input Return Loss  | with matching network   |     | -12   |     | dB   |
| ATT <sub>range</sub>            | DSA Attenuation range  |   |     | 25    |     | dB   |
| ATT <sub>step</sub>             | DSA Attenuation step   |   |     | 0.5   |     | dB   |
|                                 | DSA Attenuation step accuracy                                    | Delta=Gatt(X)-Gatt(X-1),<br>F <sub>in</sub> =3610MHz, after calibration |     | ±0.1  |     | dB   |
|                                 | DSA Gain Steps Phase accuracy any 8dB range                      | F <sub>in</sub> =3610MHz, after calibration                             |     | ±0.9  |     | deg  |
|                                 | DSA Gain Steps Phase accuracy any 8dB range                      | F <sub>in</sub> =4910MHz, after calibration                             |     | ±1.8  |     | deg  |

Typical values at  $T_A = +25^\circ\text{C}$ , full temperature range is  $T_{A,\text{MIN}} = -40^\circ\text{C}$  to  $T_{J,\text{MAX}} = +110^\circ\text{C}$ ; RX Output Rate = 491.52MSPS below 6GHz input frequency and 1474.56MSPS above 6GHz input frequency,  $f_{\text{ADC}} = 2949.12\text{MSPS}$ ; PLL clock mode with  $f_{\text{REF}} = 491.52\text{MHz}$  below 6GHz input frequency and External clock mode with  $f_{\text{CLK}} = 11796.48\text{MHz}$  above 6GHz input frequency; nominal power supplies; DSA Setting = 4dB below 6GHz and 3dB above 6GHz; SerDes rate = 24.33Gbps; unless otherwise noted.

| PARAMETER         |                                       | TEST CONDITIONS  | MIN | TYP    | MAX | UNIT    |
|-------------------|---------------------------------------|--|-----|--------|-----|---------|
| NSD               | Noise Density<br>(small signal)       | $f_{\text{IN}} = 830\text{ MHz}$ , DSA = 3dB <sup>(3)</sup>  |     | -155.2 |     | dBFS/Hz |
|                   |                                       | $f_{\text{IN}} = 1760\text{ MHz}$ , DSA = 3dB <sup>(3)</sup> |     | -155.0 |     | dBFS/Hz |
|                   |                                       | $f_{\text{IN}} = 2610\text{ MHz}$ , DSA = 3dB <sup>(3)</sup> |     | -154.4 |     | dBFS/Hz |
|                   |                                       | $f_{\text{IN}} = 3610\text{ MHz}$ , DSA = 3dB <sup>(3)</sup> |     | -154.1 |     | dBFS/Hz |
|                   |                                       | $f_{\text{IN}} = 4910\text{ MHz}$ , DSA = 3dB <sup>(3)</sup> |     | -155.1 |     | dBFS/Hz |
|                   |                                       | $f_{\text{IN}} = 8150\text{ MHz}$ , DSA = 3dB <sup>(3)</sup> |     | -150   |     | dBFS/Hz |
|                   |                                       | $f_{\text{IN}} = 9610\text{ MHz}$ , DSA = 3dB <sup>(3)</sup> |     | -151   |     | dBFS/Hz |
|                   |                                       | $f_{\text{IN}} = 830\text{ MHz}$ , 3<=Atten<=22              |     | -156.0 |     | dBFS/Hz |
|                   |                                       | $f_{\text{IN}} = 1760\text{ MHz}$ , 3<=Atten<=25             |     | -155.8 |     | dBFS/Hz |
|                   |                                       | $f_{\text{IN}} = 2610\text{ MHz}$ , 3<=Atten<=25             |     | -155.7 |     | dBFS/Hz |
|                   |                                       | $f_{\text{IN}} = 3610\text{ MHz}$ , 3<=Atten<=25             |     | -155.4 |     | dBFS/Hz |
|                   |                                       | $f_{\text{IN}} = 4910\text{ MHz}$ , 3<=Atten<=25             |     | -155.8 |     | dBFS/Hz |
|                   |                                       | $f_{\text{IN}} = 8150\text{ MHz}$ , 3<=Atten<=25             |     | -152.5 |     | dBFS/Hz |
|                   |                                       | $f_{\text{IN}} = 9610\text{ MHz}$ , 3<=Atten<=25             |     | -152.5 |     | dBFS/Hz |
| NF <sub>min</sub> | Noise Figure min<br>DSA Atten=0 - 3dB | $f_{\text{IN}} = 830\text{ MHz}$                             |     | 19.1   |     | dB      |
|                   |                                       | $f_{\text{IN}} = 1760\text{ MHz}$                            |     | 19.0   |     | dB      |
|                   |                                       | $f_{\text{IN}} = 2610\text{ MHz}$                            |     | 20.9   |     | dB      |
|                   |                                       | $f_{\text{IN}} = 3610\text{ MHz}$                            |     | 22.8   |     | dB      |
|                   |                                       | $f_{\text{IN}} = 4910\text{ MHz}$                            |     | 22.4   |     | dB      |
|                   |                                       | $f_{\text{IN}} = 8150\text{ MHz}$                            |     | 27.3   |     | dB      |
|                   |                                       | $f_{\text{IN}} = 9610\text{ MHz}$                            |     | 30     |     | dB      |
| NF                | Noise Figure<br>DSA Atten=4dB         | $f_{\text{IN}} = 830\text{ MHz}$ <sup>(4)</sup>              |     | 20.0   |     | dB      |
|                   |                                       | $f_{\text{IN}} = 1760\text{ MHz}$ <sup>(4)</sup>             |     | 20.6   |     | dB      |
|                   |                                       | $f_{\text{IN}} = 2610\text{ MHz}$ <sup>(4)</sup>             |     | 21.9   |     | dB      |
|                   |                                       | $f_{\text{IN}} = 3610\text{ MHz}$ <sup>(4)</sup>             |     | 23.5   |     | dB      |
|                   |                                       | $f_{\text{IN}} = 4910\text{ MHz}$ <sup>(4)</sup>             |     | 22.3   |     | dB      |
|                   |                                       | $f_{\text{IN}} = 8150\text{ MHz}$ <sup>(4)</sup>             |     | 27.9   |     | dB      |
|                   |                                       | $f_{\text{IN}} = 9610\text{ MHz}$ <sup>(4)</sup>             |     | 30.7   |     | dB      |
| NF <sub>max</sub> | Noise Figure<br>DSA Atten=20dB        | $f_{\text{IN}} = 830\text{ MHz}$                             |     | 34.7   |     | dB      |
|                   |                                       | $f_{\text{IN}} = 1760\text{ MHz}$                            |     | 35.2   |     | dB      |
|                   |                                       | $f_{\text{IN}} = 2610\text{ MHz}$                            |     | 36.0   |     | dB      |
|                   |                                       | $f_{\text{IN}} = 3610\text{ MHz}$                            |     | 37.3   |     | dB      |
|                   |                                       | $f_{\text{IN}} = 4910\text{ MHz}$                            |     | 37.6   |     | dB      |
|                   |                                       | $f_{\text{IN}} = 8150\text{ MHz}$                            |     | 42.8   |     | dB      |
|                   |                                       | $f_{\text{IN}} = 9610\text{ MHz}$                            |     | 45     |     | dB      |

Typical values at  $T_A = +25^\circ\text{C}$ , full temperature range is  $T_{A,\text{MIN}} = -40^\circ\text{C}$  to  $T_{J,\text{MAX}} = +110^\circ\text{C}$ ; RX Output Rate = 491.52MSPS below 6GHz input frequency and 1474.56MSPS above 6GHz input frequency,  $f_{\text{ADC}} = 2949.12\text{MSPS}$ ; PLL clock mode with  $f_{\text{REF}} = 491.52\text{MHz}$  below 6GHz input frequency and External clock mode with  $f_{\text{CLK}} = 11796.48\text{MHz}$  above 6GHz input frequency; nominal power supplies; DSA Setting = 4dB below 6GHz and 3dB above 6GHz; SerDes rate = 24.33Gbps; unless otherwise noted.

| PARAMETER |  | TEST CONDITIONS   | MIN | TYP | MAX | UNIT |
|-----------|--|---|-----|-----|-----|------|
| IMD3      | 3 <sup>rd</sup> order intermodulation 2 tones at at $f_{\text{IN}} \pm 10\text{MHz}$<br>-7dBFS each tone | $f_{\text{IN}} = 840\text{ MHz}, 3 \leq \text{Atten} \leq 12$                         |     | -82 |     | dBc  |
|           |  | $f_{\text{IN}} = 1770\text{ MHz}, 3 \leq \text{Atten} \leq 12$                        |     | -84 |     | dBc  |
|           |  | $f_{\text{IN}} = 2610\text{ MHz}, 3 \leq \text{Atten} \leq 12$                        |     | -74 |     | dBc  |
|           |  | $f_{\text{IN}} = 3610\text{ MHz}, 3 \leq \text{Atten} \leq 12$                        |     | -77 |     | dBc  |
|           |  | $f_{\text{IN}} = 4920\text{ MHz}, 3 \leq \text{Atten} \leq 12$                        |     | -76 |     | dBc  |
|           |  | $f_{\text{IN}} = 8150\text{ MHz}, 3 \leq \text{Atten} \leq 12,$<br>25MHz tone spacing |     | -55 |     | dBc  |
|           |  | $f_{\text{IN}} = 9610\text{ MHz}, 3 \leq \text{Atten} \leq 12,$<br>25MHz tone spacing |     | -60 |     | dBc  |
| SFDR      | Spurious Free Dynamic Range within output bandwidth, $A_{\text{IN}} = -3\text{ dBFS}$                    | $f_{\text{IN}} = 830\text{ MHz}$  |     | 88  |     | dBFS |
|           |  | $f_{\text{IN}} = 1760\text{ MHz}$   |     | 81  |     | dBFS |
|           |  | $f_{\text{IN}} = 2610\text{ MHz}$   |     | 88  |     | dBFS |
|           |  | $f_{\text{IN}} = 3610\text{ MHz}$   |     | 84  |     | dBFS |
|           |  | $f_{\text{IN}} = 4910\text{ MHz}$   |     | 79  |     | dBFS |
|           |  | $f_{\text{IN}} = 8150\text{ MHz}$   |     | 78  |     | dBFS |
|           |  | $f_{\text{IN}} = 9610\text{ MHz}$   |     | 71  |     | dBFS |
| HD2       | 2nd Harmonic Distortion<br>$A_{\text{IN}} = -3\text{ dBFS}^{(2)}$  | $f_{\text{IN}} = 830\text{ MHz}$  |     | -86 |     | dBFS |
|           |  | $f_{\text{IN}} = 1760\text{ MHz}$   |     | -91 |     | dBFS |
|           |  | $f_{\text{IN}} = 2610\text{ MHz}$   |     | -88 |     | dBFS |
|           |  | $f_{\text{IN}} = 3610\text{ MHz}$   |     | -87 |     | dBFS |
|           |  | $f_{\text{IN}} = 4910\text{ MHz}$   |     | -84 |     | dBFS |
|           |  | $f_{\text{IN}} = 8150\text{ MHz}$   |     | -70 |     | dBFS |
|           |  | $f_{\text{IN}} = 9610\text{ MHz}$   |     | -70 |     | dBFS |
| HD3       | 3rd Harmonic Distortion<br>$A_{\text{IN}} = -3\text{ dBFS}$  | $f_{\text{IN}} = 830\text{ MHz}$  |     | -80 |     | dBFS |
|           |  | $f_{\text{IN}} = 1760\text{ MHz}$   |     | -85 |     | dBFS |
|           |  | $f_{\text{IN}} = 2501\text{ MHz}$   |     | -80 | -58 | dBFS |
|           |  | $f_{\text{IN}} = 2610\text{ MHz}$   |     | -85 |     | dBFS |
|           |  | $f_{\text{IN}} = 3610\text{ MHz}$   |     | -78 |     | dBFS |
|           |  | $f_{\text{IN}} = 4910\text{ MHz}$   |     | -75 |     | dBFS |
|           |  | $f_{\text{IN}} = 8150\text{ MHz}$   |     | -70 |     | dBFS |
|           |  | $f_{\text{IN}} = 9610\text{ MHz}$   |     | -70 |     | dBFS |
| HDn, n>3  | SFDR excl. HD2 and HD3<br>$A_{\text{IN}} = -3\text{ dBFS}$   | $f_{\text{IN}} = 830\text{ MHz}$  |     | -88 |     | dBFS |
|           |  | $f_{\text{IN}} = 1760\text{ MHz}$   |     | -81 |     | dBFS |
|           |  | $f_{\text{IN}} = 2610\text{ MHz}$   |     | -88 |     | dBFS |
|           |  | $f_{\text{IN}} = 3610\text{ MHz}$   |     | -84 |     | dBFS |
|           |  | $f_{\text{IN}} = 4910\text{ MHz}$   |     | -82 |     | dBFS |
|           |  | $f_{\text{IN}} = 8150\text{ MHz}$   |     | -78 |     | dBFS |
|           |  | $f_{\text{IN}} = 9610\text{ MHz}$   |     | -78 |     | dBFS |

Typical values at  $T_A = +25^\circ\text{C}$ , full temperature range is  $T_{A,\text{MIN}} = -40^\circ\text{C}$  to  $T_{J,\text{MAX}} = +110^\circ\text{C}$ ; RX Output Rate = 491.52MSPS below 6GHz input frequency and 1474.56MSPS above 6GHz input frequency,  $f_{\text{ADC}} = 2949.12\text{MSPS}$ ; PLL clock mode with  $f_{\text{REF}} = 491.52\text{MHz}$  below 6GHz input frequency and External clock mode with  $f_{\text{CLK}} = 11796.48\text{MHz}$  above 6GHz input frequency; nominal power supplies; DSA Setting = 4dB below 6GHz and 3dB above 6GHz; SerDes rate = 24.33Gbps; unless otherwise noted.

| PARAMETER       |   | TEST CONDITIONS                                     | MIN | TYP  | MAX | UNIT |
|-----------------|---|---|-----|------|-----|------|
| SFDR            | Spurious Free Dynamic Range<br>$A_{\text{IN}} = -13\text{ dBFS}$<br>$0 \leq \text{Atten} \leq 16$ | $f_{\text{IN}} = 830\text{ MHz}$                    |     | 89   |     | dBFS |
|                 |   | $f_{\text{IN}} = 1760\text{ MHz}$                   |     | 89   |     | dBFS |
|                 |   | $f_{\text{IN}} = 2610\text{ MHz}$                   |     | 95   |     | dBFS |
|                 |   | $f_{\text{IN}} = 3610\text{ MHz}$                   |     | 90   |     | dBFS |
|                 |   | $f_{\text{IN}} = 4910\text{ MHz}$                   |     | 90   |     | dBFS |
|                 |   | $f_{\text{IN}} = 8150\text{ MHz}$                   |     | 83   |     | dBFS |
|                 |   | $f_{\text{IN}} = 9610\text{ MHz}$                   |     | 80   |     | dBFS |
| HD2             | 2nd Harmonic Distortion<br>$A_{\text{IN}} = -13\text{ dBFS}$<br>$0 \leq \text{Atten} \leq 16$     | $f_{\text{IN}} = 830\text{ MHz}$ , with board trim  |     | -79  |     | dBFS |
|                 |   | $f_{\text{IN}} = 1760\text{ MHz}$ , with board trim |     | -102 |     | dBFS |
|                 |   | $f_{\text{IN}} = 2610\text{ MHz}$ , with board trim |     | -100 |     | dBFS |
|                 |   | $f_{\text{IN}} = 3610\text{ MHz}$ , with board trim |     | -101 |     | dBFS |
|                 |   | $f_{\text{IN}} = 4910\text{ MHz}$ , with board trim |     | -99  |     | dBFS |
|                 |   | $f_{\text{IN}} = 8150\text{ MHz}$ , with board trim |     | -107 |     | dBFS |
|                 |   | $f_{\text{IN}} = 9610\text{ MHz}$ , with board trim |     | -107 |     | dBFS |
| HD3             | 3rd Harmonic Distortion<br>$A_{\text{IN}} = -13\text{ dBFS}$<br>$0 \leq \text{Atten} \leq 16$     | $f_{\text{IN}} = 830\text{ MHz}$                    |     | -95  |     | dBFS |
|                 |   | $f_{\text{IN}} = 1760\text{ MHz}$                   |     | -95  |     | dBFS |
|                 |   | $f_{\text{IN}} = 2610\text{ MHz}$                   |     | -98  |     | dBFS |
|                 |   | $f_{\text{IN}} = 3610\text{ MHz}$                   |     | -97  |     | dBFS |
|                 |   | $f_{\text{IN}} = 4910\text{ MHz}$                   |     | -94  |     | dBFS |
|                 |   | $f_{\text{IN}} = 8150\text{ MHz}$                   |     | -100 |     | dBFS |
|                 |   | $f_{\text{IN}} = 9610\text{ MHz}$                   |     | -102 |     | dBFS |
| HDn, n>3        | SFDR excl. HD2 and HD3<br>$A_{\text{IN}} = -13\text{ dBFS}$<br>$0 \leq \text{Atten} \leq 16$      | $f_{\text{IN}} = 830\text{ MHz}$                    |     | -89  |     | dBFS |
|                 |   | $f_{\text{IN}} = 1760\text{ MHz}$                   |     | -89  |     | dBFS |
|                 |   | $f_{\text{IN}} = 2610\text{ MHz}$                   |     | -95  |     | dBFS |
|                 |   | $f_{\text{IN}} = 3610\text{ MHz}$                   |     | -90  |     | dBFS |
|                 |   | $f_{\text{IN}} = 4910\text{ MHz}$                   |     | -90  |     | dBFS |
|                 |   | $f_{\text{IN}} = 8150\text{ MHz}$                   |     | -83  |     | dBFS |
|                 |   | $f_{\text{IN}} = 9610\text{ MHz}$                   |     | -80  |     | dBFS |
| RX-RX Isolation | Near Channel:<br>1RXIN to 2RXIN<br>3RXIN to 4RXIN   | $f_{\text{IN}} = 830\text{ MHz}$                    |     | -77  |     | dBc  |
|                 |   | $f_{\text{IN}} = 1760\text{ MHz}$                   |     | -71  |     | dBc  |
|                 |   | $f_{\text{IN}} = 2610\text{ MHz}$                   |     | -74  |     | dBc  |
|                 |   | $f_{\text{IN}} = 3610\text{ MHz}$                   |     | -77  |     | dBc  |
|                 |   | $f_{\text{IN}} = 4910\text{ MHz}$                   |     | -65  |     | dBc  |
|                 |   | $f_{\text{IN}} = 8150\text{ MHz}$                   |     | -64  |     | dBc  |
|                 |   | $f_{\text{IN}} = 9610\text{ MHz}$                   |     | -60  |     | dBc  |
| TX-FB Isolation | Near Channel:<br>2TXOUT to 1FBIN<br>4TXOUT to 2FBIN   | $f_{\text{IN}} = 830\text{ MHz}$                    |     | -84  |     | dBc  |
|                 |   | $f_{\text{IN}} = 1760\text{ MHz}$                   |     | -88  |     | dBc  |
|                 |   | $f_{\text{IN}} = 2610\text{ MHz}$                   |     | -85  |     | dBc  |
|                 |   | $f_{\text{IN}} = 3610\text{ MHz}$                   |     | -75  |     | dBc  |
|                 |   | $f_{\text{IN}} = 4910\text{ MHz}$                   |     | -82  |     | dBc  |
|                 |   | $f_{\text{IN}} = 8150\text{ MHz}$                   |     | -71  |     | dBc  |
|                 |   | $f_{\text{IN}} = 9610\text{ MHz}$                   |     | -69  |     | dBc  |

Typical values at  $T_A = +25^\circ\text{C}$ , full temperature range is  $T_{A,\text{MIN}} = -40^\circ\text{C}$  to  $T_{J,\text{MAX}} = +110^\circ\text{C}$ ; RX Output Rate = 491.52MSPS below 6GHz input frequency and 1474.56MSPS above 6GHz input frequency,  $f_{\text{ADC}} = 2949.12\text{MSPS}$ ; PLL clock mode with  $f_{\text{REF}} = 491.52\text{MHz}$  below 6GHz input frequency and External clock mode with  $f_{\text{CLK}} = 11796.48\text{MHz}$  above 6GHz input frequency; nominal power supplies; DSA Setting = 4dB below 6GHz and 3dB above 6GHz; SerDes rate = 24.33Gbps; unless otherwise noted.

| PARAMETER       |  | TEST CONDITIONS                    | MIN | TYP | MAX | UNIT |
|-----------------|--|------------------------------------|-----|-----|-----|------|
| TX-RX Isolation | Far Channel:<br>2TXOUT to 1RXIN<br>4TXOUT to 3RXIN | $f_{\text{IN}} = 830 \text{ MHz}$  |     | -86 |     | dBc  |
|                 |  | $f_{\text{IN}} = 1760 \text{ MHz}$ |     | -87 |     | dBc  |
|                 |  | $f_{\text{IN}} = 2610 \text{ MHz}$ |     | -91 |     | dBc  |
|                 |  | $f_{\text{IN}} = 3610 \text{ MHz}$ |     | -83 |     | dBc  |
|                 |  | $f_{\text{IN}} = 4910 \text{ MHz}$ |     | -82 |     | dBc  |
|                 |  | $f_{\text{IN}} = 8150 \text{ MHz}$ |     | -68 |     | dBc  |
|                 |  | $f_{\text{IN}} = 9610 \text{ MHz}$ |     | -68 |     | dBc  |

- (1) The input fullscale at minimum attenuation can be reduce by adding a digital gain range to the DSA, extending the useful range of the DSA. The noise figure remains constant over the digital gain range.
- (2) NLE correction of HD2
- (3) From DSA = 3dB down to 0dB, NSD increases 1dB per DSA dB
- (4) NF increase 1dB per DSA 1dB above DSA = 3dB

#### 4.7 PLL/VCO/Clock Electrical Characteristics

Typical values at TA = +25°C, full temperature range is T<sub>A,MIN</sub> = -40°C to T<sub>J,MAX</sub> = +110°C; Reference clock input frequency 491.52MHz (unless otherwise noted), f<sub>DAC</sub> = f<sub>VCO</sub>, f<sub>OUT</sub> = f<sub>DAC</sub>/4, normalized to f<sub>VCO</sub>.

| PARAMETER                |   | TEST CONDITIONS                                | MIN   | TYP                | MAX    | UNIT    |
|--------------------------|---|--|-------|--------------------|--------|---------|
| f <sub>VCO1</sub>        | VCO1 min frequency  |  |       |                    | 7.2    | GHz     |
|                          | VCO1 max frequency  |  | 7.68  |                    |        | GHz     |
| f <sub>VCO2</sub>        | VCO2 min frequency  |  |       |                    | 8.8    | GHz     |
|                          | VCO2 max frequency  |  | 9.1   |                    |        | GHz     |
| f <sub>VCO3</sub>        | VCO3 min frequency  |  |       |                    | 9.7    | GHz     |
|                          | VCO3 max frequency  |  | 10.24 |                    |        | GHz     |
| f <sub>VCO4</sub>        | VCO4 min frequency  |  |       |                    | 11.6   | GHz     |
|                          | VCO4 max frequency  |  | 12.08 |                    |        | GHz     |
| DIV <sub>DAC</sub>       | DAC sample rate divider   |  |       | 1, 2 or 3          |        |         |
| DIV <sub>FBAD</sub><br>C | ADC sample rate divider from DAC sample rate  |  |       | 1, 2, 3, 4, 6 or 8 |        |         |
| DIV <sub>RXAD</sub><br>C | ADC sample rate divider   |  |       | 1, 2, 3, 4, 6 or 8 |        |         |
| PN <sub>VCO</sub>        | Closed Loop Phase Noise F <sub>PLL</sub> = 11.79848 GHz F <sub>REF</sub> =491.52MHz | 600kHz   |       | -113               |        | dBc/Hz  |
|                          |   | 800kHz   |       | -116               |        | dBc/Hz  |
|                          |   | 1MHz   |       | -119               |        | dBc/Hz  |
|                          |   | 1.8MHz   |       | -125               |        | dBc/Hz  |
|                          |   | 5MHz   |       | -133               |        | dBc/Hz  |
|                          |   | 50MHz  |       | -141               |        | dBc/Hz  |
|                          | Closed Loop Phase Noise F <sub>PLL</sub> =8.84736 GHz F <sub>REF</sub> =491.52MHz   | 600kHz   |       | -114               |        | dBc/Hz  |
|                          |   | 800kHz   |       | -118               |        | dBc/Hz  |
|                          |   | 1MHz   |       | -120               |        | dBc/Hz  |
|                          |   | 1.8MHz   |       | -127               |        | dBc/Hz  |
|                          |   | 5MHz   |       | -135               |        | dBc/Hz  |
|                          | Closed Loop Phase Noise F <sub>PLL</sub> = 9.8403 GHz F <sub>REF</sub> =491.52MHz   | 600kHz   |       | -113               |        | dBc/Hz  |
|                          |   | 800kHz   |       | -116               |        | dBc/Hz  |
|                          |   | 1MHz   |       | -119               |        | dBc/Hz  |
|                          |   | 1.8MHz   |       | -125               |        | dBc/Hz  |
|                          |   | 5MHz   |       | -134               |        | dBc/Hz  |
|                          | Closed Loop Phase Noise F <sub>PLL</sub> = 7.86432GHz F <sub>REF</sub> =491.52MHz   | 600kHz   |       | -116               |        | dBc/Hz  |
|                          |   | 800kHz   |       | -119               |        | dBc/Hz  |
|                          |   | 1MHz   |       | -122               |        | dBc/Hz  |
|                          |   | 1.8MHz   |       | -127               |        | dBc/Hz  |
| 5MHz                     |   |  | -136  |                    | dBc/Hz |         |
| F <sub>rms</sub>         | Clock PLL integrated phase error <sup>(1)</sup>                                     | f <sub>PLL</sub> =11.79848 GHz, [1KHz, 100MHz] |       | -43.4              |        | dBc/Hz  |
|                          |   | f <sub>PLL</sub> =8.8536 GHz, [1KHz, 100MHz]   |       | -47.6              |        | dBc/Hz  |
|                          |   | f <sub>PLL</sub> =9.8304 GHz, [1KHz, 100MHz]   |       | -46.2              |        | dBc/Hz  |
| f <sub>PFD</sub>         | PFD frequency   |  | 100   |                    | 500    | MHz     |
| F <sub>REF</sub>         | Input clock minimum frequency   |  |       | 0.1                |        | GHz     |
| F <sub>REF</sub>         | Input Clock maximum frequency   |  |       | 12                 |        | GHz     |
| V <sub>CLKMIN</sub>      | Input clock minimum level   |  |       | 0.6                |        | Vppdiff |

Typical values at  $T_A = +25^\circ\text{C}$ , full temperature range is  $T_{A,\text{MIN}} = -40^\circ\text{C}$  to  $T_{J,\text{MAX}} = +110^\circ\text{C}$ ; Reference clock input frequency 491.52MHz (unless otherwise noted),  $f_{\text{DAC}} = f_{\text{VCO}}$ ,  $f_{\text{OUT}} = f_{\text{DAC}}/4$ , normalized to  $f_{\text{VCO}}$ .

| PARAMETER                      |                                       | TEST CONDITIONS                       | MIN | TYP                    | MAX | UNIT     |
|--------------------------------|---------------------------------------|---------------------------------------|-----|------------------------|-----|----------|
| $V_{\text{CLKMAX}}$            | Input Clock maximum level             |                                       |     | 1.8                    |     | Vppdiff  |
| $\text{PN}_{\text{pll\_flat}}$ | Normalized PLL flat Noise             | $f_{\text{VCO}} = 11796.48\text{MHz}$ |     | -226.5                 |     | dBc/Hz   |
| Coupling                       |                                       |                                       |     | AC<br>Coupling<br>Only |     |          |
|                                | REFCLK input impedance <sup>(2)</sup> | Parallel resistance                   |     | 100                    |     | $\Omega$ |
|                                |                                       | Parallel capacitance                  |     | 0.5                    |     | pF       |

- (1) Single Sideband, not including the reference clock contribution  
 (2) Refer to S11 data available from TI for impedance vs frequency

## 4.8 Digital Electrical Characteristics

Typical values at TA = +25°C, full temperature range is T<sub>A,MIN</sub> = -40°C to T<sub>J,MAX</sub> = +110°C (unless otherwise noted)

| PARAMETER  |   | TEST CONDITIONS           | MIN                | TYP                | MAX | UNIT                   |
|--|---|---------------------------|--------------------|--------------------|-----|------------------------|
| <b>CML SerDes Inputs [8:1]SRX+/-</b>   |   |                           |                    |                    |     |                        |
| V <sub>SRDIFF</sub>  | SerDes Receiver Minimum Input Amplitude                 |                           |                    | 100                |     | mVpp                   |
| V <sub>SRDIFF</sub>  | SerDes Receiver Maximum Input Amplitude                 |                           |                    | 1200               |     | mVpp                   |
| V <sub>SRCOM</sub>   | SerDes Minimum Input Common Mode                        |                           |                    | 0.5                |     | V                      |
| V <sub>SRCOM</sub>   | SerDes Maximum Input Common Mode                        |                           |                    | 0.6                |     | V                      |
| Z <sub>SRdiff</sub>  | SerDes Internal Differential Termination <sup>(1)</sup> |                           |                    | 115                |     | Ω                      |
| F <sub>SerDes</sub>  | SerDes Bit Rate   | Minimum full rate mode    |                    | 19                 |     | Gbps                   |
| F <sub>SerDes</sub>  | SerDes Bit Rate   | Maximum full rate mode    |                    | 24.75              |     | Gbps                   |
| F <sub>SerDes</sub>  | SerDes Bit Rate   | Minimum half rate mode    |                    | 9.5                |     | Gbps                   |
| F <sub>SerDes</sub>  | SerDes Bit Rate   | Maximum half rate mode    |                    | 16.25              |     | Gbps                   |
| F <sub>SerDes</sub>  | SerDes Bit Rate   | Minimum quarter rate mode |                    | 4.75               |     | Gbps                   |
| F <sub>SerDes</sub>  | SerDes Bit Rate   | Maximum quarter rate mode |                    | 8.125              |     | Gbps                   |
|  | Insertion Loss Tolerance <sup>(2)</sup>                 | Serdes supply = 1.8V      |                    | 25                 |     | dB                     |
| TJ   | Total Jitter Tolerance                                  |                           |                    | 0.42               |     | UI                     |
| <b>CML SerDes Outputs [8:1]STX+/-</b>  |   |                           |                    |                    |     |                        |
| V <sub>STDIFF</sub>  | SerDes Transmitter Minimum Output Amplitude             | differential              |                    | 500                |     | mVpp                   |
| V <sub>STDIFF</sub>  | SerDes Transmitter Maximum Output Amplitude             | differential              |                    | 1000               |     | mVpp                   |
| V <sub>STCOM</sub>   | SerDes Output Minimum Common Mode                       |                           |                    | 0.5                |     | V                      |
| V <sub>STCOM</sub>   | SerDes Output Common Mode                               |                           |                    | 0.6                |     | V                      |
| Z <sub>STdiff</sub>  | SerDes Output Impedance                                 |                           |                    | 115                |     | Ω                      |
| TRF  | Output rise and fall time                               | 20-80%                    |                    | 8                  |     | ps                     |
| TEQS   | Equalization range                                      |                           |                    | 7                  |     | dB                     |
| TTJ  | Output total jitter                                     |                           |                    | 0.21               |     | UI                     |
| <b>CMOS I/O: GPIO{B/C/D/E}x, SPICLK, SPISDIO, SPISDO, SPISEN, RESETZ, BISTB0, BISTB1</b> |   |                           |                    |                    |     |                        |
| V <sub>IH</sub>  | High-Level Input Voltage                                |                           | 0.6×VDD1<br>P8GPIO |                    |     | V                      |
| V <sub>IL</sub>  | Low-Level Input Voltage                                 |                           |                    | 0.4×VDD1<br>P8GPIO |     | V                      |
| V <sub>OH</sub>  | High-Level Output Voltage                               |                           | VDD1P8G<br>PIO-0.2 |                    |     | V                      |
| V <sub>OL</sub>  | Low-Level Output Voltage                                |                           |                    |                    | 0.2 | V                      |
| <b>Differential Inputs: SYSREF+/- Mode A</b>   |   |                           |                    |                    |     |                        |
| F <sub>SYSREFMAX</sub>   | SYSREF Input Frequency Maximum                          |                           |                    | 40                 |     | MHz                    |
| V <sub>SWINGSRMAX</sub>  | SYSREF Input Swing Maximum                              |                           |                    | 1.8                |     | Vppdiff <sup>(3)</sup> |
| V <sub>SWINGSRMIN</sub>  | SYSREF Input Swing Minimum                              | f <sub>REF</sub> < 500MHz |                    | 0.3                |     | Vppdiff <sup>(3)</sup> |
| V <sub>SWINGSRMIN</sub>  | SYSREF Input Swing Minimum                              | f <sub>REF</sub> > 500MHz |                    | 0.6                |     | Vppdiff <sup>(3)</sup> |
| V <sub>COMSRMAX</sub>  | SYSREF Input Common Mode Voltage Maximum                |                           |                    | 0.8                |     | V                      |
| V <sub>COMSRMIN</sub>  | SYSREF Input Common Mode Voltage Minimum                |                           |                    | 0.6                |     | V                      |
| Z <sub>T</sub>   | Input termination                                       | differential              |                    | 108 <sup>(1)</sup> |     | Ω                      |

Typical values at TA = +25°C, full temperature range is TA,MIN = -40°C to TJ,MAX = +110°C (unless otherwise noted)

| PARAMETER  |                                   | TEST CONDITIONS | MIN | TYP | MAX | UNIT                    |
|--|-----------------------------------|-----------------|-----|-----|-----|-------------------------|
| CL   | Input capacitance                 | Each pin to GND |     | 0.5 |     | pF                      |
| <b>LVDS Inputs: 0SYNCIN+/- and 1SYNCIN+/-</b>      |                                   |                 |     |     |     |                         |
| VICOM  | Input Common Voltage              |                 |     | 1.2 |     | V                       |
| VID  | Differential Input Voltage swing  |                 |     | 450 |     | mVppdiff <sup>(3)</sup> |
| ZT   | Input termination                 | differential    |     | 100 |     | Ω                       |
| <b>LVDS Outputs: 0SYNCOOUT+/- and 1SYNCOOUT+/-</b> |                                   |                 |     |     |     |                         |
| VOCOM  | Output Common Voltage             |                 |     | 1.2 |     | V                       |
| VOD  | Differential Output Voltage swing |                 |     | 355 |     | mVppdiff <sup>(3)</sup> |

- (1) Default setting. SYSREF termination is programmable between nominally 100Ω, 150Ω and 300Ω
- (2) Loss tolerance is bump to bump from STX to SRX
- (3) Vppdiff is the difference between the maximum differential voltage (positive value) and minimum differential voltage (negative value).

#### 4.9 Power Supply Electrical Characteristics

Typical values at TA = +25°C, full temperature range is TA,MIN = -40°C to TJ,MAX = +110°C; TX Input Rate = 491.52MSPS, fDAC = 8847.36MSPS interleave mode; fADC = 2949.12MSPS; nominal power supplies; 1 tone at -1 dBFS; DSA Attenuation = 0dB; SerDes rate = 24.33Gbps; unless otherwise noted.

| PARAMETER |   | TEST CONDITIONS  | MIN  | TYP    | MAX   | UNIT |
|-----------|---|--|--|--------|-------|------|
| IVDD1P8   | Group 3A: VDD1P8FB + VDD1P8RX + VDD1P8TX                                | Mode 1: 4T2F - FDD FB 100% on, no RX TX/FB Rate: 491.52 Msps Single Band: 12x Int, FB 6x Dec fDAC = 5898.24 SPS fADC = 2949.12MSPS fTX = 1.85 GHz 64/66 coding, 16.22Gbps TX: 4-8-4-1, FB: 2-4-4-1 |  | 948.2  |       | mA   |
|           | Group 3B: VDD1P8FBCLK + VDD1P8RXCLK + VDD1P8TXDAC+ VDD1P8GPIO + VDDA1P8 |  |  | 533.7  |       | mA   |
|           | Group 3C: VDD1P8PLL + VDD1P8PLLVC0                                      |  |  | 77.3   |       | mA   |
| IVDD1P2   | Group 2A: VDD1P2FB + VDD1P2RX   |  |  | 299.4  |       | mA   |
|           | Group 2B: VDD1P2TXCLK + VDD1P2TXENC                                     |  |  | 804.5  |       | mA   |
|           | Group 2C: VDD1P2FBCML + VDD1P2RXCML + VDD1P2PLLCLKREF                   |  |  | 49.1   |       | mA   |
| IVDD0P9   | Group 1A: DVDD0P9 + VDDT0P9   |  |  | 2041.3 |       | mA   |
| Pdiss     | Power Dissipation   |  |  | 6027.1 |       | mW   |
| IVDD1P8   | Group 3A: VDD1P8FB + VDD1P8RX + VDD1P8TX                                |  | Mode 2: 4T4R - TDD 1F shared with RX TX 75%, RX 25%, FB 75% Dual Band: 12x Int, FB 6x Dec, RX 24x Dec TX/FB Rate 491.52 Msps RX Rate 122.88 Msps fDAC = 8847.36MSPS fADC = 2949.12MSPS fOUT=fIN= 1.9, 2.6 GHz 64/66 coding, 16.22Gbps TX: 8-16-4-1, FB: 2-4-4-1, RX: 2-16-16-1 |        | 820.4 |      |
|           | Group 3B: VDD1P8FBCLK + VDD1P8RXCLK + VDD1P8TXDAC+ VDD1P8GPIO + VDDA1P8 |  |  | 735.2  |       | mA   |
|           | Group 3C: VDD1P8PLL + VDD1P8PLLVC0                                      |  |  | 74.4   |       | mA   |
| IVDD1P2   | Group 2A: VDD1P2FB + VDD1P2RX   |  |  | 289.0  |       | mA   |
|           | Group 2B: VDD1P2TXCLK + VDD1P2TXENC                                     |  |  | 822.0  |       | mA   |
|           | Group 2C: VDD1P2FBCML + VDD1P2RXCML + VDD1P2PLLCLKREF                   |  |  | 45.6   |       | mA   |
| IVDD0P9   | Group 1A: DVDD0P9 + VDDT0P9   |  |  | 2263.8 |       | mA   |
| Pdiss     | Power Dissipation   |  |  | 6359.2 |       | mW   |

**AFE7950-SP, AFE7950-SEP**

SBASAG7B – MARCH 2024 – REVISED JUNE 2026

Typical values at  $T_A = +25^\circ\text{C}$ , full temperature range is  $T_{A,\text{MIN}} = -40^\circ\text{C}$  to  $T_{J,\text{MAX}} = +110^\circ\text{C}$ ; TX Input Rate = 491.52MSPS,  $f_{\text{DAC}} = 8847.36\text{MSPS}$  interleave mode;  $f_{\text{ADC}} = 2949.12\text{MSPS}$ ; nominal power supplies; 1 tone at -1 dBFS; DSA Attenuation = 0dB; SerDes rate = 24.33Gbps; unless otherwise noted.

| PARAMETER           |   | TEST CONDITIONS  | MIN   | TYP     | MAX    | UNIT |
|---------------------|---|--|---|---------|--------|------|
| $I_{\text{VDD1P8}}$ | Group 3A: VDD1P8FB + VDD1P8RX + VDD1P8TX                                | Mode 3: 4T4R2F - FDD FB 100% on TX Dual Band: 12x Int, FB 6x Dec RX Dual Band: RX 24x TX/FB Rate 491.52 Msps RX Rate 122.88 Msps $f_{\text{DAC}} = 11796.48\text{ MSPS}$ $f_{\text{ADC}} = 2949.12\text{ MSPS}$ $f_{\text{TX}} = 1.85 + 2.15\text{ GHz}$ $f_{\text{RX}} = 1.75 + 1.88\text{ GHz}$ 64/66 coding, 16.22Gbps TX: 8-16-4-1, FB: 2-4-4-1, RX: 2-16-16-1 |   | 1668.6  |        | mA   |
|                     | Group 3B: VDD1P8FBCLK + VDD1P8RXCLK + VDD1P8TXDAC+ VDD1P8GPIO + VDDA1P8 |  |   | 965.1   |        | mA   |
|                     | Group 3C: VDD1P8PLL + VDD1P8PLLVC0                                      |  |   | 77.6    |        | mA   |
| $I_{\text{VDD1P2}}$ | Group 2A: VDD1P2FB + VDD1P2RX   |  |   | 893.4   |        | mA   |
|                     | Group 2B: VDD1P2TXCLK + VDD1P2TXENC                                     |  |   | 879.5   |        | mA   |
|                     | Group 2C: VDD1P2FBCML + VDD1P2RXCML + VDD1P2PLLCLKREF                   |  |   | 50.7    |        | mA   |
| $I_{\text{VDD0P9}}$ | Group 1A: DVDD0P9 + VDDT0P9   |  |   | 3826.9  |        | mA   |
| $P_{\text{diss}}$   | Power Dissipation   |  |   | 10513.0 |        | mW   |
| $I_{\text{VDD1P8}}$ | Group 3A: VDD1P8FB + VDD1P8RX + VDD1P8TX                                |  | Mode 4: 4T4R2F - FDD FB 100% on 7.5 GSPS DAC, 2.5 GSPS ADC Single Band: 15x Int, FB 5x Dec Dual Band: RX 20x TX/FB Rate 491.52 Msps RX Rate 122.88 Msps $f_{\text{DAC}} = 7372.8\text{ MSPS}$ $f_{\text{ADC}} = 2457.6\text{ MSPS}$ $f_{\text{TX}} = 1.85 + 2.15\text{ GHz}$ $f_{\text{RX}} = 1.75 + 1.88\text{ GHz}$ 64/66 coding, 16.22Gbps TX: 4-8-4-1, FB: 2-4-4-1, RX: 2-16-16-1 |         | 1611.5 |      |
|                     | Group 3B: VDD1P8FBCLK + VDD1P8RXCLK + VDD1P8TXDAC+ VDD1P8GPIO + VDDA1P8 |  |   | 694.5   |        | mA   |
|                     | Group 3C: VDD1P8PLL + VDD1P8PLLVC0                                      |  |   | 72.8    |        | mA   |
| $I_{\text{VDD1P2}}$ | Group 2A: VDD1P2FB + VDD1P2RX   |  |   | 768.5   |        | mA   |
|                     | Group 2B: VDD1P2TXCLK + VDD1P2TXENC                                     |  |   | 940.5   |        | mA   |
|                     | Group 2C: VDD1P2FBCML + VDD1P2RXCML + VDD1P2PLLCLKREF                   |  |   | 45.5    |        | mA   |
| $I_{\text{VDD0P9}}$ | Group 1A: DVDD0P9 + VDDT0P9   |  |   | 3000.5  |        | mA   |
| $P_{\text{diss}}$   | Power Dissipation   |  |   | 9087.4  |        | mW   |
| $I_{\text{VDD1P8}}$ | Group 3A: VDD1P8FB + VDD1P8RX + VDD1P8TX                                | Mode 5: 4T4R - TDD 1F shared with RX TX 75%, RX 25%, FB 75% Single Band: 12x Int, FB 3x Dec, RX 6x Dec TX/FB Rate = 983.04 Msps RX Rate 491.52 Msps $f_{\text{DAC}} = 11796.48\text{ MSPS}$ $f_{\text{ADC}} = 2949.12\text{ MSPS}$ $f_{\text{TX}} = 3.5\text{ GHz}$ $f_{\text{RX}} = 3.5\text{ GHz}$ 64/66 coding, 16.22Gbps TX: 8-8-2-1, FB: 4-4-4-2, RX: 4-8-4-1 |   |         | 821.8  |      |
|                     | Group 3B: VDD1P8FBCLK + VDD1P8RXCLK + VDD1P8TXDAC+ VDD1P8GPIO + VDDA1P8 |  |   | 808.5   |        | mA   |
|                     | Group 3C: VDD1P8PLL + VDD1P8PLLVC0                                      |  |   | 77.4    |        | mA   |
| $I_{\text{VDD1P2}}$ | Group 2A: VDD1P2FB + VDD1P2RX   |  |   | 289.5   |        | mA   |
|                     | Group 2B: VDD1P2TXCLK + VDD1P2TXENC                                     |  |   | 682.0   |        | mA   |
|                     | Group 2C: VDD1P2FBCML + VDD1P2RXCML + VDD1P2PLLCLKREF                   |  |   | 49.0    |        | mA   |
| $I_{\text{VDD0P9}}$ | Group 1A: DVDD0P9 + VDDT0P9   |  |   | 2123.3  |        | mA   |
| $P_{\text{diss}}$   | Power Dissipation   |  |   | 6209.3  |        | mW   |

Typical values at  $T_A = +25^\circ\text{C}$ , full temperature range is  $T_{A,\text{MIN}} = -40^\circ\text{C}$  to  $T_{J,\text{MAX}} = +110^\circ\text{C}$ ; TX Input Rate = 491.52MSPS,  $f_{\text{DAC}} = 8847.36\text{MSPS}$  interleave mode;  $f_{\text{ADC}} = 2949.12\text{MSPS}$ ; nominal power supplies; 1 tone at -1 dBFS; DSA Attenuation = 0dB; SerDes rate = 24.33Gbps; unless otherwise noted.

| PARAMETER           |   | TEST CONDITIONS  | MIN  | TYP   | MAX    | UNIT |    |
|---------------------|---|--|--|-------|--------|------|----|
| $I_{\text{VDD1P8}}$ | Group 3A: VDD1P8FB + VDD1P8RX + VDD1P8TX                                | Mode 7a: TDD 4T1FB (RX iin Standby)<br>TX 9G and FB 3G -16bit: 368.64M; DSA = 6dB, non-interleave mode<br>RX 3G : 368.64M. 16 bit, Standby<br>Serdes: 25gbps) -> 2 lanes for Rx/FB (lane shared) and 2lanes for Tx |  | 658.1 |        | mA   |    |
|                     | Group 3B: VDD1P8FBCLK + VDD1P8RXCLK + VDD1P8TXDAC+ VDD1P8GPIO + VDDA1P8 |  |  | 431.1 |        | mA   |    |
|                     | Group 3C: VDD1P8PLL + VDD1P8PLLVC0                                      |  |  | 75.3  |        | mA   |    |
| $I_{\text{VDD1P2}}$ | Group 2A: VDD1P2FB + VDD1P2RX   |  |  |       | 189.2  |      | mA |
|                     | Group 2B: VDD1P2TXCLK + VDD1P2TXENC                                     |  |  |       | 1041.1 |      | mA |
|                     | Group 2C: VDD1P2FBCML + VDD1P2RXCML + VDD1P2PLLCLKREF                   |  |  |       | 39.0   |      | mA |
| $I_{\text{VDD0P9}}$ | Group 1A: DVDD0P9 + VDDT0P9   |  |  |       | 2208.7 |      | mA |
| $P_{\text{diss}}$   | Power Dissipation   |  |  |       | 5607.0 |      | mW |
| $I_{\text{VDD1P8}}$ | Group 3A: VDD1P8FB + VDD1P8RX + VDD1P8TX                                |  | Mode 7b: TDD 4R (TX in Standby)<br>TX 9G and FB 3G -16bit: 368.64M; DSA = 6dB, , non-interleave mode, Standby<br>RX 3G : 368.64M. 16 bit<br>Serdes: 25gbps) -> 2 lanes for Rx/FB (lane shared) and 2lanes for Tx |       | 789.5  |      | mA |
|                     | Group 3B: VDD1P8FBCLK + VDD1P8RXCLK + VDD1P8TXDAC+ VDD1P8GPIO + VDDA1P8 |  |  | 471.3 |        | mA   |    |
|                     | Group 3C: VDD1P8PLL + VDD1P8PLLVC0                                      |  |  | 73.4  |        | mA   |    |
| $I_{\text{VDD1P2}}$ | Group 2A: VDD1P2FB + VDD1P2RX   |  |  |       | 599.3  |      | mA |
|                     | Group 2B: VDD1P2TXCLK + VDD1P2TXENC                                     |  |  |       | 169.6  |      | mA |
|                     | Group 2C: VDD1P2FBCML + VDD1P2RXCML + VDD1P2PLLCLKREF                   |  |  |       | 39.1   |      | mA |
| $I_{\text{VDD0P9}}$ | Group 1A: DVDD0P9 + VDDT0P9   |  |  |       | 1645.3 |      | mA |
| $P_{\text{diss}}$   | Power Dissipation   |  |  |       | 4851.9 |      | mW |
| $I_{\text{VDD1P8}}$ | Group 3A: VDD1P8FB + VDD1P8RX + VDD1P8TX                                | Mode 7c: TDD 4T4R1FB<br>TX 9G and FB 3G -16bit: 368.64M; DSA = 6dB, , non-interleave mode, 75% on<br>RX 3G : 368.64M. 16 bit 25% on<br>Serdes: 25gbps) -> 2 lanes for Rx/FB (lane shared) and 2lanes for Tx        |  |       | 691.0  |      | mA |
| $I_{\text{VDD1P8}}$ | Group 3B: VDD1P8FBCLK + VDD1P8RXCLK + VDD1P8TXDAC+ VDD1P8GPIO + VDDA1P8 |  |  | 441.2 |        | mA   |    |
| $I_{\text{VDD1P8}}$ | Group 3C: VDD1P8PLL + VDD1P8PLLVC0                                      |  |  | 74.8  |        | mA   |    |
| $I_{\text{VDD1P2}}$ | Group 2A: VDD1P2FB + VDD1P2RX   |  |  |       | 291.7  |      | mA |
| $I_{\text{VDD1P2}}$ | Group 2B: VDD1P2TXCLK + VDD1P2TXENC                                     |  |  |       | 823.2  |      | mA |
| $I_{\text{VDD1P2}}$ | Group 2C: VDD1P2FBCML + VDD1P2RXCML + VDD1P2PLLCLKREF                   |  |  |       | 39.0   |      | mA |
| $I_{\text{VDD0P9}}$ | Group 1A: DVDD0P9 + VDDT0P9   |  |  |       | 2067.9 |      | mA |
| $P_{\text{diss}}$   | Power Dissipation   |  |  |       | 5418.2 |      | mW |

**AFE7950-SP, AFE7950-SEP**

SBASAG7B – MARCH 2024 – REVISED JUNE 2026

Typical values at  $T_A = +25^\circ\text{C}$ , full temperature range is  $T_{A,\text{MIN}} = -40^\circ\text{C}$  to  $T_{J,\text{MAX}} = +110^\circ\text{C}$ ; TX Input Rate = 491.52MSPS,  $f_{\text{DAC}} = 8847.36\text{MSPS}$  interleave mode;  $f_{\text{ADC}} = 2949.12\text{MSPS}$ ; nominal power supplies; 1 tone at -1 dBFS; DSA Attenuation = 0dB; SerDes rate = 24.33Gbps; unless otherwise noted.

| PARAMETER           |   | TEST CONDITIONS   | MIN  | TYP    | MAX    | UNIT |
|---------------------|---|---|--|--------|--------|------|
| $I_{\text{VDD1P8}}$ | Group 3A: VDD1P8FB + VDD1P8RX + VDD1P8TX                                | Mode 7d: FDD 4T4R1FB<br>TX 9G and FB 3G -16bit: 368.64M; DSA = 6dB, , non-interleave mode,<br>RX 3G : 368.64M. 16 bit<br>Serdes: 25gbps) -> 2 lanes for Rx/FB (lane shared) and 2lanes for Tx |  | 1283.8 |        | mA   |
| $I_{\text{VDD1P8}}$ | Group 3B: VDD1P8FBCLK + VDD1P8RXCLK + VDD1P8TXDAC+ VDD1P8GPIO + VDDA1P8 |   |  | 752.0  |        | mA   |
| $I_{\text{VDD1P8}}$ | Group 3C: VDD1P8PLL + VDD1P8PLLVC0                                      |   |  | 74.6   |        | mA   |
| $I_{\text{VDD1P2}}$ | Group 2A: VDD1P2FB + VDD1P2RX   |   |  | 750.5  |        | mA   |
| $I_{\text{VDD1P2}}$ | Group 2B: VDD1P2TXCLK + VDD1P2TXENC                                     |   |  | 1077.6 |        | mA   |
| $I_{\text{VDD1P2}}$ | Group 2C: VDD1P2FBCML + VDD1P2RXCML + VDD1P2PLLCLKREF                   |   |  | 47.7   |        | mA   |
| $I_{\text{VDD0P9}}$ | Group 1A: DVDD0P9 + VDDT0P9   |   |  | 2695.5 |        | mA   |
| $P_{\text{diss}}$   | Power Dissipation   |   |  | 8475.5 |        | mW   |
| $I_{\text{VDD1P8}}$ | Group 3A: VDD1P8FB + VDD1P8RX + VDD1P8TX                                | Mode 8: same configuration as mode 7, Sleep Mode. SLEEP pin is pull high.   |  | 20.3   |        | mA   |
|                     | Group 3B: VDD1P8FBCLK + VDD1P8RXCLK + VDD1P8TXDAC+ VDD1P8GPIO + VDDA1P8 |   |  | 292.8  |        | mA   |
|                     | Group 3C: VDD1P8PLL + VDD1P8PLLVC0                                      |   |  | 12.6   |        | mA   |
| $I_{\text{VDD1P2}}$ | Group 2A: VDD1P2FB + VDD1P2RX   |   |  | 4.6    |        | mA   |
|                     | Group 2B: VDD1P2TXCLK + VDD1P2TXENC                                     |   |  | 54.3   |        | mA   |
|                     | Group 2C: VDD1P2FBCML + VDD1P2RXCML + VDD1P2PLLCLKREF                   |   |  | 15.3   |        | mA   |
| $I_{\text{VDD0P9}}$ | Group 1A: DVDD0P9 + VDDT0P9   |   |  | 313.1  |        | mA   |
| $P_{\text{diss}}$   | Power Dissipation   |   |  | 956.8  |        | mW   |
| $I_{\text{VDD1P8}}$ | Group 3A: VDD1P8FB + VDD1P8RX + VDD1P8TX                                |   | Mode 9: 4T4R2F - FDD FB 100% on TX<br>Single Band: 24x Int, FB 12x Dec RX<br>Single Band: RX 24x TX/FB Rate 245.76 Msp<br>RX Rate 122.88 Msp<br>$f_{\text{DAC}} = 5898.24\text{ MSPS}$ $f_{\text{ADC}} = 2949.12\text{ MSPS}$ $f_{\text{TX}} = 0.85\text{ GHz}$ $f_{\text{RX}} = 0.8\text{ GHz}$ 8/10 coding, 9.8304Gbps TX: 4-8-4-1, FB: 2-4-4-1, RX: 2-8-8-1 |        | 1593.2 |      |
|                     | Group 3B: VDD1P8FBCLK + VDD1P8RXCLK + VDD1P8TXDAC+ VDD1P8GPIO + VDDA1P8 |   |  | 840.6  |        | mA   |
|                     | Group 3C: VDD1P8PLL + VDD1P8PLLVC0                                      |   |  | 77.3   |        | mA   |
| $I_{\text{VDD1P2}}$ | Group 2A: VDD1P2FB + VDD1P2RX   |   |  | 905.0  |        | mA   |
|                     | Group 2B: VDD1P2TXCLK + VDD1P2TXENC                                     |   |  | 817.7  |        | mA   |
|                     | Group 2C: VDD1P2FBCML + VDD1P2RXCML + VDD1P2PLLCLKREF                   |   |  | 52.1   |        | mA   |
| $I_{\text{VDD0P9}}$ | Group 1A: DVDD0P9 + VDDT0P9   |   |  | 2405.2 |        | mA   |
| $P_{\text{diss}}$   | Power Dissipation   |   |  | 8814.3 |        | mW   |

Typical values at  $T_A = +25^\circ\text{C}$ , full temperature range is  $T_{A,\text{MIN}} = -40^\circ\text{C}$  to  $T_{J,\text{MAX}} = +110^\circ\text{C}$ ; TX Input Rate = 491.52MSPS,  $f_{\text{DAC}} = 8847.36\text{MSPS}$  interleave mode;  $f_{\text{ADC}} = 2949.12\text{MSPS}$ ; nominal power supplies; 1 tone at -1 dBFS; DSA Attenuation = 0dB; SerDes rate = 24.33Gbps; unless otherwise noted.

| PARAMETER           |   | TEST CONDITIONS   | MIN   | TYP     | MAX | UNIT |
|---------------------|---|---|---|---------|-----|------|
| $I_{\text{VDD1P8}}$ | Group 3A: VDD1P8FB + VDD1P8RX + VDD1P8TX                                | Mode 10: 4T4R2F - FDD FB 100% on TX Single Band: 18x Int, FB 6x Dec RX Single Band: RX 12x TX/FB Rate 491.52 Msp/s RX Rate 245.76 Msp/s $f_{\text{DAC}} = 8847.36\text{ MSPS}$ $f_{\text{ADC}} = 2949.12\text{ MSPS}$ $f_{\text{TX}} = 1.85\text{ GHz}$ $f_{\text{RX}} = 1.75\text{ GHz}$ 8/10 coding, 9.8304Gbps TX: 8-8-2-1, FB: 4-4-2-1, RX: 4-8-4-1 |   | 1626.2  |     | mA   |
|                     | Group 3B: VDD1P8FBCLK + VDD1P8RXCLK + VDD1P8TXDAC+ VDD1P8GPIO + VDDA1P8 |   |   | 976.4   |     | mA   |
|                     | Group 3C: VDD1P8PLL + VDD1P8PLLVC0                                      |   |   | 74.6    |     | mA   |
| $I_{\text{VDD1P2}}$ | Group 2A: VDD1P2FB + VDD1P2RX   |   |   | 902.7   |     | mA   |
|                     | Group 2B: VDD1P2TXCLK + VDD1P2TXENC                                     |   |   | 1111.9  |     | mA   |
|                     | Group 2C: VDD1P2FBCML + VDD1P2RXCML + VDD1P2PLLCLKREF                   |   |   | 48.0    |     | mA   |
| $I_{\text{VDD0P9}}$ | Group 1A: DVDD0P9 + VDDT0P9   |   |   | 3578.9  |     | mA   |
| $P_{\text{diss}}$   | Power Dissipation   |   |   | 10515.0 |     | mW   |
| $I_{\text{VDD1P8}}$ | Group 3A: VDD1P8FB + VDD1P8RX + VDD1P8TX                                |   | Mode 11a: TDD 4T1FB (RX in Standby) Single Band: 8x Int, FB 2x Dec, RX uses FB TX/FB/RX Rate = 1474.56 Msp/s $f_{\text{DAC}} = 11796.48\text{ MSPS}$ $f_{\text{ADC}} = 2949.12\text{ MSPS}$ $f_{\text{TX}} = f_{\text{RX}} = 8\text{ GHz}$ 64/66 coding, 24.33 Gbps TX: 8-8-2-1, FB/RX: 4-4-4-2 |         | 800 |      |
|                     | Group 3B: VDD1P8FBCLK + VDD1P8RXCLK + VDD1P8TXDAC+ VDD1P8GPIO + VDDA1P8 |   |   | 840     |     | mA   |
|                     | Group 3C: VDD1P8PLL + VDD1P8PLLVC0                                      |   |   | 73      |     | mA   |
| $I_{\text{VDD1P2}}$ | Group 2A: VDD1P2FB + VDD1P2RX   |   |   | 190     |     | mA   |
|                     | Group 2B: VDD1P2TXCLK + VDD1P2TXENC                                     |   |   | 1440    |     | mA   |
|                     | Group 2C: VDD1P2FBCML + VDD1P2RXCML + VDD1P2PLLCLKREF                   |   |   | 75      |     | mA   |
| $I_{\text{VDD0P9}}$ | Group 1A: DVDD0P9 + VDDT0P9   |   |   | 3070    |     | mA   |
| $P_{\text{diss}}$   | Power Dissipation   |   |   | 8010    |     | mW   |
| $I_{\text{VDD1P8}}$ | Group 3A: VDD1P8FB + VDD1P8RX + VDD1P8TX                                | Mode 11b: TDD 4R (TX in Standby) Single Band: 8x Int, FB 2x Dec, RX uses FB TX/FB/RX Rate = 1474.56 Msp/s $f_{\text{DAC}} = 11796.48\text{ MSPS}$ $f_{\text{ADC}} = 2949.12\text{ MSPS}$ $f_{\text{TX}} = f_{\text{RX}} = 8\text{ GHz}$ 64/66 coding, 24.33 Gbps TX: 8-8-2-1, FB/RX: 4-4-4-2  |   |         | 750 |      |
|                     | Group 3B: VDD1P8FBCLK + VDD1P8RXCLK + VDD1P8TXDAC+ VDD1P8GPIO + VDDA1P8 |   |   | 890     |     | mA   |
|                     | Group 3C: VDD1P8PLL + VDD1P8PLLVC0                                      |   |   | 72      |     | mA   |
| $I_{\text{VDD1P2}}$ | Group 2A: VDD1P2FB + VDD1P2RX   |   |   | 610     |     | mA   |
|                     | Group 2B: VDD1P2TXCLK + VDD1P2TXENC                                     |   |   | 280     |     | mA   |
|                     | Group 2C: VDD1P2FBCML + VDD1P2RXCML + VDD1P2PLLCLKREF                   |   |   | 72      |     | mA   |
| $I_{\text{VDD0P9}}$ | Group 1A: DVDD0P9 + VDDT0P9   |   |   | 2360    |     | mA   |
| $P_{\text{diss}}$   | Power Dissipation   |   |   | 6460    |     | mW   |

**AFE7950-SP, AFE7950-SEP**

SBASAG7B – MARCH 2024 – REVISED JUNE 2026

Typical values at  $T_A = +25^\circ\text{C}$ , full temperature range is  $T_{A,\text{MIN}} = -40^\circ\text{C}$  to  $T_{J,\text{MAX}} = +110^\circ\text{C}$ ; TX Input Rate = 491.52MSPS,  $f_{\text{DAC}} = 8847.36\text{MSPS}$  interleave mode;  $f_{\text{ADC}} = 2949.12\text{MSPS}$ ; nominal power supplies; 1 tone at -1 dBFS; DSA Attenuation = 0dB; SerDes rate = 24.33Gbps; unless otherwise noted.

| PARAMETER           |   | TEST CONDITIONS  | MIN  | TYP   | MAX  | UNIT |
|---------------------|---|--|--|-------|------|------|
| $I_{\text{VDD1P8}}$ | Group 3A: VDD1P8FB + VDD1P8RX + VDD1P8TX                                | Mode 11c: TDD 4T4R1FB average<br>TX/FB: 75%, RX 25%<br>Single Band: 8x Int, FB 2x Dec, RX uses<br>FB TX/FB/RX Rate = 1474.56 Msps $f_{\text{DAC}} = 11796.48\text{ MSPS}$ $f_{\text{ADC}} = 2949.12\text{ MSPS}$<br>$f_{\text{TX}} = f_{\text{RX}} = 8\text{ GHz}$ 64/66 coding, 24.33<br>Gbps TX: 8-8-2-1, FB/RX: 4-4-4-2 |  | 790   |      | mA   |
|                     | Group 3B: VDD1P8FBCLK + VDD1P8RXCLK + VDD1P8TXDAC+ VDD1P8GPIO + VDDA1P8 |  |  | 850   |      | mA   |
|                     | Group 3C: VDD1P8PLL + VDD1P8PLLCO                                       |  |  | 73    |      | mA   |
| $I_{\text{VDD1P2}}$ | Group 2A: VDD1P2FB + VDD1P2RX   |  |  | 300   |      | mA   |
|                     | Group 2B: VDD1P2TXCLK + VDD1P2TXENC                                     |  |  | 1150  |      | mA   |
|                     | Group 2C: VDD1P2FBCML + VDD1P2RXCML + VDD1P2PLLCLKREF                   |  |  | 75    |      | mA   |
| $I_{\text{VDD0P9}}$ | Group 1A: DVDD0P9 + VDDT0P9   |  |  | 2890  |      | mA   |
| $P_{\text{diss}}$   | Power Dissipation   |  |  | 7620  |      | mW   |
| $I_{\text{VDD1P8}}$ | Group 3A: VDD1P8FB + VDD1P8RX + VDD1P8TX                                |  | Mode 11d: FDD 4T4R<br>Single Band: 8x Int, RX uses FB<br>TX/FB/RX Rate = 1474.56 Msps $f_{\text{DAC}} = 11796.48\text{ MSPS}$ $f_{\text{ADC}} = 2949.12\text{ MSPS}$<br>$f_{\text{TX}} = f_{\text{RX}} = 8\text{ GHz}$ 64/66 coding, 24.33<br>Gbps TX: 8-8-2-1, FB/RX: 4-4-4-2 |       | 1260 |      |
|                     | Group 3B: VDD1P8FBCLK + VDD1P8RXCLK + VDD1P8TXDAC+ VDD1P8GPIO + VDDA1P8 |  |  | 940   |      | mA   |
|                     | Group 3C: VDD1P8PLL + VDD1P8PLLCO                                       |  |  | 73    |      | mA   |
| $I_{\text{VDD1P2}}$ | Group 2A: VDD1P2FB + VDD1P2RX   |  |  | 630   |      | mA   |
|                     | Group 2B: VDD1P2TXCLK + VDD1P2TXENC                                     |  |  | 1480  |      | mA   |
|                     | Group 2C: VDD1P2FBCML + VDD1P2RXCML + VDD1P2PLLCLKREF                   |  |  | 78    |      | mA   |
| $I_{\text{VDD0P9}}$ | Group 1A: DVDD0P9 + VDDT0P9   |  |  | 4200  |      | mA   |
| $P_{\text{diss}}$   | Power Dissipation   |  |  | 10640 |      | mW   |

## 4.10 Timing Requirements

Typical values at  $T_A = +25^\circ\text{C}$ , full temperature range is  $T_{A,\text{MIN}} = -40^\circ\text{C}$  to  $T_{J,\text{MAX}} = +110^\circ\text{C}$ ; TX Input Rate = 491.52MSPS,  $f_{\text{DAC}} = 8847.36\text{MSPS}$ ;  $f_{\text{ADC}} = 2949.12\text{MSPS}$ ; nominal power supplies; 1 tone at -1 dBFS; DSA Attenuation = 0dB; SerDes rate = 24.33Gbps; unless otherwise noted.

|                                  |   | MIN | NOM                   | MAX | UNIT |
|----------------------------------|---|-----|-----------------------|-----|------|
| <b>Timing: SYSREF+/-</b>         |   |     |                       |     |      |
| $t_{\text{s}}(\text{SYSREF})$    | Setup Time, SYSREF+/- Valid to Rising Edge of CLK+/-          |     | 50                    |     | ps   |
| $t_{\text{h}}(\text{SYSREF})$    | Hold Time, SYSREF+/- Valid after Rising Edge of CLK+/-        |     | 50                    |     | ps   |
| <b>Timing: Serial ports</b>      |   |     |                       |     |      |
| $t_{\text{s}}(\text{SENB})$      | Setup Time, SENB to Rising Edge of SCLK                       |     | 15                    |     | ns   |
| $t_{\text{h}}(\text{SENB})$      | Hold Time, SENB after last Rising Edge of SCLK <sup>(1)</sup> |     | $5 + t_{\text{SCLK}}$ |     | ns   |
| $t_{\text{s}}(\text{SDIO})$      | Setup Time, SDIO valid to Rising Edge of SCLK                 |     | 15                    |     | ns   |
| $t_{\text{h}}(\text{SDIO})$      | Hold Time, SDIO valid after Rising Edge of SCLK               |     | 5                     |     | ns   |
| $t_{\text{(SCLK)_W}}$            | Minimum SCLK period: registers write                          |     | 25                    |     | ns   |
| $t_{\text{(SCLK)_R}}$            | Minimum SCLK period: registers read                           |     | 50                    |     | ns   |
| $t_{\text{(SCLK)_R}}$            | SCLK period: temp sensor <sup>(2)</sup>                       |     | 1000                  |     | ns   |
| $t_{\text{d}}(\text{data\_out})$ | Minimum Data Output delay after Falling Edge of SCLK          |     | 0                     |     | ns   |
|                                  | Maximum Data Output delay after Falling Edge of SCLK          |     | 15                    |     | ns   |
| $t_{\text{RESET}}$               | Minimum RESETZ Pulse Width                                    |     | 1                     |     | ms   |

- (1) SDEN\ need to be held one more extra clock cycle with the last SCLK edge  
(2) Temp sensor requires a maximum of 1MHz SCLK cycle.

## 4.11 Switching Characteristics

Typical values at  $T_A = +25^\circ\text{C}$ , full temperature range is  $T_{A,\text{MIN}} = -40^\circ\text{C}$  to  $T_{J,\text{MAX}} = +110^\circ\text{C}$ ; TX Input Rate = 491.52MSPS,  $f_{\text{DAC}} = 8847.36\text{MSPS}$ ;  $f_{\text{ADC}} = 2949.12\text{MSPS}$ ; nominal power supplies; 1 tone at -1 dBFS; DSA Attenuation = 0dB; SerDes rate = 24.33Gbps; unless otherwise noted.

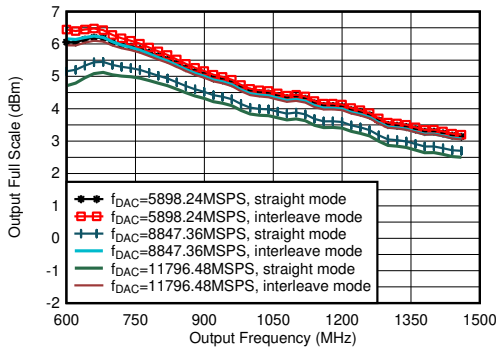
| PARAMETER                 |                                 | TEST CONDITIONS   | MIN | TYP | MAX | UNIT                                  |
|---------------------------|---------------------------------|---|-----|-----|-----|---------------------------------------|
| <b>TX Channel Latency</b> |                                 |   |     |     |     |                                       |
| $t_{\text{JESD TX}}$      | JESD to TX output Latency       | LMFSHd=2-8-8-1, 368.64 MSPS input rate, 24x Interpolation, Serdes rate = 16.22Gbps (JESD204C) |     | 152 |     | interface clock cycles <sup>(1)</sup> |
|                           |                                 | LMFSHd=8-16-4-1, 491.52 MSPS 24x Interpolation, Serdes rate = 16.22Gbps (JESD204C)            |     | 176 |     |                                       |
|                           |                                 | LMFSHd=4-16-8-1, 245.76 MSPS 48x Interpolation, Serdes rate = 16.22Gbps (JESD204C)            |     | 124 |     |                                       |
|                           |                                 | LMFSHd=2-16-16-1, 122.88 MSPS 96x Interpolation, Serdes rate = 16.22Gbps (JESD204C)           |     | 97  |     |                                       |
| <b>RX Channel Latency</b> |                                 |   |     |     |     |                                       |
|                           | SerDes Transmitter Analog Delay |   |     | 3.6 |     | ns                                    |
| $t_{\text{JESD RX}}$      | RX input to JESD output Latency | LMFS=2-16-16-1, 122.88 MSPS, 24x Decimation, Serdes rate = 16.22Gbps (JESD204C)               |     | 92  |     | interface clock cycles <sup>(1)</sup> |
|                           |                                 | LMFS=4-16-8-1, 245.76 MSPS, 12x Decimation, Serdes rate = 16.22Gbps (JESD204C)                |     | 108 |     |                                       |
|                           |                                 | LMFS=4-8-4-1, 491.52 MSPS, 6x Decimation, Serdes rate = 16.22Gbps (JESD204C)                  |     | 153 |     |                                       |
| <b>FB Channel Latency</b> |                                 |   |     |     |     |                                       |
|                           | SerDes Transmitter Analog Delay |   |     | 3.6 |     | ns                                    |
| $t_{\text{JESD FB}}$      | FB input to JESD output Latency | LMFS=1-2-8-1, 368.64 MSPS, 8x Decimation  |     | 151 |     | interface clock cycles <sup>(1)</sup> |
|                           |                                 | LMFS=2-4-4-1, 491.52 MSPS, 6x Decimation  |     | 177 |     |                                       |

(1) Interface clock cycles is the period of the digital interface sample rate, e.g. 1GSPS = 1ns.

## 4.12 Typical Characteristics

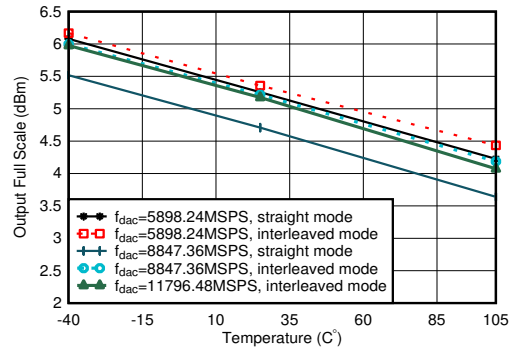
### 4.12.1 TX Typical Characteristics 800MHz

Typical values at  $T_A = +25^\circ\text{C}$  with nominal supplies. Default conditions: TX input data rate = 491.52MSPS,  $f_{DAC} = 11796.48\text{MSPS}$  (24x interpolation), interleave mode, 1<sup>st</sup> Nyquist zone output, PLL clock mode with  $f_{REF} = 491.52\text{MHz}$ ,  $A_{OUT} = -1\text{dBFS}$ , DSA = 0dB, Sin(x)/x enabled, DSA calibrated



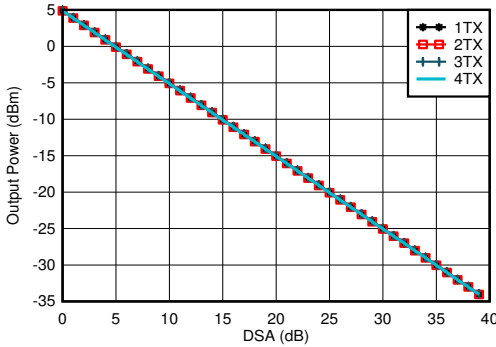
including PCB and cable losses,  $A_{out} = -0.5\text{dBFS}$ , DSA = 0, 0.8GHz matching

**Figure 4-1. TX Output Fullscale vs Output Frequency**



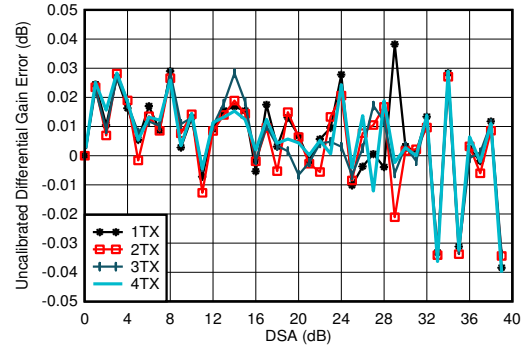
including PCB and cable losses,  $A_{out} = -0.5\text{dBFS}$ , DSA = 0, 0.8GHz matching

**Figure 4-2. TX Output Fullscale vs Temperature**



$f_{DAC} = 11796.48\text{MSPS}$ , interleave mode,  $A_{out} = -0.5\text{dBFS}$ , matching 0.8GHz

**Figure 4-3. TX Output Power vs DSA Setting and Channel at 0.85GHz**

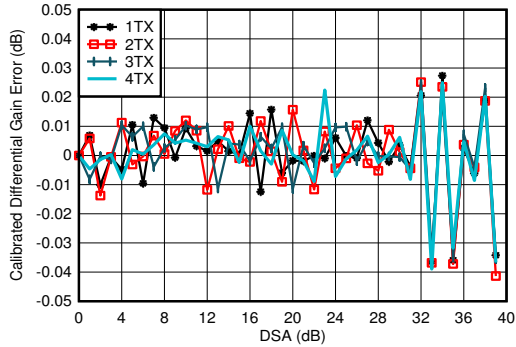


$f_{DAC} = 5898.24\text{MSPS}$ , interleave mode, matching at 0.8GHz  
Differential Gain Error =  $P_{OUT}(\text{DSA Setting} - 1) - P_{OUT}(\text{DSA Setting}) + 1$

**Figure 4-4. TX Uncalibrated Differential Gain Error vs DSA Setting and Channel at 0.85GHz**

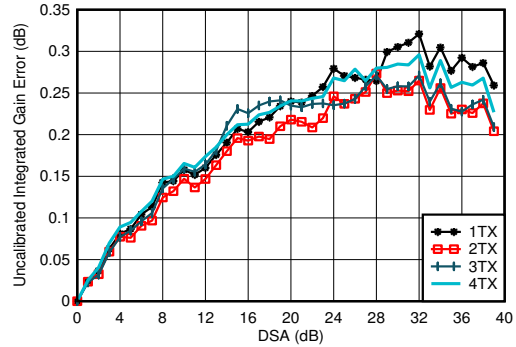
### 4.12.1 TX Typical Characteristics 800MHz (continued)

Typical values at  $T_A = +25^\circ\text{C}$  with nominal supplies. Default conditions: TX input data rate = 491.52MSPS,  $f_{\text{DAC}} = 11796.48\text{MSPS}$  (24x interpolation), interleave mode, 1<sup>st</sup> Nyquist zone output, PLL clock mode with  $f_{\text{REF}} = 491.52\text{MHz}$ ,  $A_{\text{OUT}} = -1\text{dBFS}$ , DSA = 0dB, Sin(x)/x enabled, DSA calibrated



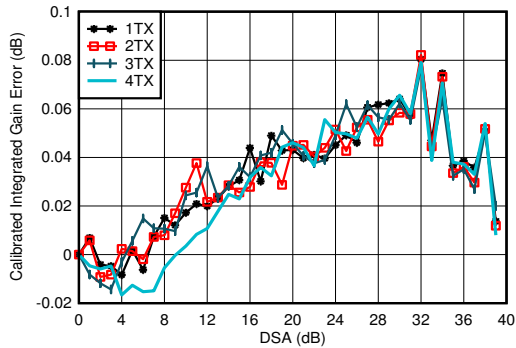
$f_{\text{DAC}} = 5898.24\text{MSPS}$ , interleave mode, matching at 0.8GHz  
 Differential Gain Error =  $P_{\text{OUT}}(\text{DSA Setting} - 1) - P_{\text{OUT}}(\text{DSA Setting}) + 1$

**Figure 4-5. TX Calibrated Differential Gain Error vs DSA Setting and Channel at 0.85GHz**



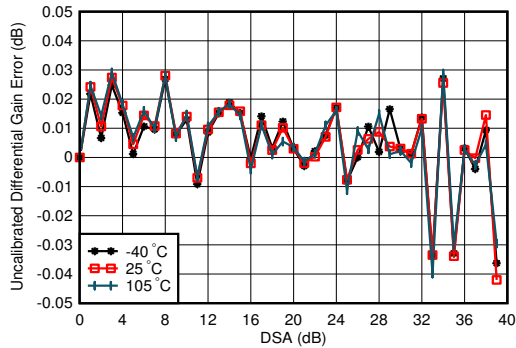
$f_{\text{DAC}} = 5898.24\text{MSPS}$ , interleave mode, matching at 0.8GHz  
 Integrated Gain Error =  $P_{\text{OUT}}(\text{DSA Setting}) - P_{\text{OUT}}(\text{DSA Setting} = 0) + \text{DSA Settings}$

**Figure 4-6. TX Uncalibrated Integrated Gain Error vs DSA Setting and Channel at 0.85GHz**



$f_{\text{DAC}} = 5898.24\text{MSPS}$ , interleave mode, matching at 0.8GHz  
 Integrated Gain Error =  $P_{\text{OUT}}(\text{DSA Setting}) - P_{\text{OUT}}(\text{DSA Setting} = 0) + \text{DSA Setting}$

**Figure 4-7. TX Calibrated Integrated Gain Error vs DSA Setting and Channel at 0.85GHz**

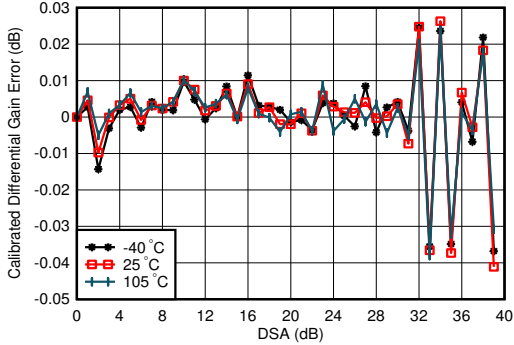


$f_{\text{DAC}} = 5898.24\text{MSPS}$ , interleave mode, matching at 0.8GHz  
 Differential Gain Error =  $P_{\text{OUT}}(\text{DSA Setting} - 1) - P_{\text{OUT}}(\text{DSA Setting}) + 1$

**Figure 4-8. TX Uncalibrated Differential Gain Error vs DSA Setting and Temperature at 0.85GHz**

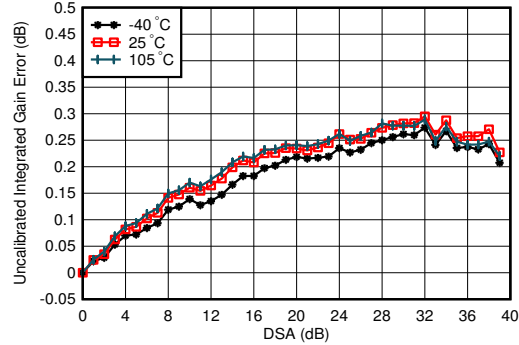
**4.12.1 TX Typical Characteristics 800MHz (continued)**

Typical values at  $T_A = +25^\circ\text{C}$  with nominal supplies. Default conditions: TX input data rate = 491.52MSPS,  $f_{\text{DAC}} = 11796.48\text{MSPS}$  (24x interpolation), interleave mode, 1<sup>st</sup> Nyquist zone output, PLL clock mode with  $f_{\text{REF}} = 491.52\text{MHz}$ ,  $A_{\text{OUT}} = -1\text{dBFS}$ , DSA = 0dB, Sin(x)/x enabled, DSA calibrated



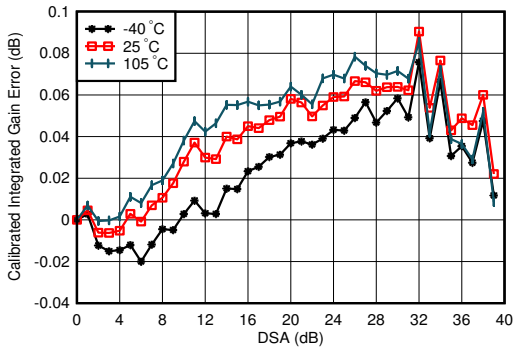
$f_{\text{DAC}} = 5898.24\text{MSPS}$ , interleave mode, matching at 0.8GHz  
Differential Gain Error =  $P_{\text{OUT}}(\text{DSA Setting} - 1) - P_{\text{OUT}}(\text{DSA Setting}) + 1$

**Figure 4-9. TX Calibrated Differential Gain Error vs DSA Setting and Temperature at 0.85GHz**



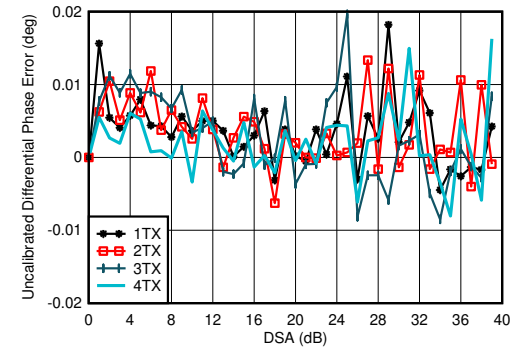
$f_{\text{DAC}} = 5898.24\text{MSPS}$ , interleave mode, matching at 0.8GHz  
Integrated Gain Error =  $P_{\text{OUT}}(\text{DSA Setting}) - P_{\text{OUT}}(\text{DSA Setting} = 0) + \text{DSA Setting}$

**Figure 4-10. TX Uncalibrated Integrated Gain Error vs DSA Setting and Temperature at 0.85GHz**



$f_{\text{DAC}} = 5898.24\text{MSPS}$ , interleave mode, matching at 0.8GHz  
Integrated Gain Error =  $P_{\text{OUT}}(\text{DSA Setting}) - P_{\text{OUT}}(\text{DSA Setting} = 0) + \text{DSA Setting}$

**Figure 4-11. TX Calibrated Integrated Gain Error vs DSA Setting and Temperature at 0.85GHz**

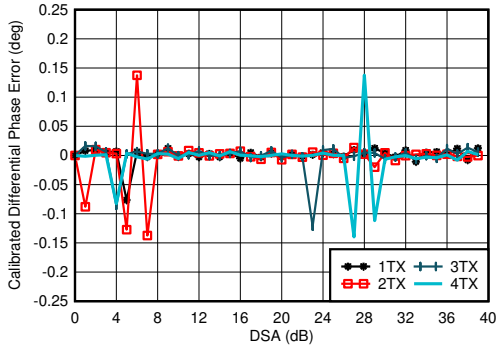


$f_{\text{DAC}} = 5898.24\text{MSPS}$ , interleave mode, matching at 0.8GHz  
Differential Phase Error =  $\text{Phase}_{\text{OUT}}(\text{DSA Setting} - 1) - \text{Phase}_{\text{OUT}}(\text{DSA Setting})$

**Figure 4-12. TX Uncalibrated Differential Phase Error vs DSA Setting and Channel at 0.85GHz**

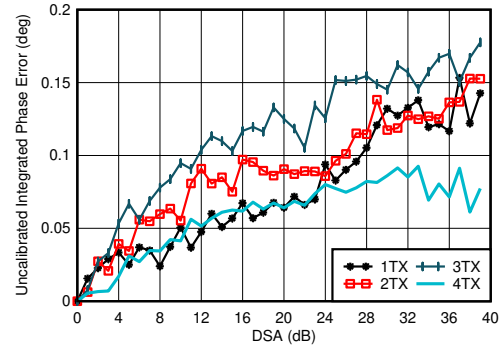
**4.12.1 TX Typical Characteristics 800MHz (continued)**

Typical values at  $T_A = +25^\circ\text{C}$  with nominal supplies. Default conditions: TX input data rate = 491.52MSPS,  $f_{\text{DAC}} = 11796.48\text{MSPS}$  (24x interpolation), interleave mode, 1<sup>st</sup> Nyquist zone output, PLL clock mode with  $f_{\text{REF}} = 491.52\text{MHz}$ ,  $A_{\text{OUT}} = -1\text{dBFS}$ , DSA = 0dB, Sin(x)/x enabled, DSA calibrated



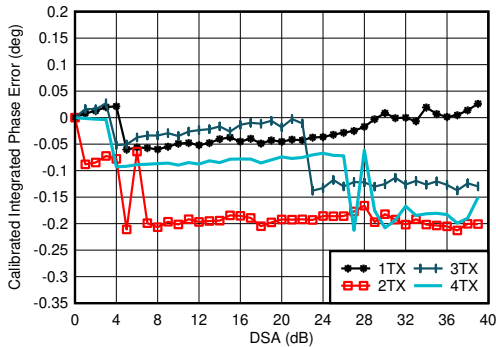
$f_{\text{DAC}} = 5898.24\text{MSPS}$ , interleave mode, matching at 0.8GHz  
 Differential Phase Error =  $\text{Phase}_{\text{OUT}}(\text{DSA Setting} - 1) - \text{Phase}_{\text{OUT}}(\text{DSA Setting})$   
 Phase DNL spike may occur at any DSA setting.

**Figure 4-13. TX Calibrated Differential Phase Error vs DSA Setting and Channel at 0.85GHz**



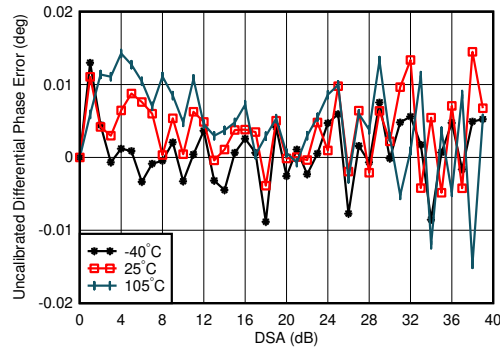
$f_{\text{DAC}} = 5898.24\text{MSPS}$ , interleave mode, matching at 0.8GHz  
 Integrated Phase Error =  $\text{Phase}_{\text{OUT}}(\text{DSA Setting}) - \text{Phase}_{\text{OUT}}(\text{DSA Setting} = 0)$

**Figure 4-14. TX Uncalibrated Integrated Phase Error vs DSA Setting and Channel at 0.85GHz**



$f_{\text{DAC}} = 5898.24\text{MSPS}$ , interleave mode, matching at 0.8GHz  
 Integrated Phase Error =  $\text{Phase}_{\text{OUT}}(\text{DSA Setting}) - \text{Phase}_{\text{OUT}}(\text{DSA Setting} = 0)$

**Figure 4-15. TX Calibrated Integrated Phase Error vs DSA Setting and Channel at 0.85GHz**

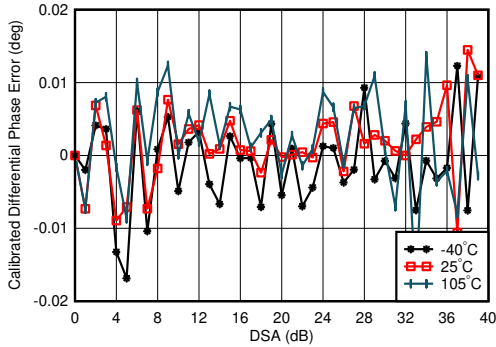


$f_{\text{DAC}} = 5898.24\text{MSPS}$ , interleave mode, matching at 0.8GHz  
 Differential Phase Error =  $\text{Phase}_{\text{OUT}}(\text{DSA Setting} - 1) - \text{Phase}_{\text{OUT}}(\text{DSA Setting}) + 1$

**Figure 4-16. TX Uncalibrated Differential Phase Error vs DSA Setting and Temperature at 0.85GHz**

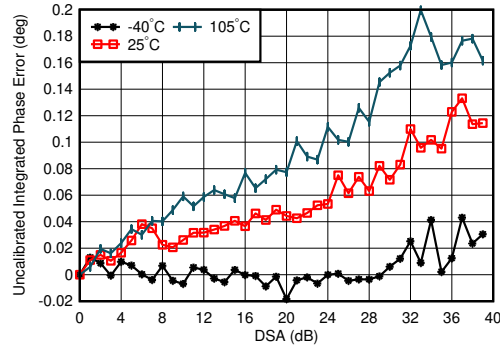
**4.12.1 TX Typical Characteristics 800MHz (continued)**

Typical values at  $T_A = +25^\circ\text{C}$  with nominal supplies. Default conditions: TX input data rate = 491.52MSPS,  $f_{\text{DAC}} = 11796.48\text{MSPS}$  (24x interpolation), interleave mode, 1<sup>st</sup> Nyquist zone output, PLL clock mode with  $f_{\text{REF}} = 491.52\text{MHz}$ ,  $A_{\text{OUT}} = -1\text{dBFS}$ , DSA = 0dB, Sin(x)/x enabled, DSA calibrated



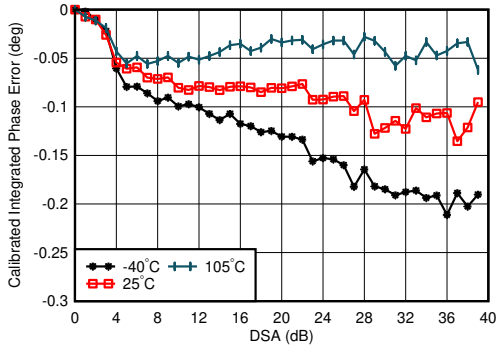
$f_{\text{DAC}} = 5898.24\text{MSPS}$ , interleave mode, matching at 0.8GHz, channel with the median variation over DSA setting at 25°C  
 Differential Phase Error =  $\text{Phase}_{\text{OUT}}(\text{DSA Setting} - 1) - \text{Phase}_{\text{OUT}}(\text{DSA Setting}) + 1$

**Figure 4-17. TX Calibrated Differential Phase Error vs DSA Setting and Temperature at 0.85GHz**



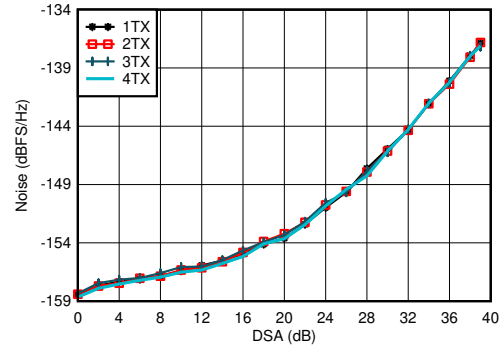
$f_{\text{DAC}} = 5898.24\text{MSPS}$ , interleave mode, matching at 0.8GHz  
 Integrated Phase Error =  $\text{Phase}_{\text{OUT}}(\text{DSA Setting}) - \text{Phase}_{\text{OUT}}(\text{DSA Setting} = 0)$

**Figure 4-18. TX Uncalibrated Integrated Phase Error vs DSA Setting and Temperature at 0.85GHz**



$f_{\text{DAC}} = 5898.24\text{MSPS}$ , interleave mode, matching at 0.8GHz  
 Integrated Phase Error =  $\text{Phase}_{\text{OUT}}(\text{DSA Setting}) - \text{Phase}_{\text{OUT}}(\text{DSA Setting} = 0)$

**Figure 4-19. TX Calibrated Integrated Phase Error vs DSA Setting and Temperature at 0.85GHz**

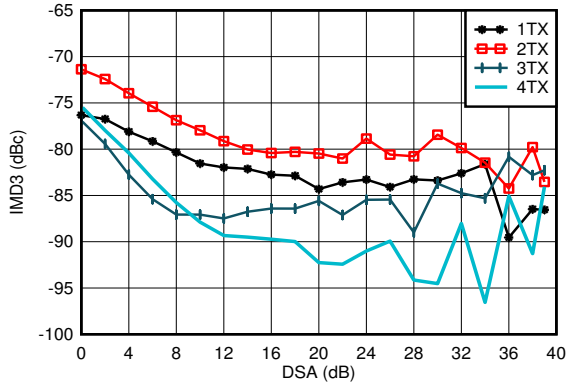


$f_{\text{DAC}} = 5898.24\text{MSPS}$ , interleave mode, matching at 0.8GHz,  
 $P_{\text{OUT}} = -13\text{ dBFS}$

**Figure 4-20. TX Output Noise vs Channel and Attenuation at 0.85GHz**

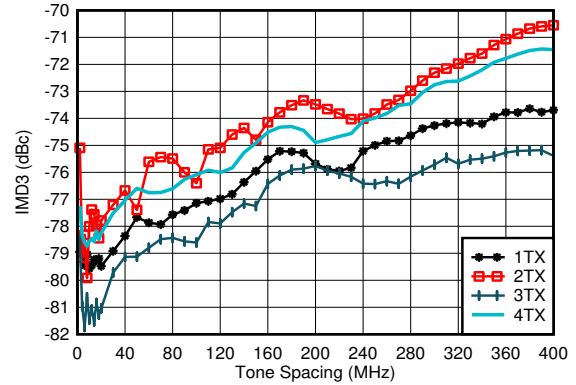
**4.12.1 TX Typical Characteristics 800MHz (continued)**

Typical values at  $T_A = +25^\circ\text{C}$  with nominal supplies. Default conditions: TX input data rate = 491.52MSPS,  $f_{DAC} = 11796.48\text{MSPS}$  (24x interpolation), interleave mode, 1<sup>st</sup> Nyquist zone output, PLL clock mode with  $f_{REF} = 491.52\text{MHz}$ ,  $A_{OUT} = -1\text{dBFS}$ , DSA = 0dB, Sin(x)/x enabled, DSA calibrated



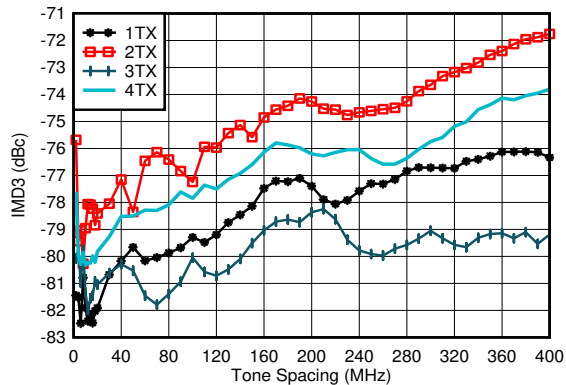
$f_{DAC} = 11796.48\text{MSPS}$ , interleave mode,  $f_{CENTER} = 0.85\text{GHz}$ , matching at 0.8 GHz,  $-13\text{dBFS}$  each tone

**Figure 4-21. TX IMD3 vs DSA Setting at 0.85GHz**



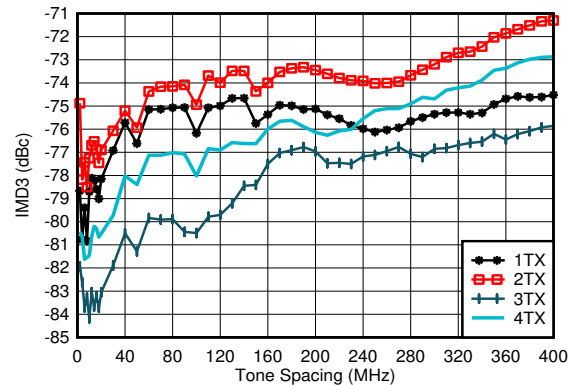
$f_{DAC} = 5898.24\text{MSPS}$ , straight mode,  $f_{CENTER} = 0.85\text{GHz}$ , matching at 0.8GHz,  $-13\text{dBFS}$  each tone

**Figure 4-22. TX IMD3 vs Tone Spacing and Channel at 0.85GHz**



$f_{DAC} = 8847.36\text{MSPS}$ , straight mode,  $f_{CENTER} = 0.85\text{GHz}$ , matching at 0.8GHz,  $-13\text{dBFS}$  each tone

**Figure 4-23. TX IMD3 vs Tone Spacing and Channel at 0.85GHz**

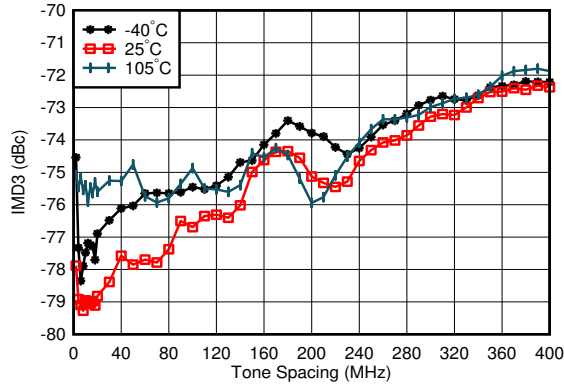


$f_{DAC} = 11796.48\text{MSPS}$ , interleave mode,  $f_{CENTER} = 0.85\text{GHz}$ , matching at 0.8GHz,  $-13\text{dBFS}$  each tone

**Figure 4-24. TX IMD3 vs Tone Spacing and Channel at 0.85GHz**

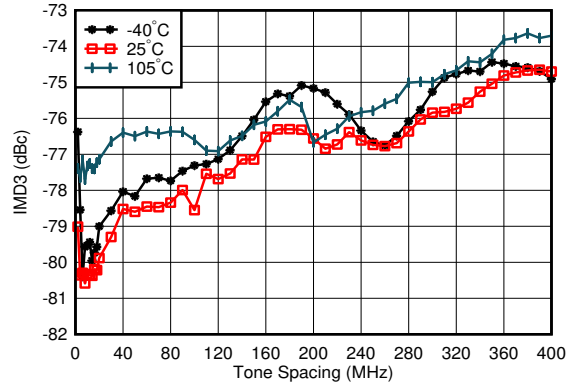
**4.12.1 TX Typical Characteristics 800MHz (continued)**

Typical values at  $T_A = +25^\circ\text{C}$  with nominal supplies. Default conditions: TX input data rate = 491.52MSPS,  $f_{\text{DAC}} = 11796.48\text{MSPS}$  (24x interpolation), interleave mode, 1<sup>st</sup> Nyquist zone output, PLL clock mode with  $f_{\text{REF}} = 491.52\text{MHz}$ ,  $A_{\text{OUT}} = -1\text{dBFS}$ , DSA = 0dB, Sin(x)/x enabled, DSA calibrated



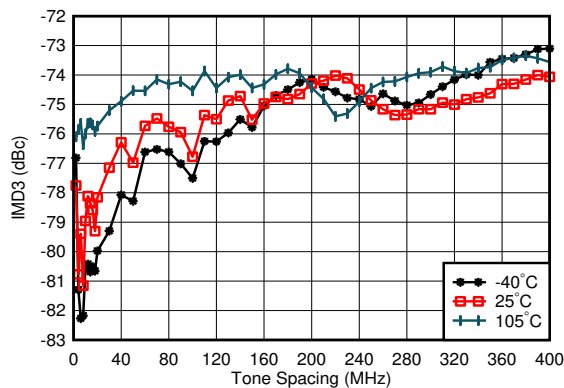
$f_{\text{DAC}} = 5898.24\text{MSPS}$ , straight mode,  $f_{\text{CENTER}} = 0.85\text{GHz}$ , matching at 0.8GHz, -13dBFS each tone, worst channel

**Figure 4-25. TX IMD3 vs Tone Spacing and Temperature at 0.85GHz**



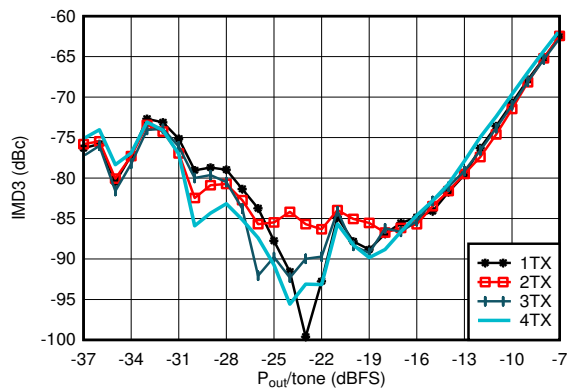
$\text{DAC} = 8847.3 \text{ MSPS}$ , straight mode,  $f_{\text{CENTER}} = 0.85\text{GHz}$ , matching at 0.8 GHz, -13dBFS each tone, worst channel

**Figure 4-26. TX IMD3 vs Tone Spacing and Temperature at 0.85GHz**



$f_{\text{DAC}} = 11796.48\text{MSPS}$ , straight mode,  $f_{\text{CENTER}} = 0.85\text{GHz}$ , matching at 0.8GHz, -13dBFS each tone, worst channel

**Figure 4-27. TX IMD3 vs Tone Spacing and Temperature at 0.85GHz**



$f_{\text{DAC}} = 5898.24\text{MSPS}$ , straight mode,  $f_{\text{CENTER}} = 0.85\text{GHz}$ ,  $f_{\text{SPACING}} = 20\text{MHz}$ , matching at 0.8GHz

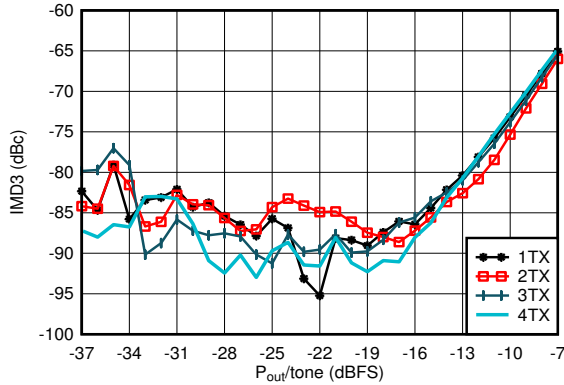
**Figure 4-28. TX IMD3 vs Digital Level at 0.85GHz**

**AFE7950-SP, AFE7950-SEP**

SBASAG7B – MARCH 2024 – REVISED JUNE 2026

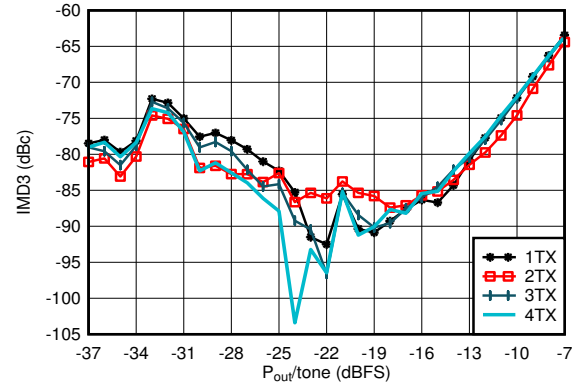
**4.12.1 TX Typical Characteristics 800MHz (continued)**

Typical values at  $T_A = +25^\circ\text{C}$  with nominal supplies. Default conditions: TX input data rate = 491.52MSPS,  $f_{DAC} = 11796.48\text{MSPS}$  (24x interpolation), interleave mode, 1<sup>st</sup> Nyquist zone output, PLL clock mode with  $f_{REF} = 491.52\text{MHz}$ ,  $A_{OUT} = -1\text{dBFS}$ , DSA = 0dB, Sin(x)/x enabled, DSA calibrated



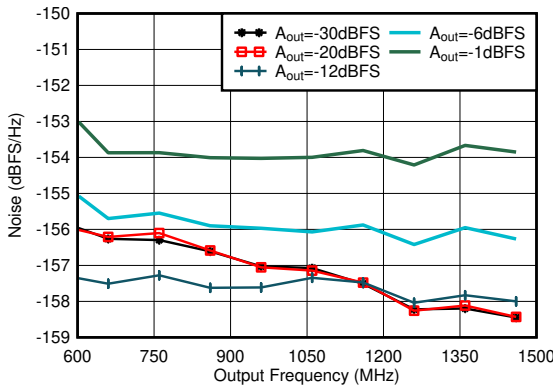
$f_{DAC} = 8847.36\text{MSPS}$ , straight mode,  $f_{CENTER} = 0.85\text{GHz}$ ,  $f_{SPACING} = 20\text{MHz}$ , matching at 0.8GHz

**Figure 4-29. TX IMD3 vs Digital Level at 0.85GHz**



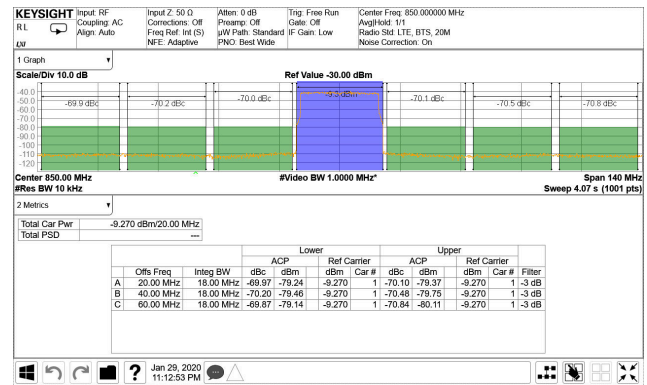
$f_{DAC} = 11796.48\text{MSPS}$ , interleave mode,  $f_{CENTER} = 0.85\text{GHz}$ ,  $f_{SPACING} = 20\text{MHz}$ , matching at 0.8GHz

**Figure 4-30. TX IMD3 vs Digital Level at 0.85GHz**



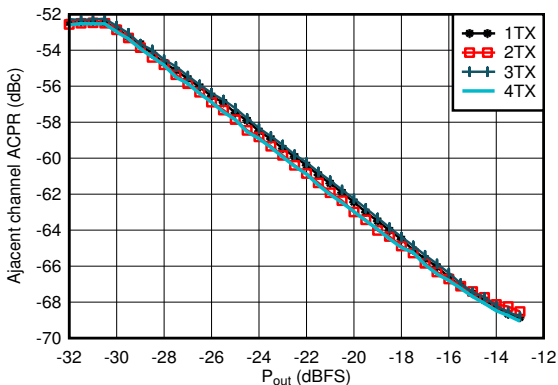
Matching at 2.6GHz, Single tone,  $f_{DAC} = 11.79648\text{GSPPS}$ , interleave mode, 40MHz offset, DSA = 0dB

**Figure 4-31. TX Single Tone Output Noise vs Frequency and Amplitude at 0.85GHz**



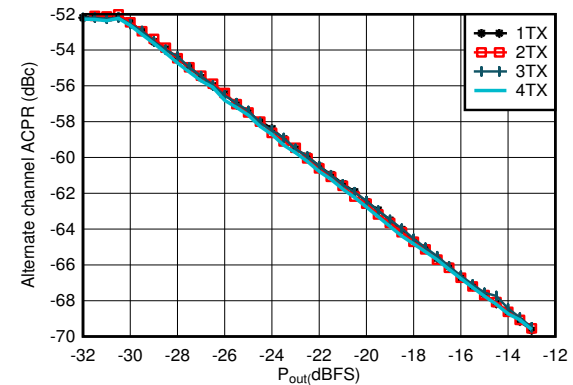
TM1.1,  $P_{OUT\_RMS} = -13\text{dBFS}$

**Figure 4-32. TX 20-MHz LTE Output Spectrum at 0.85 GHz**



Matching at 0.8GHz, single carrier 20MHz BW TM1.1 LTE

**Figure 4-33. TX 20-MHz LTE ACPR vs Digital Level at 0.85GHz**

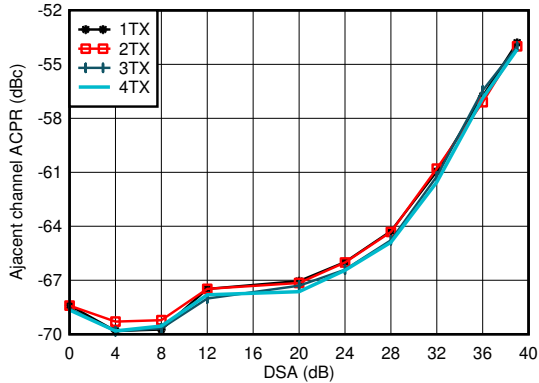


Matching at 0.8GHz, single carrier 20MHz BW TM1.1 LTE

**Figure 4-34. TX 20MHz LTE alt-ACPR vs Digital Level at 0.85GHz**

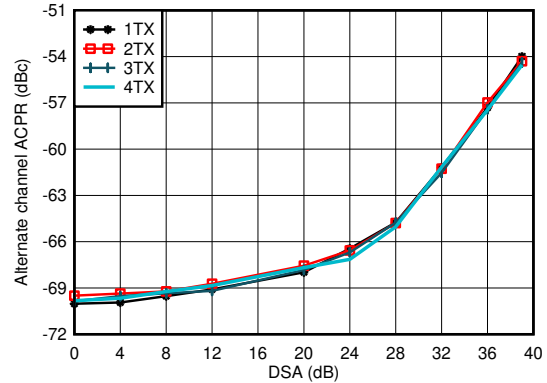
**4.12.1 TX Typical Characteristics 800MHz (continued)**

Typical values at  $T_A = +25^\circ\text{C}$  with nominal supplies. Default conditions: TX input data rate = 491.52MSPS,  $f_{DAC} = 11796.48\text{MSPS}$  (24x interpolation), interleave mode, 1<sup>st</sup> Nyquist zone output, PLL clock mode with  $f_{REF} = 491.52\text{MHz}$ ,  $A_{OUT} = -1\text{dBFS}$ , DSA = 0dB, Sin(x)/x enabled, DSA calibrated



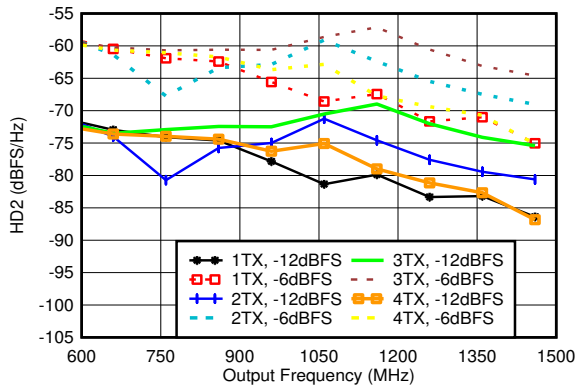
Matching at 0.8GHz, single carrier 20MHz BW TM1.1 LTE

**Figure 4-35. TX 20MHz LTE ACPR vs DSA at 0.85GHz**



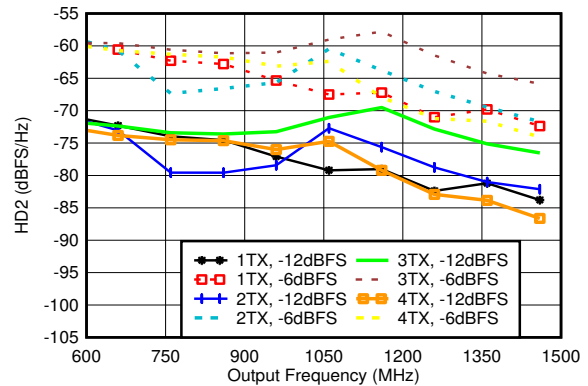
Matching at 0.8GHz, single carrier 20MHz BW TM1.1 LTE

**Figure 4-36. TX 20-MHz LTE alt-ACPR vs DSA at 0.85GHz**



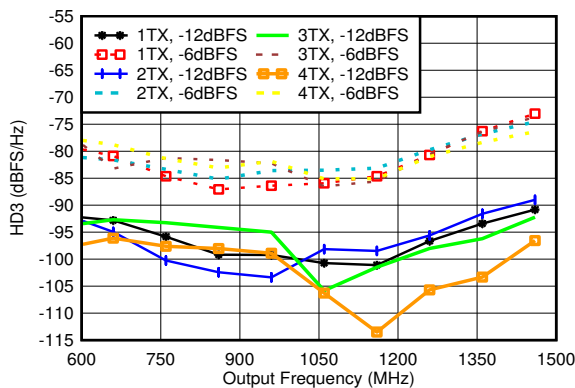
Matching at 0.8GHz,  $f_{DAC} = 5898.2\text{ GSPS}$ , straight mode

**Figure 4-37. TX HD2 vs Digital Amplitude and Output Frequency at 0.85GHz**



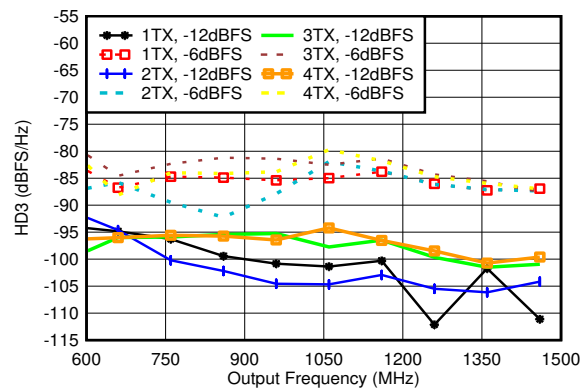
Matching at 0.8GHz,  $f_{DAC} = 8847.36\text{GSPS}$ , straight mode

**Figure 4-38. TX HD2 vs Digital Amplitude and Output Frequency at 0.85GHz**



Matching at 0.8GHz,  $f_{DAC} = 5898.24\text{MSPS}$ , straight mode, normalized to output power at harmonic frequency

**Figure 4-39. TX HD3 vs Digital Amplitude and Output Frequency at 0.85GHz**

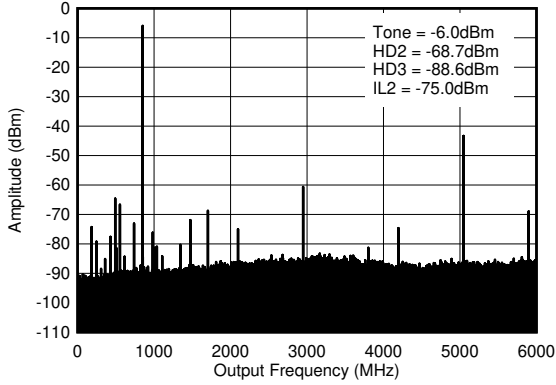


Matching at 0.8GHz,  $f_{DAC} = 8847.36\text{MSPS}$ , straight mode, normalized to output power at harmonic frequency

**Figure 4-40. TX HD3 vs Digital Amplitude and Output Frequency at 0.85GHz**

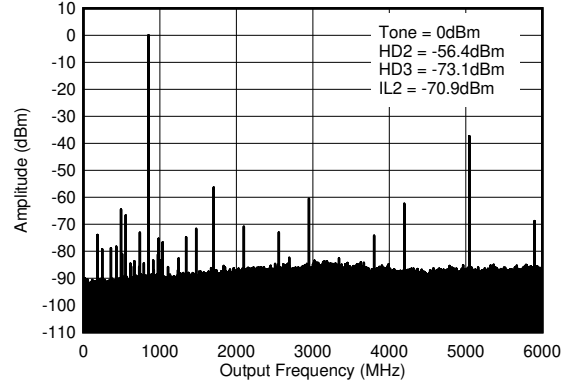
**4.12.1 TX Typical Characteristics 800MHz (continued)**

Typical values at  $T_A = +25^\circ\text{C}$  with nominal supplies. Default conditions: TX input data rate = 491.52MSPS,  $f_{\text{DAC}} = 11796.48\text{MSPS}$  (24x interpolation), interleave mode, 1<sup>st</sup> Nyquist zone output, PLL clock mode with  $f_{\text{REF}} = 491.52\text{MHz}$ ,  $A_{\text{OUT}} = -1\text{dBFS}$ , DSA = 0dB, Sin(x)/x enabled, DSA calibrated



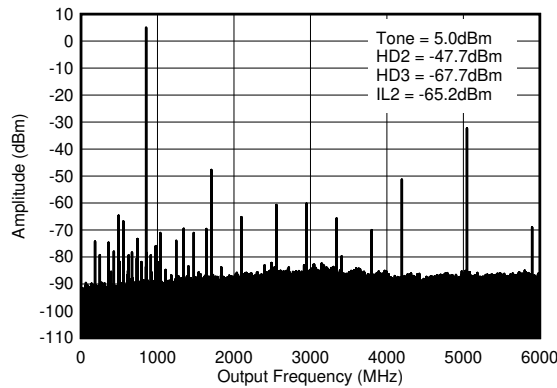
$f_{\text{DAC}} = 5898.24\text{MSPS}$ , interleave mode, 0.8GHz matching, includes PCB and cable losses.  $\text{ILn} = f_s/n \pm f_{\text{OUT}}$ .

**Figure 4-41. TX Single Tone (-12 dBFS) Output Spectrum at 0.85GHz (0- $f_{\text{DAC}}$ )**



$f_{\text{DAC}} = 5898.2\text{MSPS}$ , interleave mode, 0.8GHz matching, includes PCB and cable losses.  $\text{ILn} = f_s/n \pm f_{\text{OUT}}$ .

**Figure 4-42. TX Single Tone (-6dBFS) Output Spectrum at 0.85GHz (0- $f_{\text{DAC}}$ )**

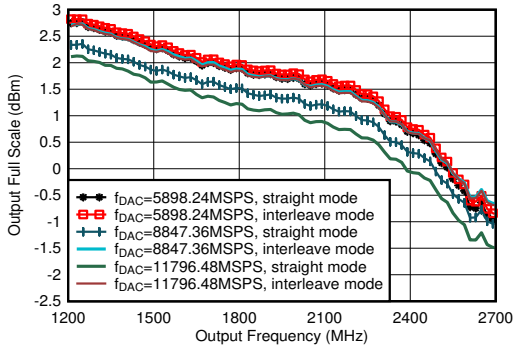


$f_{\text{DAC}} = 5898.24\text{MSPS}$ , interleave mode, 0.8GHz matching, includes PCB and cable losses.  $\text{ILn} = f_s/n \pm f_{\text{OUT}}$ .

**Figure 4-43. TX Single Tone (-1dBFS) Output Spectrum at 0.85GHz (0- $f_{\text{DAC}}$ )**

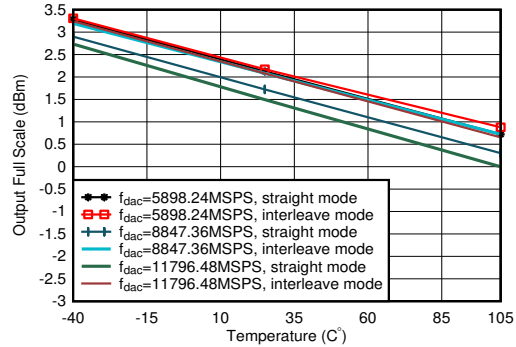
### 4.12.2 TX Typical Characteristics at 1.8GHz

Typical values at  $T_A = +25^\circ\text{C}$  with nominal supplies. Default conditions: TX input data rate = 491.52MSPS,  $f_{DAC} = 11796.48\text{MSPS}$  (24x interpolation), interleave mode, 1<sup>st</sup> Nyquist zone output, PLL clock mode with  $f_{REF} = 491.52\text{MHz}$ ,  $A_{OUT} = -1\text{ dBFS}$ , DSA = 0dB,  $\text{Sin}(x)/x$  enabled, DSA calibrated



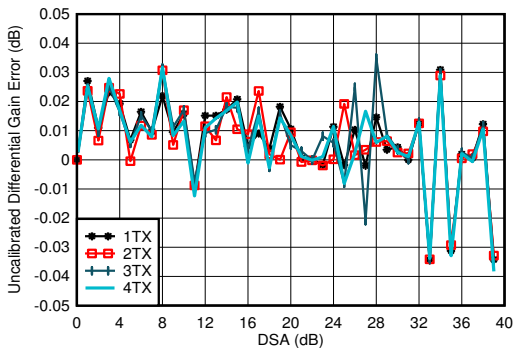
including PCB and cable losses,  $A_{out} = -0.5\text{dBFS}$ , DSA = 0, 1.8GHz matching

**Figure 4-44. TX Output Fullscale vs Output Frequency**



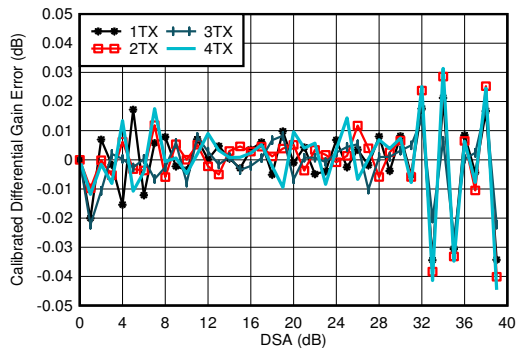
$A_{out} = -0.5\text{dBFS}$ , matching 1.8GHz

**Figure 4-45. TX Output Power vs Temperature at 1.8GHz**



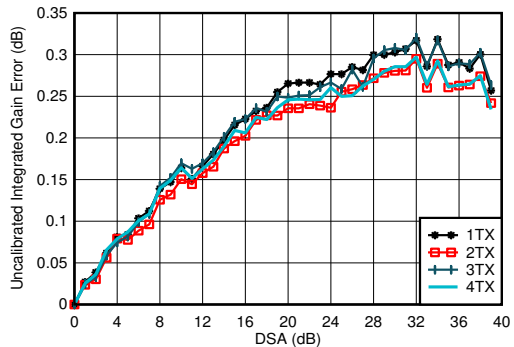
$f_{DAC} = 5898.24\text{MSPS}$ , interleave mode, matching at 1.8GHz  
Differential Gain Error =  $P_{OUT}(\text{DSA Setting} - 1) - P_{OUT}(\text{DSA Setting}) + 1$

**Figure 4-46. TX Uncalibrated Differential Gain Error vs DSA Setting and Channel at 1.8GHz**



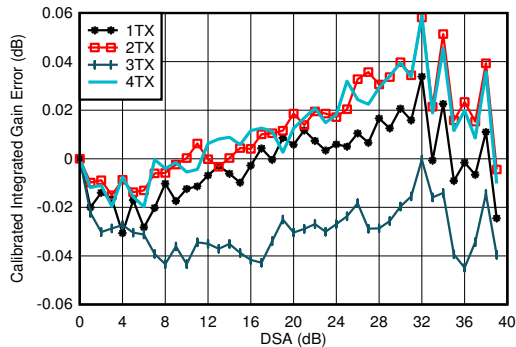
$f_{DAC} = 5898.24\text{MSPS}$ , interleave mode, matching at 1.8GHz  
Differential Gain Error =  $P_{OUT}(\text{DSA Setting} - 1) - P_{OUT}(\text{DSA Setting}) + 1$

**Figure 4-47. TX Calibrated Differential Gain Error vs DSA Setting and Channel at 1.8GHz**



$f_{DAC} = 5898.24\text{MSPS}$ , interleave mode, matching at 1.8GHz  
Integrated Gain Error =  $P_{OUT}(\text{DSA Setting}) - P_{OUT}(\text{DSA Setting} = 0) + (\text{DSA Setting})$

**Figure 4-48. TX Uncalibrated Integrated Gain Error vs DSA Setting and Channel at 1.8GHz**

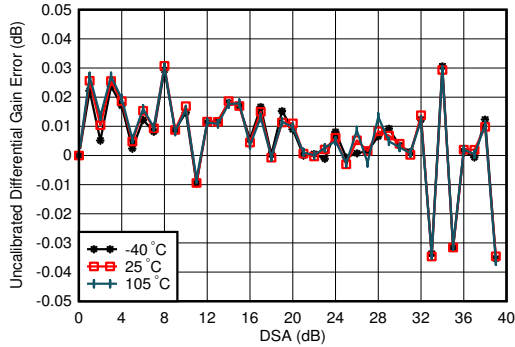


$f_{DAC} = 5898.24\text{MSPS}$ , interleave mode, matching at 1.8GHz  
Integrated Gain Error =  $P_{OUT}(\text{DSA Setting}) - P_{OUT}(\text{DSA Setting} = 0) + (\text{DSA Setting})$

**Figure 4-49. TX Calibrated Integrated Gain Error vs DSA Setting and Channel at 1.8GHz**

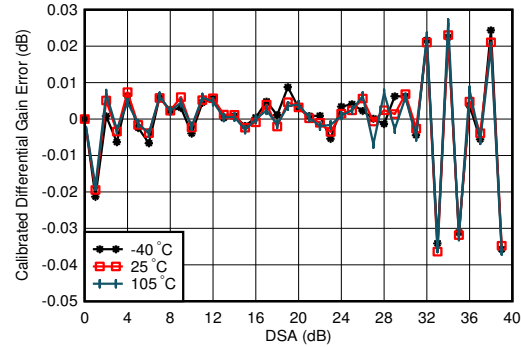
### 4.12.2 TX Typical Characteristics at 1.8GHz (continued)

Typical values at  $T_A = +25^\circ\text{C}$  with nominal supplies. Default conditions: TX input data rate = 491.52MSPS,  $f_{\text{DAC}} = 11796.48\text{MSPS}$  (24x interpolation), interleave mode, 1<sup>st</sup> Nyquist zone output, PLL clock mode with  $f_{\text{REF}} = 491.52\text{MHz}$ ,  $A_{\text{OUT}} = -1\text{ dBFS}$ , DSA = 0dB, Sin(x)/x enabled, DSA calibrated



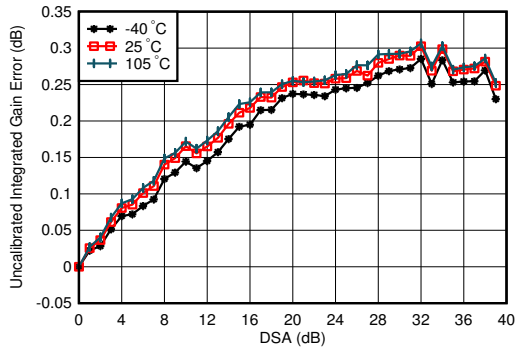
$f_{\text{DAC}} = 5898.24\text{MSPS}$ , interleave mode, matching at 1.8GHz  
 Differential Gain Error =  $P_{\text{OUT}}(\text{DSA Setting} - 1) - P_{\text{OUT}}(\text{DSA Setting}) + 1$

**Figure 4-50. TX Uncalibrated Differential Gain Error vs DSA Setting and Temperature at 1.8GHz**



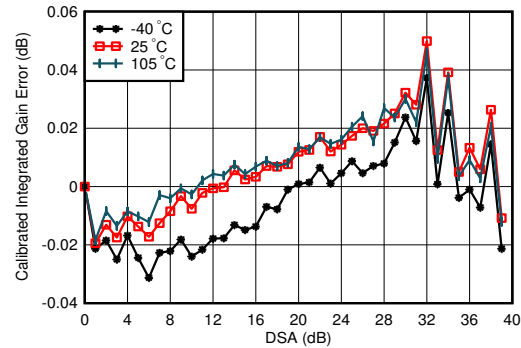
$f_{\text{DAC}} = 5898.24\text{MSPS}$ , interleave mode, matching at 1.8GHz  
 Differential Gain Error =  $P_{\text{OUT}}(\text{DSA Setting} - 1) - P_{\text{OUT}}(\text{DSA Setting}) + 1$

**Figure 4-51. TX Calibrated Differential Gain Error vs DSA Setting and Temperature at 1.8GHz**



$f_{\text{DAC}} = 5898.24\text{MSPS}$ , interleave mode, matching at 1.8GHz  
 Integrated Gain Error =  $P_{\text{OUT}}(\text{DSA Setting}) - P_{\text{OUT}}(\text{DSA Setting} = 0) + (\text{DSA Setting})$

**Figure 4-52. TX Uncalibrated Integrated Gain Error vs DSA Setting and Temperature at 1.8GHz**

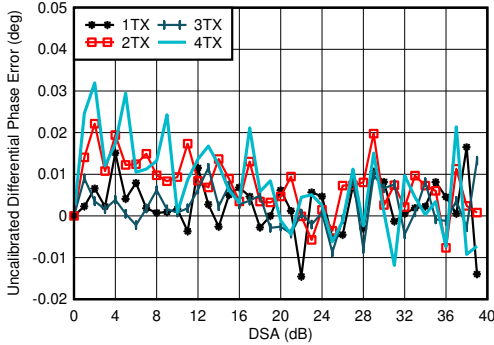


$f_{\text{DAC}} = 5898.24\text{MSPS}$ , interleave mode, matching at 1.8GHz  
 Integrated Gain Error =  $P_{\text{OUT}}(\text{DSA Setting}) - P_{\text{OUT}}(\text{DSA Setting} = 0) + (\text{DSA Setting})$

**Figure 4-53. TX Calibrated Integrated Gain Error vs DSA Setting and Temperature at 1.8GHz**

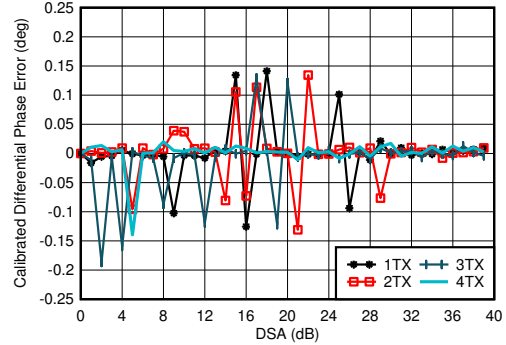
### 4.12.2 TX Typical Characteristics at 1.8GHz (continued)

Typical values at  $T_A = +25^\circ\text{C}$  with nominal supplies. Default conditions: TX input data rate = 491.52MSPS,  $f_{\text{DAC}} = 11796.48\text{MSPS}$  (24x interpolation), interleave mode, 1<sup>st</sup> Nyquist zone output, PLL clock mode with  $f_{\text{REF}} = 491.52\text{MHz}$ ,  $A_{\text{OUT}} = -1\text{ dBFS}$ , DSA = 0dB,  $\text{Sin}(x)/x$  enabled, DSA calibrated



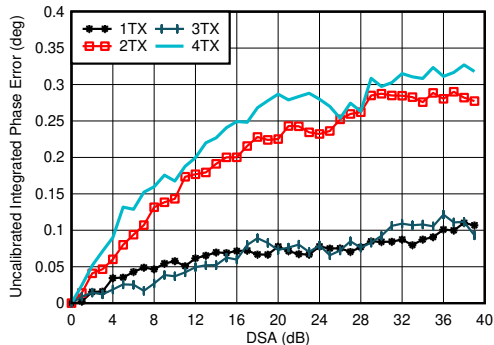
$f_{\text{DAC}} = 5898.24\text{MSPS}$ , interleave mode, matching at 1.8GHz  
 Differential Phase Error =  $\text{Phase}_{\text{OUT}}(\text{DSA Setting} - 1) - \text{Phase}_{\text{OUT}}(\text{DSA Setting})$

**Figure 4-54. TX Uncalibrated Differential Phase Error vs DSA Setting and Channel at 1.8GHz**



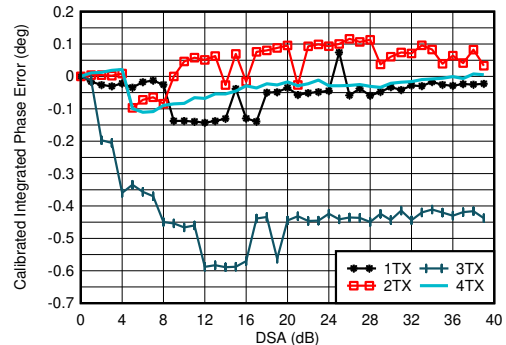
$f_{\text{DAC}} = 8847.36\text{MSPS}$ , straight mode, matching at 2.6GHz  
 Differential Phase Error =  $\text{Phase}_{\text{OUT}}(\text{DSA Setting} - 1) - \text{Phase}_{\text{OUT}}(\text{DSA Setting})$   
 Phase DNL spike may occur at any DSA setting.

**Figure 4-55. TX Calibrated Differential Phase Error vs DSA Setting and Channel at 1.8GHz**



$f_{\text{DAC}} = 5898.24\text{MSPS}$ , interleave mode, matching at 1.8GHz  
 Integrated Phase Error =  $\text{Phase}(\text{DSA Setting}) - \text{Phase}(\text{DSA Setting} = 0)$

**Figure 4-56. TX Uncalibrated Integrated Phase Error vs DSA Setting and Channel at 1.8GHz**

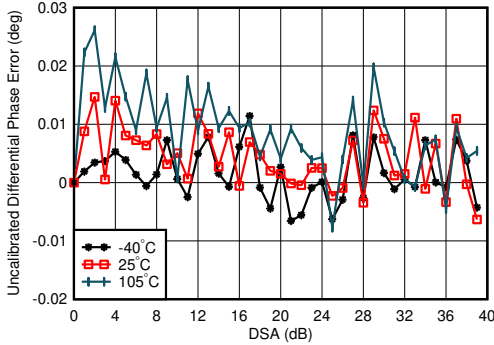


$f_{\text{DAC}} = 5898.24\text{MSPS}$ , interleave mode, matching at 1.8GHz  
 Integrated Phase Error =  $\text{Phase}(\text{DSA Setting}) - \text{Phase}(\text{DSA Setting} = 0)$

**Figure 4-57. TX Calibrated Integrated Phase Error vs DSA Setting and Channel at 1.8GHz**

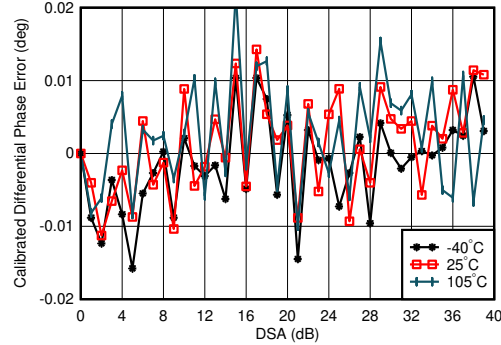
**4.12.2 TX Typical Characteristics at 1.8GHz (continued)**

Typical values at  $T_A = +25^\circ\text{C}$  with nominal supplies. Default conditions: TX input data rate = 491.52MSPS,  $f_{\text{DAC}} = 11796.48\text{MSPS}$  (24x interpolation), interleave mode, 1<sup>st</sup> Nyquist zone output, PLL clock mode with  $f_{\text{REF}} = 491.52\text{MHz}$ ,  $A_{\text{OUT}} = -1\text{ dBFS}$ , DSA = 0dB,  $\text{Sin}(x)/x$  enabled, DSA calibrated



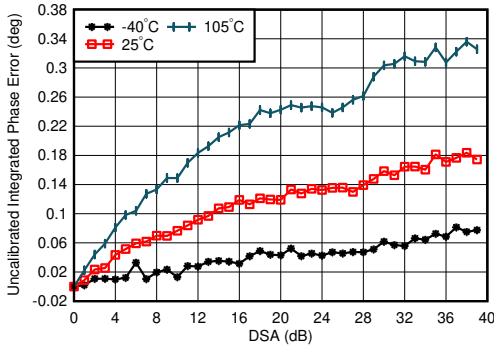
$f_{\text{DAC}} = 5898.24\text{MSPS}$ , interleave mode, matching at 1.8GHz  
 Differential Phase Error =  $\text{Phase}_{\text{OUT}}(\text{DSA Setting} - 1) - \text{Phase}_{\text{OUT}}(\text{DSA Setting})$

**Figure 4-58. TX Uncalibrated Differential Phase Error vs DSA Setting and Temperature at 1.8GHz**



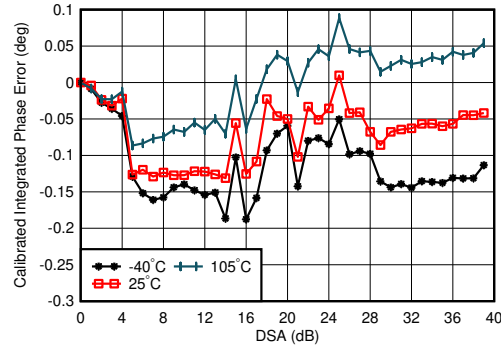
$f_{\text{DAC}} = 5898.24\text{MSPS}$ , interleave mode, matching at 1.8GHz, channel with the median variation over DSA setting at 25°C  
 Differential Phase Error =  $\text{Phase}_{\text{OUT}}(\text{DSA Setting} - 1) - \text{Phase}_{\text{OUT}}(\text{DSA Setting})$

**Figure 4-59. TX Calibrated Differential Phase Error vs DSA Setting and Temperature at 1.8GHz**



$f_{\text{DAC}} = 5898.24\text{MSPS}$ , interleave mode, matching at 1.8GHz, channel with the median variation over DSA setting at 25°C  
 Integrated Phase Error =  $\text{Phase}(\text{DSA Setting}) - \text{Phase}(\text{DSA Setting} = 0)$

**Figure 4-60. TX Uncalibrated Integrated Phase Error vs DSA Setting and Temperature at 1.8GHz**

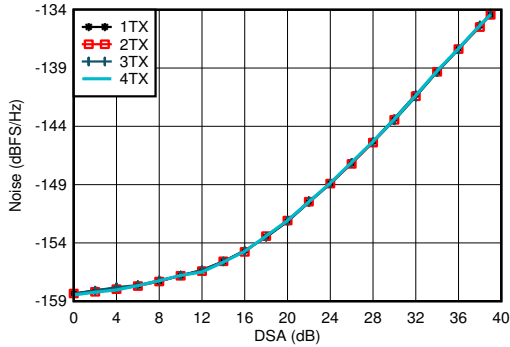


$f_{\text{DAC}} = 5898.24\text{MSPS}$ , interleave mode, matching at 1.8GHz, channel with the median variation over DSA setting at 25°C  
 Integrated Phase Error =  $\text{Phase}(\text{DSA Setting}) - \text{Phase}(\text{DSA Setting} = 0)$

**Figure 4-61. TX Calibrated Integrated Phase Error vs DSA Setting and Temperature at 1.8GHz**

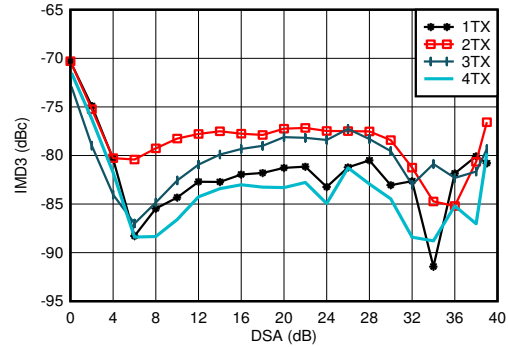
**4.12.2 TX Typical Characteristics at 1.8GHz (continued)**

Typical values at  $T_A = +25^\circ\text{C}$  with nominal supplies. Default conditions: TX input data rate = 491.52MSPS,  $f_{DAC} = 11796.48\text{MSPS}$  (24x interpolation), interleave mode, 1<sup>st</sup> Nyquist zone output, PLL clock mode with  $f_{REF} = 491.52\text{MHz}$ ,  $A_{OUT} = -1\text{dBFS}$ , DSA = 0dB, Sin(x)/x enabled, DSA calibrated



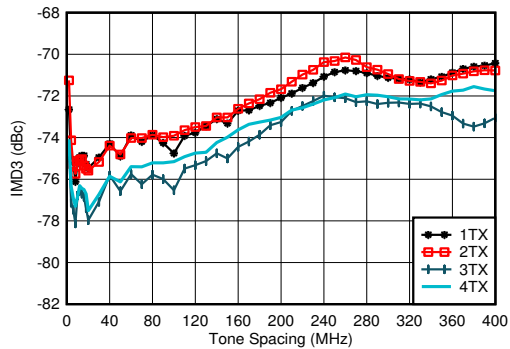
$f_{DAC} = 5898.24\text{MSPS}$ , interleave mode, matching at 1.8GHz,  $P_{OUT} = -13\text{dBFS}$

**Figure 4-62. TX Output Noise vs Channel and Attenuation at 1.8GHz**



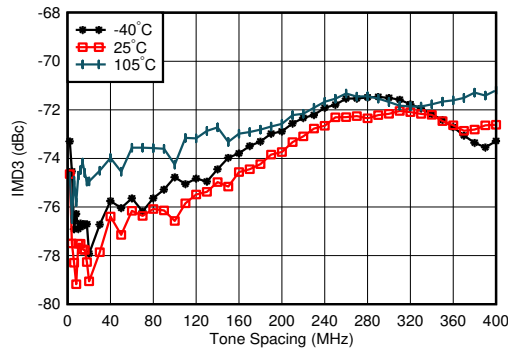
$f_{DAC} = 11796.48\text{MSPS}$ , interleave mode,  $f_{CENTER} = 1.8\text{GHz}$ , matching at 1.8GHz,  $-13\text{dBFS}$  each tone

**Figure 4-63. TX IMD3 vs DSA Setting at 1.8GHz**



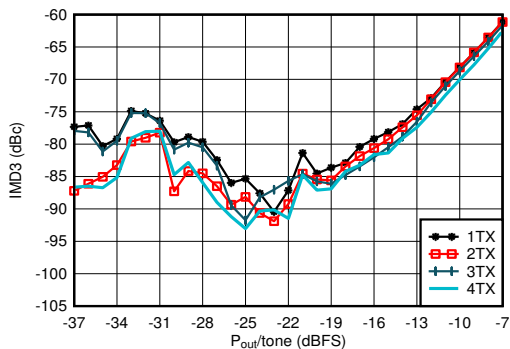
$f_{DAC} = 11796.48\text{MSPS}$ , interleave mode,  $f_{CENTER} = 1.8\text{GHz}$ , matching at 1.8GHz,  $-13\text{dBFS}$  each tone

**Figure 4-64. TX IMD3 vs Tone Spacing and Channel at 1.8GHz**



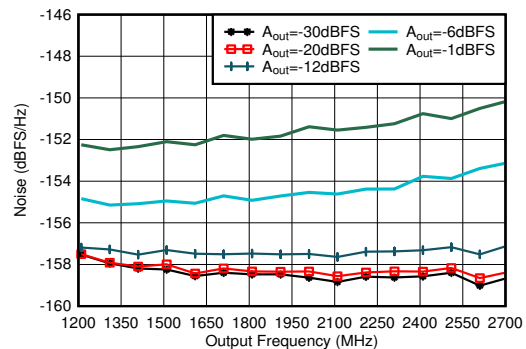
$f_{DAC} = 11796.48\text{MSPS}$ , interleave mode,  $f_{CENTER} = 1.8\text{GHz}$ , matching at 1.8GHz,  $-13\text{dBFS}$  each tone, worst channel

**Figure 4-65. TX IMD3 vs Tone Spacing and Temperature at 1.8GHz**



$f_{DAC} = 11796.48\text{MSPS}$ , interleave mode,  $f_{CENTER} = 1.8\text{GHz}$ ,  $f_{SPACING} = 20\text{MHz}$ , matching at 1.8GHz

**Figure 4-66. TX IMD3 vs Digital Level at 1.8GHz**

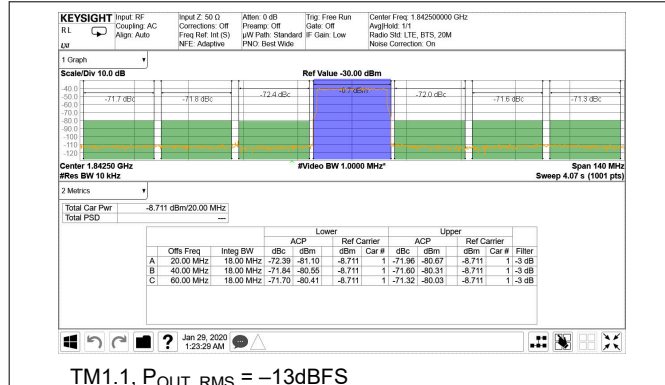


Matching at 2.6GHz, Single tone,  $f_{DAC} = 11.79648\text{GSPS}$ , interleave mode, 40MHz offset

**Figure 4-67. TX Single Tone Output Noise vs Frequency and Amplitude at 1.8GHz**

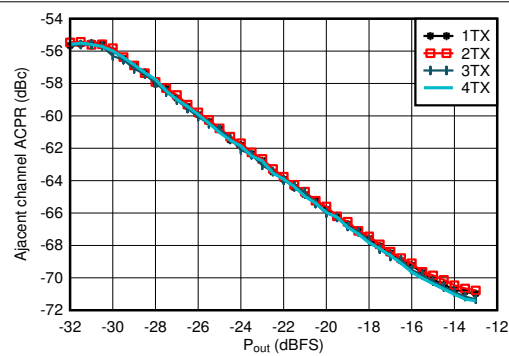
**4.12.2 TX Typical Characteristics at 1.8GHz (continued)**

Typical values at  $T_A = +25^\circ\text{C}$  with nominal supplies. Default conditions: TX input data rate = 491.52MSPS,  $f_{DAC} = 11796.48\text{MSPS}$  (24x interpolation), interleave mode, 1<sup>st</sup> Nyquist zone output, PLL clock mode with  $f_{REF} = 491.52\text{MHz}$ ,  $A_{OUT} = -1\text{ dBFS}$ , DSA = 0dB, Sin(x)/x enabled, DSA calibrated



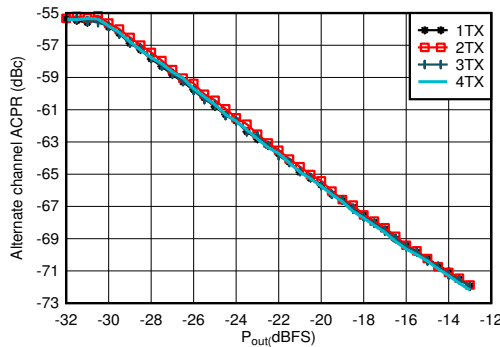
TM1.1,  $P_{OUT\_RMS} = -13\text{dBFS}$

**Figure 4-68. TX 20-MHz LTE Output Spectrum at 1.8425GHz**



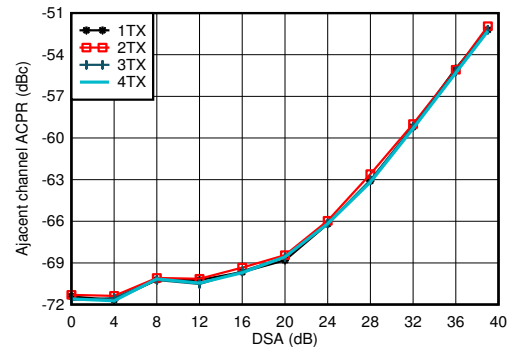
Matching at 1.8GHz, single carrier 20MHz BW TM1.1 LTE

**Figure 4-69. TX 20MHz LTE ACPR vs Digital Level at 1.8425GHz**



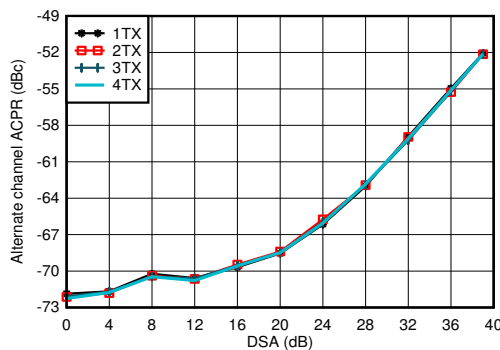
Matching at 1.8GHz, single carrier 20MHz BW TM1.1 LTE

**Figure 4-70. TX 20MHz LTE alt-ACPR vs Digital Level at 1.8425GHz**



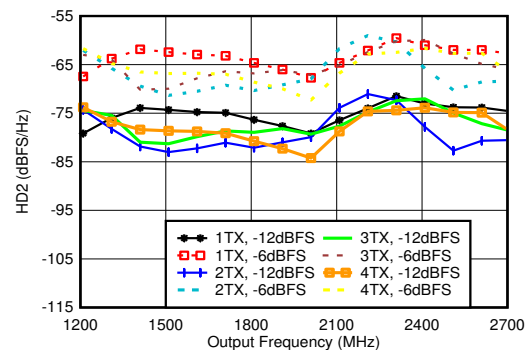
Matching at 1.8GHz, single carrier 20MHz BW TM1.1 LTE

**Figure 4-71. TX 20MHz LTE ACPR vs DSA at 1.8GHz**



Matching at 1.8GHz, single carrier 20MHz BW TM1.1 LTE

**Figure 4-72. TX 20MHz LTE alt-ACPR vs DSA at 1.8GHz**

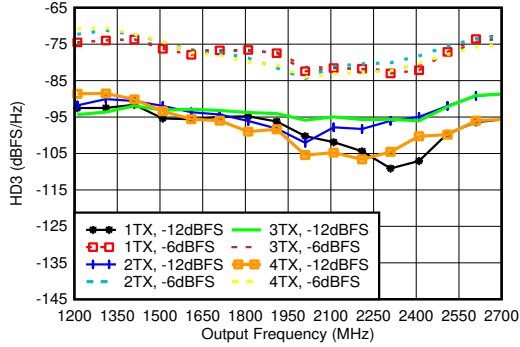


Matching at 1.8GHz,  $f_{DAC} = 11.79648\text{GSPS}$ , interleave mode, normalized to output power at harmonic frequency

**Figure 4-73. TX HD2 vs Digital Amplitude and Output Frequency at 1.8GHz**

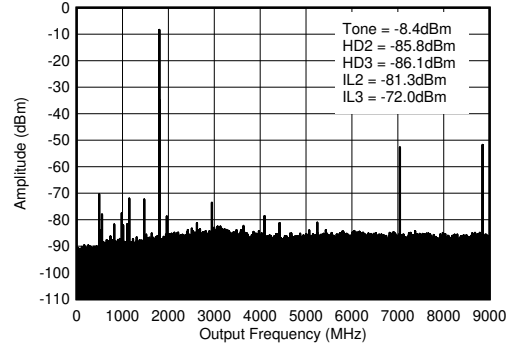
### 4.12.2 TX Typical Characteristics at 1.8GHz (continued)

Typical values at  $T_A = +25^\circ\text{C}$  with nominal supplies. Default conditions: TX input data rate = 491.52MSPS,  $f_{\text{DAC}} = 11796.48\text{MSPS}$  (24x interpolation), interleave mode, 1<sup>st</sup> Nyquist zone output, PLL clock mode with  $f_{\text{REF}} = 491.52\text{MHz}$ ,  $A_{\text{OUT}} = -1\text{ dBFS}$ , DSA = 0dB,  $\text{Sin}(x)/x$  enabled, DSA calibrated



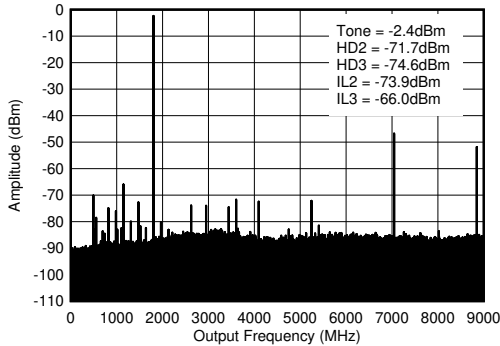
Matching at 1.8GHz,  $f_{\text{DAC}} = 11.79648\text{GSPPS}$ , interleave mode, normalized to output power at harmonic frequency

Figure 4-74. TX HD3 vs Digital Amplitude and Output Frequency at 1.8GHz



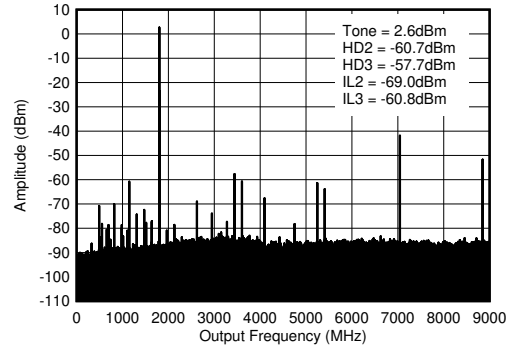
$f_{\text{DAC}} = 8847.36\text{MSPS}$ , straight mode, 1.8GHz matching, includes PCB and cable losses.  $\text{IL}_n = f_s/n \pm f_{\text{OUT}}$  and is due to mixing with digital clocks.

Figure 4-75. TX Single Tone (-12 dBFS) Output Spectrum at 1.8GHz (0- $f_{\text{DAC}}$ )



$f_{\text{DAC}} = 8847.36\text{MSPS}$ , straight mode, 1.8GHz matching, includes PCB and cable losses.  $\text{IL}_n = f_s/n \pm f_{\text{OUT}}$  and is due to mixing with digital clocks.

Figure 4-76. TX Single Tone (-6 dBFS) Output Spectrum at 1.8GHz (0- $f_{\text{DAC}}$ )

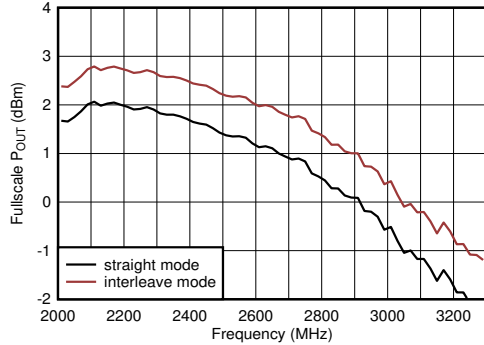


$f_{\text{DAC}} = 8847.36\text{MSPS}$ , straight mode, 1.8GHz matching, includes PCB and cable losses.  $\text{IL}_n = f_s/n \pm f_{\text{OUT}}$  and is due to mixing with digital clocks.

Figure 4-77. TX Single Tone (-1 dBFS) Output Spectrum at 1.8GHz (0- $f_{\text{DAC}}$ )

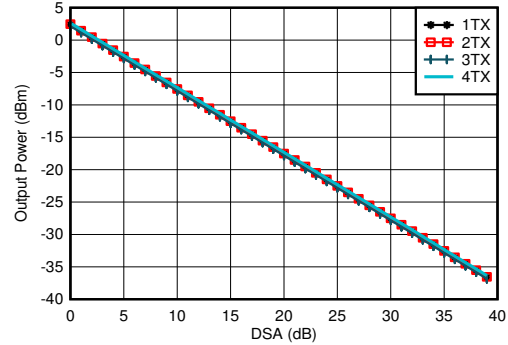
### 4.12.3 TX Typical Characteristics at 2.6GHz

Typical values at  $T_A = +25^\circ\text{C}$  with nominal supplies. Default conditions: TX input data rate = 491.52MSPS,  $f_{DAC} = 11796.48\text{MSPS}$  (24x interpolation), interleave mode, 1<sup>st</sup> Nyquist zone output, PLL clock mode with  $f_{REF} = 491.52\text{MHz}$ ,  $A_{OUT} = -1\text{dBFS}$ , DSA = 0dB, Sin(x)/x enabled, DSA calibrated



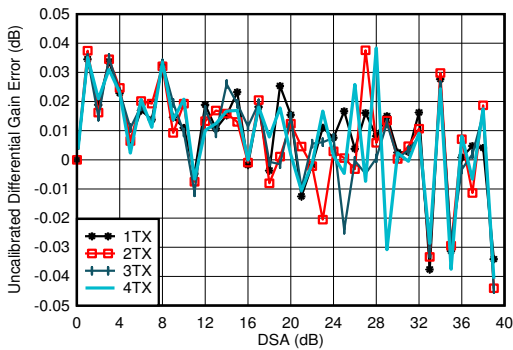
Including PCB and cable losses,  $A_{out} = -0.5\text{dBFS}$ , DSA = 0, 2.6GHz matching

**Figure 4-78. TX Full Scale vs RF Frequency at 11796.48MSPS**



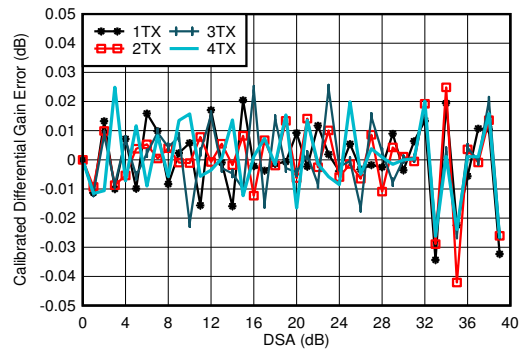
$f_{DAC} = 8847.36\text{MSPS}$ ,  $A_{out} = -0.5\text{dBFS}$ , matching 2.6GHz

**Figure 4-79. TX Output Power vs DSA Setting and Channel at 2.6GHz**



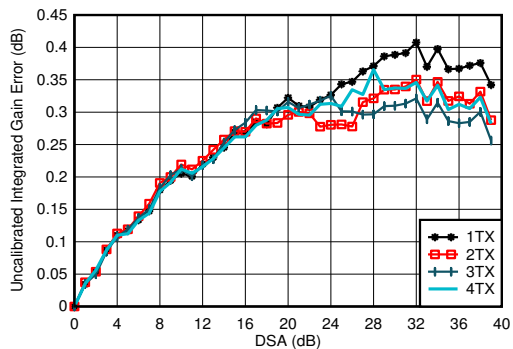
$f_{DAC} = 8847.36\text{MSPS}$ , straight mode, matching at 2.6GHz  
Differential Gain Error =  $P_{OUT}(\text{DSA Setting} - 1) - P_{OUT}(\text{DSA Setting}) + 1$

**Figure 4-80. TX Uncalibrated Differential Gain Error vs DSA Setting and Channel at 2.6GHz**



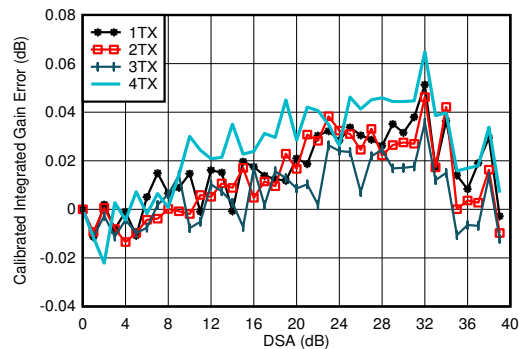
$f_{DAC} = 8847.36\text{MSPS}$ , straight mode, matching at 2.6GHz  
Differential Gain Error =  $P_{OUT}(\text{DSA Setting} - 1) - P_{OUT}(\text{DSA Setting}) + 1$

**Figure 4-81. TX Calibrated Differential Gain Error vs DSA Setting and Channel at 2.6GHz**



$f_{DAC} = 8847.36\text{MSPS}$ , straight mode, matching at 2.6GHz  
Integrated Gain Error =  $P_{OUT}(\text{DSA Setting}) - P_{OUT}(\text{DSA Setting} = 0) + (\text{DSA Setting})$

**Figure 4-82. TX Uncalibrated Integrated Gain Error vs DSA Setting and Channel at 2.6GHz**

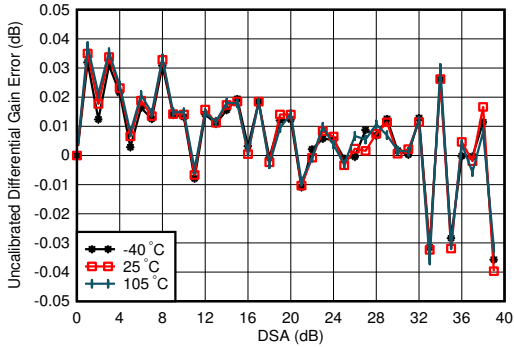


$f_{DAC} = 8847.36\text{MSPS}$ , straight mode, matching at 2.6GHz  
Integrated Gain Error =  $P_{OUT}(\text{DSA Setting}) - P_{OUT}(\text{DSA Setting} = 0) + (\text{DSA Setting})$

**Figure 4-83. TX Calibrated Integrated Gain Error vs DSA Setting and Channel at 2.6GHz**

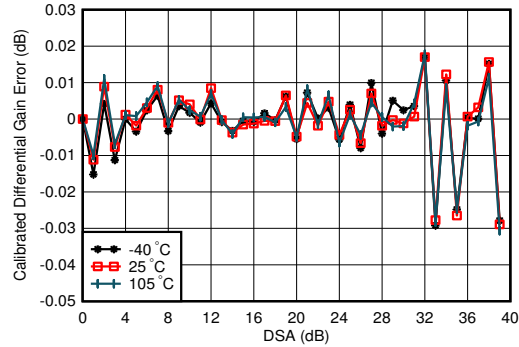
**4.12.3 TX Typical Characteristics at 2.6GHz (continued)**

Typical values at  $T_A = +25^\circ\text{C}$  with nominal supplies. Default conditions: TX input data rate = 491.52MSPS,  $f_{\text{DAC}} = 11796.48\text{MSPS}$  (24x interpolation), interleave mode, 1<sup>st</sup> Nyquist zone output, PLL clock mode with  $f_{\text{REF}} = 491.52\text{MHz}$ ,  $A_{\text{OUT}} = -1\text{dBFS}$ , DSA = 0dB, Sin(x)/x enabled, DSA calibrated



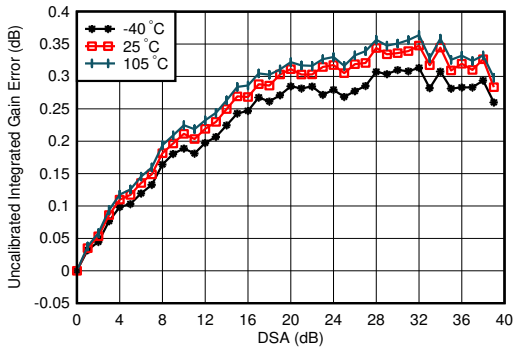
$f_{\text{DAC}} = 8847.36\text{MSPS}$ , straight mode, matching at 2.6GHz, channel with the median variation over DSA setting at 25°C  
 Differential Gain Error =  $P_{\text{OUT}}(\text{DSA Setting} - 1) - P_{\text{OUT}}(\text{DSA Setting}) + 1$

**Figure 4-84. TX Uncalibrated Differential Gain Error vs DSA Setting and Temperature at 2.6GHz**



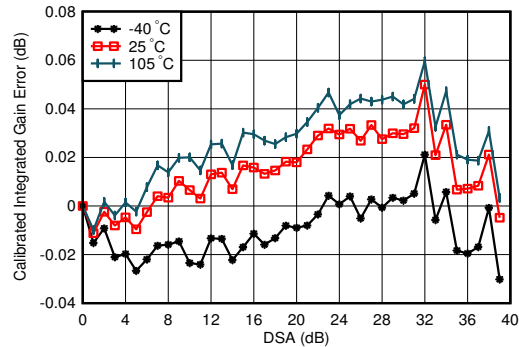
$f_{\text{DAC}} = 8847.36\text{MSPS}$ , straight mode, matching at 2.6GHz, channel with the median variation over DSA setting at 25°C  
 Differential Gain Error =  $P_{\text{OUT}}(\text{DSA Setting} - 1) - P_{\text{OUT}}(\text{DSA Setting}) + 1$

**Figure 4-85. TX Calibrated Differential Gain Error vs DSA Setting and Temperature at 2.6GHz**



$f_{\text{DAC}} = 8847.36\text{MSPS}$ , straight mode, matching at 2.6GHz, channel with the median variation over DSA setting at 25°C  
 Integrated Gain Error =  $P_{\text{OUT}}(\text{DSA Setting}) - P_{\text{OUT}}(\text{DSA Setting} = 0) + (\text{DSA Setting})$

**Figure 4-86. TX Uncalibrated Integrated Gain Error vs DSA Setting and Temperature at 2.6GHz**

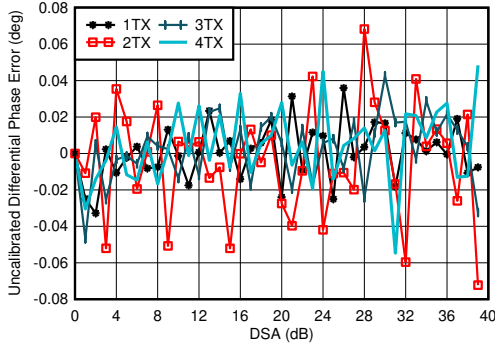


$f_{\text{DAC}} = 8847.36\text{MSPS}$ , straight mode, matching at 2.6GHz, channel with the median variation over DSA setting at 25°C  
 Integrated Gain Error =  $P_{\text{OUT}}(\text{DSA Setting}) - P_{\text{OUT}}(\text{DSA Setting} = 0) + (\text{DSA Setting})$

**Figure 4-87. TX Calibrated Integrated Gain Error vs DSA Setting and Temperature at 2.6GHz**

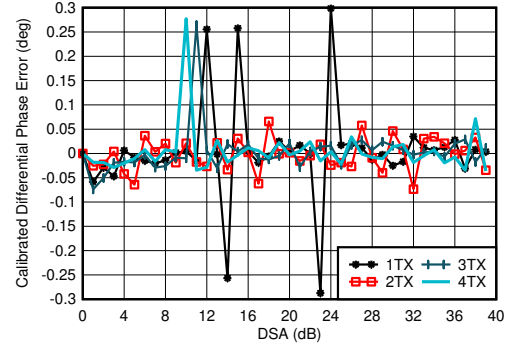
### 4.12.3 TX Typical Characteristics at 2.6GHz (continued)

Typical values at  $T_A = +25^\circ\text{C}$  with nominal supplies. Default conditions: TX input data rate = 491.52MSPS,  $f_{\text{DAC}} = 11796.48\text{MSPS}$  (24x interpolation), interleave mode, 1<sup>st</sup> Nyquist zone output, PLL clock mode with  $f_{\text{REF}} = 491.52\text{MHz}$ ,  $A_{\text{OUT}} = -1\text{dBFS}$ , DSA = 0dB, Sin(x)/x enabled, DSA calibrated



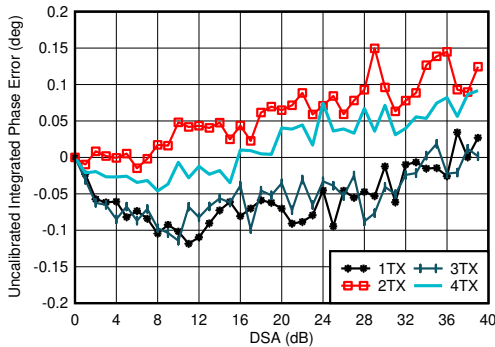
$f_{\text{DAC}} = 8847.36\text{MSPS}$ , straight mode, matching at 2.6GHz  
 Differential Phase Error =  $\text{Phase}_{\text{OUT}}(\text{DSA Setting} - 1) - \text{Phase}_{\text{OUT}}(\text{DSA Setting})$

**Figure 4-88. TX Uncalibrated Differential Phase Error vs DSA Setting and Channel at 2.6GHz**



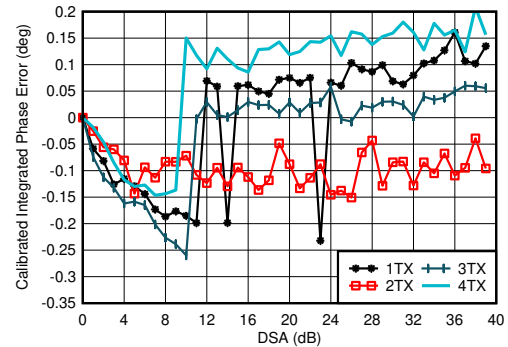
$f_{\text{DAC}} = 8847.36\text{MSPS}$ , straight mode, matching at 2.6GHz  
 Differential Phase Error =  $\text{Phase}_{\text{OUT}}(\text{DSA Setting} - 1) - \text{Phase}_{\text{OUT}}(\text{DSA Setting})$   
 Phase DNL spike may occur at any DSA setting.

**Figure 4-89. TX Calibrated Differential Phase Error vs DSA Setting and Channel at 2.6GHz**



$f_{\text{DAC}} = 8847.36\text{MSPS}$ , straight mode, matching at 2.6GHz  
 Integrated Phase Error =  $\text{Phase}(\text{DSA Setting}) - \text{Phase}(\text{DSA Setting} = 0)$

**Figure 4-90. TX Uncalibrated Integrated Phase Error vs DSA Setting and Channel at 2.6GHz**

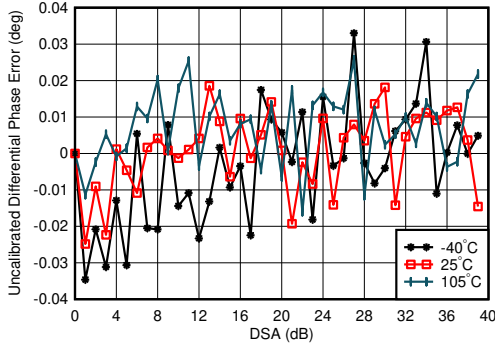


$f_{\text{DAC}} = 8847.36\text{MSPS}$ , straight mode, matching at 2.6GHz  
 Integrated Phase Error =  $\text{Phase}(\text{DSA Setting}) - \text{Phase}(\text{DSA Setting} = 0)$

**Figure 4-91. TX Calibrated Integrated Phase Error vs DSA Setting and Channel at 2.6GHz**

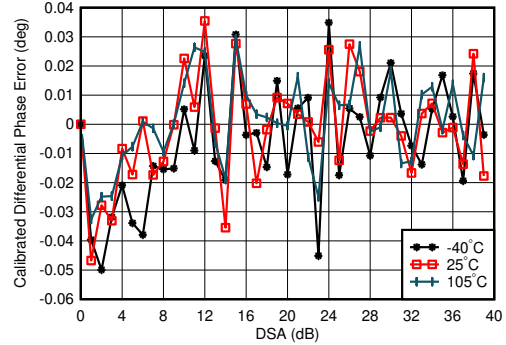
**4.12.3 TX Typical Characteristics at 2.6GHz (continued)**

Typical values at  $T_A = +25^\circ\text{C}$  with nominal supplies. Default conditions: TX input data rate = 491.52MSPS,  $f_{\text{DAC}} = 11796.48\text{MSPS}$  (24x interpolation), interleave mode, 1<sup>st</sup> Nyquist zone output, PLL clock mode with  $f_{\text{REF}} = 491.52\text{MHz}$ ,  $A_{\text{OUT}} = -1\text{dBFS}$ , DSA = 0dB, Sin(x)/x enabled, DSA calibrated



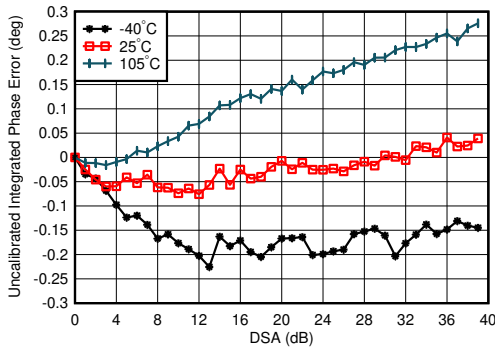
$f_{\text{DAC}} = 8847.36\text{MSPS}$ , straight mode, matching at 2.6GHz, channel with the median variation over DSA setting at 25°C  
Differential Phase Error =  $\text{Phase}_{\text{OUT}}(\text{DSA Setting} - 1) - \text{Phase}_{\text{OUT}}(\text{DSA Setting})$

**Figure 4-92. TX Uncalibrated Differential Phase Error vs DSA Setting and Temperature at 2.6GHz**



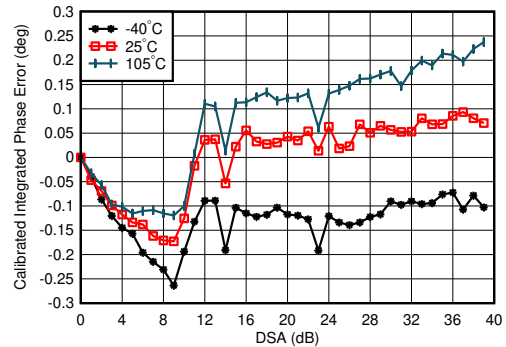
$f_{\text{DAC}} = 8847.36\text{MSPS}$ , straight mode, matching at 2.6GHz, channel with the median variation over DSA setting at 25°C  
Differential Phase Error =  $\text{Phase}_{\text{OUT}}(\text{DSA Setting} - 1) - \text{Phase}_{\text{OUT}}(\text{DSA Setting})$

**Figure 4-93. TX Calibrated Differential Phase Error vs DSA Setting and Temperature at 2.6GHz**



$f_{\text{DAC}} = 8847.36\text{MSPS}$ , straight mode, matching at 2.6GHz, channel with the medium variation over DSA setting at 25°C  
Integrated Phase Error =  $\text{Phase}(\text{DSA Setting}) - \text{Phase}(\text{DSA Setting} = 0)$

**Figure 4-94. TX Uncalibrated Integrated Phase Error vs DSA Setting and Temperature at 2.6GHz**

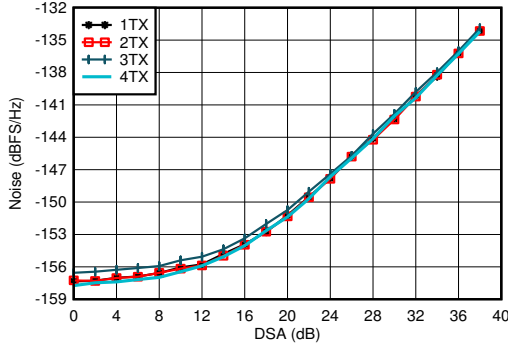


$f_{\text{DAC}} = 8847.36\text{MSPS}$ , straight mode, matching at 2.6GHz, channel with the median variation over DSA setting at 25°C  
Integrated Phase Error =  $\text{Phase}(\text{DSA Setting}) - \text{Phase}(\text{DSA Setting} = 0)$

**Figure 4-95. TX Calibrated Integrated Phase Error vs DSA Setting and Temperature at 2.6GHz**

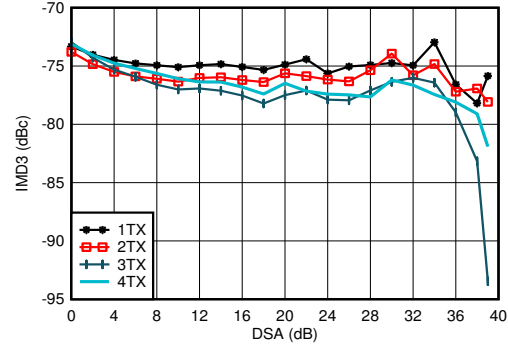
### 4.12.3 TX Typical Characteristics at 2.6GHz (continued)

Typical values at  $T_A = +25^\circ\text{C}$  with nominal supplies. Default conditions: TX input data rate = 491.52MSPS,  $f_{\text{DAC}} = 11796.48\text{MSPS}$  (24x interpolation), interleave mode, 1<sup>st</sup> Nyquist zone output, PLL clock mode with  $f_{\text{REF}} = 491.52\text{MHz}$ ,  $A_{\text{OUT}} = -1\text{dBFS}$ , DSA = 0dB, Sin(x)/x enabled, DSA calibrated



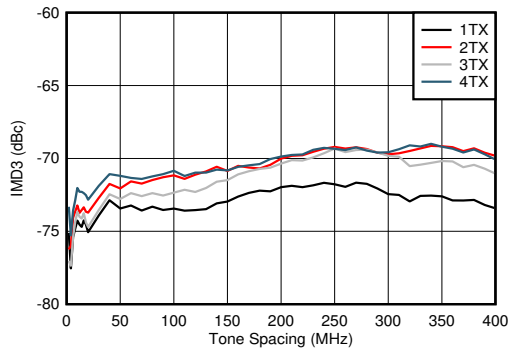
$f_{\text{DAC}} = 8847.36\text{MSPS}$ , straight mode, matching at 2.6GHz,  $P_{\text{OUT}} = -13\text{ dBFS}$

**Figure 4-96. TX Output Noise vs Channel and Attenuation at 2.6GHz**



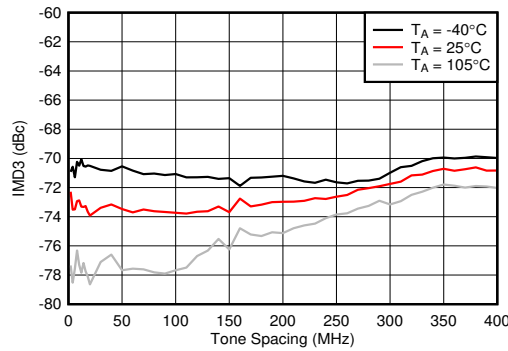
$f_{\text{DAC}} = 8847.36\text{MSPS}$ , straight mode,  $f_{\text{CENTER}} = 2.6\text{GHz}$ , matching at 2.6GHz,  $-13\text{ dBFS}$  each tone

**Figure 4-97. TX IMD3 vs DSA Setting at 2.6GHz**



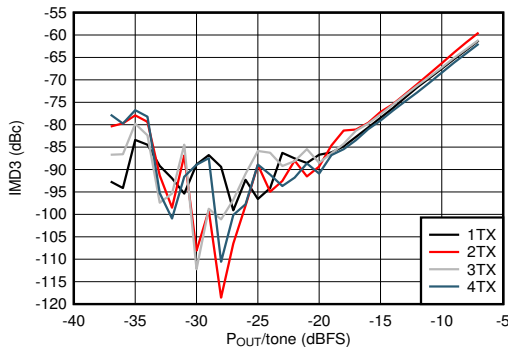
$f_{\text{DAC}} = 8847.36\text{MSPS}$ , straight mode,  $f_{\text{CENTER}} = 2.6\text{GHz}$ , matching at 2.6GHz,  $-13\text{ dBFS}$  each tone

**Figure 4-98. TX IMD3 vs Tone Spacing and Channel at 2.6GHz**



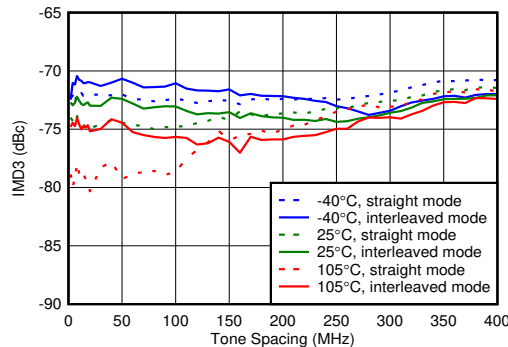
$f_{\text{DAC}} = 8847.36\text{MSPS}$ , straight mode,  $f_{\text{CENTER}} = 2.6\text{GHz}$ , matching at 2.6GHz,  $-13\text{ dBFS}$  each tone, worst channel.

**Figure 4-99. TX IMD3 vs Tone Spacing and Temperature at 2.6GHz**



$f_{\text{DAC}} = 8847.36\text{MSPS}$ , straight mode,  $f_{\text{CENTER}} = 2.6\text{GHz}$ ,  $f_{\text{SPACING}} = 20\text{ MHz}$ , matching at 2.6GHz

**Figure 4-100. TX IMD3 vs Digital Level at 2.6GHz**

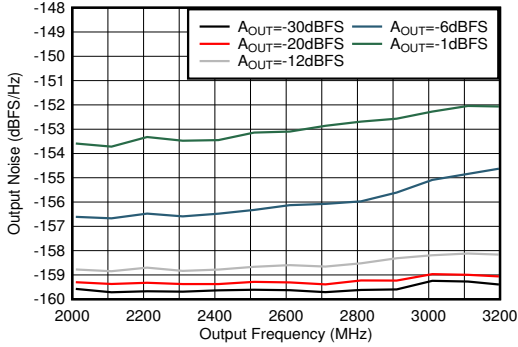


$f_{\text{DAC}} = 8847.36\text{MSPS}$ , straight mode,  $f_{\text{CENTER}} = 2.6\text{GHz}$ , matching at 2.6GHz,  $-13\text{ dBFS}$  each tone

**Figure 4-101. TX IMD3 vs Tone Spacing and Temperature**

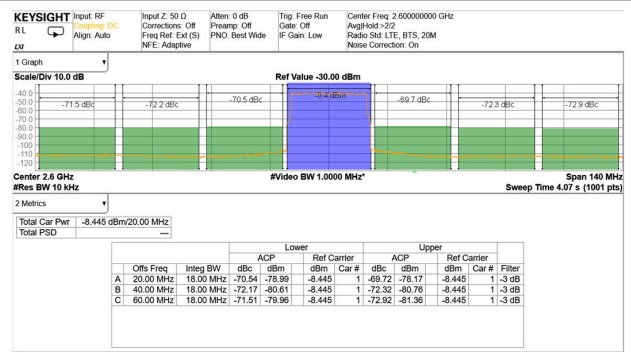
### 4.12.3 TX Typical Characteristics at 2.6GHz (continued)

Typical values at  $T_A = +25^\circ\text{C}$  with nominal supplies. Default conditions: TX input data rate = 491.52MSPS,  $f_{DAC} = 11796.48\text{MSPS}$  (24x interpolation), interleave mode, 1<sup>st</sup> Nyquist zone output, PLL clock mode with  $f_{REF} = 491.52\text{MHz}$ ,  $A_{OUT} = -1\text{dBFS}$ , DSA = 0dB, Sin(x)/x enabled, DSA calibrated



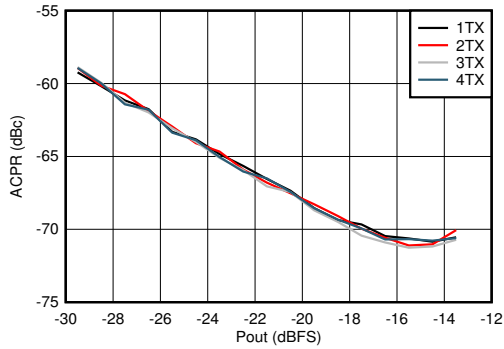
Matching at 2.6GHz, Single tone,  $f_{DAC} = 11.79648\text{GSPS}$ , interleave mode, 40-MHz offset

Figure 4-102. TX Single Tone Output Noise vs Frequency and Amplitude at 2.6GHz



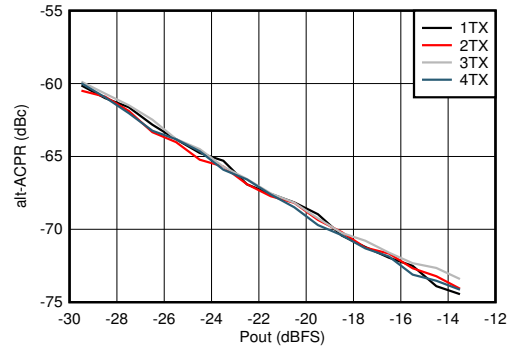
TM1.1,  $P_{OUT\_RMS} = -13\text{dBFS}$

Figure 4-103. TX 20-MHz LTE Output Spectrum at 2.6GHz (Band 41)



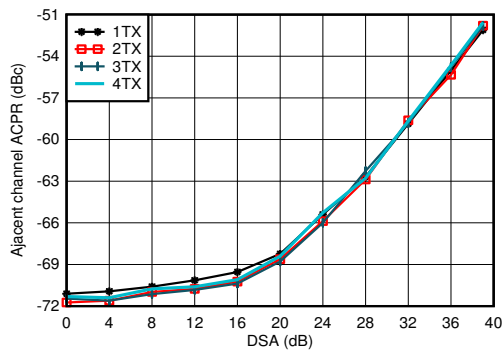
Matching at 2.6GHz, single carrier 20MHz BW TM1.1 LTE

Figure 4-104. TX 20-MHz LTE ACPR vs Digital Level at 2.6GHz



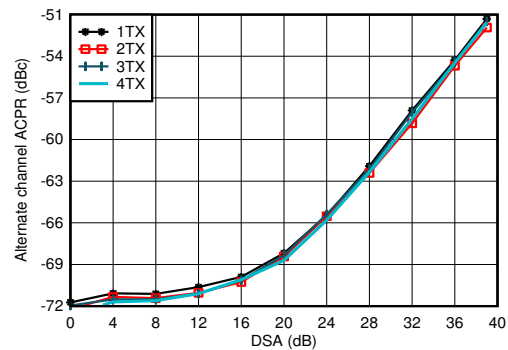
Matching at 2.6GHz, single carrier 20MHz BW TM1.1 LTE

Figure 4-105. TX 20-MHz LTE alt-ACPR vs Digital Level at 2.6GHz



Matching at 2.6GHz, single carrier 20MHz BW TM1.1 LTE

Figure 4-106. TX 20-MHz LTE ACPR vs DSA at 2.6GHz

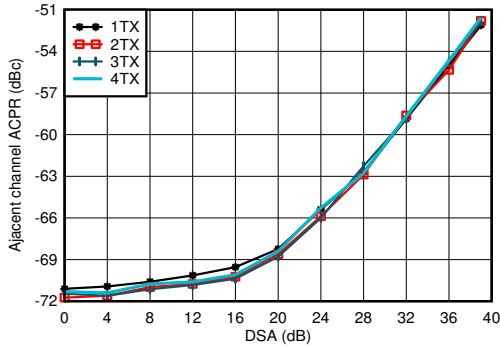


Matching at 2.6GHz, single carrier 20MHz BW TM1.1 LTE

Figure 4-107. TX 20-MHz LTE alt-ACPR vs DSA at 2.6GHz

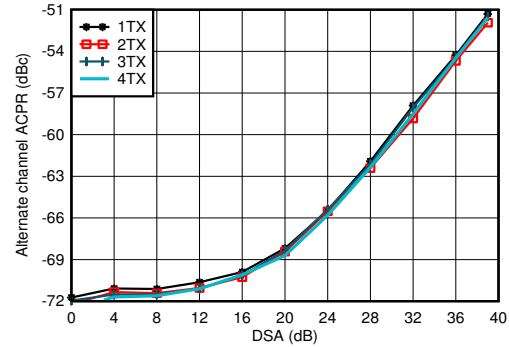
### 4.12.3 TX Typical Characteristics at 2.6GHz (continued)

Typical values at  $T_A = +25^\circ\text{C}$  with nominal supplies. Default conditions: TX input data rate = 491.52MSPS,  $f_{\text{DAC}} = 11796.48\text{MSPS}$  (24x interpolation), interleave mode, 1<sup>st</sup> Nyquist zone output, PLL clock mode with  $f_{\text{REF}} = 491.52\text{MHz}$ ,  $A_{\text{OUT}} = -1\text{dBFS}$ , DSA = 0dB, Sin(x)/x enabled, DSA calibrated



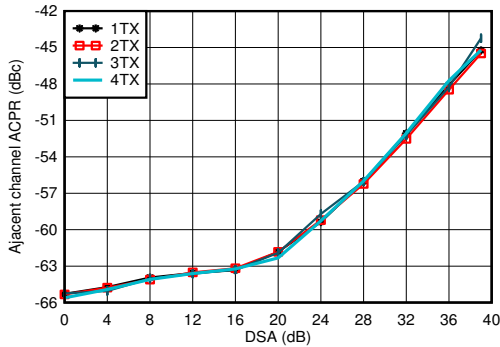
Matching at 2.6GHz, single carrier 20MHz BW TM1.1 LTE

Figure 4-108. TX 20-MHz LTE ACPR vs DSA at 2.6GHz



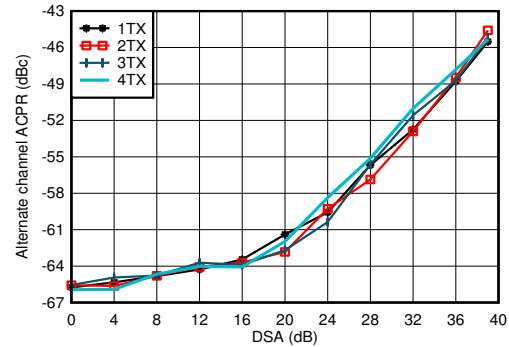
Matching at 2.6GHz, single carrier 20MHz BW TM1.1 LTE

Figure 4-109. TX 20-MHz LTE alt-ACPR vs DSA at 2.6GHz



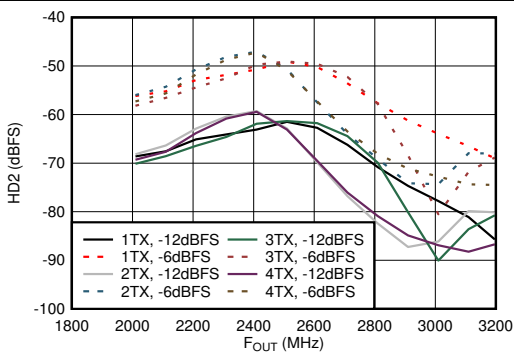
Matching at 2.6GHz, single carrier 100MHz BW TM1.1 NR

Figure 4-110. TX 100-MHz NR ACPR vs DSA at 2.6GHz



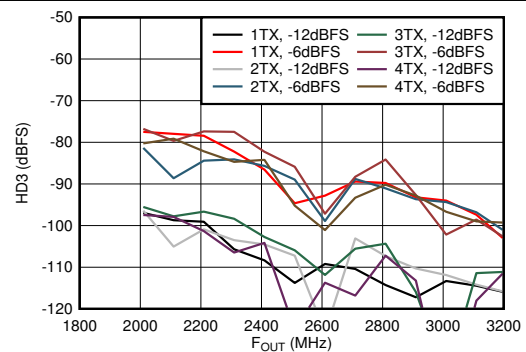
Matching at 2.6GHz, single carrier 100MHz BW TM1.1 NR

Figure 4-111. TX 100-MHz NR alt-ACPR vs DSA at 2.6GHz



Matching at 2.6GHz,  $f_{\text{DAC}} = 11.79648\text{GSPS}$ , interleave mode, normalized to output power at harmonic frequency

Figure 4-112. TX HD2 vs Digital Amplitude and Output Frequency at 2.6GHz

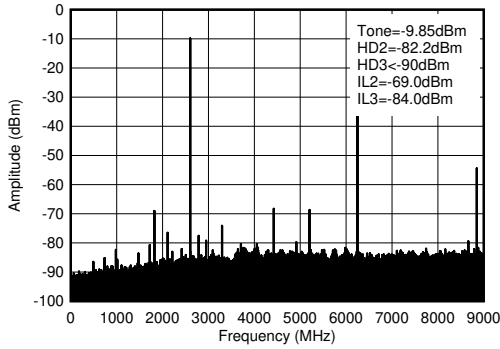


Matching at 2.6GHz,  $f_{\text{DAC}} = 11.79648\text{GSPS}$ , interleave mode, normalized to output power at harmonic frequency

Figure 4-113. TX HD3 vs Digital Amplitude and Output Frequency at 2.6GHz

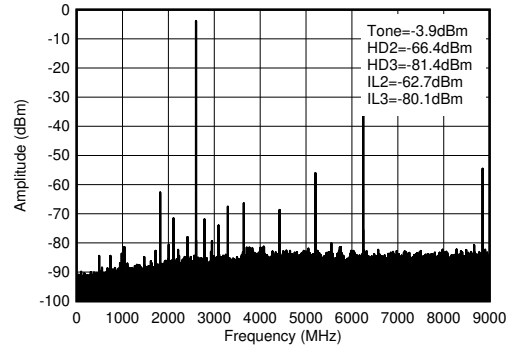
### 4.12.3 TX Typical Characteristics at 2.6GHz (continued)

Typical values at  $T_A = +25^\circ\text{C}$  with nominal supplies. Default conditions: TX input data rate = 491.52MSPS,  $f_{\text{DAC}} = 11796.48\text{MSPS}$  (24x interpolation), interleave mode, 1<sup>st</sup> Nyquist zone output, PLL clock mode with  $f_{\text{REF}} = 491.52\text{MHz}$ ,  $A_{\text{OUT}} = -1\text{dBFS}$ , DSA = 0dB, Sin(x)/x enabled, DSA calibrated



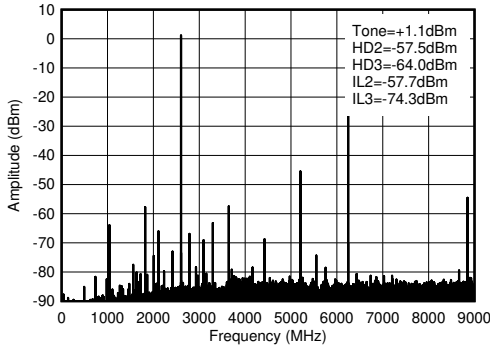
$f_{\text{DAC}} = 8847.36\text{MSPS}$ , straight mode, 2.6GHz matching, includes PCB and cable losses.  $\text{IL}_n = f_s/n \pm f_{\text{OUT}}$  and is due to mixing with digital clocks.

**Figure 4-114. TX Single Tone (-12dBFS) Output Spectrum at 2.6GHz (0- $f_{\text{DAC}}$ )**



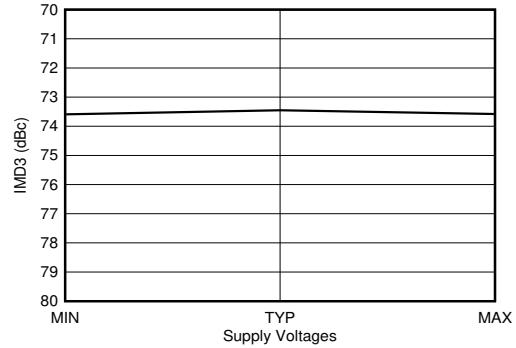
$f_{\text{DAC}} = 8847.36\text{MSPS}$ , straight mode, 2.6GHz matching, includes PCB and cable losses.  $\text{IL}_n = f_s/n \pm f_{\text{OUT}}$  and is due to mixing with digital clocks.

**Figure 4-115. TX Single Tone (-6dBFS) Output Spectrum at 2.6GHz (0- $f_{\text{DAC}}$ )**



$f_{\text{DAC}} = 8847.36\text{MSPS}$ , straight mode, 2.6GHz matching, includes PCB and cable losses.  $\text{IL}_n = f_s/n \pm f_{\text{OUT}}$  and is due to mixing with digital clocks.

**Figure 4-116. TX Single Tone (-1dBFS) Output Spectrum at 2.6GHz (0- $f_{\text{DAC}}$ )**

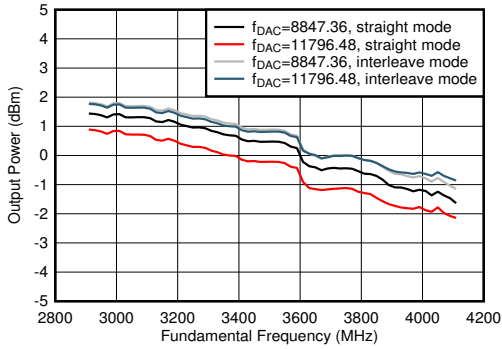


$f_{\text{DAC}} = 11796.48\text{MSPS}$ , interleave mode, 2.6GHz matching. 40MHz offset from tone. Output Power = -13dBFS. All supplies simultaneously at MIN, TYP, or MAX voltages.

**Figure 4-117. TX IMD3 vs Supply Voltage at 2.6GHz**

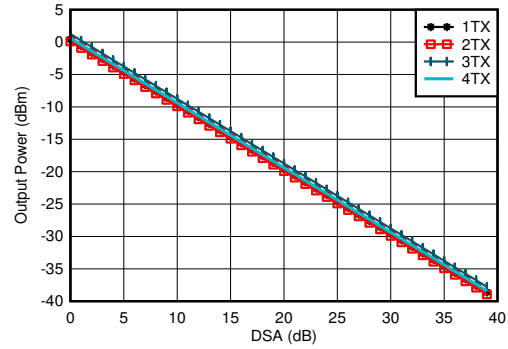
### 4.12.4 TX Typical Characteristics at 3.5GHz

Typical values at  $T_A = +25^\circ\text{C}$  with nominal supplies. Default conditions: TX input data rate = 491.52MSPS,  $f_{\text{DAC}} = 11796.48\text{MSPS}$  (24x interpolation), interleave mode, 1<sup>st</sup> Nyquist zone output, PLL clock mode with  $f_{\text{REF}} = 491.52\text{MHz}$ ,  $A_{\text{OUT}} = -1\text{dBFS}$ , DSA = 0dB, Sin(x)/x enabled, DSA calibrated



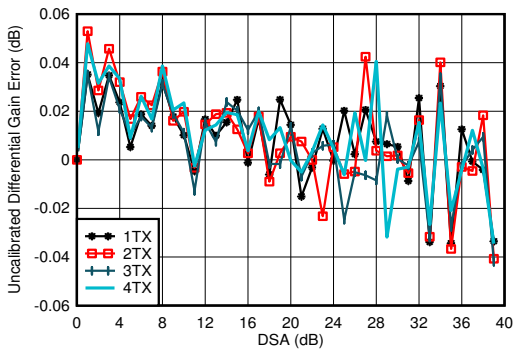
$A_{\text{out}} = -0.5\text{dBFS}$ , 3.5GHz Matching, included PCB and cable losses

Figure 4-118. TX Output Power vs Frequency



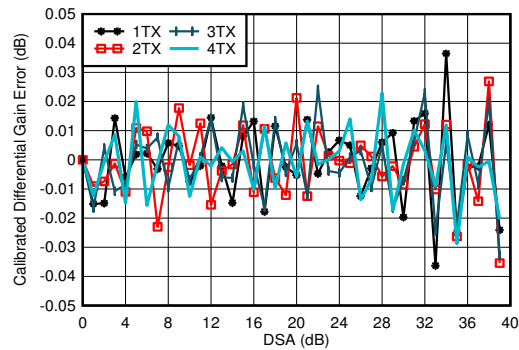
$A_{\text{out}} = -0.5\text{dBFS}$ , 3.5GHz Matching, included PCB and cable losses

Figure 4-119. TX Output Power vs DSA Setting at 3.5GHz



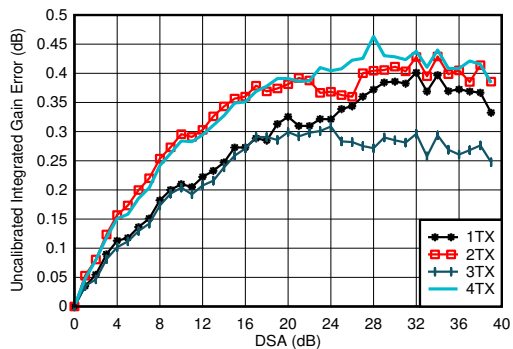
3.5GHz Matching, included PCB and cable losses  
Differential Gain Error =  $P_{\text{OUT}}(\text{DSA Setting} - 1) - P_{\text{OUT}}(\text{DSA Setting}) + 1$

Figure 4-120. TX Uncalibrated Differential Gain Error vs DSA Setting and Channel at 3.5GHz



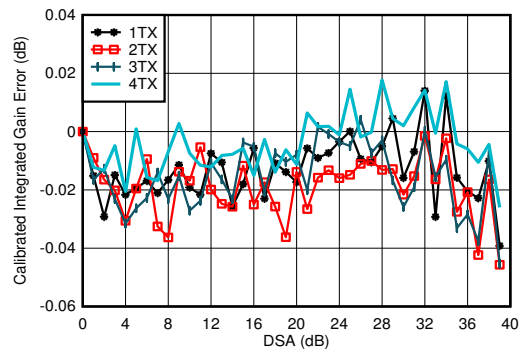
3.5GHz Matching, included PCB and cable losses  
Differential Gain Error =  $P_{\text{OUT}}(\text{DSA Setting} - 1) - P_{\text{OUT}}(\text{DSA Setting}) + 1$

Figure 4-121. TX Calibrated Differential Gain Error vs DSA Setting and Channel at 3.5GHz



3.5GHz Matching, included PCB and cable losses  
Integrated Gain Error =  $P_{\text{OUT}}(\text{DSA Setting}) - P_{\text{OUT}}(\text{DSA Setting} = 0) + (\text{DSA Setting})$

Figure 4-122. TX Uncalibrated Integrated Gain Error vs DSA Setting and Channel at 3.5GHz

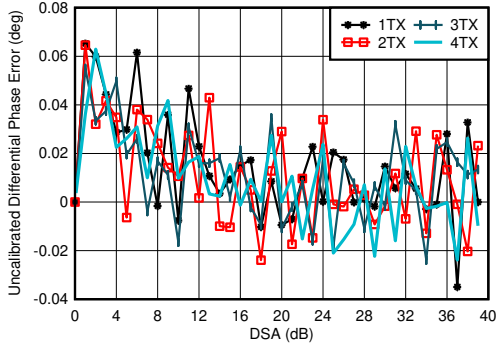


3.5GHz Matching, included PCB and cable losses  
Integrated Gain Error =  $P_{\text{OUT}}(\text{DSA Setting}) - P_{\text{OUT}}(\text{DSA Setting} = 0) + (\text{DSA Setting})$

Figure 4-123. TX Calibrated Integrated Gain Error vs DSA Setting and Channel at 3.5GHz

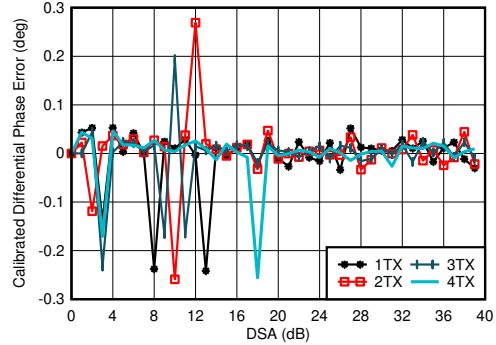
**4.12.4 TX Typical Characteristics at 3.5GHz (continued)**

Typical values at  $T_A = +25^\circ\text{C}$  with nominal supplies. Default conditions: TX input data rate = 491.52MSPS,  $f_{\text{DAC}} = 11796.48\text{MSPS}$  (24x interpolation), interleave mode, 1<sup>st</sup> Nyquist zone output, PLL clock mode with  $f_{\text{REF}} = 491.52\text{MHz}$ ,  $A_{\text{OUT}} = -1\text{dBFS}$ , DSA = 0dB, Sin(x)/x enabled, DSA calibrated



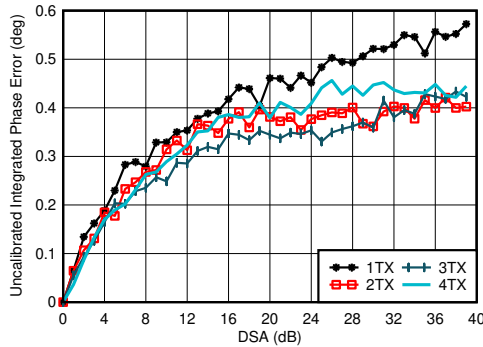
3.5GHz Matching, included PCB and cable losses

**Figure 4-124. TX Uncalibrated Differential Phase Error vs DSA Setting and Channel at 3.5GHz**



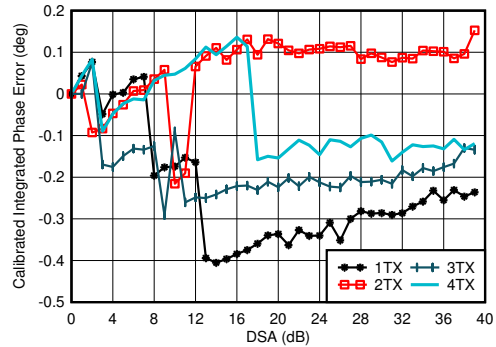
3.5GHz Matching, included PCB and cable losses  
Phase DNL spike may occur at any DSA setting.

**Figure 4-125. TX Calibrated Differential Phase Error vs DSA Setting and Channel at 3.5GHz**



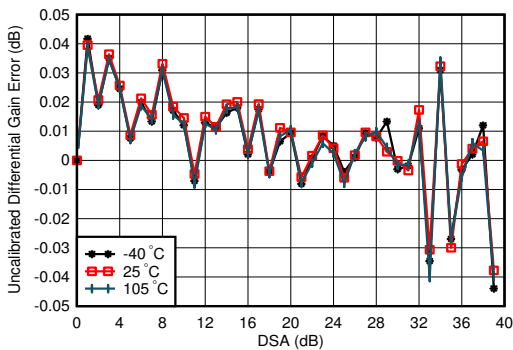
3.5GHz Matching, included PCB and cable losses

**Figure 4-126. TX Uncalibrated Integrated Phase Error vs DSA Setting and Channel at 3.5GHz**



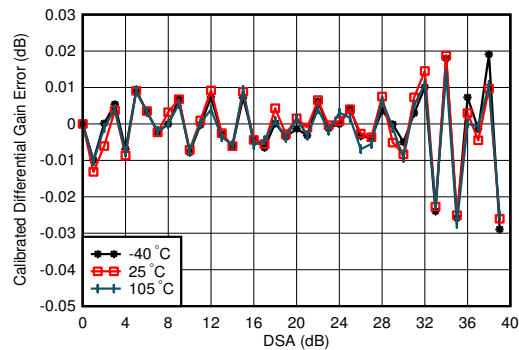
3.5GHz Matching, included PCB and cable losses

**Figure 4-127. TX Calibrated Integrated Phase Error vs DSA Setting and Channel at 3.5GHz**



3.5GHz Matching, 1TX

**Figure 4-128. TX Uncalibrated Differential Gain Error vs DSA Setting and Temperature at 3.5GHz**

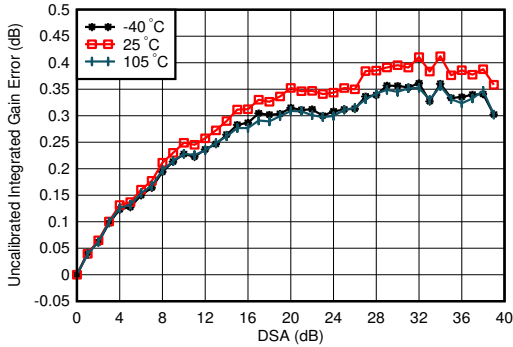


3.5GHz Matching, 1TX, Calibrated at 25°C

**Figure 4-129. TX Calibrated Differential Gain Error vs DSA Setting and Temperature at 3.5GHz**

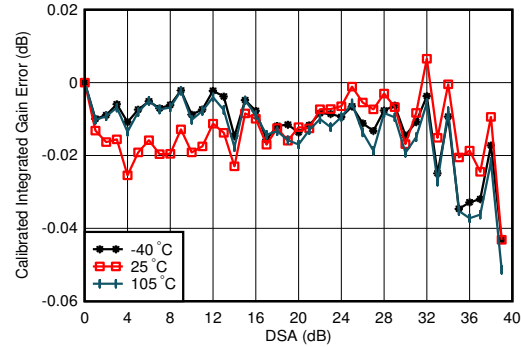
**4.12.4 TX Typical Characteristics at 3.5GHz (continued)**

Typical values at  $T_A = +25^\circ\text{C}$  with nominal supplies. Default conditions: TX input data rate = 491.52MSPS,  $f_{\text{DAC}} = 11796.48\text{MSPS}$  (24x interpolation), interleave mode, 1<sup>st</sup> Nyquist zone output, PLL clock mode with  $f_{\text{REF}} = 491.52\text{MHz}$ ,  $A_{\text{OUT}} = -1\text{dBFS}$ , DSA = 0dB, Sin(x)/x enabled, DSA calibrated



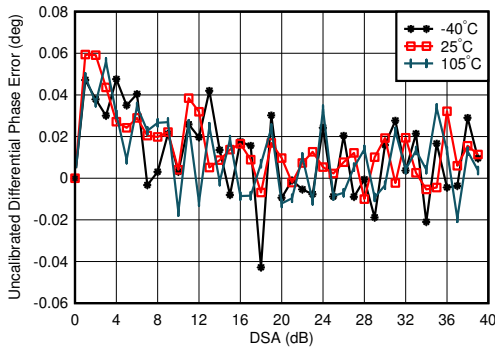
3.5GHz Matching, 1TX

**Figure 4-130. TX Uncalibrated Integrated Gain Error vs DSA Setting and Temperature at 3.5GHz**



3.5GHz Matching, 1TX, Calibrated at 25°C

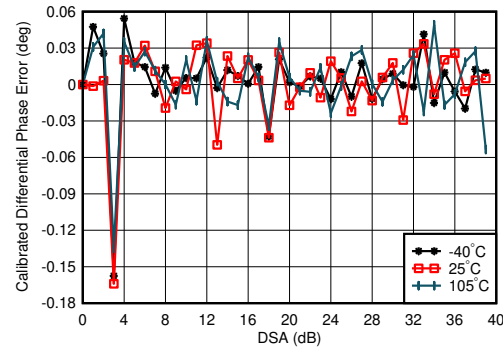
**Figure 4-131. TX Calibrated Integrated Gain Error vs DSA Setting and Temperature at 3.5GHz**



3.5GHz Matching, 1TX

$$\text{Differential Phase Error} = \text{Phase}_{\text{OUT}}(\text{DSA Setting} - 1) - \text{Phase}_{\text{OUT}}(\text{DSA Setting})$$

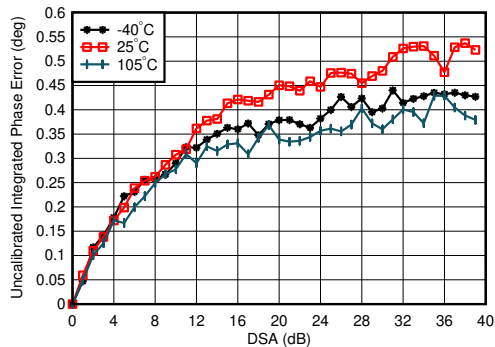
**Figure 4-132. TX Uncalibrated Differential Phase Error vs DSA setting and Temperature at 3.5GHz**



3.5GHz Matching, 1TX, Calibrated at 25°C

$$\text{Differential Phase Error} = \text{Phase}_{\text{OUT}}(\text{DSA Setting} - 1) - \text{Phase}_{\text{OUT}}(\text{DSA Setting})$$

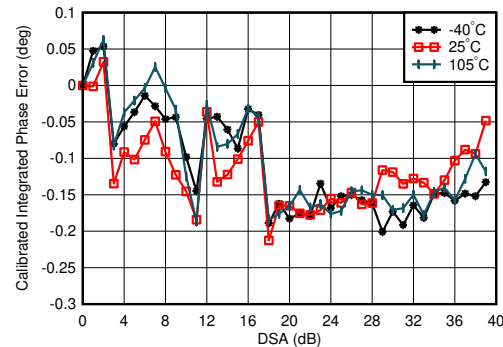
**Figure 4-133. TX Calibrated Differential Phase Error vs DSA Setting and Temperature at 3.5GHz**



3.5GHz Matching, 1TX

$$\text{Integrated Phase Error} = \text{Phase}(\text{DSA Setting}) - \text{Phase}(\text{DSA Setting} = 0)$$

**Figure 4-134. TX Uncalibrated Integrated Phase Error vs DSA Setting and Temperature at 3.5GHz**



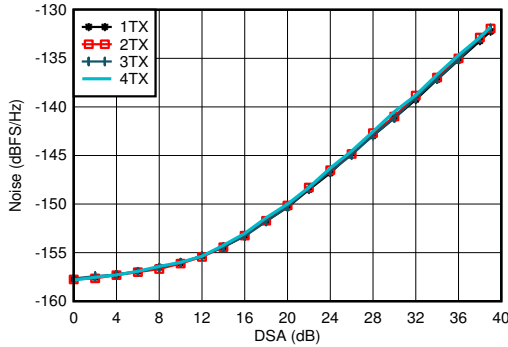
3.5GHz Matching, 1TX, Calibrated at 25°C

$$\text{Integrated Phase Error} = \text{Phase}(\text{DSA Setting}) - \text{Phase}(\text{DSA Setting} = 0)$$

**Figure 4-135. TX Calibrated Integrated Phase Error vs DSA Setting and Temperature at 3.5GHz**

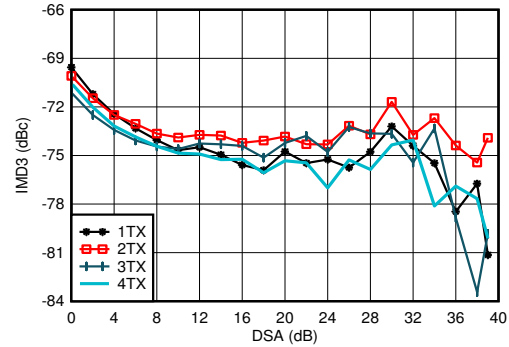
### 4.12.4 TX Typical Characteristics at 3.5GHz (continued)

Typical values at  $T_A = +25^\circ\text{C}$  with nominal supplies. Default conditions: TX input data rate = 491.52MSPS,  $f_{\text{DAC}} = 11796.48\text{MSPS}$  (24x interpolation), interleave mode, 1<sup>st</sup> Nyquist zone output, PLL clock mode with  $f_{\text{REF}} = 491.52\text{MHz}$ ,  $A_{\text{OUT}} = -1\text{dBFS}$ , DSA = 0dB, Sin(x)/x enabled, DSA calibrated



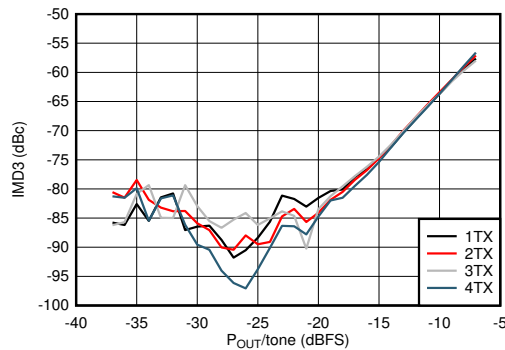
A.  $f_{\text{DAC}} = 11796.48\text{MSPS}$ , interleave mode, matching at 3.5GHz,  $A_{\text{out}} = -13\text{ dBFS}$ .

Figure 4-136. TX NSD vs DSA Setting at 3.5GHz



20MHz tone spacing, 3.5GHz Matching,  $-13\text{ dBFS}$  each tone, included PCB and cable losses

Figure 4-137. TX IMD3 vs DSA Setting at 3.5GHz



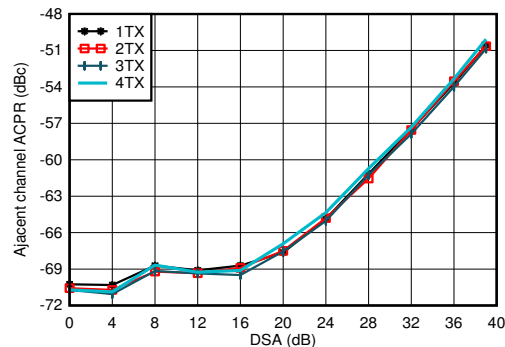
20MHz tone spacing, 3.5GHz Matching

Figure 4-138. TX IMD3 vs Digital Amplitude and Channel at 3.5GHz



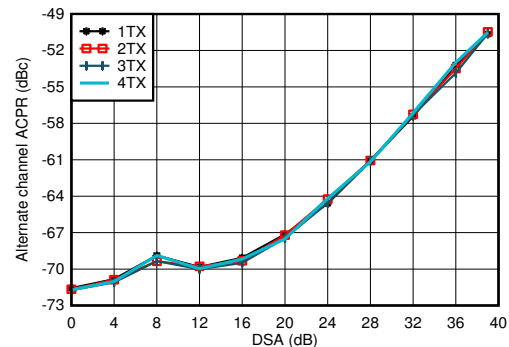
3.5GHz Matching, single carrier 20MHz BW TM1.1 LTE

Figure 4-139. TX 20MHz LTE Output Spectrum at 3.5GHz (Band 42)



3.5GHz Matching, single carrier 20MHz BW TM1.1 LTE

Figure 4-140. TX 20MHz LTE ACPR vs DSA Setting at 3.5GHz

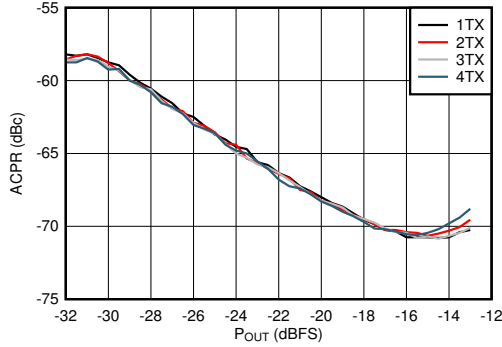


3.5GHz Matching, single carrier 20MHz BW TM1.1 LTE

Figure 4-141. TX 20MHz LTE alt-ACPR vs DSA Setting at 3.5GHz

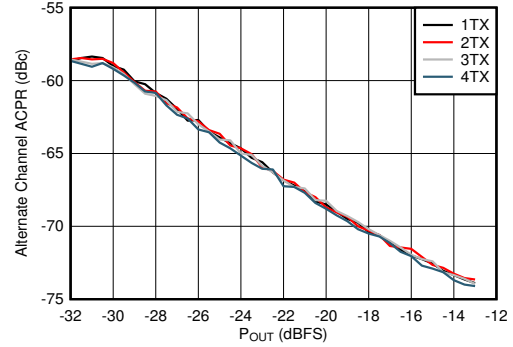
**4.12.4 TX Typical Characteristics at 3.5GHz (continued)**

Typical values at  $T_A = +25^\circ\text{C}$  with nominal supplies. Default conditions: TX input data rate = 491.52MSPS,  $f_{DAC} = 11796.48\text{MSPS}$  (24x interpolation), interleave mode, 1<sup>st</sup> Nyquist zone output, PLL clock mode with  $f_{REF} = 491.52\text{MHz}$ ,  $A_{OUT} = -1\text{dBFS}$ , DSA = 0dB, Sin(x)/x enabled, DSA calibrated



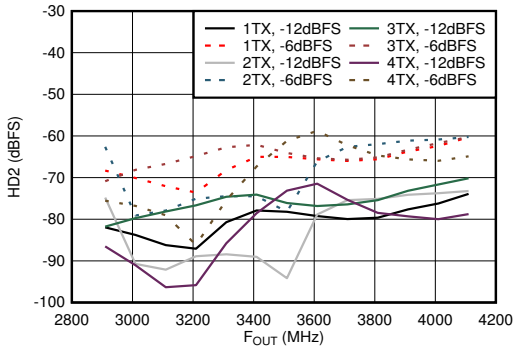
3.5GHz Matching, single carrier 20MHz BW TM1.1 LTE

**Figure 4-142. TX 20MHz LTE ACPR vs Digital Level at 3.5GHz**



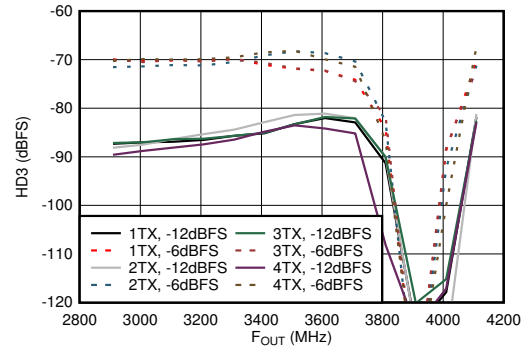
3.5GHz Matching, single carrier 20MHz BW TM1.1 LTE

**Figure 4-143. TX 20MHz LTE alt-ACPR vs Digital Level at 3.5GHz**



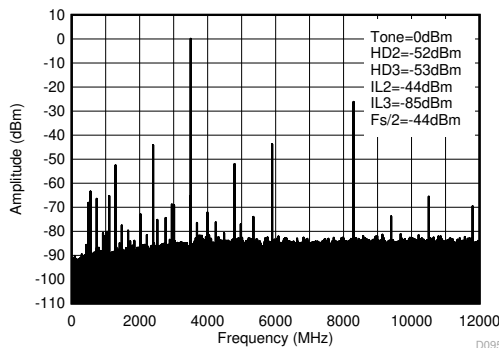
Matching at 3.5GHz,  $f_{DAC} = 11.79648\text{GSPS}$ , interleave mode, normalized to output power at harmonic frequency

**Figure 4-144. TX Single Tone HD2 vs Frequency and Digital Level at 3.5GHz**



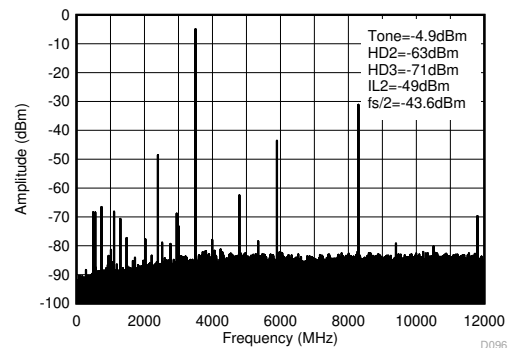
Matching at 3.5GHz,  $f_{DAC} = 11.79648\text{GSPS}$ , interleave mode, normalized to output power at harmonic frequency. Dip is due to HD3 falling near DC.

**Figure 4-145. TX Single Tone HD3 vs Frequency and Digital Level at 3.5GHz**



Matching at 3.5GHz,  $f_{DAC} = 11.79648\text{GSPS}$ , interleave mode.

**Figure 4-146. TX Single Tone (-1dBFS) Output Spectrum at 3.5GHz (0 -  $f_{DAC}$ )**

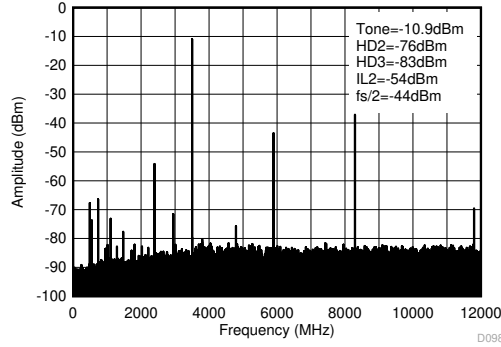


Matching at 3.5GHz,  $f_{DAC} = 11.79648\text{GSPS}$ , interleave mode.

**Figure 4-147. TX Single Tone (-6dBFS) Output Spectrum at 3.5GHz (0 -  $f_{DAC}$ )**

**4.12.4 TX Typical Characteristics at 3.5GHz (continued)**

Typical values at  $T_A = +25^\circ\text{C}$  with nominal supplies. Default conditions: TX input data rate = 491.52MSPS,  $f_{DAC} = 11796.48\text{MSPS}$  (24x interpolation), interleave mode, 1<sup>st</sup> Nyquist zone output, PLL clock mode with  $f_{REF} = 491.52\text{MHz}$ ,  $A_{OUT} = -1\text{dBFS}$ , DSA = 0dB, Sin(x)/x enabled, DSA calibrated

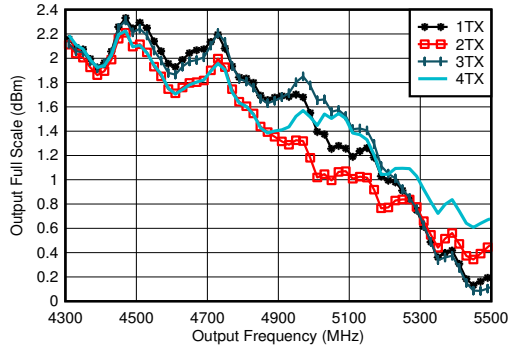


Matching at 3.5GHz,  $f_{DAC} = 11.79648\text{GSPS}$ , interleave mode.

**Figure 4-148. TX Single Tone (-12dBFS) Output Spectrum at 3.5GHz (0- $f_{DAC}$ )**

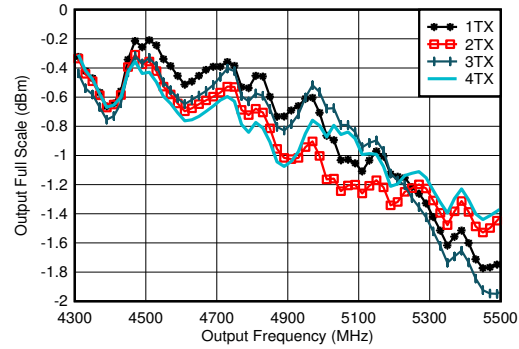
### 4.12.5 TX Typical Characteristics at 4.9GHz

Typical values at  $T_A = +25^\circ\text{C}$  with nominal supplies. Default conditions: TX input data rate = 491.52MSPS,  $f_{\text{DAC}} = 11796.48\text{MSPS}$  (24x interpolation), interleave mode, 1<sup>st</sup> Nyquist zone output, PLL clock mode with  $f_{\text{REF}} = 491.52\text{MHz}$ ,  $A_{\text{OUT}} = -1\text{dBFS}$ , DSA = 0dB, Sin(x)/x enabled, DSA calibrated



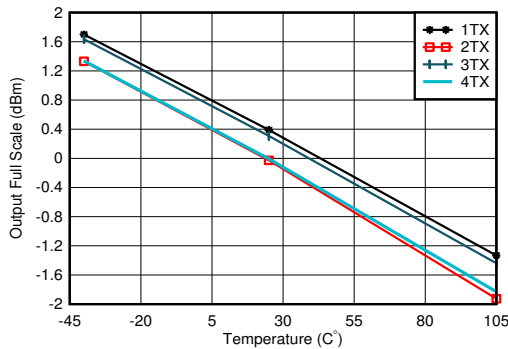
Excluding PCB and cable losses,  $A_{\text{out}} = -0.5\text{ dBFS}$ , DSA = 0, 4.9GHz matching

**Figure 4-149. TX Full Scale vs RF Frequency and Channel at 11796.48MSPS**



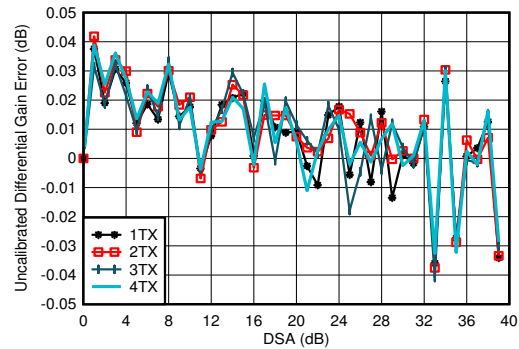
Excluding PCB and cable losses,  $A_{\text{out}} = -0.5\text{ dBFS}$ , DSA = 0, 4.9GHz matching

**Figure 4-150. TX Full Scale vs RF Frequency and Channel at 5898.24 MSPS, Straight Mode, 2nd Nyquist Zone**



$f_{\text{DAC}} = 11796.48\text{MSPS}$ ,  $A_{\text{out}} = -0.5\text{dBFS}$ , matching 4.9GHz

**Figure 4-151. TX Output Power vs DSA Setting and Channel at 4.9GHz**

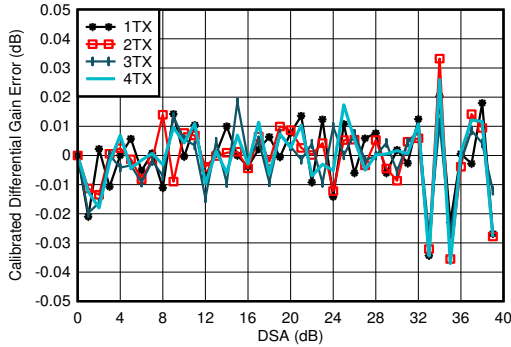


$f_{\text{DAC}} = 11796.48\text{MSPS}$ , interleave mode, matching at 4.9GHz  
Differential Gain Error =  $P_{\text{OUT}}(\text{DSA Setting} - 1) - P_{\text{OUT}}(\text{DSA Setting}) + 1$

**Figure 4-152. TX Uncalibrated Differential Gain Error vs DSA Setting and Channel at 4.9GHz**

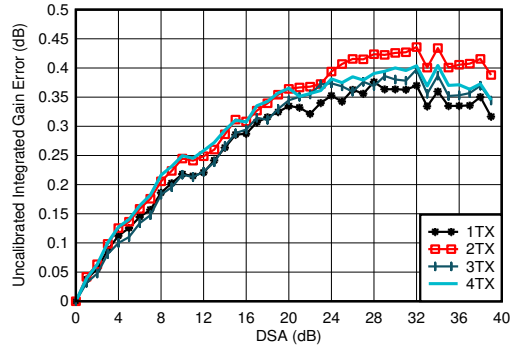
**4.12.5 TX Typical Characteristics at 4.9GHz (continued)**

Typical values at  $T_A = +25^\circ\text{C}$  with nominal supplies. Default conditions: TX input data rate = 491.52MSPS,  $f_{\text{DAC}} = 11796.48\text{MSPS}$  (24x interpolation), interleave mode, 1<sup>st</sup> Nyquist zone output, PLL clock mode with  $f_{\text{REF}} = 491.52\text{MHz}$ ,  $A_{\text{OUT}} = -1\text{dBFS}$ , DSA = 0dB, Sin(x)/x enabled, DSA calibrated



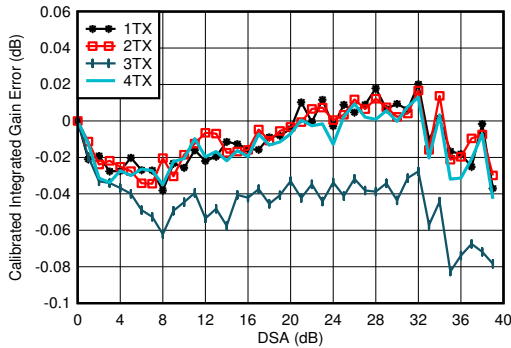
$f_{\text{DAC}} = 11796.48\text{MSPS}$ , interleave mode, matching at 4.9GHz  
Differential Gain Error =  $P_{\text{OUT}}(\text{DSA Setting} - 1) - P_{\text{OUT}}(\text{DSA Setting}) + 1$

**Figure 4-153. TX Calibrated Differential Gain Error vs DSA Setting and Channel at 4.9GHz**



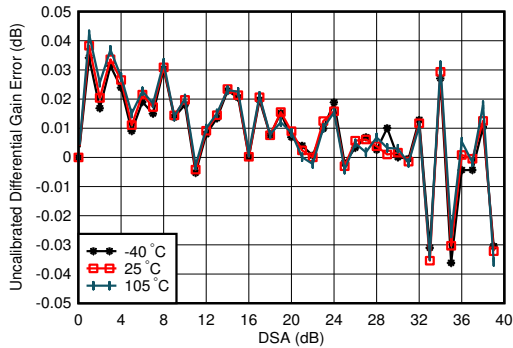
$f_{\text{DAC}} = 11796.48\text{MSPS}$ , interleave mode, matching at 4.9GHz  
Integrated Gain Error =  $P_{\text{OUT}}(\text{DSA Setting}) - P_{\text{OUT}}(\text{DSA Setting} = 0) + (\text{DSA Setting})$

**Figure 4-154. TX Uncalibrated Integrated Gain Error vs DSA Setting and Channel at 4.9GHz**



$f_{\text{DAC}} = 11796.48\text{MSPS}$ , interleave mode, matching at 4.9GHz  
Integrated Gain Error =  $P_{\text{OUT}}(\text{DSA Setting}) - P_{\text{OUT}}(\text{DSA Setting} = 0) + (\text{DSA Setting})$

**Figure 4-155. TX Calibrated Integrated Gain Error vs DSA Setting and Channel at 4.9GHz**

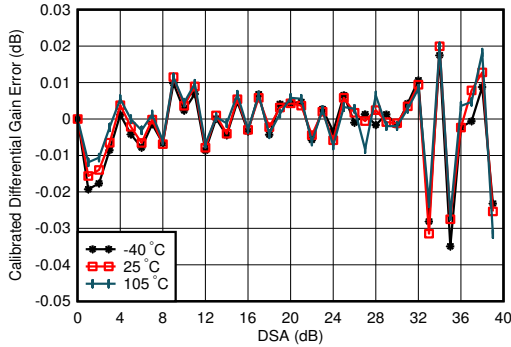


$f_{\text{DAC}} = 11796.48\text{MSPS}$ , interleaved mode, matching at 4.9GHz  
Differential Gain Error =  $P_{\text{OUT}}(\text{DSA Setting} - 1) - P_{\text{OUT}}(\text{DSA Setting}) + 1$

**Figure 4-156. TX Uncalibrated Differential Gain Error vs DSA Setting and Temperature at 4.9GHz**

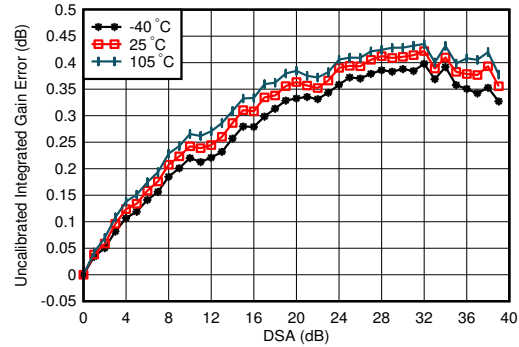
### 4.12.5 TX Typical Characteristics at 4.9GHz (continued)

Typical values at  $T_A = +25^\circ\text{C}$  with nominal supplies. Default conditions: TX input data rate = 491.52MSPS,  $f_{\text{DAC}} = 11796.48\text{MSPS}$  (24x interpolation), interleave mode, 1<sup>st</sup> Nyquist zone output, PLL clock mode with  $f_{\text{REF}} = 491.52\text{MHz}$ ,  $A_{\text{OUT}} = -1\text{dBFS}$ , DSA = 0dB, Sin(x)/x enabled, DSA calibrated



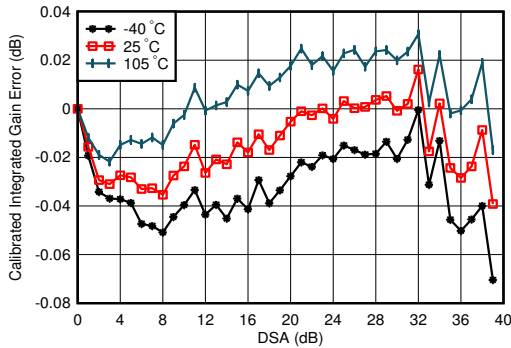
$f_{\text{DAC}} = 11796.48\text{MSPS}$ , interleaved mode, matching at 4.9GHz  
 Differential Gain Error =  $P_{\text{OUT}}(\text{DSA Setting} - 1) - P_{\text{OUT}}(\text{DSA Setting}) + 1$

**Figure 4-157. TX Calibrated Differential Gain Error vs DSA Setting and Temperature at 4.9GHz**



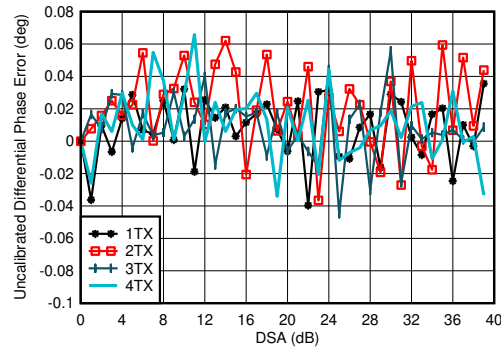
$f_{\text{DAC}} = 11796.48\text{MSPS}$ , interleaved mode, matching at 4.9GHz  
 Integrated Gain Error =  $P_{\text{OUT}}(\text{DSA Setting}) - P_{\text{OUT}}(\text{DSA Setting} = 0) + (\text{DSA Setting})$

**Figure 4-158. TX Uncalibrated Integrated Gain Error vs DSA Setting and Temperature at 4.9GHz**



$f_{\text{DAC}} = 11796.48\text{MSPS}$ , interleaved mode, matching at 4.9GHz  
 Integrated Gain Error =  $P_{\text{OUT}}(\text{DSA Setting}) - P_{\text{OUT}}(\text{DSA Setting} = 0) + (\text{DSA Setting})$

**Figure 4-159. TX Calibrated Integrated Gain Error vs DSA Setting and Temperature at 4.9GHz**

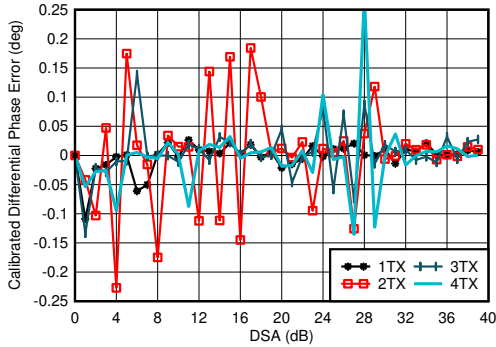


$f_{\text{DAC}} = 11796.48\text{MSPS}$ , interleaved mode, matching at 4.9GHz  
 Differential Phase Error =  $\text{Phase}_{\text{OUT}}(\text{DSA Setting} - 1) - \text{Phase}_{\text{OUT}}(\text{DSA Setting})$

**Figure 4-160. TX Uncalibrated Differential Phase Error vs DSA Setting and Channel at 4.9GHz**

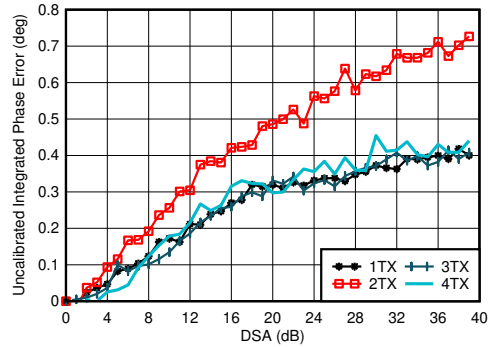
### 4.12.5 TX Typical Characteristics at 4.9GHz (continued)

Typical values at  $T_A = +25^\circ\text{C}$  with nominal supplies. Default conditions: TX input data rate = 491.52MSPS,  $f_{\text{DAC}} = 11796.48\text{MSPS}$  (24x interpolation), interleave mode, 1<sup>st</sup> Nyquist zone output, PLL clock mode with  $f_{\text{REF}} = 491.52\text{MHz}$ ,  $A_{\text{OUT}} = -1\text{dBFS}$ , DSA = 0dB, Sin(x)/x enabled, DSA calibrated



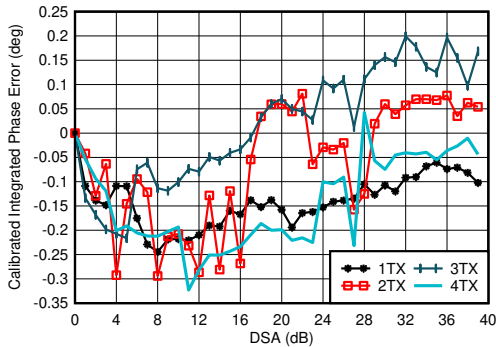
$f_{\text{DAC}} = 11796.48\text{MSPS}$ , interleaved mode, matching at 4.9GHz  
 Differential Phase Error =  $\text{Phase}_{\text{OUT}}(\text{DSA Setting} - 1) - \text{Phase}_{\text{OUT}}(\text{DSA Setting})$   
 Phase DNL spike may occur at any DSA setting.

Figure 4-161. TX Calibrated Differential Phase Error vs DSA Setting and Channel at 4.9GHz



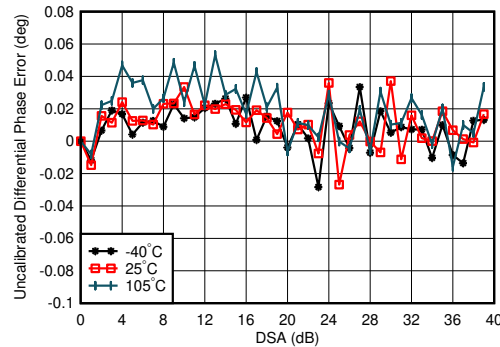
$f_{\text{DAC}} = 11796.48\text{MSPS}$ , interleaved mode, matching at 4.9GHz  
 Integrated Phase Error =  $\text{Phase}(\text{DSA Setting}) - \text{Phase}(\text{DSA Setting} = 0)$

Figure 4-162. TX Uncalibrated Integrated Phase Error vs DSA Setting and Channel at 4.9GHz



$f_{\text{DAC}} = 11796.48\text{MSPS}$ , interleaved mode, matching at 4.9GHz  
 Integrated Phase Error =  $\text{Phase}(\text{DSA Setting}) - \text{Phase}(\text{DSA Setting} = 0)$

Figure 4-163. TX Calibrated Integrated Phase Error vs DSA Setting and Channel at 4.9GHz

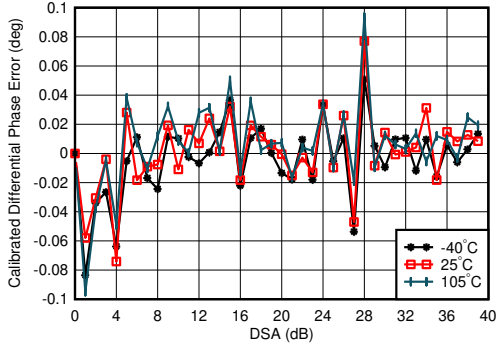


$f_{\text{DAC}} = 11796.48\text{MSPS}$ , interleaved mode, matching at 4.9GHz  
 Differential Phase Error =  $\text{Phase}_{\text{OUT}}(\text{DSA Setting} - 1) - \text{Phase}_{\text{OUT}}(\text{DSA Setting})$

Figure 4-164. TX Uncalibrated Differential Phase Error vs DSA Setting and Temperature at 4.9GHz

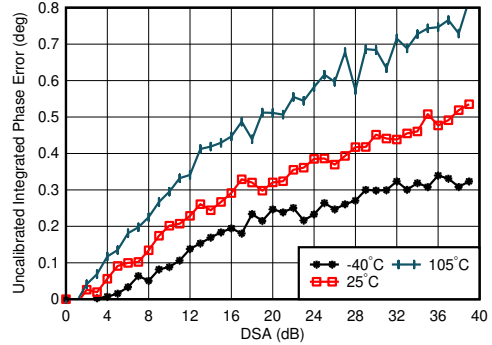
### 4.12.5 TX Typical Characteristics at 4.9GHz (continued)

Typical values at  $T_A = +25^\circ\text{C}$  with nominal supplies. Default conditions: TX input data rate = 491.52MSPS,  $f_{\text{DAC}} = 11796.48\text{MSPS}$  (24x interpolation), interleaved mode, 1<sup>st</sup> Nyquist zone output, PLL clock mode with  $f_{\text{REF}} = 491.52\text{MHz}$ ,  $A_{\text{OUT}} = -1\text{dBFS}$ , DSA = 0dB, Sin(x)/x enabled, DSA calibrated



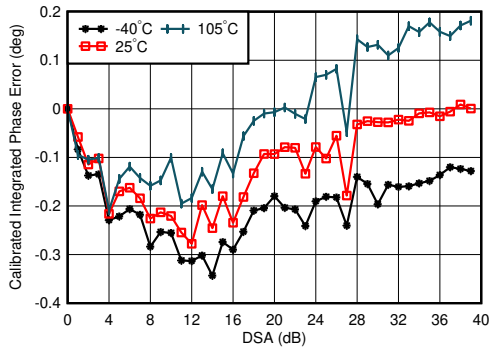
$f_{\text{DAC}} = 11796.48\text{MSPS}$ , interleaved mode, matching at 4.9GHz  
 Differential Phase Error =  $\text{Phase}_{\text{OUT}}(\text{DSA Setting} - 1) - \text{Phase}_{\text{OUT}}(\text{DSA Setting})$

**Figure 4-165. TX Calibrated Differential Phase Error vs DSA Setting and Temperature at 4.9GHz**



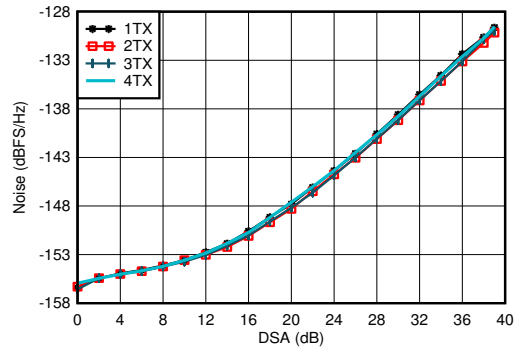
$f_{\text{DAC}} = 11796.48\text{MSPS}$ , interleaved mode, matching at 4.9GHz  
 Integrated Phase Error =  $\text{Phase}(\text{DSA Setting}) - \text{Phase}(\text{DSA Setting} = 0)$

**Figure 4-166. TX Uncalibrated Integrated Phase Error vs DSA Setting and Temperature at 4.9GHz**



$f_{\text{DAC}} = 11796.48\text{MSPS}$ , interleaved mode, matching at 4.9GHz, channel with the median variation over DSA setting at 25°C  
 Integrated Phase Error =  $\text{Phase}(\text{DSA Setting}) - \text{Phase}(\text{DSA Setting} = 0)$

**Figure 4-167. TX Calibrated Integrated Phase Error vs DSA Setting and Temperature at 4.9GHz**

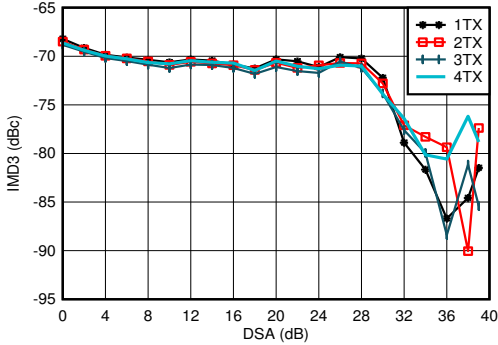


$f_{\text{DAC}} = 11796.48\text{MSPS}$ , interleaved mode, matching at 4.9GHz,  $P_{\text{OUT}} = -13\text{dBFS}$

**Figure 4-168. TX Output Noise vs Channel and Attenuation at 2.6GHz**

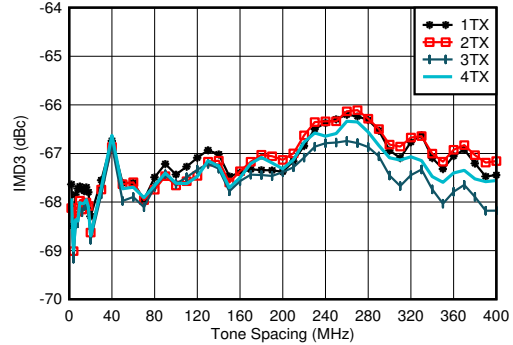
### 4.12.5 TX Typical Characteristics at 4.9GHz (continued)

Typical values at  $T_A = +25^\circ\text{C}$  with nominal supplies. Default conditions: TX input data rate = 491.52MSPS,  $f_{DAC} = 11796.48\text{MSPS}$  (24x interpolation), interleave mode, 1<sup>st</sup> Nyquist zone output, PLL clock mode with  $f_{REF} = 491.52\text{MHz}$ ,  $A_{OUT} = -1\text{dBFS}$ , DSA = 0dB, Sin(x)/x enabled, DSA calibrated



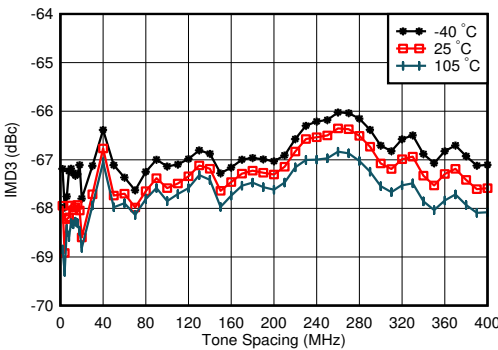
$f_{DAC} = 11796.48\text{MSPS}$ , interleaved mode, matching at 4.9GHz,  $f_{CENTER} = 4.9\text{GHz}$ , -13 dBFS each tone

**Figure 4-169. TX IMD3 vs DSA Setting at 4.9GHz**



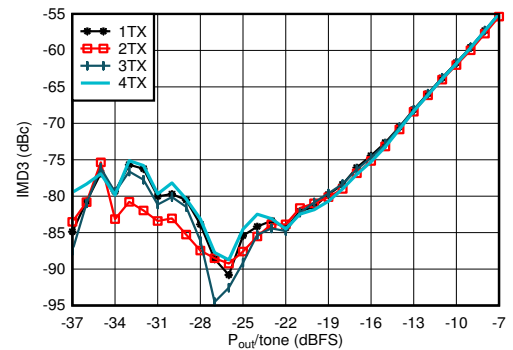
$f_{DAC} = 11796.48\text{MSPS}$ , interleaved mode, matching at 4.9GHz,  $f_{CENTER} = 4.9\text{GHz}$ , -13 dBFS each tone

**Figure 4-170. TX IMD3 vs Tone Spacing and Channel at 4.9GHz**



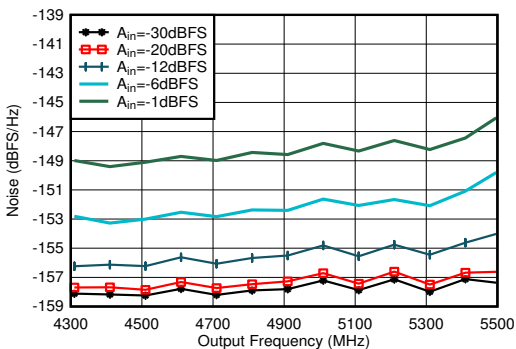
$f_{DAC} = 11796.48\text{MSPS}$ , interleaved mode, matching at 4.9GHz,  $f_{CENTER} = 4.9\text{GHz}$ , -13 dBFS each tone, worst channel

**Figure 4-171. TX IMD3 vs Tone Spacing and Temperature at 4.9GHz**



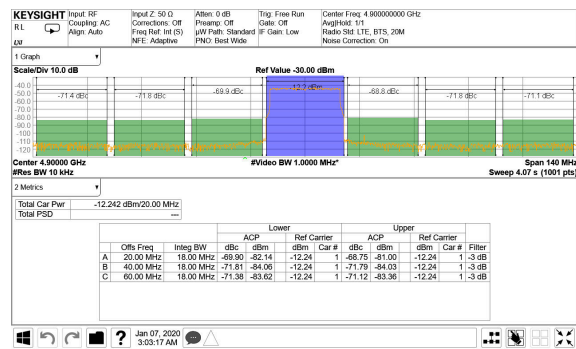
$f_{DAC} = 11796.48\text{MSPS}$ , interleaved mode, matching at 4.9GHz,  $f_{CENTER} = 4.9\text{GHz}$ ,  $f_{SPACING} = 20\text{MHz}$

**Figure 4-172. TX IMD3 vs Digital Level at 4.9GHz**



Matching at 4.9GHz, Single tone,  $f_{DAC} = 11.79648\text{GSPPS}$ , interleave mode, 40MHz offset, DSA = 0dB

**Figure 4-173. TX Single Tone Output Noise vs Frequency and Amplitude at 4.9GHz**

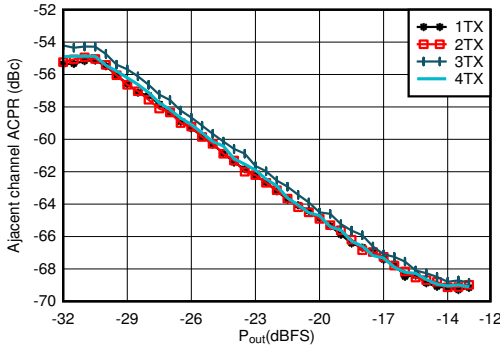


TM1.1,  $P_{OUT\_RMS} = -13\text{dBFS}$

**Figure 4-174. TX 20MHz LTE Output Spectrum at 4.9GHz**

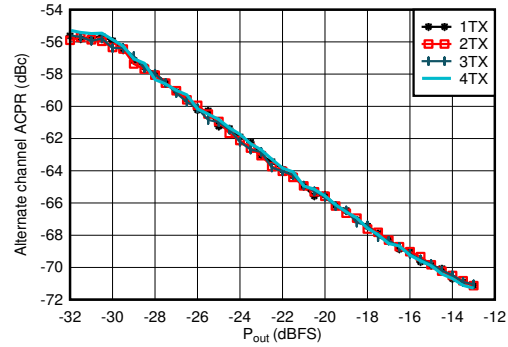
**4.12.5 TX Typical Characteristics at 4.9GHz (continued)**

Typical values at  $T_A = +25^\circ\text{C}$  with nominal supplies. Default conditions: TX input data rate = 491.52MSPS,  $f_{DAC} = 11796.48\text{MSPS}$  (24x interpolation), interleave mode, 1<sup>st</sup> Nyquist zone output, PLL clock mode with  $f_{REF} = 491.52\text{MHz}$ ,  $A_{OUT} = -1\text{dBFS}$ , DSA = 0dB, Sin(x)/x enabled, DSA calibrated



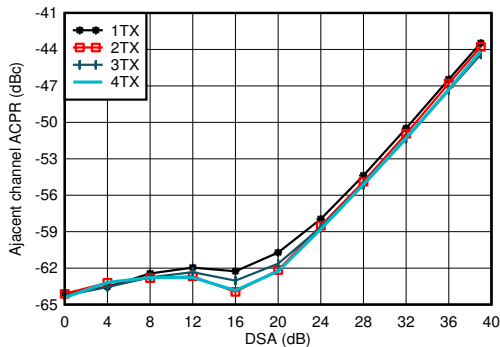
Matching at 4.9GHz, single carrier 20MHz BW TM1.1 LTE

**Figure 4-175. TX 20MHz LTE ACPR vs Digital Level at 4.9GHz**



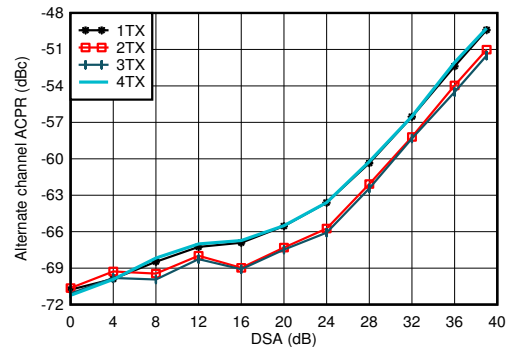
Matching at 4.9GHz, single carrier 20MHz BW TM1.1 LTE

**Figure 4-176. TX 20MHz LTE alt-ACPR vs Digital Level at 4.9GHz**



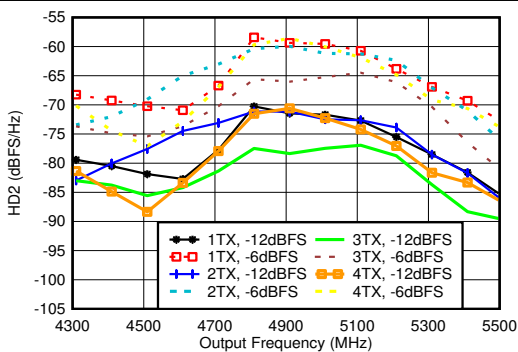
Matching at 4.9GHz, single carrier 20MHz BW TM1.1 LTE

**Figure 4-177. TX 20MHz LTE ACPR vs DSA at 4.9GHz**



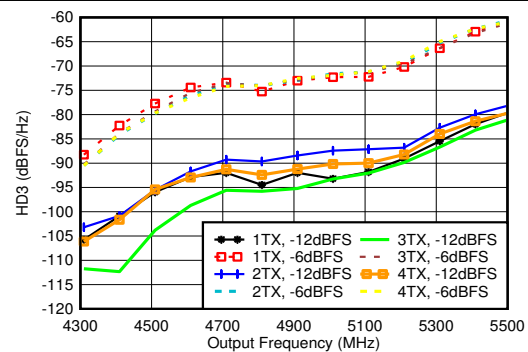
Matching at 4.9GHz, single carrier 20MHz BW TM1.1 LTE

**Figure 4-178. TX 20MHz LTE alt-ACPR vs DSA at 4.9GHz**



Matching at 4.9GHz,  $f_{DAC} = 11.79648\text{GSPS}$ , interleave mode, normalized to output power at harmonic frequency

**Figure 4-179. TX HD2 vs Digital Amplitude and Output Frequency at 4.9GHz**

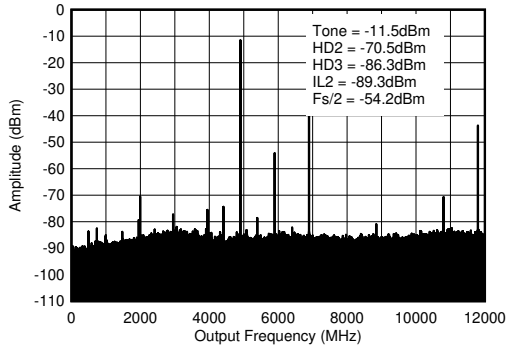


Matching at 4.9GHz,  $f_{DAC} = 11.79648\text{GSPS}$ , interleave mode, normalized to output power at harmonic frequency

**Figure 4-180. TX HD3 vs Digital Amplitude and Output Frequency at 4.9GHz**

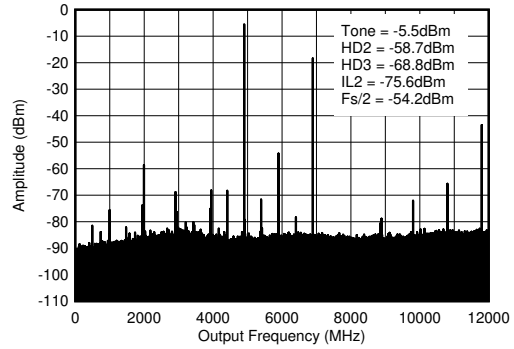
### 4.12.5 TX Typical Characteristics at 4.9GHz (continued)

Typical values at  $T_A = +25^\circ\text{C}$  with nominal supplies. Default conditions: TX input data rate = 491.52MSPS,  $f_{\text{DAC}} = 11796.48\text{MSPS}$  (24x interpolation), interleave mode, 1<sup>st</sup> Nyquist zone output, PLL clock mode with  $f_{\text{REF}} = 491.52\text{MHz}$ ,  $A_{\text{OUT}} = -1\text{dBFS}$ , DSA = 0dB, Sin(x)/x enabled, DSA calibrated



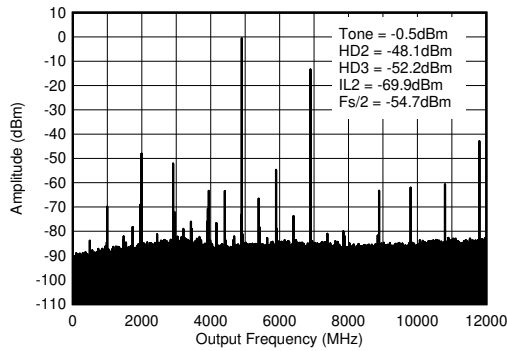
$f_{\text{DAC}} = 11796.48\text{MSPS}$ , interleave mode, 4.9GHz matching, includes PCB and cable losses.  $\text{ILn} = f_{\text{S}}/\text{n} \pm f_{\text{OUT}}$ .

**Figure 4-181. TX Single Tone (-12 dBFS) Output Spectrum at 4.9GHz (0- $f_{\text{DAC}}$ )**



$f_{\text{DAC}} = 11796.48\text{MSPS}$ , interleave mode, 4.9GHz matching, includes PCB and cable losses.  $\text{ILn} = f_{\text{S}}/\text{n} \pm f_{\text{OUT}}$ .

**Figure 4-182. TX Single Tone (-6 dBFS) Output Spectrum at 4.9GHz (0- $f_{\text{DAC}}$ )**

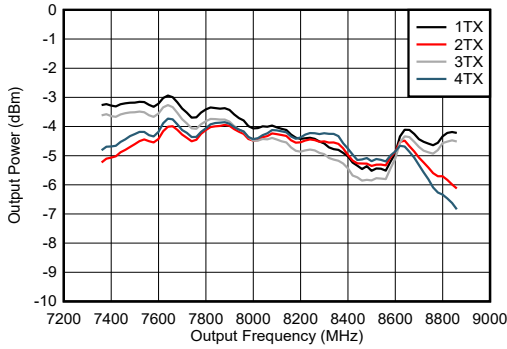


$f_{\text{DAC}} = 11796.48\text{MSPS}$ , interleave mode, 4.9GHz matching, includes PCB and cable losses.  $\text{ILn} = f_{\text{S}}/\text{n} \pm f_{\text{OUT}}$ .

**Figure 4-183. TX Single Tone (-1 dBFS) Output Spectrum at 4.9GHz (0- $f_{\text{DAC}}$ )**

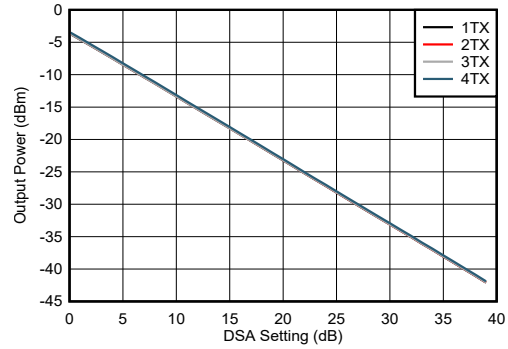
### 4.12.6 TX Typical Characteristics at 8.1GHz

Typical values at  $T_A = +25^\circ\text{C}$  with nominal supplies. Default conditions: TX input data rate = 491.52MSPS,  $f_{\text{DAC}} = 11796.48$  MSPS (24x interpolation), mixed mode, 1<sup>st</sup> Nyquist zone output, PLL clock mode with  $f_{\text{REF}} = 491.52\text{MHz}$ ,  $A_{\text{OUT}} = -1$  dBFS, DSA = 0 dB, Sin(x)/x enabled, DSA calibrated, 8.1GHz matching



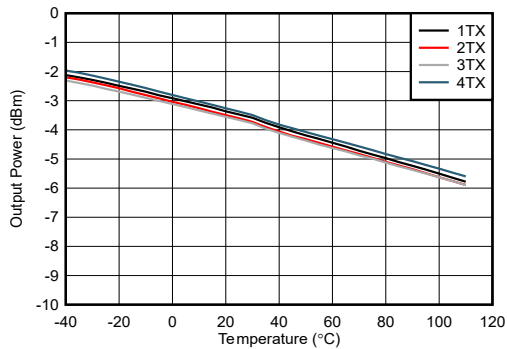
includes PCB and cable losses.

Figure 4-184. TX Output Power vs Frequency at 8.1GHz



includes PCB and cable losses.

Figure 4-185. TX Output Power vs DSA Setting at 8.1GHz



includes PCB and cable losses.

Figure 4-186. TX Output Power vs Temperature at 8.1GHz

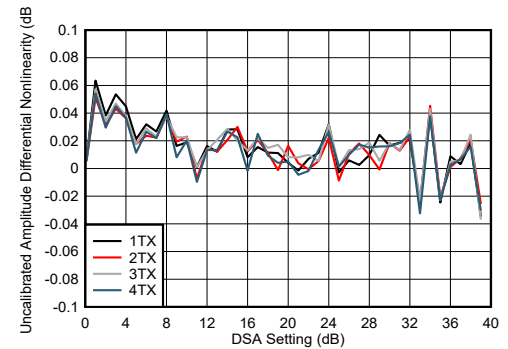


Figure 4-187. TX DSA Uncalibrated Amplitude Differential Nonlinearity at 8.1GHz

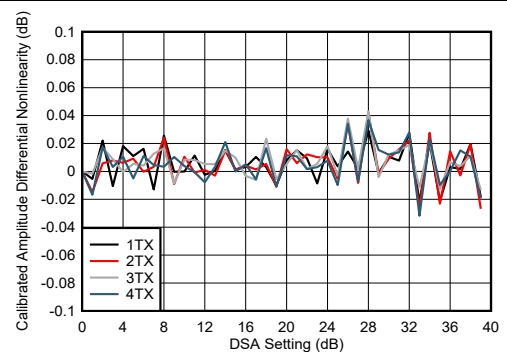


Figure 4-188. TX DSA Calibrated Amplitude Differential Nonlinearity at 8.1GHz

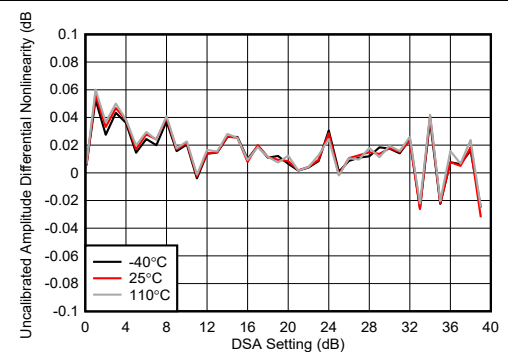
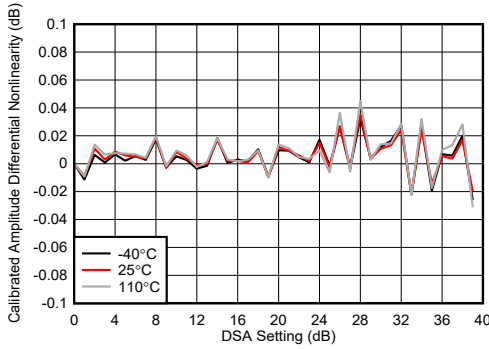


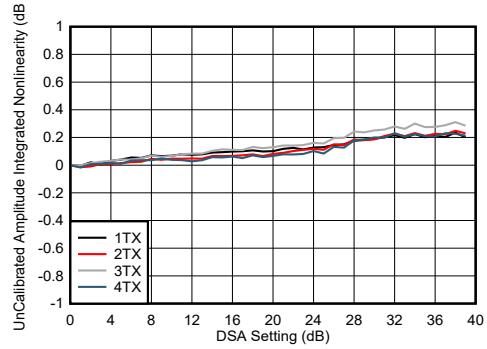
Figure 4-189. TX DSA Uncalibrated Amplitude Differential Nonlinearity at 8.1GHz

### 4.12.6 TX Typical Characteristics at 8.1GHz (continued)

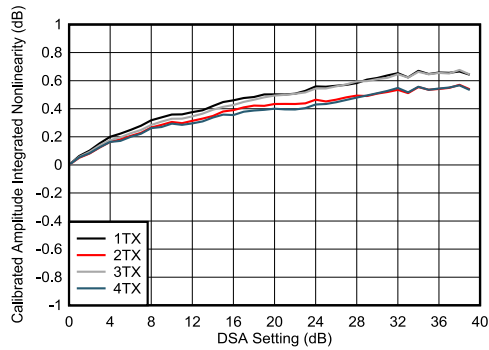
Typical values at  $T_A = +25^\circ\text{C}$  with nominal supplies. Default conditions: TX input data rate = 491.52MSPS,  $f_{\text{DAC}} = 11796.48$  MSPS (24x interpolation), mixed mode, 1<sup>st</sup> Nyquist zone output, PLL clock mode with  $f_{\text{REF}} = 491.52\text{MHz}$ ,  $A_{\text{OUT}} = -1$  dBFS, DSA = 0 dB, Sin(x)/x enabled, DSA calibrated, 8.1GHz matching



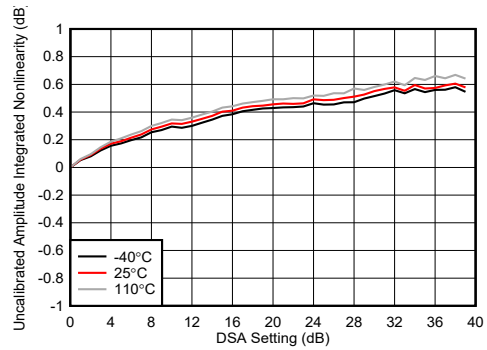
**Figure 4-190. TX DSA Calibrated Amplitude Differential Nonlinearity at 8.11GHz**



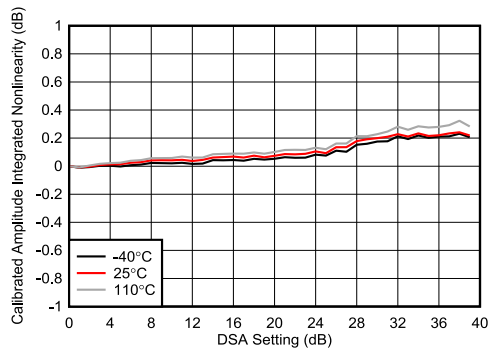
**Figure 4-191. TX DSA Uncalibrated Amplitude Integrated Nonlinearity at 8.11GHz**



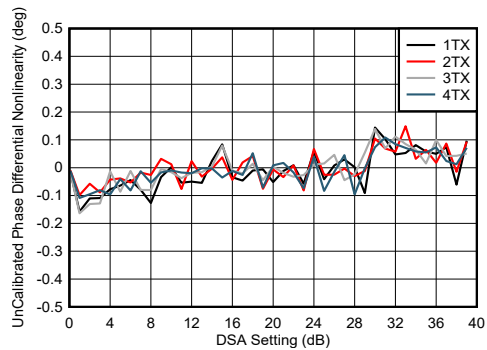
**Figure 4-192. TX DSA Calibrated Amplitude Integrated Nonlinearity at 8.11GHz**



**Figure 4-193. TX DSA Uncalibrated Amplitude Integrated Nonlinearity at 8.11GHz**



**Figure 4-194. TX DSA Calibrated Amplitude Integrated Nonlinearity at 8.11GHz**



**Figure 4-195. TX DSA Uncalibrated Phase Differential Nonlinearity at 8.11GHz**

### 4.12.6 TX Typical Characteristics at 8.1GHz (continued)

Typical values at  $T_A = +25^\circ\text{C}$  with nominal supplies. Default conditions: TX input data rate = 491.52MSPS,  $f_{\text{DAC}} = 11796.48$  MSPS (24x interpolation), mixed mode, 1<sup>st</sup> Nyquist zone output, PLL clock mode with  $f_{\text{REF}} = 491.52\text{MHz}$ ,  $A_{\text{OUT}} = -1$  dBFS, DSA = 0 dB, Sin(x)/x enabled, DSA calibrated, 8.1GHz matching

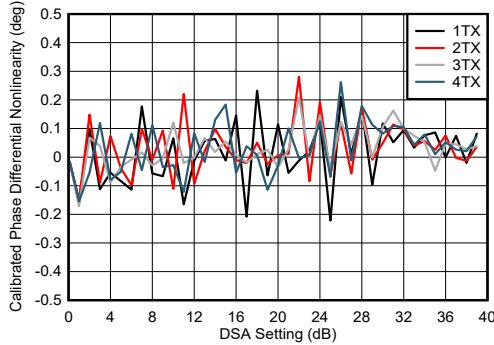


Figure 4-196. TX DSA Calibrated Phase Differential Nonlinearity at 8.1GHz

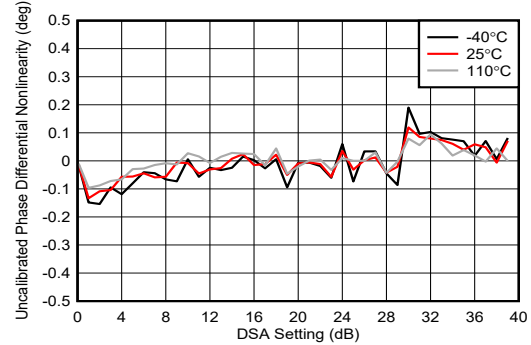


Figure 4-197. TX DSA Uncalibrated Phase Differential Nonlinearity at 8.1GHz

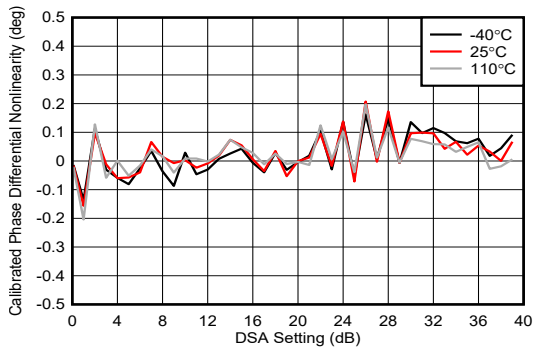


Figure 4-198. TX DSA Calibrated Phase Differential Nonlinearity at 8.1GHz

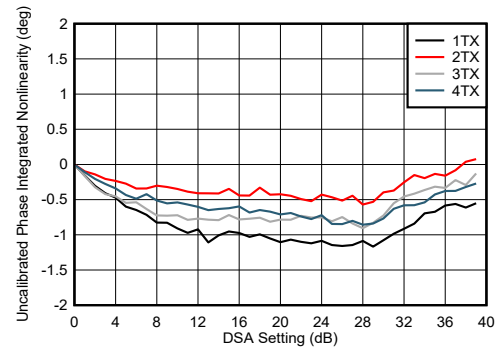


Figure 4-199. TX DSA Uncalibrated Phase Integrated Nonlinearity at 8.1GHz

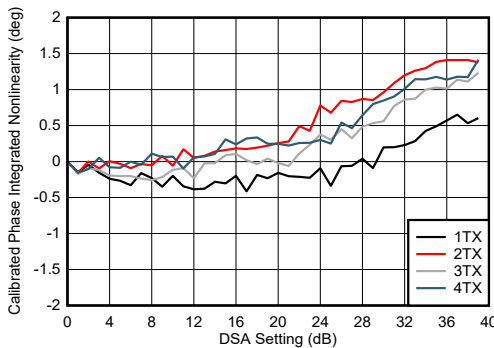


Figure 4-200. TX DSA Calibrated Phase Integrated Nonlinearity at 8.1GHz

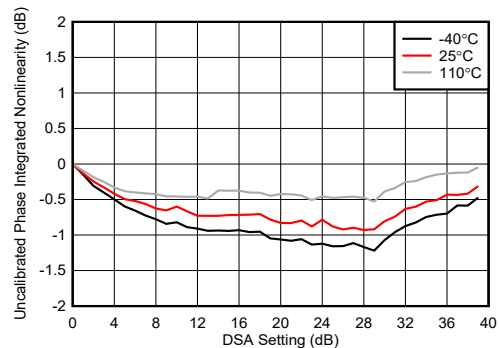
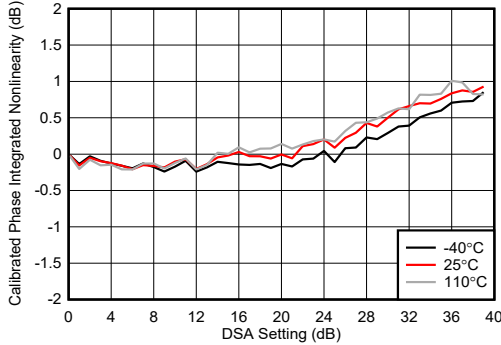


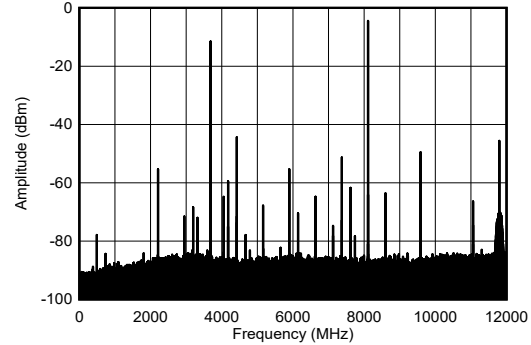
Figure 4-201. TX DSA Uncalibrated Phase Integrated Nonlinearity at 8.1GHz

**4.12.6 TX Typical Characteristics at 8.1GHz (continued)**

Typical values at  $T_A = +25^\circ\text{C}$  with nominal supplies. Default conditions: TX input data rate = 491.52MSPS,  $f_{\text{DAC}} = 11796.48$  MSPS (24x interpolation), mixed mode, 1<sup>st</sup> Nyquist zone output, PLL clock mode with  $f_{\text{REF}} = 491.52\text{MHz}$ ,  $A_{\text{OUT}} = -1$  dBFS, DSA = 0 dB, Sin(x)/x enabled, DSA calibrated, 8.1GHz matching

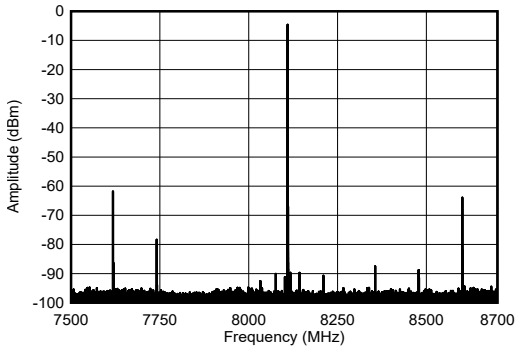


**Figure 4-202. TX DSA Calibrated Phase Integrated Nonlinearity at 8.1GHz**



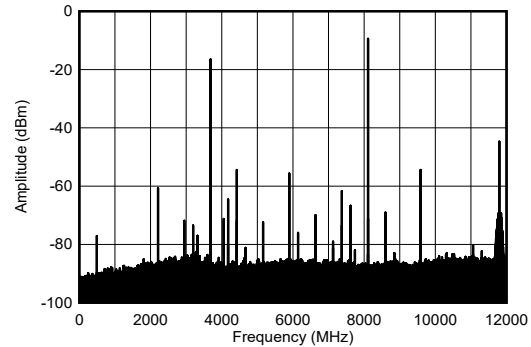
-1dBFS

**Figure 4-203. TX Single Tone Output Spectrum at 8.1GHz**



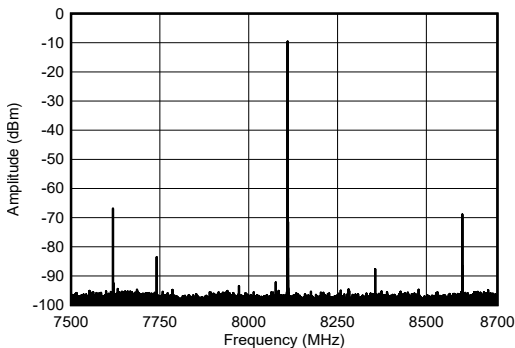
-1dBFS

**Figure 4-204. TX Single Tone Output Spectrum at 8.1GHz**



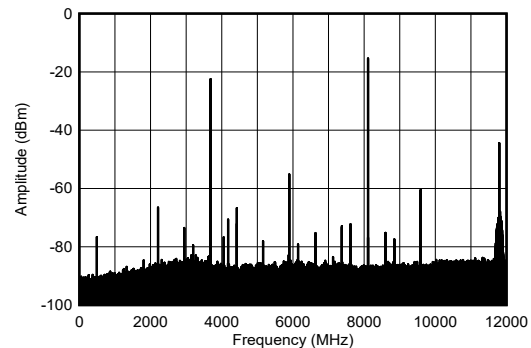
-6dBFS

**Figure 4-205. TX Single Tone Output Spectrum at 8.1GHz**



-6dBFS

**Figure 4-206. TX Single Tone Output Spectrum at 8.1GHz**

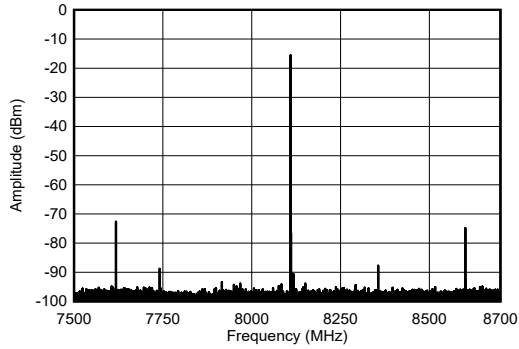


-12dBFS

**Figure 4-207. TX Single Tone Output Spectrum at 8.1GHz**

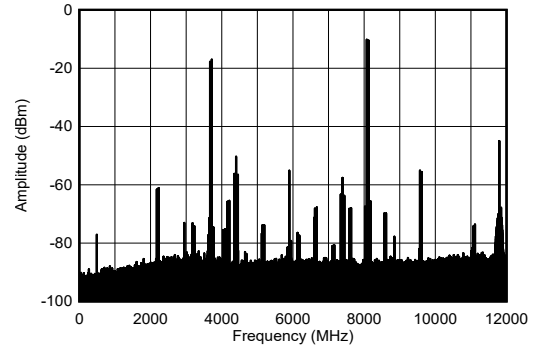
### 4.12.6 TX Typical Characteristics at 8.1GHz (continued)

Typical values at  $T_A = +25^\circ\text{C}$  with nominal supplies. Default conditions: TX input data rate = 491.52MSPS,  $f_{\text{DAC}} = 11796.48$  MSPS (24x interpolation), mixed mode, 1<sup>st</sup> Nyquist zone output, PLL clock mode with  $f_{\text{REF}} = 491.52\text{MHz}$ ,  $A_{\text{OUT}} = -1$  dBFS, DSA = 0 dB, Sin(x)/x enabled, DSA calibrated, 8.1GHz matching



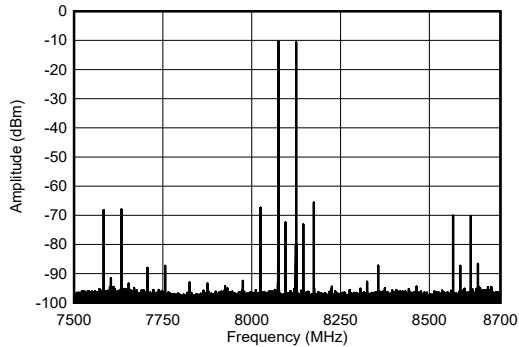
-12dBFS

Figure 4-208. TX Single Tone Output Spectrum at 8.11GHz



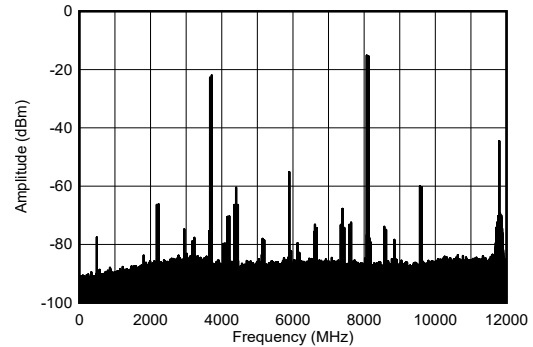
50MHz tone spacing, -7dBFS each tone

Figure 4-209. TX Dual Tone Output Spectrum at 8.11GHz



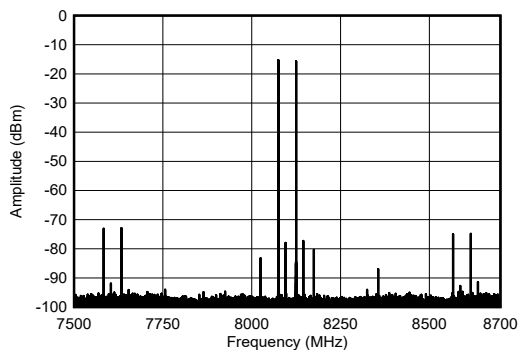
50MHz tone spacing, -7dBFS each tone

Figure 4-210. TX Dual Tone Output Spectrum at 8.11GHz



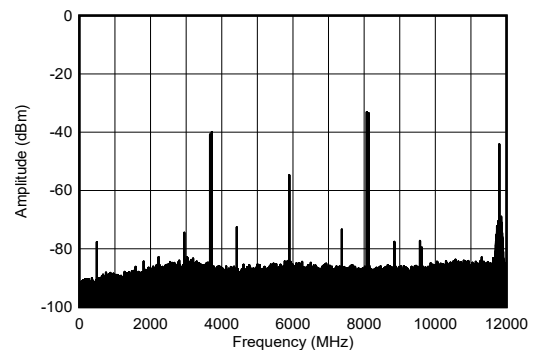
50MHz tone spacing, -12dBFS each tone

Figure 4-211. TX Dual Tone Output Spectrum at 8.11GHz



50MHz tone spacing, -12dBFS each tone

Figure 4-212. TX Dual Tone Output Spectrum at 8.11GHz

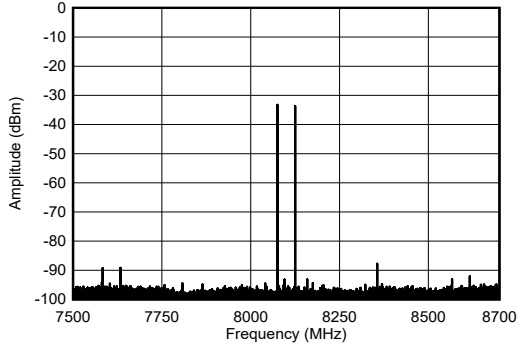


50MHz tone spacing, -30dBFS each tone

Figure 4-213. TX Dual Tone Output Spectrum at 8.11GHz

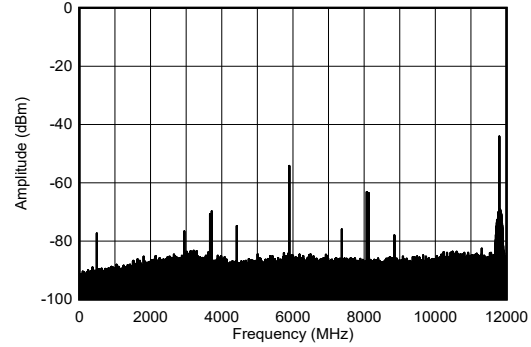
**4.12.6 TX Typical Characteristics at 8.1GHz (continued)**

Typical values at  $T_A = +25^\circ\text{C}$  with nominal supplies. Default conditions: TX input data rate = 491.52MSPS,  $f_{DAC} = 11796.48$  MSPS (24x interpolation), mixed mode, 1<sup>st</sup> Nyquist zone output, PLL clock mode with  $f_{REF} = 491.52\text{MHz}$ ,  $A_{OUT} = -1$  dBFS, DSA = 0 dB, Sin(x)/x enabled, DSA calibrated, 8.1GHz matching



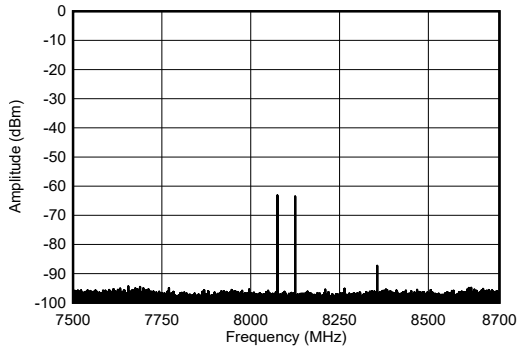
50MHz tone spacing, -30dBFS each tone

**Figure 4-214. TX Dual Tone Output Spectrum at 8.11GHz**



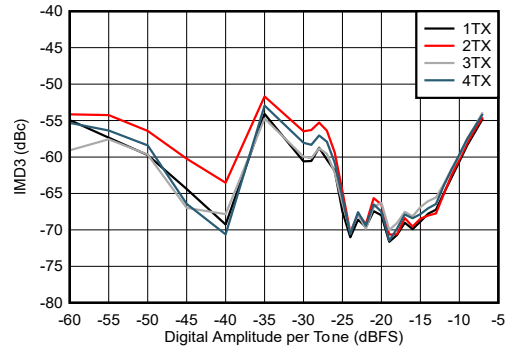
50MHz tone spacing, -60dBFS each tone

**Figure 4-215. TX Dual Tone Output Spectrum at 8.11GHz**



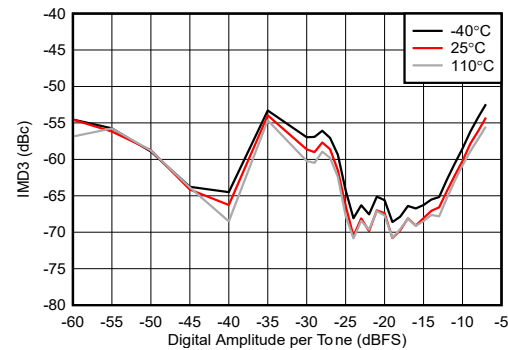
50MHz tone spacing, -60dBFS each tone

**Figure 4-216. TX Dual Tone Output Spectrum at 8.11GHz**



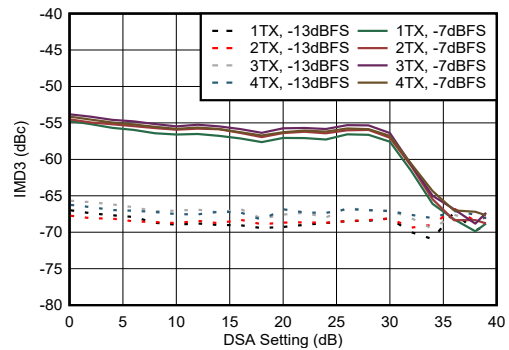
-7dBFS each tone, 50MHz tone spacing

**Figure 4-217. TX IMD3 vs Digital Amplitude at 8.11GHz**



-7dBFS each tone, 50MHz tone spacing

**Figure 4-218. TX IMD3 vs Digital Amplitude at 8.11GHz**

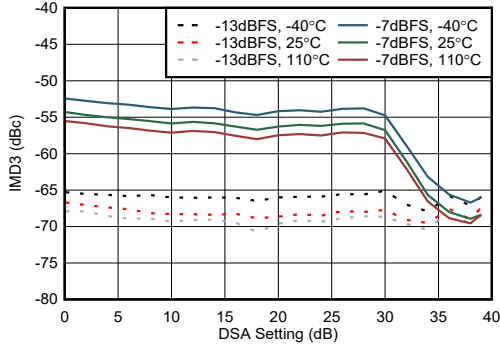


50MHz tone spacing

**Figure 4-219. TX IMD3 vs DSA Setting at 8.11GHz**

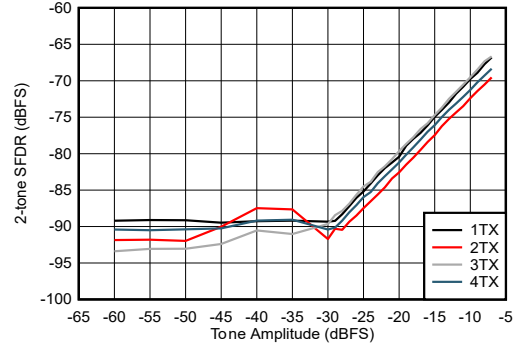
### 4.12.6 TX Typical Characteristics at 8.1GHz (continued)

Typical values at  $T_A = +25^\circ\text{C}$  with nominal supplies. Default conditions: TX input data rate = 491.52MSPS,  $f_{\text{DAC}} = 11796.48$  MSPS (24x interpolation), mixed mode, 1<sup>st</sup> Nyquist zone output, PLL clock mode with  $f_{\text{REF}} = 491.52\text{MHz}$ ,  $A_{\text{OUT}} = -1$  dBFS, DSA = 0 dB, Sin(x)/x enabled, DSA calibrated, 8.1GHz matching



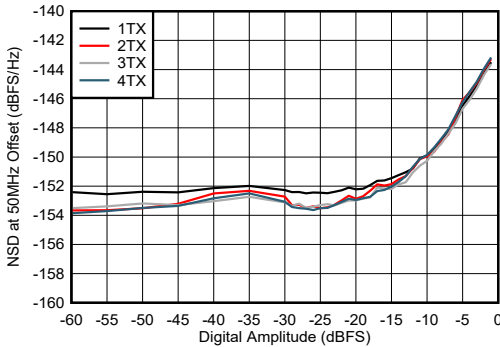
50 MHz tone spacing

Figure 4-220. TX IMD3 vs DSA Setting at 8.11GHz



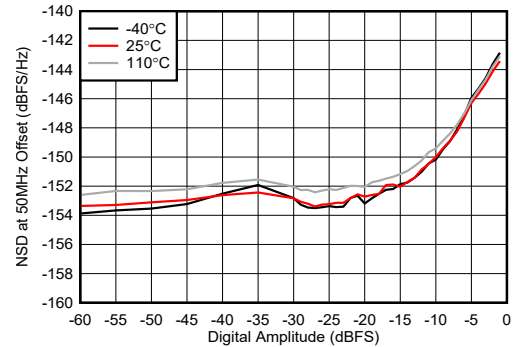
50 MHz tone spacing

Figure 4-221. TX 2-Tone SFDR vs Digital Amplitude at 8.11GHz



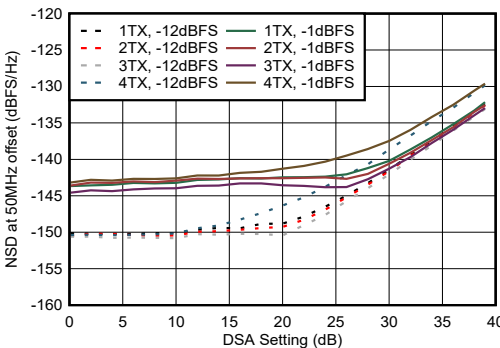
50 MHz offset

Figure 4-222. TX NSD vs Digital Amplitude at 8.11GHz



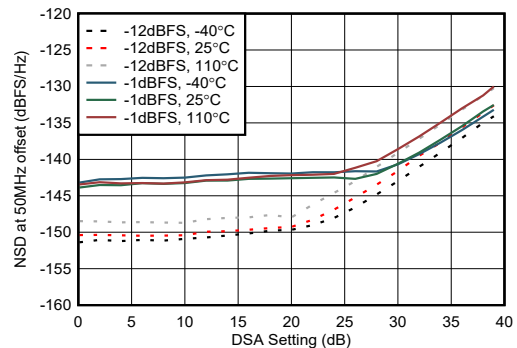
50 MHz offset

Figure 4-223. TX NSD vs Digital Amplitude at 8.11GHz



50 MHz offset

Figure 4-224. TX NSD vs DSA Setting at 8.11GHz



50 MHz offset

Figure 4-225. TX NSD vs DSA Setting at 8.11GHz

### 4.12.6 TX Typical Characteristics at 8.1GHz (continued)

Typical values at  $T_A = +25^\circ\text{C}$  with nominal supplies. Default conditions: TX input data rate = 491.52MSPS,  $f_{DAC} = 11796.48$  MSPS (24x interpolation), mixed mode, 1<sup>st</sup> Nyquist zone output, PLL clock mode with  $f_{REF} = 491.52\text{MHz}$ ,  $A_{OUT} = -1$  dBFS, DSA = 0 dB, Sin(x)/x enabled, DSA calibrated, 8.1GHz matching

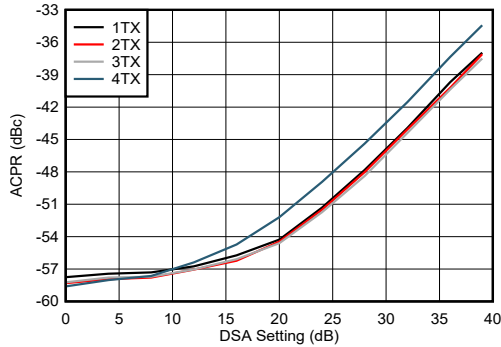


Figure 4-226. TX NR100MHz ACPR vs DSA Setting 8.11GHz

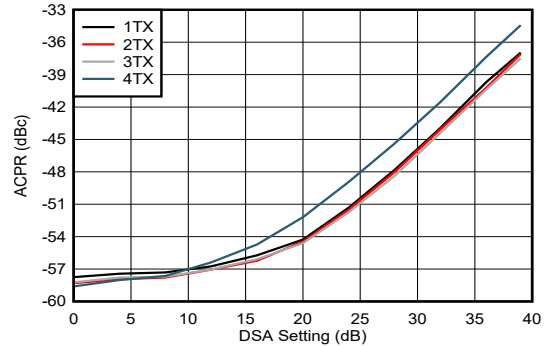


Figure 4-227. TX NR100MHz alt-ACPR vs DSA Setting 8.11GHz

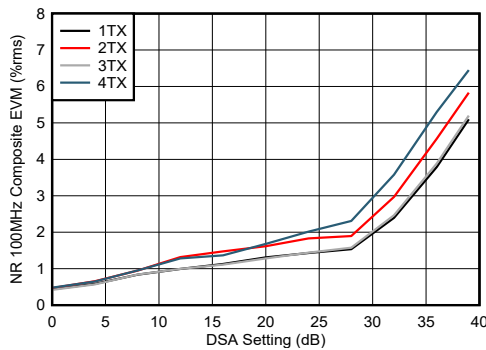


Figure 4-228. TX NR100MHz EVM vs DSA Setting 8.11GHz

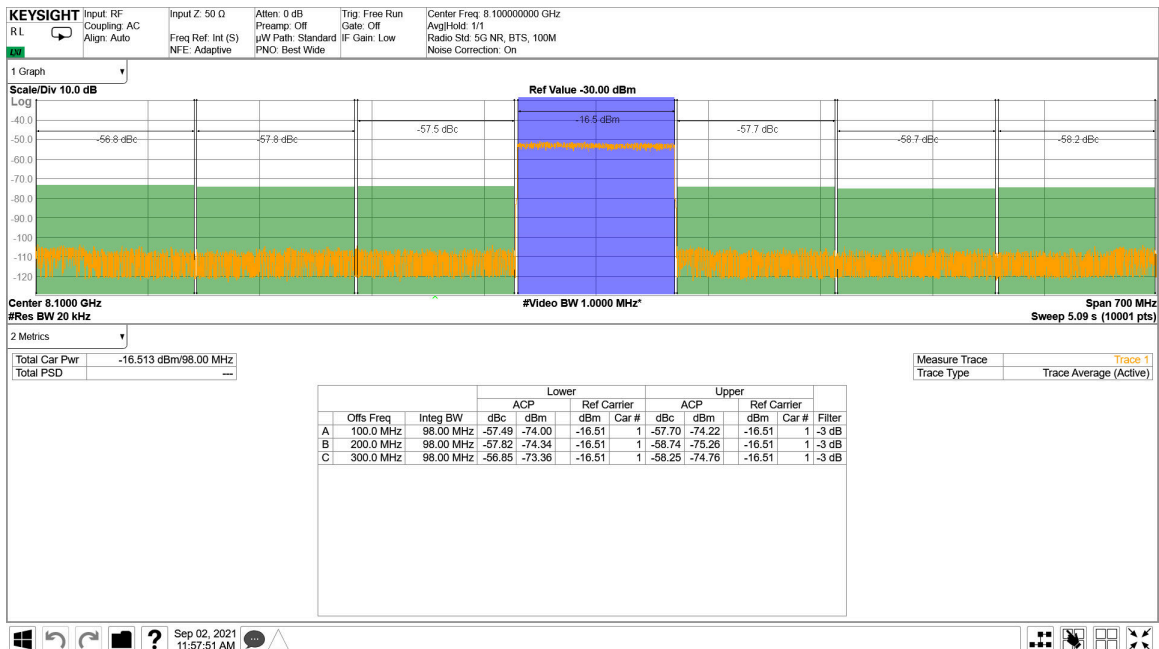


Figure 4-229. TX 100MHz NR Output Spectrum at 8.11GHz

**AFE7950-SP, AFE7950-SEP**

SBASAG7B – MARCH 2024 – REVISED JUNE 2026

**4.12.6 TX Typical Characteristics at 8.1GHz (continued)**

Typical values at  $T_A = +25^\circ\text{C}$  with nominal supplies. Default conditions: TX input data rate = 491.52MSPS,  $f_{DAC} = 11796.48$  MSPS (24x interpolation), mixed mode, 1<sup>st</sup> Nyquist zone output, PLL clock mode with  $f_{REF} = 491.52\text{MHz}$ ,  $A_{OUT} = -1$  dBFS, DSA = 0 dB, Sin(x)/x enabled, DSA calibrated, 8.1GHz matching

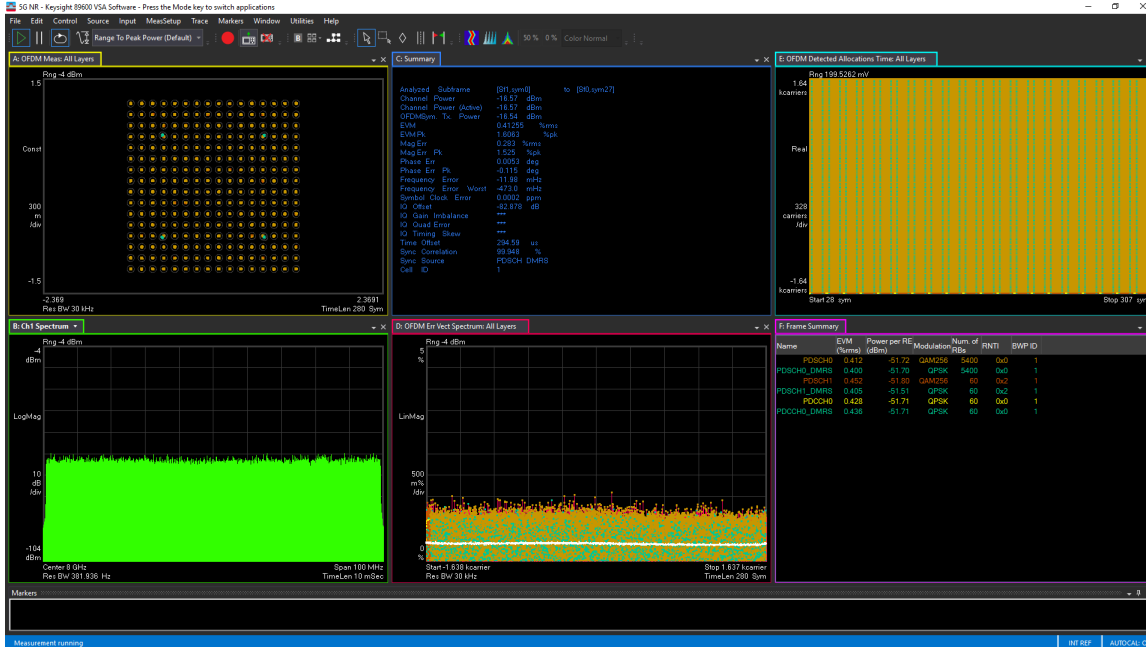


Figure 4-230. TX 100MHz NR EVM at 8.11GHz

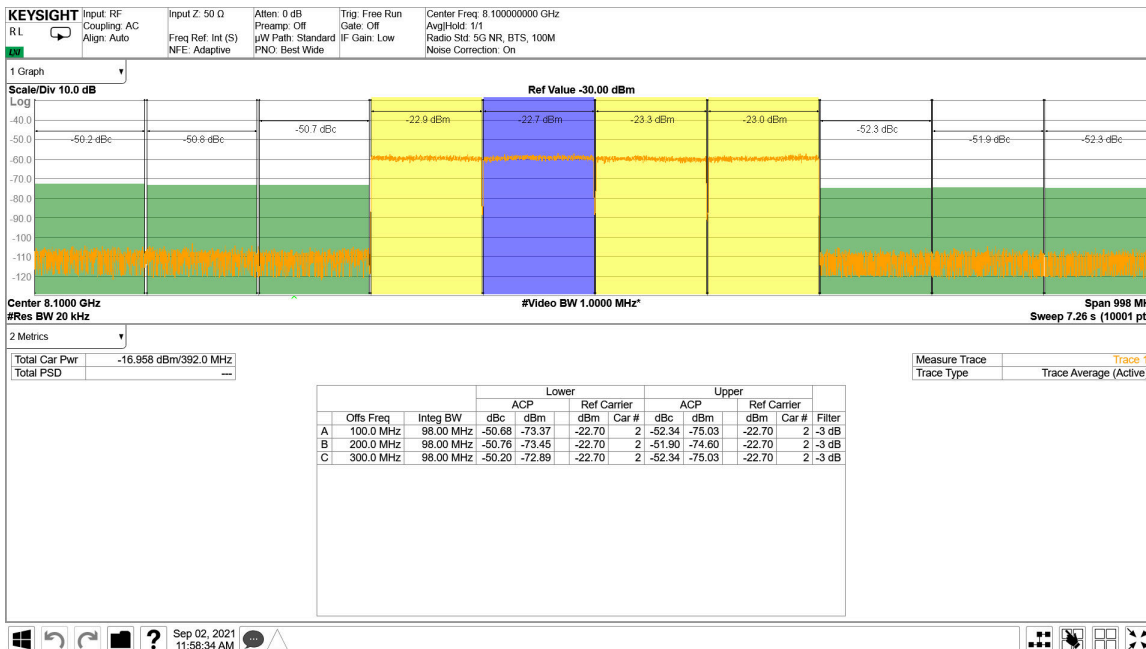


Figure 4-231. TX 4x100MHz NR Output Spectrum 8.11GHz

### 4.12.6 TX Typical Characteristics at 8.1GHz (continued)

Typical values at  $T_A = +25^\circ\text{C}$  with nominal supplies. Default conditions: TX input data rate = 491.52MSPS,  $f_{DAC} = 11796.48$  MSPS (24x interpolation), mixed mode, 1<sup>st</sup> Nyquist zone output, PLL clock mode with  $f_{REF} = 491.52\text{MHz}$ ,  $A_{OUT} = -1$  dBFS, DSA = 0 dB, Sin(x)/x enabled, DSA calibrated, 8.1GHz matching

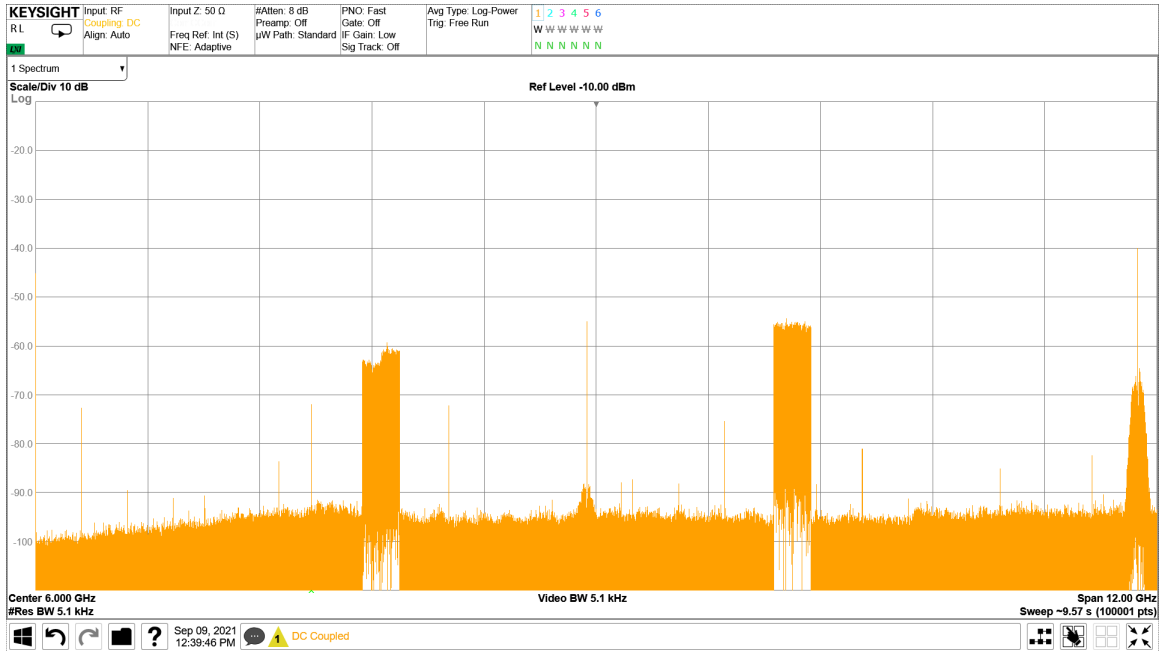
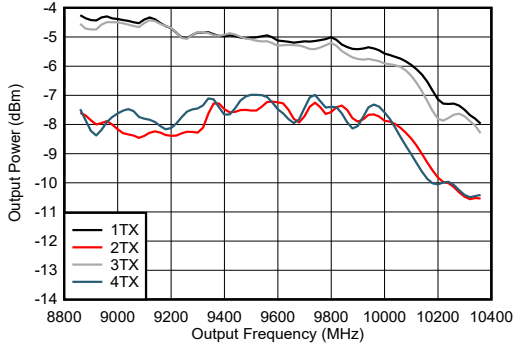


Figure 4-232. TX 4x100MHz NR Output Spectrum 8.1GHz

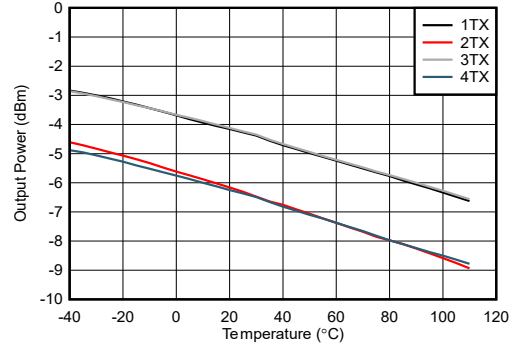
### 4.12.7 TX Typical Characteristics at 9.6GHz

Typical values at  $T_A = +25^\circ\text{C}$  with nominal supplies. Default conditions: TX input data rate = 1474.56MSPS,  $f_{\text{DAC}} = 11796.48\text{MSPS}$  (8x interpolation), Mixed mode, 1<sup>st</sup> Nyquist zone output, PLL clock mode with  $f_{\text{REF}} = 491.52\text{MHz}$ ,  $A_{\text{OUT}} = -1\text{dBFS}$ , DSA = 0dB, Sin(x)/x enabled, DSA calibrated, 9.6GHz matching



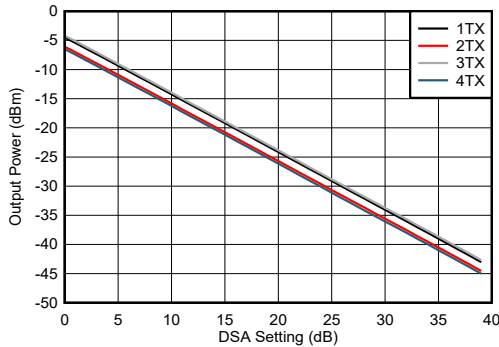
Includes PCB and cable losses.

Figure 4-233. TX Output Power vs Frequency at 9.61GHz



Includes PCB and cable losses.

Figure 4-234. TX Output Power vs Frequency at 9.61GHz



Includes PCB and cable losses.

Figure 4-235. TX Output Power vs DSA Setting at 9.61GHz

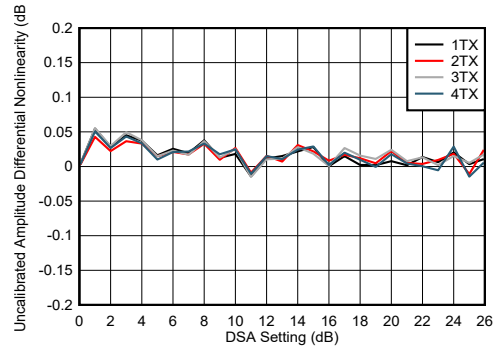


Figure 4-236. TX DSA Uncalibrated Amplitude Differential Nonlinearity

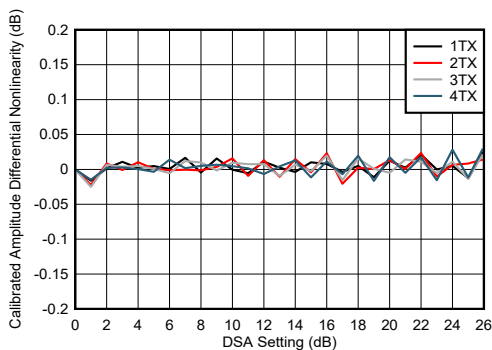


Figure 4-237. TX DSA Calibrated Amplitude Differential Nonlinearity

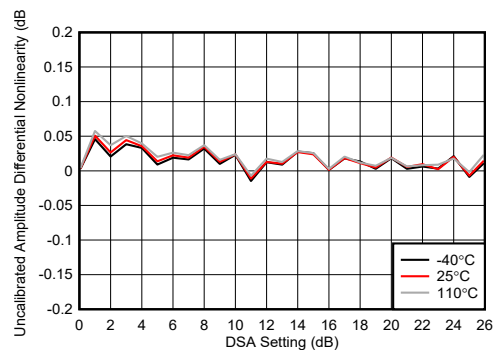
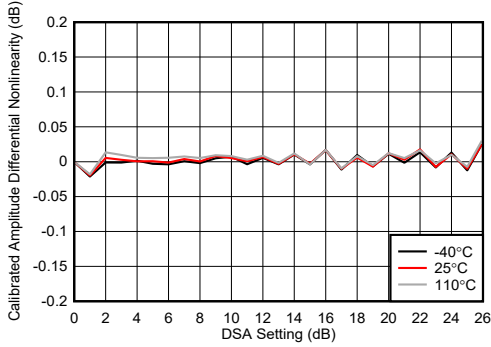


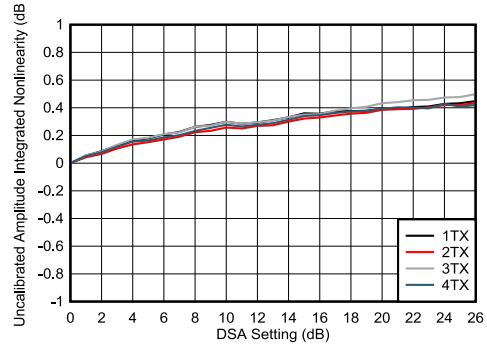
Figure 4-238. TX DSA Uncalibrated Amplitude Differential Nonlinearity

**4.12.7 TX Typical Characteristics at 9.6GHz (continued)**

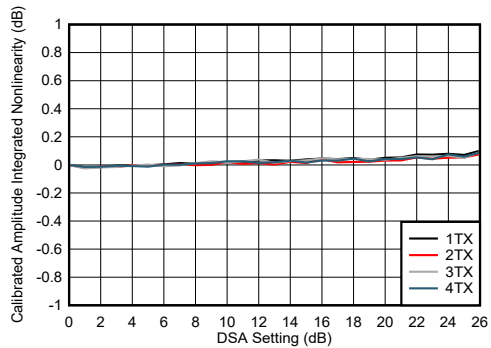
Typical values at  $T_A = +25^\circ\text{C}$  with nominal supplies. Default conditions: TX input data rate = 1474.56MSPS,  $f_{DAC} = 11796.48\text{MSPS}$  (8x interpolation), Mixed mode, 1<sup>st</sup> Nyquist zone output, PLL clock mode with  $f_{REF} = 491.52\text{MHz}$ ,  $A_{OUT} = -1\text{dBFS}$ , DSA = 0dB, Sin(x)/x enabled, DSA calibrated, 9.6GHz matching



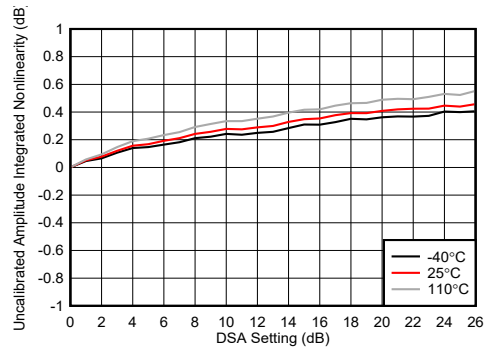
**Figure 4-239. TX DSA Calibrated Amplitude Differential Nonlinearity**



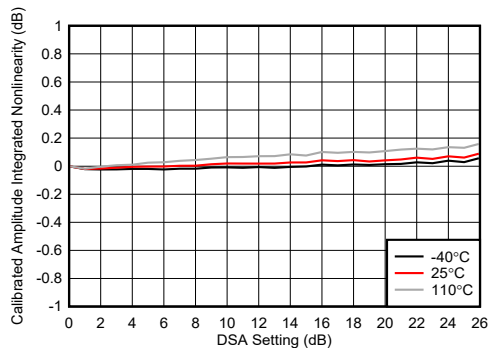
**Figure 4-240. TX DSA Uncalibrated Amplitude Integrated Nonlinearity**



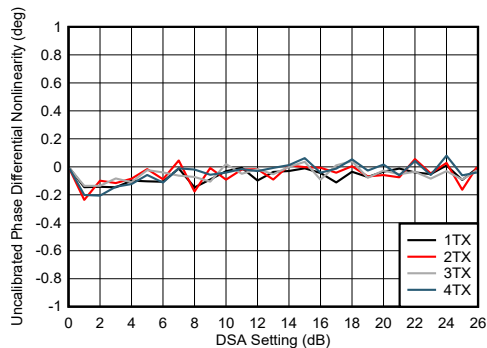
**Figure 4-241. TX DSA Calibrated Amplitude Integrated Nonlinearity**



**Figure 4-242. TX DSA Uncalibrated Amplitude Integrated Nonlinearity**



**Figure 4-243. TX DSA Calibrated Amplitude Integrated Nonlinearity**



**Figure 4-244. TX DSA Uncalibrated Phase Differential Nonlinearity**

### 4.12.7 TX Typical Characteristics at 9.6GHz (continued)

Typical values at  $T_A = +25^\circ\text{C}$  with nominal supplies. Default conditions: TX input data rate = 1474.56MSPS,  $f_{\text{DAC}} = 11796.48\text{MSPS}$  (8x interpolation), Mixed mode, 1<sup>st</sup> Nyquist zone output, PLL clock mode with  $f_{\text{REF}} = 491.52\text{MHz}$ ,  $A_{\text{OUT}} = -1\text{dBFS}$ , DSA = 0dB, Sin(x)/x enabled, DSA calibrated, 9.6GHz matching

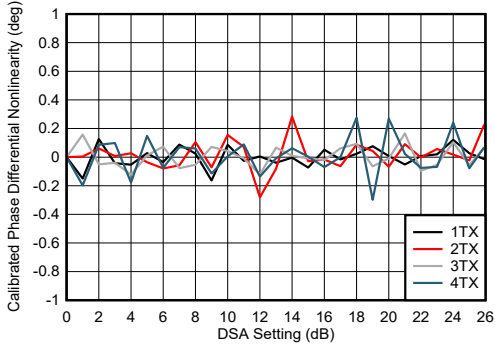


Figure 4-245. TX DSA Calibrated Phase Differential Nonlinearity

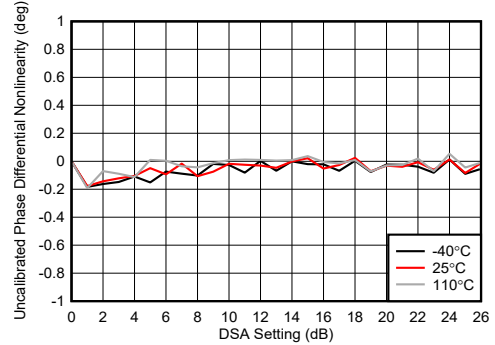


Figure 4-246. TX DSA Uncalibrated Phase Differential Nonlinearity

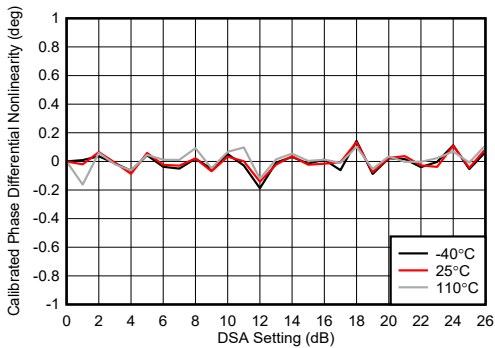


Figure 4-247. TX DSA Calibrated Phase Differential Nonlinearity

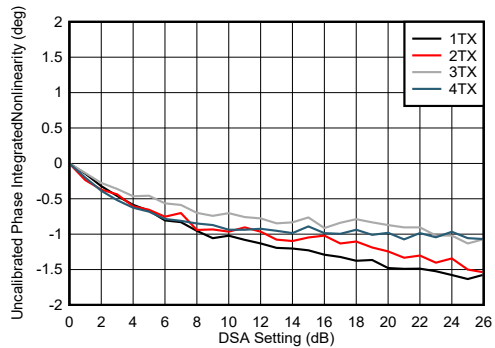


Figure 4-248. TX DSA Uncalibrated Phase Integrated Nonlinearity

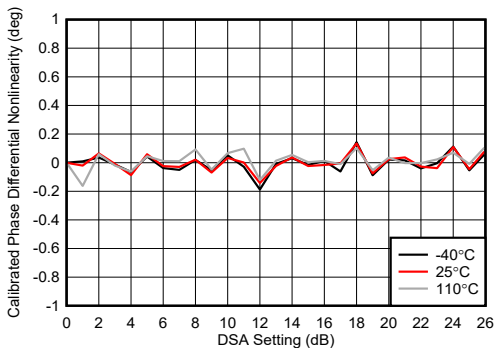


Figure 4-249. TX DSA Calibrated Phase Integrated Nonlinearity

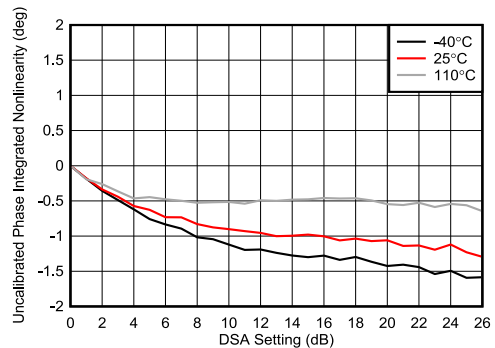
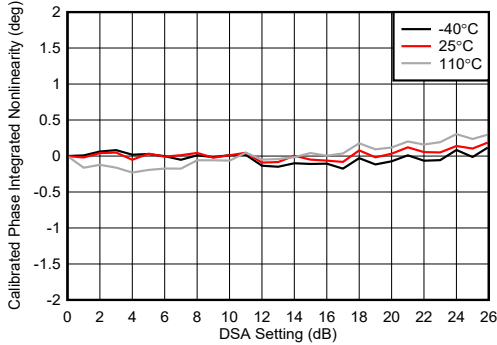


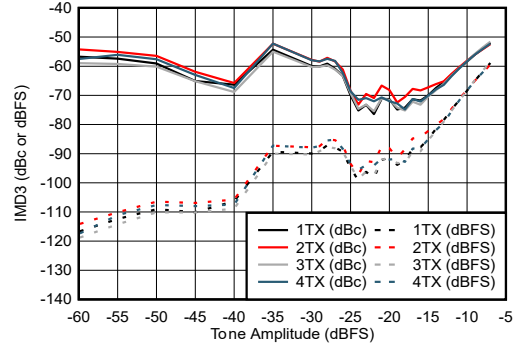
Figure 4-250. TX DSA Uncalibrated Phase Integrated Nonlinearity

**4.12.7 TX Typical Characteristics at 9.6GHz (continued)**

Typical values at  $T_A = +25^\circ\text{C}$  with nominal supplies. Default conditions: TX input data rate = 1474.56MSPS,  $f_{DAC} = 11796.48\text{MSPS}$  (8x interpolation), Mixed mode, 1<sup>st</sup> Nyquist zone output, PLL clock mode with  $f_{REF} = 491.52\text{MHz}$ ,  $A_{OUT} = -1\text{dBFS}$ , DSA = 0dB, Sin(x)/x enabled, DSA calibrated, 9.6GHz matching

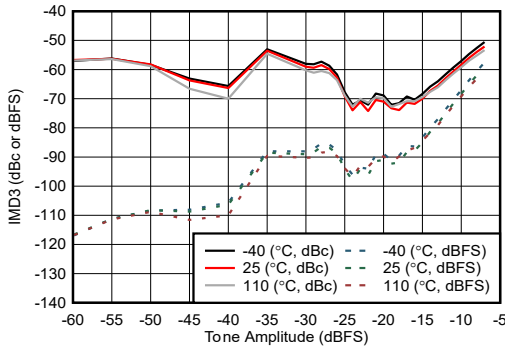


**Figure 4-251. TX DSA Calibrated Amplitude Integrated Nonlinearity**



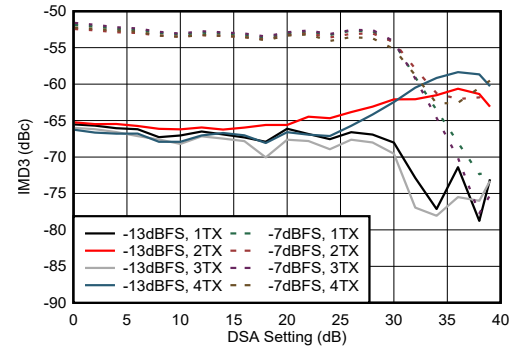
50MHz tone spacing

**Figure 4-252. TX IMD3 vs Digital Amplitude at 9.61GHz**



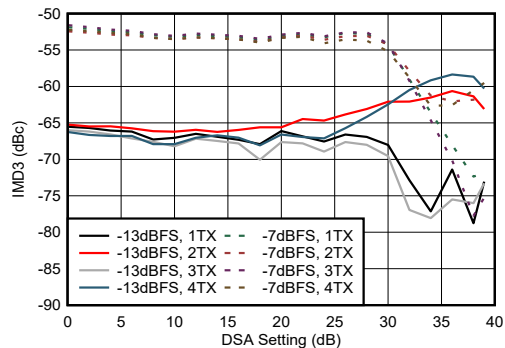
50MHz tone spacing

**Figure 4-253. TX IMD3 vs Digital Amplitude at 9.61GHz**



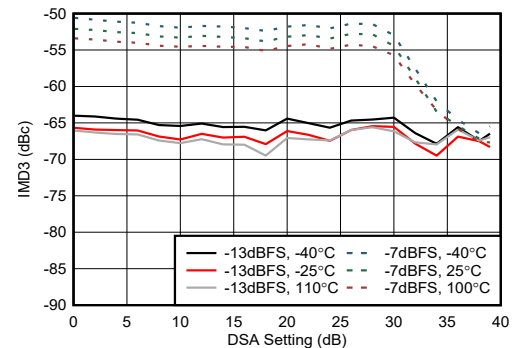
50MHz tone spacing

**Figure 4-254. TX IMD3 vs DSA Setting at 9.61GHz**



50MHz tone spacing

**Figure 4-255. TX IMD3 vs DSA Setting at 9.61GHz**



50MHz tone spacing

**Figure 4-256. TX IMD3 vs DSA Setting at 9.61GHz**

### 4.12.7 TX Typical Characteristics at 9.6GHz (continued)

Typical values at  $T_A = +25^\circ\text{C}$  with nominal supplies. Default conditions: TX input data rate = 1474.56MSPS,  $f_{\text{DAC}} = 11796.48\text{MSPS}$  (8x interpolation), Mixed mode, 1<sup>st</sup> Nyquist zone output, PLL clock mode with  $f_{\text{REF}} = 491.52\text{MHz}$ ,  $A_{\text{OUT}} = -1\text{dBFS}$ , DSA = 0dB, Sin(x)/x enabled, DSA calibrated, 9.6GHz matching

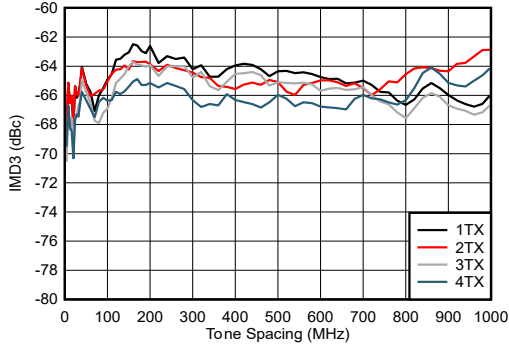


Figure 4-257. TX IMD3 vs Tone Spacing at 9.61GHz

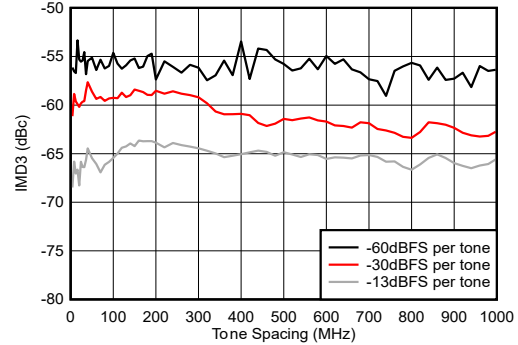


Figure 4-258. TX IMD3 vs Tone Spacing at 9.61GHz

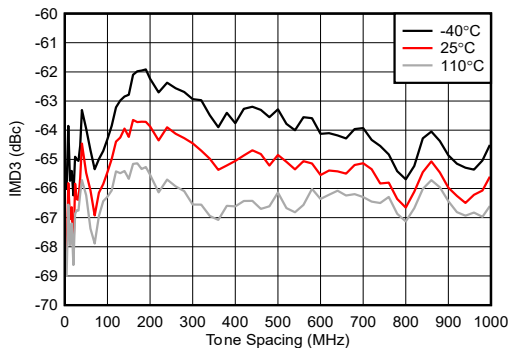


Figure 4-259. TX IMD3 vs Tone Spacing at 9.61GHz

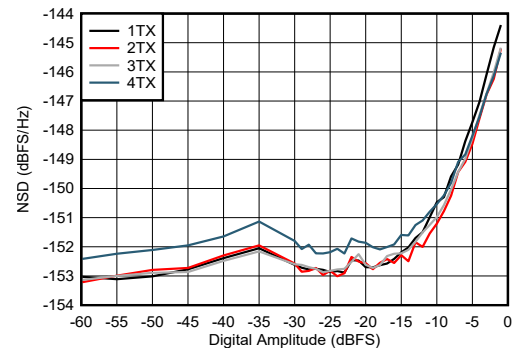


Figure 4-260. TX NSD vs Digital Amplitude at 9.61GHz

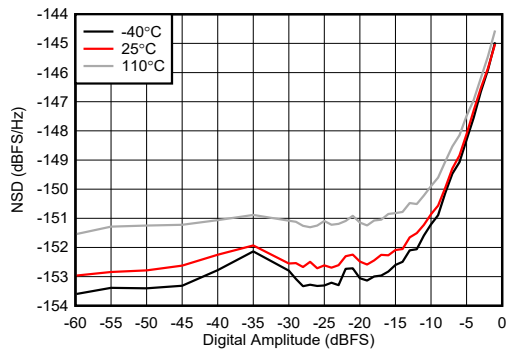


Figure 4-261. TX NSD vs Digital Amplitude at 9.61GHz

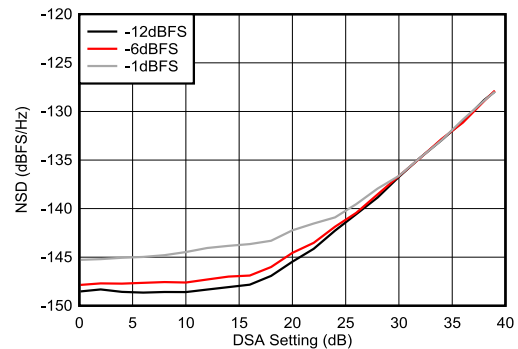


Figure 4-262. TX NSD vs DSA Setting at 9.61GHz

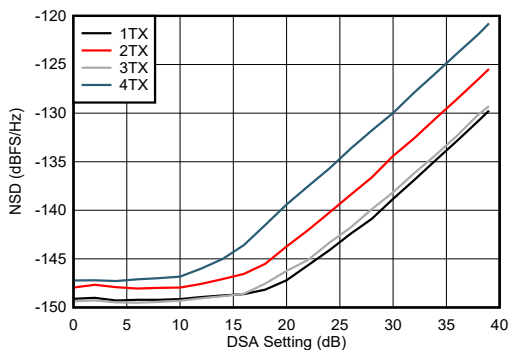


Figure 4-263. TX NSD vs DSA Setting at 9.61GHz

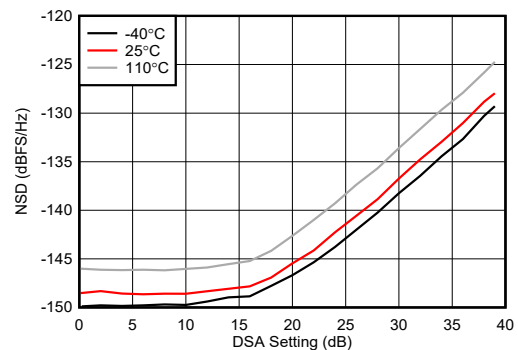
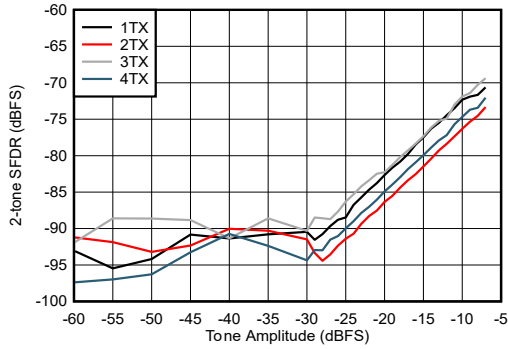


Figure 4-264. TX NSD vs DSA Setting at 9.61GHz

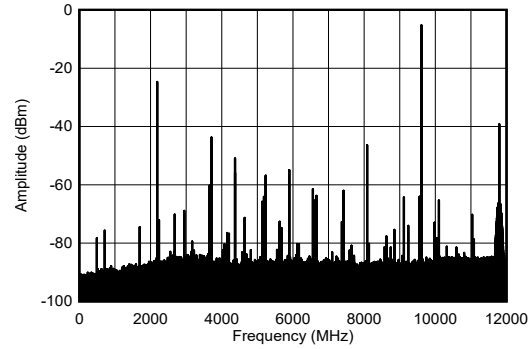
**4.12.7 TX Typical Characteristics at 9.6GHz (continued)**

Typical values at  $T_A = +25^\circ\text{C}$  with nominal supplies. Default conditions: TX input data rate = 1474.56MSPS,  $f_{\text{DAC}} = 11796.48\text{MSPS}$  (8x interpolation), Mixed mode, 1<sup>st</sup> Nyquist zone output, PLL clock mode with  $f_{\text{REF}} = 491.52\text{MHz}$ ,  $A_{\text{OUT}} = -1\text{dBFS}$ , DSA = 0dB, Sin(x)/x enabled, DSA calibrated, 9.6GHz matching



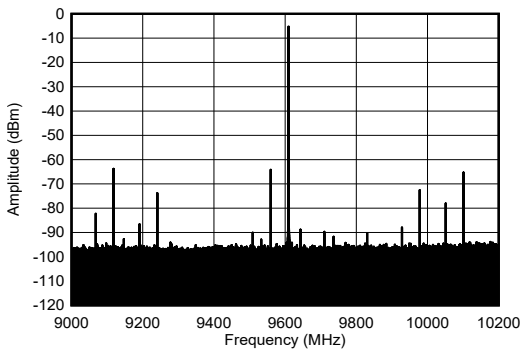
50 MHz tone spacing

**Figure 4-265. TX 2-tone SFDR vs Digital Amplitude at 9.61GHz**



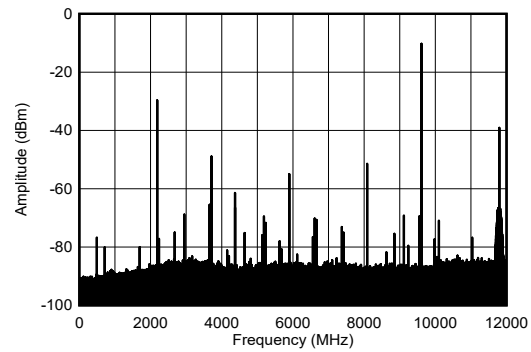
Includes PCB and cable losses.

**Figure 4-266. TX Single Tone Spectrum at 9.61GHz and -1dBFS (wideband)**



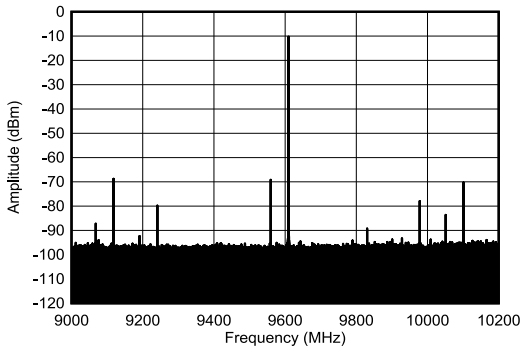
Includes PCB and cable losses.

**Figure 4-267. TX Single Tone Spectrum at 9.61GHz and -1dBFS (1.2GHz BW)**



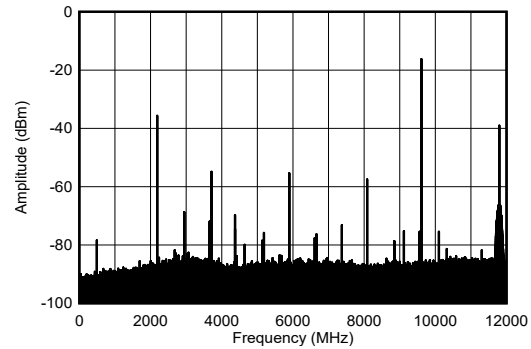
Includes PCB and cable losses.

**Figure 4-268. TX Single Tone Spectrum at 9.61GHz and -6dBFS (wideband)**



Includes PCB and cable losses.

**Figure 4-269. TX Single Tone Spectrum at 9.61GHz and -6dBFS (1.2GHz BW)**

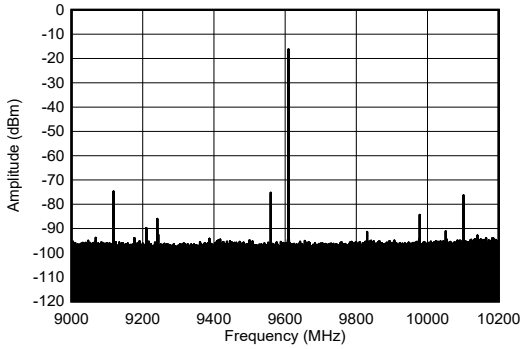


Includes PCB and cable losses.

**Figure 4-270. TX Single Tone Spectrum at 9.61GHz and -12dBFS (wideband)**

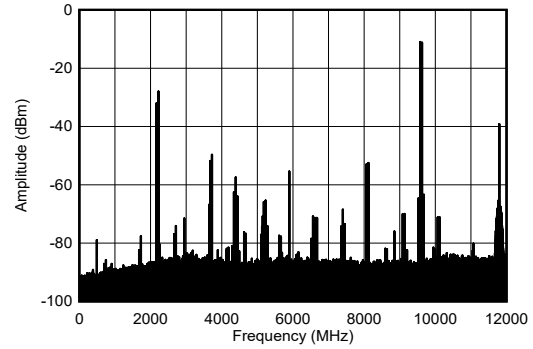
**4.12.7 TX Typical Characteristics at 9.6GHz (continued)**

Typical values at  $T_A = +25^\circ\text{C}$  with nominal supplies. Default conditions: TX input data rate = 1474.56MSPS,  $f_{\text{DAC}} = 11796.48\text{MSPS}$  (8x interpolation), Mixed mode, 1<sup>st</sup> Nyquist zone output, PLL clock mode with  $f_{\text{REF}} = 491.52\text{MHz}$ ,  $A_{\text{OUT}} = -1\text{dBFS}$ , DSA = 0dB, Sin(x)/x enabled, DSA calibrated, 9.6GHz matching



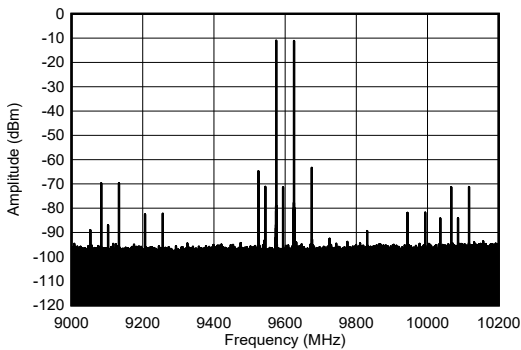
Includes PCB and cable losses.

**Figure 4-271. TX Single Tone Spectrum at 9.61GHz and -12dBFS (1.2GHz BW)**



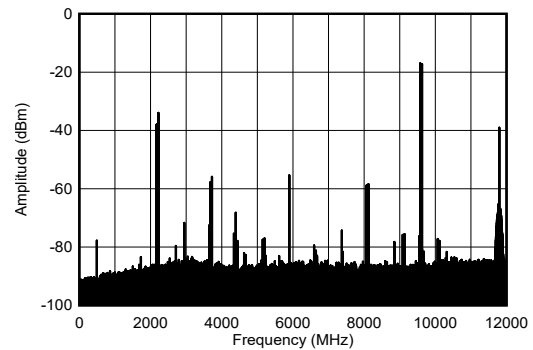
Includes PCB and cable losses, 50MHz tone spacing.

**Figure 4-272. TX 2-Tone Spectrum at 9.61GHz and -7dBFS (wideband)**



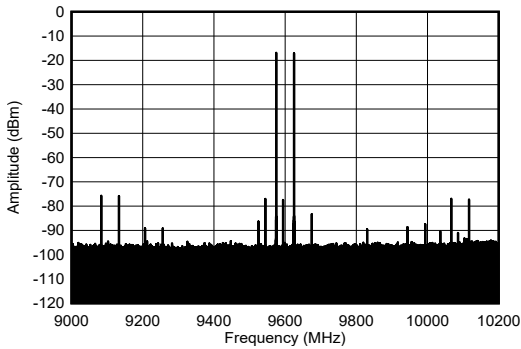
Includes PCB and cable losses, 50MHz tone spacing.

**Figure 4-273. TX 2-Tone Spectrum at 9.61GHz and -7dBFS (1.2GHz BW)**



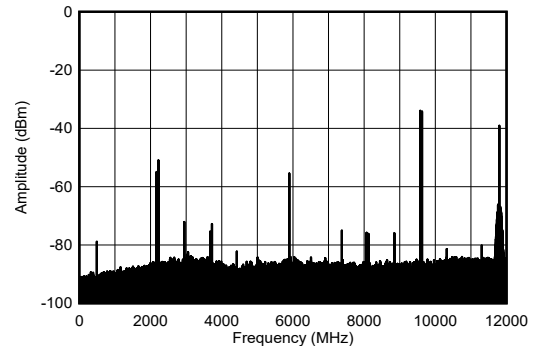
Includes PCB and cable losses, 50MHz tone spacing.

**Figure 4-274. TX 2-Tone Spectrum at 9.61GHz and -13dBFS (wideband)**



Includes PCB and cable losses, 50MHz tone spacing.

**Figure 4-275. TX 2-Tone Spectrum at 9.61GHz and -13dBFS (1.2GHz BW)**

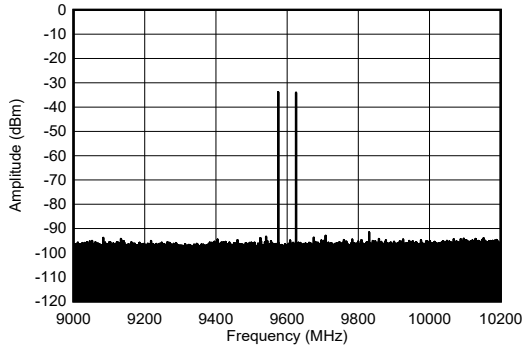


Includes PCB and cable losses, 50MHz tone spacing.

**Figure 4-276. TX 2-Tone Spectrum at 9.61GHz and -30dBFS Each (wideband)**

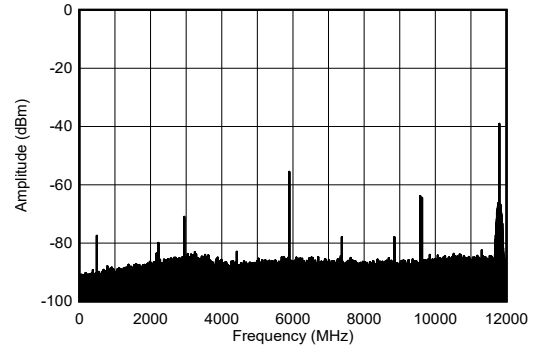
### 4.12.7 TX Typical Characteristics at 9.6GHz (continued)

Typical values at  $T_A = +25^\circ\text{C}$  with nominal supplies. Default conditions: TX input data rate = 1474.56MSPS,  $f_{\text{DAC}} = 11796.48\text{MSPS}$  (8x interpolation), Mixed mode, 1<sup>st</sup> Nyquist zone output, PLL clock mode with  $f_{\text{REF}} = 491.52\text{MHz}$ ,  $A_{\text{OUT}} = -1\text{dBFS}$ , DSA = 0dB, Sin(x)/x enabled, DSA calibrated, 9.6GHz matching



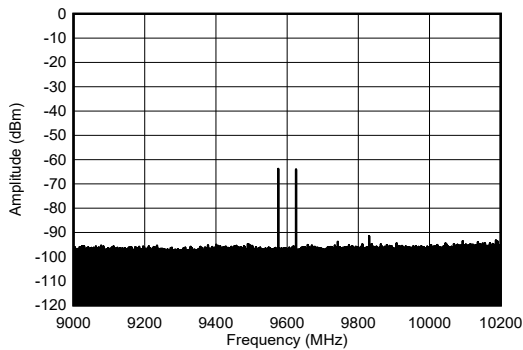
Includes PCB and cable losses, 50MHz tone spacing.

**Figure 4-277. TX 2-Tone Spectrum at 9.61GHz and -30dBFS Each (1.2GHz BW)**



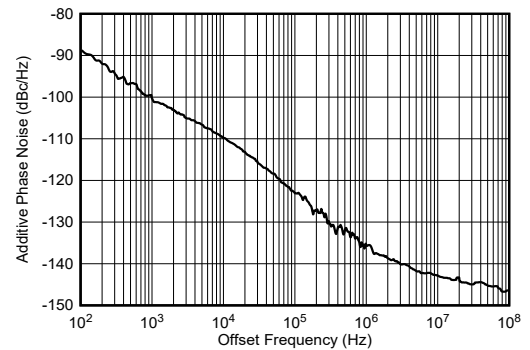
Includes PCB and cable losses, 50MHz tone spacing.

**Figure 4-278. TX 2-Tone Spectrum at 9.61GHz and -60dBFS Each (wideband)**



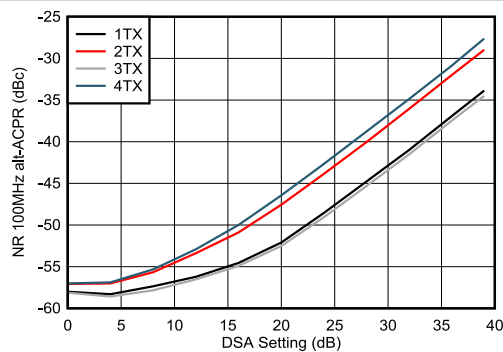
Includes PCB and cable losses, 50MHz tone spacing.

**Figure 4-279. TX 2-Tone Spectrum at 9.61GHz and -60dBFS Each (1.2GHz BW)**

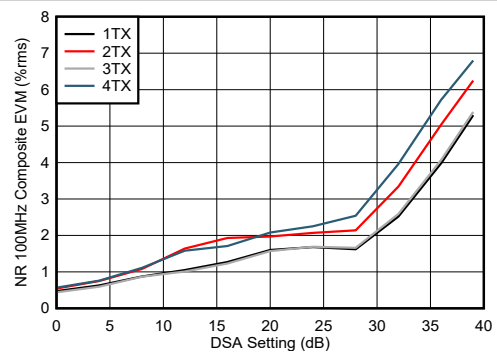


Single sideband, external clock mode, input clock phase noise removed

**Figure 4-280. TX Additive Phase Noise vs Offset Frequency at 9.61GHz**



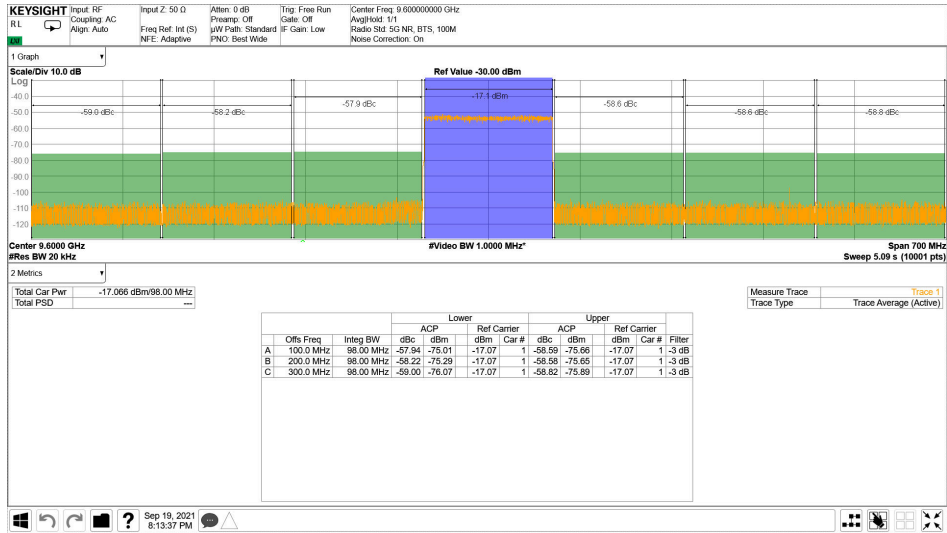
**Figure 4-281. TX NR100MHz alt-ACPR vs DSA Setting at 9.61GHz**



**Figure 4-282. TX NR100MHz EVM vs DSA Setting at 9.61GHz**

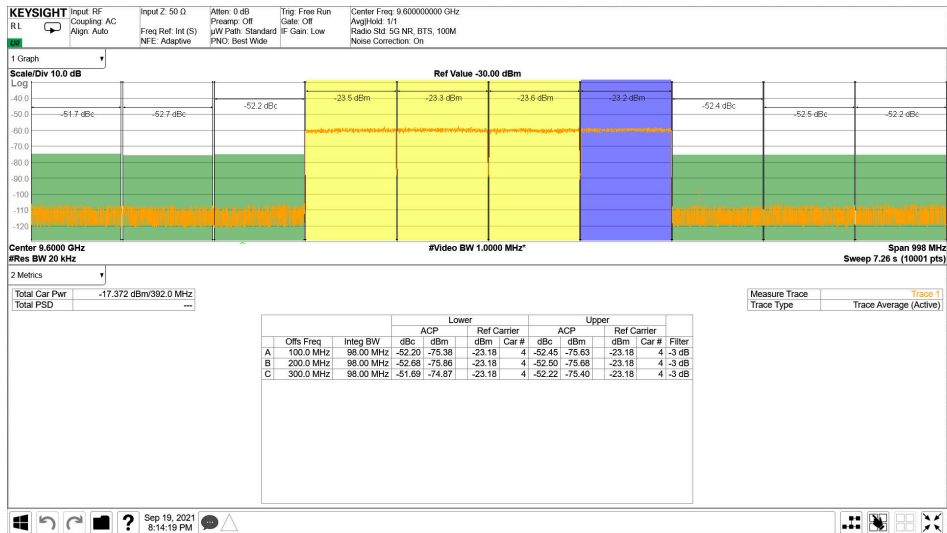
**4.12.7 TX Typical Characteristics at 9.6GHz (continued)**

Typical values at  $T_A = +25^\circ\text{C}$  with nominal supplies. Default conditions: TX input data rate = 1474.56MSPS,  $f_{DAC} = 11796.48\text{MSPS}$  (8x interpolation), Mixed mode, 1<sup>st</sup> Nyquist zone output, PLL clock mode with  $f_{REF} = 491.52\text{MHz}$ ,  $A_{OUT} = -1\text{dBFS}$ , DSA = 0dB, Sin(x)/x enabled, DSA calibrated, 9.6GHz matching



Includes PCB and cable losses.

**Figure 4-283. TX NR100MHz Output Spectrum at 9.61GHz**

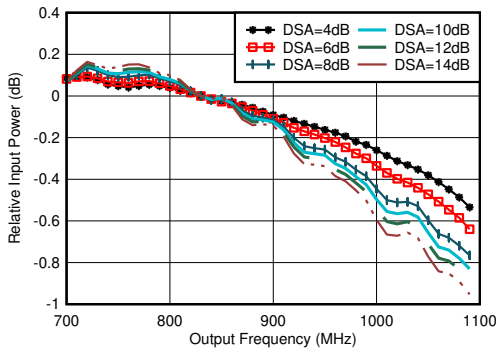


Includes PCB and cable losses.

**Figure 4-284. TX 4xNR100MHz Output Spectrum at 9.61GHz**

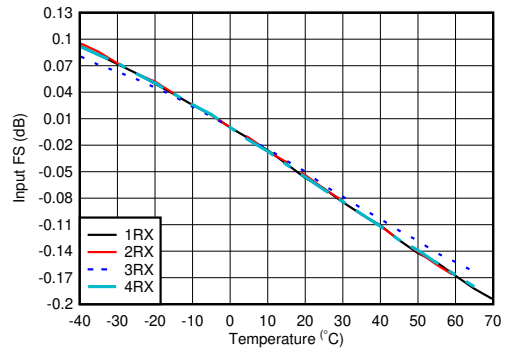
### 4.12.8 RX Typical Characteristics at 800MHz

Typical values at  $T_A = +25^\circ\text{C}$ , ADC Sampling Rate = 2949.12GHz. Default conditions: output sample rate = 491.52MSPS (decimate by 6), PLL clock mode with  $f_{REF} = 491.52\text{MHz}$ ,  $A_{IN} = -3\text{dBFS}$ , DSA setting = 4dB.



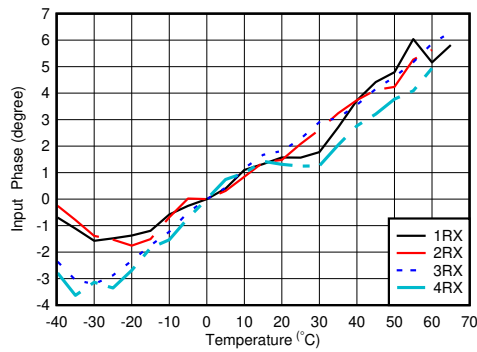
With 0.8GHz matching, normalized to 830MHz

**Figure 4-285. RX In-Band Gain Flatness for Channel 1RX,  $f_{IN} = 830\text{MHz}$**



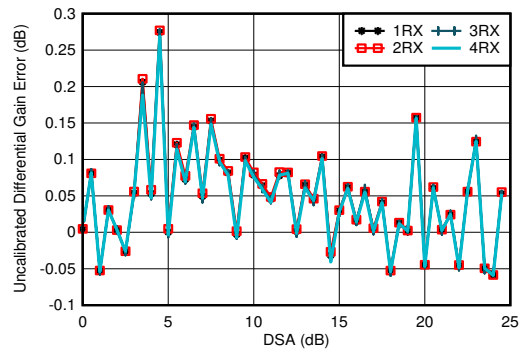
With 0.8GHz matching, normalized to fullscale at 25°C for each channel

**Figure 4-286. RX Input Fullscale vs Temperature and Channel at 800MHz**



With 0.8GHz matching, normalized to phase at 25°C

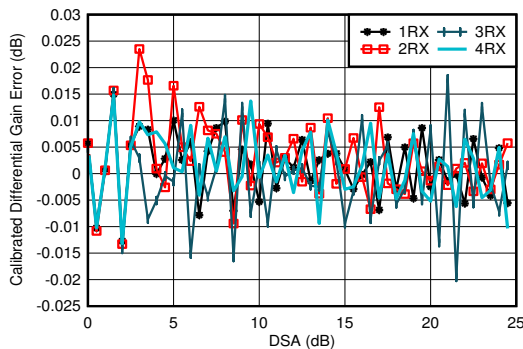
**Figure 4-287. RX Input Phase vs Temperature and DSA at  $f_{OUT} = 0.8\text{GHz}$**



With 0.8GHz matching

Differential Amplitude Error =  $P_{IN}(\text{DSA Setting} - 1) - P_{IN}(\text{DSA Setting}) + 1$

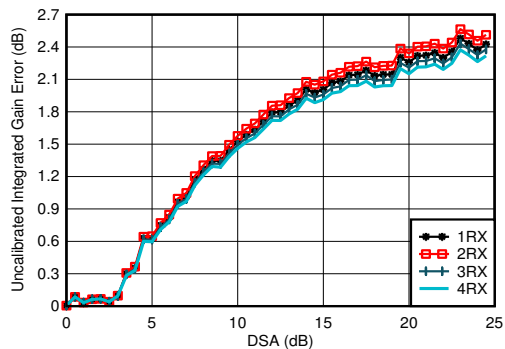
**Figure 4-288. RX Uncalibrated Differential Amplitude Error vs DSA Setting at 0.8GHz**



With 0.8GHz matching

Differential Amplitude Error =  $P_{IN}(\text{DSA Setting} - 1) - P_{IN}(\text{DSA Setting}) + 1$

**Figure 4-289. RX Calibrated Differential Amplitude Error vs DSA Setting at 0.8GHz**



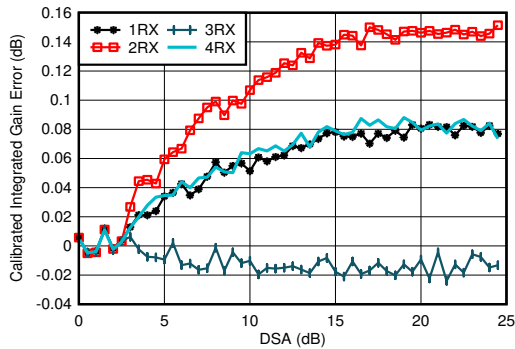
With 0.8GHz matching

Integrated Amplitude Error =  $P_{IN}(\text{DSA Setting}) - P_{IN}(\text{DSA Setting} = 0) + (\text{DSA Setting})$

**Figure 4-290. RX Uncalibrated Integrated Amplitude Error vs DSA Setting at 0.8GHz**

### 4.12.8 RX Typical Characteristics at 800MHz (continued)

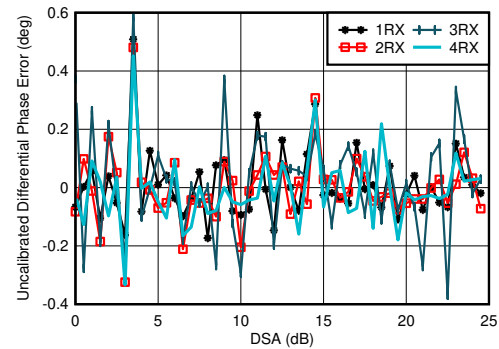
Typical values at  $T_A = +25^\circ\text{C}$ , ADC Sampling Rate = 2949.12GHz. Default conditions: output sample rate = 491.52MSPS (decimate by 6), PLL clock mode with  $f_{REF} = 491.52\text{MHz}$ ,  $A_{IN} = -3\text{dBFS}$ , DSA setting = 4dB.



With 0.8GHz matching

Integrated Amplitude Error =  $P_{IN}(\text{DSA Setting}) - P_{IN}(\text{DSA Setting} = 0) + (\text{DSA Setting})$

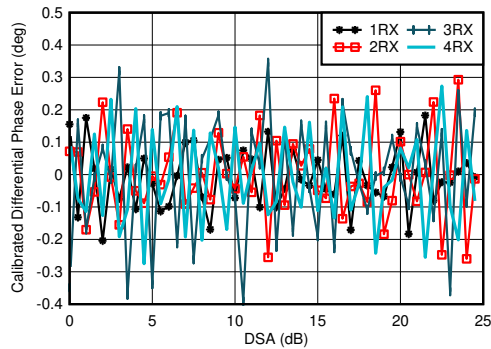
**Figure 4-291. RX Calibrated Integrated Amplitude Error vs DSA Setting at 2.6GHz**



With 0.8GHz matching

Differential Phase Error =  $\text{Phase}_{IN}(\text{DSA Setting} - 1) - \text{Phase}_{IN}(\text{DSA Setting})$

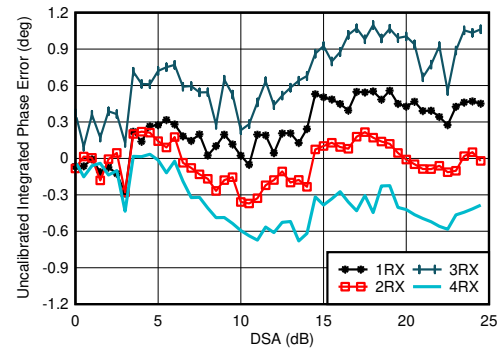
**Figure 4-292. RX Uncalibrated Differential Phase Error vs DSA Setting at 0.8GHz**



With 0.8GHz matching

Differential Phase Error =  $\text{Phase}_{IN}(\text{DSA Setting} - 1) - \text{Phase}_{IN}(\text{DSA Setting})$

**Figure 4-293. RX Calibrated Differential Phase Error vs DSA Setting at 0.8GHz**



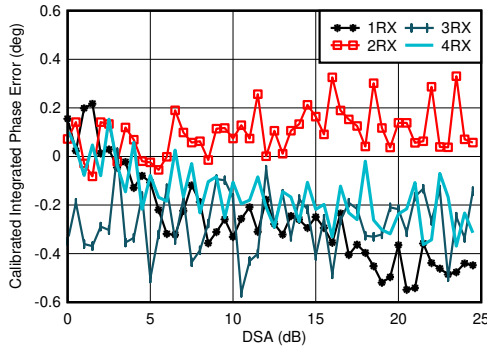
With 0.8GHz matching

Integrated Phase Error =  $\text{Phase}(\text{DSA Setting}) - \text{Phase}(\text{DSA Setting} = 0)$

**Figure 4-294. RX Uncalibrated Integrated Phase Error vs DSA Setting at 0.8GHz**

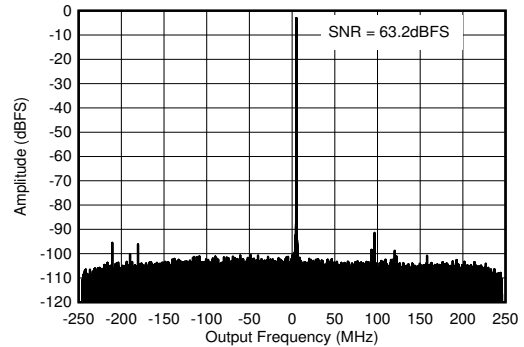
**4.12.8 RX Typical Characteristics at 800MHz (continued)**

Typical values at  $T_A = +25^\circ\text{C}$ , ADC Sampling Rate = 2949.12GHz. Default conditions: output sample rate = 491.52MSPS (decimate by 6), PLL clock mode with  $f_{REF} = 491.52\text{MHz}$ ,  $A_{IN} = -3\text{dBFS}$ , DSA setting = 4dB.



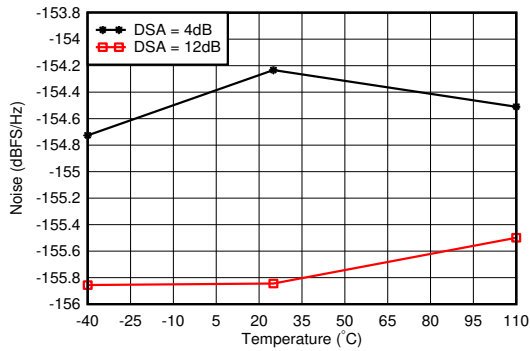
With 0.8GHz matching  
Integrated Phase Error = Phase(DSA Setting) – Phase(DSA Setting = 0)

**Figure 4-295. RX Calibrated Integrated Phase Error vs DSA Setting at 0.8GHz**



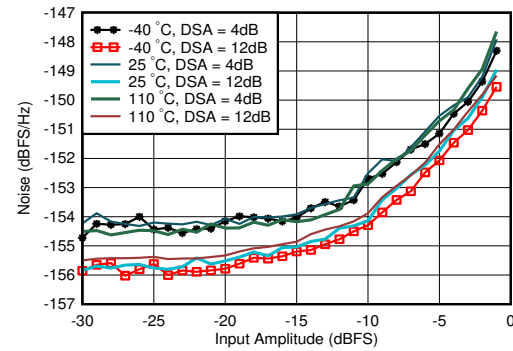
With 0.8GHz matching,  $f_{IN} = 840\text{MHz}$ ,  $A_{IN} = -3\text{dBFS}$

**Figure 4-296. RX Output FFT at 0.8GHz**



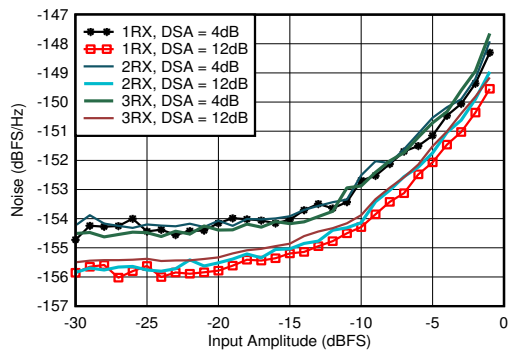
With 0.8GHz matching, 12.5MHz offset from tone

**Figure 4-297. RX Noise Spectral Density vs Temperature at 0.8GHz**



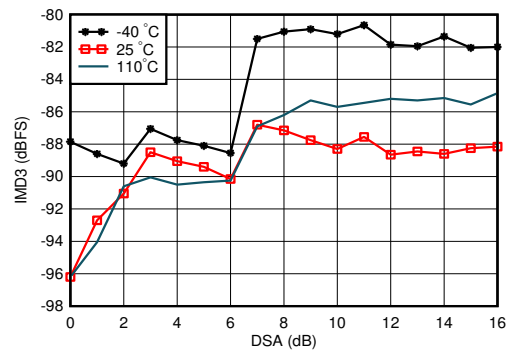
With 0.8GHz matching, DSA Setting = 12dB, 12.5MHz offset from tone

**Figure 4-298. RX Noise Spectral Density vs Input Amplitude and Temperature at 0.8GHz**



With 0.8GHz matching, 12.5MHz offset from tone

**Figure 4-299. RX Noise Spectral Density vs Input Amplitude and Channel at 0.8GHz**

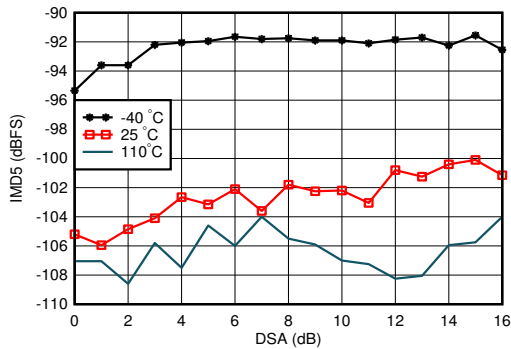


A. With 0.8GHz matching, each tone  $-7\text{dBFS}$ , tone spacing = 20MHz

**Figure 4-300. RX IMD3 vs DSA Setting and Temperature at 0.8GHz**

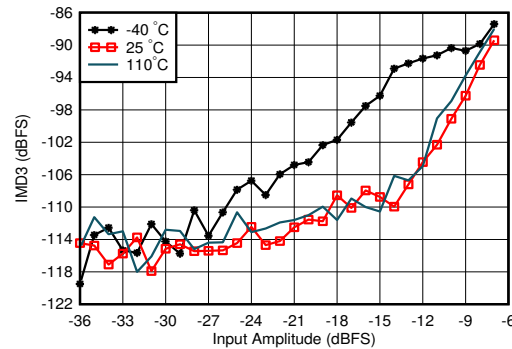
### 4.12.8 RX Typical Characteristics at 800MHz (continued)

Typical values at  $T_A = +25^\circ\text{C}$ , ADC Sampling Rate = 2949.12GHz. Default conditions: output sample rate = 491.52MSPS (decimate by 6), PLL clock mode with  $f_{REF} = 491.52\text{MHz}$ ,  $A_{IN} = -3\text{dBFS}$ , DSA setting = 4dB.



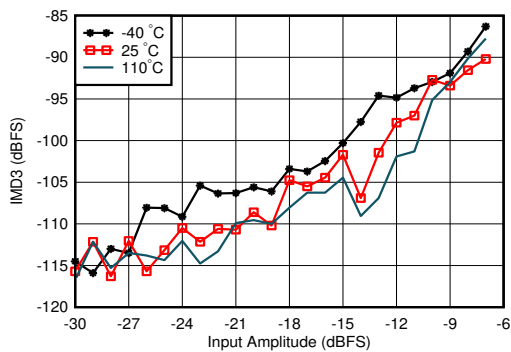
With 0.8GHz matching, each tone  $-7\text{dBFS}$ , tone spacing = 20MHz

Figure 4-301. RX IMD5 vs DSA Setting and Temperature at 0.8GHz



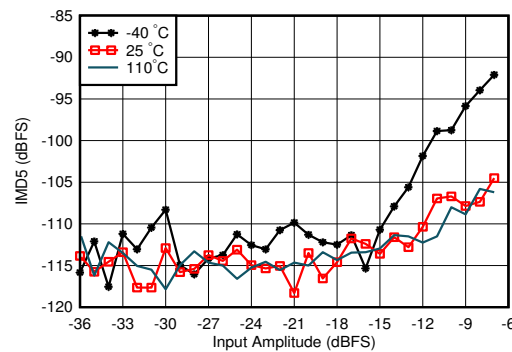
With 0.8GHz matching, tone spacing = 20MHz, DSA = 4dB

Figure 4-302. RX IMD3 vs Input Level and Temperature at 0.8GHz



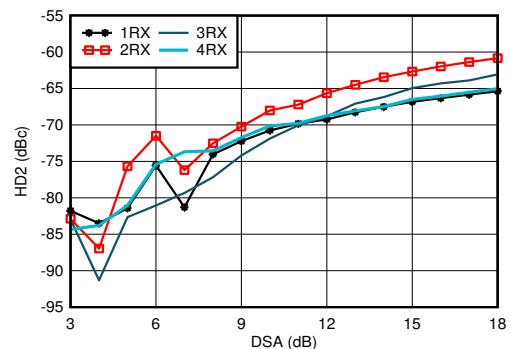
With 0.8GHz matching, tone spacing = 20MHz, DSA = 12dB

Figure 4-303. RX IMD3 vs Input Level and Temperature at 0.8GHz



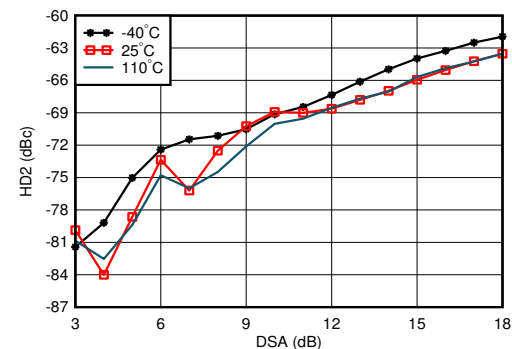
With 0.8GHz matching, tone spacing = 20MHz, DSA = 12dB

Figure 4-304. RX IMD5 vs Input Level and Temperature at 0.8GHz



With 0.8GHz matching, measured after HD2 trim, DDC bypass mode (TI only mode for characterization)

Figure 4-305. RX HD2 vs DSA Setting and Channel at 0.8GHz

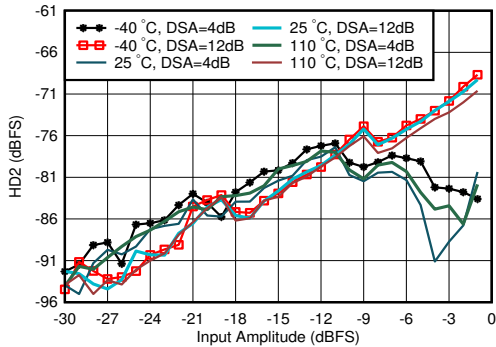


With 0.8GHz matching, measured after HD2 trim, DDC bypass mode (TI only mode for characterization)

Figure 4-306. RX HD2 vs DSA Setting and Temperature at 0.8GHz

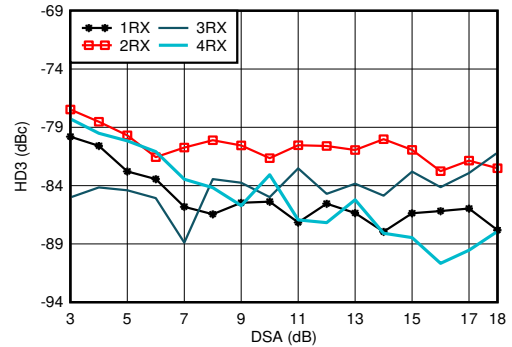
**4.12.8 RX Typical Characteristics at 800MHz (continued)**

Typical values at  $T_A = +25^\circ\text{C}$ , ADC Sampling Rate = 2949.12GHz. Default conditions: output sample rate = 491.52MSPS (decimate by 6), PLL clock mode with  $f_{REF} = 491.52\text{MHz}$ ,  $A_{IN} = -3\text{dBFS}$ , DSA setting = 4dB.



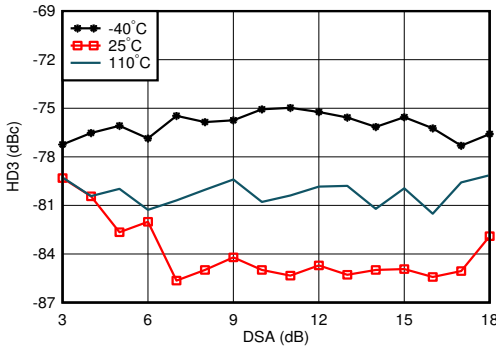
With 0.8GHz matching, measured after HD2 trim, DDC bypass mode (TI only mode for characterization)

**Figure 4-307. RX HD2 vs Input Level and Temperature at 0.8GHz**



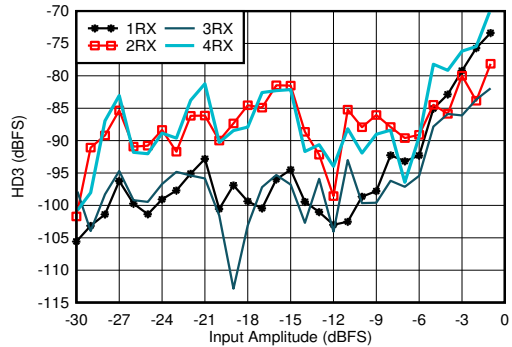
With 0.8GHz matching, DDC bypass mode (TI only mode for characterization)

**Figure 4-308. RX HD3 vs DSA Setting and Channel at 0.8GHz**



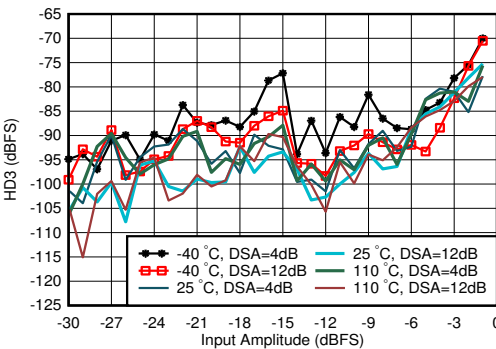
With 0.8GHz matching, DDC bypass mode (TI only mode for characterization)

**Figure 4-309. RX HD3 vs DSA Setting and Temperature at 0.8GHz**



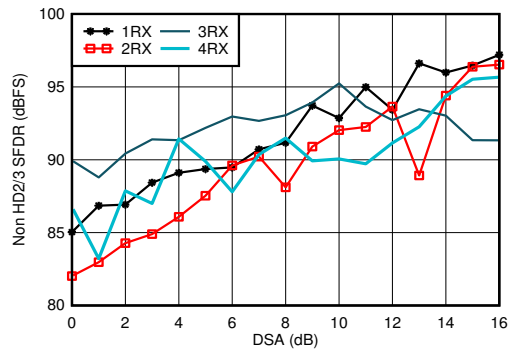
With 0.8GHz matching, DDC bypass mode (TI only mode for characterization)

**Figure 4-310. RX HD3 vs Input Level and Channel at 0.8GHz**



With 0.8GHz matching, DDC bypass mode (TI only mode for characterization)

**Figure 4-311. RX HD3 vs Input Level and Temperature at 0.8GHz**

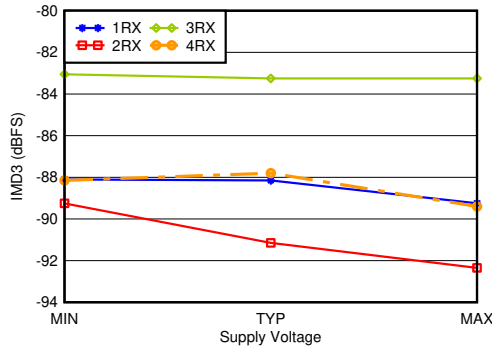


With 0.8GHz matching

**Figure 4-312. RX Non-HD2/3 vs DSA Setting at 0.8GHz**

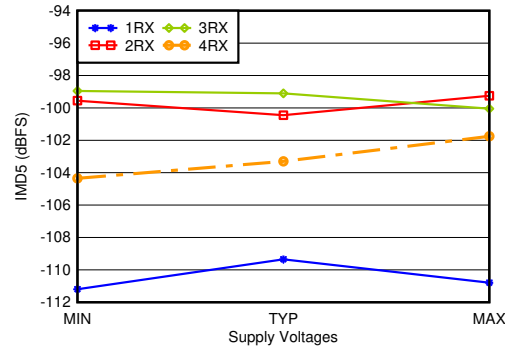
### 4.12.8 RX Typical Characteristics at 800MHz (continued)

Typical values at  $T_A = +25^\circ\text{C}$ , ADC Sampling Rate = 2949.12GHz. Default conditions: output sample rate = 491.52MSPS (decimate by 6), PLL clock mode with  $f_{REF} = 491.52\text{MHz}$ ,  $A_{IN} = -3\text{dBFS}$ , DSA setting = 4dB.



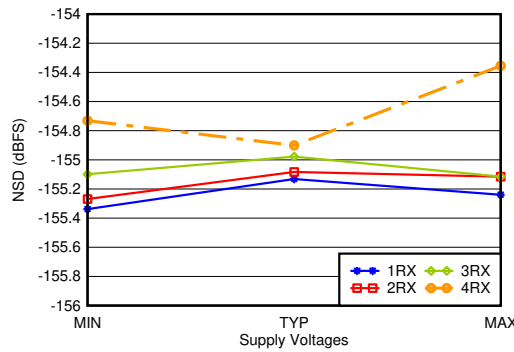
With 0.8GHz matching,  $-7\text{dBFS}$  each tone, 20MHz tone spacing, all supplies at MIN, TYP, or MAX recommended operating voltages

Figure 4-313. RX IMD3 vs Supply and Channel at 0.8GHz



With 0.8GHz matching,  $-7\text{dBFS}$  each tone, 20MHz tone spacing, all supplies at MIN, TYP, or MAX recommended operating voltages

Figure 4-314. RX IMD5 vs Supply and Channel at 0.8GHz

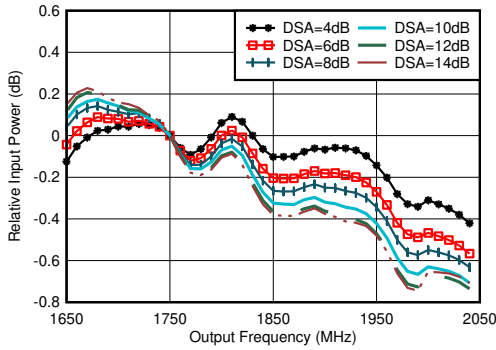


With 0.8GHz matching, 12.5MHz offset, all supplies at MIN, TYP, or MAX recommended operating voltages

Figure 4-315. RX Noise Spectral Density vs Supply and Channel at 0.8GHz

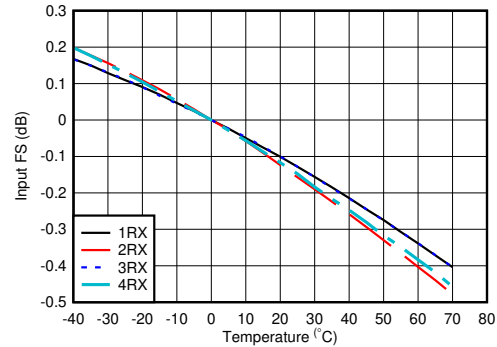
### 4.12.9 RX Typical Characteristics at 1.75-1.9GHz

Typical values at  $T_A = +25^\circ\text{C}$ , ADC Sampling Rate = 2949.12MHz. Default conditions: output sample rate = 491.52MSPS (decimate by 6), PLL clock mode with  $f_{REF} = 491.52\text{MHz}$ ,  $A_{IN} = -3\text{dBFS}$ , DSA setting = 4dB.



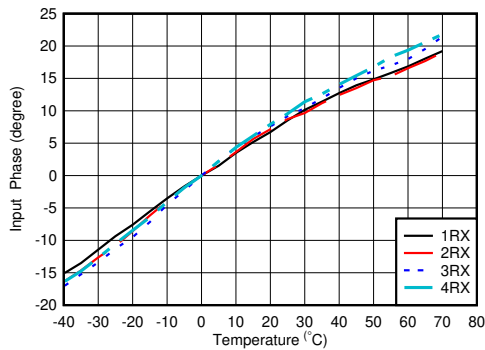
With 1.8GHz matching, normalized to 1.75GHz

**Figure 4-316. RX In-Band Gain Flatness,  $f_{IN} = 1750\text{MHz}$**



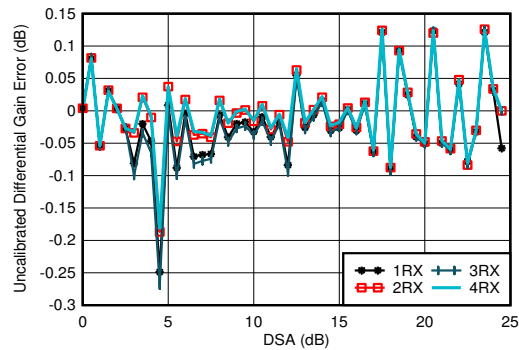
With 1.8GHz matching, normalized to fullscale at  $25^\circ\text{C}$  for each channel

**Figure 4-317. RX Input Fullscale vs Temperature and Channel at 1.75GHz**



With 2.6GHz matching, normalized to phase at  $25^\circ\text{C}$

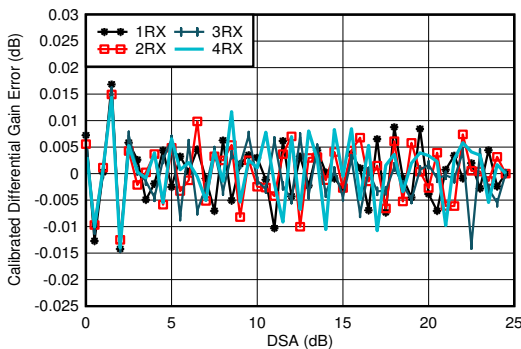
**Figure 4-318. RX Input Phase vs Temperature and DSA at  $f_{IN} = 1.75\text{GHz}$**



With 1.8GHz matching

Differential Amplitude Error =  $P_{IN}(\text{DSA Setting} - 1) - P_{IN}(\text{DSA Setting}) + 1$

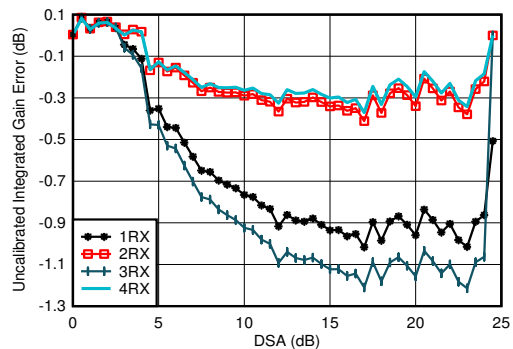
**Figure 4-319. RX Uncalibrated Differential Amplitude Error vs DSA Setting at 1.75GHz**



With 1.8GHz matching

Differential Amplitude Error =  $P_{IN}(\text{DSA Setting} - 1) - P_{IN}(\text{DSA Setting}) + 1$

**Figure 4-320. RX Calibrated Differential Amplitude Error vs DSA Setting at 1.75GHz**



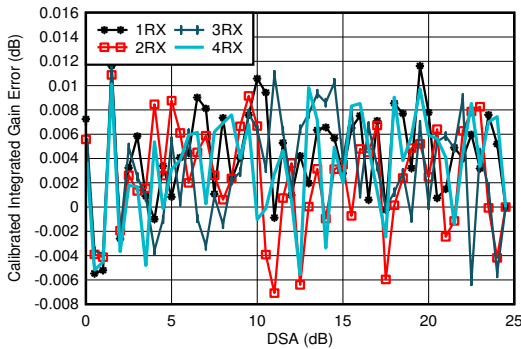
With 1.8GHz matching

Integrated Amplitude Error =  $P_{IN}(\text{DSA Setting}) - P_{IN}(\text{DSA Setting} = 0) + (\text{DSA Setting})$

**Figure 4-321. RX Uncalibrated Integrated Amplitude Error vs DSA Setting at 1.75GHz**

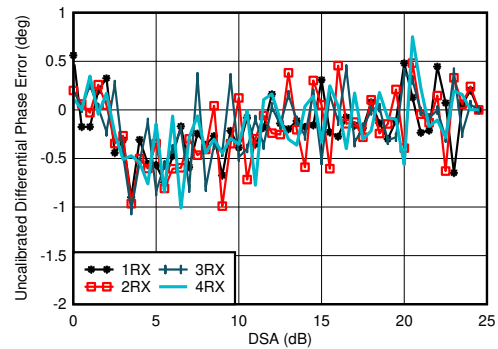
### 4.12.9 RX Typical Characteristics at 1.75-1.9GHz (continued)

Typical values at  $T_A = +25^\circ\text{C}$ , ADC Sampling Rate = 2949.12MHz. Default conditions: output sample rate = 491.52MSPS (decimate by 6), PLL clock mode with  $f_{REF} = 491.52\text{MHz}$ ,  $A_{IN} = -3\text{dBFS}$ , DSA setting = 4dB.



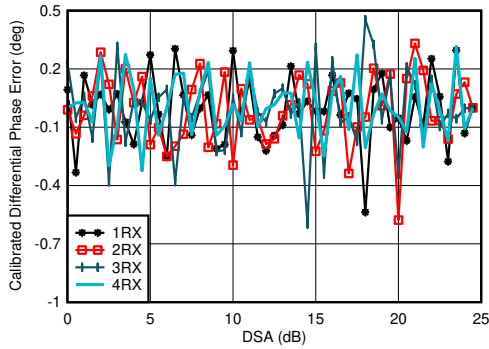
With 1.8GHz matching  
 Integrated Amplitude Error =  $P_{IN}(\text{DSA Setting}) - P_{IN}(\text{DSA Setting} = 0) + (\text{DSA Setting})$

Figure 4-322. RX Calibrated Integrated Amplitude Error vs DSA Setting at 1.75GHz



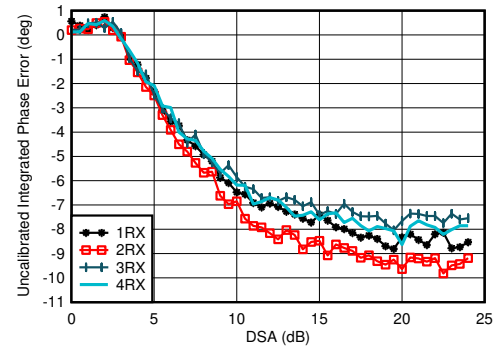
With 1.8GHz matching  
 Differential Phase Error =  $\text{Phase}_{IN}(\text{DSA Setting} - 1) - \text{Phase}_{IN}(\text{DSA Setting})$

Figure 4-323. RX Uncalibrated Differential Phase Error vs DSA Setting at 1.75GHz



With 1.8GHz matching  
 Differential Phase Error =  $\text{Phase}_{IN}(\text{DSA Setting} - 1) - \text{Phase}_{IN}(\text{DSA Setting})$

Figure 4-324. RX Calibrated Differential Phase Error vs DSA Setting at 1.75GHz

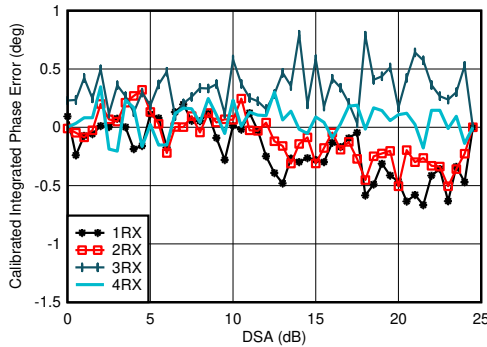


With 1.8GHz matching  
 Integrated Phase Error =  $\text{Phase}(\text{DSA Setting}) - \text{Phase}(\text{DSA Setting} = 0)$

Figure 4-325. RX Uncalibrated Integrated Phase Error vs DSA Setting at 1.75GHz

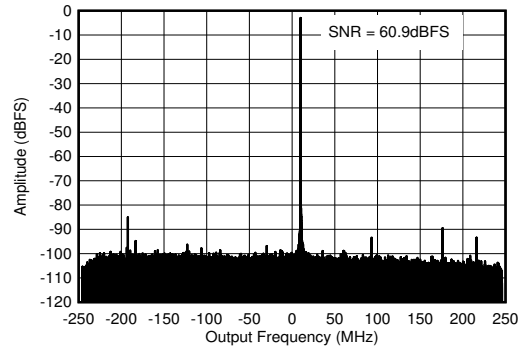
### 4.12.9 RX Typical Characteristics at 1.75-1.9GHz (continued)

Typical values at  $T_A = +25^\circ\text{C}$ , ADC Sampling Rate = 2949.12MHz. Default conditions: output sample rate = 491.52MSPS (decimate by 6), PLL clock mode with  $f_{REF} = 491.52\text{MHz}$ ,  $A_{IN} = -3\text{dBFS}$ , DSA setting = 4dB.



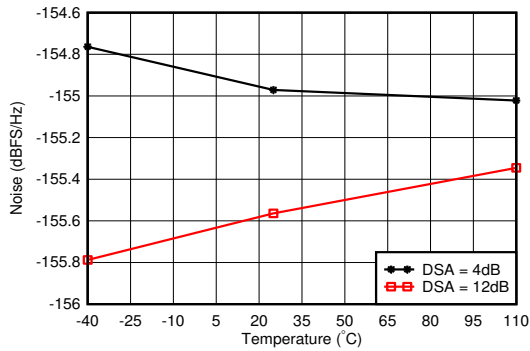
With 1.8GHz matching  
Integrated Phase Error = Phase(DSA Setting) – Phase(DSA Setting = 0)

**Figure 4-326. RX Calibrated Integrated Phase Error vs DSA Setting at 1.75GHz**



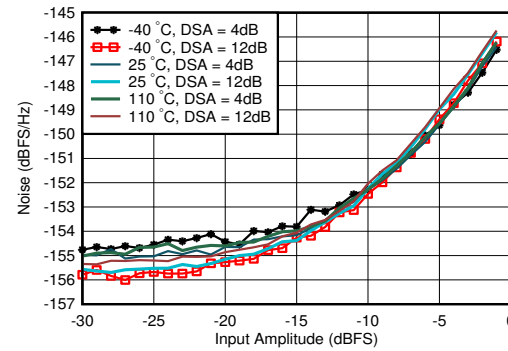
With 1.8GHz matching,  $f_{IN} = 2610\text{MHz}$ ,  $A_{IN} = -3\text{dBFS}$

**Figure 4-327. RX Output FFT at 1.75GHz**



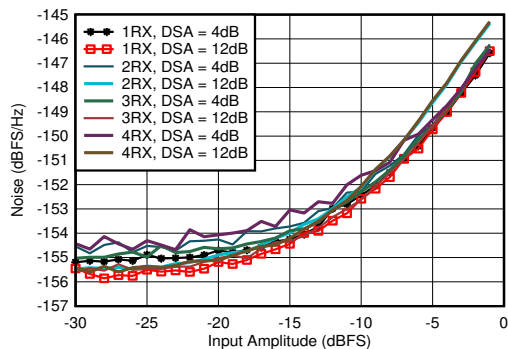
With 1.8GHz matching, 12.5MHz offset from tone

**Figure 4-328. RX Noise Spectral Density vs Temperature at 1.75GHz**



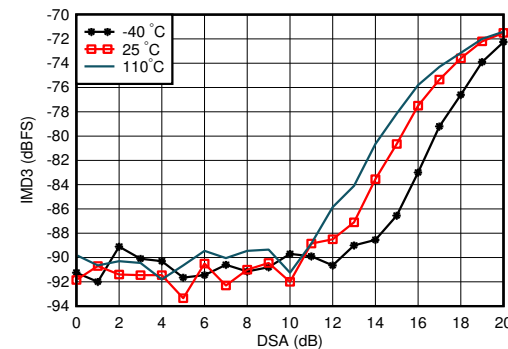
With 1.8GHz matching, DSA Setting = 12dB, 12.5MHz offset from tone

**Figure 4-329. RX Noise Spectral Density vs Input Amplitude and Temperature at 1.75GHz**



With 1.8GHz matching, 12.5MHz offset from tone

**Figure 4-330. RX Noise Spectral Density vs Input Amplitude and Channel at 1.75GHz**

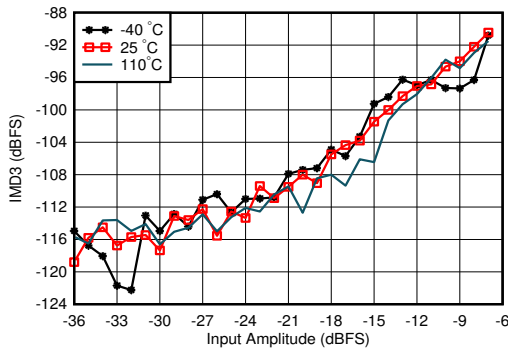


With 1.8GHz matching, each tone  $-7\text{dBFS}$ , tone spacing = 20MHz

**Figure 4-331. RX IMD3 vs DSA Setting and Temperature at 1.75GHz**

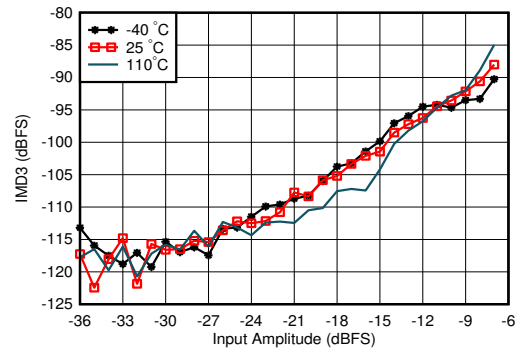
**4.12.9 RX Typical Characteristics at 1.75-1.9GHz (continued)**

Typical values at  $T_A = +25^\circ\text{C}$ , ADC Sampling Rate = 2949.12GHz. Default conditions: output sample rate = 491.52MSPS (decimate by 6), PLL clock mode with  $f_{REF} = 491.52\text{MHz}$ ,  $A_{IN} = -3\text{dBFS}$ , DSA setting = 4dB.



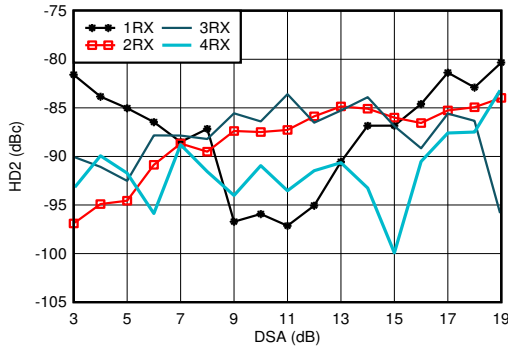
With 1.8GHz matching, tone spacing = 20MHz, DSA = 4dB

**Figure 4-332. RX IMD3 vs Input Level and Temperature at 1.75GHz**



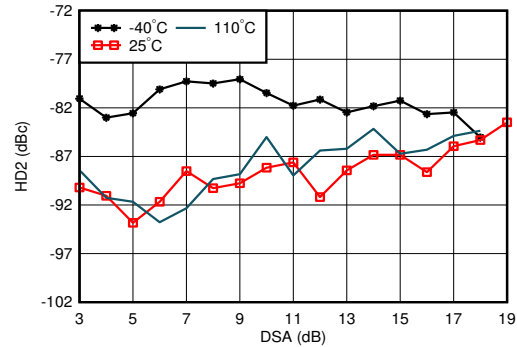
With 1.8GHz matching, tone spacing = 20MHz, DSA = 12dB

**Figure 4-333. RX IMD3 vs Input Level and Temperature at 1.75GHz**



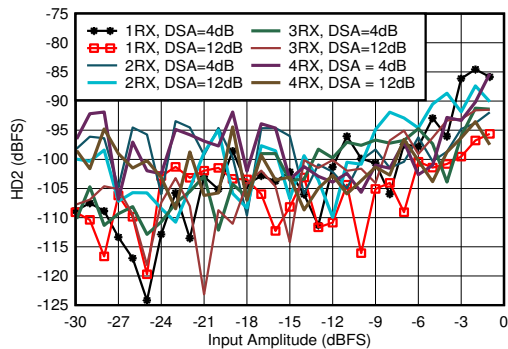
With 1.8GHz matching,  $f_{in} = 1900\text{MHz}$ , measured after HD2 trim, DDC bypass mode (TI only mode for characterization)

**Figure 4-334. RX HD2 vs DSA Setting and Channel at 1.9 GHz**



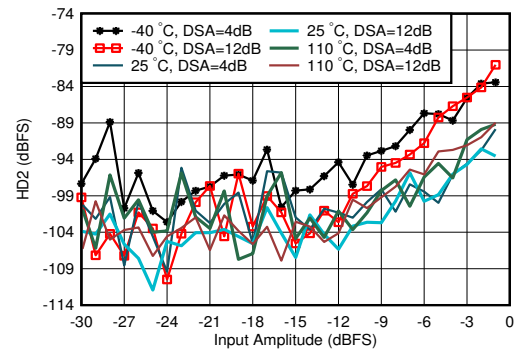
With 1.8GHz matching,  $f_{in} = 1900\text{MHz}$ , measured after HD2 trim, DDC bypass mode (TI only mode for characterization)

**Figure 4-335. RX HD2 vs DSA Setting and Temperature at 1.9 GHz**



With 1.8GHz matching,  $f_{in} = 1900\text{MHz}$ , measured after HD2 trim, DDC bypass mode (TI only mode for characterization)

**Figure 4-336. RX HD2 vs Input Amplitude and Channel at 1.9GHz**

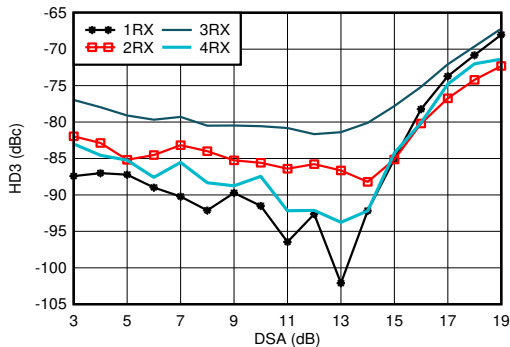


With 1.8GHz matching,  $f_{in} = 1900\text{MHz}$ , measured after HD2 trim, DDC bypass mode (TI only mode for characterization)

**Figure 4-337. RX HD2 vs Input Amplitude and Temperature at 1.9GHz**

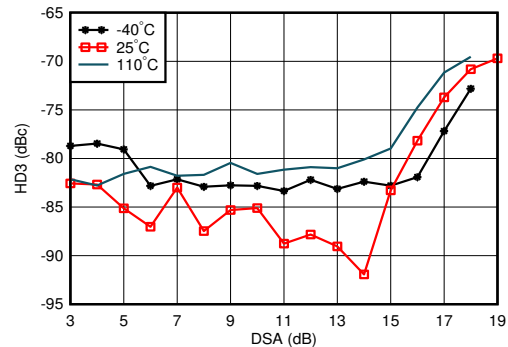
**4.12.9 RX Typical Characteristics at 1.75-1.9GHz (continued)**

Typical values at  $T_A = +25^\circ\text{C}$ , ADC Sampling Rate = 2949.12MHz. Default conditions: output sample rate = 491.52MSPS (decimate by 6), PLL clock mode with  $f_{REF} = 491.52\text{MHz}$ ,  $A_{IN} = -3\text{dBFS}$ , DSA setting = 4dB.



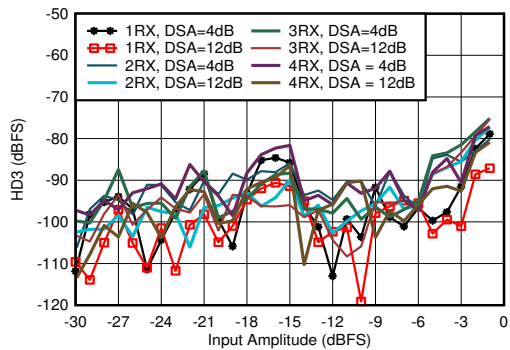
With 1.8GHz matching,  $f_{in} = 1900\text{MHz}$ , DDC bypass mode (TI only mode for characterization)

**Figure 4-338. RX HD3 vs DSA Setting and Channel at 1.9GHz**



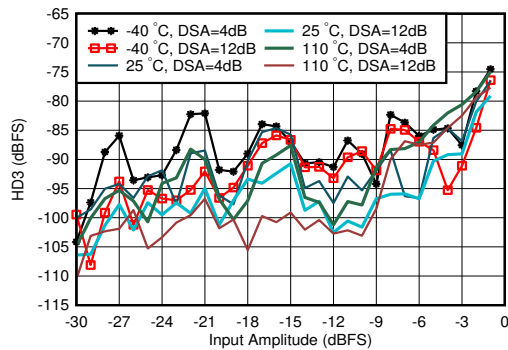
With 1.8GHz matching,  $f_{in} = 1900\text{MHz}$ , DDC bypass mode (TI only mode for characterization)

**Figure 4-339. RX HD3 vs DSA Setting and Temperature at 1.9GHz**



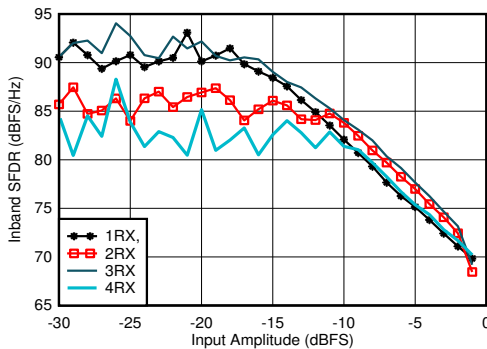
With 1.8GHz matching,  $f_{in} = 1900\text{MHz}$ , DDC bypass mode (TI only mode for characterization)

**Figure 4-340. RX HD3 vs Input Level and Channel at 1.9GHz**



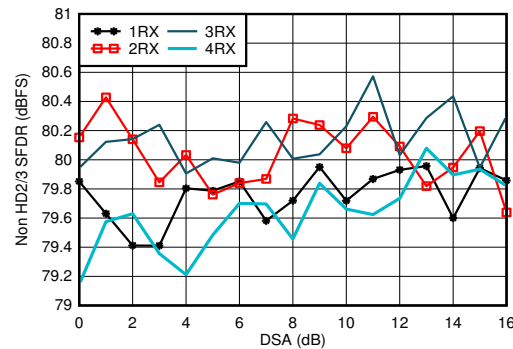
With 1.8GHz matching,  $f_{in} = 1900\text{MHz}$ , DDC bypass mode (TI only mode for characterization)

**Figure 4-341. RX HD3 vs Input Level and Temperature at 1.9GHz**



With 1.8GHz matching, decimated by 3

**Figure 4-342. RX In-Band SFDR ( $\pm 400\text{MHz}$ ) vs Input Amplitude at 1.75GHz**

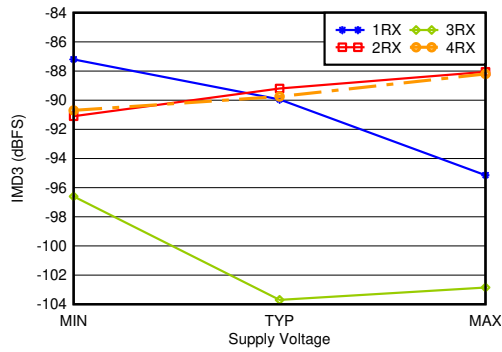


With 1.8GHz matching

**Figure 4-343. RX Non-HD2/3 vs DSA Setting at 1.75GHz**

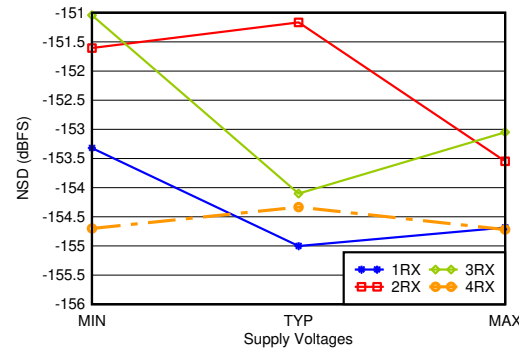
#### 4.12.9 RX Typical Characteristics at 1.75-1.9GHz (continued)

Typical values at  $T_A = +25^\circ\text{C}$ , ADC Sampling Rate = 2949.12MHz. Default conditions: output sample rate = 491.52MSPS (decimate by 6), PLL clock mode with  $f_{REF} = 491.52\text{MHz}$ ,  $A_{IN} = -3\text{dBFS}$ , DSA setting = 4dB.



With 1.8GHz matching, -7dBFS each tone, 20MHz tone spacing, all supplies at MIN, TYP, or MAX recommended operating voltages

Figure 4-344. RX IMD3 vs Supply and Channel at 1.75GHz

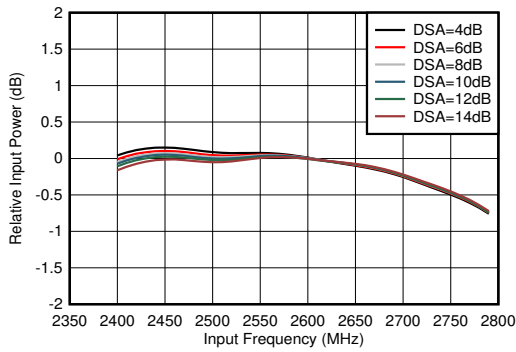


With 1.8GHz matching, 12.5MHz offset, all supplies at MIN, TYP, or MAX recommended operating voltages

Figure 4-345. RX Noise Spectral Density vs Supply and Channel at 1.75GHz

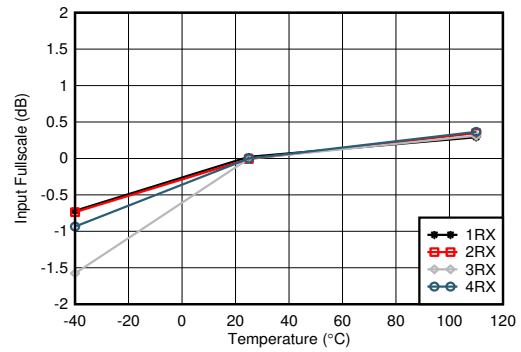
### 4.12.10 RX Typical Characteristics at 2.6GHz

Typical values at  $T_A = +25^\circ\text{C}$ , ADC Sampling Rate = 2949.12MHz. Default conditions: output sample rate = 491.52MSPS (decimate by 6), PLL clock mode with  $f_{REF} = 491.52\text{MHz}$ ,  $A_{IN} = -3\text{dBFS}$ , DSA setting = 4dB.



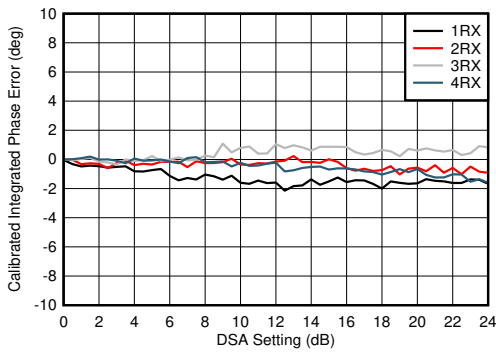
With matching, normalized to power at 2.6GHz for each DSA setting

**Figure 4-346. RX Inband Gain Flatness,  $f_{IN} = 2600\text{MHz}$**



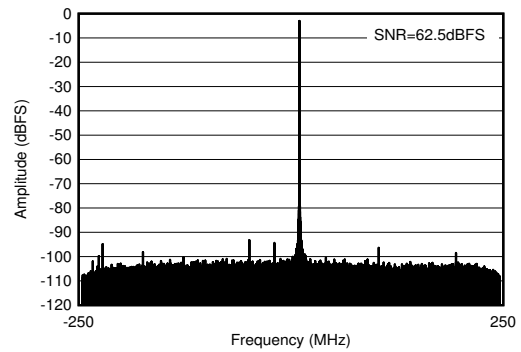
With 2.6GHz matching, normalized to fullscale at 25°C for each channel

**Figure 4-347. RX Input Fullscale vs Temperature and Channel at 2.6GHz**



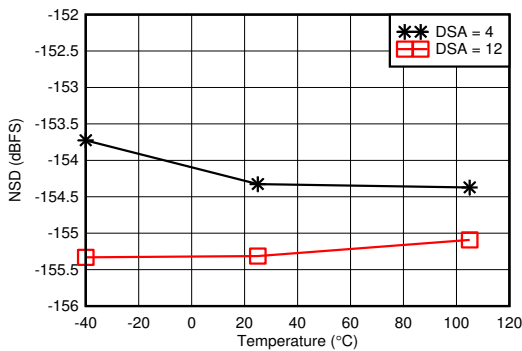
With 2.6GHz matching  
Integrated Phase Error = Phase(DSA Setting) – Phase(DSA Setting = 0)

**Figure 4-348. RX Calibrated Integrated Phase Error vs DSA Setting at 2.6GHz**



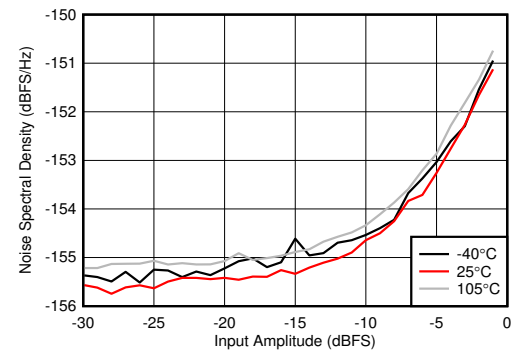
With 2.6GHz matching,  $f_{IN} = 2610\text{MHz}$ ,  $A_{IN} = -3\text{dBFS}$

**Figure 4-349. RX Output FFT at 2.6GHz**



With 2.6GHz matching, 12.5MHz offset from tone

**Figure 4-350. RX Noise Spectral Density vs Temperature at 2.6GHz**

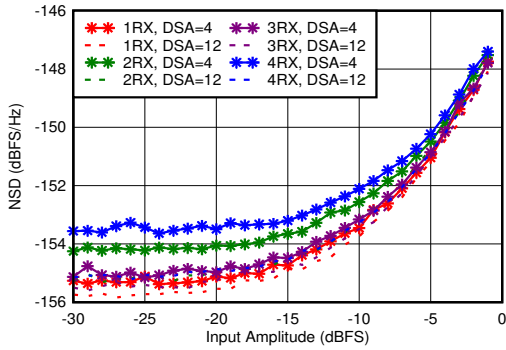


With 2.6GHz matching, DSA Setting = 12dB, 12.5MHz offset from tone

**Figure 4-351. RX Noise Spectral Density vs Input Amplitude and Temperature at 2.6GHz**

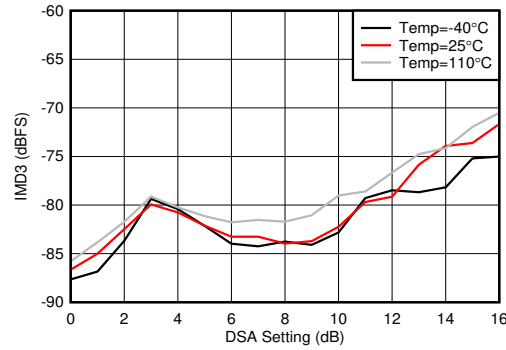
**4.12.10 RX Typical Characteristics at 2.6GHz (continued)**

Typical values at  $T_A = +25^\circ\text{C}$ , ADC Sampling Rate = 2949.12GHz. Default conditions: output sample rate = 491.52MSPS (decimate by 6), PLL clock mode with  $f_{REF} = 491.52\text{MHz}$ ,  $A_{IN} = -3\text{dBFS}$ , DSA setting = 4dB.



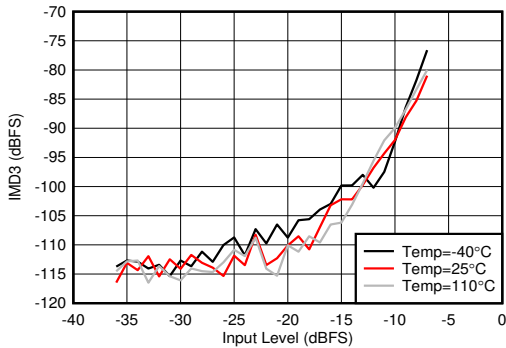
With 2.6GHz matching, 12.5MHz offset from tone

**Figure 4-352. RX Noise Spectral Density vs Input Amplitude and Channel at 2.6GHz**



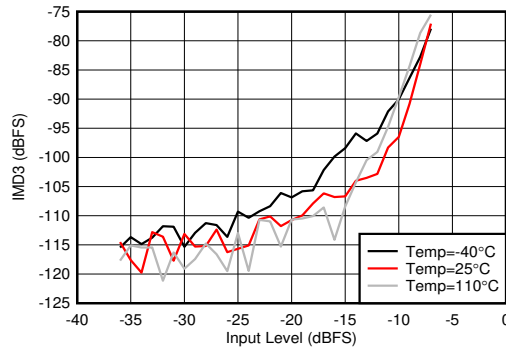
With 2.6GHz matching, each tone  $-7\text{dBFS}$ , tone spacing = 20MHz

**Figure 4-353. RX IMD3 vs DSA Setting and Temperature at 2.6GHz**



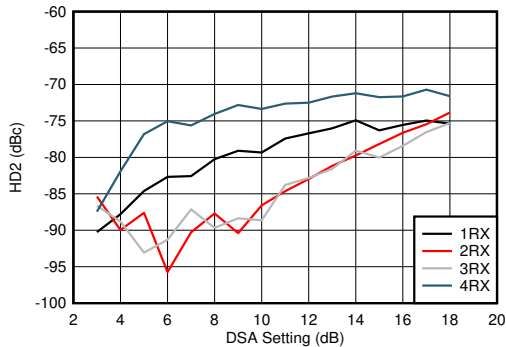
With 2.6GHz matching, tone spacing = 20MHz, DSA = 4dB

**Figure 4-354. RX IMD3 vs Input Level and Temperature at 2.6GHz**



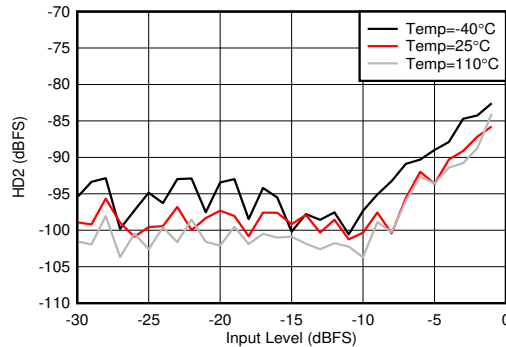
With 2.6GHz matching, tone spacing = 20MHz, DSA = 12dB

**Figure 4-355. RX IMD3 vs Input Level and Temperature at 2.6GHz**



With 2.6GHz matching, DDC bypass mode (TI only mode for characterization)

**Figure 4-356. RX HD2 vs DSA Setting and Channel at 2.6GHz**

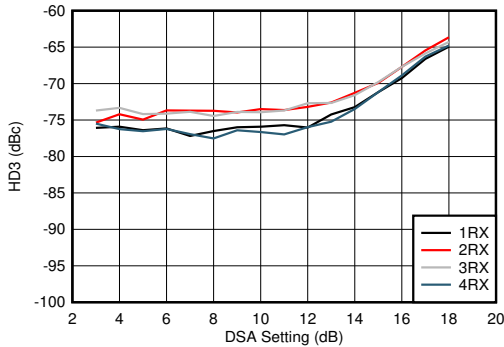


With 2.6GHz matching, DDC bypass mode (TI only mode for characterization)

**Figure 4-357. RX HD2 vs Input Level and Temperature at 2.6GHz**

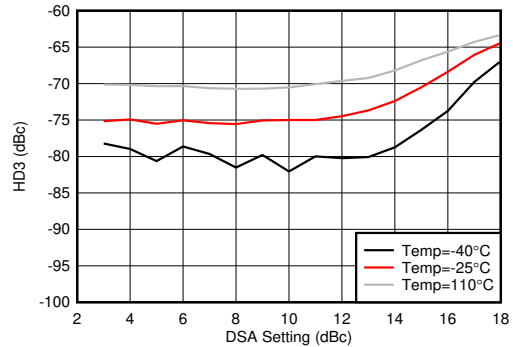
**4.12.10 RX Typical Characteristics at 2.6GHz (continued)**

Typical values at  $T_A = +25^\circ\text{C}$ , ADC Sampling Rate = 2949.12MHz. Default conditions: output sample rate = 491.52MSPS (decimate by 6), PLL clock mode with  $f_{REF} = 491.52\text{MHz}$ ,  $A_{IN} = -3\text{dBFS}$ , DSA setting = 4dB.



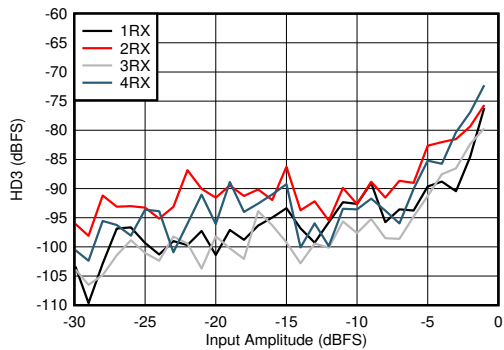
With 2.6GHz matching, DDC bypass mode (TI only mode for characterization)

**Figure 4-358. RX HD3 vs DSA Setting and Channel at 2.6GHz**



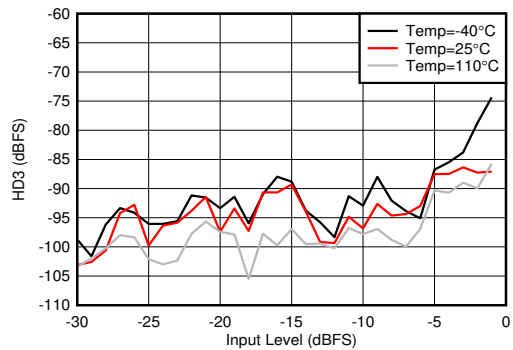
With 2.6GHz matching, DDC bypass mode (TI only mode for characterization)

**Figure 4-359. RX HD3 vs DSA Setting and Temperature at 2.6GHz**



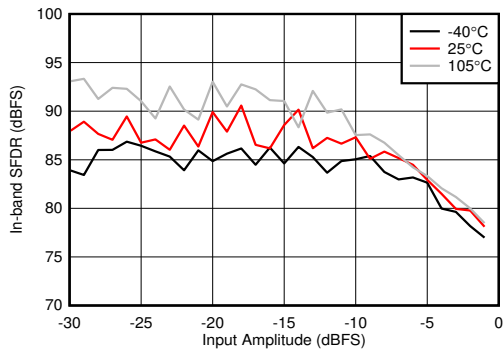
With 2.6GHz matching, DDC bypass mode (TI only mode for characterization)

**Figure 4-360. RX HD3 vs Input Level and Channel at 2.6GHz**



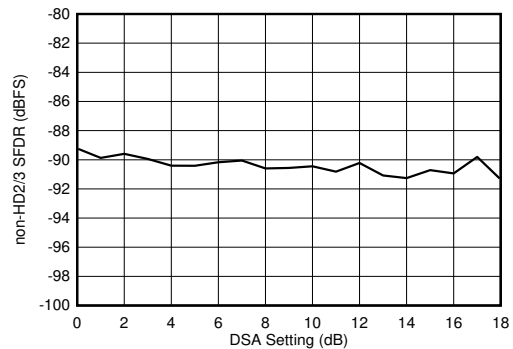
With 2.6GHz matching, DDC bypass mode (TI only mode for characterization)

**Figure 4-361. RX HD3 vs Input Level and Temperature at 2.6GHz**



With 2.6GHz matching, decimate by 4

**Figure 4-362. RX In-Band SFDR ( $\pm 300$  MHz) vs Input Amplitude and Temperature at 2.6GHz**

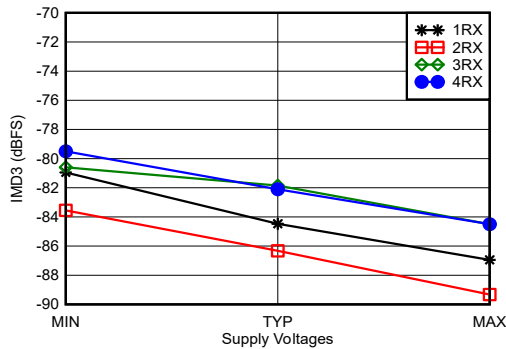


With 2.6GHz matching

**Figure 4-363. RX Non-HD2/3 vs DSA Setting at 2.6GHz**

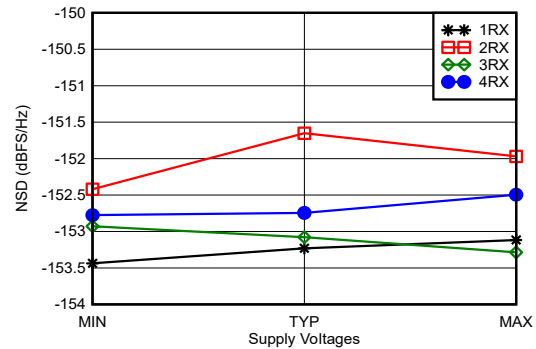
**4.12.10 RX Typical Characteristics at 2.6GHz (continued)**

Typical values at  $T_A = +25^\circ\text{C}$ , ADC Sampling Rate = 2949.12GHz. Default conditions: output sample rate = 491.52MSPS (decimate by 6), PLL clock mode with  $f_{REF} = 491.52\text{MHz}$ ,  $A_{IN} = -3\text{dBFS}$ , DSA setting = 4dB.



With 2.6GHz matching, -7dBFS each tone, 20MHz tone spacing, all supplies at MIN, TYP, or MAX recommended operating voltages

**Figure 4-364. RX IMD3 vs Supply and Channel at 2.6GHz**

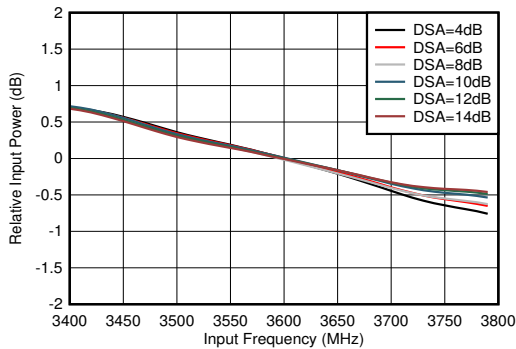


With 2.6GHz matching, 12.5MHz offset, all supplies at MIN, TYP, or MAX recommended operating voltages

**Figure 4-365. RX Noise Spectral Density vs Supply and Channel at 2.6GHz**

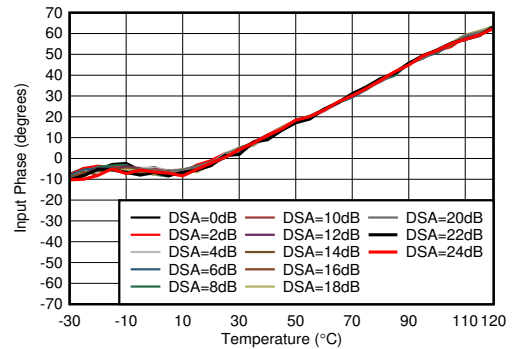
### 4.12.11 RX Typical Characteristics at 3.5GHz

Typical values at  $T_A = +25^\circ\text{C}$ , ADC Sampling Rate = 2949.12GHz. Default conditions: output sample rate = 491.52MSPS (decimate by 6), PLL clock mode with  $f_{REF} = 491.52\text{MHz}$ ,  $A_{IN} = -3\text{dBFS}$ , DSA setting = 4dB.



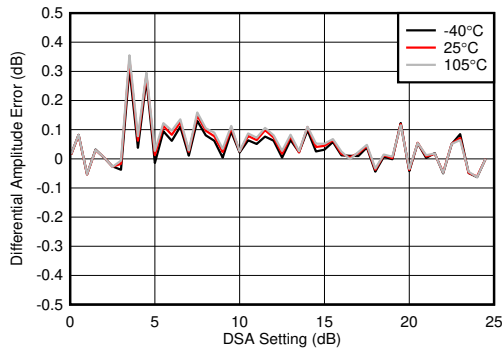
With 3.6GHz matching, normalized to 3.6GHz

**Figure 4-366. RX In-Band Gain Flatness,  $f_{IN} = 3600\text{MHz}$**



With 3.6GHz matching, normalized to phase at 25°C

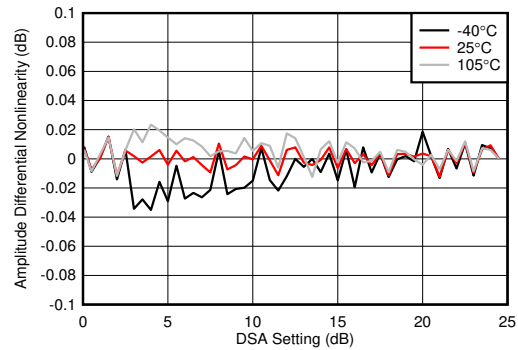
**Figure 4-367. RX Input Phase vs Temperature at 3.6GHz**



With 3.6GHz matching

$$\text{Differential Amplitude Error} = P_{IN}(\text{DSA Setting} - 1) - P_{IN}(\text{DSA Setting}) + 1$$

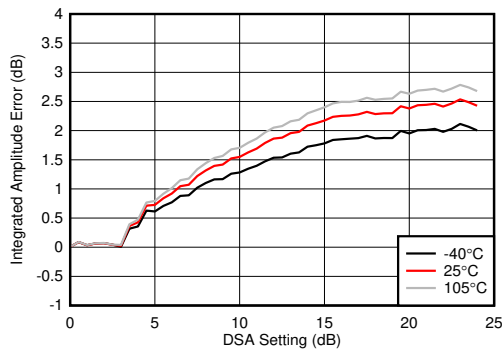
**Figure 4-368. RX Uncalibrated Differential Amplitude Error vs DSA Setting at 3.6GHz**



With 3.6GHz matching

$$\text{Differential Amplitude Error} = P_{IN}(\text{DSA Setting} - 1) - P_{IN}(\text{DSA Setting}) + 1$$

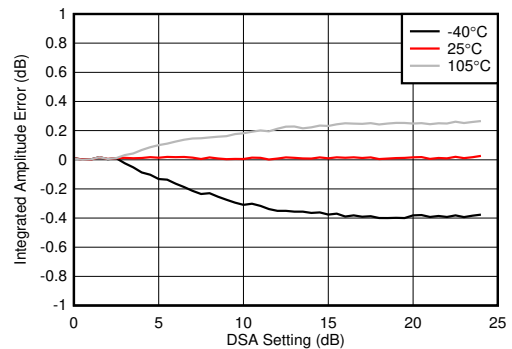
**Figure 4-369. RX Calibrated Differential Amplitude Error vs DSA Setting at 3.6GHz**



With 3.6GHz matching

$$\text{Integrated Amplitude Error} = P_{IN}(\text{DSA Setting}) - P_{IN}(\text{DSA Setting} = 0) + (\text{DSA Setting})$$

**Figure 4-370. RX Uncalibrated Integrated Amplitude Error vs DSA Setting at 3.6GHz**



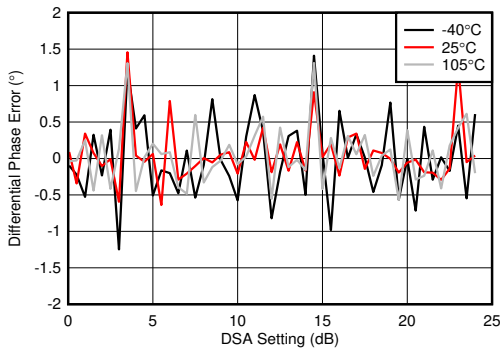
With 3.6GHz matching

$$\text{Integrated Amplitude Error} = P_{IN}(\text{DSA Setting}) - P_{IN}(\text{DSA Setting} = 0) + (\text{DSA Setting})$$

**Figure 4-371. RX Calibrated Integrated Amplitude Error vs DSA Setting at 3.6GHz**

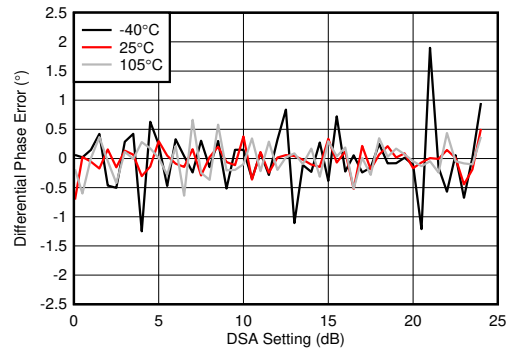
**4.12.11 RX Typical Characteristics at 3.5GHz (continued)**

Typical values at  $T_A = +25^\circ\text{C}$ , ADC Sampling Rate = 2949.12MHz. Default conditions: output sample rate = 491.52MSPS (decimate by 6), PLL clock mode with  $f_{REF} = 491.52\text{MHz}$ ,  $A_{IN} = -3\text{dBFS}$ , DSA setting = 4dB.



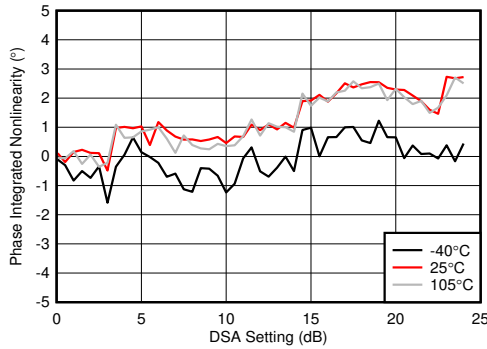
With 3.6GHz matching  
 Differential Phase Error =  $\text{Phase}_{IN}(\text{DSA Setting} - 1) - \text{Phase}_{IN}(\text{DSA Setting})$

**Figure 4-372. RX Uncalibrated Phase Error vs DSA Setting at 3.6GHz**



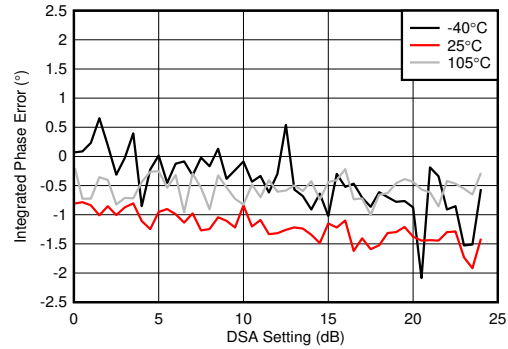
With 3.6GHz matching  
 Differential Phase Error =  $\text{Phase}_{IN}(\text{DSA Setting} - 1) - \text{Phase}_{IN}(\text{DSA Setting})$

**Figure 4-373. RX Calibrated Differential Phase Error vs DSA Setting at 3.6GHz**



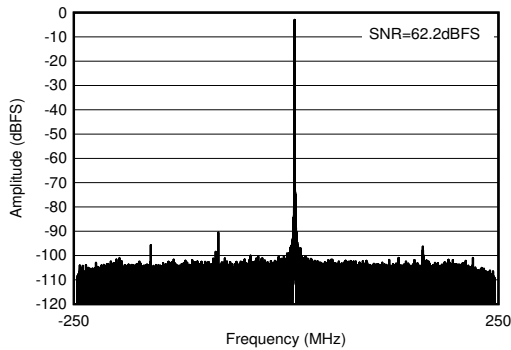
With 3.6GHz matching  
 Integrated Phase Error =  $\text{Phase}(\text{DSA Setting}) - \text{Phase}(\text{DSA Setting} = 0)$

**Figure 4-374. RX Uncalibrated Integrated Phase Error vs DSA Setting at 3.6GHz**



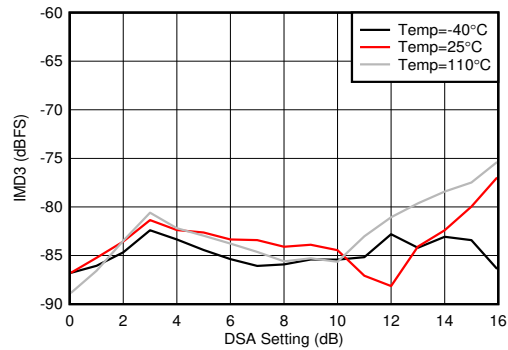
With 3.6GHz matching  
 Integrated Phase Error =  $\text{Phase}(\text{DSA Setting}) - \text{Phase}(\text{DSA Setting} = 0)$

**Figure 4-375. RX Calibrated Integrated Phase Error vs DSA Setting at 3.6GHz**



With 3.6GHz matching,  $f_{IN} = 3610\text{MHz}$ ,  $A_{IN} = -3\text{dBFS}$

**Figure 4-376. RX Output FFT at 3.6GHz**

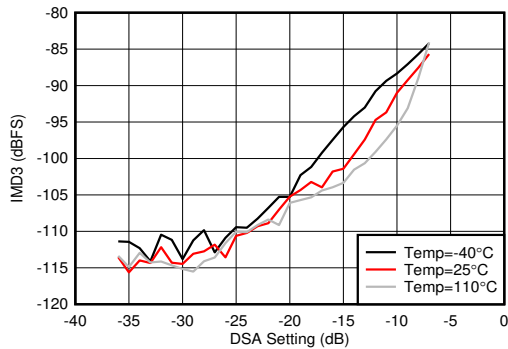


With 3.5 GHz matching, each tone at  $-7\text{dBFS}$ , 20MHz tone spacing

**Figure 4-377. RX IMD3 vs DSA Setting and Temperature at 3.6GHz**

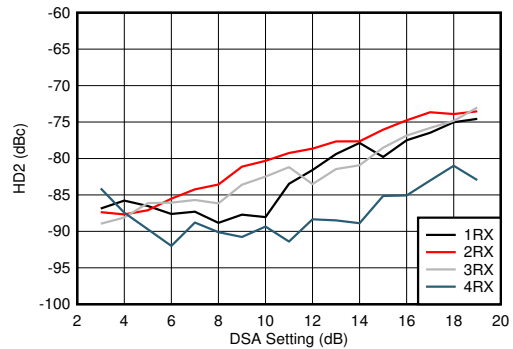
**4.12.11 RX Typical Characteristics at 3.5GHz (continued)**

Typical values at  $T_A = +25^\circ\text{C}$ , ADC Sampling Rate = 2949.12GHz. Default conditions: output sample rate = 491.52MSPS (decimate by 6), PLL clock mode with  $f_{REF} = 491.52\text{MHz}$ ,  $A_{IN} = -3\text{dBFS}$ , DSA setting = 4dB.



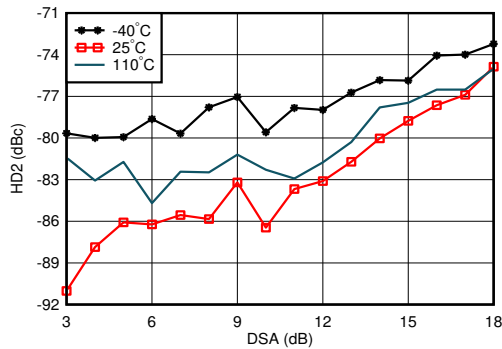
With 3.5GHz matching, 20MHz tone spacing

**Figure 4-378. RX IMD3 vs Input Level and Temperature at 3.6GHz**



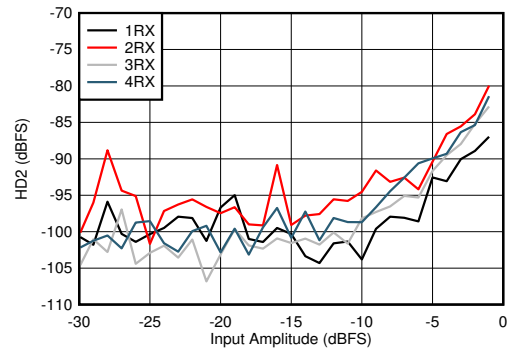
With 3.5GHz matching, DDC bypass mode (TI only mode for characterization)

**Figure 4-379. RX HD2 vs DSA Setting and Channel at 3.6GHz**



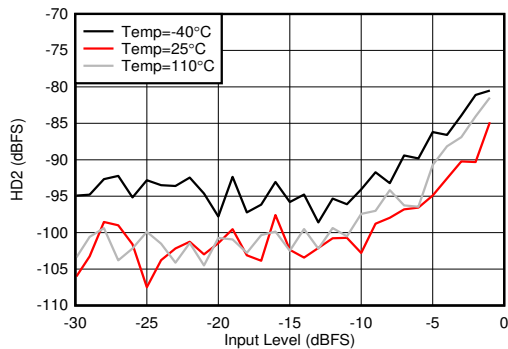
With 3.5GHz matching, DDC bypass mode (TI only mode for characterization)

**Figure 4-380. RX HD2 vs DSA Setting and Temperature at 3.6GHz**



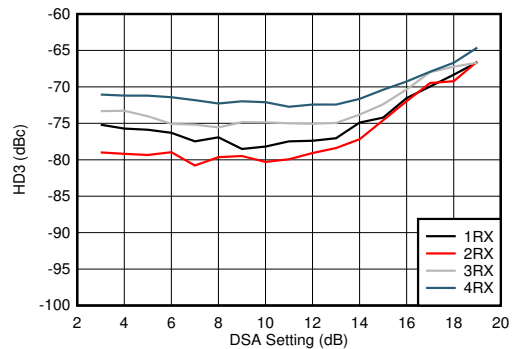
With 3.5GHz matching, DDC bypass mode (TI only mode for characterization)

**Figure 4-381. RX HD2 vs Input Level and Channel at 3.6GHz**



With 3.5GHz matching, DDC bypass mode (TI only mode for characterization)

**Figure 4-382. RX HD2 vs Input Level and Temperature at 3.6GHz**

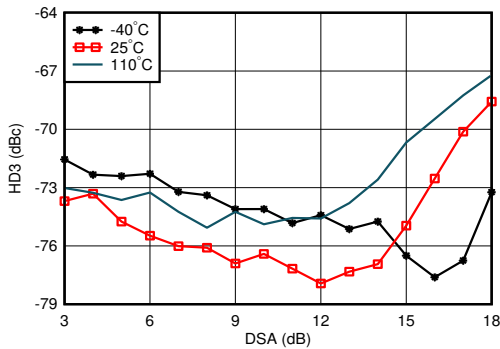


With 3.5GHz matching, DDC bypass mode (TI only mode for characterization)

**Figure 4-383. RX HD3 vs DSA Setting and Channel at 3.6GHz**

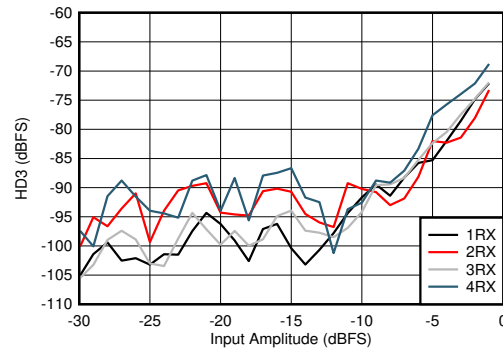
**4.12.11 RX Typical Characteristics at 3.5GHz (continued)**

Typical values at  $T_A = +25^\circ\text{C}$ , ADC Sampling Rate = 2949.12MHz. Default conditions: output sample rate = 491.52MSPS (decimate by 6), PLL clock mode with  $f_{REF} = 491.52\text{MHz}$ ,  $A_{IN} = -3\text{dBFS}$ , DSA setting = 4dB.



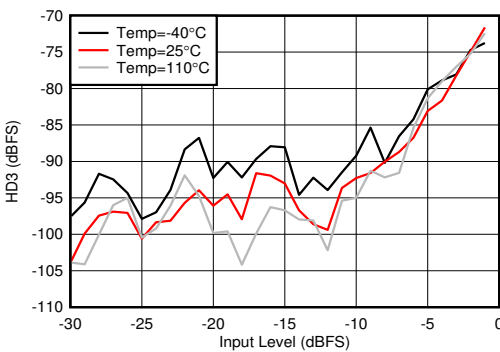
With 3.5GHz matching, DDC bypass mode (TI only mode for characterization)

**Figure 4-384. RX HD3 vs DSA Setting and Temperature at 3.6GHz**



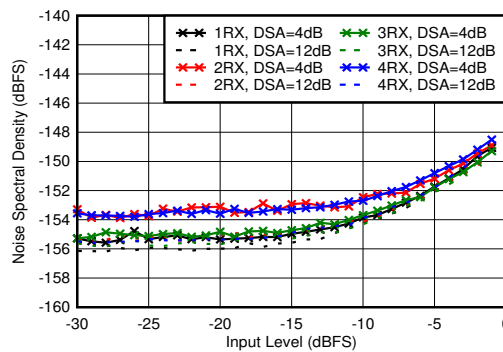
With 3.5GHz matching, DDC bypass mode (TI only mode for characterization)

**Figure 4-385. RX HD3 vs Input Level and Channel at 3.6GHz**



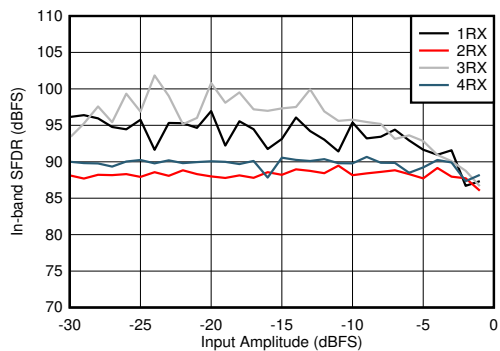
With 3.5GHz matching, DDC bypass mode (TI only mode for characterization)

**Figure 4-386. RX HD3 vs Input Level and Temperature at 3.6GHz**



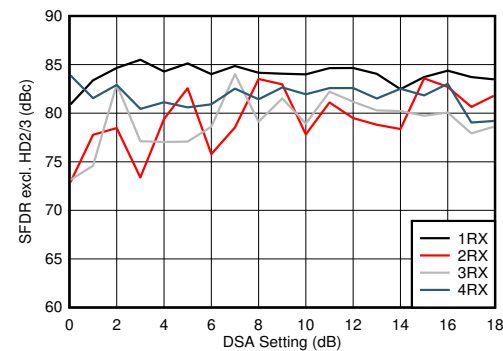
With 3.5GHz matching, 12.5-MHz offset from tone

**Figure 4-387. RX Noise Spectral Density vs Input Level and DSA Setting at 3.6GHz**



With 3.5GHz matching

**Figure 4-388. RX In-Band SFDR ( $\pm 200\text{MHz}$ ) vs Input Level and Channel at 3.6GHz**

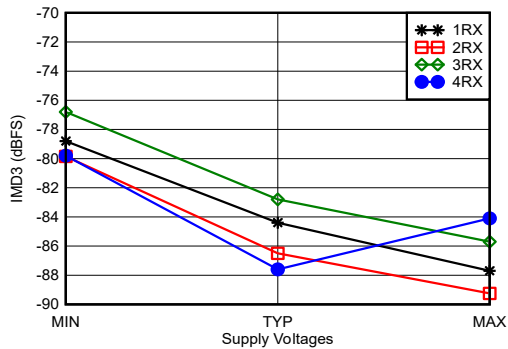


With 3.5GHz matching

**Figure 4-389. RX SFDR Excluding HD2/3 vs DSA Setting and Channel at 3.6GHz**

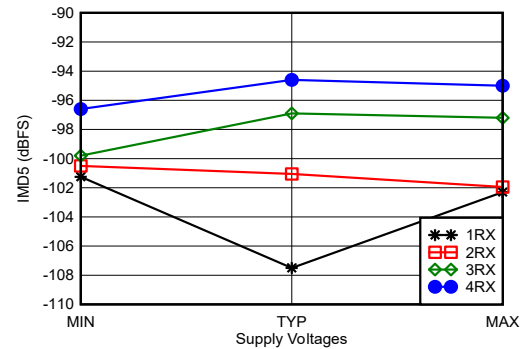
#### 4.12.11 RX Typical Characteristics at 3.5GHz (continued)

Typical values at  $T_A = +25^\circ\text{C}$ , ADC Sampling Rate = 2949.12GHz. Default conditions: output sample rate = 491.52MSPS (decimate by 6), PLL clock mode with  $f_{REF} = 491.52\text{MHz}$ ,  $A_{IN} = -3\text{dBFS}$ , DSA setting = 4dB.



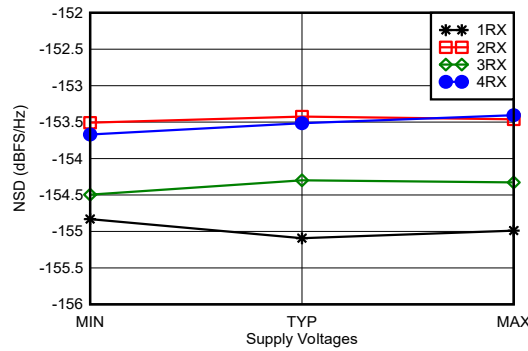
With 3.6GHz matching,  $-7\text{dBFS}$  each tone, 20MHz tone spacing, all supplies at MIN, TYP, or MAX recommended operating voltages

Figure 4-390. RX IMD3 vs Supply Voltage and Channel at 3.6GHz



With 3.6GHz matching,  $-7\text{dBFS}$  each tone, 20-MHz tone spacing, all supplies at MIN, TYP, or MAX recommended operating voltages

Figure 4-391. RX IMD5 vs Supply Voltage and Channel at 3.6GHz

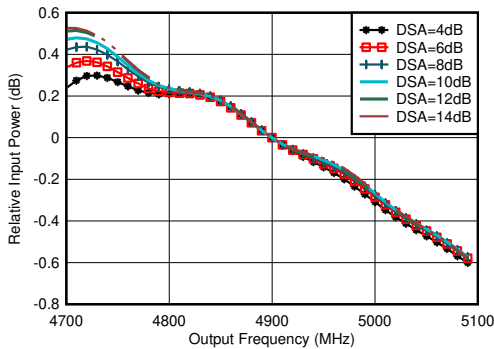


With 3.6GHz matching, tone at 20 dBFS, 12.5MHz offset frequency, all supplies at MIN, TYP, or MAX recommended operating voltages

Figure 4-392. RX Noise Spectral Density vs Supply Voltage and Channel at 3.6GHz

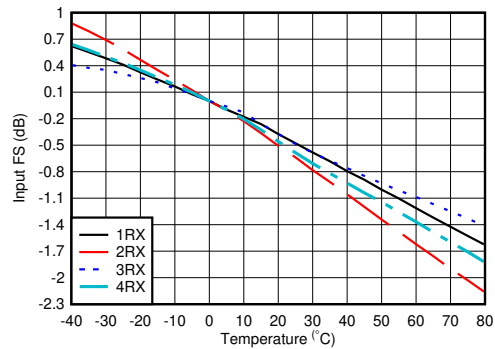
### 4.12.12 RX Typical Characteristics at 4.9GHz

Typical values at  $T_A = +25^\circ\text{C}$ , ADC Sampling Rate = 2949.12GHz. Default conditions: output sample rate = 491.52MSPS (decimate by 6), PLL clock mode with  $f_{REF} = 491.52\text{MHz}$ ,  $A_{IN} = -3\text{dBFS}$ , DSA setting = 4dB.



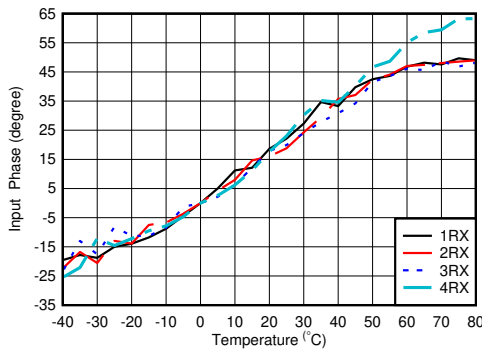
With matching, normalized to power at 4.9GHz for each DSA setting

**Figure 4-393. RX Inband Gain Flatness,  $f_{IN} = 4900\text{MHz}$**



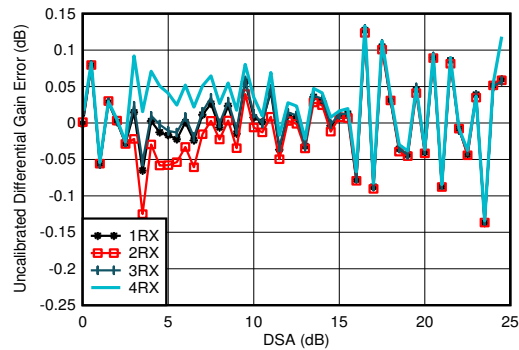
With 4.9GHz matching, normalized to fullscale at 25°C for each channel

**Figure 4-394. RX Input Fullscale vs Temperature and Channel at 4.9GHz**



With 4.9GHz matching, normalized to phase at 25°C

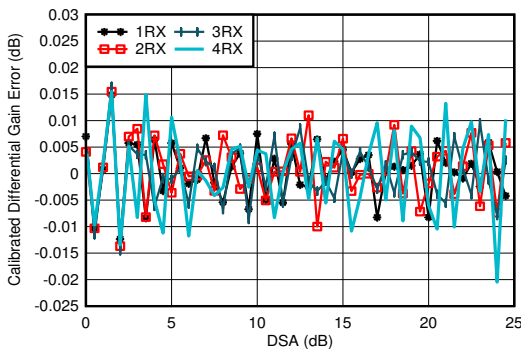
**Figure 4-395. RX Input Phase vs Temperature and DSA at  $f_{OUT} = 4.9\text{GHz}$**



With 4.9GHz matching

$$\text{Differential Amplitude Error} = P_{IN}(\text{DSA Setting} - 1) - P_{IN}(\text{DSA Setting}) + 1$$

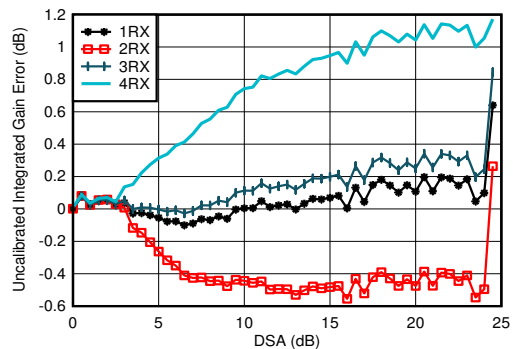
**Figure 4-396. RX Uncalibrated Differential Amplitude Error vs DSA Setting at 4.9GHz**



With 4.9GHz matching

$$\text{Differential Amplitude Error} = P_{IN}(\text{DSA Setting} - 1) - P_{IN}(\text{DSA Setting}) + 1$$

**Figure 4-397. RX Calibrated Differential Amplitude Error vs DSA Setting at 4.9GHz**



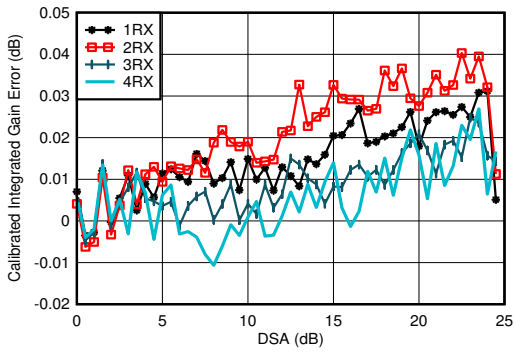
With 4.9GHz matching

$$\text{Integrated Amplitude Error} = P_{IN}(\text{DSA Setting}) - P_{IN}(\text{DSA Setting} = 0) + (\text{DSA Setting})$$

**Figure 4-398. RX Uncalibrated Integrated Amplitude Error vs DSA Setting at 4.9GHz**

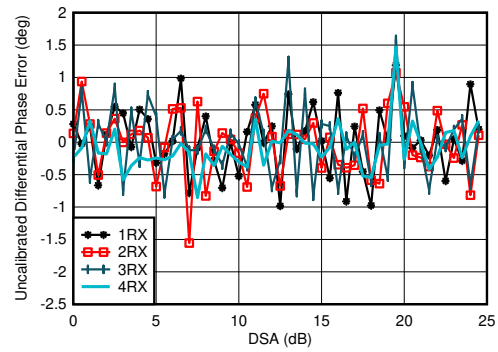
**4.12.12 RX Typical Characteristics at 4.9GHz (continued)**

Typical values at  $T_A = +25^\circ\text{C}$ , ADC Sampling Rate = 2949.12GHz. Default conditions: output sample rate = 491.52MSPS (decimate by 6), PLL clock mode with  $f_{REF} = 491.52\text{MHz}$ ,  $A_{IN} = -3\text{dBFS}$ , DSA setting = 4dB.



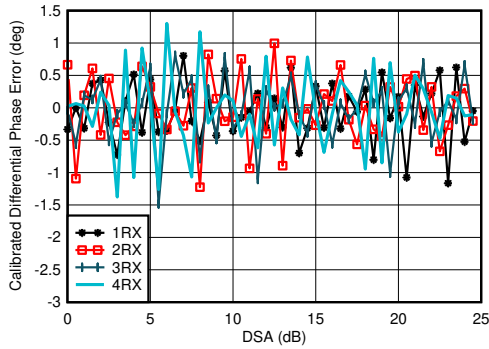
With 4.9GHz matching  
Integrated Amplitude Error =  $P_{IN}(\text{DSA Setting}) - P_{IN}(\text{DSA Setting} = 0) + (\text{DSA Setting})$

**Figure 4-399. RX Calibrated Integrated Amplitude Error vs DSA Setting at 4.9GHz**



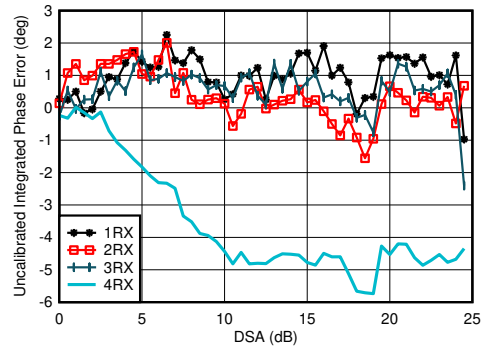
With 4.9GHz matching  
Differential Phase Error =  $\text{Phase}_{IN}(\text{DSA Setting} - 1) - \text{Phase}_{IN}(\text{DSA Setting})$

**Figure 4-400. RX Uncalibrated Differential Phase Error vs DSA Setting at 4.9GHz**



With 4.9GHz matching  
Differential Phase Error =  $\text{Phase}_{IN}(\text{DSA Setting} - 1) - \text{Phase}_{IN}(\text{DSA Setting})$

**Figure 4-401. RX Calibrated Differential Phase Error vs DSA Setting at 4.9GHz**

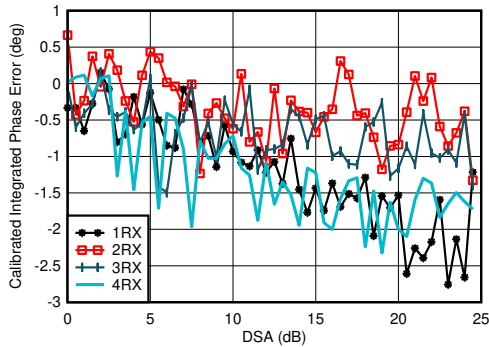


With 4.9GHz matching  
Integrated Phase Error =  $\text{Phase}(\text{DSA Setting}) - \text{Phase}(\text{DSA Setting} = 0)$

**Figure 4-402. RX Uncalibrated Integrated Phase Error vs DSA Setting at 4.9GHz**

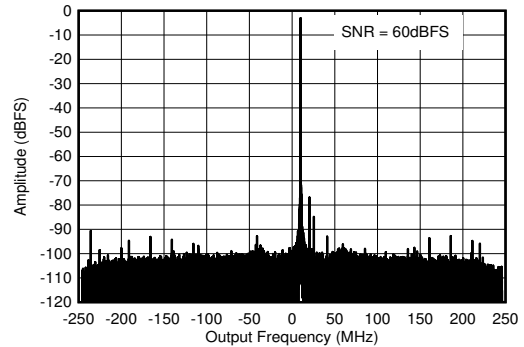
**4.12.12 RX Typical Characteristics at 4.9GHz (continued)**

Typical values at  $T_A = +25^\circ\text{C}$ , ADC Sampling Rate = 2949.12MHz. Default conditions: output sample rate = 491.52MSPS (decimate by 6), PLL clock mode with  $f_{REF} = 491.52\text{MHz}$ ,  $A_{IN} = -3\text{dBFS}$ , DSA setting = 4dB.



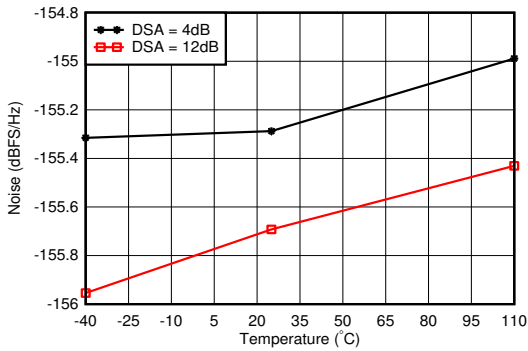
With 4.9GHz matching  
Integrated Phase Error = Phase(DSA Setting) – Phase(DSA Setting = 0)

**Figure 4-403. RX Calibrated Integrated Phase Error vs DSA Setting at 4.9GHz**



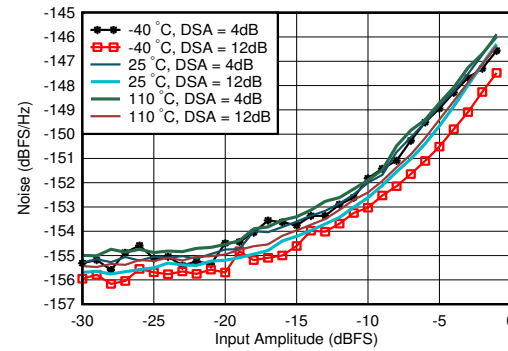
With 4.9GHz matching,  $f_{IN} = 4910\text{MHz}$ ,  $A_{IN} = -3\text{dBFS}$

**Figure 4-404. RX Output FFT at 4.9GHz**



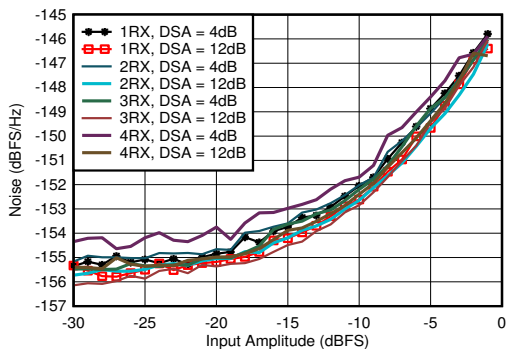
With 4.9GHz matching, 12.5-MHz offset from tone

**Figure 4-405. RX Noise Spectral Density vs Temperature at 4.9GHz**



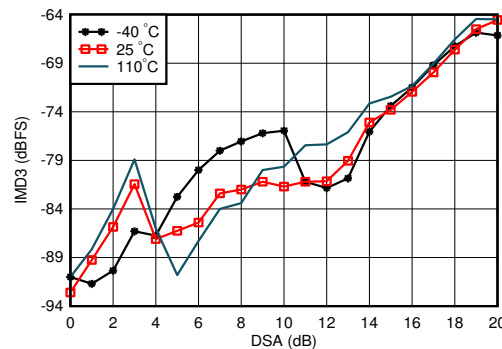
With 4.9GHz matching, DSA Setting = 12dB, 12.5MHz offset from tone

**Figure 4-406. RX Noise Spectral Density vs Input Amplitude and Temperature at 4.9GHz**



With 4.9GHz matching, 12.5MHz offset from tone

**Figure 4-407. RX Noise Spectral Density vs Input Amplitude and Channel at 4.9GHz**

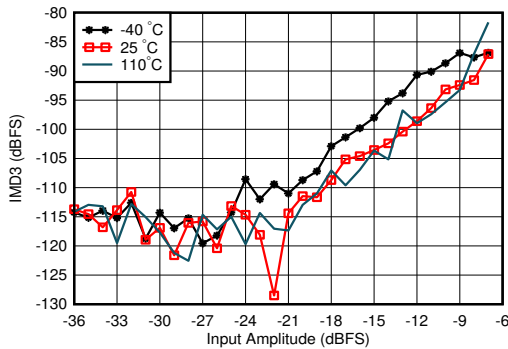


With 4.9GHz matching, each tone  $-7\text{dBFS}$ , tone spacing = 20MHz

**Figure 4-408. RX IMD3 vs DSA Setting and Temperature at 4.9GHz**

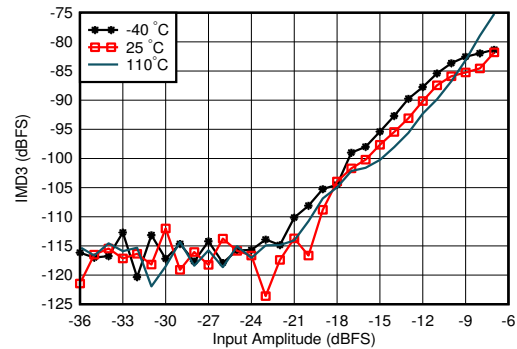
**4.12.12 RX Typical Characteristics at 4.9GHz (continued)**

Typical values at  $T_A = +25^\circ\text{C}$ , ADC Sampling Rate = 2949.12MHz. Default conditions: output sample rate = 491.52MSPS (decimate by 6), PLL clock mode with  $f_{REF} = 491.52\text{MHz}$ ,  $A_{IN} = -3\text{dBFS}$ , DSA setting = 4dB.



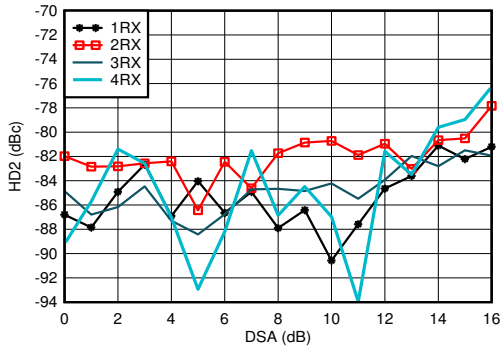
With 4.9GHz matching, tone spacing = 20MHz, DSA = 4dB

**Figure 4-409. RX IMD3 vs Input Level and Temperature at 4.9GHz**



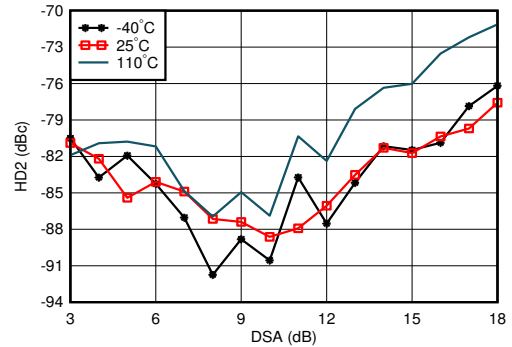
With 4.9GHz matching, tone spacing = 20MHz, DSA = 12dB

**Figure 4-410. RX IMD3 vs Input Level and Temperature at 4.9GHz**



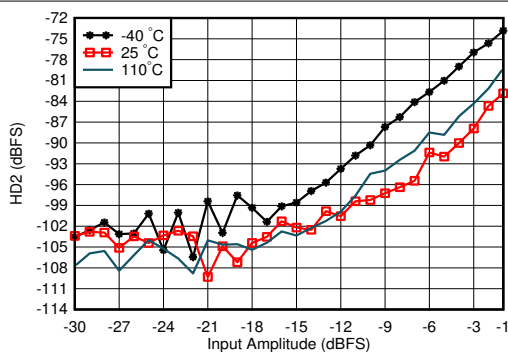
With 4.9GHz matching, measured after HD2 trim, DDC bypass mode (TI only mode for characterization)

**Figure 4-411. RX HD2 vs DSA Setting and Channel at 4.9GHz**



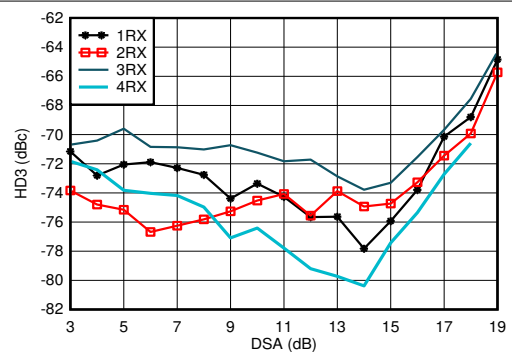
With 4.9GHz matching, measured after HD2 trim, DDC bypass mode (TI only mode for characterization)

**Figure 4-412. RX HD2 vs DSA and Temperature at 4.9GHz**



With 4.9GHz matching, measured after HD2 trim, DDC bypass mode (TI only mode for characterization)

**Figure 4-413. RX HD2 vs Input Level and Temperature at 4.9GHz**

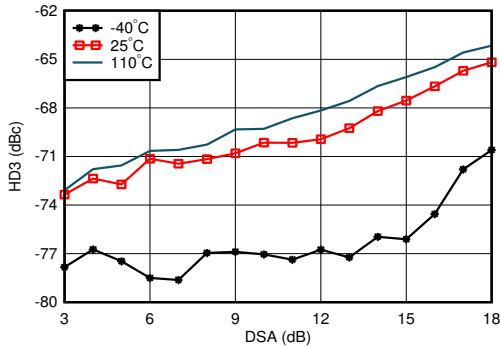


With 4.9GHz matching, DDC bypass mode (TI only mode for characterization)

**Figure 4-414. RX HD3 vs DSA Setting and Channel at 4.9GHz**

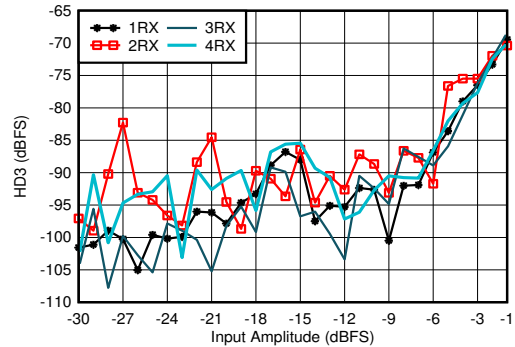
4.12.12 RX Typical Characteristics at 4.9GHz (continued)

Typical values at  $T_A = +25^\circ\text{C}$ , ADC Sampling Rate = 2949.12MHz. Default conditions: output sample rate = 491.52MSPS (decimate by 6), PLL clock mode with  $f_{REF} = 491.52\text{MHz}$ ,  $A_{IN} = -3\text{dBFS}$ , DSA setting = 4dB.



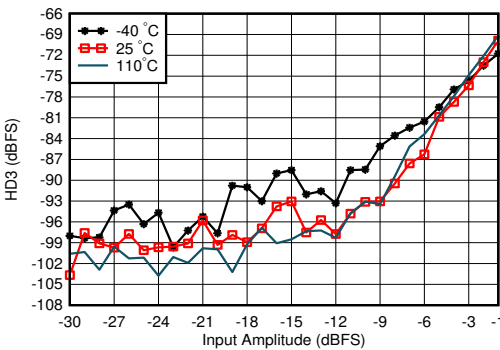
With 4.9GHz matching, DDC bypass mode (TI only mode for characterization)

Figure 4-415. RX HD3 vs DSA Setting and Temperature at 4.9GHz



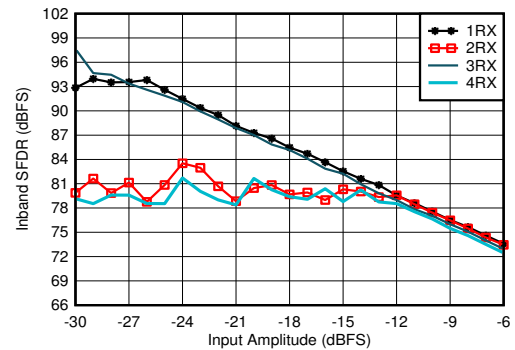
With 4.9GHz matching, DDC bypass mode (TI only mode for characterization)

Figure 4-416. RX HD3 vs Input Level and Channel at 4.9GHz



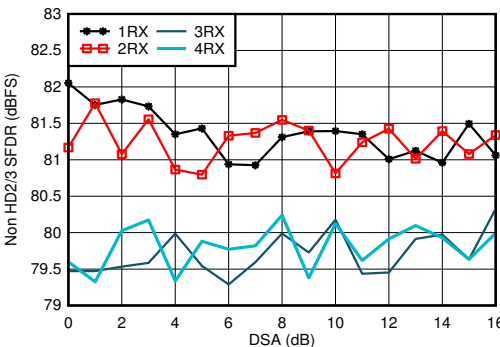
With 4.9GHz matching, DDC bypass mode (TI only mode for characterization)

Figure 4-417. RX HD3 vs Input Level and Temperature at 4.9GHz



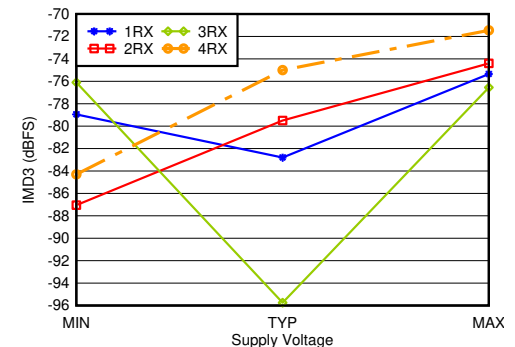
With 4.9GHz matching, decimate by 3

Figure 4-418. RX In-Band SFDR ( $\pm 400\text{ MHz}$ ) vs Input Amplitude and Channel at 4.9GHz



With 4.9GHz matching

Figure 4-419. RX Non-HD2/3 vs DSA Setting at 4.9GHz

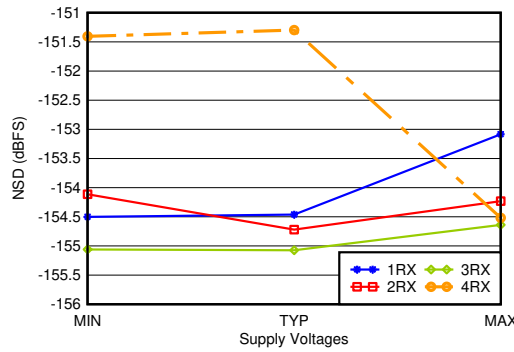


With 4.9GHz matching,  $-7\text{dBFS}$  each tone, 20MHz tone spacing, all supplies at MIN, TYP, or MAX recommended operating voltages

Figure 4-420. RX IMD3 vs Supply and Channel at 4.9GHz

### 4.12.12 RX Typical Characteristics at 4.9GHz (continued)

Typical values at  $T_A = +25^\circ\text{C}$ , ADC Sampling Rate = 2949.12GHz. Default conditions: output sample rate = 491.52MSPS (decimate by 6), PLL clock mode with  $f_{REF} = 491.52\text{MHz}$ ,  $A_{IN} = -3\text{dBFS}$ , DSA setting = 4dB.

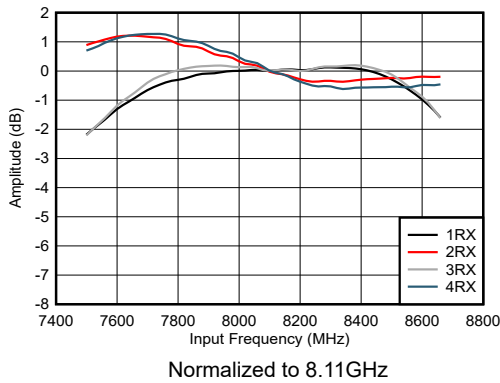


With 4.9GHz matching, 12.5MHz offset, all supplies at MIN, TYP, or MAX recommended operating voltages

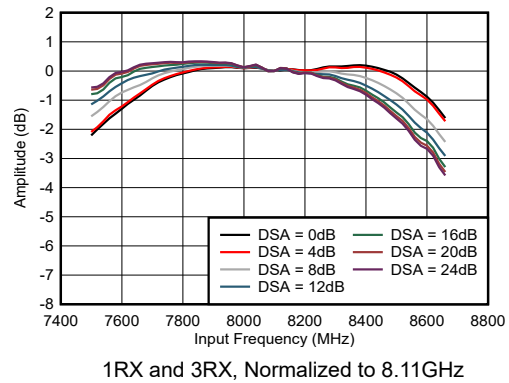
**Figure 4-421. RX Noise Spectral Density vs Supply and Channel at 4.9GHz**

### 4.12.13 RX Typical Characteristics at 8.1GHz

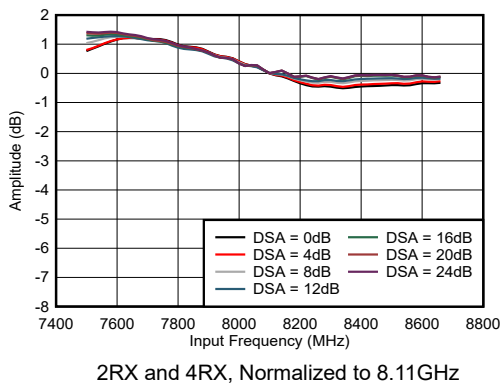
Typical values at  $T_A = +25^\circ\text{C}$ , ADC Sampling Rate = 2949.12GHz. Default conditions: output sample rate = 1474.56MSPS (decimate by 2), External clock mode with  $f_{CLK} = 11796.48\text{MHz}$ ,  $A_{IN} = -3\text{dBFS}$ , DSA setting = 3 dB, 8.1GHz matching.



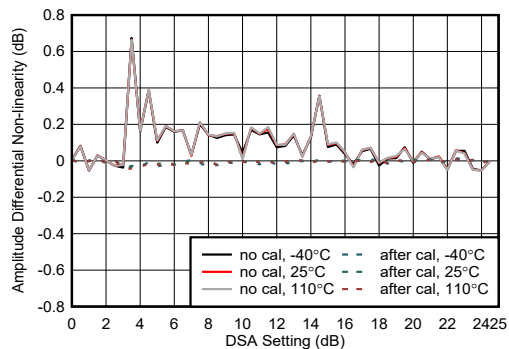
**Figure 4-422. RX Amplitude vs Frequency and Channel**



**Figure 4-423. RX Amplitude vs Frequency and DSA Setting**



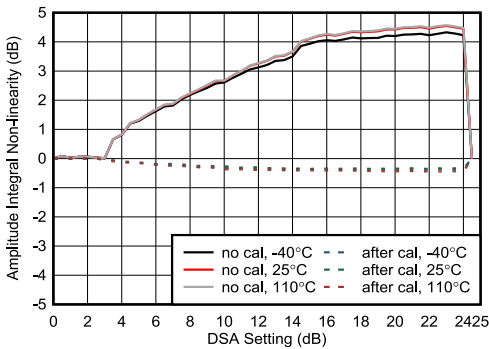
**Figure 4-424. RX Amplitude vs Frequency and DSA Setting**



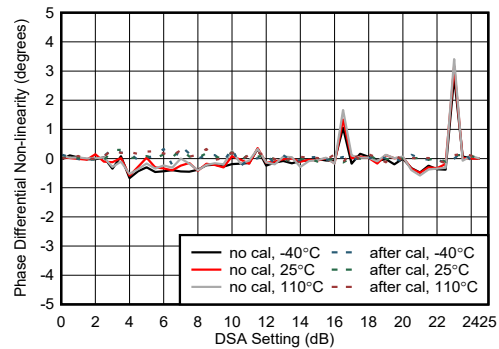
**Figure 4-425. RX Amplitude Differential Nonlinearity at 8.11GHz**

**4.12.13 RX Typical Characteristics at 8.1GHz (continued)**

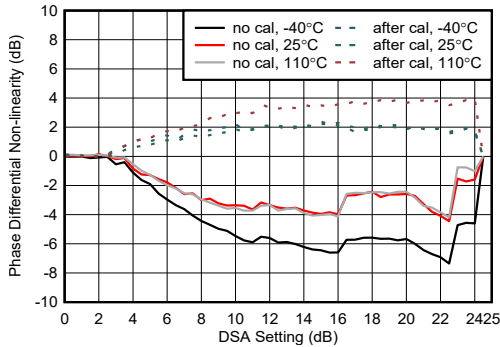
Typical values at  $T_A = +25^\circ\text{C}$ , ADC Sampling Rate = 2949.12MHz. Default conditions: output sample rate = 1474.56MSPS (decimate by 2), External clock mode with  $f_{\text{CLK}} = 11796.48\text{MHz}$ ,  $A_{\text{IN}} = -3\text{dBFS}$ , DSA setting = 3 dB, 8.1GHz matching.



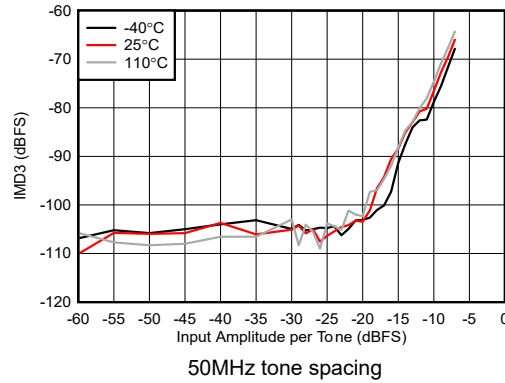
**Figure 4-426. RX Amplitude Integrated Nonlinearity at 8.1GHz**



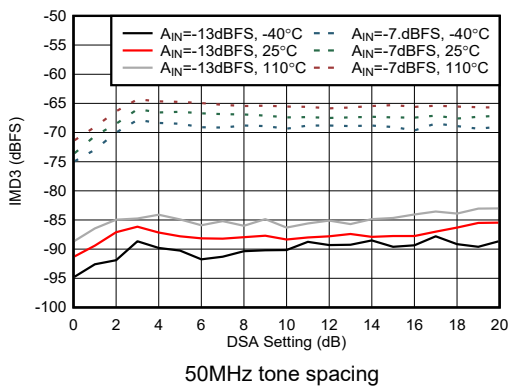
**Figure 4-427. RX Phase Differential Nonlinearity at 8.1GHz**



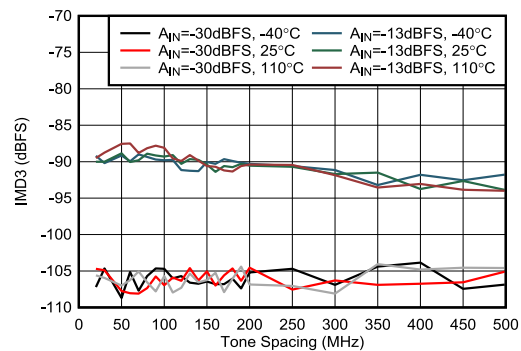
**Figure 4-428. RX Phase Differential Nonlinearity at 8.1GHz**



**Figure 4-429. RX IMD3 vs Input Amplitude at 8.1GHz**



**Figure 4-430. RX IMD3 vs DSA Setting at 8.1GHz**



**Figure 4-431. RX IMD3 vs Tone Spacing at 8.1GHz**

### 4.12.13 RX Typical Characteristics at 8.1GHz (continued)

Typical values at  $T_A = +25^\circ\text{C}$ , ADC Sampling Rate = 2949.12MHz. Default conditions: output sample rate = 1474.56MSPS (decimate by 2), External clock mode with  $f_{\text{CLK}} = 11796.48\text{MHz}$ ,  $A_{\text{IN}} = -3\text{dBFS}$ , DSA setting = 3 dB, 8.1GHz matching.

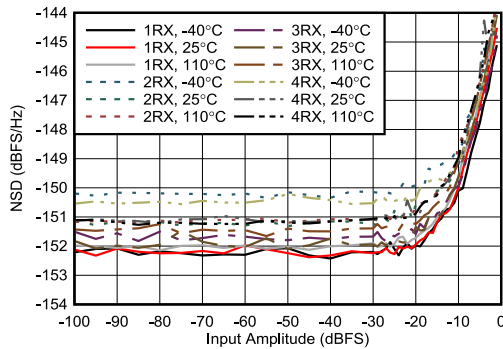


Figure 4-432. RX NSD vs Digital Amplitude at 8.11GHz

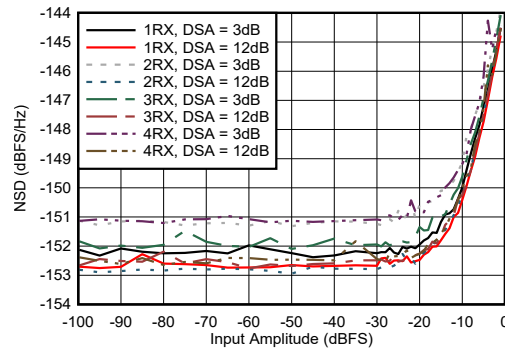


Figure 4-433. RX NSD vs Digital Amplitude at 8.11GHz

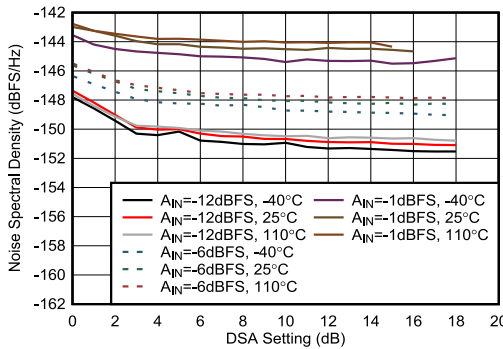
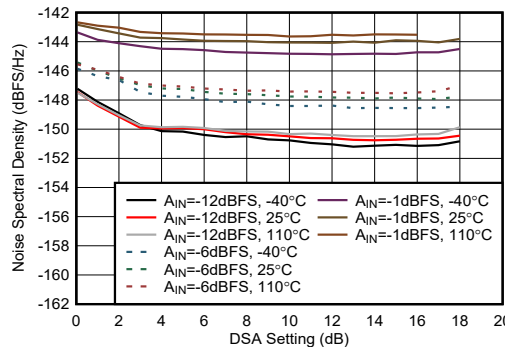


Figure 4-434. RX NSD vs DSA Setting at 8.11GHz



External clock mode

Figure 4-435. RX NSD vs DSA Setting at 8.11GHz

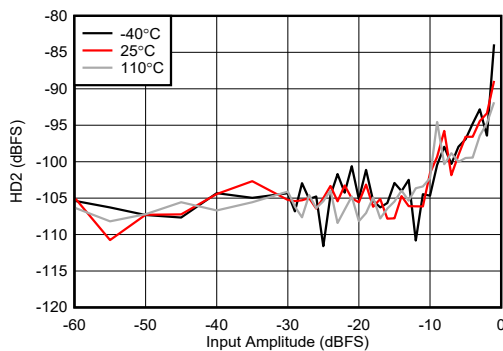


Figure 4-436. RX HD2 vs Digital Amplitude at 8.11GHz

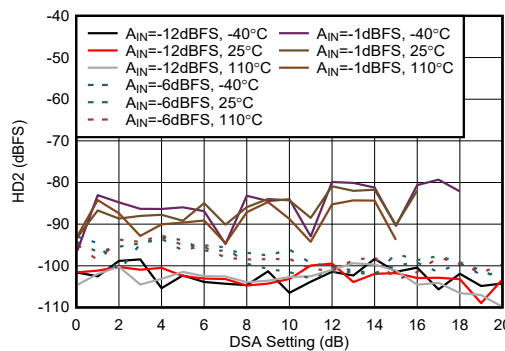


Figure 4-437. RX HD2 vs DSA Setting at 8.11GHz

### 4.12.13 RX Typical Characteristics at 8.1GHz (continued)

Typical values at  $T_A = +25^\circ\text{C}$ , ADC Sampling Rate = 2949.12MHz. Default conditions: output sample rate = 1474.56MSPS (decimate by 2), External clock mode with  $f_{\text{CLK}} = 11796.48\text{MHz}$ ,  $A_{\text{IN}} = -3\text{dBFS}$ , DSA setting = 3 dB, 8.1GHz matching.

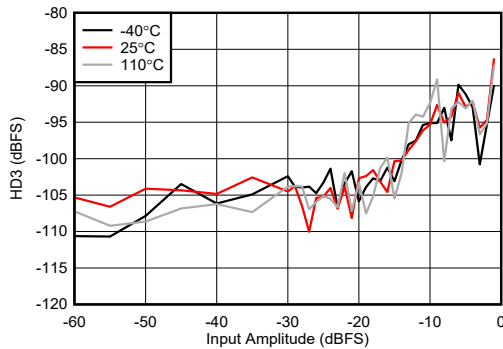


Figure 4-438. RX HD3 vs Digital Amplitude at 8.11GHz

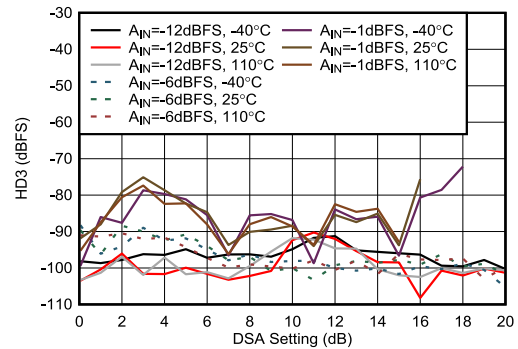


Figure 4-439. RX HD3 vs DSA Setting at 8.11GHz

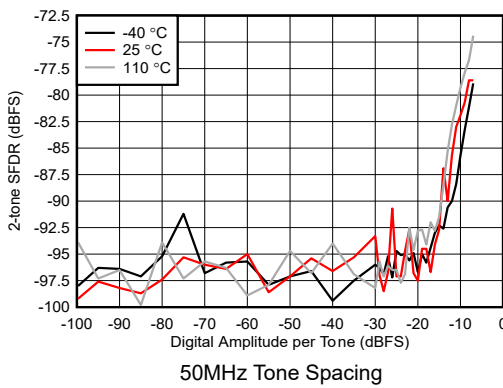


Figure 4-440. RX 2-tone SFDR vs Digital Amplitude at 8.11GHz

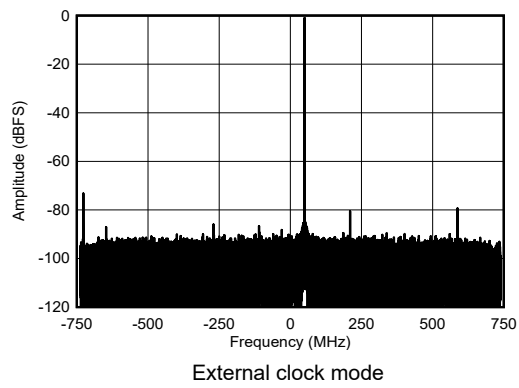


Figure 4-441. RX Single Tone Output FFT at 8.11GHz, -1dBFS

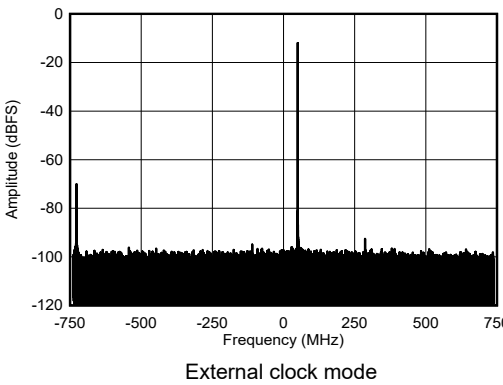


Figure 4-442. RX Single Tone Output FFT at 8.11GHz, -12dBFS

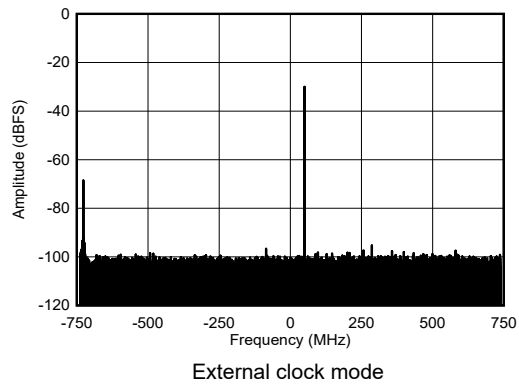
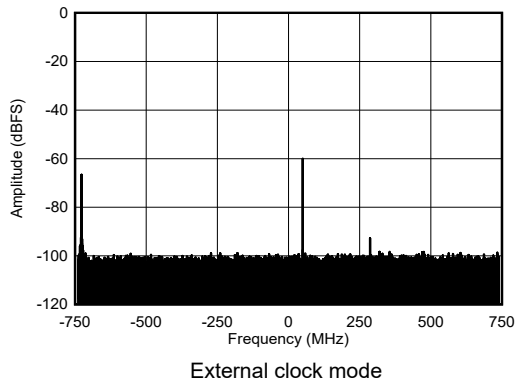


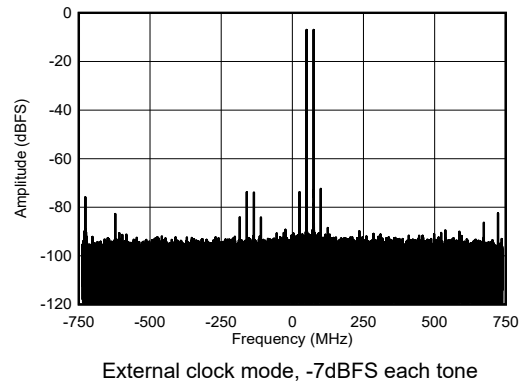
Figure 4-443. RX Single Tone Output FFT at 8.11GHz, -30 dBFS

**4.12.13 RX Typical Characteristics at 8.1GHz (continued)**

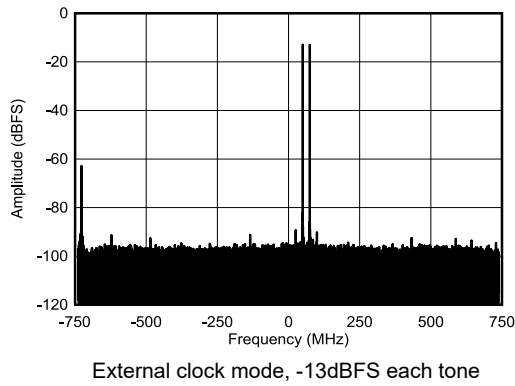
Typical values at  $T_A = +25^\circ\text{C}$ , ADC Sampling Rate = 2949.12MHz. Default conditions: output sample rate = 1474.56MSPS (decimate by 2), External clock mode with  $f_{\text{CLK}} = 11796.48\text{MHz}$ ,  $A_{\text{IN}} = -3\text{dBFS}$ , DSA setting = 3 dB, 8.1GHz matching.



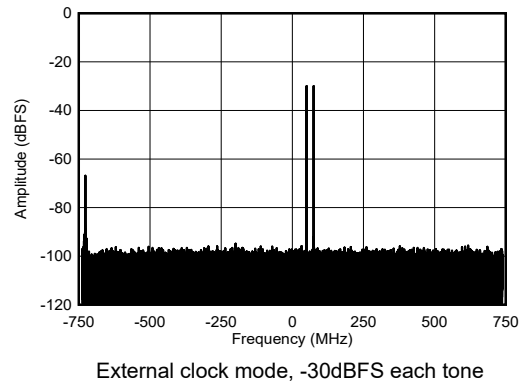
**Figure 4-444. RX Single Tone Output FFT at 8.11GHz, -60 dBFS**



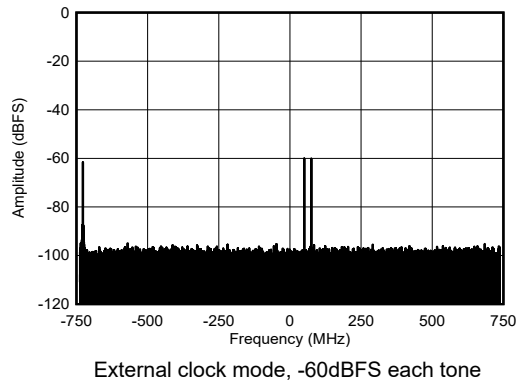
**Figure 4-445. RX Dual Tone Output FFT at 8.11GHz**



**Figure 4-446. RX Dual Tone Output FFT at 8.11GHz**



**Figure 4-447. RX Dual Tone Output FFT at 8.11GHz**



**Figure 4-448. RX Dual Tone Output FFT at 8.11GHz**

### 4.12.14 RX Typical Characteristics at 9.6GHz

Typical values at  $T_A = +25^\circ\text{C}$ , ADC Sampling Rate = 2949.12MHz. Default conditions: output sample rate = 1474.56MSPS (decimate by 2), External clock mode with  $f_{\text{CLK}} = 11796.48\text{MHz}$ ,  $A_{\text{IN}} = -3\text{dBFS}$ , DSA setting = 3 dB, 9.6GHz matching.

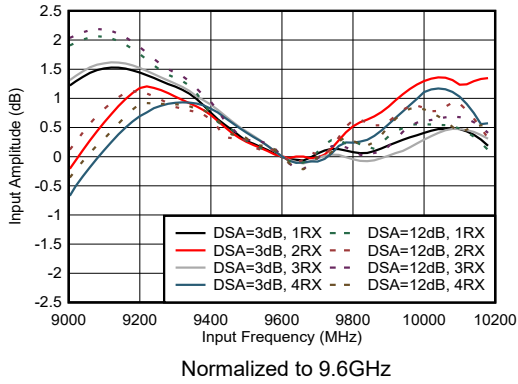


Figure 4-449. RX Input Amplitude vs Frequency

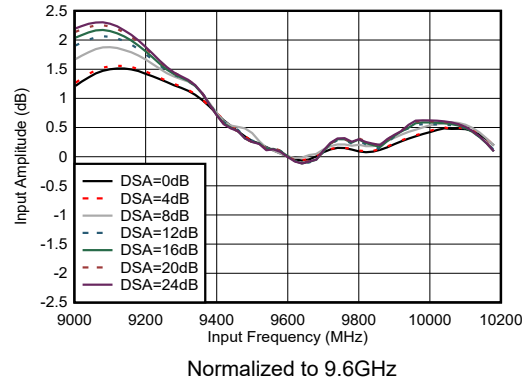


Figure 4-450. RX Input Amplitude vs Frequency at 9.6GHz

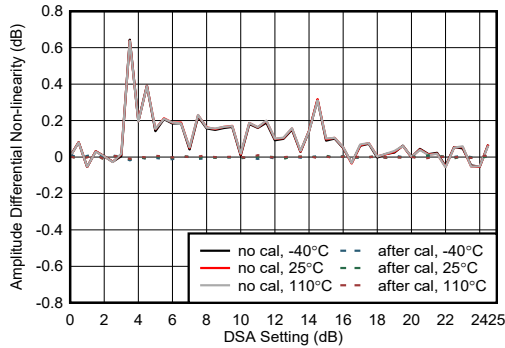


Figure 4-451. RX Amplitude Differential Non-linearity at 9.6GHz

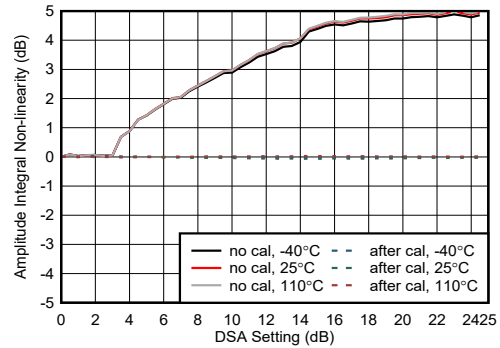


Figure 4-452. RX Amplitude Integrated Non-linearity at 9.6GHz

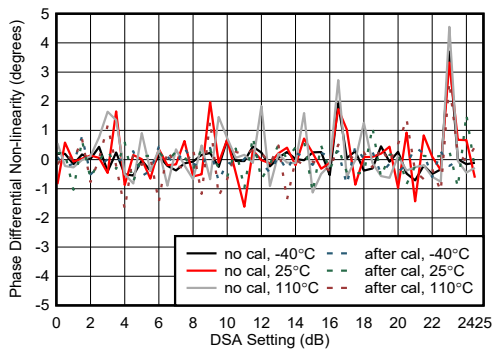


Figure 4-453. RX Phase Differential Non-linearity at 9.6GHz

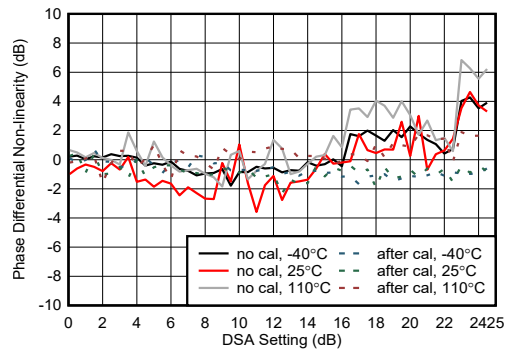
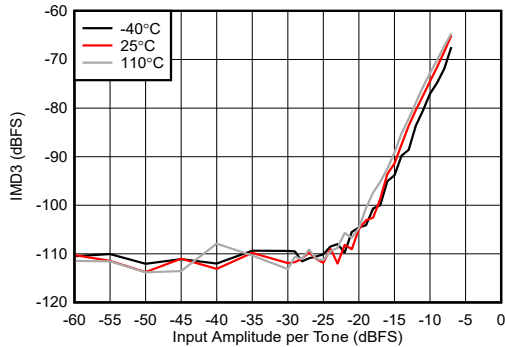


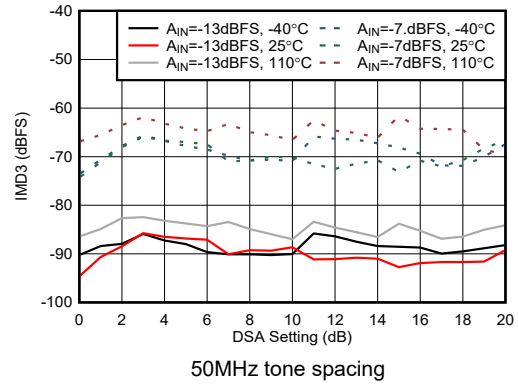
Figure 4-454. RX Phase Integrated Non-linearity at 9.6GHz

**4.12.14 RX Typical Characteristics at 9.6GHz (continued)**

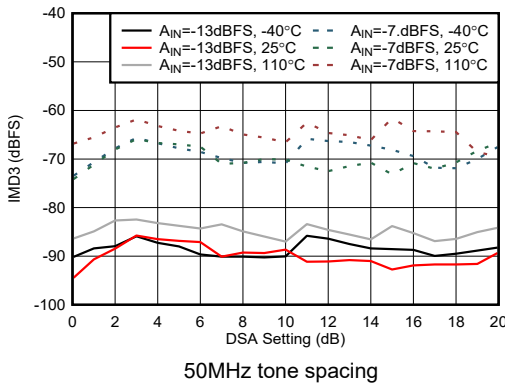
Typical values at  $T_A = +25^\circ\text{C}$ , ADC Sampling Rate = 2949.12MHz. Default conditions: output sample rate = 1474.56MSPS (decimate by 2), External clock mode with  $f_{\text{CLK}} = 11796.48\text{MHz}$ ,  $A_{\text{IN}} = -3\text{dBFS}$ , DSA setting = 3 dB, 9.6GHz matching.



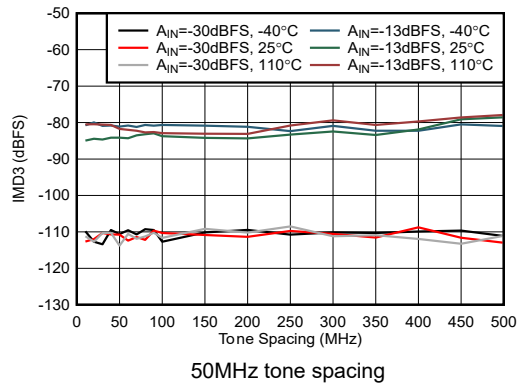
**Figure 4-455. RX IMD3 vs Digital Amplitude at 9.6GHz**



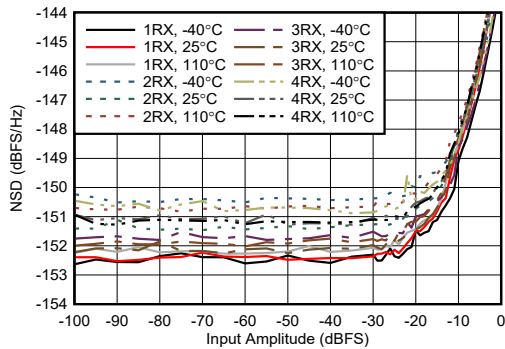
**Figure 4-456. RX IMD3 vs DSA Setting at 9.6GHz**



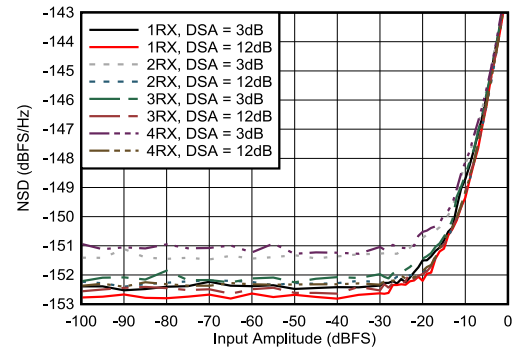
**Figure 4-457. RX IMD3 vs DSA Setting at 9.6GHz**



**Figure 4-458. RX IMD3 vs Tone Spacing at 9.6GHz**



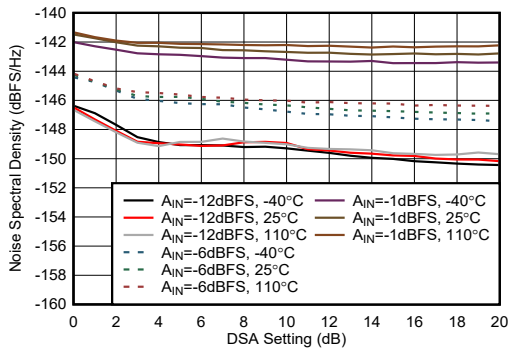
**Figure 4-459. RX NSD vs Digital Amplitude at 9.6GHz**



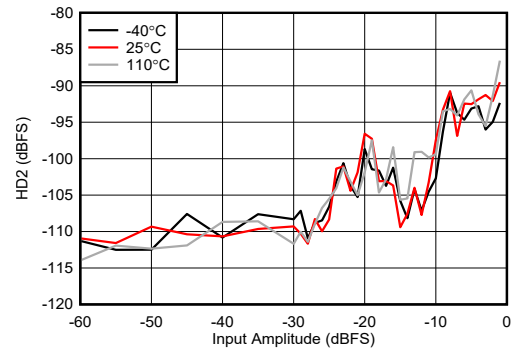
**Figure 4-460. RX NSD vs Digital Amplitude at 9.6GHz**

**4.12.14 RX Typical Characteristics at 9.6GHz (continued)**

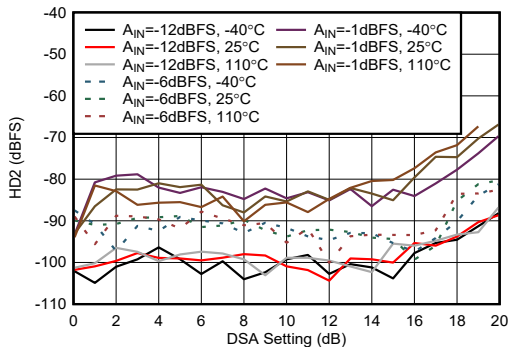
Typical values at  $T_A = +25^\circ\text{C}$ , ADC Sampling Rate = 2949.12MHz. Default conditions: output sample rate = 1474.56MSPS (decimate by 2), External clock mode with  $f_{\text{CLK}} = 11796.48\text{MHz}$ ,  $A_{\text{IN}} = -3\text{dBFS}$ , DSA setting = 3 dB, 9.6GHz matching.



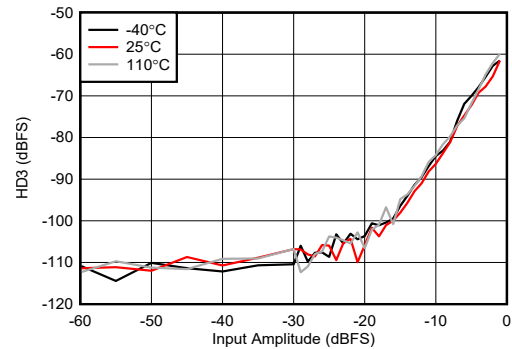
**Figure 4-461. RX NSD vs DSA Setting at 9.6GHz**



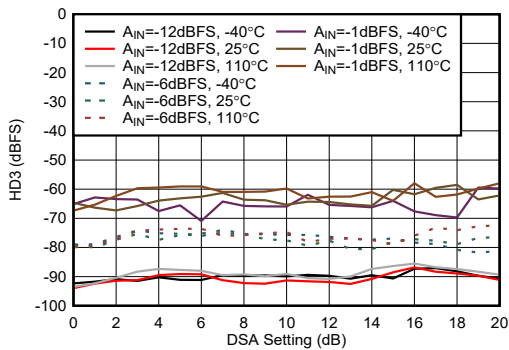
**Figure 4-462. RX HD2 vs Digital Level at 9.6GHz**



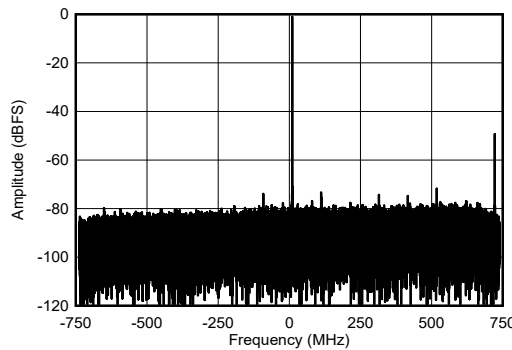
**Figure 4-463. RX HD2 vs DSA Setting at 9.6GHz**



**Figure 4-464. RX HD3 vs Digital Level at 9.6GHz**



**Figure 4-465. RX HD3 vs DSA Setting at 9.6GHz**

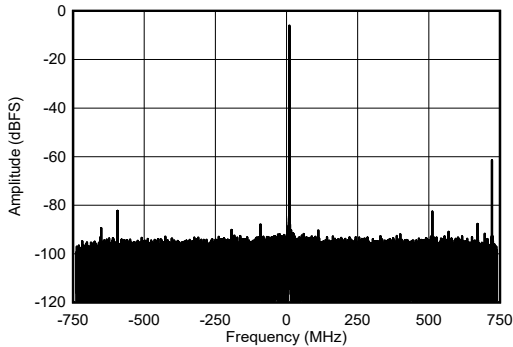


-1dBFS

**Figure 4-466. RX Single Tone Output FFT at 9.61 GHz**

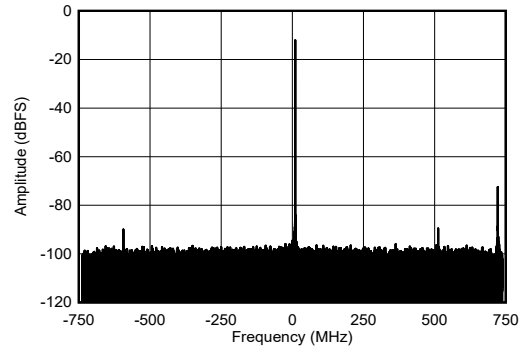
**4.12.14 RX Typical Characteristics at 9.6GHz (continued)**

Typical values at  $T_A = +25^\circ\text{C}$ , ADC Sampling Rate = 2949.12MHz. Default conditions: output sample rate = 1474.56MSPS (decimate by 2), External clock mode with  $f_{\text{CLK}} = 11796.48\text{MHz}$ ,  $A_{\text{IN}} = -3\text{dBFS}$ , DSA setting = 3 dB, 9.6GHz matching.



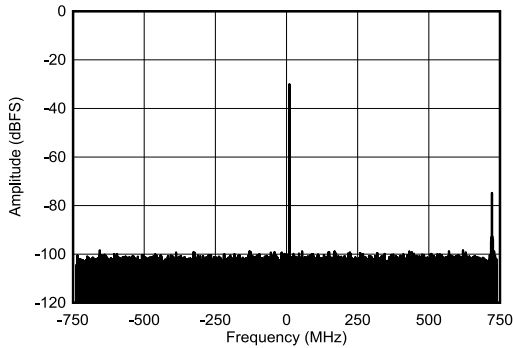
-6dBFS

**Figure 4-467. RX Single Tone Output FFT at 9.61GHz**



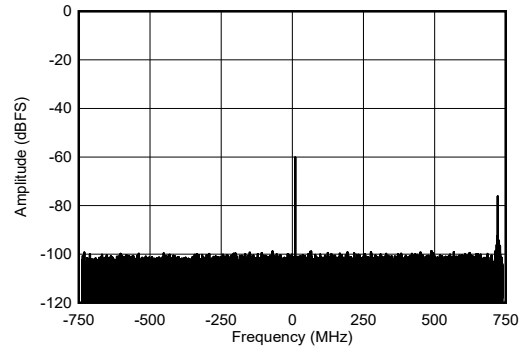
-12 dBFS.

**Figure 4-468. RX Single Tone Output FFT at 9.61GHz**



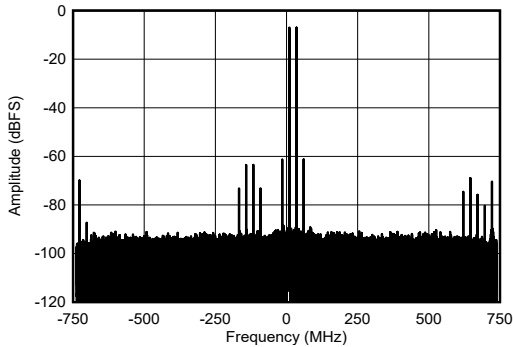
-30dBFS

**Figure 4-469. RX Single Tone Output FFT at 9.61GHz**



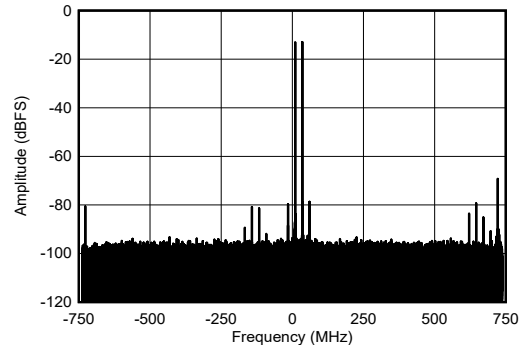
-60 dBFS

**Figure 4-470. RX Single Tone Output FFT at 9.61GHz**



9.61 and 9.635GHz, -7dBFS each tone

**Figure 4-471. RX Two Tone Output FFT at 9.61GHz**

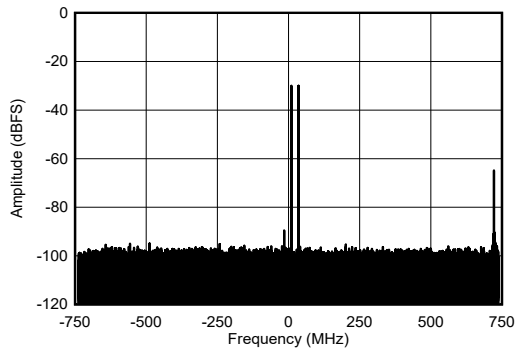


9.61 and 9.635GHz, -13dBFS each tone

**Figure 4-472. RX Two Tone Output FFT at 9.61GHz**

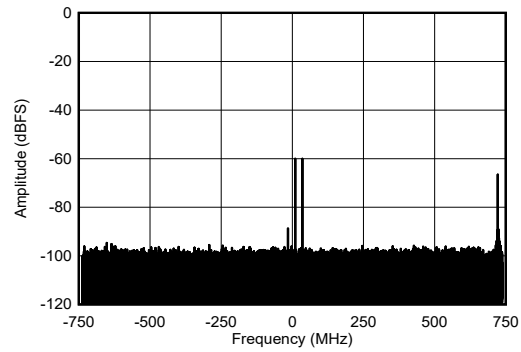
**4.12.14 RX Typical Characteristics at 9.6GHz (continued)**

Typical values at  $T_A = +25^\circ\text{C}$ , ADC Sampling Rate = 2949.12MHz. Default conditions: output sample rate = 1474.56MSPS (decimate by 2), External clock mode with  $f_{\text{CLK}} = 11796.48\text{MHz}$ ,  $A_{\text{IN}} = -3\text{dBFS}$ , DSA setting = 3 dB, 9.6GHz matching.



9.61 and 9.635GHz, -30dBFS each tone

**Figure 4-473. RX Two Tone Output FFT at 9.61GHz**



9.61 and 9.635GHz, -60dBFS each tone

**Figure 4-474. RX Two Tone Output FFT at 9.61GHz**

## 5 Device and Documentation Support

### 5.1 Receiving Notification of Documentation Updates

To receive notification of documentation updates, navigate to the device product folder on [ti.com](https://www.ti.com). Click on *Notifications* to register and receive a weekly digest of any product information that has changed. For change details, review the revision history included in any revised document.

### 5.2 Support Resources

[TI E2E™ support forums](#) are an engineer's go-to source for fast, verified answers and design help — straight from the experts. Search existing answers or ask your own question to get the quick design help you need.

Linked content is provided "AS IS" by the respective contributors. They do not constitute TI specifications and do not necessarily reflect TI's views; see TI's [Terms of Use](#).

### 5.3 Trademarks

TI E2E™ is a trademark of Texas Instruments.  
All trademarks are the property of their respective owners.

### 5.4 Electrostatic Discharge Caution



This integrated circuit can be damaged by ESD. Texas Instruments recommends that all integrated circuits be handled with appropriate precautions. Failure to observe proper handling and installation procedures can cause damage.

ESD damage can range from subtle performance degradation to complete device failure. Precision integrated circuits may be more susceptible to damage because very small parametric changes could cause the device not to meet its published specifications.

### 5.5 Glossary

[TI Glossary](#) This glossary lists and explains terms, acronyms, and definitions.

## 6 Revision History

NOTE: Page numbers for previous revisions may differ from page numbers in the current version.

| <b>Changes from Revision A (August 2024) to Revision B (June 2026)</b> | <b>Page</b> |
|--|-------------|
| • Changed Space Screening and Assurance in <i>Features</i> .....       | 1           |
| • Deleted Product Preview note from AFE7950-SEP.....                   | 1           |

| <b>Changes from Revision * (March 2024) to Revision A (August 2024)</b>                       | <b>Page</b> |
|---|-------------|
| • Changed the RF frequency range from 10.2GHz to 12GHz (typical) in the <i>Features</i> ..... | 1           |
| • Changed the RF frequency range from 10.2GHz to 12GHz in the <i>Description</i> .....        | 1           |
| • Changed the RF frequency range to 12000MHz.....   | 6           |
| • Changed the RF frequency range to 12000MHz.....   | 13          |

## 7 Mechanical, Packaging, and Orderable Information

The following pages include mechanical, packaging, and orderable information. This information is the most current data available for the designated devices. This data is subject to change without notice and revision of this document. For browser-based versions of this data sheet, refer to the left-hand navigation.

**PACKAGING INFORMATION**

| Orderable part number         | Status<br>(1) | Material type<br>(2) | Package   Pins    | Package qty   Carrier | RoHS<br>(3) | Lead finish/<br>Ball material<br>(4) | MSL rating/<br>Peak reflow<br>(5) | Op temp (°C) | Part marking<br>(6)  |
|-------------------------------|---------------|----------------------|-------------------|-----------------------|-------------|--------------------------------------|-----------------------------------|--------------|----------------------|
| <a href="#">AFE7950ALKSHP</a> | Active        | Production           | FCBGA (ALK)   400 | 90   JEDEC TRAY (5+1) | No          | Call TI                              | Call TI                           | -40 to 85    | AFE7950SHP<br>SNPB   |
| <a href="#">SN0400ALK-DC</a>  | Active        | Production           | FCBGA (ALK)   400 | 90   JEDEC TRAY (5+1) | -           | Call TI                              | Call TI                           | -45 to 105   | AFE7950ALKDC<br>SNPB |

(1) **Status:** For more details on status, see our [product life cycle](#).

(2) **Material type:** When designated, preproduction parts are prototypes/experimental devices, and are not yet approved or released for full production. Testing and final process, including without limitation quality assurance, reliability performance testing, and/or process qualification, may not yet be complete, and this item is subject to further changes or possible discontinuation. If available for ordering, purchases will be subject to an additional waiver at checkout, and are intended for early internal evaluation purposes only. These items are sold without warranties of any kind.

(3) **RoHS values:** Yes, No, RoHS Exempt. See the [TI RoHS Statement](#) for additional information and value definition.

(4) **Lead finish/Ball material:** Parts may have multiple material finish options. Finish options are separated by a vertical ruled line. Lead finish/Ball material values may wrap to two lines if the finish value exceeds the maximum column width.

(5) **MSL rating/Peak reflow:** The moisture sensitivity level ratings and peak solder (reflow) temperatures. In the event that a part has multiple moisture sensitivity ratings, only the lowest level per JEDEC standards is shown. Refer to the shipping label for the actual reflow temperature that will be used to mount the part to the printed circuit board.

(6) **Part marking:** There may be an additional marking, which relates to the logo, the lot trace code information, or the environmental category of the part.

Multiple part markings will be inside parentheses. Only one part marking contained in parentheses and separated by a "-" will appear on a part. If a line is indented then it is a continuation of the previous line and the two combined represent the entire part marking for that device.

**Important Information and Disclaimer:**The information provided on this page represents TI's knowledge and belief as of the date that it is provided. TI bases its knowledge and belief on information provided by third parties, and makes no representation or warranty as to the accuracy of such information. Efforts are underway to better integrate information from third parties. TI has taken and continues to take reasonable steps to provide representative and accurate information but may not have conducted destructive testing or chemical analysis on incoming materials and chemicals. TI and TI suppliers consider certain information to be proprietary, and thus CAS numbers and other limited information may not be available for release.

In no event shall TI's liability arising out of such information exceed the total purchase price of the TI part(s) at issue in this document sold by TI to Customer on an annual basis.

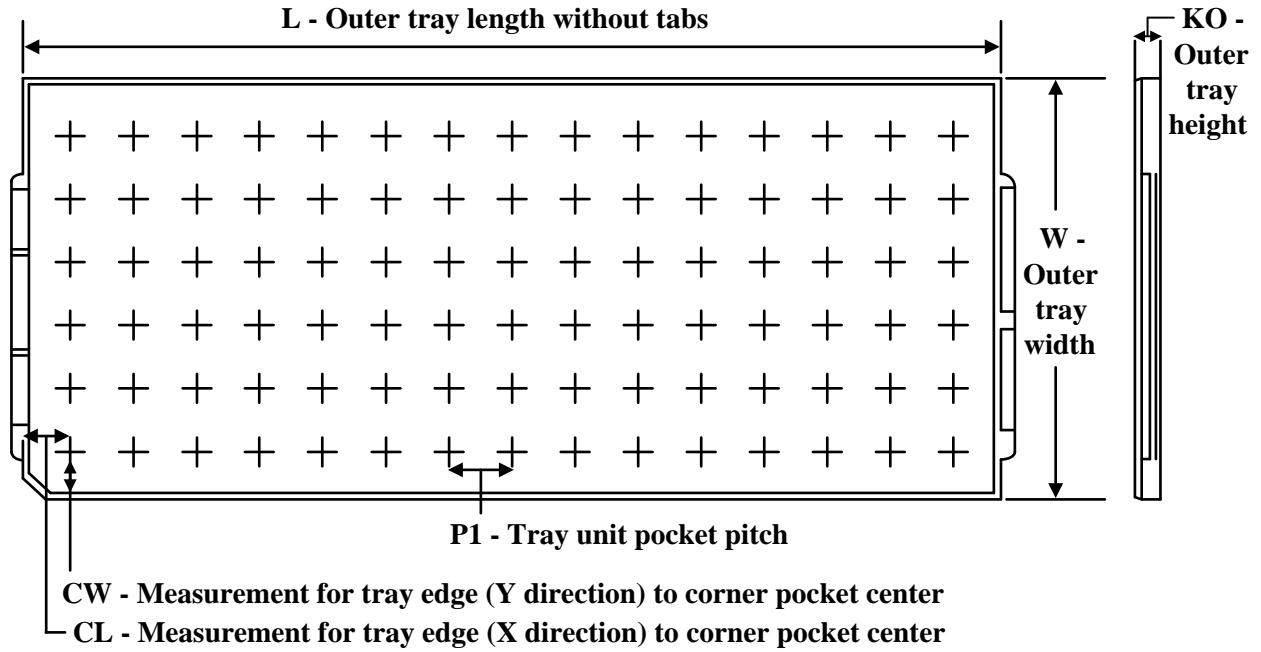
**OTHER QUALIFIED VERSIONS OF AFE7950-SP :**

- Catalog : [AFE7950](#)

NOTE: Qualified Version Definitions:

- Catalog - TI's standard catalog product

**TRAY**



Chamfer on Tray corner indicates Pin 1 orientation of packed units.

\*All dimensions are nominal

| Device        | Package Name | Package Type | Pins | SPQ | Unit array matrix | Max temperature (°C) | L (mm) | W (mm) | K0 (µm) | P1 (mm) | CL (mm) | CW (mm) |
|---------------|--------------|--------------|------|-----|-------------------|----------------------|--------|--------|---------|---------|---------|---------|
| AFE7950ALKSHP | ALK          | FCBGA        | 400  | 90  | 6 x 15            | 150                  | 315    | 135.9  | 7620    | 19.5    | 21      | 19.2    |

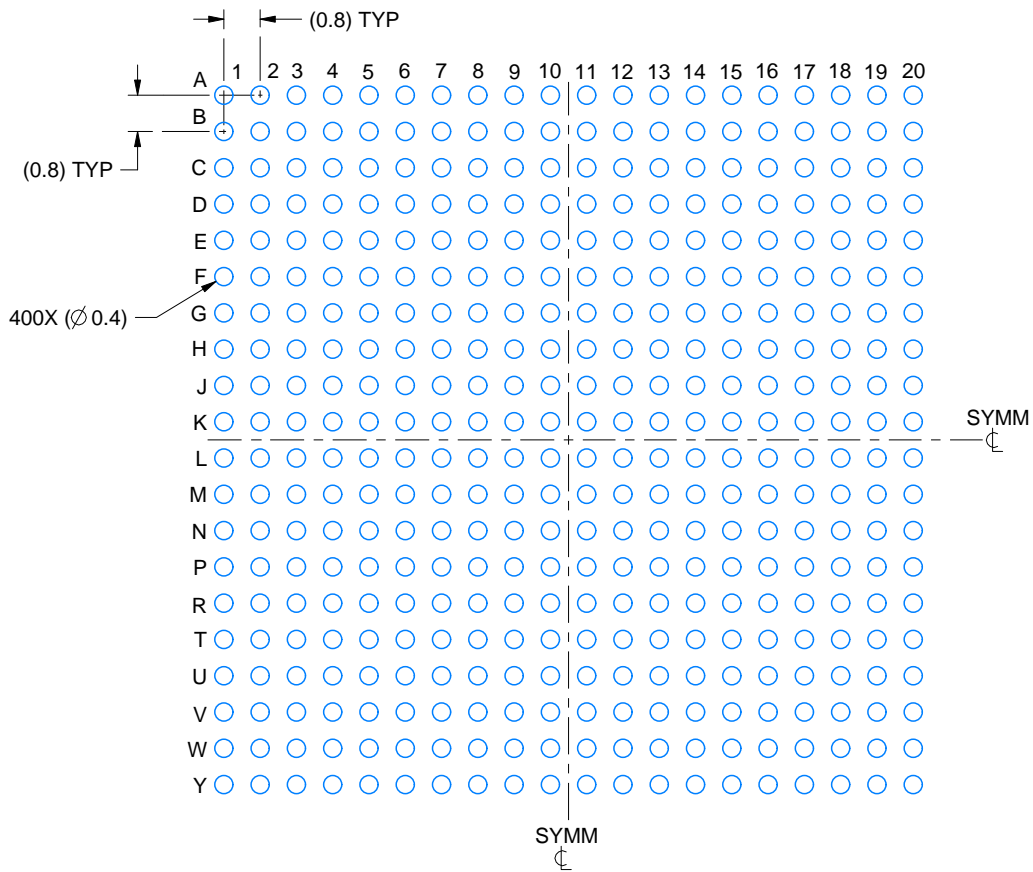


# EXAMPLE BOARD LAYOUT

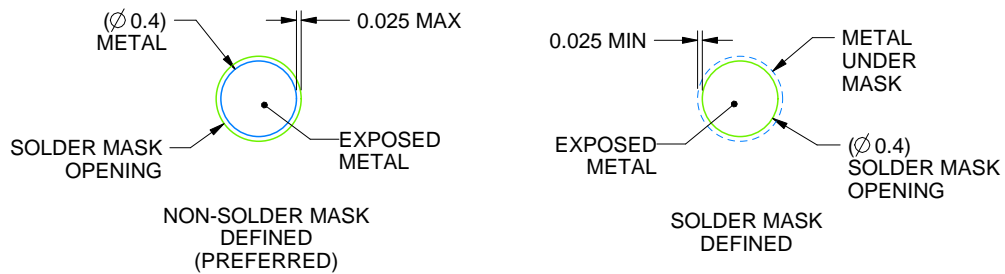
ALK0400A

FCBGA - 2.65 mm max height

BALL GRID ARRAY



LAND PATTERN EXAMPLE  
EXPOSED METAL SHOWN  
SCALE:6X



SOLDER MASK DETAILS  
NOT TO SCALE

4225930/C 03/2023

NOTES: (continued)

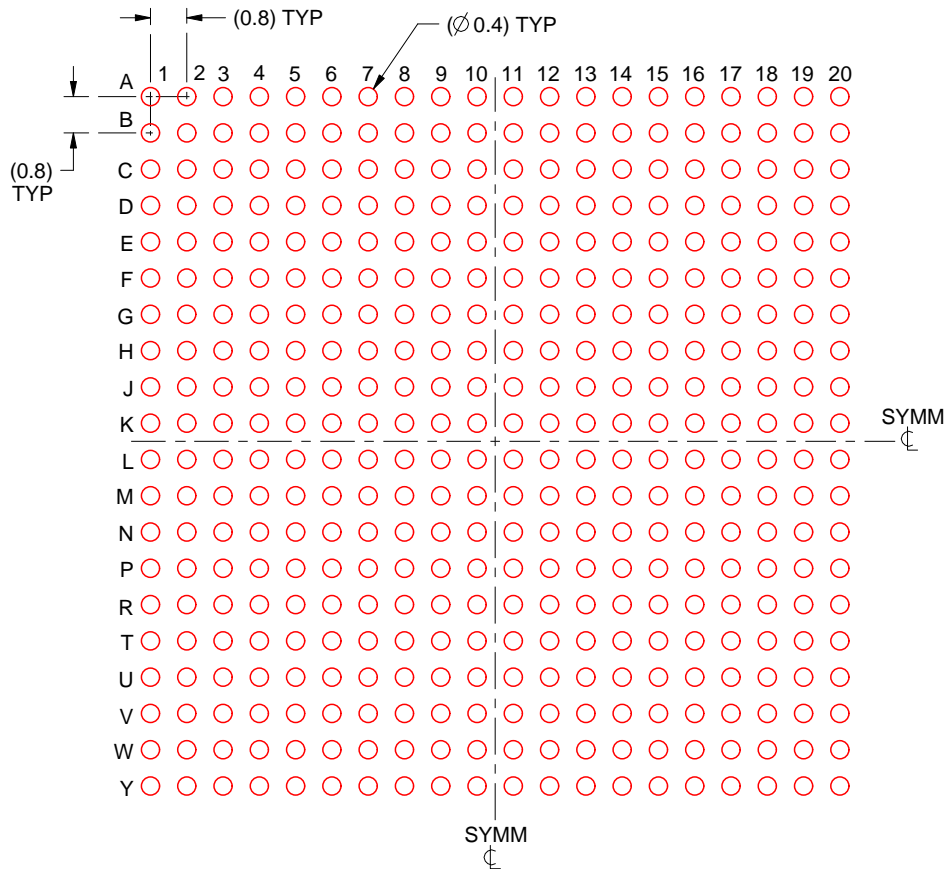
- Final dimensions may vary due to manufacturing tolerance considerations and also routing constraints. For more information, see Texas Instruments literature number SPRU811 ([www.ti.com/lit/spru811](http://www.ti.com/lit/spru811)).

# EXAMPLE STENCIL DESIGN

## ALK0400A

## FCBGA - 2.65 mm max height

BALL GRID ARRAY



SOLDER PASTE EXAMPLE  
BASED ON 0.15 mm THICK STENCIL  
SCALE:6X

4225930/C 03/2023

NOTES: (continued)

8. Laser cutting apertures with trapezoidal walls and rounded corners may offer better paste release.

## IMPORTANT NOTICE AND DISCLAIMER

TI PROVIDES TECHNICAL AND RELIABILITY DATA (INCLUDING DATASHEETS), DESIGN RESOURCES (INCLUDING REFERENCE DESIGNS), APPLICATION OR OTHER DESIGN ADVICE, WEB TOOLS, SAFETY INFORMATION, AND OTHER RESOURCES "AS IS" AND WITH ALL FAULTS, AND DISCLAIMS ALL WARRANTIES, EXPRESS AND IMPLIED, INCLUDING WITHOUT LIMITATION ANY IMPLIED WARRANTIES OF MERCHANTABILITY, FITNESS FOR A PARTICULAR PURPOSE OR NON-INFRINGEMENT OF THIRD PARTY INTELLECTUAL PROPERTY RIGHTS.

These resources are intended for skilled developers designing with TI products. You are solely responsible for (1) selecting the appropriate TI products for your application, (2) designing, validating and testing your application, and (3) ensuring your application meets applicable standards, and any other safety, security, regulatory or other requirements.

These resources are subject to change without notice. TI grants you permission to use these resources only for development of an application that uses the TI products described in the resource. Other reproduction and display of these resources is prohibited. No license is granted to any other TI intellectual property right or to any third party intellectual property right. TI disclaims responsibility for, and you fully indemnify TI and its representatives against any claims, damages, costs, losses, and liabilities arising out of your use of these resources.

TI's products are provided subject to [TI's Terms of Sale](#), [TI's General Quality Guidelines](#), or other applicable terms available either on [ti.com](http://ti.com) or provided in conjunction with such TI products. TI's provision of these resources does not expand or otherwise alter TI's applicable warranties or warranty disclaimers for TI products. Unless TI explicitly designates a product as custom or customer-specified, TI products are standard, catalog, general purpose devices.

TI objects to and rejects any additional or different terms you may propose.

Copyright © 2026, Texas Instruments Incorporated

Last updated 10/2025