



Affordable, Flexible Smart Home & Industrial Displays Using 0.2 nHD EVM DLP Pico Technology

Philippe Dollo

Application Engineer

DLP® Pico Projection

DLP® Products

DLP LightCrafter 2000 EVM

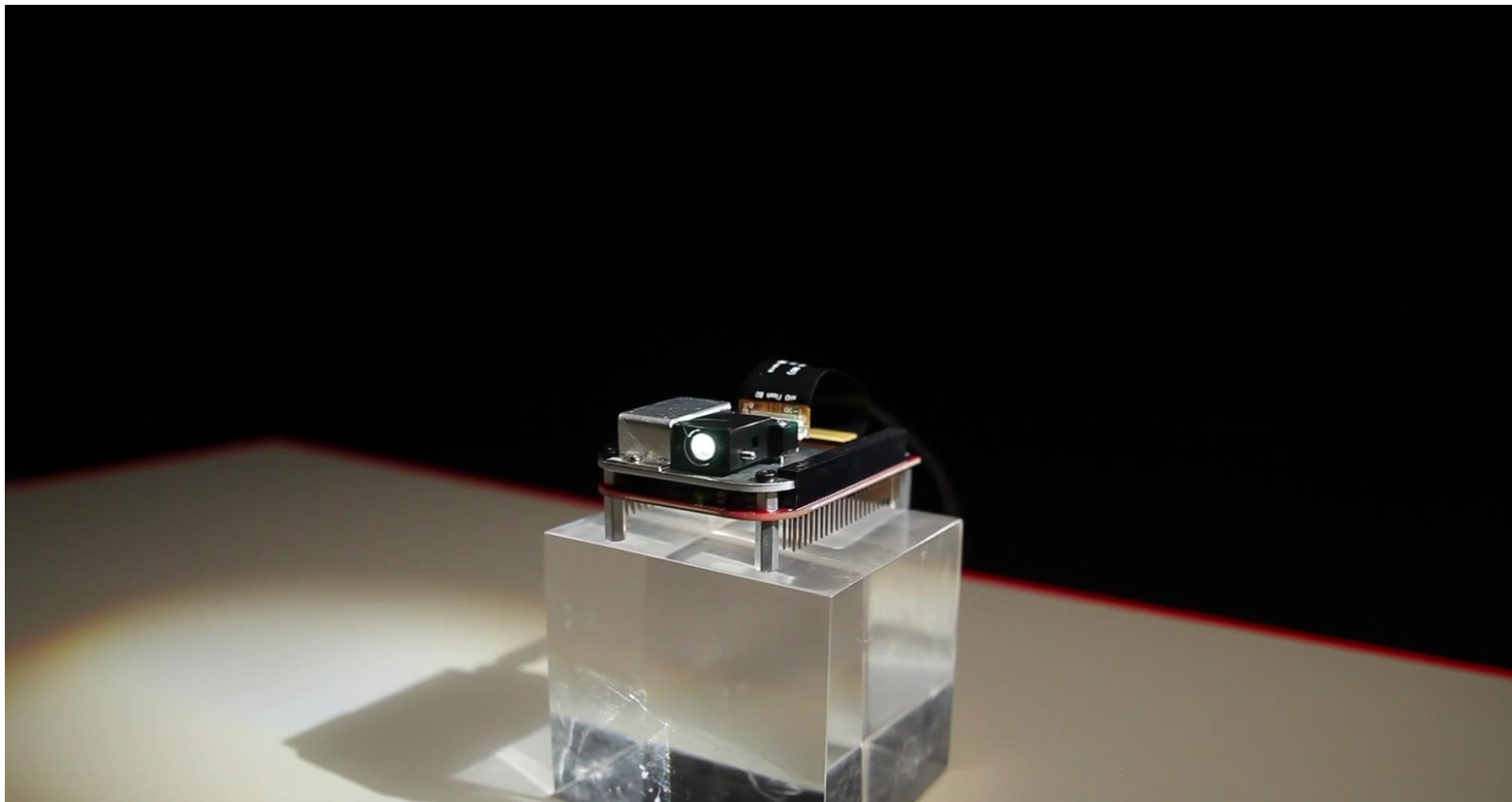

Agenda

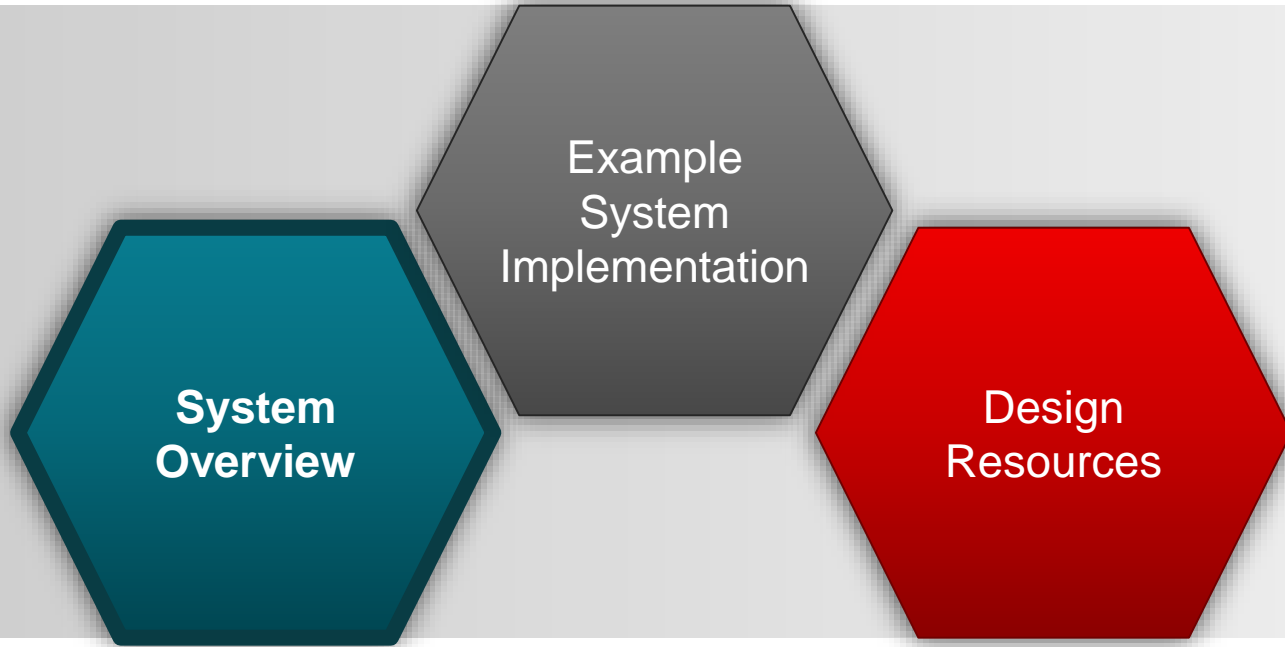

DLP2000 chipset and the DLP LightCrafter™ display 2000





Limitless display possibilities

16:9 aspect ratio

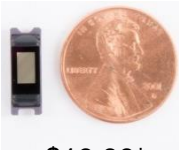

Developer friendly



\$19.99*



\$99

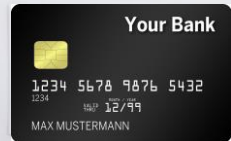

Your Bank

1234 5678 9876 5432
1234 12/99
MAX MUSTERMANN



Small form factors

Designed for low-cost processors



Power efficiency

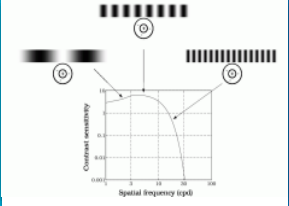

* Suggested resale price for 1ku per year

DLP2000 system applications

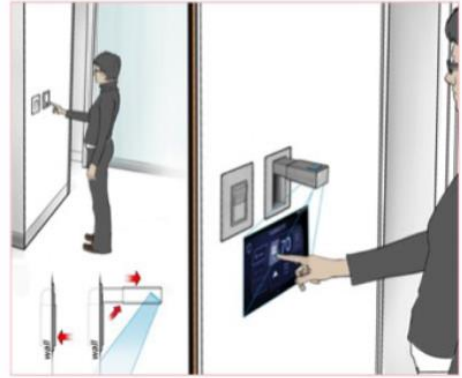
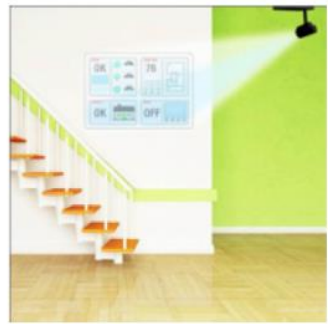

DLP2000 display interactivity

	Stereo vision	Structured light		Time of flight
		Fixed pattern	Programmable pattern	
Cost	Low	Mid-high	High	Medium
Depth accuracy	Low (mm-cm)	Mid-high (mm-cm)	High ($\mu\text{m-cm}$)	Medium (mm-cm)
Response time	Medium (limited by S/W)	Slow (limited by camera speed)	Slow (Limited by camera speed)	Fast (limited by sensor speed)
Distance range	Mid-range	Short to Mid-range (depends on illumination power)	Short to Mid-range (depends on illumination power)	Short to long range (depend on laser/ led power power)
Low light performance	Weak	Good	Good	Good
Bright light performance	Good	Weak/fair	Weak/fair	Good
Software Complexity	High	Low/medium	Medium	Low

- [TI DLP® Pico™ technology for smart home applications](#) white paper

DLPDLCR2000

TIDA-01473



Features

- Achieves ~20 lumens in “credit-card sized” form factor
- Provides simplistic interface to embedded host processors (BeagleBone Black, Raspberry Pi, etc.)
- Implements DLP chipset technology using low-cost optimized BOM (<\$99)

Applications

- Smart-home and industrial automation
- Internet-of-things (IoT) projects
- Low-power, portable display applications

Tools & Resources

- **TIDA-01473**
- **Design Guide**
- **Design Files:** Schematics, BOM, Gerbers, Software, etc.
- **Device Datasheets:**
 - DLPC2607
 - DLPA1000
 - DLP2000 (DMD)

Benefits

- Low cost provides design accessibility
- Strong compatibility with TI-owned SITARA processor line
- Simplicity enables quick turnaround of user-made designs

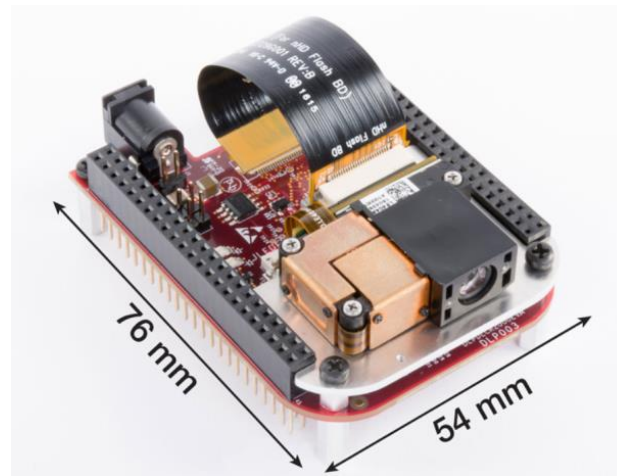

System Block Diagram

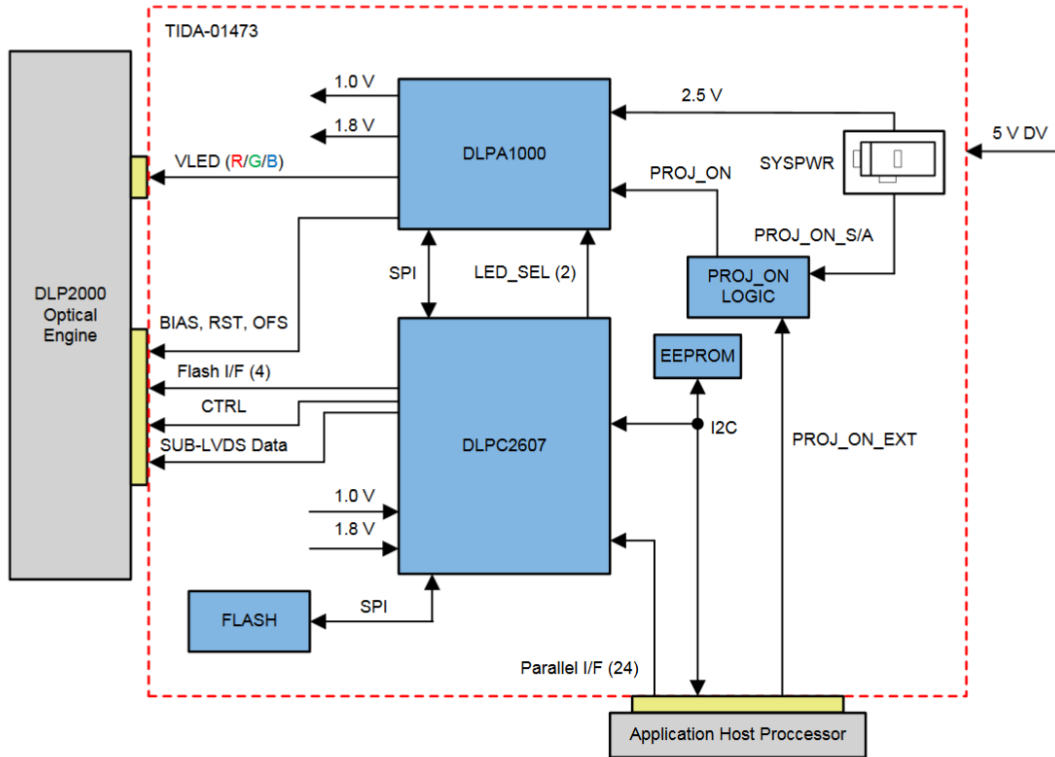

Copyright © 2017, Texas Instruments Incorporated

Associated Reference Designs

<http://www.ti.com/tool/TIDA-01473>

DLP Products in this System

<http://www.ti.com/product/DLPC2607>

<http://www.ti.com/product/DLPA1000>

<http://www.ti.com/product/DLP2000>

Plus 6 Additional TI Products

SN74LVC1G125DC -- Buffer

TPS71501DC -- Regulator

SN74AUP1G06DC – Inverter Buffer

TLV809I50DBZ – Voltage Supervisor

SN74LVC1G3208DCKR – OR-AND Logic IC

TPS22929DDBV – IC Load Switch

Agenda

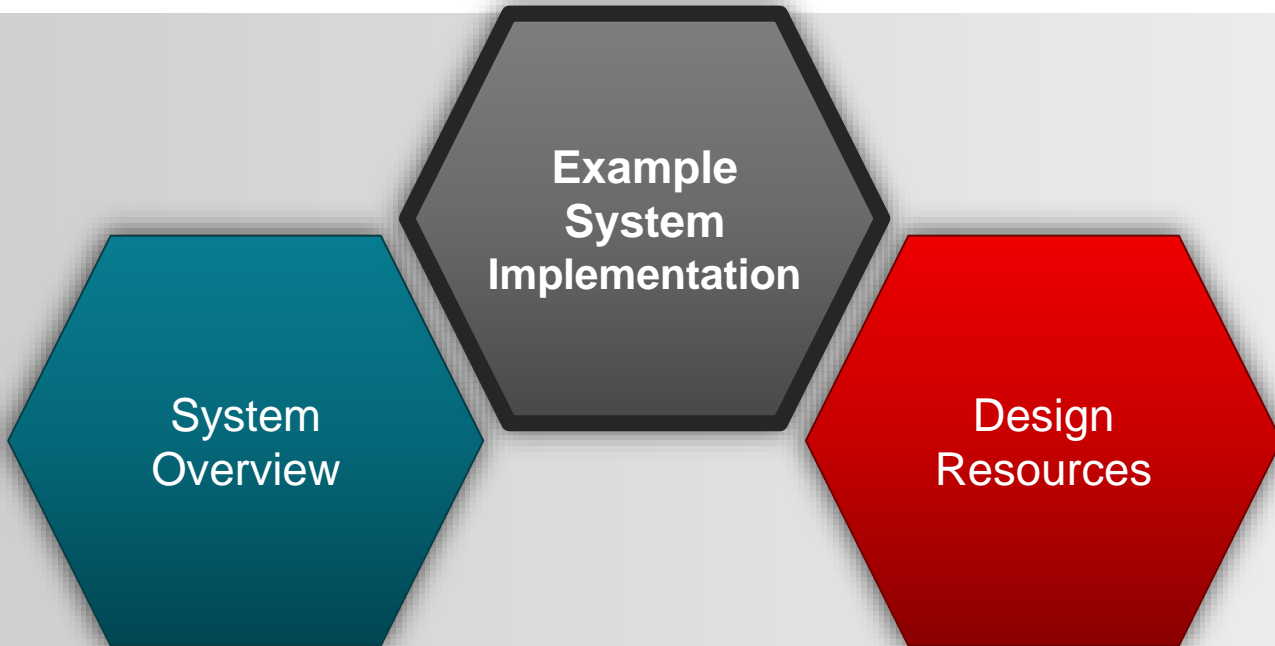

Getting started

- To setup a complete system, you will need the following:
 - DLPDLCR2000EVM
 - [Download](#) the user's guide
 - EVM Power Supply
 - 5V, 3A Rated (PW172KB0503F01 ITE Switch Mode Power Supply or equivalent is recommended)
 - BeagleBone Black (with miniUSB Type-B Cable), or other host processor
 - microSD Card (4GB or greater)



Debian setup

- An up-to-date release of Debian with driver support for the DLP2000 EVM can be downloaded from:
 - <http://beagleboard.org/latest-images> (Debian Jessie v8.9 Recommended)
- SDFormatter and Win32DiskImager are **Windows** tools that can prepare the SD Card with Debian to be installed on the BeagleBone Black
 - https://www.sdcard.org/downloads/formatter_4/
 - <https://sourceforge.net/projects/win32diskimager/>
- On **Mac/Linux**, we can skip this step as proper SD card formatting is natively supported (using fdisk)
- From here, the BeagleBone Black software should be installed onto the SD card using your preferred method and operating system

Terminal setup

- After socketing the EVM into the BeagleBone Black's header ports, plug in the EVM to its power supply and the BeagleBone Black to a PC via USB
- Launch your preferred SSH terminal client (such as PuTTY) to access the BeagleBone Black Linux system:
 - Host Name: 192.168.7.2:22
 - Username: debian Password: tempwd
- Once logged into the SSH session, it is recommended that the Debian system be updated:
 - ~\$ sudo apt-get update
 - ~\$ sudo apt-get upgrade
 - ~\$ sudo apt-get install mplayer2
- Mplayer will be used for demo purposes later



Basic I2C communication

- Using the built-in I2C tools, we can communicate with the EVM using the BeagleBone Black:

```
debian@beaglebone:~$ i2cset -y 2 0x1b 0x0b 0x00 0x00 0x00 0x00 1
debian@beaglebone:~$ i2cset -y 2 0x1b 0x0c 0x00 0x00 0x00 0x1b i
```

I2C Bus #	Device Address	Device Register	Data	Mode
2	0x1b	0x0c	0x00 0x00 0x00	i

- More information on commands available in DLPC2607 Programmer’s Guide (<http://www.ti.com/lit/pdf/dlpu013>)
- The above commands will switch the EVM to the external display (BeagleBone Black) and adjust display resolution
- I2C commands can be issued to the EVM at any time to manipulate operation, including brightness, video patterns, and resolution settings

Python demonstration scripts

- Debian Jessie (for the BeagleBone Black) features Python scripts created to demo various key features of the EVM
 - Video playback tests require mplayer to function
- To install these scripts, navigate to the install directory and execute:
 - ~\$ cd /opt/scripts/device/bone/capes/DLPDLCR2000/
 - ~\$ tar -xvf dlp_lightcrafter-1.0.19.tar.gz
 - ~\$ cd dlp_lightcrafter-1.0.19
 - ~\$ sudo python setup.py install
- Included video scripts feature tests demonstrating LED brightness, test patterns, resolution, and system status commands
- [Github repository available](#) to download for general use

Video playback using X11

- The fishbowl video (shown in promotional material) is available for playback as one of the Python test scripts
- In the SSH terminal, do:
 - ~\$ export DISPLAY=:0
 - ~\$ cd /opt/scripts/device/bone/capes/DLPDLCR2000/
 - ~\$ python MplayerTest.py
- Using black on the DLPDLCR2000EVM (and other DLP products) allows for freeform displays, as demonstrated in this video



Agenda

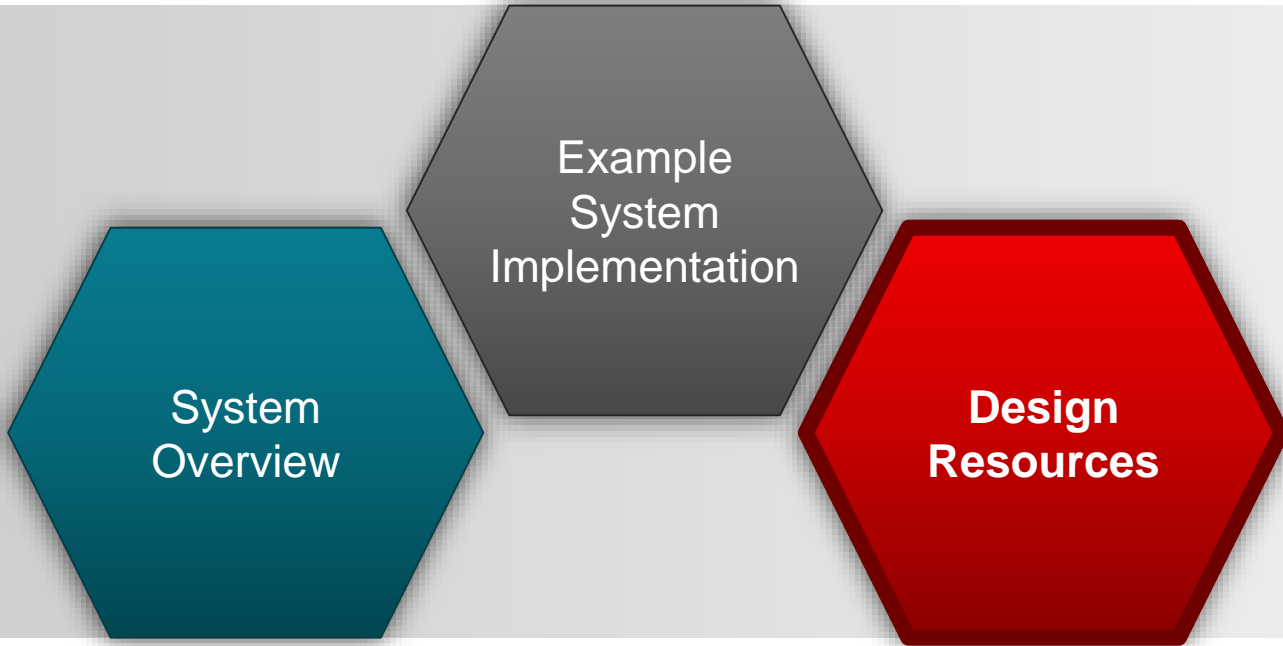

TI.com resources and links

- 0.2 nHD Chipset Documentation:
 - [DLPC2607 Pico Processor ASIC Datasheet](#)
 - [DLPA1000 Power Management and LED Driver Datasheet](#)
 - [DLP2000 DMD Datasheet](#)
 - [DLPC2607 Software Programmer's Guide](#)
- EVM Documentation:
 - [DLP LightCrafter Display 2000 EVM User's Guide](#)
 - [DLP LightCrafter Display 2000 EVM Reference Design](#)
- Application Notes and White Papers:
 - [DLP System Design: Brightness Requirements and Tradeoffs](#)
 - [DLP Pico Technology for Smart Home Applications](#)
- Support Forums:
 - [TI E2E™ Community](#)

Application development resources

- From here, custom applications can be developed and deployed to the BeagleBone Black to perform a wide variety of tasks
 - [BeagleBoard.org Developers Community](#)
 - [OpenCV](#)
 - [QT-Embedded](#)
- E2E community support for DLP2000 EVM
 - [BeagleBone Black Cape Overlay Customization](#)
 - [Structured Light Starter Code for DLP2000 EVM](#)
 - [Using the DLP2000 EVM with the Raspberry Pi](#)
- For specialized projects, consider employing other host processors
 - BeagleBone Black Wireless, Raspberry Pi, Dragonboard 410c, etc.



©Copyright 2017 Texas Instruments Incorporated. All rights reserved.

This material is provided strictly “as-is,” for informational purposes only, and without any warranty.
Use of this material is subject to TI’s **Terms of Use**, viewable at TI.com

Training Levels

Technical Level of content:

Fundamental - High level overview of TI technologies, product lines, etc. This is an introduction presentation for someone not familiar with the topic.

Intermediate - Systems or Product topic that goes into depth. This is a presentation for someone familiar with the systems or products being discussed and should be technical in nature.

Advanced - Technical deep dive of a system or product designed for someone with deep experience on the topic including hands-on experience.

Standardized Sub-System Nomenclature for Building EE Reference Designs

SUB_SYSTEM_ID	SUB_SYSTEM_NAME	DESCRIPTION	TYPICAL PRODUCTS
1	Analog Front End	Transformation from real world signals to or from digital signals	ADC, DAC, OPA, Instrumentation Amplifier/INA, PGA, REF, BUF, MUX, XTR
2	Signal Isolation	Galvanic isolation between ground potentials	Digital Isolators, (Signal Transformers, Opto couplers), Analog Isolators
3	Current & Voltage Sense	Current sensing	ADC, OPA, Hall sensors, Fluxgate, INA, (Current shunts), REF, COMP, MUX, Switch
4	Signal Input/Output Protection	Protection for inputs and outputs, ESD, EFT, Surge	TVS Diodes, FETs, (PTC), (Diodes)
5	Power Stage	Output power transistor and drivers	Isolated Gate drivers, FETs, Diagnostics, Protection, (Relay, Thyritors, IGBTs)
6	Input Power Protection	Protection for main power supply	eFUSE, HotSwap, (PTC, Diodes, Fuse)
7	Isolated AC/DC Power Supply	Isolated 115/230V AC/DC Power Supply including power stage, , incl. LDO	PWM Controllers, PFC, FETs, (Diodes)
8	Non-Isolated AC/DC Power Supply	Non-isolated DC/DC Power Supply including power stage, incl. LDO	PWM Controllers, PFC, FET (Diodes, Transformers)
9	Isolated DC/DC Power Supply	Isolated power supply between DC potentials including power stage, incl. LDO	Push-pull drivers, fly-buck converters, (transformers)
10	Non-Isolated DC/DC Power Supply	DC/DC Power Supply including power stage, incl. LDO	Buck/Boost converters and controllers, LDO, PMIC, Power Modules, voltage & reset supervisors
11	Energy Storage	Battery back up power and capacitor charging including power stage	DC/DC, Oring, Boost Converters, BMS, (Battery), (Capacitors, Supercaps)
12	Digital Processing	Central processing unit(s)	MPU, MCU, DSP, (FPGA, x86, ASIC, CPLD)
13	Memory	Data storage function	DDR Power, Level Translation, ESD Protection, Termination, (SD Card, EPROM, DDR, NOR/NAND Flash)
14	Clocking	Clock generation and distribution	Clock generators, jitter cleaners, clock distribution, (Xtal)
15	Wired Interface	Wired signal interface to external devices or internal boards	RS-232, RS-485, Ethernet, LVDS, 4-20mA DAC, USB, interface translators, Level translators
16	Wireless Interface	Wireless signal interface to external devices or internal boards	Wifi, BLE, NFC, Sub 1GHz
17	Output User Interface	Status signaling and graphical interface	Audio amplifiers, LED drivers, Back lighting, Bias, Touch Screen, ALS, (LEDs, Buzzer, Loudspeaker, Display)
18	Input User Interface	User interface to the product	GPIO expanders, LDC, Captivate, Haptics Driver, (Push buttons, Key Pads)
19	Self-Diagnostics/Monitoring	On-board sensors and health monitoring	Temperature sensor, Humidity sensor, Voltage & Reset Supervisor
20	Sense Element	integrated sensing elements	CCD, MEMS sensors