

TAPE AND REEL INFORMATION



QUADRANT ASSIGNMENTS FOR PIN 1 ORIENTATION IN TAPE



*All dimensions are nominal

Device	Package Type	Package Drawing	Pins	SPQ	Reel Diameter (mm)	Reel Width W1 (mm)	A0 (mm)	B0 (mm)	K0 (mm)	P1 (mm)	W (mm)	Pin1 Quadrant
ATL431LIAIDBZR	SOT-23	DBZ	3	3000	178.0	9.0	3.15	2.77	1.22	4.0	8.0	Q3
ATL431LIAIDBZR	SOT-23	DBZ	3	3000	178.0	9.2	3.15	2.77	1.22	4.0	8.0	Q3
ATL431LIAIDQNR	X2SON	DQN	4	3000	180.0	9.5	1.16	1.16	0.5	4.0	8.0	Q2
ATL431LIAQDBZR	SOT-23	DBZ	3	3000	178.0	9.2	3.15	2.77	1.22	4.0	8.0	Q3
ATL431LIAQDBZR	SOT-23	DBZ	3	3000	178.0	9.0	3.15	2.77	1.22	4.0	8.0	Q3
ATL431LIAQDQNR	X2SON	DQN	4	3000	180.0	9.5	1.16	1.16	0.5	4.0	8.0	Q2
ATL431LIBIDBZR	SOT-23	DBZ	3	3000	178.0	9.2	3.15	2.77	1.22	4.0	8.0	Q3
ATL431LIBIDBZR	SOT-23	DBZ	3	3000	178.0	9.0	3.15	2.77	1.22	4.0	8.0	Q3
ATL431LIBIDQNR	X2SON	DQN	4	3000	180.0	9.5	1.16	1.16	0.5	4.0	8.0	Q2
ATL431LIBQDBZR	SOT-23	DBZ	3	3000	178.0	9.0	3.15	2.77	1.22	4.0	8.0	Q3
ATL431LIBQDBZR	SOT-23	DBZ	3	3000	178.0	9.2	3.15	2.77	1.22	4.0	8.0	Q3
ATL431LIBQDQNR	X2SON	DQN	4	3000	180.0	9.5	1.16	1.16	0.5	4.0	8.0	Q2
ATL432LIAIDBZR	SOT-23	DBZ	3	3000	178.0	9.0	3.15	2.77	1.22	4.0	8.0	Q3
ATL432LIAIDBZR	SOT-23	DBZ	3	3000	178.0	9.2	3.15	2.77	1.22	4.0	8.0	Q3
ATL432LIAQDBZR	SOT-23	DBZ	3	3000	178.0	9.0	3.15	2.77	1.22	4.0	8.0	Q3
ATL432LIAQDBZR	SOT-23	DBZ	3	3000	178.0	9.2	3.15	2.77	1.22	4.0	8.0	Q3
ATL432LIBIDBZR	SOT-23	DBZ	3	3000	178.0	9.2	3.15	2.77	1.22	4.0	8.0	Q3
ATL432LIBIDBZR	SOT-23	DBZ	3	3000	178.0	9.0	3.15	2.77	1.22	4.0	8.0	Q3

Device	Package Type	Package Drawing	Pins	SPQ	Reel Diameter (mm)	Reel Width W1 (mm)	A0 (mm)	B0 (mm)	K0 (mm)	P1 (mm)	W (mm)	Pin1 Quadrant
ATL432LIBQDBZR	SOT-23	DBZ	3	3000	178.0	9.0	3.15	2.77	1.22	4.0	8.0	Q3
ATL432LIBQDBZR	SOT-23	DBZ	3	3000	178.0	9.2	3.15	2.77	1.22	4.0	8.0	Q3

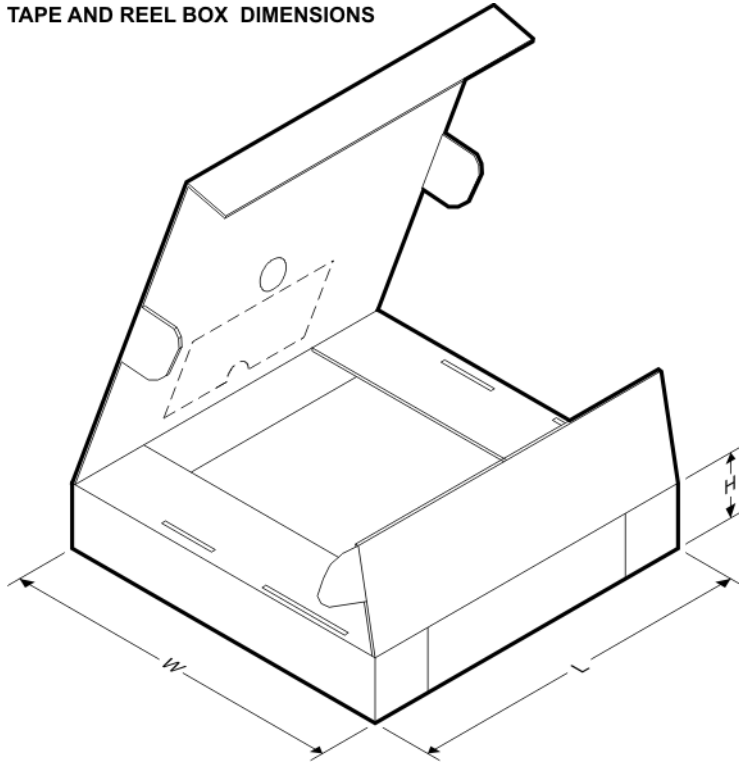
TAPE AND REEL BOX DIMENSIONS

*All dimensions are nominal

Device	Package Type	Package Drawing	Pins	SPQ	Length (mm)	Width (mm)	Height (mm)
ATL431LIAIDBZR	SOT-23	DBZ	3	3000	180.0	180.0	18.0
ATL431LIAIDBZR	SOT-23	DBZ	3	3000	180.0	180.0	18.0
ATL431LIAIDQNR	X2SON	DQN	4	3000	184.0	184.0	19.0
ATL431LIAQDBZR	SOT-23	DBZ	3	3000	180.0	180.0	18.0
ATL431LIAQDBZR	SOT-23	DBZ	3	3000	180.0	180.0	18.0
ATL431LIAQDQNR	X2SON	DQN	4	3000	184.0	184.0	19.0
ATL431LIBIDBZR	SOT-23	DBZ	3	3000	180.0	180.0	18.0
ATL431LIBIDBZR	SOT-23	DBZ	3	3000	180.0	180.0	18.0
ATL431LIBIDQNR	X2SON	DQN	4	3000	184.0	184.0	19.0
ATL431LIBQDBZR	SOT-23	DBZ	3	3000	180.0	180.0	18.0
ATL431LIBQDBZR	SOT-23	DBZ	3	3000	180.0	180.0	18.0
ATL431LIBQDQNR	X2SON	DQN	4	3000	184.0	184.0	19.0
ATL432LIAIDBZR	SOT-23	DBZ	3	3000	180.0	180.0	18.0
ATL432LIAIDBZR	SOT-23	DBZ	3	3000	180.0	180.0	18.0
ATL432LIAQDBZR	SOT-23	DBZ	3	3000	180.0	180.0	18.0

Device	Package Type	Package Drawing	Pins	SPQ	Length (mm)	Width (mm)	Height (mm)
ATL432LIAQDBZR	SOT-23	DBZ	3	3000	180.0	180.0	18.0
ATL432LIBIDBZR	SOT-23	DBZ	3	3000	180.0	180.0	18.0
ATL432LIBIDBZR	SOT-23	DBZ	3	3000	180.0	180.0	18.0
ATL432LIBQDBZR	SOT-23	DBZ	3	3000	180.0	180.0	18.0
ATL432LIBQDBZR	SOT-23	DBZ	3	3000	180.0	180.0	18.0