



### 说明

基于手势的电容式触控扬声器界面参考设计演示了一个用于控制扬声器系统的超低功耗面板。此设计采用支持 CapTIvate™ 技术的 MSP430™ 微控制器 (MCU) 来识别电容式触控事件。此设计利用传感器的自电容式配置来检测接近、点击、拖动和轻扫姿势，可改进扬声器系统的交互方式并改善用户体验。MSP430FR2633 MCU 可驱动所有的电容式传感功能。

### 资源

<a href="#">TIDM-02004</a>	设计文件夹
<a href="#">MSP430FR2633</a>	产品文件夹
<a href="#">CAPT-MSP-FR2633 开发套件</a>	工具文件夹
<a href="#">MSP-EXP430F5529LP LaunchPad 开发套件</a>	工具文件夹
<a href="#">CapTIvate 设计中心</a>	工具文件夹

### 特性

- 通过 MSP430 CapTIvate MCU 实现电容式触控传感
- 电容式触控按钮姿势：点击、点击和按住
- 电容式触控滑块和滚轮姿势：点击、点击两次、轻扫和滑动
- 低功耗：空闲并使用接近唤醒功能时小于 5 $\mu$ A，处于工作模式时小于 500 $\mu$ A
- 耐潮湿设计：遵循建议的设计准则，可承受某些环境中的潮湿雾气和水滴的侵蚀

### 应用

- 智能扬声器（带语音助理）
- 条形音箱
- 有线扬声器
- 无线扬声器



咨询我们的 E2E 专家  
WEBENCH® 计算器工具

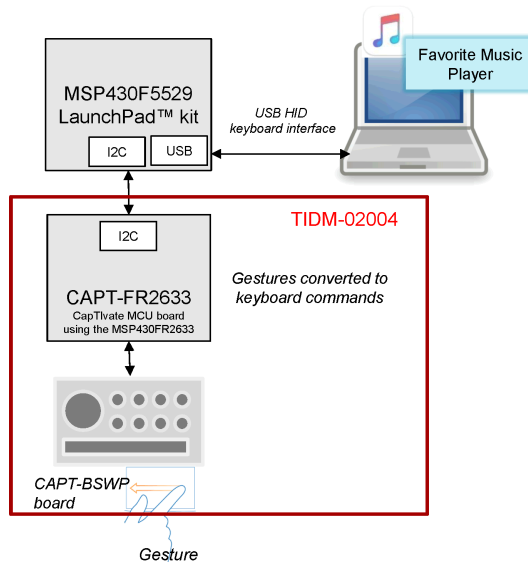

该 TI 参考设计末尾的重要声明表述了授权使用、知识产权问题和其他重要的免责声明和信息。

## 1 System Description

Capacitive touch button, slider and wheel human-machine interfaces can create an enhanced user experience over traditional mechanical style buttons, allowing sleek designs and improved product reliability. This reference design for wireless smart speakers demonstrates how capacitive touch inputs using simple finger gestures, such as tap, double tap and swipe can be used to control a Windows® media player.

### 1.1 Key System Specifications

表 1 lists the key system specifications of the TIDM-02004.

表 1. Key System Specifications

Feature	Specification	Details
Button	8 buttons, self capacitive	
Slider	4 element, self capacitive, 140 mm (5.5 in), resolution = 1000 counts	User programmable
Wheel	3 element, self capacitive, 35 mm (1.5 in) diameter, resolution = 100 counts	User programmable
Gesture (wheel)	Tap, swipe left or right, slide left or right	See 节 3.2.1
Gesture (slider)	Tap, double tap, swipe left or right, slide left or right	See 节 3.2.2
Gesture (button)	Tap, tap and hold	See 节 3.2.3
Sensor scan rate	20 ms (50 Hz)	User programmable
Power Consumption	Active mode: approximately <b>480 <math>\mu</math>A</b>	See 节 3.7.2
	Low-power wake on proximity: approximately <b>5 <math>\mu</math>A</b>	
Moisture tolerance	Design is tolerant to condensation, fine spray	See 节 3.7.3
Featured MCU: MSP430FR2633	The MSP430FR2633 is a low-power FRAM MCU with integrated CapTIvate technology for capacitive sensing	See 1.3 节
MSP430FR2633 memory footprint		See 节 3.6.3

### 1.2 Introduction

The TIDM-02004 design demonstrates the use of capacitive touch gestures to control the play, pause, volume up and down, and next and previous track functions of the Windows Media Player application. Compared with traditional mechanical style buttons, which are limited to only simple interactions, capacitive touch technology opens up new possibilities for product design, enhancing user experience, improving product reliability and reducing product cost.

The focus of this reference design is to show how combining intelligent gesturing firmware with a capacitive touch sensor design can create new possibilities for human-machine inputs. This reference design, along with the accompanying firmware examples, provide the reader a path to implementing similar functionality in their designs. What is not covered in detail in this reference design are details on USB, HID and interfacing to a Windows environment.

### 1.3 MSP430FR2633 CapTIvate MCU

The MSP430FR2633 is an ultra-low-power, FRAM-based MSP430 MCU featuring CapTIvate Technology. CapTIvate Technology is TI's robust capacitive sensing solution. The MSP430FR2633 MCU is designed for user interface applications with integrated capacitive touch and a strong MSP430 peripheral set.

Features:

- 16 capacitive touch inputs that can support up to 64 electrodes in mutual-capacitance mode

- Parallel scanning of up to four electrodes at a time
- CapTivate Software Library included in a preprogrammed 12KB of ROM
- Four 16-bit timers and a 16-bit counter-only real-time clock (RTC)
- Three enhanced serial communications peripherals for UART, IrDA, SPI, and I<sup>2</sup>C
- 19 I/Os with 16 interrupt pins for wake-up from low-power modes
- High-performance, 8-channel, 10-bit analog-to-digital converter (ADC)
- Clock system with an operating speed of up to 16 MHz

## 2 System Overview

### 2.1 Block Diagram

图 1 shows how the TIDM-02004 demonstrates capacitive touch gestures to control a Windows media player. The reference design block diagram includes the CAPTIVATE-FR2633 Target MCU module, CAPTIVATE-BSWP self capacitive demo panel and MSP430FR2633 MCU.



图 1. TIDM-02004 Block Diagram

### 2.2 Design Considerations

This reference design can be easily assembled from existing TI products available on the TI e-store.

[CAPT-MSP-FR2633 CapTIvate Capacitive Touch development kit](#)

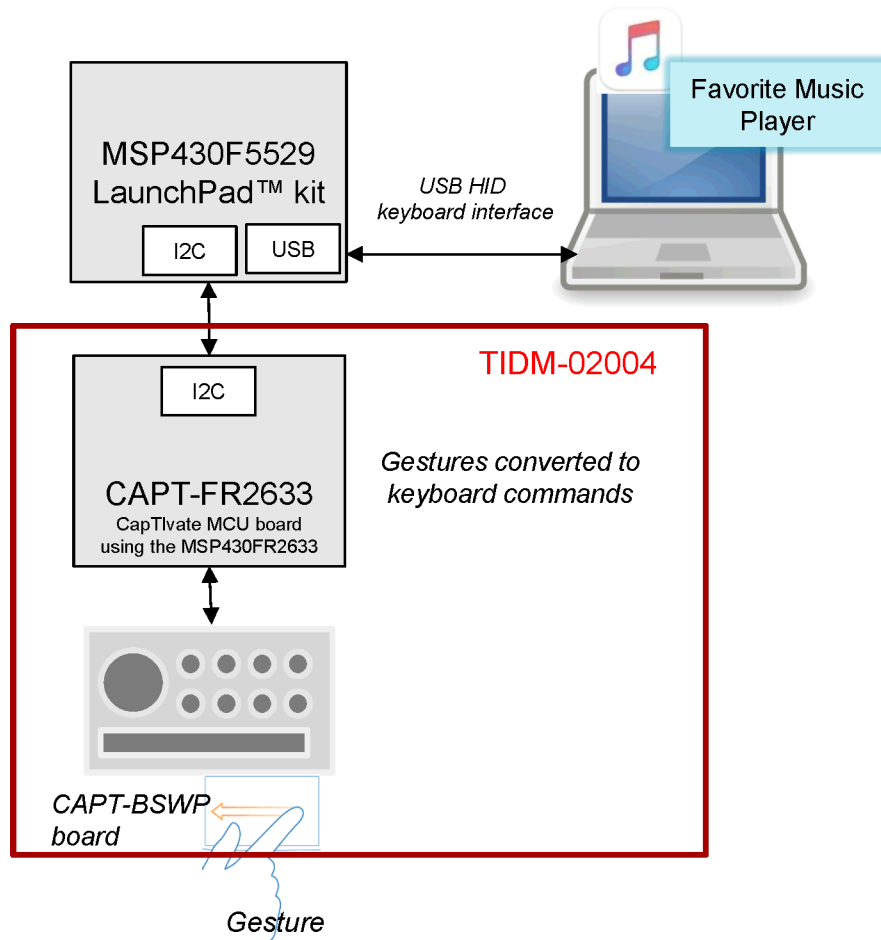
[EXP-MSP430F5529LP USB LaunchPad development kit](#)

To experiment further with capacitive touch and designing a custom PCB, refer to the [CapTIvate Technology Guide](#) for guidelines on button, slider, and wheel sensor designs.

## 2.3 Highlighted Products

### MSP430FR2633 Target MCU

The MSP430FR2633 is a 16-bit microcontroller with programmable ferroelectric memory (FRAM) and CapTIvate capacitive sensing technology. CapTIvate technology is a flexible and robust capacitive sensing technology for user interface applications such as buttons, sliders, wheels, and proximity sensors.

### CAPTIVATE-PGMR Board

The CAPTIVATE-PGMR board is used to program and debug the MSP430FR2633 target MCU. It is included in the CAPT-MSP-FR2633 development kit or can be ordered separately. For this reference design, the CAPTIVATE-PGMR is needed only to initially program the MSP430FR2633 target MCU with the demonstration firmware. It is not needed for the demonstration.

#### 2.3.1 MSP430FR2633 MCU Block Diagram

MSP430FR2633 MCUs feature a diverse peripheral set that makes them ideal for use in many capacitive sensing applications. 图 2 shows the block diagram of the MSP430FR2633 MCU.



图 2. Block Diagram of MSP430FR2633

### 2.3.2 CapTlvate Technology Block Diagram

CapTlvate Technology enables capacitive sensing on the TIDM-02004. CapTlvate Technology is an MSP peripheral dedicated to providing robust capacitive sensing measurements. 图 3 shows the block diagram of the CapTlvate peripheral.

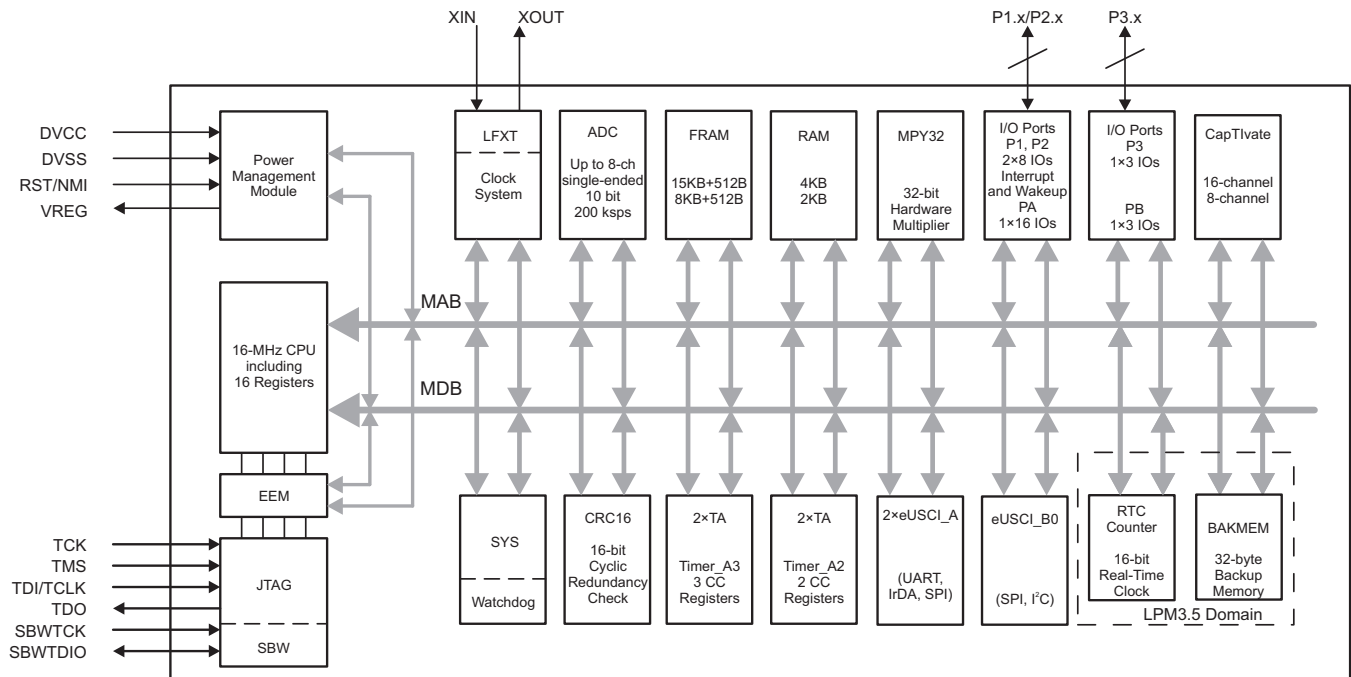

图 3. CapTlvate Technology Block Diagram

## 3 Hardware, Software, Testing Requirements, and Test Results

### 3.1 System Design Theory

The TIDM-02004 reference design leverages the CapTlvate CAPT-MSP-FR2633 capacitive touch development kit featuring an MSP430FR2633 MCU with CapTlvate Capacitive Touch Technology and the CAPTIVATE-BSWP demonstration panel with self capacitive button, slider and wheel sensors created from copper patterns designed on the PCB. As a user's finger interacts with these sensors, changes in capacitance are measured by the MSP430FR2633 MCU and processed to determine the validity and type of gesture. Each valid gesture is then mapped to a corresponding keyboard value and transmitted to the MSP430 USB HID keyboard device over an I2C interface where it is reported to the Windows application.

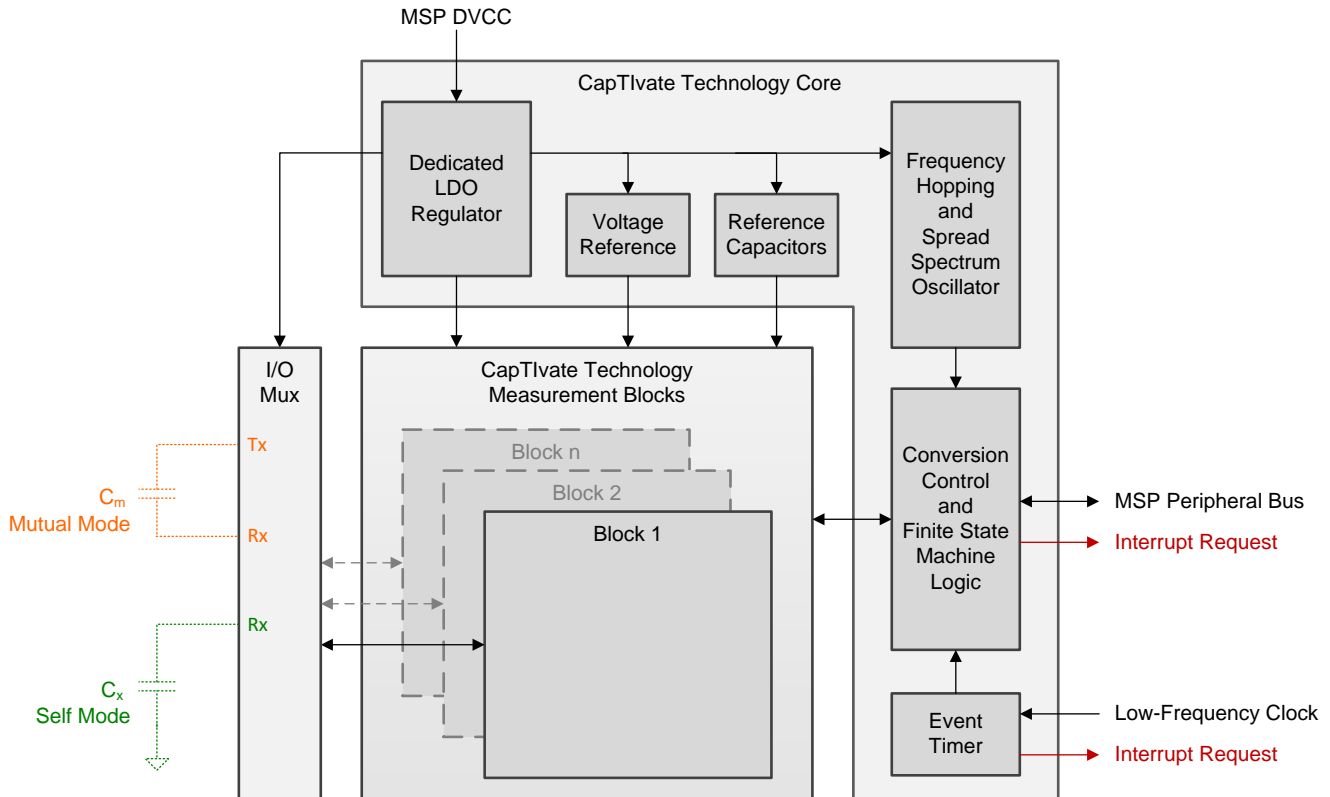
### 3.2 Capacitive Touch Sensors

Compared with traditional mechanical buttons, capacitive touch wheel, slider and button sensors offer a product designer more flexibility and functionality when considering an application's human-machine interface design.

For detailed information about capacitive touch sensors and how to design them, please refer to the [CapTIvate Technology Guide](#), Design Guide chapter for guidelines on button, slider and wheel sensor designs.

### 3.2.1 Wheel Sensor

A capacitive touch wheel sensor is constructed as a circular copper pattern on the PCB containing 3 or 4 interdigitated sensing elements. The interdigitation provides a high resolution, linear output as the finger moves around the wheel. A wheel's basic functionality reports a finger position anywhere on the sensor. By adding some gesturing intelligence to the firmware, both finger direction and speed can also be derived.

Specific regions or zones on the wheel's surface can be defined or mapped in software creating a flexible user-interface that allows various application functions to be controlled depending where the wheel is touched. Incorporating motion gesture features, such as Slide or Swipe, adds another level of user action possibilities. 图 4 shows some of the possible gesture features that could be used for controlling the functionality on a wireless smart speaker.



图 4. Wheel Sensor Gesture Examples

One additional benefit of the capacitive touch wheel is the ability to re-purpose the wheel interface hardware design from product to product and change only features or functionality as needed in firmware.

### 3.2.2 Slider Sensor

A capacitive touch slider sensor shares many of the same characteristics as the wheel sensor. It is constructed as a linear copper pattern on the PCB containing 3 or 4 interdigitated sensing elements. And, like the wheel, the slider provides a high resolution linear output as the finger moves from left to right and reports a finger position anywhere on the sensor.

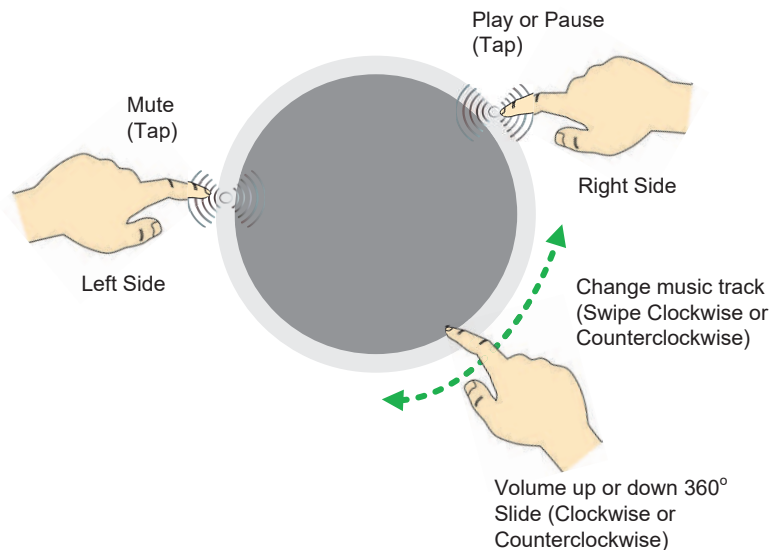

图 5. Slider Sensor Gesture Example

### 3.2.3 Button Sensor

A capacitive touch button sensor is a simple sensor constructed as a filled circular copper pattern on the PCB, slightly larger than the diameter of a finger. Unlike a wheel or slider sensor, the button is limited to providing a binary output, such as on/off. But unlike its mechanical counterpart, implementing simple gesture features, such as tap-and-hold or Double-Tap can provide the additional functionality for the application.



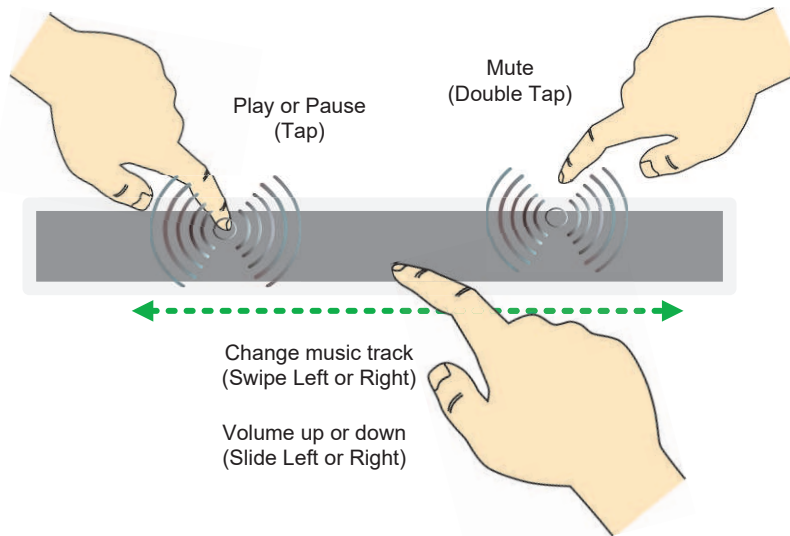

图 6. Multi-Button Sensor Gesture Example

### 3.3 Gesture and Key Mapping

This section provides details about the mapping between a gesture and a specific media player function used in this reference design demonstration.

#### 3.3.1 Media Player

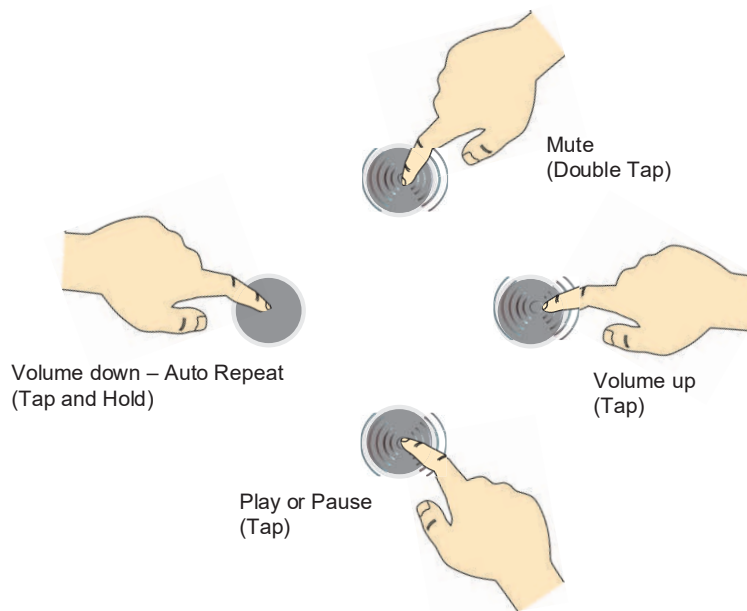
In this Windows media player demonstration, gestures such as *swipe right*, for example, are mapped in the firmware to the corresponding media player function that selects the next media track. 表 2 lists the seven supported gestures and their corresponding actions with equivalent keyboard key combinations.

表 2. Media Player Gesture Mapping

Media Player Function	Key Combination	Button Gesture	Slider Gesture	Wheel Gesture
Play or pause	CTRL-P	Tap	Tap	Tap
Previous music track	CTRL-B	Tap	Swipe left	Swipe counterclockwise
Next music track	CTRL-F	Tap	Swipe right	Swipe clockwise
Mute	F7	Tap	Double tap	Tap
Volume up	F8	Tap or tap-and-hold	Slide right	Slide clockwise
Volume down	F9	Tap or tap-and-hold	Slide left	Slide counterclockwise

#### 3.3.2 USB HID Keyboard Data

Each keyboard key value is defined in the [USB HID Usage Tables](#), Keyboard/Keypad Page (0x07), available from [USB-IF](#). Typing these same keys or key combinations directly on the Windows keyboard controls the media player the same as the capacitive touch demo.

As shown in USB HID Usage document, each key is represented by an 8-bit value. For example, reporting the F7 key requires an 8-bit value (0x00 to 0xFF). Reporting a key-combination, such as CTRL-P requires two bytes, because two keys are being pressed simultaneously. 表 3 lists each keyboard key's 8-bit value.

**表 3. Key Values From USB HID Usage Table for Keyboard/Keypad Page (0x07)**

Keyboard Key	Key Value
KEY-B	0x05
KEY-F	0x09
KEY-P	0x13
KEY-F7	0x40
KEY-F8	0x41
KEY-F9	0x42
KEY-MOD-LCTRL	0xE0

The key value is transmitted by the MSP430FR2633 to the MSP430 USB HID device over an I<sup>2</sup>C interface. When transmitting the key value, the key or key combination is reported as a 16-bit value, in which the lower byte represents the primary key and upper byte represents the key modifier, if applicable. If a key has no modifier, then the upper byte is 0x00. 表 4 lists the final 16-bit key representations that are reported to the MSP430 USB HID device.

**表 4. Media Player Functions**

Media Player Function	Key Combination	16-Bit Representation
Play or pause	CTRL-P	0xE013
Previous music track	CTRL-B	0xE005
Next music track	CTRL-F	0xE009
Mute	F7	0x0040
Volume up	F8	0x0041
Volume down	F9	0x0042

### 3.4 Capacitive Touch Gestures

Adding touch gesturing to a capacitive touch wheel, slider, or button sensor enables a more flexible human-machine interface (HMI) compared to a traditional mechanical button operation in which a button is either on or off. For example, with a capacitive touch wheel, a simple finger tap anywhere on the wheel sensor can represent a button press. Multiple touch zones can be mapped on the wheel, providing the equivalent of having several discrete buttons. In addition, the wheel can detect the motion of a finger to control user inputs like a volume control or can detect a rapid swipe motion to provide some other type of control input. Of course, moving from a traditional discrete on-off button functionality to a more feature-capable wheel does require some intelligence to translate these actions and motions into the desired functionality. This intelligence is gesture detection.

The following sections describe the gestures, motion parameters, and timing diagrams for each of the supported gestures. For more detailed information about gesture software and tuning, refer to [Capacitive Touch Gesture Software and Tuning](#).

#### 3.4.1 How Gesture Detection Works

To understand how gesture detection works, first look at how a gesture is detected. The MSP430FR2633 measures change in capacitance on the CAPTIVATE-BSWP panel caused by a finger touch on a button, slider, or wheel sensor. The CapTivate library firmware includes algorithms that determine if a sensor is touched and, if the sensor is a slider or wheel sensor, the position of the finger on the sensor. The MSP430FR2633 has a dedicated 16-bit CapTivate timer that is set by default to generate a periodic capacitive touch measurement interrupt every 20 milliseconds, or 50 times a second. This rate is user configurable. During each interrupt, the three sensors are measured, followed by the gesture processing, which uses the periodic sensor sampling rate as the time base measurement for finger touch and release events. Because the CapTivate technology has a dedicated timer, none of the general-purpose 16-timers on the MCU are used, leaving them available for the main application.

---

注: Important Concept: Gesture timing is based on the sensor sampling rate.

---

To determine a specific gesture there are one or two attributes needed. The first attribute is time. This is measured by counting the number of sensor measurement samples between two events, such as a finger touch followed by release. For example, when sampling a sensor every 20 milliseconds, a touch that lasts 10 sample periods represents a touch for 200 milliseconds. The time attribute applies to buttons, sliders, and wheels. The second attribute is distance. This is the distance that a finger has moved and applies to only wheel and slider sensors.

By assigning parameters to these time and distance attributes, rules can be created to help define each gesture. Why is this important? Because gesture duration and speed can vary from user to user, gesture parameters help improve gesture repeatability and detection accuracy. Each sensor type has its own gesture parameters and is configurable in software to allow a specific "user touch and feel" to be tailored for the application.

Because each sensor can have different gesture behaviors, processing is specific to each sensor type. For example, in this reference design there are wheel gestures, slider gestures and button gestures assigned to the corresponding sensors. In software, the sensor gesture is essentially a state machine that is executed on every measurement sample as part of the sensor's callback function and uses the sensor's timing and distance parameters to control the processing.

图 7 shows that a tap gesture is a momentary touch followed by release and is common to all three sensor types. Notice that the gesture detection only begins after there is a continuous touch for at least the first four samples and is only reported as a tap gesture when the finger is released within the specified time window. If released outside of the time window, the gesture is ignored.

---

注: The specific time and distance parameter values in the following figures represent the parameters used for this reference design demonstration. These parameters are user configurable and can be tuned for any application.

---

### 3.4.2 Tap Gesture

A tap gesture is defined as a momentary finger touch followed by a release (see 图 7). The touch duration window is set by the minimum and maximum limits defined for the gesture. The software parameters are TouchSampleCount\_Min and TouchSampleCount\_Max.



图 7. Tap Gesture Detection

### 3.4.3 Double-Tap Gesture

A double-tap gesture is defined as a momentary finger touch followed by a release, then a second touch and release. 图 8 shows that the double-tap gesture is essentially a tap followed by a delay that defines a window when the second touch can occur. The software parameters are TouchSampleCount\_Min, TouchSampleCount\_Max and DoubleTapDelayCount\_Max.

注: A sensor that supports double-tap also supports tap by default. The reader must be aware that if a tap and not a double-tap is detected, the tap gesture is not reported until after the double-tap delay period expires. This can create a slight delay in tap response, but when properly tuned, the delay has a minimal impact on user interaction.

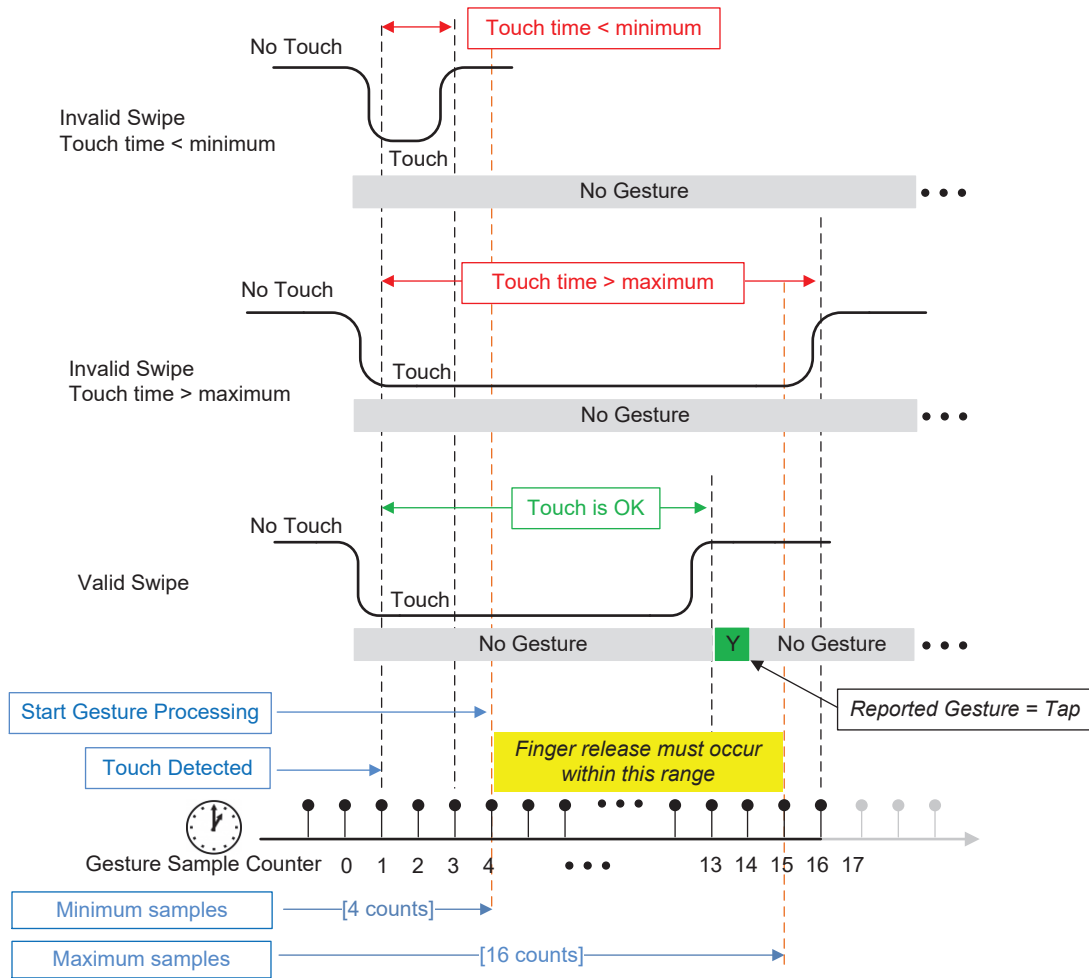

图 8. Double Tap Gesture Detection

### 3.4.4 Tap-and-Hold Gesture

A tap-and-hold gesture is defined as a long finger touch followed by a release (see 图 9). Just like a tap, the tap-and-hold has a min limit and a min hold limit that defines how long the finger must remain touching to qualify as a valid tap-and-hold gesture. The software parameters are TouchSampleCount\_Min and TouchHoldSampleCount\_Min.

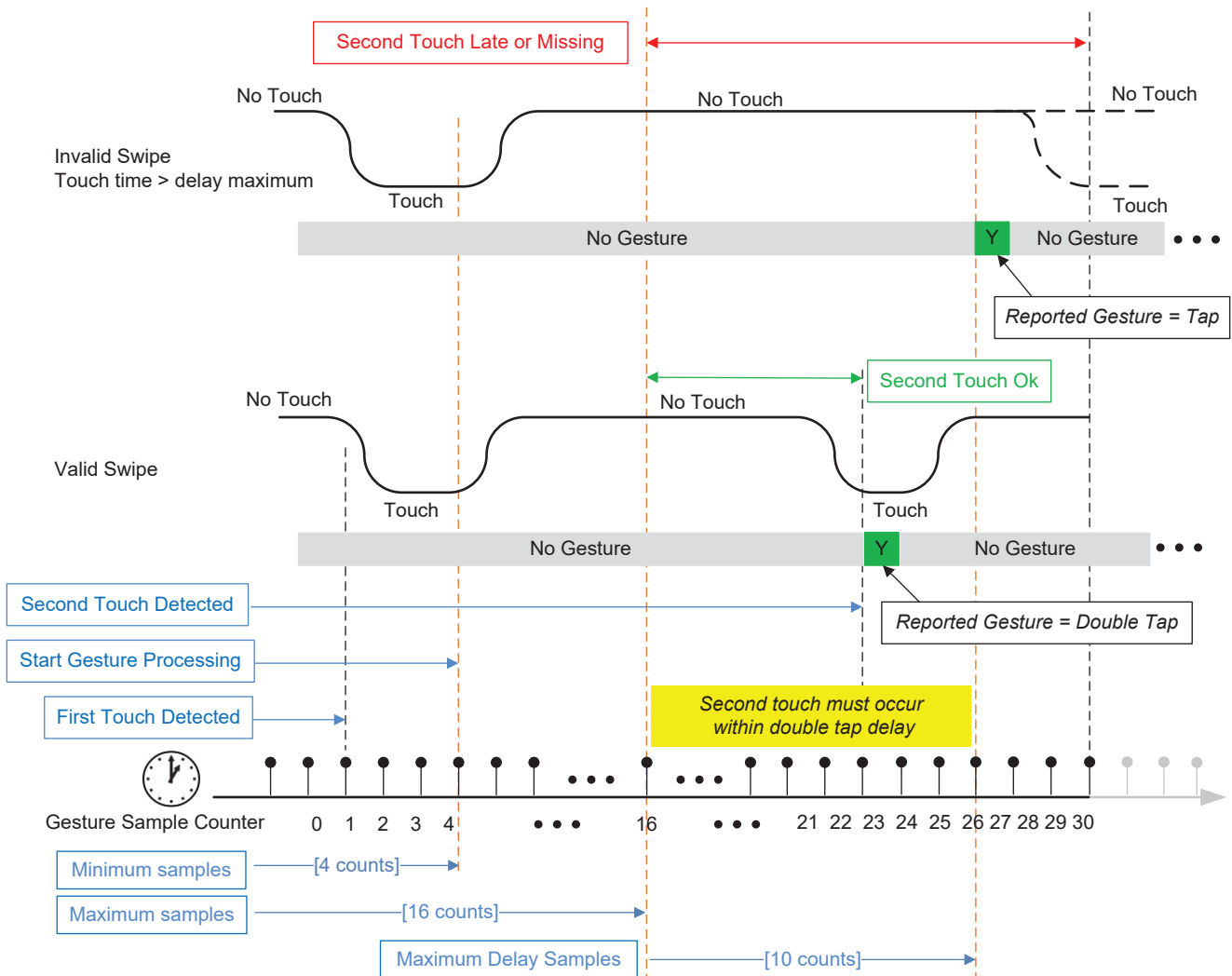

图 9. Tap-and-Hold Gesture Detection

### 3.4.5 Swipe Gesture

A swipe gesture is defined as a brief finger touch with the finger moving, first a minimum distance to show it is a motion gesture, then the finger must move a minimum swipe distance then release the finger within the allowed time. 图 10 shows that the swipe gesture requires both time and distance parameters. The software parameters are TouchSampleCount\_Min, SwipeSampleCount\_Max, FingerDistance\_Min, and SwipeDistance\_Min.

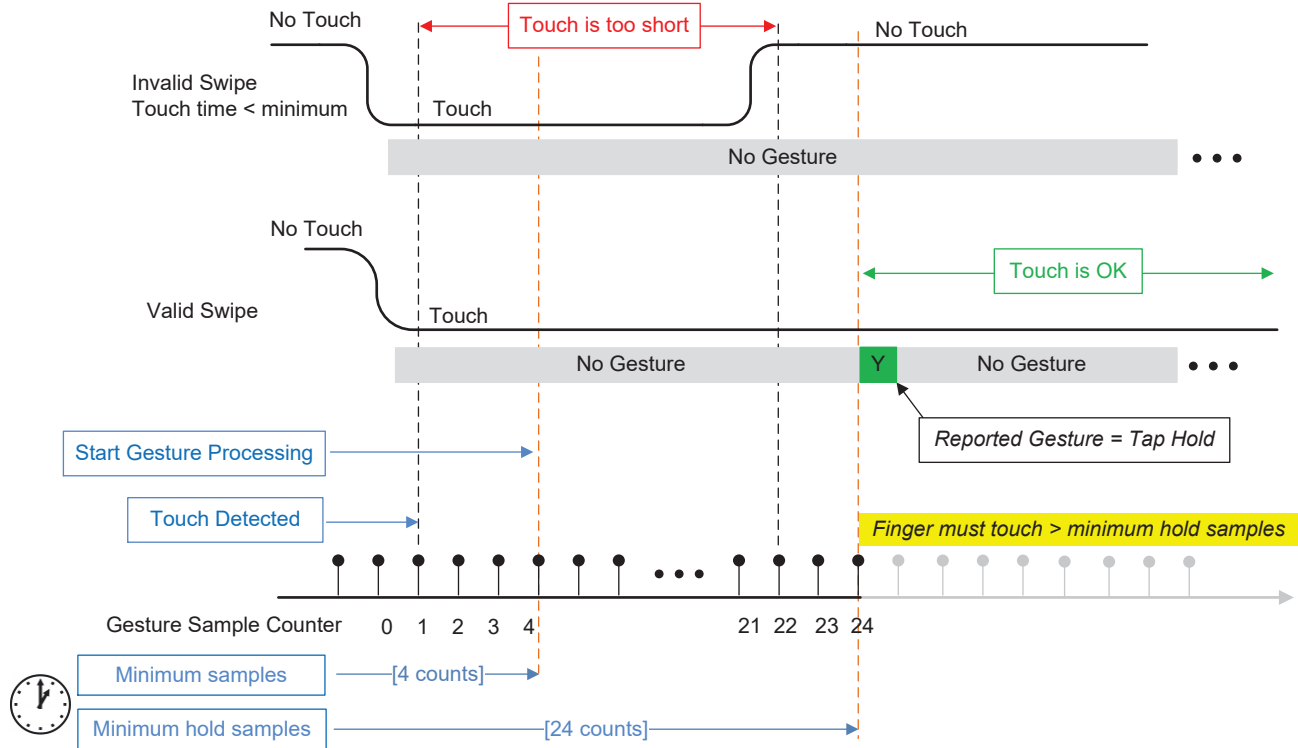

图 10. Swipe Gesture Detection



### 3.4.6 Slide Gesture

A slide gesture behavior is similar to a swipe gesture, but is defined as a continuous finger touch with motion where the distance moved meets the minimum distance parameter. 图 11 shows that as long as the finger is touching the sensor and moves the minimum required distance in any direction, a slide gesture is reported. The software parameters are TouchSampleCount\_Min and SlideStepSize.

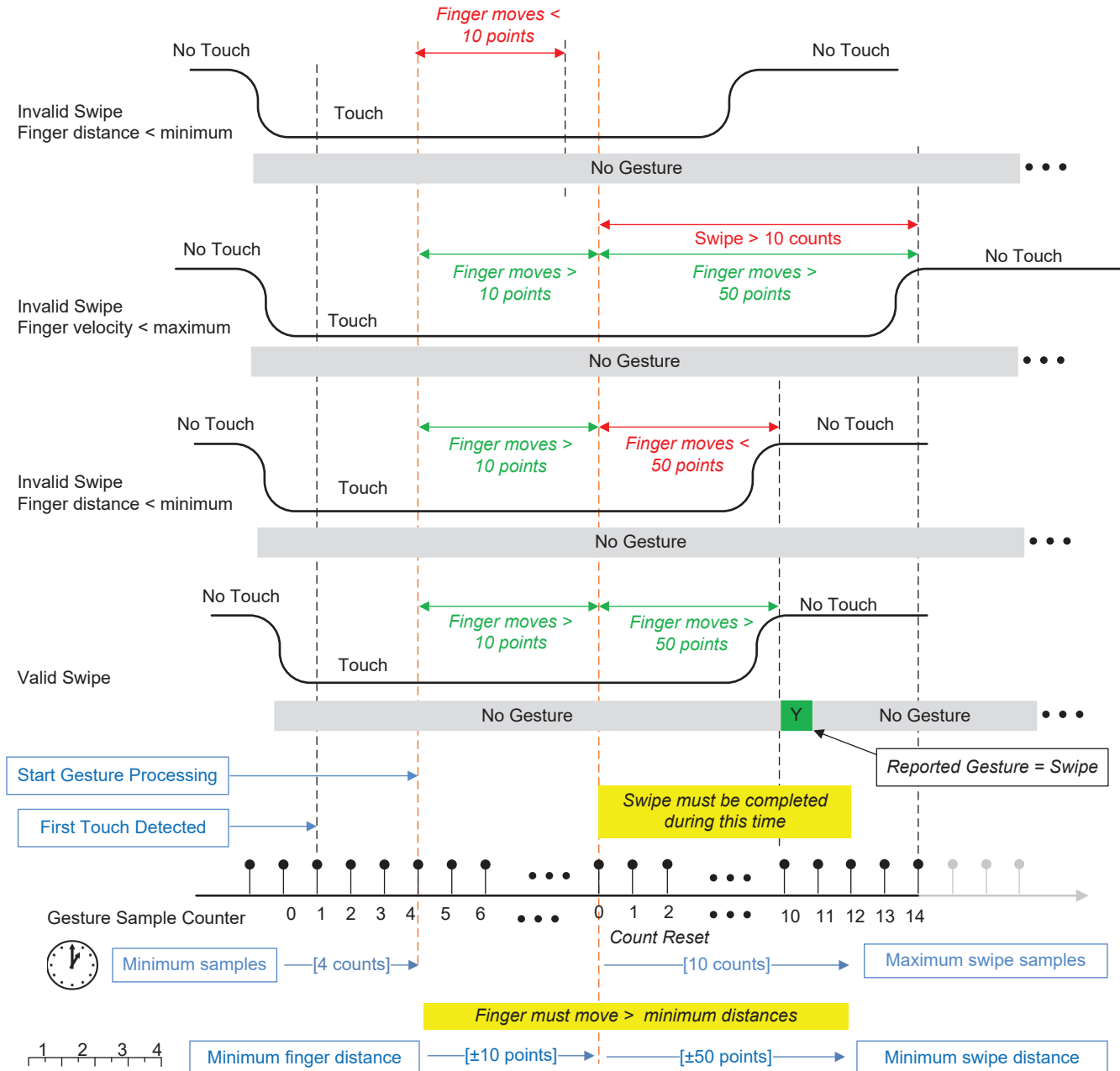

图 11. Slide Gesture Detection

### 3.5 Getting Started With Hardware

The required hardware is described in 2.2 节. If the target MCUs have not been programmed with the demonstration firmware, follow the procedure in 3.6 节. After programming, connect the MSP430FR2633 and MSP430F5529 LaunchPad development kits together and connect to a Windows PC using a USB cable. The MSP430F5529 should enumerate as a HID interface device automatically. No drivers are required.

### 3.6 Getting Started With Firmware

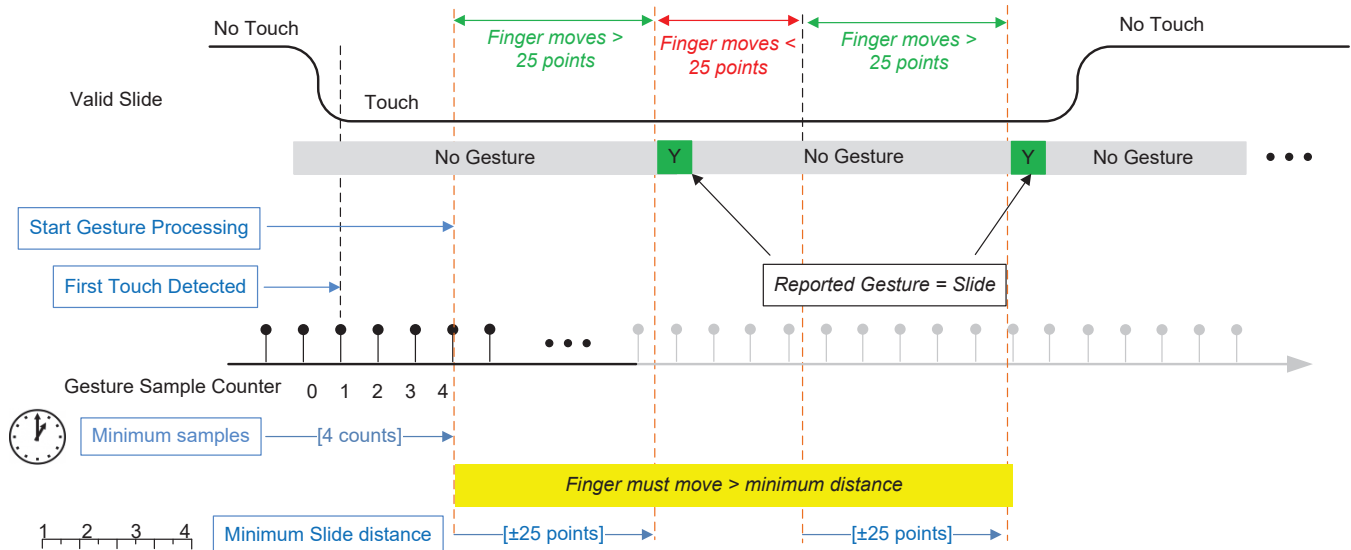
The example firmware developed for the TIDM-02004 was developed using CCS v8.2.0.00007 and TI Compiler version 18.1.4 LTS. To evaluate the example firmware, download the latest version of CCS. The example projects can be imported into a CCS workspace from [TI Design Software Install Root]/Firmware/Source/\*.

#### 3.6.1 Programming Target MCU

To program the MSP430FR2633, import the CAPT-FR2633-MediaPlayerDemo project (see 节 3.6.2) and compile the software. Connect a CAPT-PGMR programmer PCB to the CAPTIVATE-FR2633 MCU target board, then connect a USB cable to the CAPT-PGMR. In CCS, program the target by clicking on the small green bug icon. When complete, remove the CAPT-PGMR board.

To program the MSP430F5229 LaunchPad development kit, import the MSP-EXP430F5529LP\_USBKeyboardHost\_GestureDemo project (see 节 3.6.4) and compile the software. Connect a USB cable to the MSP430F5529 LaunchPad development kit. In CCS, program the target by clicking on the small green bug icon.

### 3.6.2 MSP430FR2633 CapTivate Gesture Firmware

The MSP430FR2633 example project can be imported into a CCS workspace from [TI Design Software Install Root]/TIDM-02004\_firmware/demo\_src/CAPT-FR2633\_MediaPlayer.

This firmware example is based on the CAPTIVATE-BSWP demo provided with the [CapTivate Design Center](#) installation.

The source code for the MSP430FR2633 that is relevant to this demo is organized in multiple files (see [表 5](#)).

**表 5. Source Code Files for Demo Application**

Name	Description
main.c	Application main function
demo\media_player.c, demo\media_player.h	Demo initialization and typedefs header file
gestures\gesture_definitions.h	Defines which sensors are included in the build
gestures\gestures.h	Function prototypes, enumerations, and gesture data structure types
gestures\media_player_buttons.c	Button sensor gesture processing function
gestures\media_player_wheel.c	Wheel sensor gesture processing function
gestures\media_player_slider.c	Slider sensor gesture processing function

### 3.6.3 Memory Footprint

The demo firmware for this reference design has the largest memory footprint because it supports all three sensors. A more typical application would have one or maybe two sensor types and therefore the memory footprint would be smaller.

[表 6](#) lists some possible configurations to give the reader a sense of how the memory size varies the different sensors and features. [表 7](#) lists the program memory specific to the gesture type and its handler. These values are included in the memory sizes in [表 6](#).

**表 6. Memory Size Combinations**

Sensors	FRAM (bytes)	RAM (bytes)	Configuration
Slider, wheel, and buttons	7852	1340	Default demo configuration
Slider, wheel, and buttons	7426	1338	Low-power wake on proximity disabled
Slider, wheel, and buttons	9242	1722	GUI UART communications enabled
Slider	6488	742	
Wheel	6522	710	
Buttons	6410	870	

**表 7. Individual Sensor Gesture Related Program Memory Sizes**

Sensor	Handler (bytes)	Gesture (bytes)	Total (bytes)
Slider	160	404	564
Wheel	160	454	614
Buttons	160	312	472

Compiler = TI v18.1.4 LTS, Optimization level = -O3. Unless otherwise stated, the reported code sizes are with the GUI communications option disabled = CAPT\_INTERFACE (\_\_CAPT\_NONE\_INTERFACE\_\_) located in CAPT\_UserConfig.h.

### 3.6.4 MSP430F5529 HID Keyboard Device Firmware

The MSP430F5529USB HID example project can be imported into a CCS workspace from [TI Design Software Install Root]/TIDM-02004\_firmware/hostmcu\_demo\_src/MSP-EXP430F5529LP\_USBkeyboardHost.

The source code for the MSP430F5529 that is relevant to this demo is organized in multiple files in [表 8](#).

This firmware example is based on the USB HID H8\_Keyboard example firmware that is available from [TI Resource Explorer](#).

**表 8. Source Code Files for Demo Application**

Name	Description
main.c	Application main function
keyboard.c	Functions to handler key processing and reporting
keyboard.h	Function prototypes, enumerations and data structure types for keyboard

## 3.7 Testing

This section describes the testing that was performed on the TIDM-02004. It includes descriptions of test setups and results.

### 3.7.1 Gesture

Using the demonstration instructions from [4 节](#) to verify each sensor's operation.

**表 9. Gesture Test**

Test Conditions	Result
Test all gesture combinations on wheel, slider, and button sensors. The default sensor sampling rate is 20 ms (50 Hz).	Pass

### 3.7.2 Power Measurements

The MSP430FR2633 operates in Active mode while the user is touching any sensor on the CAPT-BSWP board. The measured current averages approximately 480  $\mu$ A in this mode.

When the sensors are no longer being touched, the CPU enters low power mode LPM3 indefinitely and the CapTIvate peripheral is configured to operate in wake-on-proximity mode. In this mode, the CapTIvate peripheral is only looking for the presence of a finger or hand, waking the CPU if detected. Operating in this wake-on-proximity mode, the CPU can achieve very low power. The measured current averages approximately 5  $\mu$ A in this mode.

Two methods are available to measure the MSP430FR2633 power consumption.

1. Remove jumper J3 on the MSP430FR2633 MCU board and connect a current meter between jumper J3 "3.3V LDO" pin and J3 "MCU VCC" pin.
2. Connect the CAPT-PGMR board and use the programmer's Energy Trace™ feature to measure the current. Note, on the MSP430FR2633 MCU board, move jumper J3 between jumper J3 "MCU VCC" pin and J3 "3.3V Metered" pin.

For either option, return jumper J3 to the original position when done.

注: The MSP430F5529 LaunchPad development kit must be disconnected from the MSP430FR2633 MCU board during the measurement. The MSP430FR2633 MCU board continues to respond normally to finger gestures.

---

For more information about current measurements on the MSP430FR2633, refer to the [Experiments with Low Power](#) section of the [CapTIvate™ Technology Guide](#).

Test Conditions (Method 1)	Result
Active mode	480 $\mu$ A
Low power, Wake on Proximity	5 $\mu$ A

### 3.7.3 Moisture Tolerance

The moisture tolerance test is performed with the CAPT-BSWP panel in the horizontal position sitting on a bench top. All electronics, including the 48-pin connector on the CAPT-BSWP board are covered with plastic. A spray bottle set to fine mist and pumped three times from a distance no closer than 30 cm (12 in). The CAPT-BSWP panel is not designed for maximum moisture tolerance, and it can be susceptible to false triggers under certain conditions. For information about moisture tolerant designs, see the [TIDM-1021 Liquid Tolerant Capacitive Touch Keypad Reference Design](#).

表 10. Moisture Tolerance Test

Test Conditions	Results
Spray bottle set to fine mist	No false triggers detected

## 4 Demonstration

The following description assumes that the target MCUs have been programmed and the MSP430FR2633 and MSP430F5529 LaunchPad development kits have been connected together and connected to a Windows PC using a USB cable. The MSP430F5529 should enumerate as a HID interface device automatically. No drivers are required.

---

注: During this demonstration, leave the mouse focus on the media player application. Failing to do so allows keyboard commands to be sent to other open applications and can result in undesired behavior.

---

When power is applied to the TIDM-02004 reference design hardware, LED1 and LED2 located on the MSP430FR2633 MCU board will turn on momentarily, then turn off. Touching the slider, wheel, or buttons causes LED1 to turn on and remain on as long as the finger remains touching. When a valid gesture is detected, LED2 toggles on and off, indicating the gesture is valid and the corresponding key value has been sent to the Windows application.

Launch the Windows Media Player application on the PC. Select a favorite song and mouse click to get the song started.

### 4.1 Wheel

#### 4.1.1 Volume Control

With a song playing, touch anywhere on the wheel and slide your finger clockwise to increase the volume and counter-clockwise to decrease the volume. Experiment with with various starting positions on the wheel. You should see that this function works independent of where you start the gesture.

### 4.1.2 Changing Music Tracks

With a song playing, provide a swipe anywhere on the wheel in a clockwise direction to select the next song. Swipe in a counter-clockwise to select the previous song. Experiment with the starting position. You should see this function works independent of where you start the gesture.

---

注: The wheel resolution is 100 points. The swipe gesture requires that your finger move a minimum distance of 10 points.

---

It is also possible to select the next or previous songs with a tap gesture on the regions shown in [图 12](#).

#### 4.1.2.1 Play/Pause

With a song playing, Tap once on the region shown in [图 12](#) to pause the music. Tap again to play the music.

#### 4.1.3 Mute

With a song playing, tap once on the region shown in [图 12](#) to mute the music. Tap a second time to un-mute the music.



图 12. Wheel for Music Control

## 4.2 Slider

### 4.2.1 Volume Control

With a song playing, touch anywhere on the slider and slide your finger right to increase the volume and left to decrease the volume. Experiment with various starting positions. You should see this function works independent of where you start the gesture.

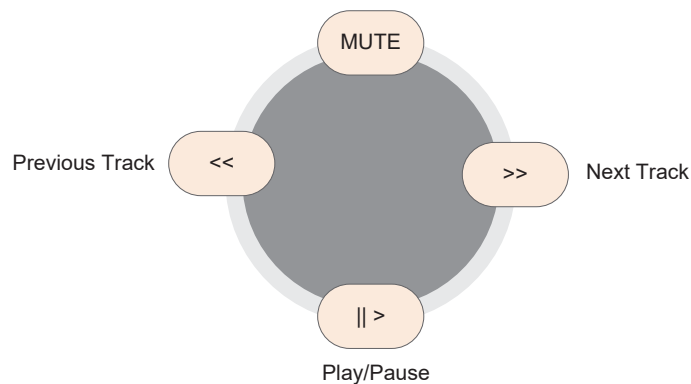
### 4.2.2 Changing Music Tracks

With a song playing, touch the slider and quickly swipe your finger right and release to select the next song. Make sure you move the minimum required distance. Quickly swipe your finger left and release to select the previous song. Experiment with various starting positions. You should see this function works independent of where you start the gesture.

---

注: The slider resolution is 1000 points. The swipe gesture requires that your finger move a minimum distance of 50 points.

---

#### **4.2.3 Play or Pause**

With a song playing, tap once anywhere on the slider to pause the song. Tap again to play the music.

#### **4.2.4 Mute**

With a song playing, double-tap anywhere on the slider to mute the song. Double-tap again to un-mute the music.

## 4.3 Buttons

### 4.3.1 Volume Control

With a song playing, tap multiple times, or tap and hold, on the volume buttons shown in 图 13 to increase or decrease the volume.

### 4.3.2 Changing Music Tracks

With a song playing, tap once on the regions shown in 图 13 to select the next or previous songs.

### 4.3.3 Play or Pause

With a song playing, tap once on the region shown in 图 13 to pause the music. Tap again to play the music.

### 4.3.4 Mute

With a song playing, tap once on the region shown in 图 13 to mute the music. Tap a second time to unmute the music.



图 13. Buttons for Music Control

## 5 Design Files

### 5.1 Schematic

To download the schematic for the TIDM-02004, see the design files at <http://www.ti.com/tool/TIDM-02004>.

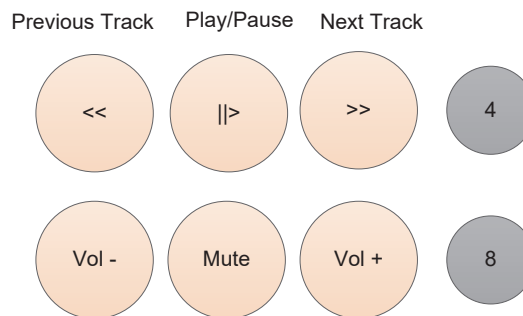
### 5.2 Bill of Materials

To download the bill of materials for the TIDM-02004, see the design files at <http://www.ti.com/tool/TIDM-02004>.

## 6 Software Files

To download the software files for this reference design, see the link at <http://www.ti.com/tool/TIDM-02004>.

## 7 Related Documentation

1. [CapTivate™ Design Center GUI for MSP430™ Capacitive Sensing MCUs](#)
2. [Texas Instruments E2E™ Community](#)



## 7.1 商标

CapTlvate, MSP430, Energy Trace, E2E are trademarks of Texas Instruments. Windows is a registered trademark of Microsoft Corporation. All other trademarks are the property of their respective owners.

## 8 Terminology

**Self capacitance:** The method of measuring changes in capacitance with respect to earth ground

**HMI:** Human-machine interface

**CDC:** CapTlvate Design Center

## 9 About the Author

Dennis Lehman is a Senior System Application Engineer at Texas Instruments supporting capacitive touch design solutions using MSP430 MCUs with CapTlvate technology. He has been with Texas Instruments for 8 years with a total of 15 years of experience in the semiconductor industry supporting 32-, 16-, and 8-bit MCU products. He has a BSCE from San Diego State University.

## 重要声明和免责声明

TI“按原样”提供技术和可靠性数据（包括数据表）、设计资源（包括参考设计）、应用或其他设计建议、网络工具、安全信息和其他资源，不保证没有瑕疵且不做任何明示或暗示的担保，包括但不限于对适销性、某特定用途方面的适用性或不侵犯任何第三方知识产权的暗示担保。

这些资源可供使用 TI 产品进行设计的熟练开发人员使用。您将自行承担以下全部责任：(1) 针对您的应用选择合适的 TI 产品，(2) 设计、验证并测试您的应用，(3) 确保您的应用满足相应标准以及任何其他功能安全、信息安全、监管或其他要求。

这些资源如有变更，恕不另行通知。TI 授权您仅可将这些资源用于研发本资源所述的 TI 产品的应用。严禁对这些资源进行其他复制或展示。您无权使用任何其他 TI 知识产权或任何第三方知识产权。您应全额赔偿因在这些资源的使用中对 TI 及其代表造成的任何索赔、损害、成本、损失和债务，TI 对此概不负责。

TI 提供的产品受 [TI 的销售条款](#) 或 [ti.com](#) 上其他适用条款/TI 产品随附的其他适用条款的约束。TI 提供这些资源并不会扩展或以其他方式更改 TI 针对 TI 产品发布的适用的担保或担保免责声明。

TI 反对并拒绝您可能提出的任何其他或不同的条款。

邮寄地址：Texas Instruments, Post Office Box 655303, Dallas, Texas 75265

Copyright © 2022，德州仪器 (TI) 公司