

1. Block Diagram	2
2. Startup/Sequencing	3
3. Synchronization.....	6
4. DDR Tracking.....	8
5. Efficiency	9
6. Load Step.....	14
7. Frequency Response	16

1. Block Diagram

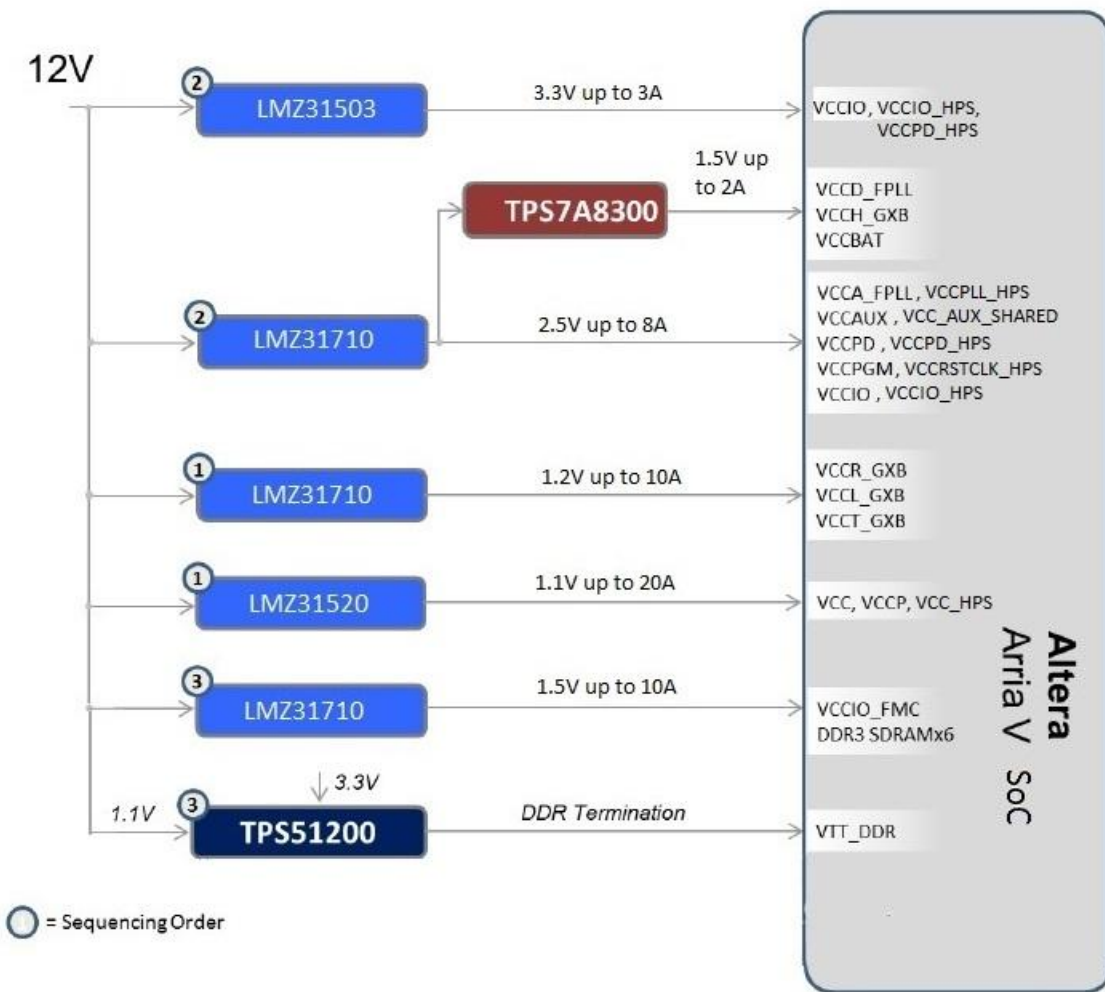

2. Startup/Sequencing

The startup waveform is shown in Figure 1 and Figure 1.1. The input voltage is 12V, with no load at the output.

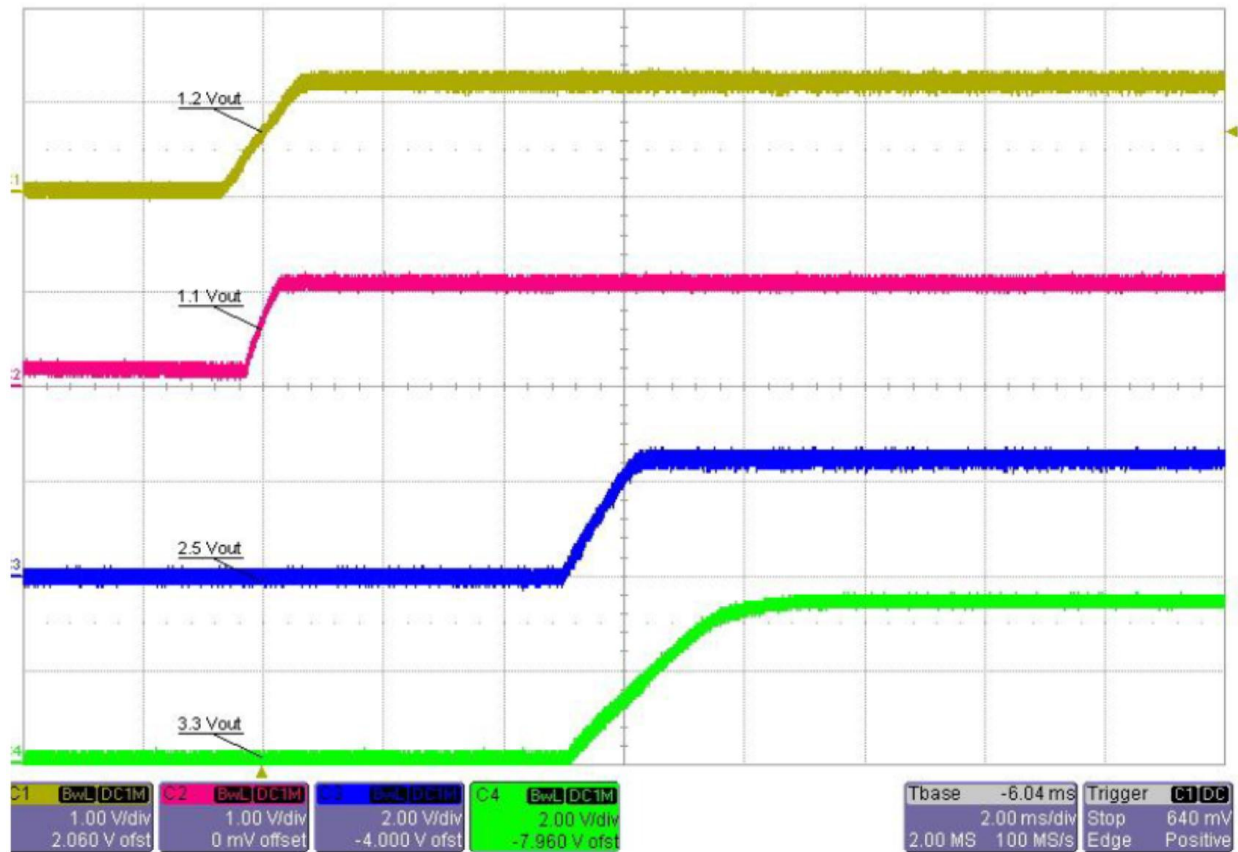

Figure 1

Ch1 => Output voltage 1.2V order #1
 Ch2 => Output voltage 1.1V order #1
 Ch3 => Output voltage 2.5V order #2
 Ch4 => Output voltage 3.3V order #2
 2ms/div
 Full Bandwidth

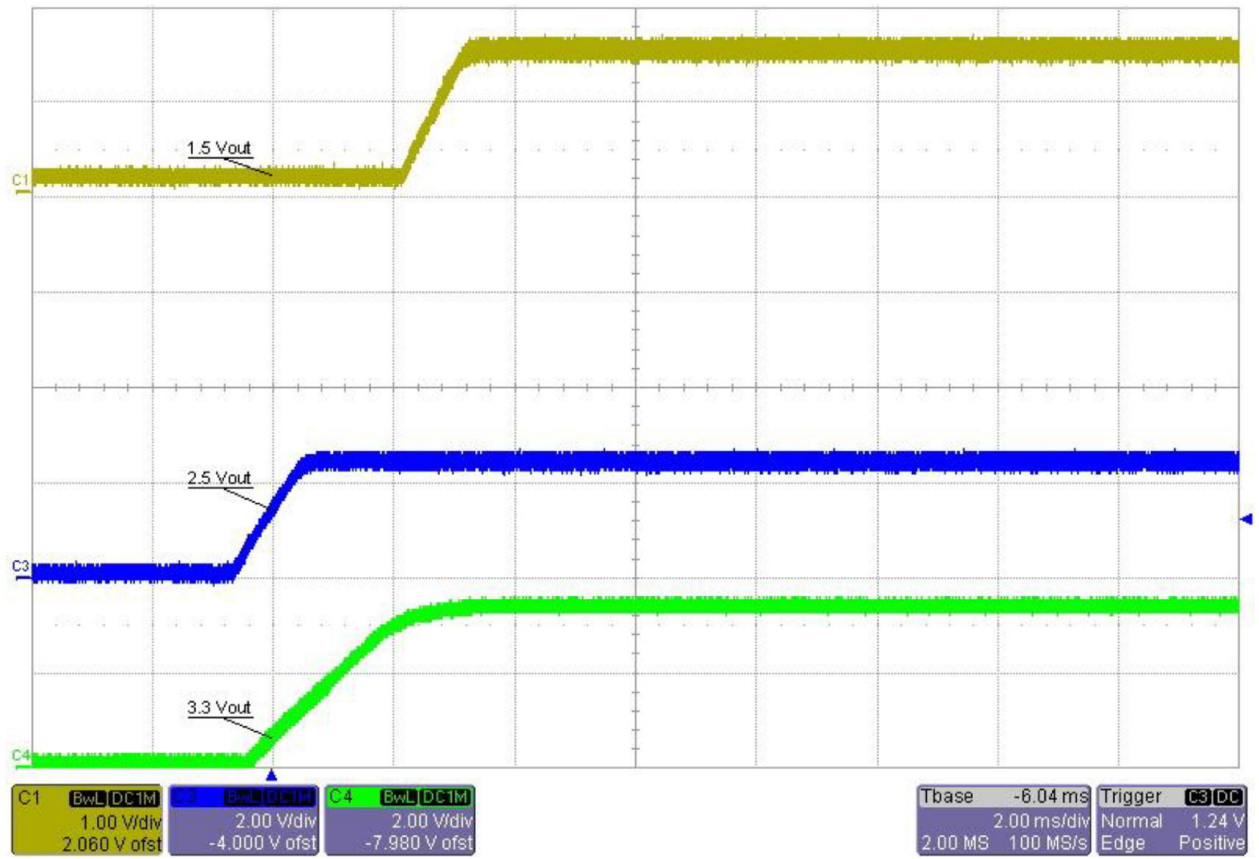

Figure 1.1
Ch1 => Output voltage 1.5V order #3
Ch3 => Output voltage 2.5V order #2
Ch4 => Output voltage 3.3V order #2
2ms/div
Full Bandwidth

A selection of startup waveforms is shown in Figure 1.2 to demonstrate LDO startup. The input voltage is 12V, with no load at the output.

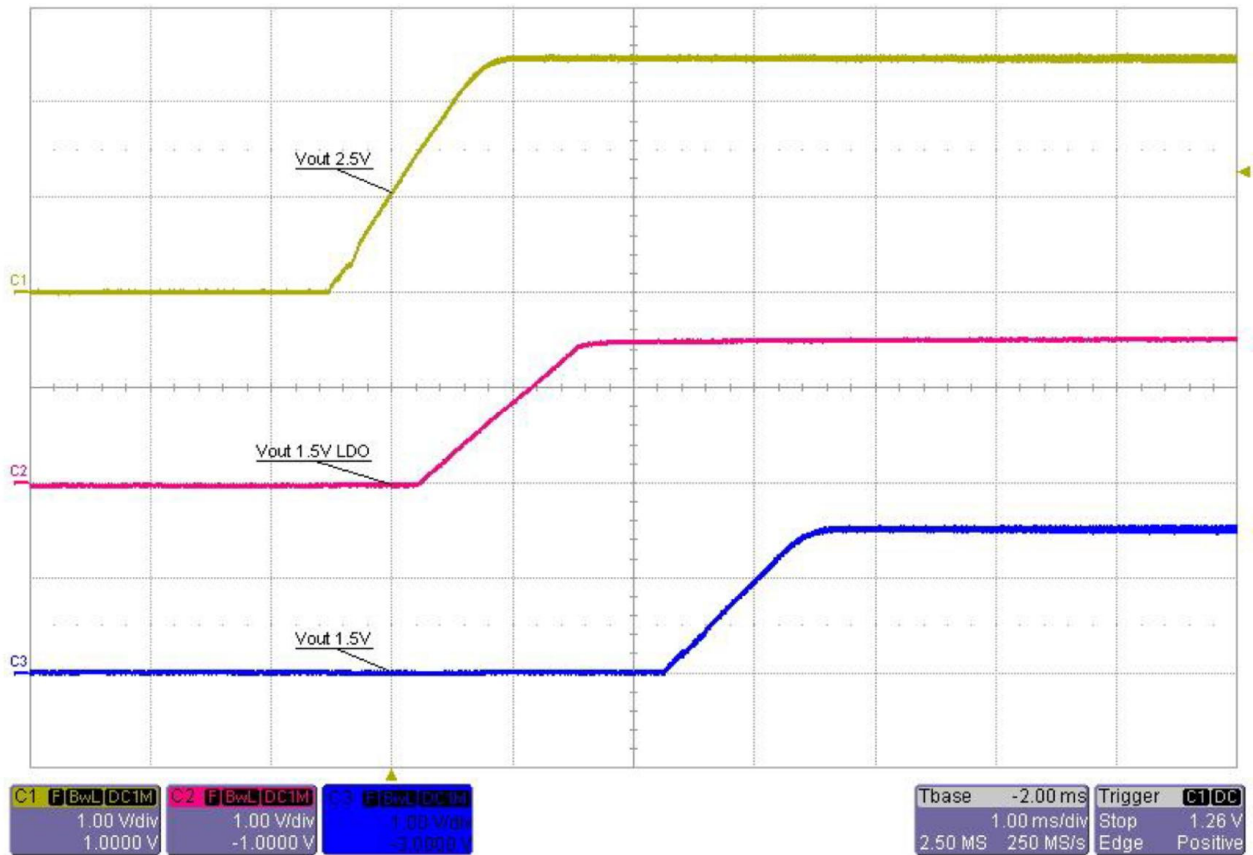

Figure 1.2

Ch1 => Output voltage 2.5V order #2
 Ch2 => LDO Output voltage 1.5V order #2 + LDO delay
 Ch2 => Output Voltage 1.5V order #3
 2.5ms/div
 Full Bandwidth

3. Synchronization

The switching nodes of the buck stages are shown in Figure 2 and Figure 2.1. The input voltage is 12V, with no load at the output.

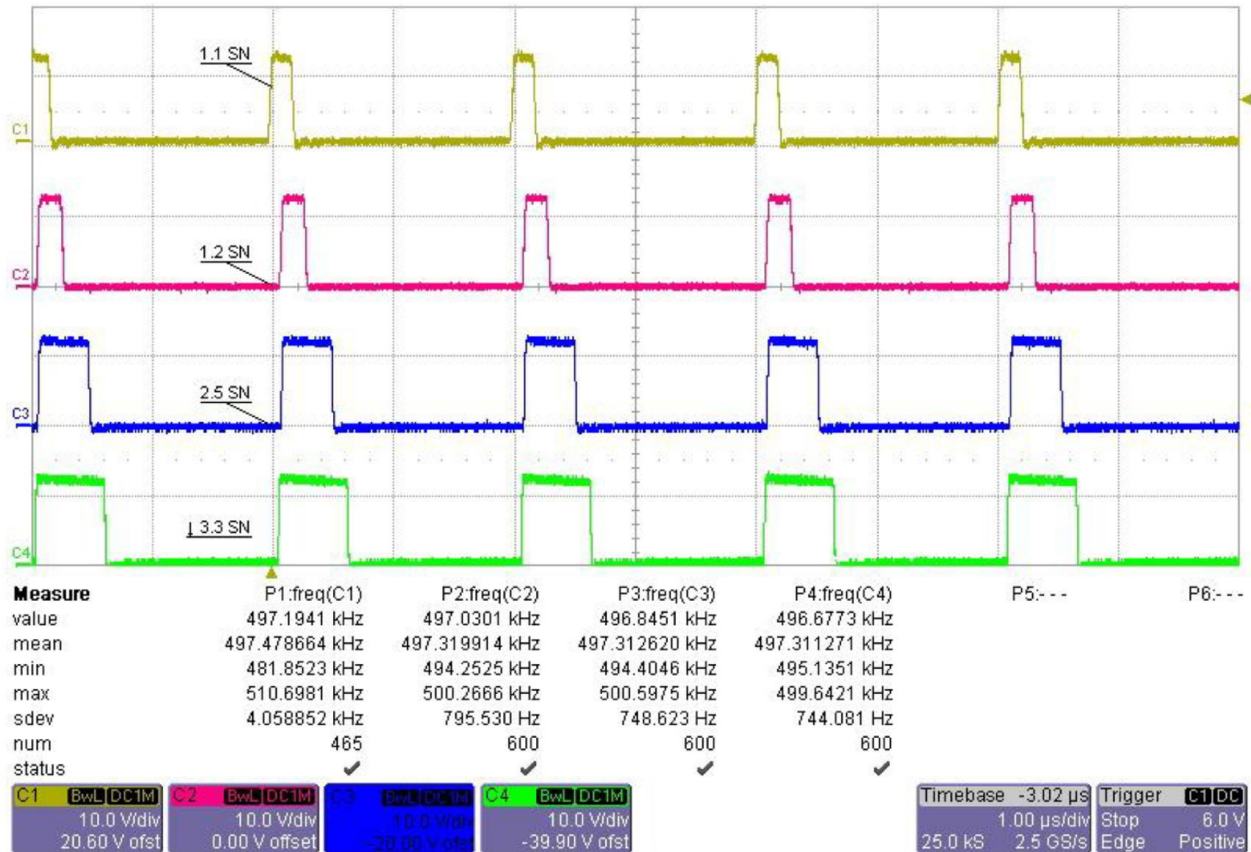

Figure 2

Ch1 => Switching node for 1.1 Vout
 Ch2 => Switching node for 1.2 Vout
 Ch3 => Switching node for 2.5 Vout
 Ch4 => Switching node for 3.3 Vout
 Common frequency: 500 kHz
 1 μ s/div

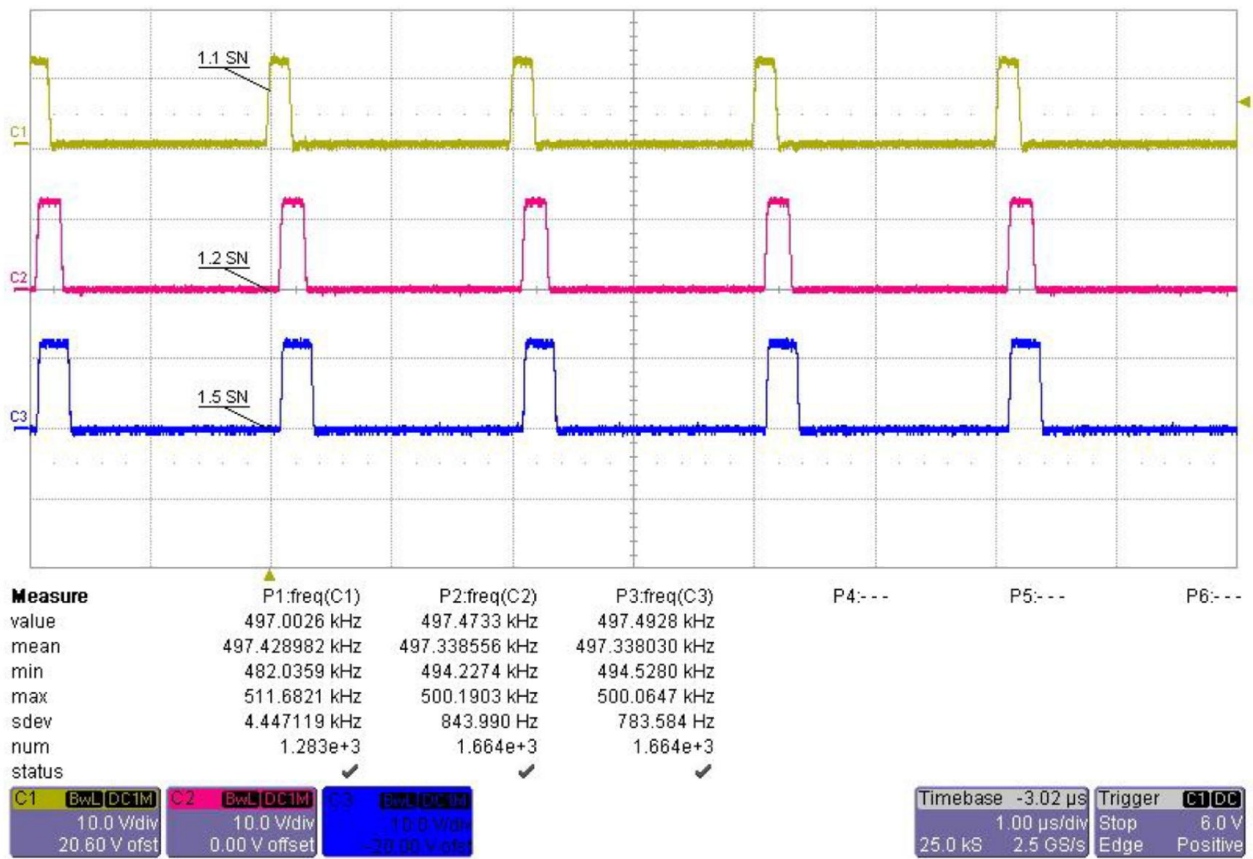

Figure 2.1

Ch1 => Switching node for 1.1 Vout
 Ch2 => Switching node for 1.2 Vout
 Ch3 => Switching node for 1.5 Vout
 Common frequency: 500 kHz
 1 μ s/div
 Full Bandwidth

4. DDR Tracking

DDR tracking is shown in the Figures 5 and 6.

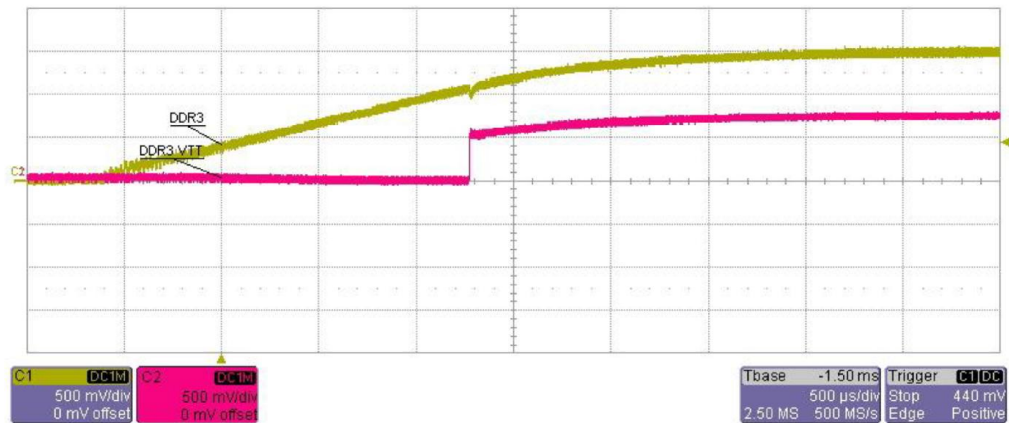

Figure 5

Ch1 => DDR3 1.5V output voltage from buck stage
 Ch2 => DDR3 0.75V termination voltage from TPS51200
 500 μ s/div
 Full Bandwidth

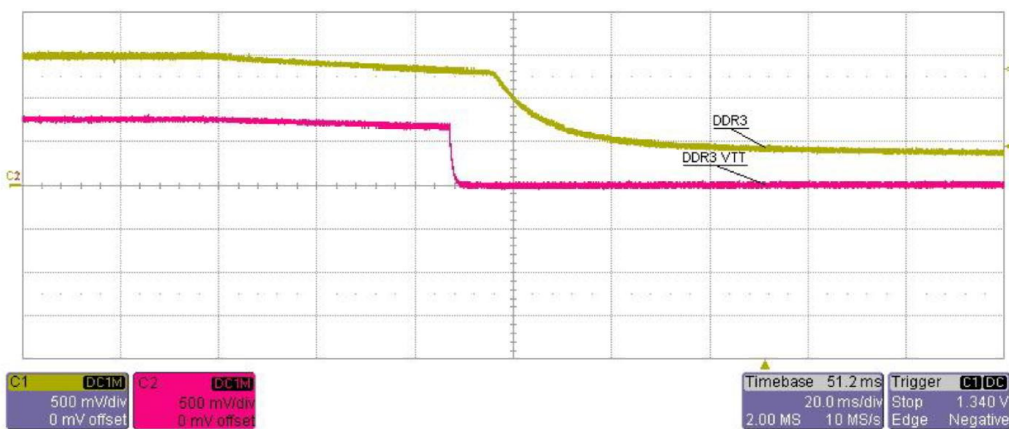

Figure 6

Ch1 => DDR3 1.5V output voltage from buck stage
 Ch2 => DDR3 0.75V termination voltage from TPS51200
 20ms/div
 Full Bandwidth

5. Efficiency

The respective efficiencies of the buck stages providing 3.3V, 2.5V, 1.2V, 1.1V, and 1.5V are shown in Figures 7, 8, 9, 10, and 11 below. The input voltage is 12V.

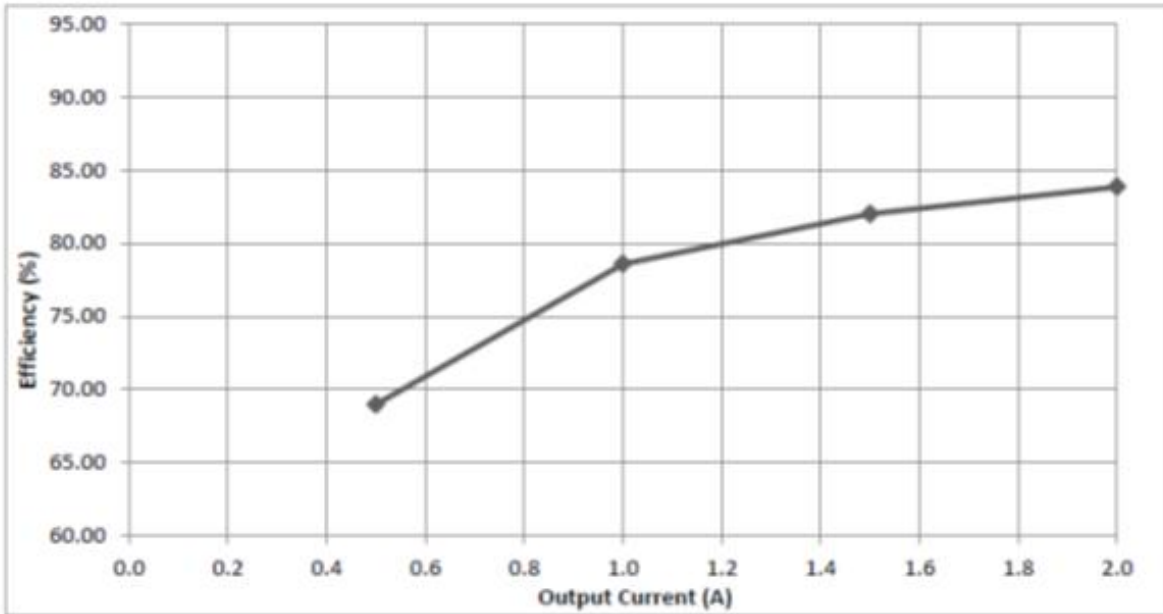

Figure 7: 3.3V Output

V _{IN} (V)	I _{IN} (A)	V _{OUT} (V)	I _{OUT} (A)	P _{IN} (W)	P _{OUT} (W)	Eff (%)
12.00	0.20	3.31	0.5	2.400	1.655	68.96
12.00	0.35	3.3	1.0	4.200	3.300	78.57
12.00	0.50	3.28	1.5	6.000	4.920	82.00
12.00	0.65	3.27	2.0	7.800	6.540	83.85

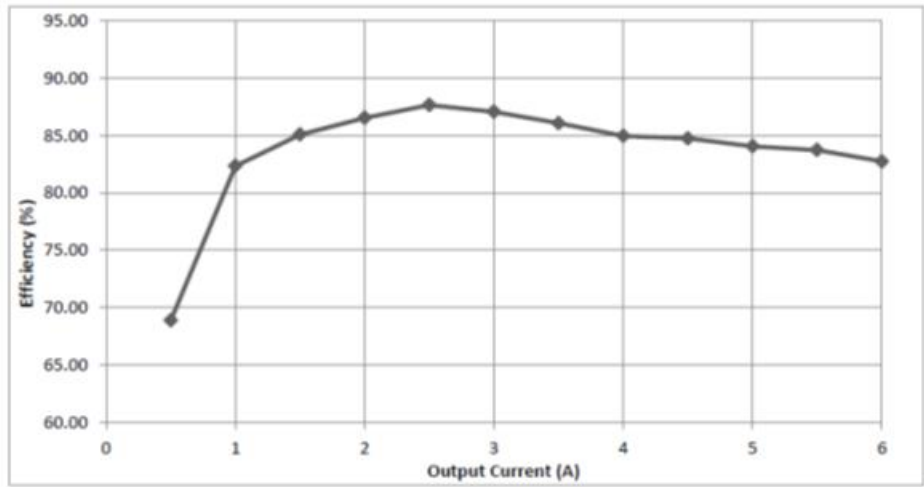

Figure 8: 2.5V Output

V _{IN} (V)	I _{IN} (A)	V _{OUT} (V)	I _{OUT} (A)	P _{IN} (W)	P _{OUT} (W)	Eff (%)
12.00	0.15	2.48	0.5	1.800	1.240	68.89
12.00	0.25	2.47	1.0	3.000	2.470	82.33
12.00	0.36	2.45	1.5	4.320	3.675	85.07
12.00	0.47	2.44	2.0	5.640	4.880	86.52
12.00	0.58	2.44	2.5	6.960	6.100	87.64
12.00	0.70	2.42	3.0	8.340	7.260	87.05
12.00	0.81	2.39	3.5	9.720	8.365	86.06
12.00	0.93	2.37	4.0	11.160	9.480	84.95
12.00	1.04	2.35	4.5	12.480	10.575	84.74
12.00	1.16	2.34	5.0	13.920	11.700	84.05
12.00	1.27	2.32	5.5	15.240	12.760	83.73
12.00	1.39	2.30	6.0	16.680	13.800	82.73

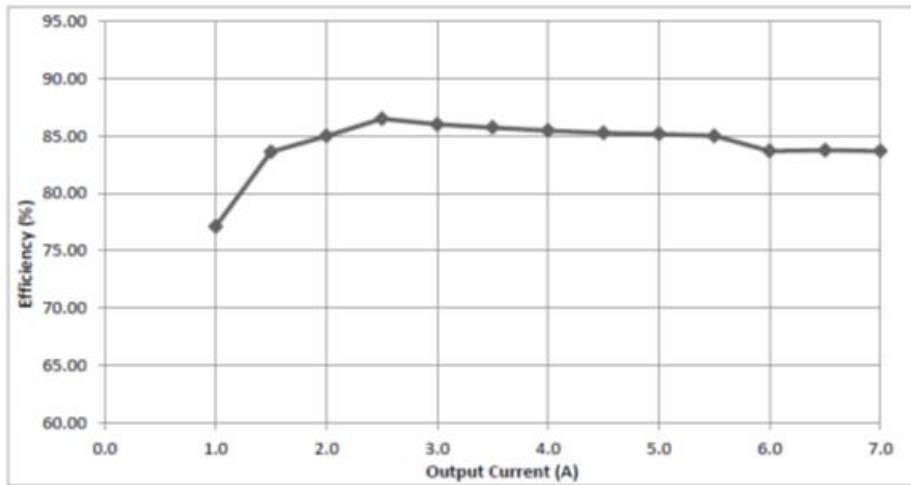

Figure 9: 1.2V Output

V _{IN} (V)	I _{IN} (A)	V _{OUT} (V)	I _{OUT} (A)	P _{IN} (W)	P _{OUT} (W)	Eff (%)
11.99	0.13	1.20	1.0	1.559	1.202	77.12
11.98	0.18	1.20	1.5	2.156	1.803	83.61
11.98	0.24	1.20	2.0	2.875	2.404	84.99
11.98	0.29	1.20	2.5	3.474	3.005	86.49
11.98	0.35	1.20	3.0	4.193	3.606	86.00
11.97	0.41	1.20	3.5	4.908	4.207	85.72
11.97	0.47	1.20	4.0	5.626	4.808	85.46
11.97	0.53	1.20	4.5	6.344	5.409	85.26
11.96	0.59	1.20	5.0	7.056	6.010	85.17
11.96	0.65	1.20	5.5	7.774	6.608	85.00
11.96	0.72	1.20	6.0	8.611	7.206	83.68
11.95	0.78	1.20	6.5	9.321	7.807	83.75
11.96	0.84	1.20	7.0	10.046	8.407	83.68

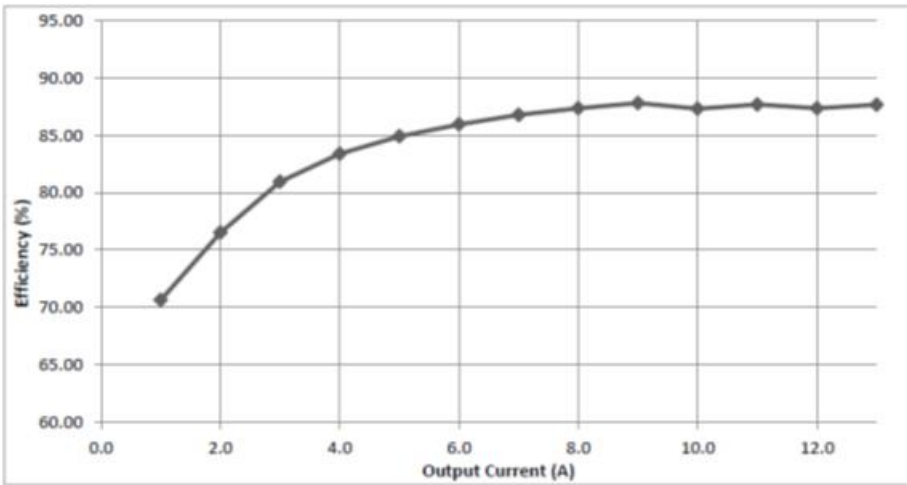

Figure 10: 1.1V Output

V _{IN} (V)	I _{IN} (A)	V _{OUT} (V)	I _{OUT} (A)	P _{IN} (W)	P _{OUT} (W)	Eff (%)
12.01	0.13	1.10	1.0	1.561	1.103	70.65
12.00	0.24	1.10	2.0	2.880	2.204	76.51
12.00	0.34	1.10	3.0	4.080	3.303	80.96
12.00	0.44	1.10	4.0	5.280	4.403	83.39
12.00	0.54	1.10	5.0	6.480	5.502	84.91
12.00	0.64	1.10	6.0	7.680	6.601	85.95
11.99	0.74	1.10	7.0	8.873	7.700	86.78
11.99	0.84	1.10	8.0	10.072	8.798	87.35
11.99	0.94	1.10	9.0	11.271	9.896	87.80
11.99	1.05	1.10	10.0	12.590	10.992	87.31
11.99	1.15	1.10	11.0	13.789	12.089	87.67
11.98	1.26	1.10	12.0	15.095	13.186	87.35
11.98	1.36	1.10	13.0	16.293	14.282	87.66

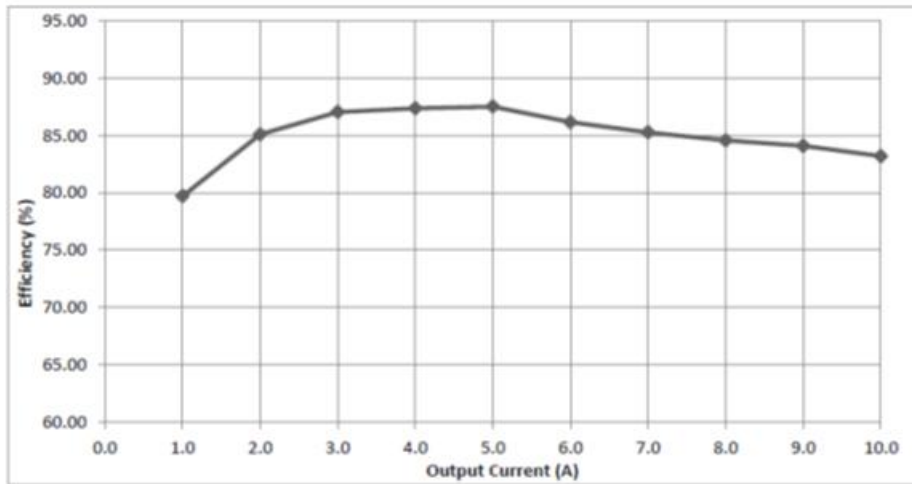
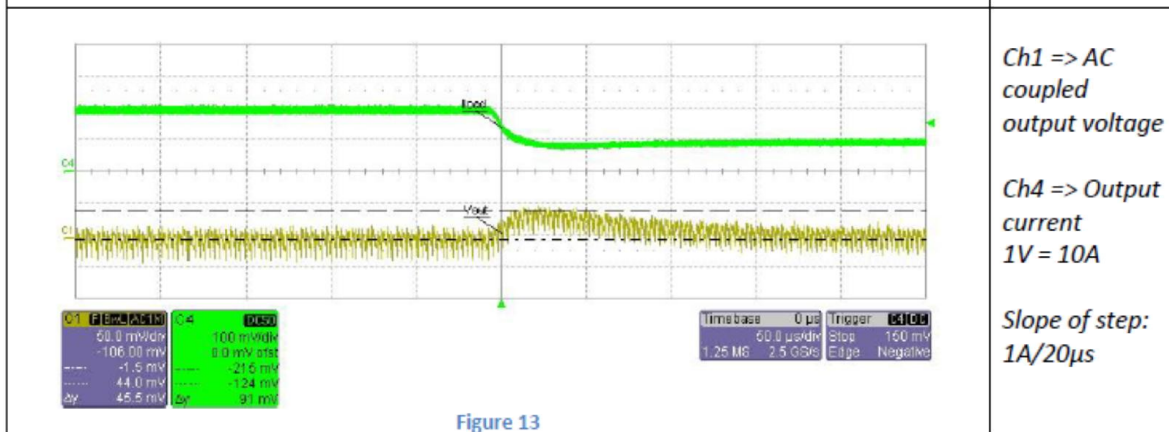
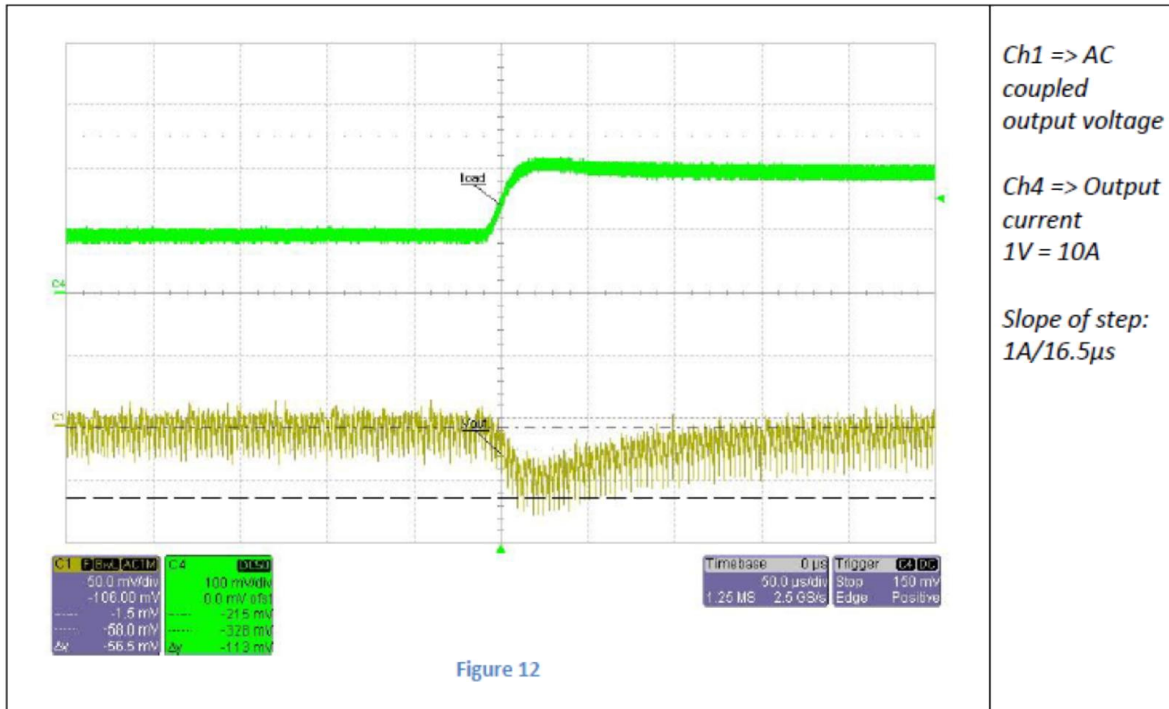

Figure 11: 1.5V Output

V _{IN} (V)	I _{IN} (A)	V _{OUT} (V)	I _{OUT} (A)	P _{IN} (W)	P _{OUT} (W)	Eff (%)
11.99	0.16	1.53	1.0	1.918	1.529	79.70
11.98	0.30	1.53	2.0	3.594	3.058	85.09
11.97	0.44	1.53	3.0	5.267	4.584	87.04
11.96	0.59	1.53	4.0	6.997	6.112	87.36
11.96	0.73	1.53	5.0	8.731	7.640	87.51
11.95	0.89	1.53	6.0	10.636	9.162	86.15
11.94	1.05	1.53	7.0	12.537	10.689	85.26
11.94	1.21	1.53	8.0	14.447	12.216	84.56
11.93	1.37	1.53	9.0	16.344	13.743	84.09
11.92	1.54	1.53	10.0	18.357	15.270	83.18

6. Load Step

The load regulation of the LMZ31503 3.3V output is shown in Figures 12 and 13 below. The input voltage is 12V. The load step increases from 1A to 2A.



The load regulation of the LMZ31710 2.5V output is shown in Figures 14 and 15 below. The input voltage is 12V. The load step increases from 3A to 6A.

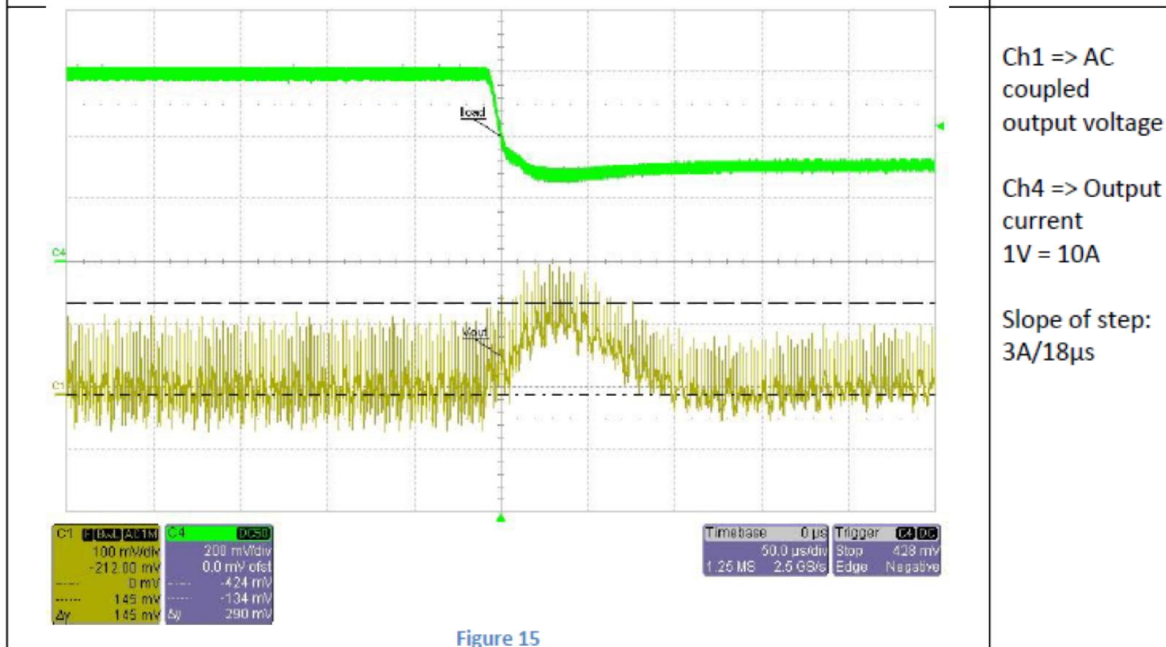
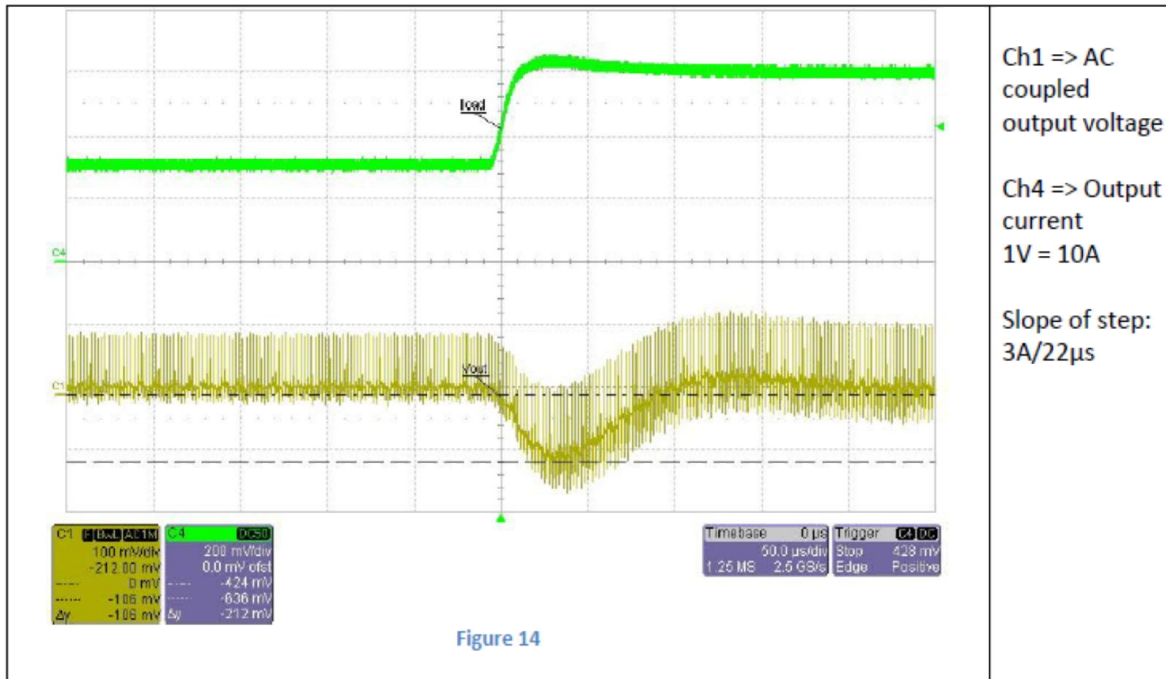

The load regulation of the LMZ31710 1.2V output is shown in the Figures 16 and 17 below. The input voltage is 12V. The load step increases from 3.5A to 7A.

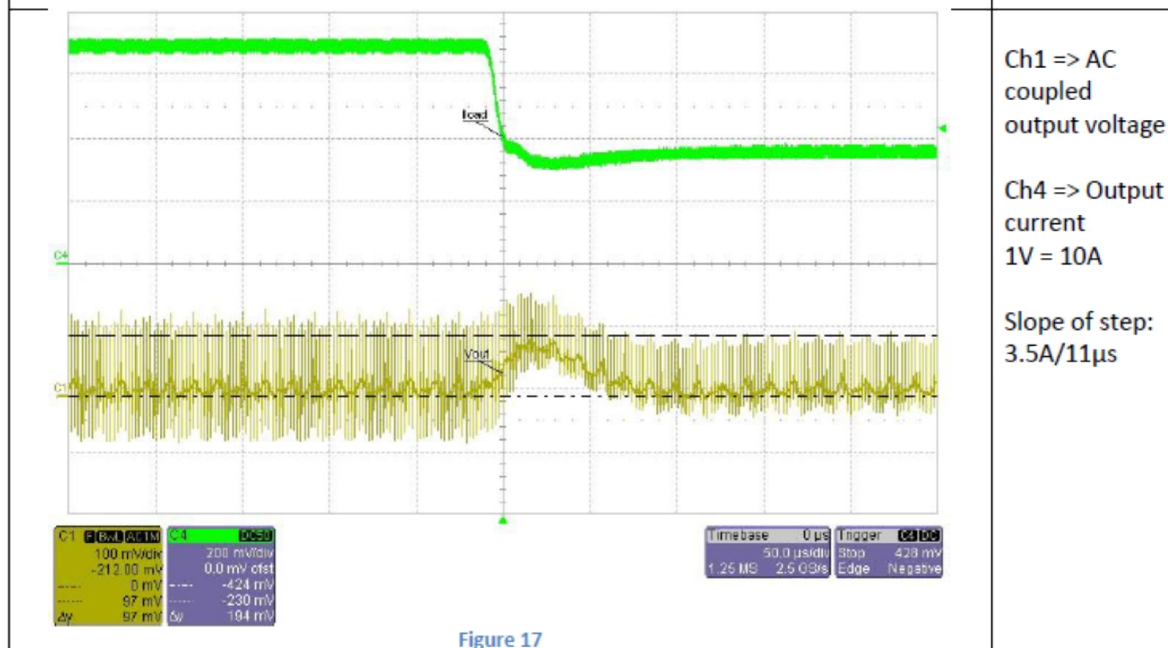
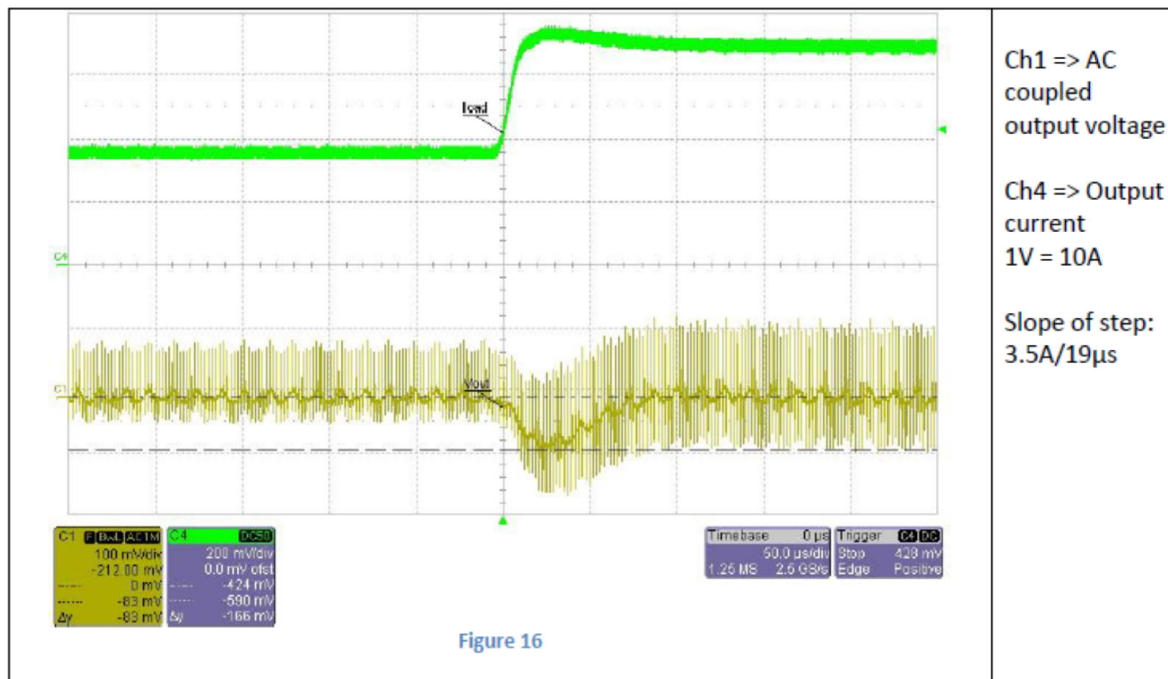

The load regulation of the LMZ31520 1.1V output is shown in the Figures 18 and 19 below. The input voltage is 12V. The load step increases from 6.5A to 13A.

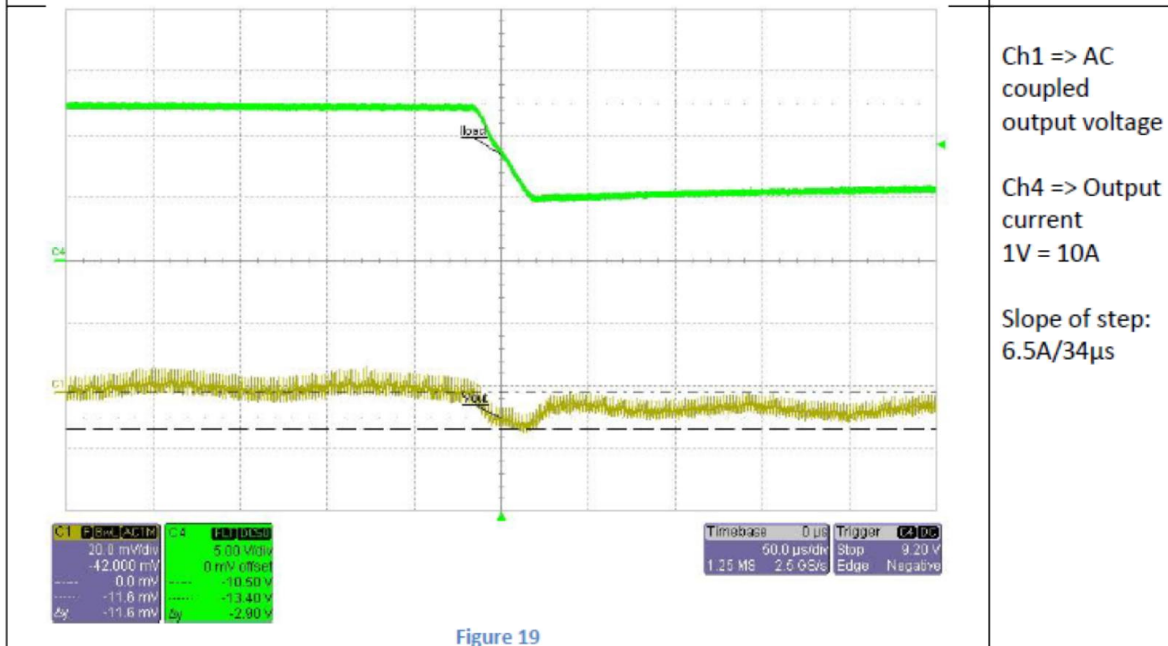
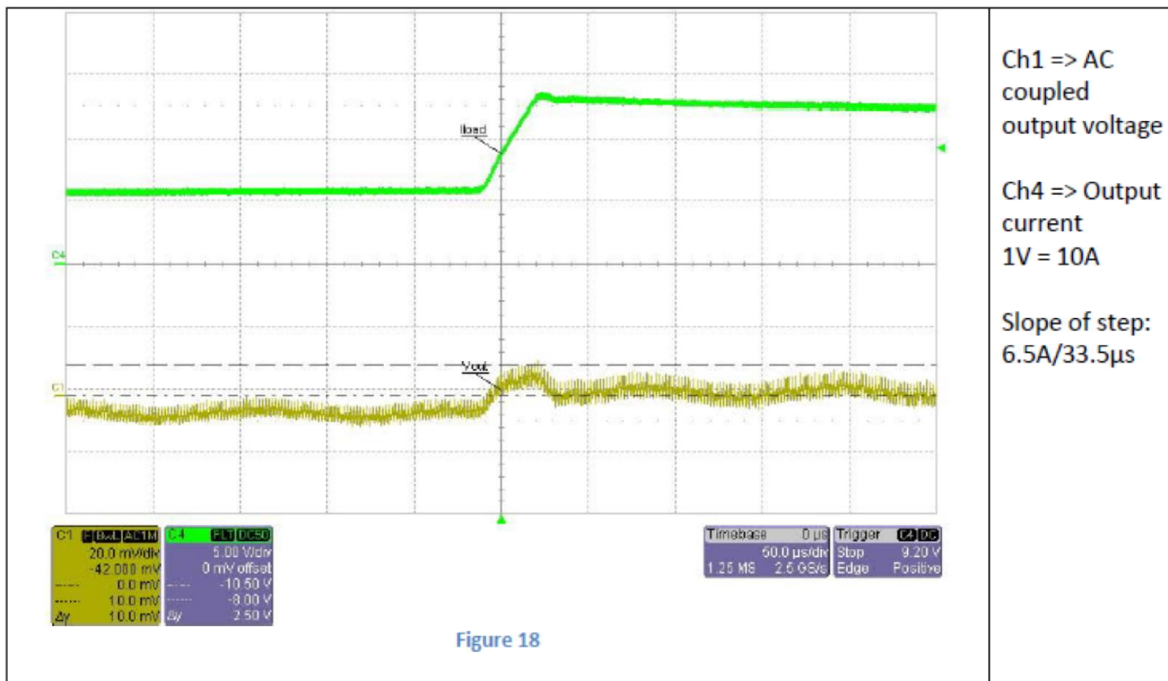

The load regulation of the LMZ31710 1.5V output is shown in the Figures 20 and 21 below. The input voltage is 12V. The load step increases from 4.5A to 9A.

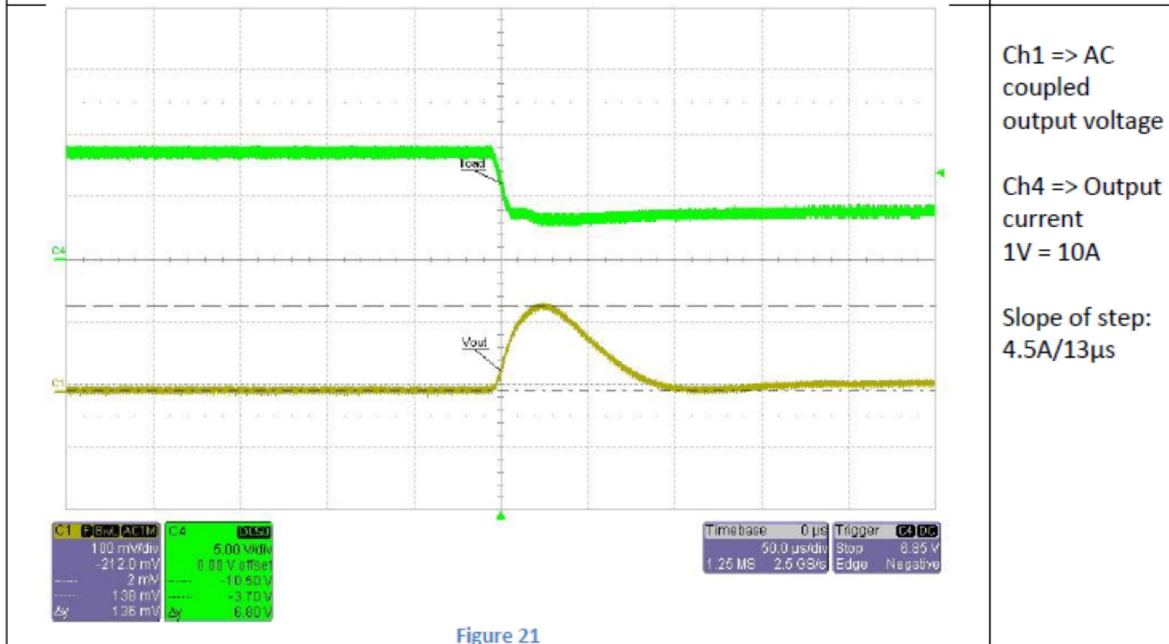
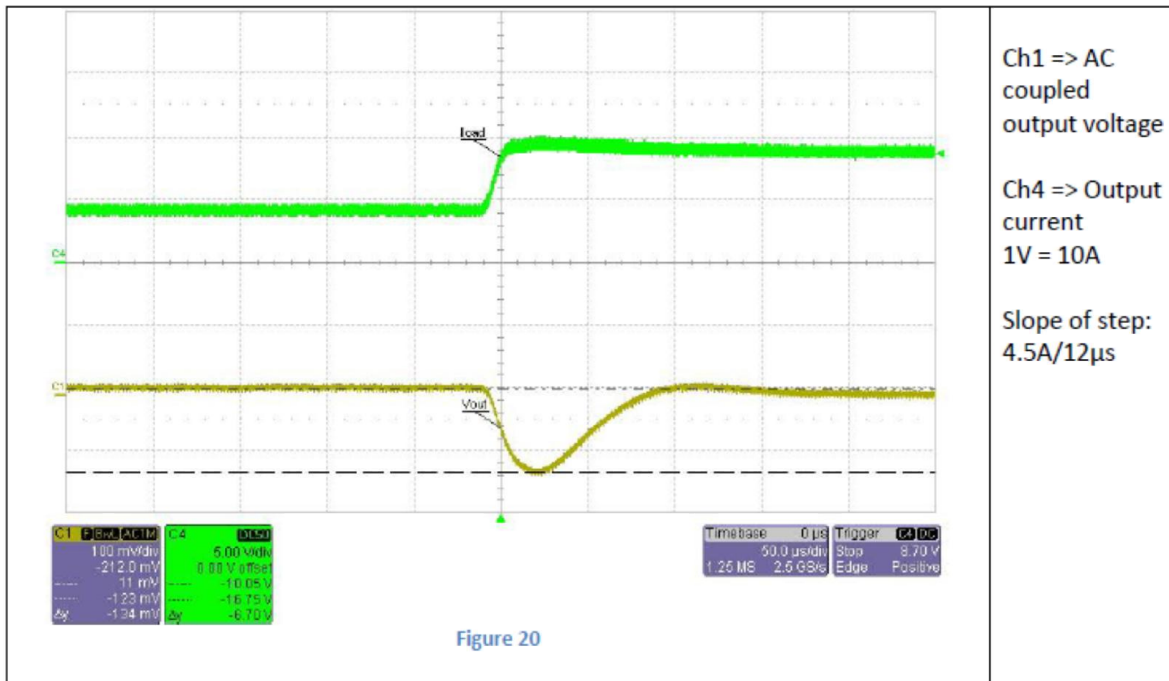

The load regulation of the 1.5V LDO output is shown in the Figures 22 and 23 below. The input voltage is 12V. The load step increases from 0A to 1.2A.

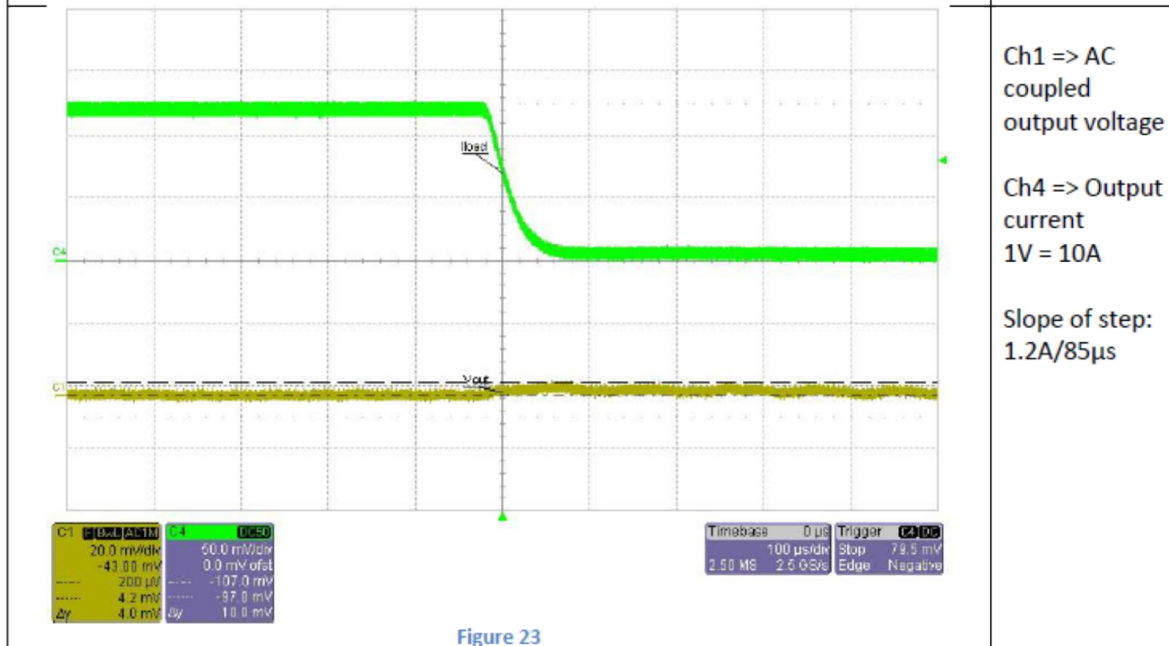
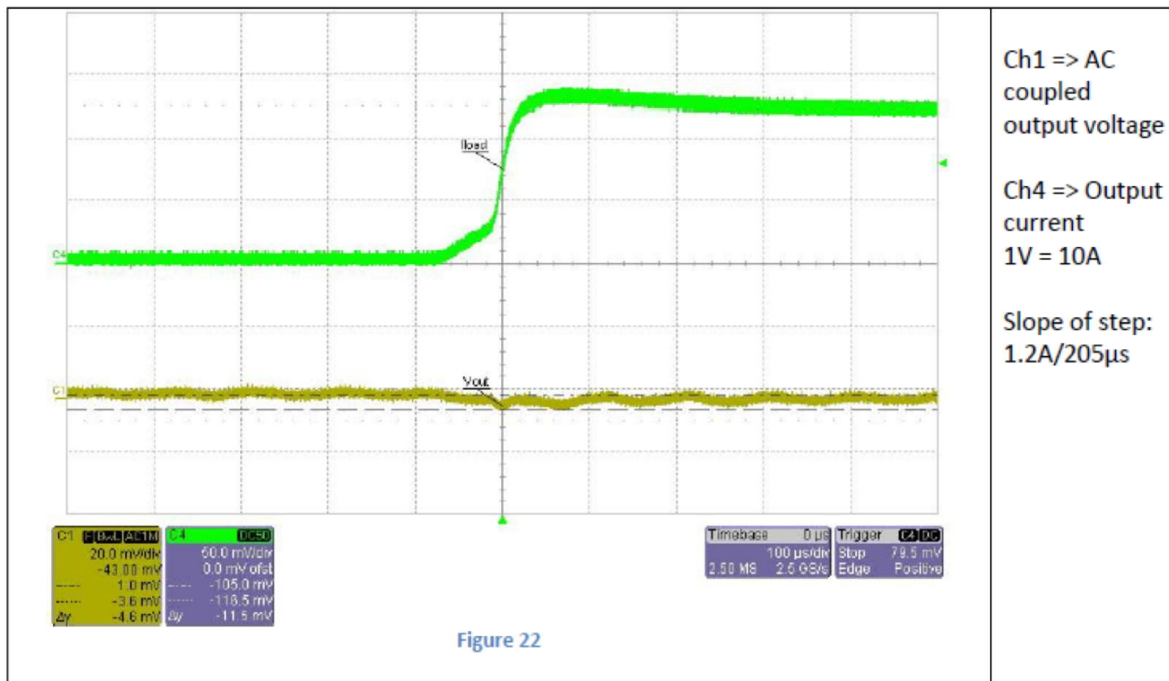

7. Frequency Response

Figure 24 shows the loop response of the LMZ31503 3.3V output with 1A load and 12V input.

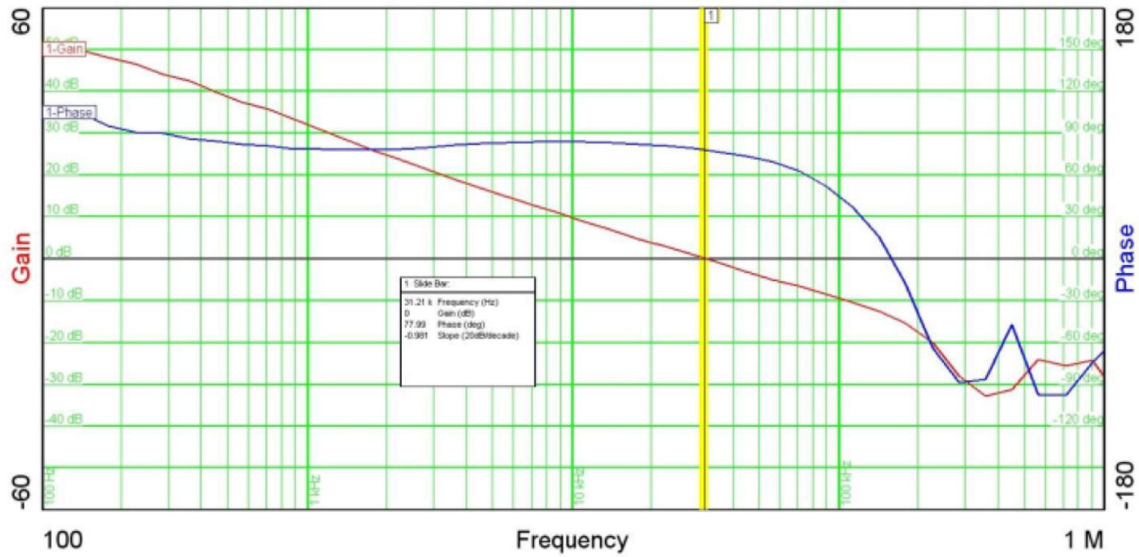

Figure 24

Table 1 summarizes the results from Figure 24.

Bandwidth (kHz)	31.21
Phase Margin	77.99°
Slope (20dB/Decade)	-0.981

Table 1

Figure 25 shows the loop response of the LMZ31710 2.5V output with 3A load and 12V input.

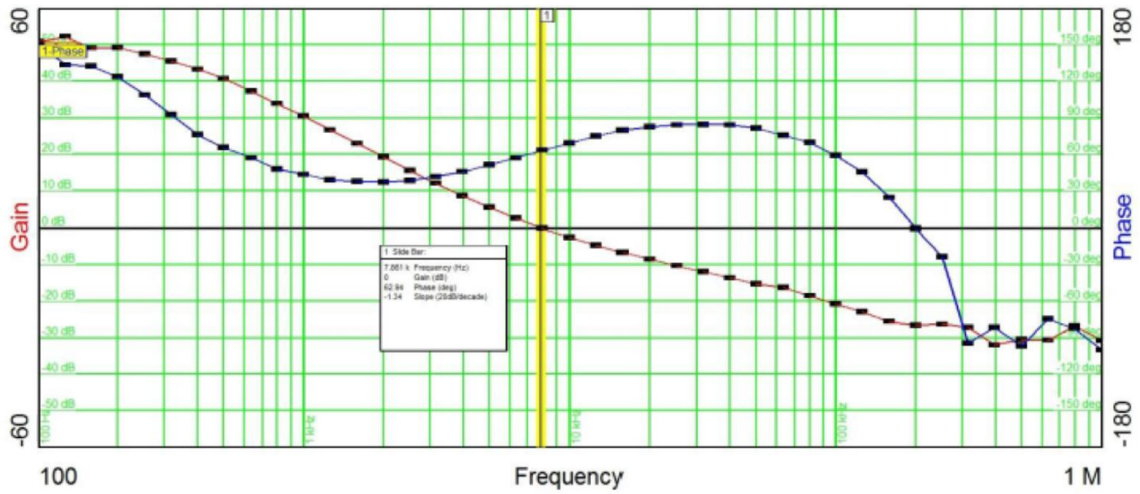

Figure 25

Table 2 summarizes the results from Figure 25.

Bandwidth (kHz)	7.861
Phase Margin	62.94°
Slope (20dB/Decade)	-1.34

Table 2

Figure 26 shows the loop response of the LMZ31710 1.2V output with 3.5A load and 12V input.

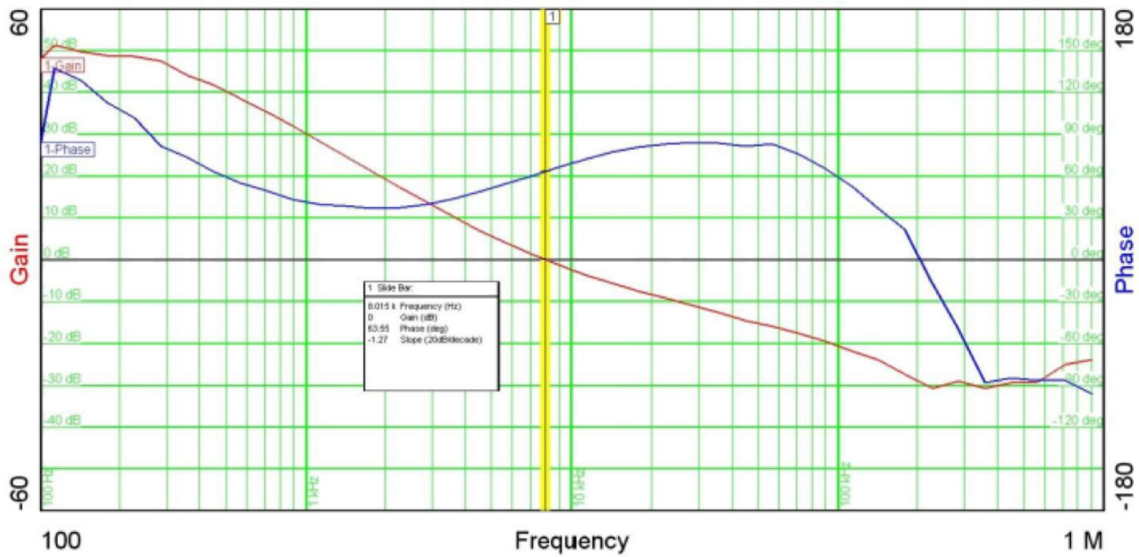

Figure 26

Table 3 summarizes the results from Figure 26.

Bandwidth (kHz)	8.015
Phase Margin	63.55°
Slope (20dB/Decade)	-1.27

Table 3

Figure 27 shows the loop response of the LMZ31520 1.1V output with 2A load and 12V input.

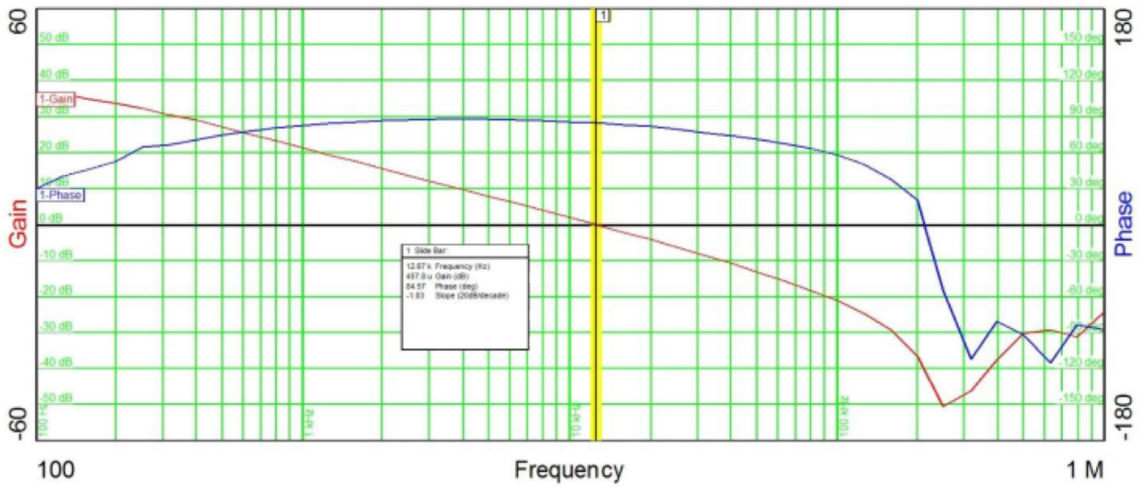

Figure 27

Table 4 summarizes the results from Figure 26.

Bandwidth (kHz)	12.67
Phase Margin	84.57°
Slope (20dB/Decade)	-1.03

Table 4

Figure 28 shows the loop response of the LMZ31710 1.5V output with 5A load and 12V input.

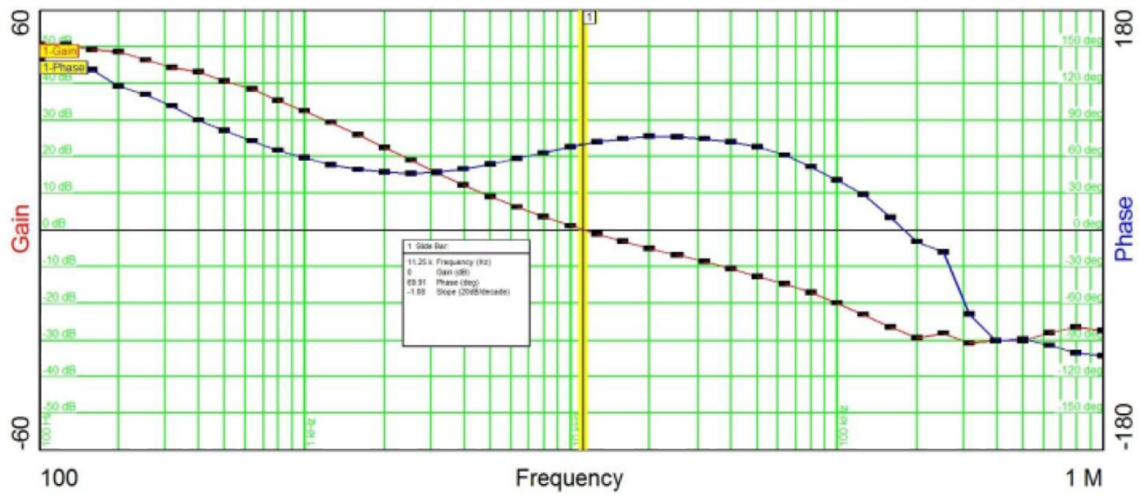

Figure 28

Table 5 summarizes the results from Figure 26.

Bandwidth (kHz)	11.25
Phase Margin	69.9°
Slope (20dB/Decade)	-1.08

Table 5

8. Miscellaneous

In order to synchronize the different buck stages, a square wave clock signal is required with a duty cycle between 20% and 80%. The LMZ31520 is used as the master clock but its duty cycle is only 9.2%. The following schematic and figure show the circuit used in order to provide a clock signal with 50% duty cycle.

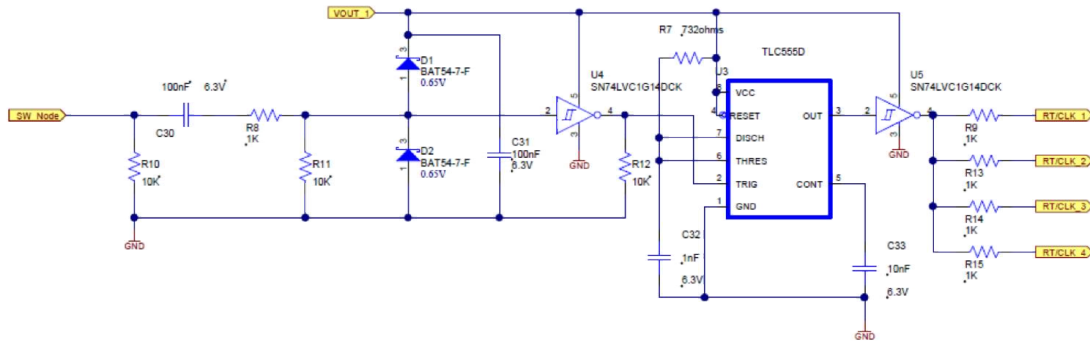

Figure 29:

Synchronization circuit

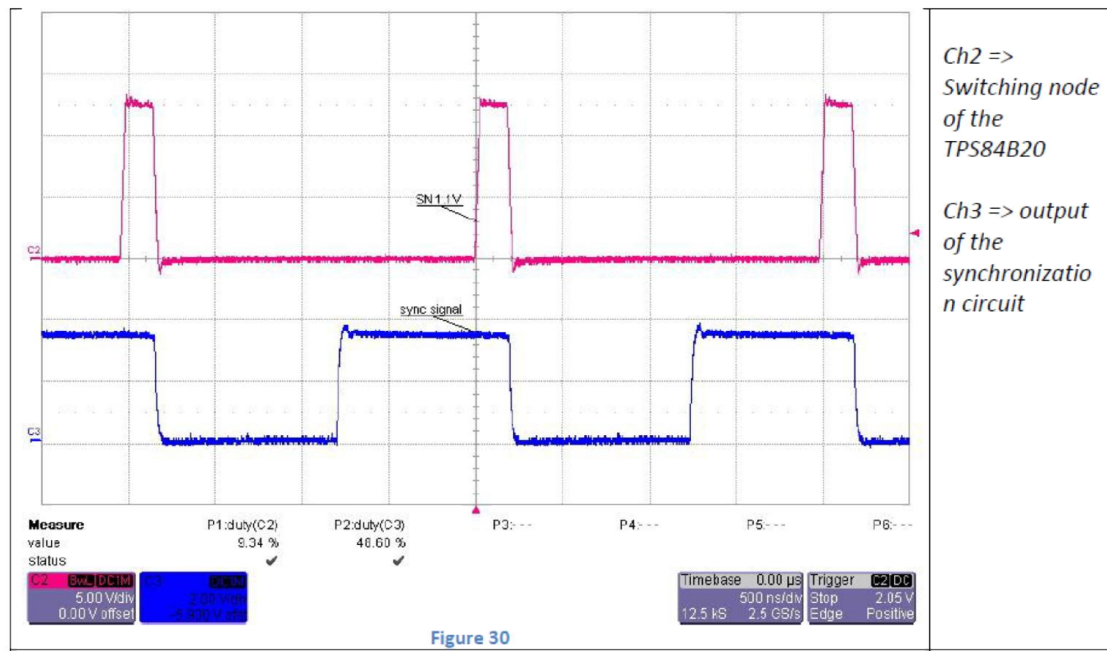

Figure 30

Ch2 => Measured duty cycle of the switching node: 9.3%

Ch3 => Measured duty cycle of the synchronization signal: 48.6%

For Feasibility Evaluation Only, in Laboratory/Development Environments. The reference design is not a complete product. It is intended solely for use for preliminary feasibility evaluation in laboratory / development environments by technically qualified electronics experts who are familiar with the dangers and application risks associated with handling electrical / mechanical components, systems and subsystems. It should not be used as all or part of a production unit.

Your Sole Responsibility and Risk. You acknowledge, represent and agree that:

1. You have unique knowledge concerning Federal, State and local regulatory requirements (including but not limited to Food and Drug Administration regulations, if applicable) which relate to your products and which relate to your use (and/or that of your employees, affiliates, contractors or designees) of the reference design for evaluation, testing and other purposes.
2. You have full and exclusive responsibility to assure the safety and compliance of your products with all such laws and other applicable regulatory requirements, and also to assure the safety of any activities to be conducted by you and/or your employees, affiliates, contractors or designees, using the reference design. Further, you are responsible to assure that any interfaces (electronic and/or mechanical) between the reference design and any human body are designed with suitable isolation and means to safely limit accessible leakage currents to minimize the risk of electrical shock hazard.
3. Since the REFERENCE DESIGN is not a completed product, it may not meet all applicable regulatory and safety compliance standards (such as UL, CSA, VDE, CE, RoHS and WEEE) which may normally be associated with similar items. You assume full responsibility to determine and/or assure compliance with any such standards and related certifications as may be applicable. You will employ reasonable safeguards to ensure that your use of the reference design will not result in any property damage, injury or death, even if the REFERENCE DESIGN should fail to perform as described or expected.

Certain Instructions. Exceeding the specified reference design ratings (including but not limited to input and output voltage, current, power, and environmental ranges) may cause property damage, personal injury or death. If there are questions concerning these ratings please contact a TI field representative prior to connecting interface electronics including input power and intended loads. Any loads applied outside of the specified output range may result in unintended and/or inaccurate operation and/or possible permanent damage to the reference design and/or interface electronics. Please consult the reference design User's Guide prior to connecting any load to the reference design output. If there is uncertainty as to the load specification, please contact a TI field representative. During normal operation, some circuit components may have case temperatures greater than 60°C as long as the input and output ranges are maintained at nominal ambient operating temperature. These components include but are not limited to linear regulators, switching transistors, pass transistors, and current sense resistors which can be identified using the reference design schematic. When placing measurement probes near these devices during normal operation, please be aware that these devices may be very warm to the touch.

Agreement to Defend, Indemnify and Hold Harmless. You agree to defend, indemnify and hold TI, its licensors and their representatives harmless from and against any and all claims, damages, losses, expenses, costs and liabilities (collectively, “Claims”) arising out of or in connection with any use of the reference design that is not in accordance with the terms of this agreement. This obligation shall apply whether Claims arise under the law of tort or contract or any other legal theory, and even if the reference design fails to perform as described or expected.

Safety-Critical or Life-Critical Applications. If you intend to evaluate TI components for possible use in safety-critical applications (such as life support) where a failure of the TI product would reasonably be expected to cause severe personal injury or death, such as devices which are classified as FDA Class III or similar classification, then you must specifically notify TI of such intent and enter into a separate Assurance and Indemnity Agreement.

IMPORTANT NOTICE AND DISCLAIMER

TI PROVIDES TECHNICAL AND RELIABILITY DATA (INCLUDING DATA SHEETS), DESIGN RESOURCES (INCLUDING REFERENCE DESIGNS), APPLICATION OR OTHER DESIGN ADVICE, WEB TOOLS, SAFETY INFORMATION, AND OTHER RESOURCES "AS IS" AND WITH ALL FAULTS, AND DISCLAIMS ALL WARRANTIES, EXPRESS AND IMPLIED, INCLUDING WITHOUT LIMITATION ANY IMPLIED WARRANTIES OF MERCHANTABILITY, FITNESS FOR A PARTICULAR PURPOSE OR NON-INFRINGEMENT OF THIRD PARTY INTELLECTUAL PROPERTY RIGHTS.

These resources are intended for skilled developers designing with TI products. You are solely responsible for (1) selecting the appropriate TI products for your application, (2) designing, validating and testing your application, and (3) ensuring your application meets applicable standards, and any other safety, security, regulatory or other requirements.

These resources are subject to change without notice. TI grants you permission to use these resources only for development of an application that uses the TI products described in the resource. Other reproduction and display of these resources is prohibited. No license is granted to any other TI intellectual property right or to any third party intellectual property right. TI disclaims responsibility for, and you will fully indemnify TI and its representatives against, any claims, damages, costs, losses, and liabilities arising out of your use of these resources.

TI's products are provided subject to [TI's Terms of Sale](#) or other applicable terms available either on ti.com or provided in conjunction with such TI products. TI's provision of these resources does not expand or otherwise alter TI's applicable warranties or warranty disclaimers for TI products.

TI objects to and rejects any additional or different terms you may have proposed.

Mailing Address: Texas Instruments, Post Office Box 655303, Dallas, Texas 75265
Copyright © 2021, Texas Instruments Incorporated