

SMP-TPS7A1650-MVK MAVRK Submodule User's Guide

User's Guide



Literature Number: SLVU718

April 2012

| | | |
|----------|--|-----------|
| 1 | Introduction | 4 |
| 2 | EVM Overview | 4 |
| | 2.1 EVM Description | 4 |
| | 2.2 Features | 5 |
| | 2.3 Featured Applications | 5 |
| | 2.4 Highlighted Products | 5 |
| | 2.5 Block Diagram | 6 |
| | 2.6 EVM Wiki | 6 |
| | 2.7 EVM Landing Page | 6 |
| 3 | Hardware Description | 6 |
| | 3.1 Power Requirements | 6 |
| | 3.2 Connector Signal Descriptions | 7 |
| | 3.3 Getting Started: Configuring the EVM | 7 |
| 4 | Board Files | 8 |
| | 4.1 Bill of Materials (BOM) | 8 |
| | 4.2 Layout (PDF) | 9 |
| | 4.3 Schematics (PDF) | 11 |
| | 4.4 Fabrication Drawings (PDF) | 12 |
| | 4.5 Gerber Files | 12 |
| | 4.6 Cadence Schematic and Board Files | 13 |
| 5 | MAVRK Links | 13 |
| | 5.1 Additional Information on MAVRK | 13 |
| | 5.2 MAVRK Questions | 13 |
| | 5.3 Additional Technical Information on MAVRK Hardware | 13 |
| | 5.4 Additional Technical Information on MAVRK Software | 13 |
| | 5.5 Obtaining a MAVRK Board | 13 |
| 6 | Precautions and Certifications | 14 |
| | 6.1 ESD Precautions | 14 |
| | 6.2 Certifications | 14 |

List of Figures

| | | |
|----|--|----|
| 1 | SMP-TPS7A1650-MVK MAVRK Submodule..... | 4 |
| 2 | SMP-TPS7A1650-MVK Block Diagram | 6 |
| 3 | TPS7A1650 Dropout Voltage Versus Output Current..... | 6 |
| 4 | SMP-TPS7A1650-MVK Board Layer 1 – Top Side..... | 9 |
| 5 | SMP-TPS7A1650-MVK Board Layer 2 – Ground Plane..... | 9 |
| 6 | SMP-TPS7A1650-MVK Board Layer 3 – Ground Plane..... | 9 |
| 7 | SMP-TPS7A1650-MVK Board Layer 4 – Bottom Side..... | 9 |
| 8 | SMP-TPS7A1650-MVK Board Solder Mask – Top Side | 10 |
| 9 | SMP-TPS7A1650-MVK Board Solder Mask – Bottom Side | 10 |
| 10 | SMP-TPS7A1650-MVK Board Silkscreen – Top Side..... | 10 |
| 11 | SMP-TPS7A1650-MVK Board Silkscreen – Bottom Side..... | 10 |
| 12 | SMP-TPS7A1650-MVK Board Layer 1 – Top Side | 11 |
| 13 | SMP-TPS7A1650-MVK Board Layer 4 – Bottom Side | 11 |
| 14 | SMP-TPS7A1650-MVK Schematic..... | 11 |
| 15 | SMP-TPS7A1650-MVK Fabrication Drawing | 12 |
| 16 | SMP-TPS7A1650-MVK Gerber File..... | 12 |
| 17 | SMP-TPS7A1650-MVK Cadence Schematic and Board File | 13 |

List of Tables

| | | |
|---|---|---|
| 1 | SMP-TPS7A1650-MVK Bill of Materials | 8 |
|---|---|---|

SMP-TPS7A1650-MVK MAVRK Submodule User's Guide

1 Introduction

This document discusses the Modular and Versatile Reference Kit (MAVRK) [TPS7A1650](#) low-dropout [linear regulator](#) (LDO) submodule. After reading this guide, a developer should understand the features of the [SMP-TPS7A1650-MVK](#). For more information on the MAVRK system, see the [MAVRK Introduction page](#).

2 EVM Overview

The [SMP-TPS7A1650-MVK](#) highlights the [TPS7A1650](#) LDO with enable and power good. This submodule is intended for converting up to 60 V DC down to 5 V on [MAVRK PMU](#) modules, such as the [PMU-CARRIER-MVK](#) and [PMU-BAT-MVK](#).

2.1 EVM Description

[Figure 1](#) shows the SMP-TPS7A1650-MVK MAVRK submodule.

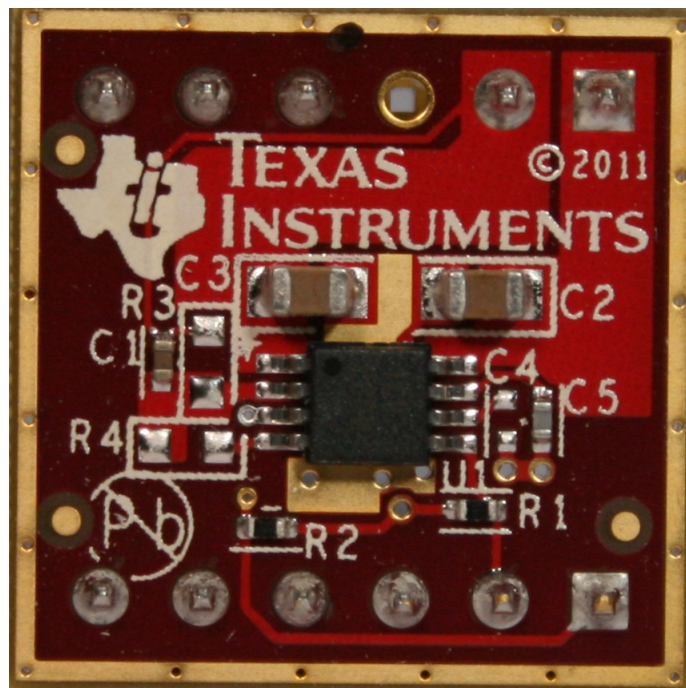

Figure 1. SMP-TPS7A1650-MVK MAVRK Submodule

The [SMP-TPS7A1650-MVK](#) contains the [TPS7A1650](#) integrated circuit and all other onboard components necessary to generate 5 V from a source of up to 60 V. The [SMP-TPS7A1650-MVK](#) can be used with a [MAVRK PMU](#) carrier board to evaluate the [TPS7A1650](#) performance as part of a power-management system. An onboard I²C™ temperature sensor can report the board temperature to the carrier board.

PowerPAD is a trademark of Texas Instruments.
 I²C is a trademark of Phillips Semiconductor.

2.2 Features

2.2.1 TPS7A1650

- Wide input voltage range: 3 to 60 V
- Ultralow quiescent current: 5 μ A
- Quiescent current at shutdown: 1 μ A
- Output current: 100 mA
- Low dropout voltage: 60 mV at 20 mA
- Accuracy: 2%
- Fixed 3.3-V output
- Power good with programmable delay
- Current-limit and thermal shutdown protections
- Stable with ceramic output capacitors \geq 2.2 μ F
- Package: high thermal performance MSOP-8 PowerPAD™
- Operating temperature range: -40°C to 125°C

2.2.2 SMP-TPS7A1650-MVK

- Fixed 5-V output
- Onboard [TMP103](#) I²C temperature sensor
- Compatible with [MAVRK PMU](#) carrier boards
- Breadboard compatible with 0.1-inch headers

2.3 Featured Applications

The [SMP-TPS7A1650-MVK](#) MAVRK submodule can be used on the following applications:

- Supply rails for operational amplifiers, DACs, ADCs, and other high-precision analog circuitry
- Audio
- Post DC-DC converter regulation and ripple filtering
- Test and measurement
- RX, TX, and PA circuitry
- Industrial instrumentation
- Base stations and telecommunications infrastructure

2.4 Highlighted Products

The [SMP-TPS7A1650-MVK](#) MAVRK submodule highlights the following devices:

- [TPS7A1650 60-V, 5- \$\mu\$ A I_q, 100-mA, low-dropout voltage regulator with enable and power good](#)
- [TMP103 digital temperature sensor with I2C/SMBUS expanded interface](#)

2.5 Block Diagram

Figure 2 shows the SMP-TPS7A1650-MVK MAVRK block diagram.

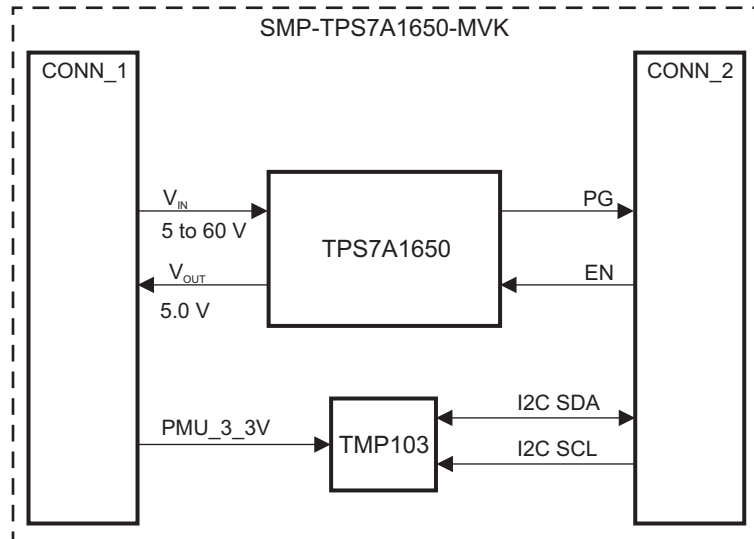

Figure 2. SMP-TPS7A1650-MVK Block Diagram

2.6 EVM Wiki

The most up-to-date information on this module is found at the [SMP-TPS7A1650-MVK MAVRK submodule wiki page](#).

2.7 EVM Landing Page

Ordering information and availability of this module is found at the [SMP-TPS7A1650-MVK MAVRK submodule tool folder](#).

3 Hardware Description

3.1 Power Requirements

The [SMP-TPS7A1650-MVK](#) can accept an input of 5 to 60 V from the carrier board, and generates a fixed 5-V output. The minimum input voltage required for regulation is the 5-V output plus the dropout voltage of the LDO, shown in [Figure 3](#).

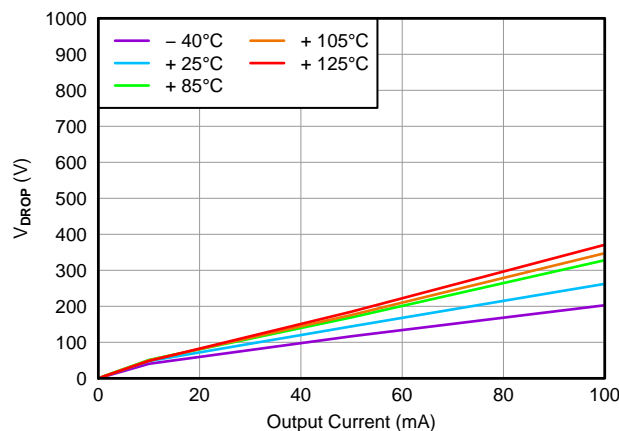

Figure 3. TPS7A1650 Dropout Voltage Versus Output Current

The output current of the [SMP-TPS7A1650-MVK](#) must not exceed 100 mA. Due to the small PCB area of the [SMP-TPS7A1650-MVK](#), it is recommended not to exceed 0.75 W of power consumption on the board. The power consumption can be estimated as $(V_{IN} - V_{OUT}) \times I_{OUT}$. The onboard temperature sensor can be used to measure the temperature rise at different power levels.

The [SMP-TPS7A1650-MVK](#) can be used in a breadboard if pin 4 of CONN_1 (PMU_3_3V) is tied to a pullup voltage within the enable (EN) voltage range of the device. To avoid damage to the onboard temperature sensor, this voltage must not exceed 3.6 V. For connector pinout information, see the [Hardware Design Guide for MAVRK PMU DC/DC Modules](#) .

3.2 Connector Signal Descriptions

For information about the [SMP-TPS7A1650-MVK](#) connector pinouts, see the [Hardware Design Guide for MAVRK PMU DC/DC Modules](#).

3.3 Getting Started: Configuring the EVM

The [SMP-TPS7A1650-MVK](#) must be connected to a DC-DC converter slot on a [MAVRK PMU](#) carrier board, such as the [PMU-CARRIER-MVK](#) or [PMU-BAT-MVK](#). Do not exceed the carrier board voltage and current limits when using this module. For detailed setup information, see the [Configuring Power Submodules on a PMU Carrier Board](#) page.

4 Board Files

4.1 Bill of Materials (BOM)

Table 1 lists the bill of materials.

[Download PDF](#) of the bill of materials.

Table 1. SMP-TPS7A1650-MVK Bill of Materials

| Item | Quantity | Reference Designator | Value | Part Description | Temperature °C | Manufacturer | Manufacturer Part Number |
|------|----------|----------------------|------------------|--|----------------|--------------------|--------------------------|
| 1 | 1 | C1 | 10 nF | Capacitor, ceramic, 10 nF 25 V, ±10%, X7R, 0402 | -55 to 125 | Taiyo Yuden | TMK105B7103KV-F |
| 2 | 2 | C2 C3 | 10 uF | Capacitor, ceramic, 10 uF 25 V, ±10%, X5R, 0805 | -55 to 85 | Murata Electronics | GRM21BR61E106KA73L |
| 3 | 0 | C4 | 10 nF | Capacitor, ceramic, 10 nF 25 V, ±10%, X7R, 0402 | -55 to 125 | Taiyo Yuden | TMK105B7103KV-F |
| 4 | 1 | C5 | 0.001 uF | Capacitor, ceramic, 1000 pF 50 V, C0G, 0402 | -55 to 125 | Murata Electronics | GRM1555C1H102JA01D |
| 5 | 1 | C6 | 10 nF | Capacitor, ceramic, 10 nF 2.5 V, ±10%, X7R, 0402 | -55 to 125 | Taiyo Yuden | TMK105B7103KV-F |
| 6 | 1 | CONN_1 | 1x6 | High temp, 0.100-inch-pitch, 1x6, Overall 430L Post Gold, Single, 230 Post height Pin three is polarized | -55 to 125 | Samtec | HMTSW-106-07-G-S-230-003 |
| 7 | 1 | CONN_2 | 1x6 | High temp, 0.100-inch pitch, 1x6, Overall 430L Post Gold, Single, 230 Post height | -55 to 125 | Samtec | HMTSW-106-07-G-S-230 |
| 8 | 1 | R1 | 10 kΩ | Resistor, thick film, 10 kΩ 0.1 W, ±200 ppm/°C, ±5%, 0402 | ±200 ppm/°C | Panasonic - ECG | ERJ-2GEJ103X |
| 9 | 1 | R2 | 10 kΩ | Resistor, thick film, 10 kΩ, 0.1W, ±200 ppm/°C, ±5%, 0402 | ±200 ppm/°C | Panasonic - ECG | ERJ-2GEJ103X |
| 10 | 0 | R3 | 200 kΩ | Resistor, thick film, 200 kΩ, 0.1 W, ±100 ppm/°C, ±1%, 0603 | ±100 ppm/°C | Panasonic - ECG | ERJ-3EKF2003V |
| 11 | 0 | R4 | 113 kΩ | Resistor, thick film, 113 kΩ, 0.1W, ±100 ppm/°C, ±1%, 0603 | ±100 ppm/°C | Panasonic - ECG | ERJ-3EKF1133V |
| 12 | 1 | U2 | ADDR = 1110000 | IC TEMP SENSOR DGTL SMBUS 4DSBGA - ADDR=1110000 | -10 to 100 | Texas Instruments | TMP103AYFF |
| 13 | 0 | R3 | 147 kΩ | Resistor, thick film, 147 kΩ, 0.1 W, ±100 ppm/°C, ±1%, 0603 | ±100 ppm/°C | Panasonic - ECG | ERJ-3EKF1473V |
| 14 | 0 | R4 | 133 kΩ | Resistor, thick film 133 kΩ, 0.1 W, ±100 ppm/°C, ±1%, 0603 | ±100 ppm/°C | Panasonic - ECG | ERJ-3EKF1333V |
| 15 | 0 | R3 | 475 kΩ | Resistor, thick film, 475 kΩ, 0.1 W, ±100 ppm/°C, ±1%, 0603 | ±100 ppm/°C | Panasonic - ECG | ERJ-3EKF4753V |
| 16 | 0 | R4 | 51.1 kΩ | Resistor, thick film, 51.1 kΩ, 0.1 W, ±100 ppm/°C, ±1%, 0603 | ±100 ppm/°C | Panasonic - ECG | ERJ-3EKF5112V |
| 17 | 1 | LB1 | Line 1 Line 2 | SMP-TPS7A1650-MVK BOM REV C | | Brady | THT-14-423-10 |
| 18 | 1 | U1 | TPS7A1650DGN | IC REG LDO FIXED 5.0V 100MA 8MSOP | -40 to 125 | Texas Instruments | TPS7A1650DGN |
| 19 | 0 | R3 | 1.5 MΩ | Resistor, thick film, 1.5 MΩ, 0.1 W, ±100 ppm/°C, ±1%, 0603 | ±100 ppm/°C | Vishay/Dale | CRCW06031M50FKEA |
| 20 | 0 | R4 | 1.37 MΩ | Resistor, thick film, 1.37 MΩ, 0.1 W, ±100 ppm/°C, ±1%, 0603 | ±100 ppm/°C | Vishay/Dale | CRCW06031M37FKEA |

4.2 *Layout (PDF)*

Figure 4 through Figure 13 show the separate SMP-TPS7A1650-MVK board layers.

[Download PDF](#) of the board layers.

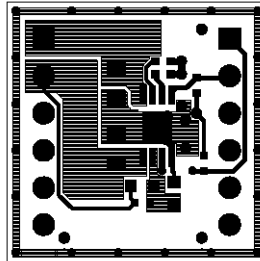

Figure 4. SMP-TPS7A1650-MVK Board Layer 1 – Top Side

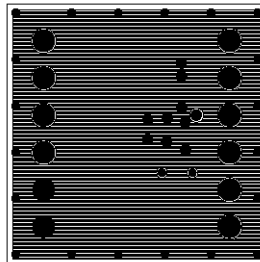

Figure 5. SMP-TPS7A1650-MVK Board Layer 2 – Ground Plane

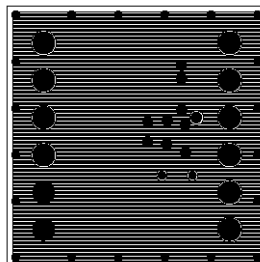

Figure 6. SMP-TPS7A1650-MVK Board Layer 3 – Ground Plane

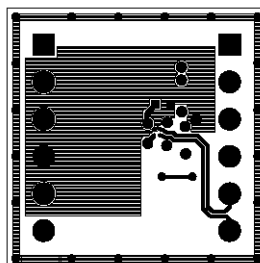

Figure 7. SMP-TPS7A1650-MVK Board Layer 4 – Bottom Side

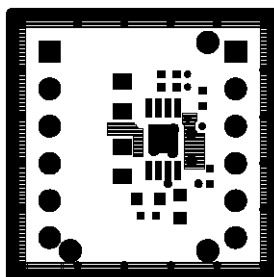

Figure 8. SMP-TPS7A1650-MVK Board Solder Mask – Top Side

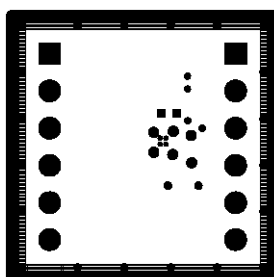

Figure 9. SMP-TPS7A1650-MVK Board Solder Mask – Bottom Side

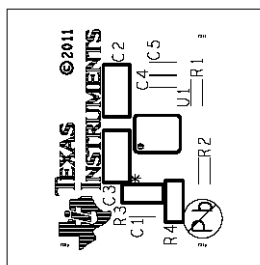

Figure 10. SMP-TPS7A1650-MVK Board Silkscreen – Top Side

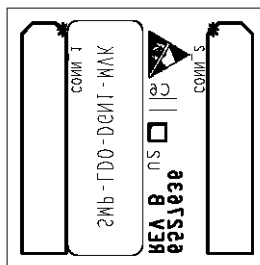

Figure 11. SMP-TPS7A1650-MVK Board Silkscreen – Bottom Side

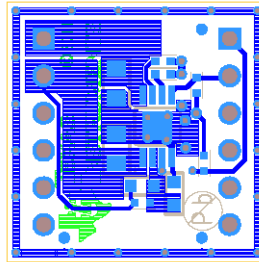

Figure 12. SMP-TPS7A1650-MVK Board Layer 1 – Top Side

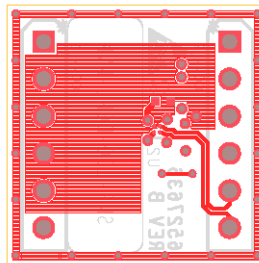

Figure 13. SMP-TPS7A1650-MVK Board Layer 4 – Bottom Side

4.3 Schematics (PDF)

Figure 14 shows the SMP-TPS7A1650-MVK schematic.

[Download PDF](#) of the schematic.

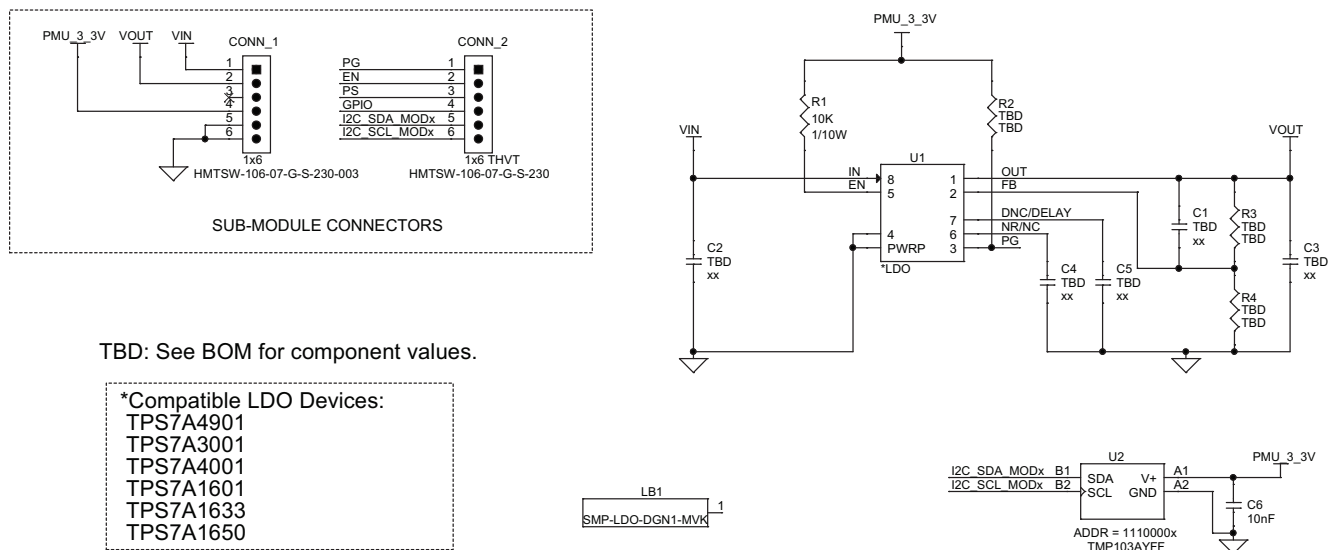

Figure 14. SMP-TPS7A1650-MVK Schematic

4.4 Fabrication Drawings (PDF)

Figure 15 shows the SMP-TPS7A1650-MVK fabrication drawing.

[Download PDF](#) of the fabrication drawing.

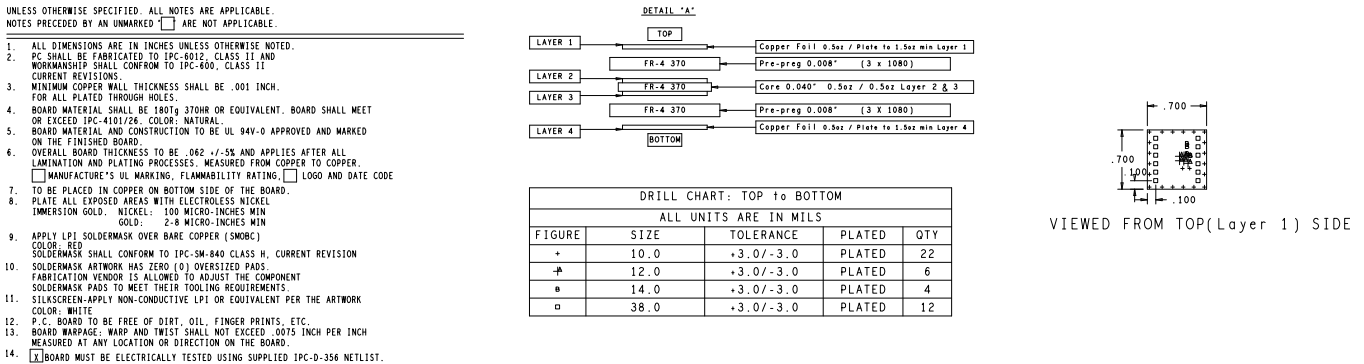

Figure 15. SMP-TPS7A1650-MVK Fabrication Drawing

4.5 Gerber Files

Figure 16 shows an SMP-TPS7A1650-MVK Gerber file.

[Download a ZIP](#) of the Gerber files.

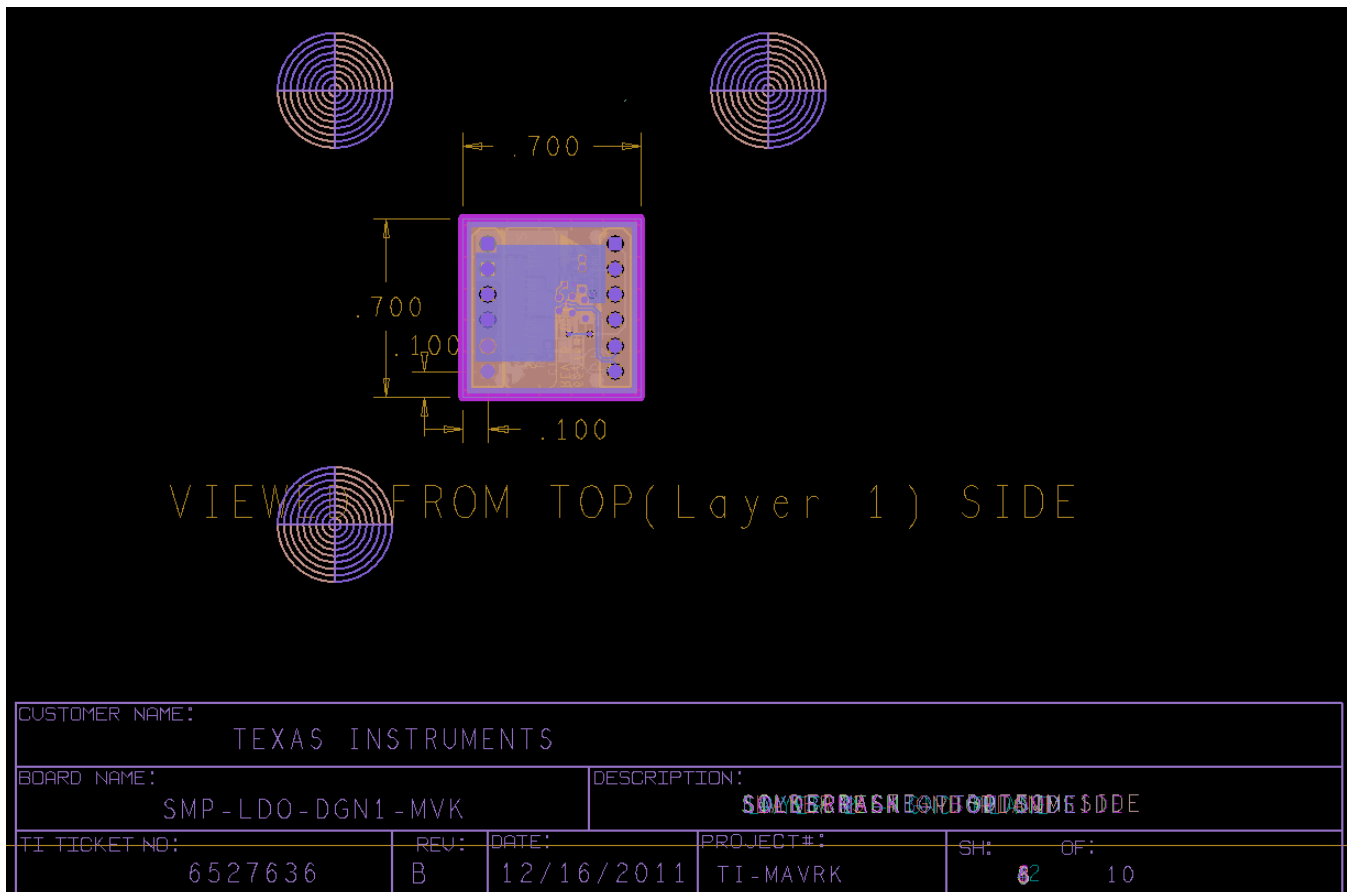

Figure 16. SMP-TPS7A1650-MVK Gerber File

4.6 Cadence Schematic and Board Files

Figure 17 shows an SMP-TPS7A1650-MVK board file.

[Download a ZIP](#) of the Cadence schematic and board files.

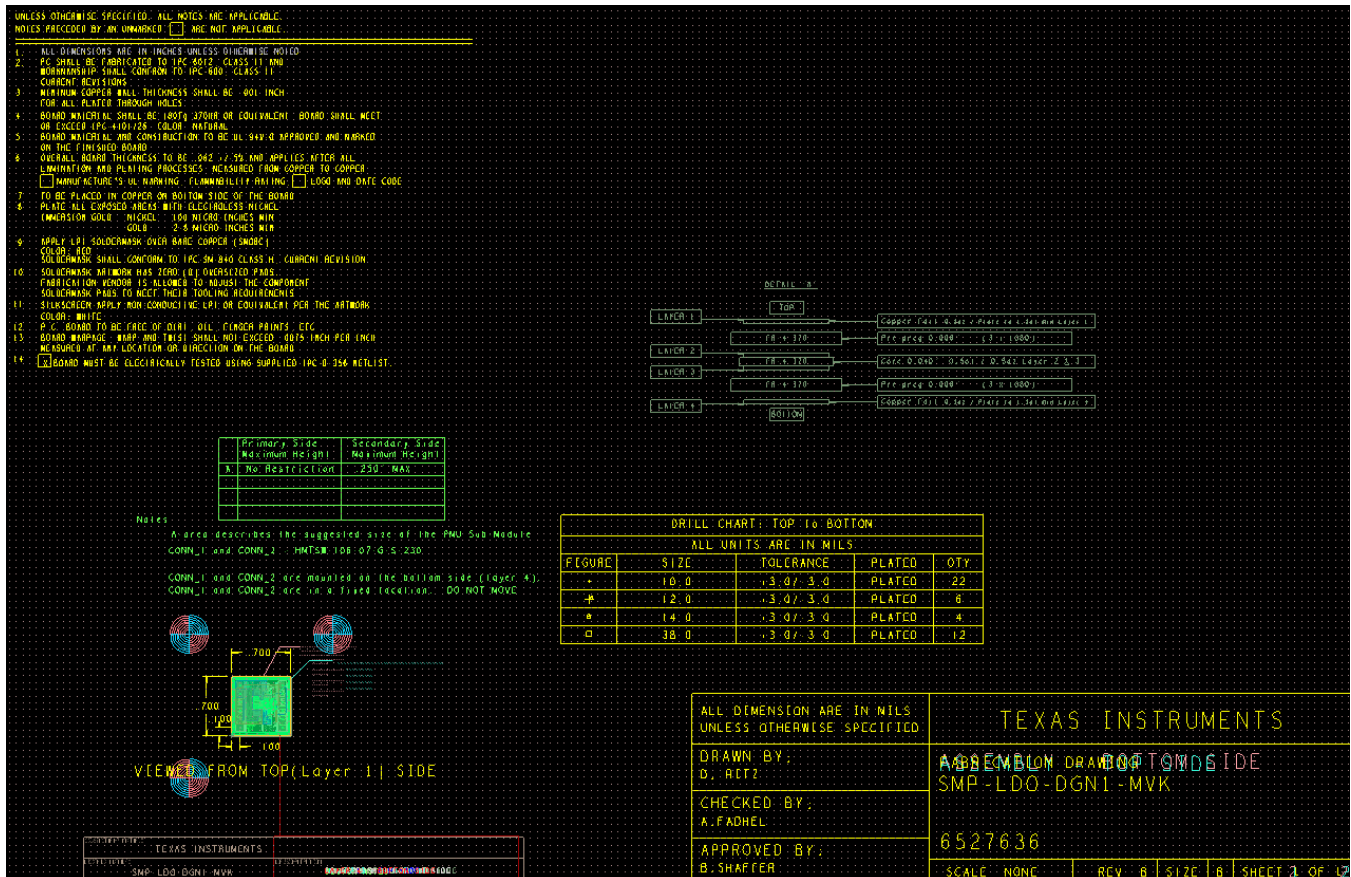

Figure 17. SMP-TPS7A1650-MVK Cadence Schematic and Board File

5 MAVRK Links

5.1 Additional Information on MAVRK

Visit the [MAVRK wiki pages](#) to get comprehensive information on MAVRK.

5.2 MAVRK Questions

Post any questions on the [MAVRK Forum](#).

5.3 Additional Technical Information on MAVRK Hardware

Review the wiki pages related to [designing MAVRK hardware](#).

5.4 Additional Technical Information on MAVRK Software

Review the wiki pages related to [working with MAVRK software](#).

5.5 Obtaining a MAVRK Board

See the [MAVRK Starter Kit tool folder page](#) to order a MAVRK starter kit. To order other modules, search for them by name on the [TI Web site](#) to find their tool folder pages.

6 Precautions and Certifications

6.1 ESD Precautions

To avoid ESD damage to the board components, adhere to the following guidelines:

- Any person handling boards must be grounded either with a wrist strap or ESD protective footwear, used in conjunction with a conductive or static-dissipative floor or floor mat.
- The work surface where boards are placed for handling, processing, testing, and so forth, must be made of static-dissipative material and be grounded to ESD ground.
- All insulator materials either must be removed from the work area or be neutralized with an ionizer. Static-generating clothes should be covered with an ESD-protective smock.
- When boards are being stored, transferred between operations or workstations, or shipped, they must be maintained in a Faraday-shield container whose inside surface (touching the boards) is static dissipative.

6.2 Certifications

[FCC and ICES standard EMC test report for the SMP-TPS7A1650-MVK submodule, aboard the MB-PRO-MVK motherboard](#)

[Eco-Info & Lead-Free Home](#)

[RoHS-Compliant Solutions](#)

[Statement on Registration, Evaluation, Authorization of Chemicals \(REACH\)](#)

EVALUATION BOARD/KIT/MODULE (EVM) ADDITIONAL TERMS

Texas Instruments (TI) provides the enclosed Evaluation Board/Kit/Module (EVM) under the following conditions:

The user assumes all responsibility and liability for proper and safe handling of the goods. Further, the user indemnifies TI from all claims arising from the handling or use of the goods.

Should this evaluation board/kit not meet the specifications indicated in the User's Guide, the board/kit may be returned within 30 days from the date of delivery for a full refund. THE FOREGOING LIMITED WARRANTY IS THE EXCLUSIVE WARRANTY MADE BY SELLER TO BUYER AND IS IN LIEU OF ALL OTHER WARRANTIES, EXPRESSED, IMPLIED, OR STATUTORY, INCLUDING ANY WARRANTY OF MERCHANTABILITY OR FITNESS FOR ANY PARTICULAR PURPOSE. EXCEPT TO THE EXTENT OF THE INDEMNITY SET FORTH ABOVE, NEITHER PARTY SHALL BE LIABLE TO THE OTHER FOR ANY INDIRECT, SPECIAL, INCIDENTAL, OR CONSEQUENTIAL DAMAGES.

Please read the User's Guide and, specifically, the Warnings and Restrictions notice in the User's Guide prior to handling the product. This notice contains important safety information about temperatures and voltages. For additional information on TI's environmental and/or safety programs, please visit www.ti.com/esh or contact TI.

No license is granted under any patent right or other intellectual property right of TI covering or relating to any machine, process, or combination in which such TI products or services might be or are used. TI currently deals with a variety of customers for products, and therefore our arrangement with the user is not exclusive. TI assumes no liability for applications assistance, customer product design, software performance, or infringement of patents or services described herein.

REGULATORY COMPLIANCE INFORMATION

As noted in the EVM User's Guide and/or EVM itself, this EVM and/or accompanying hardware may or may not be subject to the Federal Communications Commission (FCC) and Industry Canada (IC) rules.

For EVMs **not** subject to the above rules, this evaluation board/kit/module is intended for use for ENGINEERING DEVELOPMENT, DEMONSTRATION OR EVALUATION PURPOSES ONLY and is not considered by TI to be a finished end product fit for general consumer use. It generates, uses, and can radiate radio frequency energy and has not been tested for compliance with the limits of computing devices pursuant to part 15 of FCC or ICES-003 rules, which are designed to provide reasonable protection against radio frequency interference. Operation of the equipment may cause interference with radio communications, in which case the user at his own expense will be required to take whatever measures may be required to correct this interference.

General Statement for EVMs including a radio

User Power/Frequency Use Obligations: This radio is intended for development/professional use only in legally allocated frequency and power limits. Any use of radio frequencies and/or power availability of this EVM and its development application(s) must comply with local laws governing radio spectrum allocation and power limits for this evaluation module. It is the user's sole responsibility to only operate this radio in legally acceptable frequency space and within legally mandated power limitations. Any exceptions to this are strictly prohibited and unauthorized by Texas Instruments unless user has obtained appropriate experimental/development licenses from local regulatory authorities, which is responsibility of user including its acceptable authorization.

For EVMs annotated as FCC – FEDERAL COMMUNICATIONS COMMISSION Part 15 Compliant

Caution

This device complies with part 15 of the FCC Rules. Operation is subject to the following two conditions: (1) This device may not cause harmful interference, and (2) this device must accept any interference received, including interference that may cause undesired operation.

Changes or modifications not expressly approved by the party responsible for compliance could void the user's authority to operate the equipment.

FCC Interference Statement for Class A EVM devices

This equipment has been tested and found to comply with the limits for a Class A digital device, pursuant to part 15 of the FCC Rules. These limits are designed to provide reasonable protection against harmful interference when the equipment is operated in a commercial environment. This equipment generates, uses, and can radiate radio frequency energy and, if not installed and used in accordance with the instruction manual, may cause harmful interference to radio communications. Operation of this equipment in a residential area is likely to cause harmful interference in which case the user will be required to correct the interference at his own expense.

FCC Interference Statement for Class B EVM devices

This equipment has been tested and found to comply with the limits for a Class B digital device, pursuant to part 15 of the FCC Rules. These limits are designed to provide reasonable protection against harmful interference in a residential installation. This equipment generates, uses and can radiate radio frequency energy and, if not installed and used in accordance with the instructions, may cause harmful interference to radio communications. However, there is no guarantee that interference will not occur in a particular installation. If this equipment does cause harmful interference to radio or television reception, which can be determined by turning the equipment off and on, the user is encouraged to try to correct the interference by one or more of the following measures:

- Reorient or relocate the receiving antenna.
- Increase the separation between the equipment and receiver.
- Connect the equipment into an outlet on a circuit different from that to which the receiver is connected.
- Consult the dealer or an experienced radio/TV technician for help.

For EVMs annotated as IC – INDUSTRY CANADA Compliant

This Class A or B digital apparatus complies with Canadian ICES-003.

Changes or modifications not expressly approved by the party responsible for compliance could void the user's authority to operate the equipment.

Concerning EVMs including radio transmitters

This device complies with Industry Canada licence-exempt RSS standard(s). Operation is subject to the following two conditions: (1) this device may not cause interference, and (2) this device must accept any interference, including interference that may cause undesired operation of the device.

Concerning EVMs including detachable antennas

Under Industry Canada regulations, this radio transmitter may only operate using an antenna of a type and maximum (or lesser) gain approved for the transmitter by Industry Canada. To reduce potential radio interference to other users, the antenna type and its gain should be so chosen that the equivalent isotropically radiated power (e.i.r.p.) is not more than that necessary for successful communication.

This radio transmitter has been approved by Industry Canada to operate with the antenna types listed in the user guide with the maximum permissible gain and required antenna impedance for each antenna type indicated. Antenna types not included in this list, having a gain greater than the maximum gain indicated for that type, are strictly prohibited for use with this device.

Cet appareil numérique de la classe A ou B est conforme à la norme NMB-003 du Canada.

Les changements ou les modifications pas expressément approuvés par la partie responsable de la conformité ont pu vider l'autorité de l'utilisateur pour actionner l'équipement.

Concernant les EVMs avec appareils radio

Le présent appareil est conforme aux CNR d'Industrie Canada applicables aux appareils radio exempts de licence. L'exploitation est autorisée aux deux conditions suivantes : (1) l'appareil ne doit pas produire de brouillage, et (2) l'utilisateur de l'appareil doit accepter tout brouillage radioélectrique subi, même si le brouillage est susceptible d'en compromettre le fonctionnement.

Concernant les EVMs avec antennes détachables

Conformément à la réglementation d'Industrie Canada, le présent émetteur radio peut fonctionner avec une antenne d'un type et d'un gain maximal (ou inférieur) approuvé pour l'émetteur par Industrie Canada. Dans le but de réduire les risques de brouillage radioélectrique à l'intention des autres utilisateurs, il faut choisir le type d'antenne et son gain de sorte que la puissance isotrope rayonnée équivalente (p.i.r.e.) ne dépasse pas l'intensité nécessaire à l'établissement d'une communication satisfaisante.

Le présent émetteur radio a été approuvé par Industrie Canada pour fonctionner avec les types d'antenne énumérés dans le manuel d'usage et ayant un gain admissible maximal et l'impédance requise pour chaque type d'antenne. Les types d'antenne non inclus dans cette liste, ou dont le gain est supérieur au gain maximal indiqué, sont strictement interdits pour l'exploitation de l'émetteur.

【Important Notice for Users of this Product in Japan】

This development kit is NOT certified as Confirming to Technical Regulations of Radio Law of Japan

If you use this product in Japan, you are required by Radio Law of Japan to follow the instructions below with respect to this product:

1. Use this product in a shielded room or any other test facility as defined in the notification #173 issued by Ministry of Internal Affairs and Communications on March 28, 2006, based on Sub-section 1.1 of Article 6 of the Ministry's Rule for Enforcement of Radio Law of Japan,
2. Use this product only after you obtained the license of Test Radio Station as provided in Radio Law of Japan with respect to this product, or
3. Use of this product only after you obtained the Technical Regulations Conformity Certification as provided in Radio Law of Japan with respect to this product. Also, please do not transfer this product, unless you give the same notice above to the transferee. Please note that if you could not follow the instructions above, you will be subject to penalties of Radio Law of Japan.

Texas Instruments Japan Limited
(address) 24-1, Nishi-Shinjuku 6 chome, Shinjuku-ku, Tokyo, Japan

<http://www.tij.co.jp>

【ご使用にあたっての注】

本開発キットは技術基準適合証明を受けておりません。

本製品のご使用に際しては、電波法遵守のため、以下のいずれかの措置を取っていただく必要がありますのでご注意ください。

1. 電波法施行規則第6条第1項第1号に基づく平成18年3月28日総務省告示第173号で定められた電波暗室等の試験設備でご使用いただく。
2. 実験局の免許を取得後ご使用いただく。
3. 技術基準適合証明を取得後ご使用いただく。

なお、本製品は、上記の「ご使用にあたっての注意」を譲渡先、移転先に通知しない限り、譲渡、移転できないものとします。

上記を遵守頂けない場合は、電波法の罰則が適用される可能性があることをご留意ください。

日本テキサス・インスツルメンツ株式会社
東京都新宿区西新宿6丁目24番1号
西新宿三井ビル

<http://www.tij.co.jp>

EVALUATION BOARD/KIT/MODULE (EVM) WARNINGS, RESTRICTIONS AND DISCLAIMERS

For Feasibility Evaluation Only, in Laboratory/Development Environments. Unless otherwise indicated, this EVM is not a finished electrical equipment and not intended for consumer use. It is intended solely for use for preliminary feasibility evaluation in laboratory/development environments by technically qualified electronics experts who are familiar with the dangers and application risks associated with handling electrical mechanical components, systems and subsystems. It should not be used as all or part of a finished end product.

Your Sole Responsibility and Risk. You acknowledge, represent and agree that:

1. You have unique knowledge concerning Federal, State and local regulatory requirements (including but not limited to Food and Drug Administration regulations, if applicable) which relate to your products and which relate to your use (and/or that of your employees, affiliates, contractors or designees) of the EVM for evaluation, testing and other purposes.
2. You have full and exclusive responsibility to assure the safety and compliance of your products with all such laws and other applicable regulatory requirements, and also to assure the safety of any activities to be conducted by you and/or your employees, affiliates, contractors or designees, using the EVM. Further, you are responsible to assure that any interfaces (electronic and/or mechanical) between the EVM and any human body are designed with suitable isolation and means to safely limit accessible leakage currents to minimize the risk of electrical shock hazard.
3. You will employ reasonable safeguards to ensure that your use of the EVM will not result in any property damage, injury or death, even if the EVM should fail to perform as described or expected.
4. You will take care of proper disposal and recycling of the EVM's electronic components and packing materials.

Certain Instructions. It is important to operate this EVM within TI's recommended specifications and environmental considerations per the user guidelines. Exceeding the specified EVM ratings (including but not limited to input and output voltage, current, power, and environmental ranges) may cause property damage, personal injury or death. If there are questions concerning these ratings please contact a TI field representative prior to connecting interface electronics including input power and intended loads. Any loads applied outside of the specified output range may result in unintended and/or inaccurate operation and/or possible permanent damage to the EVM and/or interface electronics. Please consult the EVM User's Guide prior to connecting any load to the EVM output. If there is uncertainty as to the load specification, please contact a TI field representative. During normal operation, some circuit components may have case temperatures greater than 60°C as long as the input and output are maintained at a normal ambient operating temperature. These components include but are not limited to linear regulators, switching transistors, pass transistors, and current sense resistors which can be identified using the EVM schematic located in the EVM User's Guide. When placing measurement probes near these devices during normal operation, please be aware that these devices may be very warm to the touch. As with all electronic evaluation tools, only qualified personnel knowledgeable in electronic measurement and diagnostics normally found in development environments should use these EVMs.

Agreement to Defend, Indemnify and Hold Harmless. You agree to defend, indemnify and hold TI, its licensors and their representatives harmless from and against any and all claims, damages, losses, expenses, costs and liabilities (collectively, "Claims") arising out of or in connection with any use of the EVM that is not in accordance with the terms of the agreement. This obligation shall apply whether Claims arise under law of tort or contract or any other legal theory, and even if the EVM fails to perform as described or expected.

Safety-Critical or Life-Critical Applications. If you intend to evaluate the components for possible use in safety critical applications (such as life support) where a failure of the TI product would reasonably be expected to cause severe personal injury or death, such as devices which are classified as FDA Class III or similar classification, then you must specifically notify TI of such intent and enter into a separate Assurance and Indemnity Agreement.

Mailing Address: Texas Instruments, Post Office Box 655303, Dallas, Texas 75265
Copyright © 2012, Texas Instruments Incorporated

IMPORTANT NOTICE

Texas Instruments Incorporated and its subsidiaries (TI) reserve the right to make corrections, modifications, enhancements, improvements, and other changes to its products and services at any time and to discontinue any product or service without notice. Customers should obtain the latest relevant information before placing orders and should verify that such information is current and complete. All products are sold subject to TI's terms and conditions of sale supplied at the time of order acknowledgment.

TI warrants performance of its hardware products to the specifications applicable at the time of sale in accordance with TI's standard warranty. Testing and other quality control techniques are used to the extent TI deems necessary to support this warranty. Except where mandated by government requirements, testing of all parameters of each product is not necessarily performed.

TI assumes no liability for applications assistance or customer product design. Customers are responsible for their products and applications using TI components. To minimize the risks associated with customer products and applications, customers should provide adequate design and operating safeguards.

TI does not warrant or represent that any license, either express or implied, is granted under any TI patent right, copyright, mask work right, or other TI intellectual property right relating to any combination, machine, or process in which TI products or services are used. Information published by TI regarding third-party products or services does not constitute a license from TI to use such products or services or a warranty or endorsement thereof. Use of such information may require a license from a third party under the patents or other intellectual property of the third party, or a license from TI under the patents or other intellectual property of TI.

Reproduction of TI information in TI data books or data sheets is permissible only if reproduction is without alteration and is accompanied by all associated warranties, conditions, limitations, and notices. Reproduction of this information with alteration is an unfair and deceptive business practice. TI is not responsible or liable for such altered documentation. Information of third parties may be subject to additional restrictions.

Resale of TI products or services with statements different from or beyond the parameters stated by TI for that product or service voids all express and any implied warranties for the associated TI product or service and is an unfair and deceptive business practice. TI is not responsible or liable for any such statements.

TI products are not authorized for use in safety-critical applications (such as life support) where a failure of the TI product would reasonably be expected to cause severe personal injury or death, unless officers of the parties have executed an agreement specifically governing such use. Buyers represent that they have all necessary expertise in the safety and regulatory ramifications of their applications, and acknowledge and agree that they are solely responsible for all legal, regulatory and safety-related requirements concerning their products and any use of TI products in such safety-critical applications, notwithstanding any applications-related information or support that may be provided by TI. Further, Buyers must fully indemnify TI and its representatives against any damages arising out of the use of TI products in such safety-critical applications.

TI products are neither designed nor intended for use in military/aerospace applications or environments unless the TI products are specifically designated by TI as military-grade or "enhanced plastic." Only products designated by TI as military-grade meet military specifications. Buyers acknowledge and agree that any such use of TI products which TI has not designated as military-grade is solely at the Buyer's risk, and that they are solely responsible for compliance with all legal and regulatory requirements in connection with such use.

TI products are neither designed nor intended for use in automotive applications or environments unless the specific TI products are designated by TI as compliant with ISO/TS 16949 requirements. Buyers acknowledge and agree that, if they use any non-designated products in automotive applications, TI will not be responsible for any failure to meet such requirements.

Following are URLs where you can obtain information on other Texas Instruments products and application solutions:

Products

| | |
|------------------------|--|
| Audio | www.ti.com/audio |
| Amplifiers | amplifier.ti.com |
| Data Converters | dataconverter.ti.com |
| DLP® Products | www.dlp.com |
| DSP | dsp.ti.com |
| Clocks and Timers | www.ti.com/clocks |
| Interface | interface.ti.com |
| Logic | logic.ti.com |
| Power Mgmt | power.ti.com |
| Microcontrollers | microcontroller.ti.com |
| RFID | www.ti-rfid.com |
| OMAP Mobile Processors | www.ti.com/omap |
| Wireless Connectivity | www.ti.com/wirelessconnectivity |

Applications

| | |
|-------------------------------|--|
| Automotive and Transportation | www.ti.com/automotive |
| Communications and Telecom | www.ti.com/communications |
| Computers and Peripherals | www.ti.com/computers |
| Consumer Electronics | www.ti.com/consumer-apps |
| Energy and Lighting | www.ti.com/energy |
| Industrial | www.ti.com/industrial |
| Medical | www.ti.com/medical |
| Security | www.ti.com/security |
| Space, Avionics and Defense | www.ti.com/space-avionics-defense |
| Video and Imaging | www.ti.com/video |

TI E2E Community Home Page

e2e.ti.com

Mailing Address: Texas Instruments, Post Office Box 655303, Dallas, Texas 75265
Copyright © 2012, Texas Instruments Incorporated