

TPA0243
Audio Power Amplifier
Evaluation Module

User's Guide

IMPORTANT NOTICE

Texas Instruments and its subsidiaries (TI) reserve the right to make changes to their products or to discontinue any product or service without notice, and advise customers to obtain the latest version of relevant information to verify, before placing orders, that information being relied on is current and complete. All products are sold subject to the terms and conditions of sale supplied at the time of order acknowledgment, including those pertaining to warranty, patent infringement, and limitation of liability.

TI warrants performance of its semiconductor products to the specifications applicable at the time of sale in accordance with TI's standard warranty. Testing and other quality control techniques are utilized to the extent TI deems necessary to support this warranty. Specific testing of all parameters of each device is not necessarily performed, except those mandated by government requirements.

Customers are responsible for their applications using TI components.

In order to minimize risks associated with the customer's applications, adequate design and operating safeguards must be provided by the customer to minimize inherent or procedural hazards.

TI assumes no liability for applications assistance or customer product design. TI does not warrant or represent that any license, either express or implied, is granted under any patent right, copyright, mask work right, or other intellectual property right of TI covering or relating to any combination, machine, or process in which such semiconductor products or services might be or are used. TI's publication of information regarding any third party's products or services does not constitute TI's approval, warranty or endorsement thereof.

Preface

Related Documentation From Texas Instruments

- ***TI Plug-N-Play Audio Amplifier Evaluation Platform*** (literature number SLOU011) provides detailed information on the evaluation platform and its use with TI audio evaluation modules.
- ***TPA0243 2-W Mono Audio Power Amplifier With Headphone Drive*** (literature number SLOS279) This is the data sheet for the TPA0243 audio amplifier integrated circuit.

FCC Warning

This equipment is intended for use in a laboratory test environment only. It generates, uses, and can radiate radio frequency energy and has not been tested for compliance with the limits of computing devices pursuant to subpart J of part 15 of FCC rules, which are designed to provide reasonable protection against radio frequency interference. Operation of this equipment in other environments may cause interference with radio communications, in which case the user at his own expense will be required to take whatever measures may be required to correct this interference.



Contents

1	Introduction	1-1
1.1	Feature Highlights	1-2
1.2	Description	1-3
1.3	TPA0243 EVM Specifications	1-3
2	Operation	2-1
2.1	Precautions	2-2
2.2	Quick Start List for Platform	2-3
2.3	Quick Start List for Stand-Alone	2-4
2.4	Stand-Alone Connection Diagrams	2-5
2.4.1	TPA0243 EVMs Connected for Stereo BTL Output	2-5
2.4.2	TPA0243 EVM Connected for SE Stereo Headphone Output	2-6
2.5	Reference	2-7
2.5.1	EVM Schematic	2-7
2.5.2	EVM Parts List	2-8
2.5.3	Module PCB Layers	2-9

Figures

1-1	The TI TPA0243 Audio Amplifier Evaluation Module	1-3
2-1	Quick Start Platform Map	2-2
2-2	Module Map	2-4
2-3	TPA0243 EVMs Connected for Stereo BTL Output	2-5
2-4	TPA0243 EVM Connected for Single-Ended Stereo Headphone Output	2-6
2-5	TPA0243 EVM Schematic Diagram	2-7
2-6	TPA0243 EVM PCB	2-9
2-7	TPA0243 EVM Silkscreen	2-9
2-8	TPA0243 EVM Bottom Layer	2-10

Tables

2-1	Platform Jumper and Switch Settings for the TPA0243	2-3
2-2	TPA0243 EVM Parts List	2-8



Introduction

This chapter provides an overview of the Texas Instruments (TI) TPA0243 audio amplifier evaluation module (SLOP269). It includes a list of EVM features, a brief description of the module illustrated with a pictorial diagram, and a list of EVM specifications.

Topic	Page
1.1 Feature Highlights	1-2
1.2 Description	1-3
1.3 TPA0243 EVM Specifications	1-3

1.1 Feature Highlights

The TI TPA0243 audio amplifier evaluation module and the TI plug-n-play audio amplifier evaluation platform include the following features:

- TPA0243 mono 2-W audio power amplifier with stereo headphone drive evaluation module
 - Single channel, bridge-tied load (BTL) or dual-channel single-ended operation
 - Internal summing of left and right channels to generate mono signal
 - 2 W output power into 4 Ω at 5 V, BTL
 - 0.6 W output power into 4 Ω at 3 V, BTL
 - Low current consumption in shutdown mode (1 μ A)
 - Stereo headphone drive

- Quick and easy configuration with the TI plug-n-play audio amplifier evaluation platform
 - Evaluation module is designed to simply plug into the platform, automatically making all signal, control, and power connections
 - Platform provides flexible power options
 - Jumpers on the platform select power and module control options
 - Switches on the platform route signals
 - Platform provides quick and easy audio input and output connections

- Platform power options
 - External 5-V – 15-V DC V_{CC} supply inputs
 - External regulated V_{DD} supply input
 - Socket for onboard 5 V/3.3 V V_{DD} voltage regulator EVM
 - Onboard overvoltage and reverse polarity power protection

- Platform audio input and output connections
 - Left and right RCA phono jack inputs
 - Miniature stereo phone jack input
 - Mono (right) RCA phono jack output
 - Mono (right) compression speaker terminal output
 - Miniature stereo headphone jack output

1.2 Description

The TPA0243 audio power amplifier evaluation module is a complete 2-watt mono audio power amplifier with stereo headphone drive. It consists of the TI TPA0243 mono 2-W audio power amplifier IC along with a small number of other parts mounted on a circuit board that measures approximately 2 1/4 inches by 1 1/2 inches (Figure 1–1).

Figure 1–1. The TI TPA0243 Audio Amplifier Evaluation Module

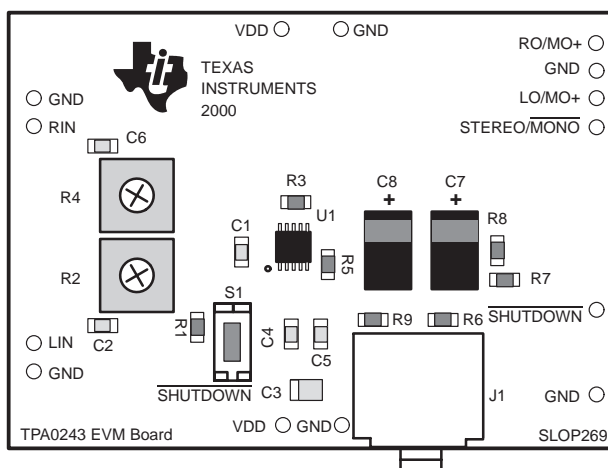

Single in-line header pins extend from the underside of the module circuit board to allow the EVM to be plugged into the TI plug-n-play audio amplifier evaluation platform, or to be wired directly into existing circuits and equipment when used stand-alone.

The platform has room for a single TPA0243 evaluation module and is a convenient vehicle for demonstrating TI's audio power amplifier and related evaluation modules. The EVMs simply plug into the platform, which automatically provides power to the modules, interconnects them correctly, and connects them to a versatile array of standard audio input and output jacks and connectors. Easy-to-use configuration controls allow the platform and EVMs to quickly model many possible end-equipment configurations.

There is nothing to build, nothing to solder, and nothing but the speakers included with the platform to *hook up*.

1.3 TPA0243 EVM Specifications

Supply voltage range, V_{DD}	2.5 V to 5.5 V
Supply current, I_{DD}	1A max
Continuous output power per channel, P_O : 4- Ω BTL, $V_{DD}=5$ V	2 W
Audio input voltage, V_I ,	5 V _{p-p} max
Minimum load impedance, R_L	4 Ω



Operation

Quick start lists in this chapter contain steps that can be followed to quickly prepare the TI plug-n-play audio amplifier evaluation platform for use with the TPA0243 audio amplifier EVM, or to connect the TPA0243 audio amplifier EVM for stand-alone operation.

Using the TPA0243 audio amplifier evaluation module with the TI evaluation platform is a quick and easy way to connect power, signal and control inputs, and signal outputs to the EVM, using standard connectors.

The TPA0243 audio amplifier evaluation module can also be used stand-alone by making connections directly to the module pins, and it can be wired directly into existing circuits or equipment. Stand-alone connection diagrams appear below.

A schematic, parts list, and PCB and layer illustrations for the EVM are included in the Reference section of this chapter.

Topic	Page
2.1 Precautions	2-2
2.2 Quick Start List for Platform	2-3
2.3 Quick Start List for Stand-Alone	2-4
2.4 Stand-Alone Connection Diagrams	2-5
2.5 Reference	2-7

2.1 Precautions

Power Supply Input Polarity and Maximum Voltage

Always ensure that the polarity and voltage of the external power connected to V_{CC} power input connector J1, J2, and/or V_{DD} power input connector J6 are correct. Overvoltage or reverse-polarity power applied to these terminals can open onboard soldered-in fuses and cause other damage to the platform, installed evaluation modules, and/or the power source.

Inserting or Removing EVM Boards

Do not insert or remove EVM boards with power applied—damage to the EVM board, the platform, or both may result.

Figure 2–1. Quick Start Platform Map

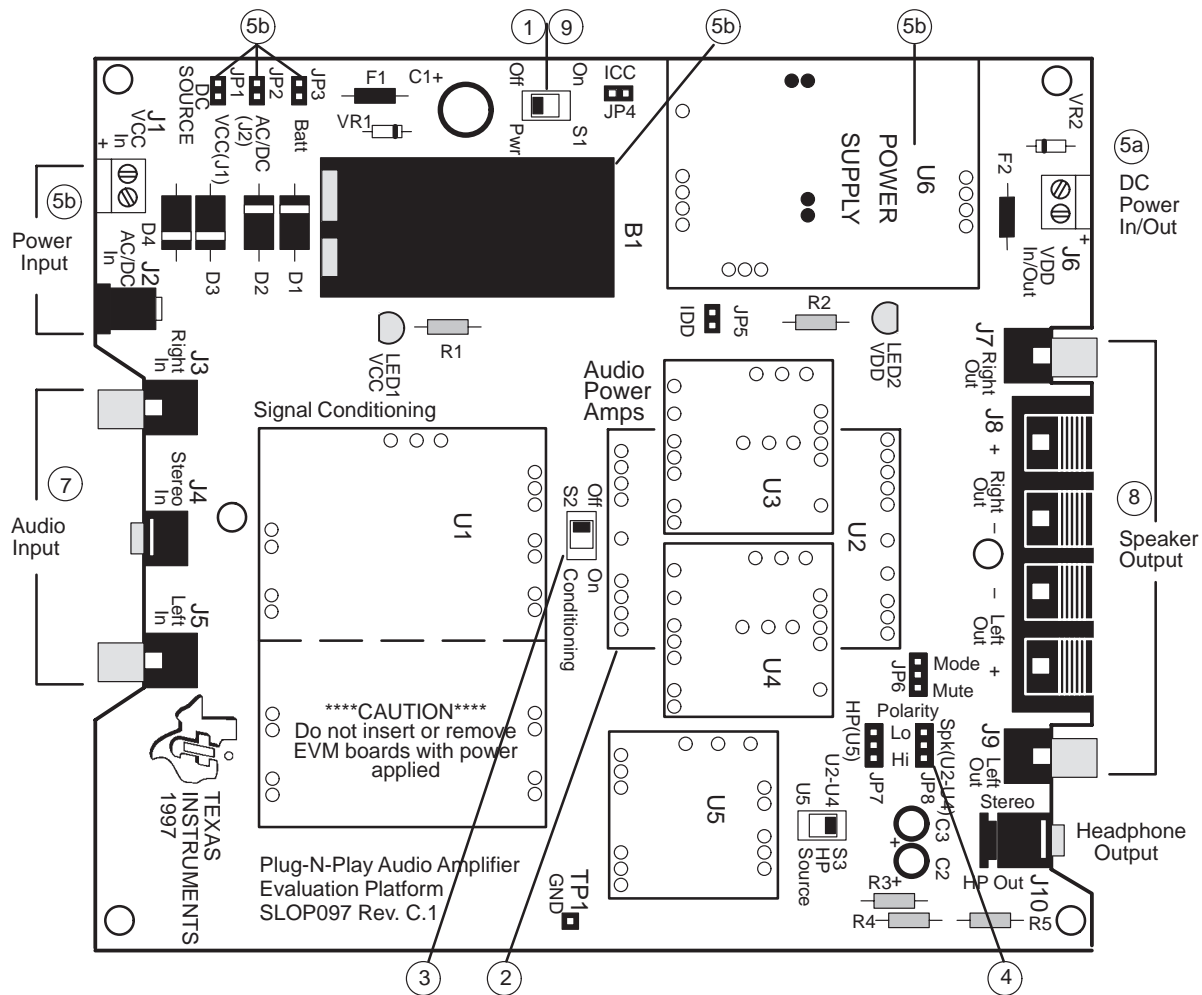

2.2 Quick Start List for Platform

Follow these steps when using the TPA0243 EVM with the TI plug-n-play audio amplifier evaluation platform (see the platform user's guide, SLOU011, for additional details). Table 2–1 shows typical platform jumper and switch settings and numbered callouts for selected steps appear in Figure 2–1.

Table 2–1. Platform Jumper and Switch Settings for the TPA0243

EVM	JP6	JP7	JP8	S2	S3
P-N-P Platform	Mode	X	Hi	Note 2	X

Notes: 1) X = Don't care
2) Set **S2** to **ON** when signal conditioning board is installed in **U1**; set **S2** to **OFF** when no signal conditioning board is installed.

Platform preparations

- 1) Ensure that all external power sources are set to **OFF** and that the platform power switch **S1** is set to **OFF**.
- 2) Install a TPA0243 module in platform socket **U2**, taking care to align the module pins correctly.
- 3) Use switch **S2** to select or bypass the signal conditioning EVM (**U1**).
- 4) Set **Mode/Mute** jumper **JP6** to **Mode** and **Polarity** jumper **JP8** to **Hi**.

Power supply

- 5) Select and connect the power supply (ensure power supply is set to **OFF**):
 - a) Connect an external regulated power supply set to 5 V to platform V_{DD} power input connector **J6** taking care to observe marked polarity, or
 - b) Install a voltage regulator EVM (SLVP097 or equiv.) in platform socket **U6**. Connect a 7 V – 12 V power source to a platform V_{CC} power input **J1** or **J2** and jumper the appropriate power input (see platform user's guide).

Inputs and outputs

- 6) Ensure that the audio signal source level is set to minimum.
- 7) Connect the audio source to left and right RCA phono jacks **J3** and **J5** or stereo miniature phone jack **J4**.
- 8) Connect the speaker to the right RCA jack **J7** or to the stripped wire speaker connector **J8**. Make sure the speaker is connected to the Right + and – terminals.

Power-Up

- 9) Verify correct voltage and input polarity and set the external power supply to **ON**. If V_{CC} and an onboard regulator EVM are used to provide V_{DD} , set platform power switch **S1** to **ON**.

Platform LED2 should light indicating the presence of V_{DD} , and the evaluation modules installed on the platform should begin operation.

- 10) Adjust the signal source level or adjust potentiometers **R2** and **R4** on the EVM as needed.

2.3 Quick Start List for Stand-Alone

Follow these steps to use the TPA0243 EVM stand-alone or when connecting it into existing circuits or equipment. Connections to the TPA0243 module header pins can be made via individual sockets, wire-wrapping, or soldering to the pins, either on the top or the bottom of the module circuit board. Numbered callouts for selected steps appear in Figure 2–2.

Figure 2–2. Module Map

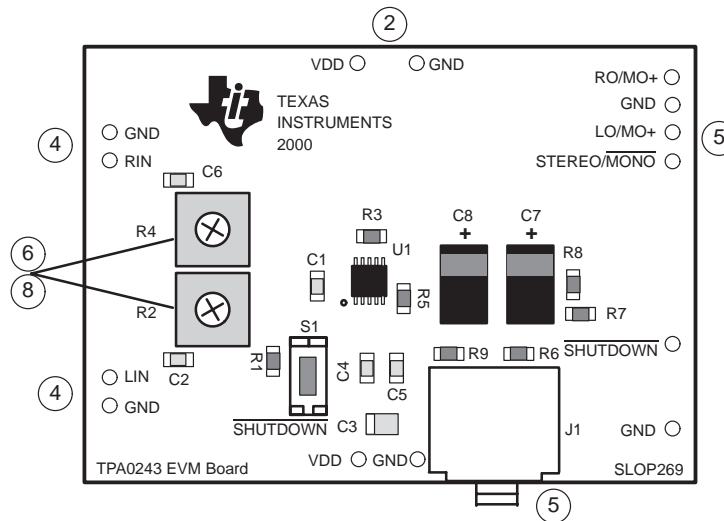

❑ Power supply

- 1) Ensure that all external power sources are set to **OFF**.
- 2) Connect an external regulated power supply set to 5 V to the module **VDD** and **GND** pins taking care to observe marked polarity.

❑ Inputs and outputs

- 3) Ensure that audio signal source level adjustments are set to minimum.
- 4) Connect the right (left) positive lead of the audio source to the module **RIN** (**LIN**) pins and the negative lead to the **GND** pin.
- 5) Connect a speaker to the module **RO/MO+** and **LO/MO–** pins *OR* plug a headphone into to EVM headphone jack **J1**.

❑ Evaluation module preparations

- 6) Adjust EVM potentiometers **R2** and **R4** to approximately mid point.

❑ Power-up

- 7) Verify correct voltage and input polarity and set the external power supply to **ON**.

The EVM should begin operation.

- 8) Adjust the signal source level or adjust potentiometers **R2** and **R4** on the EVM as needed.

2.4 Stand-Alone Connection Diagrams

The power supply range is 2.5 V to 5.5 V and isolated RO/MO+ and LO/MO- lines for BTL operation are required.

Note that the source of any shutdown signal applied to the EVM SHUTDOWN pin must be able to sink the current flowing through the pullup resistor on the module (100 k Ω) when the pin is held low.

2.4.1 TPA0243 EVMs Connected for Stereo BTL Output

Figure 2–3 shows two TPA0243 EVMs connected for stereo BTL operation.

Figure 2–3. TPA0243 EVMs Connected for Stereo BTL Output

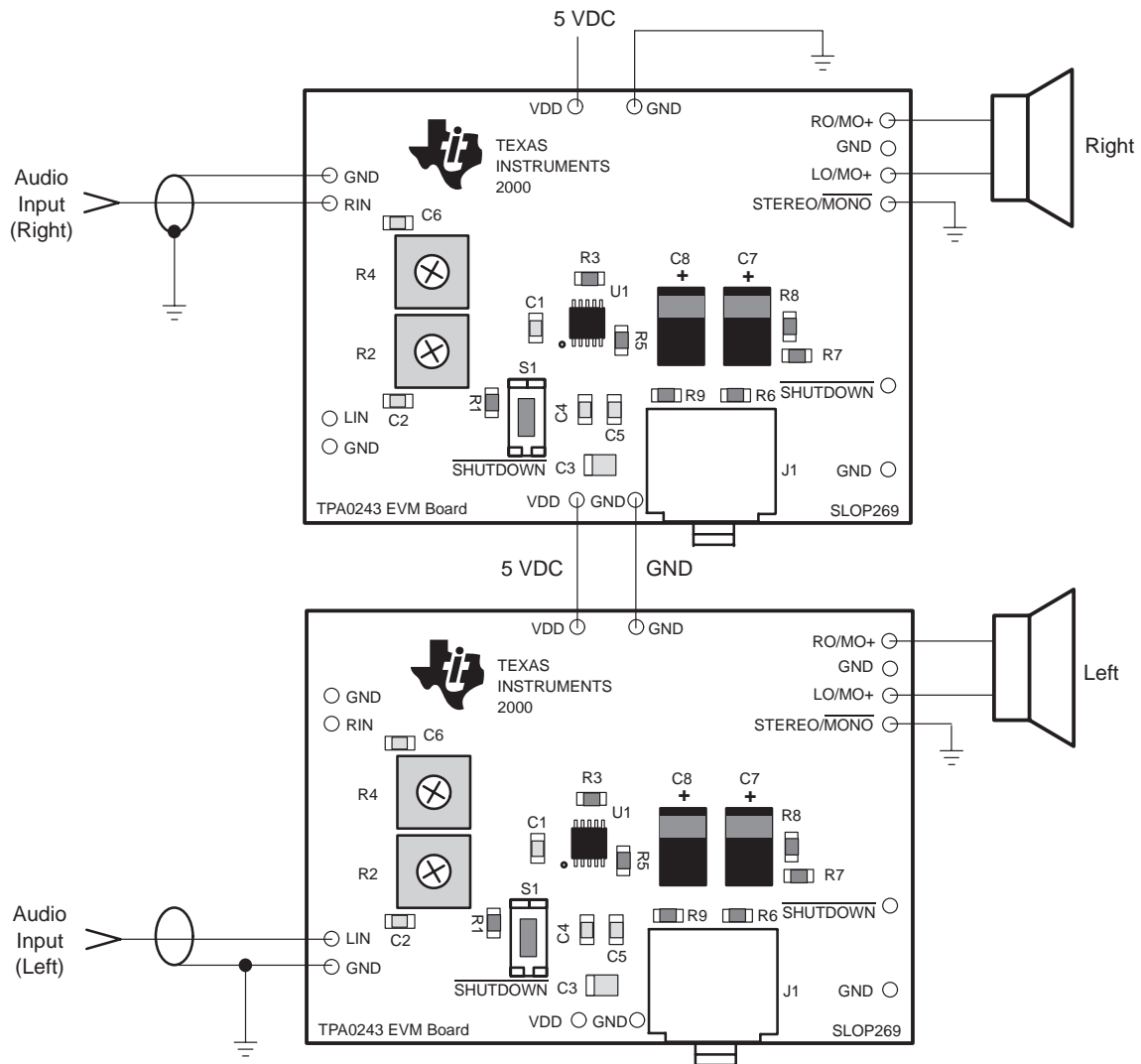

2.4.2 TPA0243 EVM Connected for Single-Ended Stereo Headphone Output

Figure 2–4 shows a TPA0243 EVM connected for single-ended stereo headphone operation.

Figure 2–4. TPA0243 EVM Connected for Single-Ended Stereo Headphone Output

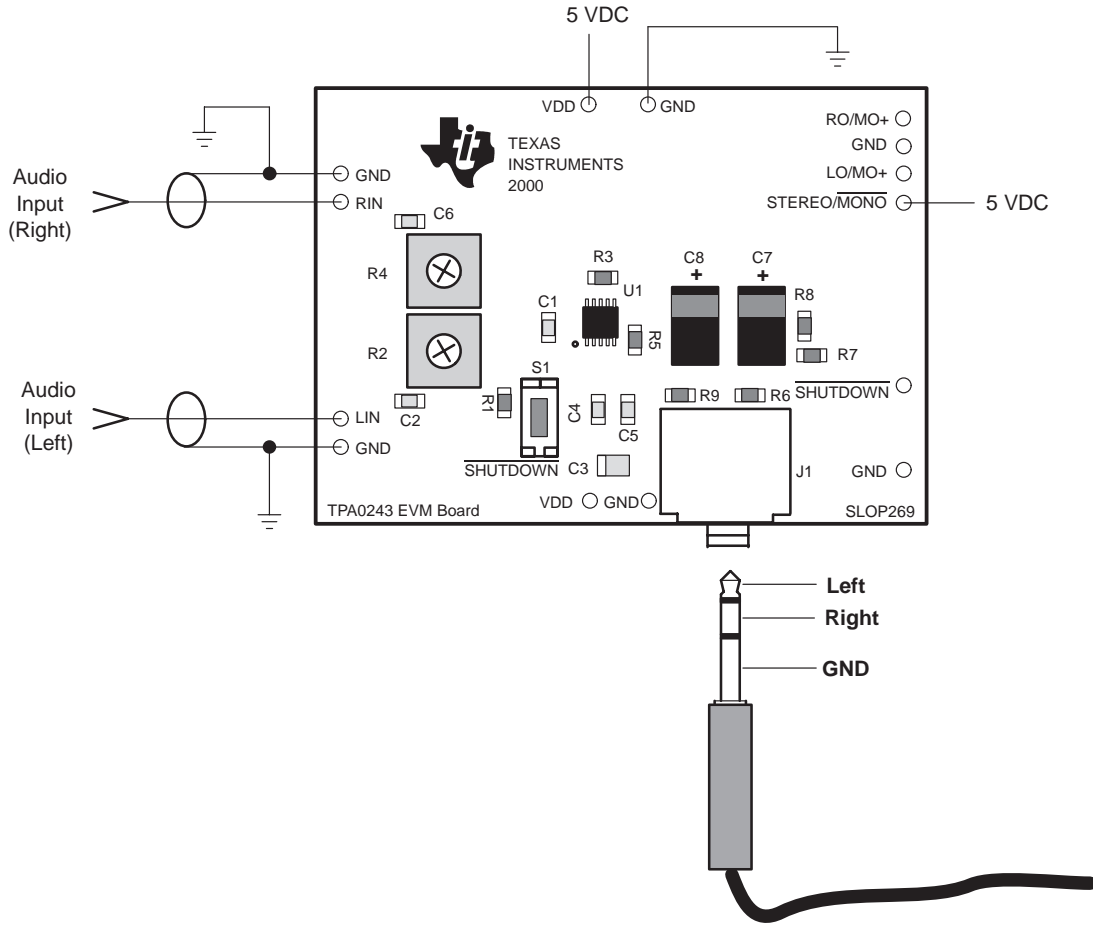

2.5 Reference

This section includes the TPA0243 EVM schematic, the EVM parts list, and the module PCB layers.

2.5.1 EVM Schematic

Figure 2–5 shows the TPA0243 EVM schematic.

Figure 2–5. TPA0243 EVM Schematic Diagram

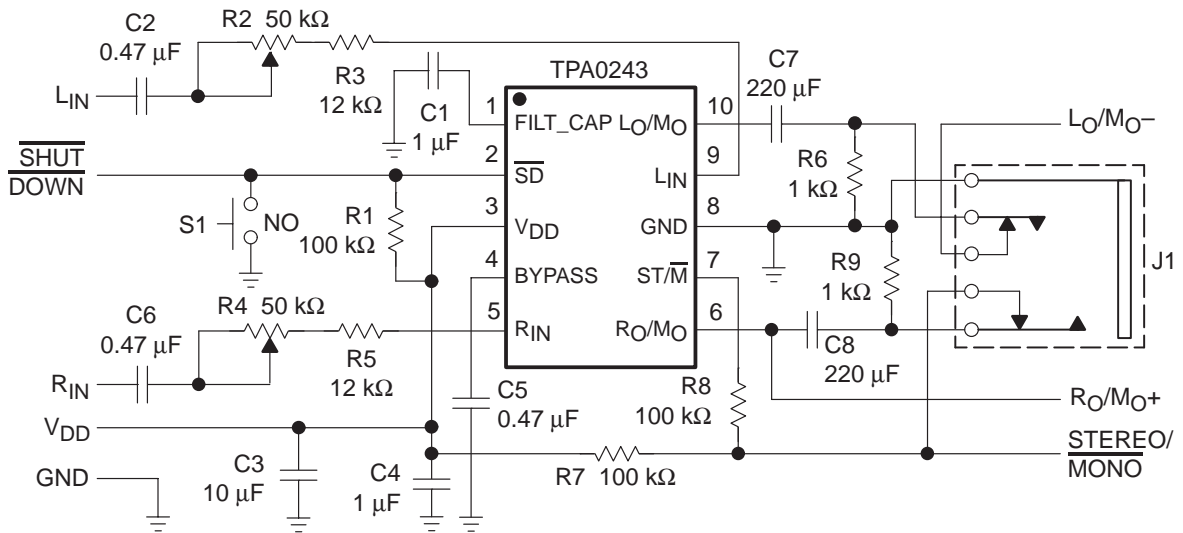

2.5.2 EVM Parts List

Table 2–2 is the TPA0243 EVM parts list.

Table 2–2. TPA0243 EVM Parts List

Ref.	Description	Size	EVM Qty.	Manufacturer/ Part Number	Vendor Number
C1, C4	Capacitor, 1 μ F @ 16 V, +80%/–20%, nonpolarized	1206	2	Murata GRM42-6Y5V105Z16BL	Arrow GRM426Y5V105Z 016
C2, C5, C6	Capacitor, 0.47 μ F @ 16 V +80%/–20%, nonpolarized	0805	3	Murata GRM40-Y5V474Z16	Arrow GRM40Y5V474Z 016
C3	Capacitor, 10 μ F @ 6.3 V	A	1	Panasonic ECS–TOJY106R	Digi-Key PCS1106CT–ND
C7, C8	Capacitor, 220 μ F @ 10 V	7.3 mm (L) 4.3 mm (W)	2	Sanyo “POSCAP” 10TPB220M	
R2, R4	Potentiometer, 50 k Ω , 1/2 W, through-hole		2	Bourns 3323P–50K	Digi-Key 3323P–503–ND
R6, R9	Resistor, 1 k Ω , 1/10 W, 5%	0805	2	Panasonic ERJ-6GEYJ102V	Digi-Key P1.0KACT-ND
R1, R7, R8	Resistor, 100 k Ω , 1/10 W, 5%	0805	3	Panasonic ERJ-6GEYJ104V	Digi-Key P100KACT-ND
R3, R5	Resistor, 12 k Ω , 1/10 W, 5%	0805	2	Panasonic ERJ-6GEYJ123V	Digi-Key P12KACT-ND
S1	Switch, momentary		1	Panasonic EVQ–PJS04K	Digi-Key P8050SCT-ND
J1	MINI STEREO PHONE JACK, PCB MOUNT	3.5 mm	1		Mouser 161–3504
	Terminal Post Headers		14	Sullins PTC36SABN	Digi-Key S1022-36-ND
U1	IC, TPA0243 2-W mono audio amplifier	MSOP-10	1	TI TPA0243DGN	

2.5.3 Module PCB Layers

The following illustrations depict the TPA0243 EVM PCB layers and silkscreen. These drawings are not to scale. Gerber plots can be obtained from any TI Sales Office.

Figure 2–6. TPA0243 EVM PCB

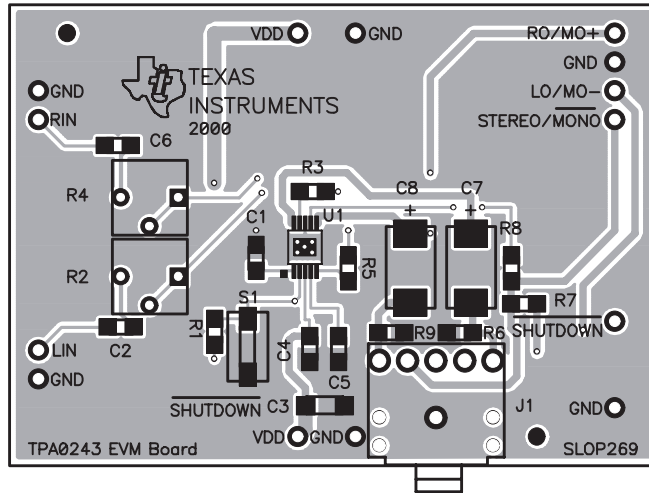

Figure 2–7. TPA0243 EVM Silkscreen

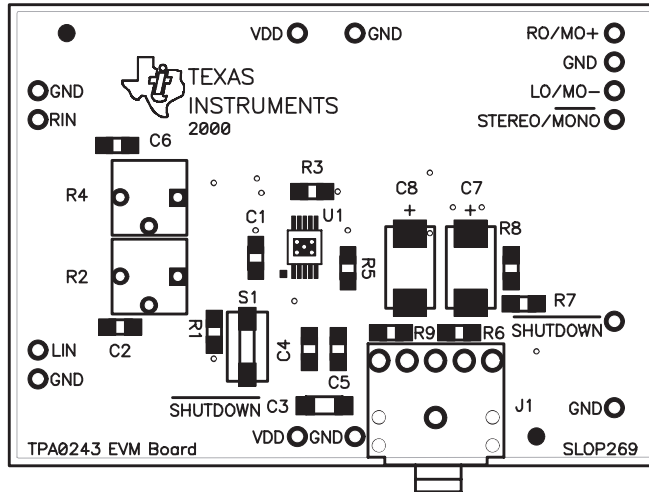

Figure 2–8. TPA0243 EVM Bottom Layer

