

# TI Designs: TIDA-060008

## 用于将 RS-232 信号传输方式转换为 RS-485 信号传输方式的参考设计



### 说明

此参考设计是一个用于将 RS-232 信号传输方式转换为 RS-485 信号传输方式的电路解决方案。鉴于 RS-232 支持的传输距离通常小于 50 英尺，而 RS-485 支持的传输距离可超过 1000 英尺，因此借助该解决方案可实现长距离通信。该设计 采用了一个 RS-232 收发器、一个 RS-485 收发器、一个多谐振荡器和一个带集成电源的数字隔离器，无需任何软件接口即可实现双向半双工通信。

此设计已针对 800 英尺长的两线制双绞线电缆进行了测试。两台电脑之间通过串行端口可成功实现高达 115200 波特率的通信。该设计 采用了工业标准 IEC 61000-4-2 和 61000-4-4 保护，具有 5000Vrms 隔离保护。

### 资源

<a href="#">TIDA-060008</a>	设计文件夹
<a href="#">TRS3232E</a>	产品文件夹
<a href="#">THVD1410</a>	产品文件夹
<a href="#">ISOW7842</a>	产品文件夹
<a href="#">SN74LVC1G123</a>	产品文件夹

### 特性

- 可将 RS-232 信号传输方式转换为 RS-485 信号传输方式，无需任何软件接口即可实现双向半双工通信，且具有热插拔功能。
- 低电压设计。该设计适用于 3.3V 和 5V 电源。
- 工业级 ESD 保护
  - RS-232 端口：IEC 61000-4-2、±8kV 接触、±15kV 气隙。
  - RS-485 端口：IEC 61000-4-2、±30kV 接触、±30kV 气隙、EFT、IEC 61000-4-4、50A；浪涌、IEC 61000-4-5、19A。
  - 隔离：5000Vrms 隔离保护。
- 将系统拓扑从点对点扩展到了多点。
- 电缆最长可达 1000 英尺。

### 应用

- 销售终端
- 工厂自动化
- IP 网络摄像机



咨询我们的 E2E™ 专家

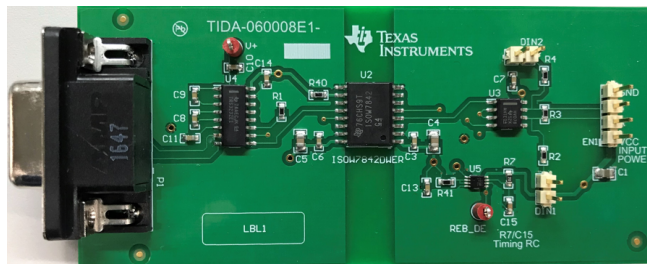
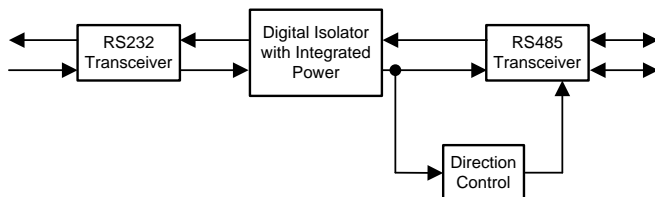

该 TI 参考设计末尾的重要声明表述了授权使用、知识产权问题和其他重要的免责声明和信息。

## 1 System Description

RS-232 is a widely used interface. One example is the serial port (COM port) of a PC. One drawback is that it can only support short distance communication (up to 50 ft). Some industrial applications need to extend the distance with robust communication. Converting RS-232 to RS-485 is one of the options, since RS-485 is widely used in industrial applications for long distance transmission.

This TI design implements the conversion circuit via an RS-232 transceiver, an RS-485 transceiver, a digital isolator, and a multivibrator. The industrial-level ESD protection is also included. The simplified diagram is shown in [图 1](#).

The power of the system is provided from the RS-485 transceiver side. This supply is isolated by a digital isolator ISOW7842 and transferred to the RS-232 transceiver side. High speed RS-485 communication needs to be properly terminated and can take up to 50 mA current consumption depending on the bus loading conditions. The RS-232 transceiver TRS3232E is interfaced with the external device like a PC. The RS-232 signal is converted to the digital domain and then transferred to the other power domain by the digital isolator. In this isolated power domain, the received digital signal is converted to RS-485 signal by a RS-485 transceiver (THVD1410). In the meantime, the edge of the digital signal triggers the multivibrator SN74LVC1G123 to generate a pulse to enable the RS-485 transceiver's transmission. In the idle state, the receiver of the RS-485 transceiver is turned on and the driver is turned off. When a valid signal shows up, the RS-485 transceiver is set into transmitter mode. Therefore, a half-duplex communication is established.

## 2 System Overview

### 2.1 Block Diagram

图 1. TIDA-060008 Block Diagram

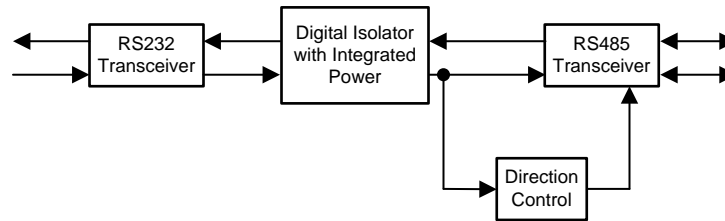

### 2.2 Design Considerations

The design goal is to support up to 256000 baud rate communication with either a 3.3-V or a 5-V supply. The isolation and industrial level ESD protection make the design robust under the noise and voltage surge of the harsh environment.

### 2.3 Highlighted Products

#### 2.3.1 THVD1410

The THVD1410 is used for RS-485 communication in this TI design. This device generates a compliant RS-485 standard output voltage with 3.3 V to 5 V supply and works for data transmission up to 500 kbps data rate. It has integrated ESD protection, such as  $\pm 18$  kV IEC 61000-4-2 Contact Discharge and  $\pm 4$  kV IEC 61000-4-4 Fast Transient Burst immunity.

See the [THVD14xx](#) product folder for a full description of this device.

#### 2.3.2 TRS3232E

The TRS3232E device consists of two RS-232 line drivers and two line receivers with  $\pm 15$ -kV IEC ESD protection. This device works with a 3.3V or a 5 V supply and up to 250 kbps data rate. It meets the requirements of TIA/EIA-232-F and provides the electrical interface between an asynchronous communication controller and the serial-port connector. In this TI design, one of each line driver and receiver is used for TxD and RxD signal. The other channel is left as “no connect” with the option of being used as RTS/CTS or DTR/DSR in other applications.

See the [TRS3232E](#) product folder for a full description of this device.

#### 2.3.3 ISOW7842

The ISOW7842 is a high-performance, quad-channel reinforced digital isolator with an integrated high-efficiency power converter. The integrated DC-DC converter works with 3.3 V and 5 V supplies and provides up to 650 mW of isolated power at high efficiency. Like the TRS3232E configuration, the unused channels have the option of future channel extension of the application.

See the [ISOW784x](#) product folder for a full description of this device.

### 3 Hardware, Software, Testing Requirements, and Test Results

#### 3.1 Required Hardware and Software

##### 3.1.1 Hardware

Two PCs with serial ports and one pair of this TI Design are needed for two-way half-duplex communication. A 10-foot unshielded twisted pair cable is used for the communication media.

##### 3.1.2 Software

The operating system for the PC is Microsoft Windows 9x, 2000, XP, Vista, or Win7. The RS-232 monitor software is used to supervise the communication. Other than monitoring the data exchange on a serial port, the software needs to be able to send and receive any data from a serial port to debug as well. The freeware used for testing is called AccessPort with version 1.37, which can be downloaded from this website <http://sudt.com/en/ap/index.html>. In the GUI of AccessPort (图 2), the top part is the terminal where you can monitor the actions on serial port, while the bottom part is where we can input data in hexadecimal or character format for transmitting data.

图 2. AccessPort GUI

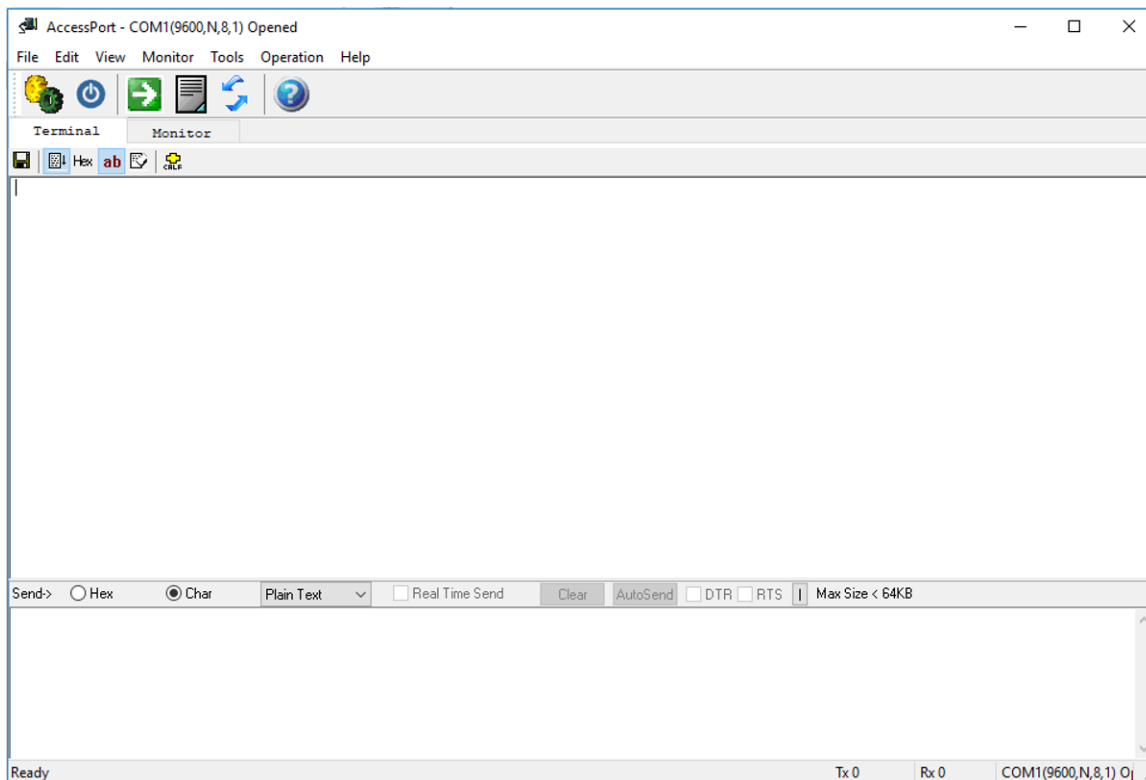

Another software tested was AGG serial port monitor (<http://www.aggsoft.com/serial-port-monitor/download.htm>). It also works for sending data and monitoring the serial port.

### 3.2 Testing and Results

#### 3.2.1 Test Setup

As shown in 图 3, two pairs of this TI Design and two PCs were used to implement bi-directional half-duplex communication. The boards on the two sides are powered by a 5 V power supply separately. The software of one PC sends data by serial port. An RS-232 transceiver TRS3232E is interfaced with the PC to convert RS-232 signal to digital domain. The digital isolator transmits the digital signal into another power domain, where the digital data is converted to RS-485 signal by a RS-485 transceiver THVD1410. The edge of the digital signal triggers the multivibrator SN74LVC1G123 to enable the RS-485 transceiver's transmitter. The transmitted RS-485 signal goes through the cable and is converted back to RS-232 signal by another set of TI design TIDA-060008 hardware. The PC on the other end receives the signal and the software decodes the data. In the lab, two PCs are put side by side for test and debug (图 4). This TI Design uses female DB9 connector for RS-232 interface, which can be directly attached to the PC serial port (图 5).

图 3. The System Block Diagram



图 4. The Two-way Half-duplex System Setup In Lab



图 5. This TI Design Plugs Into a Serial Port (Male DB9) On a PC

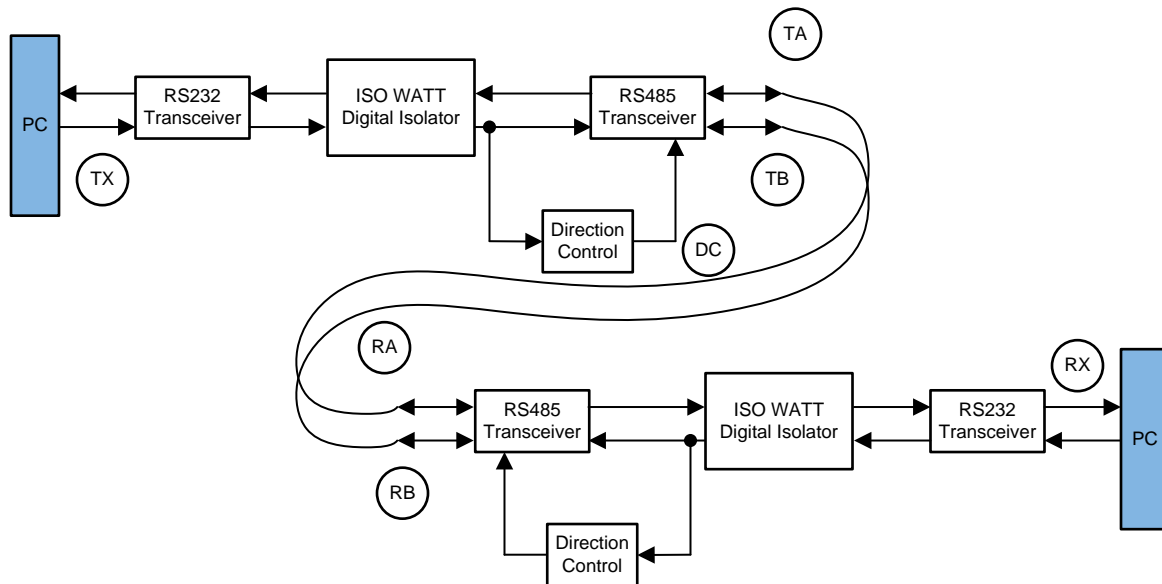

### 3.2.2 Test Results (Hardware)

The first test is to check the function of the circuit under room temperature. With a 5 V supply to both sides of the TI Designs, we check the supply voltage and the charge pump output voltage of the RS-232 transceivers of both boards to make sure the ICs work with normal supply conditions. The V+ voltage of the charge pump from both sides are above 5 V (图 6 and 图 7) showing the device supply is normal.

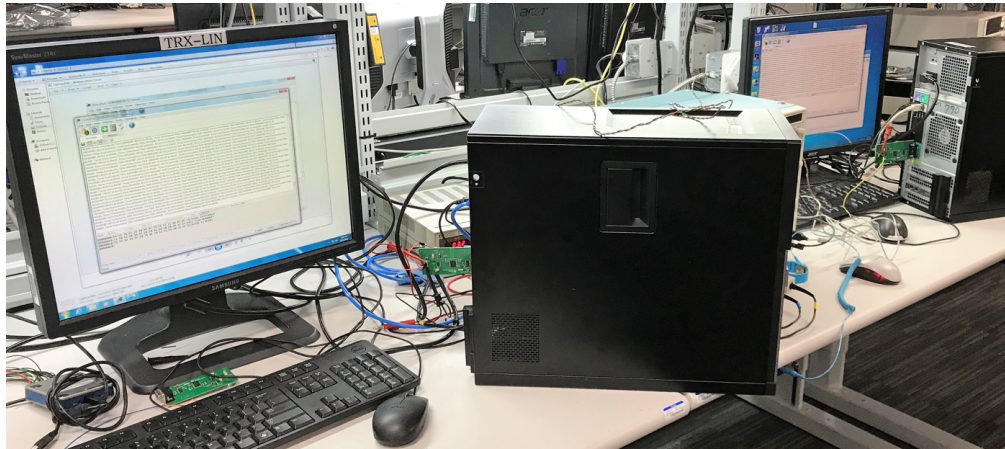
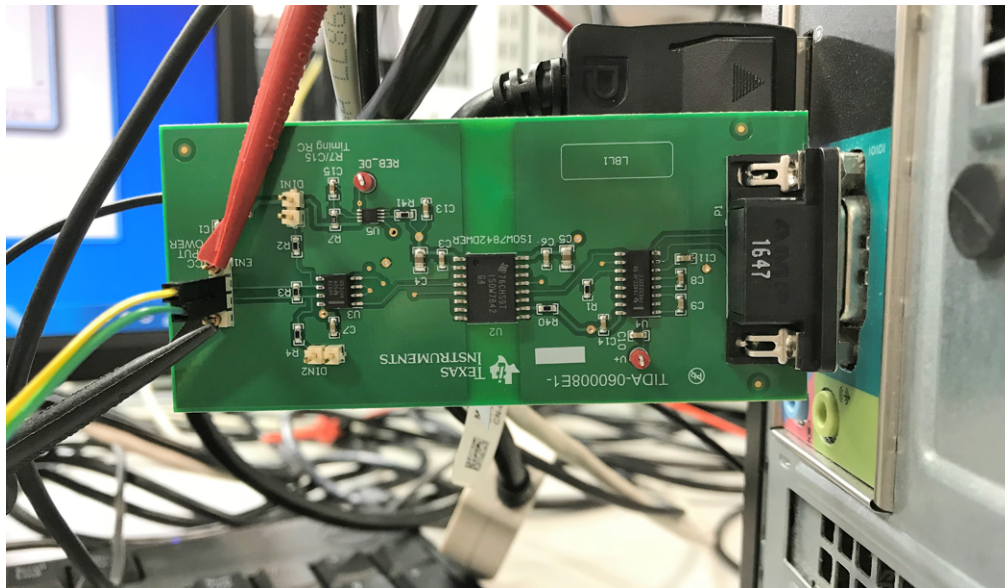

图 6. V+ Voltage of RS-232 Transceivers (TX Side)



图 7. V+ Voltage of RS-232 Transceivers (RX Side)

As 1 kHz clock RS-232 data generated by a signal generator is used as input signal (图 9), we check all the points in the signal chain for the signal quality. The converted RS-485 signal is shown at the A/B pins of the TX board. After 10 feet of unshielded twisted pair cable, the valid RS-485 signal is received at the RX board end (图 10). This RS-485 signal is converted to digital data and passes through the digital isolator. Then the RS-232 signal is generated by the RS-232 transceiver at the RX end (图 8).

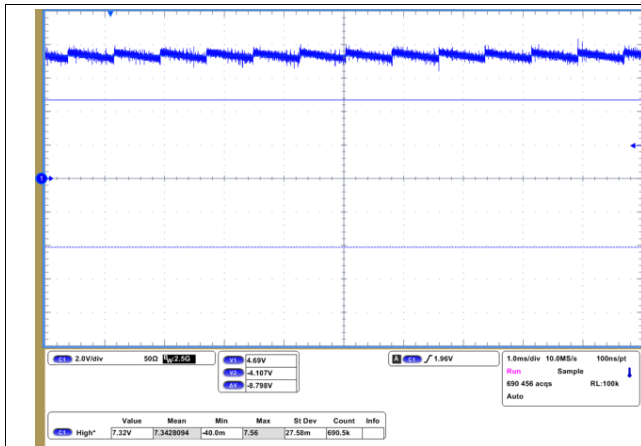

图 8. Input 1 kHz RS-232 clock data

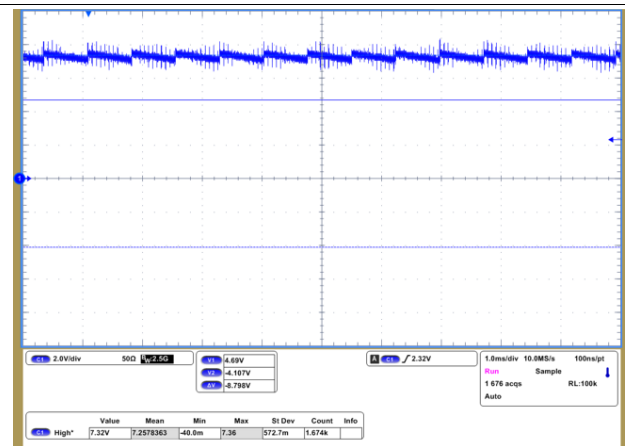

图 9. The Converted RS-485 Signal (TX Side)

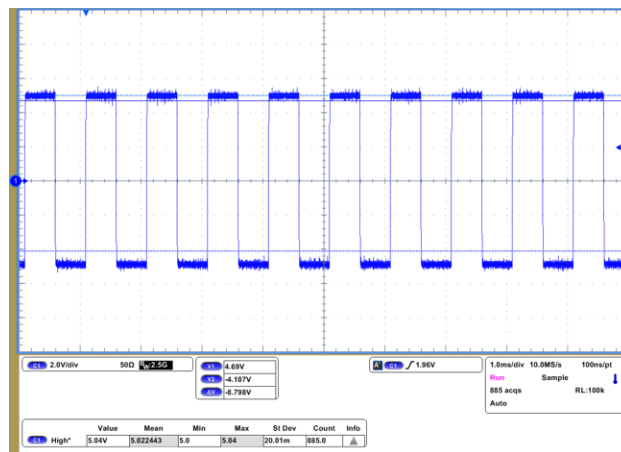

图 10. The Converted RS-485 Signal (RX Side)

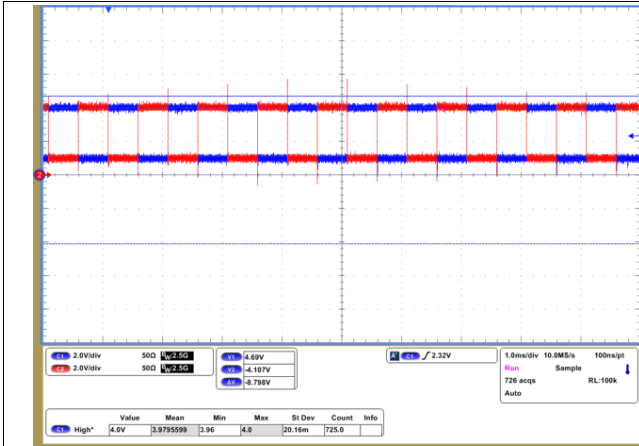

图 11. Received RS-485 Signal

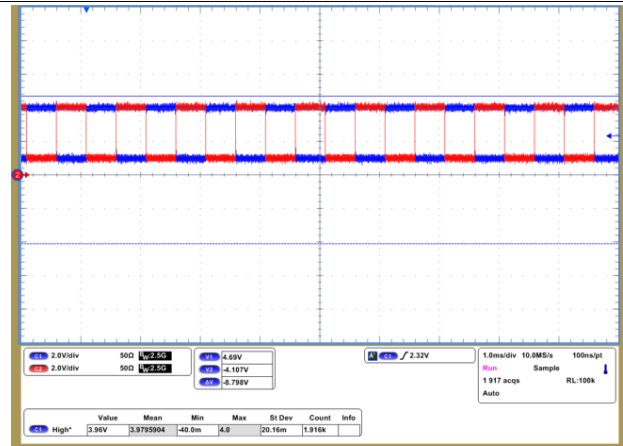

图 12. Received RS-232 Signal

With the same setup and to test the long distance communication capability, a character string generated by the PC is transmitted over an 800-foot CAT5 cable. The signal integrity over the whole system is checked as well. The waveforms in 图 13 show the RS-485 signal with 9600 baud rate before and after the cable. With 115200 baud rate, the received RS-485 signal suffers a little more distortion in amplitude and jitter (图 15). In real application, the maximum transmission distance is impacted by the media and loading of the system.

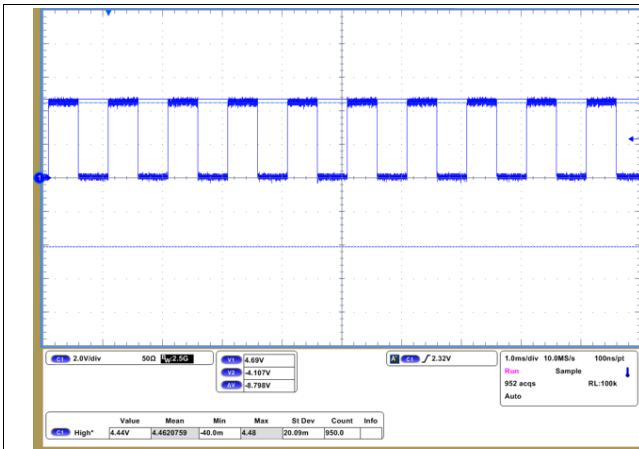

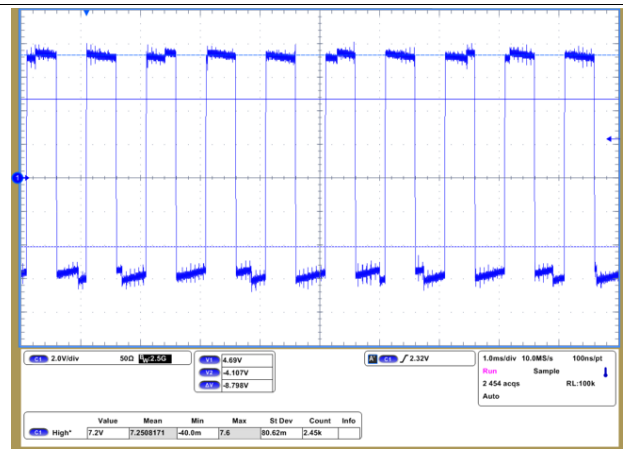

图 13. 9600 Baud Rate RS-485 Signal Before 800 feet Cable Transmission



图 14. 9600 Baud Rate RS-485 Signal After 800 feet Cable Transmission

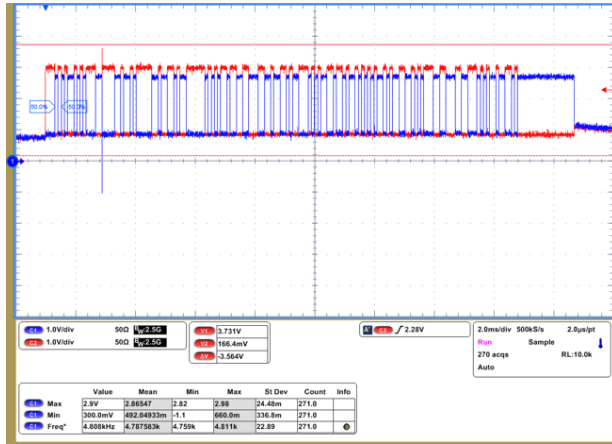

图 15. Received 115200 Baud Rate RS-485 Signal after 800 feet Cable Transmission

### 3.2.3 Test Results (Software)

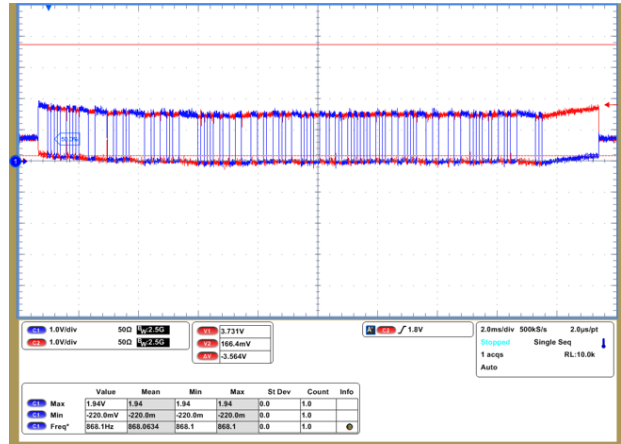
After the functionality tests, the software AccessPort was used to build real time communication between two PCs via the serial ports.

#### 3.2.3.1 9600 Baud Rate

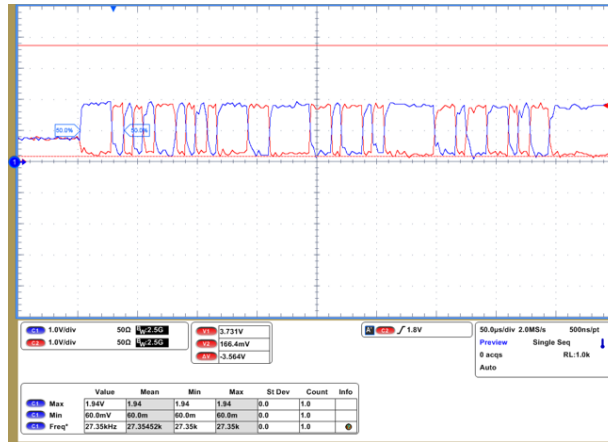
First the communication configuration was set up as [图 16](#) on the PC of TX end. To make the setup simple, the data format was chosen to be a 7-bit UART data without parity bit. To make capturing the waveforms on the oscilloscope easier, the data were sent repeatedly every 100 ms.

**图 16. 9600 Baud Rate Communication Configuration in AccessPort**

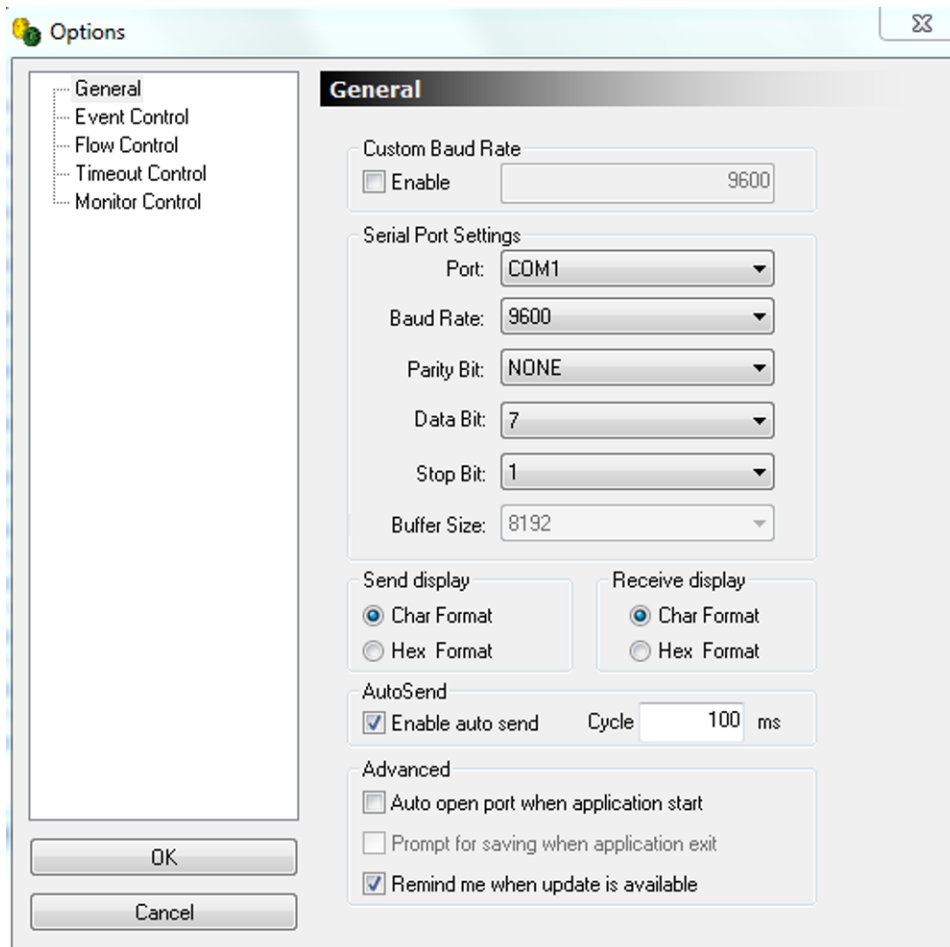

We do the same setting on the software of the receiver-end PC as well. A string of data is sent out by the software with the characters of “Texas Instruments TIDA-060008E1 RS232 to RS485”. The characters are transferred to binary ASCII code and sent to the serial port. On the receiver side, as the RS-232 signal is received on the serial port, the software detects the characters and shows them on the terminal. By comparison, the communication is successful and the same characters are shown repeatedly on the terminal ([图 18](#)).

图 17. Transmitted (Upper) and Characters on Two PCs



图 18. Received (Lower) Characters on Two PCs



### 3.2.3.2 115200 Baud Rate

To test the limit, chose the maximum data rate the software can support – 115200 baud rate with an 800-foot CAT5 cable. The communication was also successful.

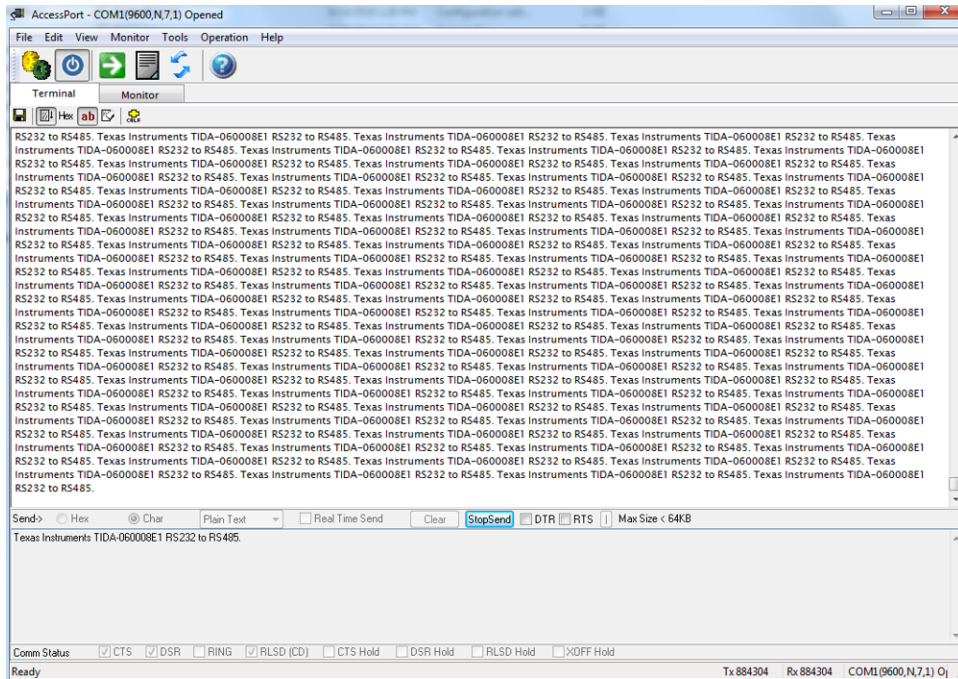
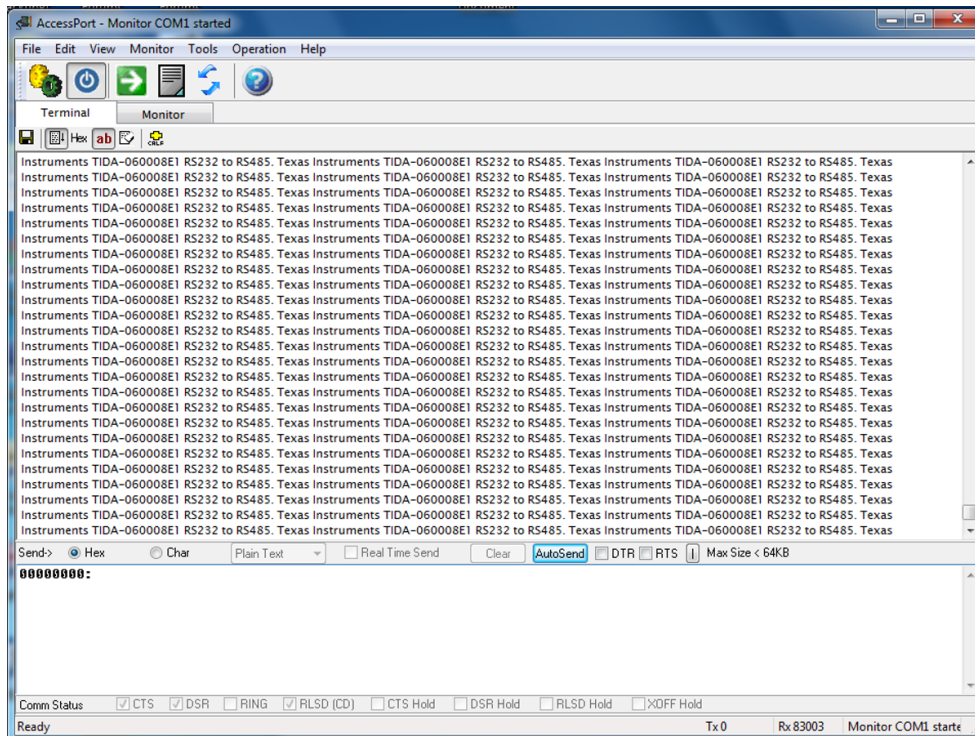
## 4 Design Files

### 4.1 Schematics

To download the schematics, see the design files at [TIDA-060008](#).

图 19. TIDA-060008 Schematic

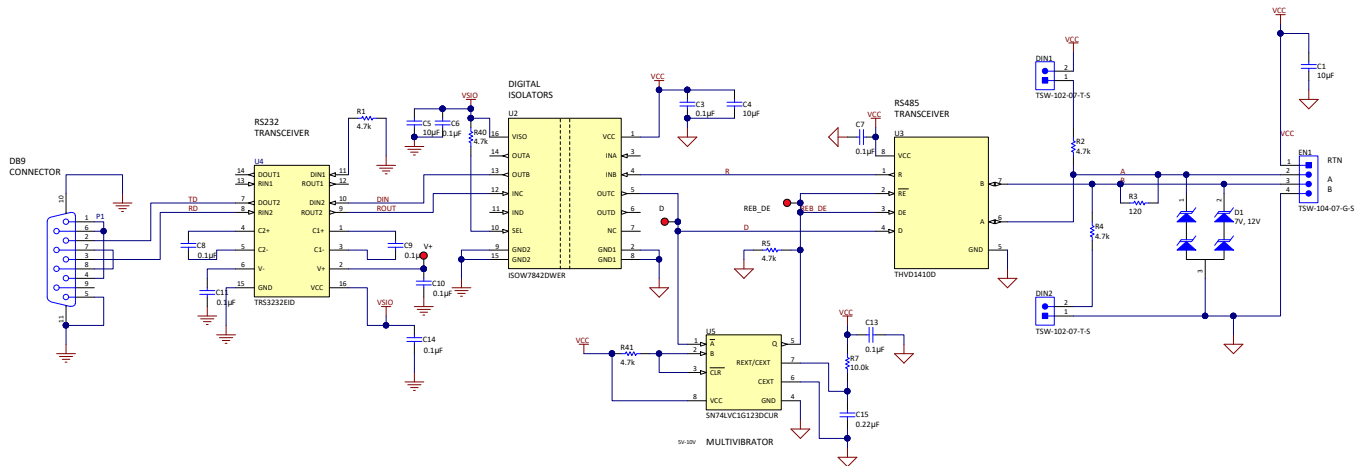

### 4.2 Bill of Materials

To download the bill of materials (BOM), see the design files at [TIDA-060008](#).

### 4.3 PCB Layout Recommendations

Place the flying capacitors and storage capacitors for the RS-232 charge pump close to the transceiver. Place decoupling capacitors close to the power pins of each device to help filter out noise.

- Use VCC and ground planes to provide low inductance.

注: High-frequency currents follow the path of least impedance and not the path of least resistance

- Ensure that enough copper is present on both GND pins of ISOW7842 to prevent the internal junction temperature of the device from rising to unacceptable levels.
- Use at least two vias for VCC and ground connections of bypass capacitors and protection devices to minimize effective via inductance.

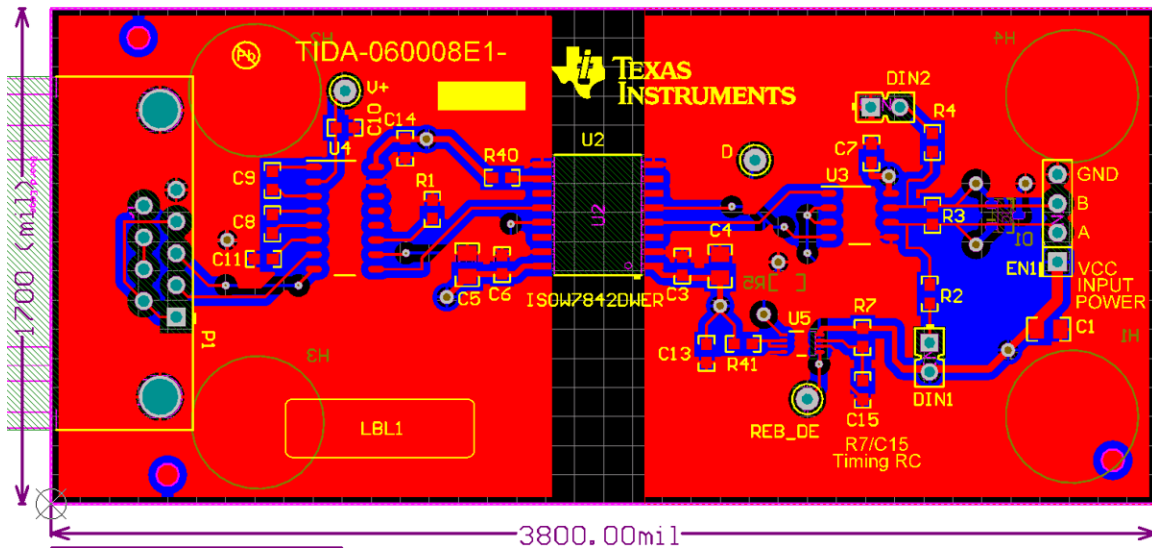
**图 20. TIDA-060008 Layout**

#### 4.3.1 Layout Prints

To download the layer plots, see the design files at [TIDA-060008](#).

#### 4.4 Altium Project

To download the Altium Designer® project files, see the design files at [TIDA-060008](#).

#### 4.5 Gerber Files

To download the Gerber files, see the design files at [TIDA-060008](#).

#### 4.6 Assembly Drawings

To download the assembly drawings, see the design files at [TIDA-060008](#).

### 5 Software Files

To download the software files, see the design files at [TIDA-060008](#).

### 6 Related Documentation

1. [RS-422 and RS-485 Standards Overview and System Configurations](#)
2. [The RS-485 Design Guide](#)
3. [Texas Instruments, How the RS-232 transceiver's regulated charge-pump circuitry works, blog](#)
4. [Self-Powered Isolated RS-232 to UART Interface Design Guide](#)
5. [Digitally Isolated, RS-232 Interface Module With Handshake Signals Design Guide](#)

#### 6.1 商标

E2E is a trademark of Texas Instruments.

Altium Designer is a registered trademark of Altium LLC or its affiliated companies.

All other trademarks are the property of their respective owners.

## 重要声明和免责声明

TI 均以“原样”提供技术性 & 可靠性数据（包括数据表）、设计资源（包括参考设计）、应用或其他设计建议、网络工具、安全信息和其他资源，不保证其中不含任何瑕疵，且不做任何明示或暗示的担保，包括但不限于对适销性、适合某特定用途或不侵犯任何第三方知识产权的暗示担保。

所述资源可供专业开发人员应用 TI 产品进行设计使用。您将对以下行为独自承担全部责任：(1) 针对您的应用选择合适的 TI 产品；(2) 设计、验证并测试您的应用；(3) 确保您的应用满足相应标准以及任何其他安全、安保或其他要求。所述资源如有变更，恕不另行通知。TI 对您使用所述资源的授权仅限于开发资源所涉及 TI 产品的相关应用。除此之外不得复制或展示所述资源，也不提供其它 TI 或任何第三方的知识产权授权许可。如因使用所述资源而产生任何索赔、赔偿、成本、损失及债务等，TI 对此概不负责，并且您须赔偿由此对 TI 及其代表造成的损害。

TI 所提供产品均受 TI 的销售条款 (<http://www.ti.com.cn/zh-cn/legal/termsofsale.html>) 以及 [ti.com.cn](http://www.ti.com.cn) 上或随附 TI 产品提供的其他可适用条款的约束。TI 提供所述资源并不扩展或以其他方式更改 TI 针对 TI 产品所发布的可适用的担保范围或担保免责声明。

邮寄地址：上海市浦东新区世纪大道 1568 号中建大厦 32 楼，邮政编码：200122  
Copyright © 2018 德州仪器半导体技术（上海）有限公司

## 重要声明和免责声明

TI 均以“原样”提供技术性 & 可靠性数据（包括数据表）、设计资源（包括参考设计）、应用或其他设计建议、网络工具、安全信息和其他资源，不保证其中不含任何瑕疵，且不做任何明示或暗示的担保，包括但不限于对适销性、适合某特定用途或不侵犯任何第三方知识产权的暗示担保。

所述资源可供专业开发人员应用 TI 产品进行设计使用。您将对以下行为独自承担全部责任：(1) 针对您的应用选择合适的 TI 产品；(2) 设计、验证并测试您的应用；(3) 确保您的应用满足相应标准以及任何其他安全、安保或其他要求。所述资源如有变更，恕不另行通知。TI 对您使用所述资源的授权仅限于开发资源所涉及 TI 产品的相关应用。除此之外不得复制或展示所述资源，也不提供其它 TI 或任何第三方的知识产权授权许可。如因使用所述资源而产生任何索赔、赔偿、成本、损失及债务等，TI 对此概不负责，并且您须赔偿由此对 TI 及其代表造成的损害。

TI 所提供产品均受 TI 的销售条款 (<http://www.ti.com.cn/zh-cn/legal/termsofsale.html>) 以及 [ti.com.cn](http://www.ti.com.cn) 上或随附 TI 产品提供的其他可适用条款的约束。TI 提供所述资源并不扩展或以其他方式更改 TI 针对 TI 产品所发布的可适用的担保范围或担保免责声明。

邮寄地址：上海市浦东新区世纪大道 1568 号中建大厦 32 楼，邮政编码：200122  
Copyright © 2018 德州仪器半导体技术（上海）有限公司