

TI Designs: TIDEP-0091

IWR1443 77GHz 液位变送器功耗优化参考设计



说明

TIDEP-0091 重点介绍了 IWR1443 76 至 81GHz 毫米波传感器的功耗优化策略，用于在液箱液位探测应用、位移传感器、4 至 20mA 传感器以及其他低功耗应用中以低功耗封装和高精度检测距离。在这些应用中，系统通常在低电压数据线路上运行，该线路的功耗远低于正常运行功耗。介绍了几种用于降低毫米波传感器功耗的方法。此外，TIDEP-0091 为一维距离检测提供了示例配置。

资源

TIDEP-0091	设计文件夹
IWR1443	产品文件夹
IWR1443BOOST	工具文件夹

特性

- 包含软件源代码、原理图、物料清单 (BOM) 和设计文件
- 为一维距离检测提供经优化的线性调频脉冲
- 适用于任何需要低功耗占空比的应用
- 提供功耗优化测试结果

应用

- [液箱液位探测](#)
- [位移变送器](#)
- [安全防护装置](#)
- [运动检测器](#)



咨询我们的 E2E 专家

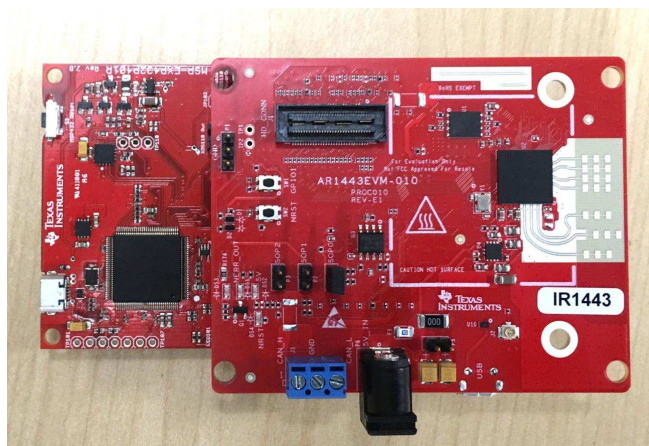
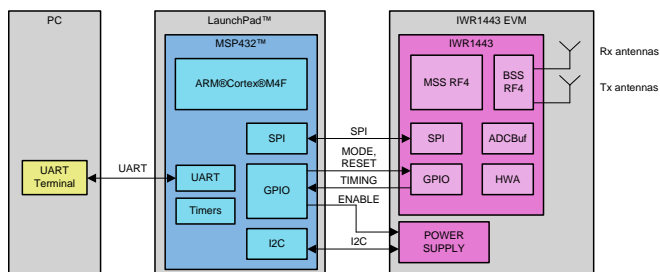

该 TI 参考设计末尾的重要声明表述了授权使用、知识产权问题和其他重要的免责声明和信息。

1 System Description

In the TIDEP-0091 the MSP432 LaunchPad™ is the master controller and is physically connected to the IWR1443 EVM through the standard LaunchPad, 20-pin headers. All communication between the boards is accomplished using these headers. A standard, 3-pin serial peripheral interface (SPI) is used as communications protocol, and general purpose IOs (GPIOs) are used for control and measurement flagging. User communication is provided through a micro-USB cable, which carries standard UART serial data to a host (PC) terminal window.

The MSP432 is directed through UART commands to power up the IWR1443 as necessary, to obtain range measurements through SPI from the IWR1443, and to power down the system when not in use. These steps are taken to reduce the average power required to take periodic measurements—an important goal for industrial applications. The MSP432 will remain in a low-power mode whenever not processing a measurement or UART command.

2 System Overview

The level sensing application uses the mmWave sensor to sense the distance to the reflected liquid or solid surface. The top mounted level sensor measurement is converted to tank level, as shown in [图 1](#). The FMCW sensor measures 2x distance to the 77 to 81-GHz reflecting surface.

The mmWave Industrial sensor program, sensor FMCW parameters, and calibration matrix are stored in QSPI flash, and is loaded each power-on cycle.

The mmWave industrial sensor typically uses 1 transmit (Tx1) and 1 receive (Rx4) antenna, either to a patch antenna with dielectric lens, or for a waveguide launch for a horn antenna. The mmWave sensor field of view is typically narrow (< 10 degrees), along the bore sight from the antenna lens or horn, perpendicular to the tank bottom.

The mmWave industrial sensor communicates with the host processor MSP432 over SPI, Control UART, and GPIO. In this application, the top magnitude returned signals are converted to range in meters, and sent over the SPI port. A customization is to return the averaged chirp 1D FFT to the host, and the higher power.

The current mode converts the receiver complex output (1x mode) with a 1024-point FFT, averaged over a user-defined number of chirps (to satisfy the radar equation integration time) into magnitude of the reflected pulse and the 1D FFT frequency. Changing the sensor FMCW parameters allows the mmWave industrial sensor to sense a distance from 10 to 100 meters. In the future, zoom FFT software will interpolate between FFT bin points to have a lower FFT frequency / bin (that is, a lower range per bin).



图 1. TIDEP-0091 System Block Diagram

2.1 Hardware Implementation

The level sensing application has several hardware sections shown in 图 2. The analog output and digital communication sections are not included in this design, which focuses on the mmWave industrial sensor, the low-voltage power supply, and the MSP432P401R host processor.

Low power is achieved through several modifications to the mmWave industrial sensor IWR1443, and the MSP432P401R host processor:

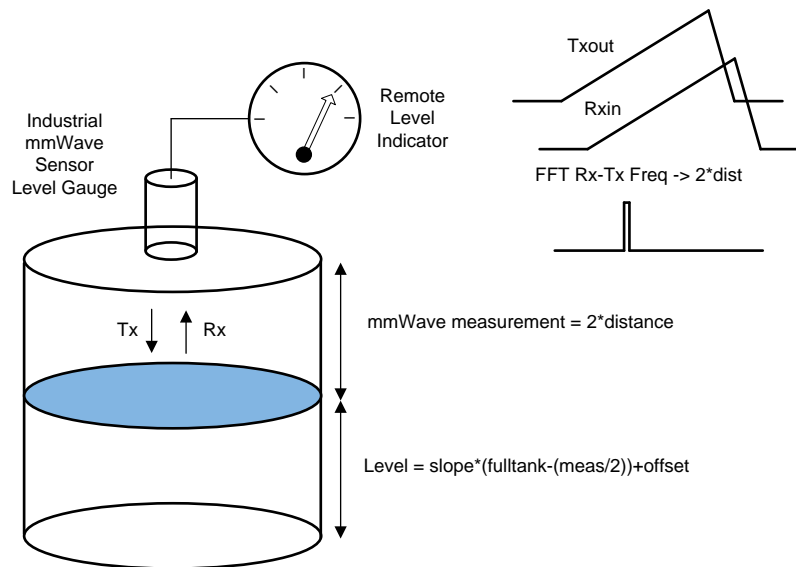
- Software: The host processor wakes up to perform tasks, and returns to low power mode.
- Hardware: Power cycling the low-voltage power supply for the mmWave industrial sensor.
- Software: Minimizing the mmWave industrial sensor configuration time by having an internal configuration instead of a host processor SPI configuration.
- Software: Using a stored full calibration, and performing partial initial calibration.
- Software: Sending the detected peak range and magnitude instead of sending the range FFT to the host processor.
- Hardware: Optimized low-voltage power supply settings for higher power efficiency.

The hardware sections are described below. This reference design modifies the mmWave industrial sensor IWR1443 BOOST EVM for specific hardware functions and loaded software. The MSP-EXP432P401R is used for the host processor. There is an Altium hardware design that extracts the interfaces from both EVMs. Refer to 图 2 for the following hardware block diagram, and description. 图 3 shows the EVM connectivity for the demonstration.

- The mmWave FMCW IWR1443 sensor and antenna interface provides the mmWave RF FMCW, hardware accelerator, ARM processing for RF scan, and conversion to distance.
- The MSP432R401 host processor controls the power sequence to the mmWave sensor, converts the returned distance into the industrial communication (4 to 20 mA, digital communication) output, and responds to specialized external digital calibration and remote firmware update commands.
- The specialized low-voltage power supply has a continuous high efficiency power for the host

processor and communication interface, and a switched special high efficiency power supply for the mmWave industrial sensor.

- The 4 to 20-mA current loop or digital communication is provided to communicate the sensed variable to the industrial control system. These are not discussed further in this design guide.



图 2. TIDEP-0091 Block Diagram

2.2 MSP432 Host Controller to mmWave Industrial Sensor

In the TIDEP-0091, the MSP432 LaunchPad™ is the master controller and physically connected to the IWR1443 EVM through the standard LaunchPad 20-pin headers. In the Altium schematic, the MSP432 LaunchPad and IWR1443 BOOST EVM board are combined into a common schematic.

All communication between the boards is accomplished using these headers. The interface between the MSP432 and mmWave sensor are shown in 图 2 and 图 3.

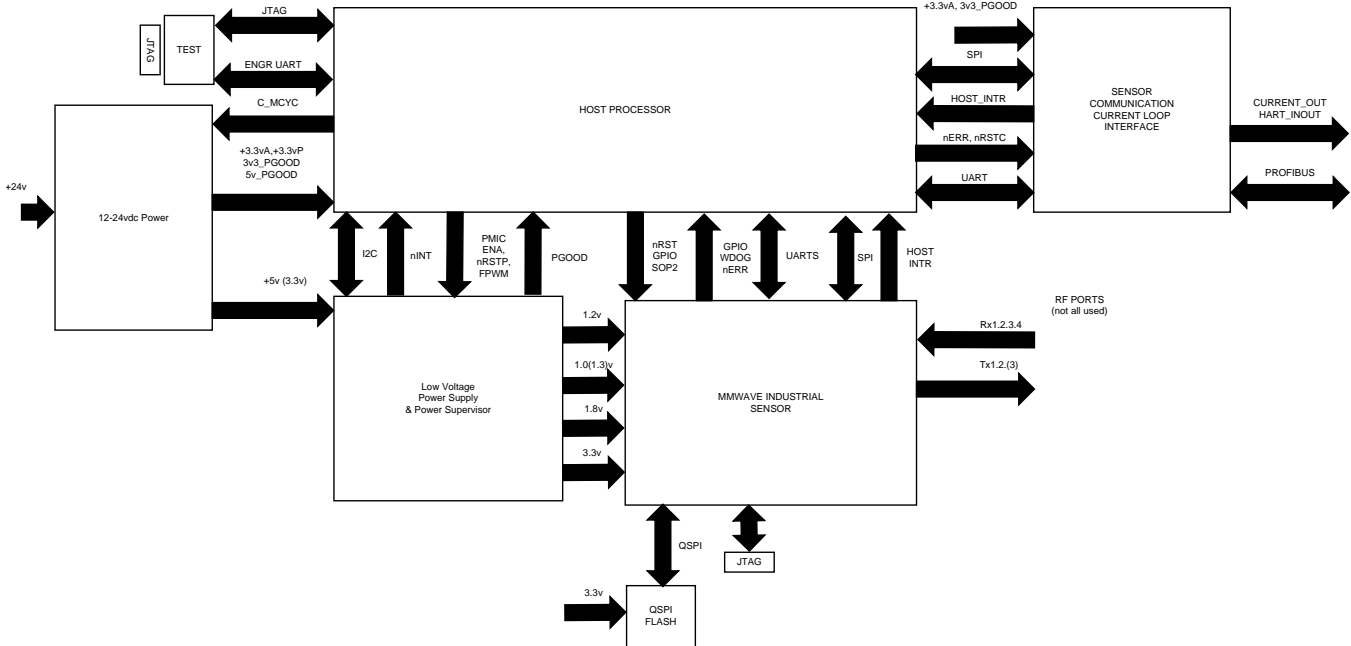
- 4-wire slave (to and from the mmWave sensor) SPI interface – industrial control and data interface
- GPIO host interrupt (from the mmWave sensor) to the MSP432 – read SPI
- GPIO-1 MSP432 output to the mmWave sensor input for mode control, 1=Calibration, 0 = Functional cycle
- nRESET – GPIO from the MSP432 to release reset for the mmWave industrial sensor
- GPIO-0 output from the mmWave sensor for timing to the MSP432 – timing signal
- Control UART-Tx,Rx – used for flashing the QSPI flash contents, from the host controller
- GPIO-SOP-2 – from the host controller to place the mmWave industrial sensor in Flashing =1, or Functional = 0 mode



图 3. TIDEP-0091 mmWave Sensor IWR1443 BOOST and MSP432R401 EVM Diagram

The connectivity of the IWR1443 BOOST EVM and MSP-EXP432P401R LaunchPad is shown in the CompareMSP432_IWR1443BOOSTBPLP.xlsx spreadsheet reference. Refer to the IWR1443 BOOST EVM technical documents for the schematic. Refer to the MSP-EXP432P401R LaunchPad schematic in the EVM user guide for the schematic.

The required signal list is shown in 表 1.

表 1. IWR1443 BoosterPack BP to MSP432 LaunchPad EVM LP Connections

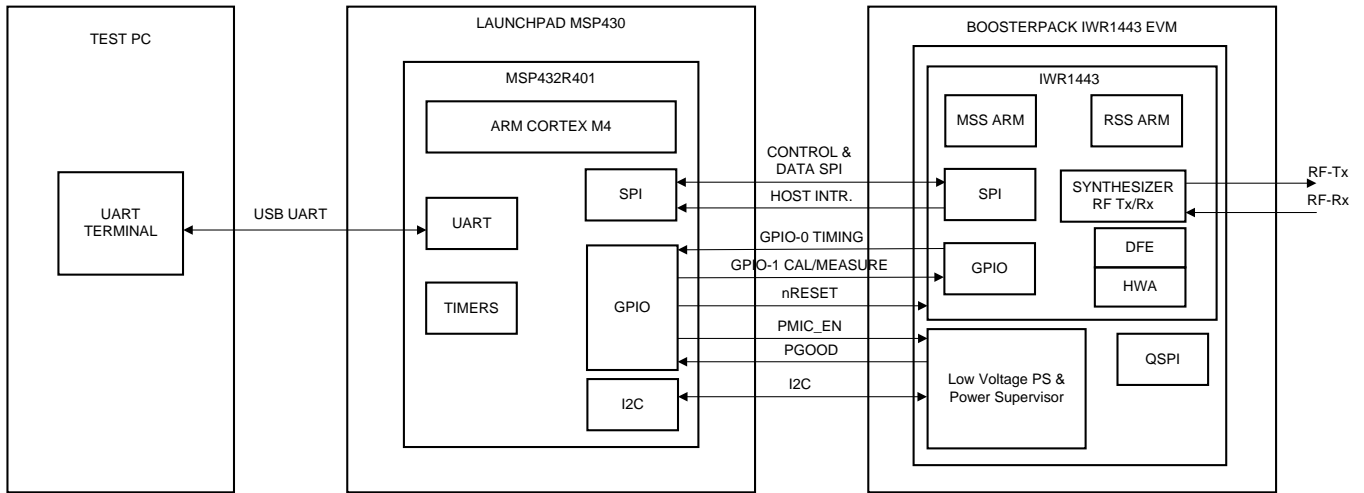
Name	IWR1443 Booster Pack EVM Connection	Name	MSP432 Launch Pad EVM Connection
GND	J5-2	GND	J2-1
AR_CS1 (Slave SPI Chip Select)	J5-6	P3.0 IO SPI_CS (out)	J2-3
(addwire) AR_nRESET (Reset in)	J5-7	P5.6 PWM (GIO out)	J4-4
AR_GPIO1 (GIO in)	J5-8	P5.7 IO (GIO out)	J2-4
AR_MOSI1 (Slave SPI serial in)	J5-12	P1.6 SPI MOSI (serial out)	J2-6
AR_MISO1 (Slave SPI serial out)	J5-14	P1,7 SPI MISO (serial in)	J2-7
AR_HOSTINTR1 (Slave GIO out)	J5-16	P5.0 IO SPICS (GIO intr in)	J2-8
AR_SPICLK1 (Slave SPI Clk in)	J6-13	P1.5 SPICLK (out)	J1-7
PGOOD (PwrOK out)	J6-14	P4.5 Ang8 I2S WS (GIO in)	J3-7
(add res) AR_GPIO0 (GIO out)	J6-15	P4.6 IO (GIO in)	J1-8
(add res) PMIC_EN (PMIC in)	J6-16	P4.7 Ang6 I2SCLK (GIO out)	J3-8
AR_SCL I2C – SCL (PMIC In)	J6-17	P6.5 IO I2C SCL (out)	J1-9
AR_SDA I2C – SDA (PMIC bidir)	J6-19	P6.4 IO I2C SCL (bidir IO)	J1-10

注: The connector orientations on the two boards are for different connector styles, (2) 20-pin connectors on the IWR1443 BOOST EVM, (4) 10-pin connectors on the MSP432 LaunchPad.

2.3 MSP432 BOOST EVM Description

The host processor MSP432 collateral is available under the TI documents for the MSP430 family on the TI website. The MSP432P401R contains an ARM processor, peripherals, and internal flash.

The MSP432P401R is the first MSP432 family device featuring low-power performance with an ARM® Cortex®-M4F core. Device features include:

- Low-power ARM Cortex-M4F MSP432P401R
- Up to 48-MHz system clock
- 256-KB flash memory, 64-KB SRAM, and 32-KB ROM with MSPWare™ software libraries
- Four 16-bit timers with capture, compare, and PWM, two 32-bit timers, and a real-time clock (RTC)
- Up to eight serial communication channels (I²C, SPI, UART, and IrDA)
- Analog: 14-bit SAR analog-to-digital converter (ADC), capacitive touch, and comparator

See <http://www.ti.com/product/MSP432P401R> for more details.

2.4 MSP432 Host Controller Software Overview

The MSP432 host processor software is briefly described in this section. When a timer interrupt or digital communication interrupt is received, the MSP432 wakes up to perform tasks. In the demo application, there is an UART/USB to control the MSP432 functions. The MSP432 host software diagram does the following:

- Power sequences the low-voltage power supply and mmWave industrial sensor
- Performs selected control UART commands (Demo UART)
- Performs a calibration cycle or functional measurement cycle of the mmWave industrial sensor
- Reports the calibration status, distance measurement, and timing information (Demo UART).

The MSP432 boot process, TI RTOS, and SimpleLink software provide the framework for the host controller software. The configuration block configures peripherals, for the command UART event or timer event.

The process sensor sequence provides for a power sequence for the mmWave industrial sensor, then controls either the sensor calibration or measurement cycle.

After the mmWave sensor returns the range and magnitude data, the linear computation of tank level occurs, and the host processor updates the output I/O of the process sensor.

The mmWave industrial sensor is turned off when the range and magnitude data is received. After the output I/O is updated, the host processor enters sleep mode.



图 4. TIDEP-0091 MSP432 Host Processor Software Flow (Blue Boxes are Not Implemented)

2.5 mmWave Industrial Sensor IWR1443 Description

The IWR1443 is a mixed signal system on a chip device that contains the RF, digital signal processing, embedded ARM R4F, internal peripherals, SRAM DMA, and external digital peripherals. In 图 5, the ARM R4F configures the digital side peripherals and communicates with external interfaces. The RF Control BIST block, BSS(RSS) is another Arm R4F that controls the RF circuitry, A2D converters, synthesizer, and digital front end (DFE).

The RF signal path, frame generation, has a synthesizer frequency for Tx and mixer. The receiver amplifies the signal, and in the mixer direct-down conversion is performed to baseband. The A2D samples the mixer output. [Programming Chirp Parameters in TI Radar Devices](#) and [MIMO Radar Application Report](#) discuss the transmit chirp and frame process. The DFE filters decimate and create the complex or real baseband format for the ADC buffer. The [IWR1443 Single Chip 76- to 81-GHz mmWave Sensor Data Manual](#) and [IWR1443 Technical Reference Manual](#) have more details.

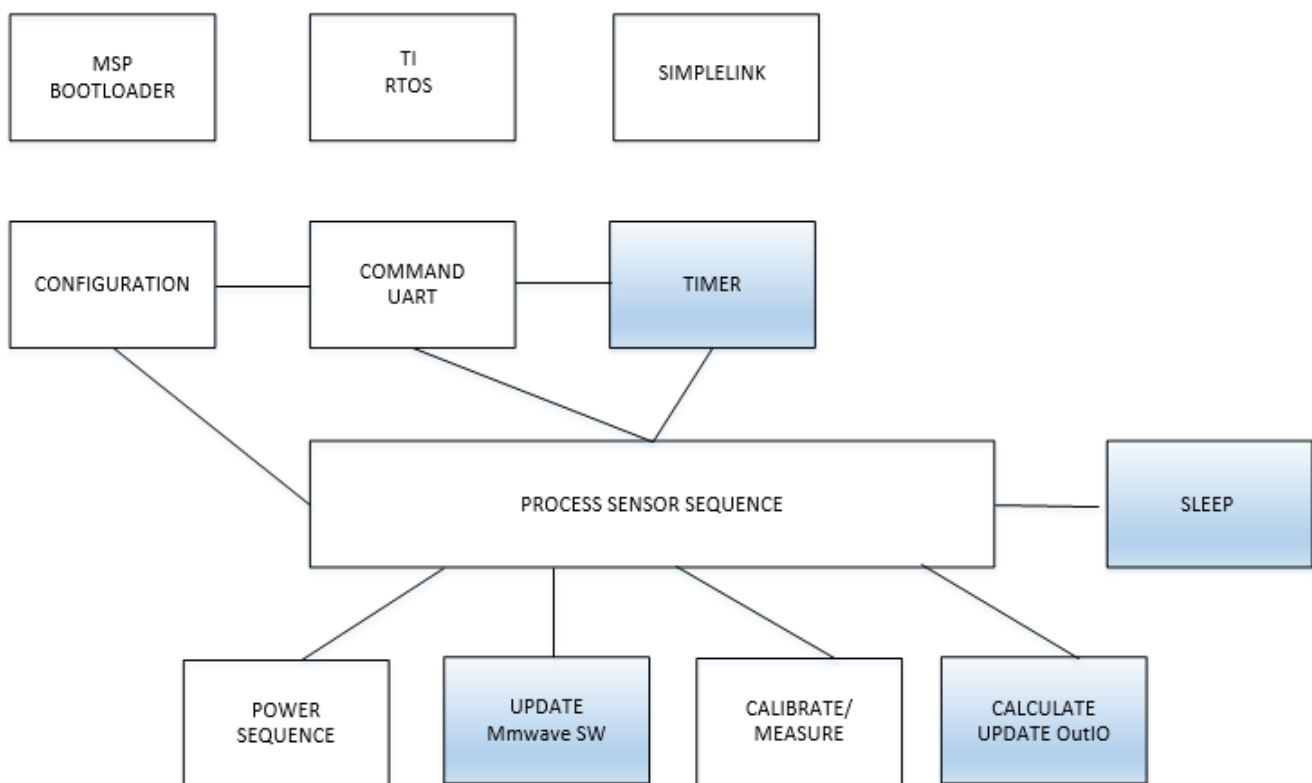
The ADC buffer is processed in the hardware accelerator HWA; the MSS arm averages the 1DFFT outputs, detects the highest magnitude peaks and converts the frequency bin to distance, for SPI output.



图 5. TIDEP-0091 IWR 1443 mmWave Sensor Block Diagram

2.6 mmWave Industrial Sensor Software

The mmWave industrial sensor IWR1443 has MSS software described in the following section, and in the mmWave SDK User Guide. Additional software is in ROM for the RF Control BIST, for RF and synthesizer controls. This is discussed in the [mmWave Radar Interface Control Document](#).

The IWR1443 software is divided into several categories:

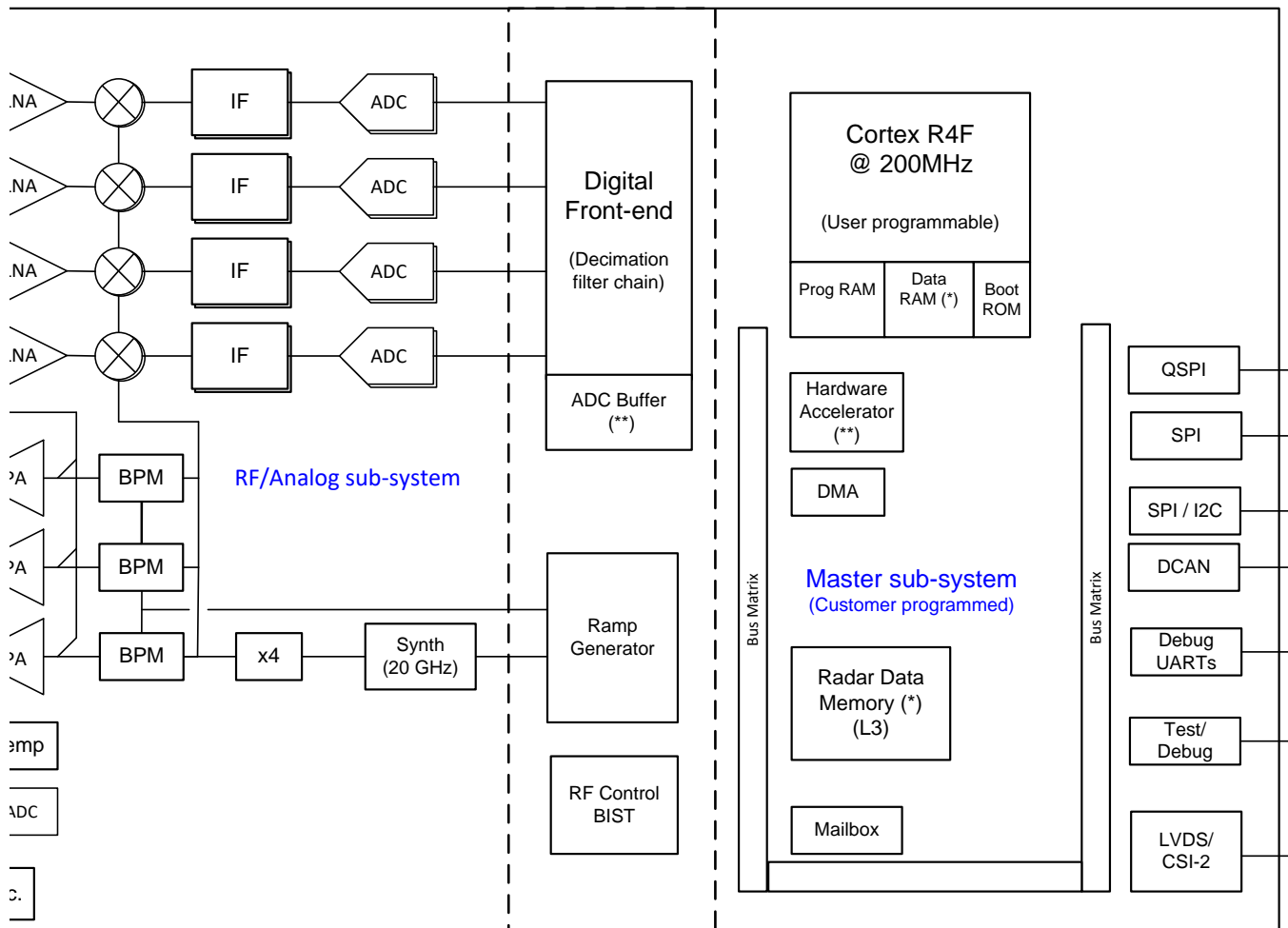
- MSS Boot ROM – This software is preprogrammed for functional boot, flashing boot, and SPI and QSPI / Control UART / and QSPI peripherals.
- QSPI loaded BSS patch – The BSS R4F RF control processor code updates are provided to supplement the BSS R4F ROM.
- QSPI loaded MSS software – This is the software toolchain, mmWave link, mmWave driver, mmWave API, and application code.
- Another QPSI section is used to store the calibration data

The mmWave industrial sensor user application communicates with the mmWave software development kit (SDK) primarily through the mmWave application program interface (API), which is a simple, high-level API with calls such as MMWave_init, MMWave_config, and MMWave_execute. These calls communicate with the lower layers, including the mmWave drivers that communicate to peripherals such as ADCBuf and HWA, and the mmWave link API that communicates to the BSS firmware through the mailbox peripheral.



图 6. IWR1443 BOOST MSS/BSS Software Block Diagram

The mmWave link and MSS application provide a preprogrammed framework for the BSS RF setup. The preprogrammed values are based on the FMCW profile, chirp and frame. These are discussed in the mmWave SDK User Guide and [Programming Chirp Parameters in TI Radar Devices](#). The next section discusses these related to the level sensing application.

When the RF control is programmed, the BSS performs a partial calibration; if the calibration is successful, the FMCW synthesizer frame is enabled and the mmWave sensor Rx data is collected. Partial calibration takes ~1 ms, while the full calibration takes ~37 ms. The received Rx data is stored and converted to a range FFT (bin# frequency, complex magnitude). This data is DMAed to the L3 memory for later processing.

The radar Rx data range FFT is averaged, and the top 3 magnitude bins are searched for to send to the host processor. The mmWave industrial sensor sends the host interrupt, then the host processor reads the SPI data. See [图 7](#) for the complete functional communication sequence.

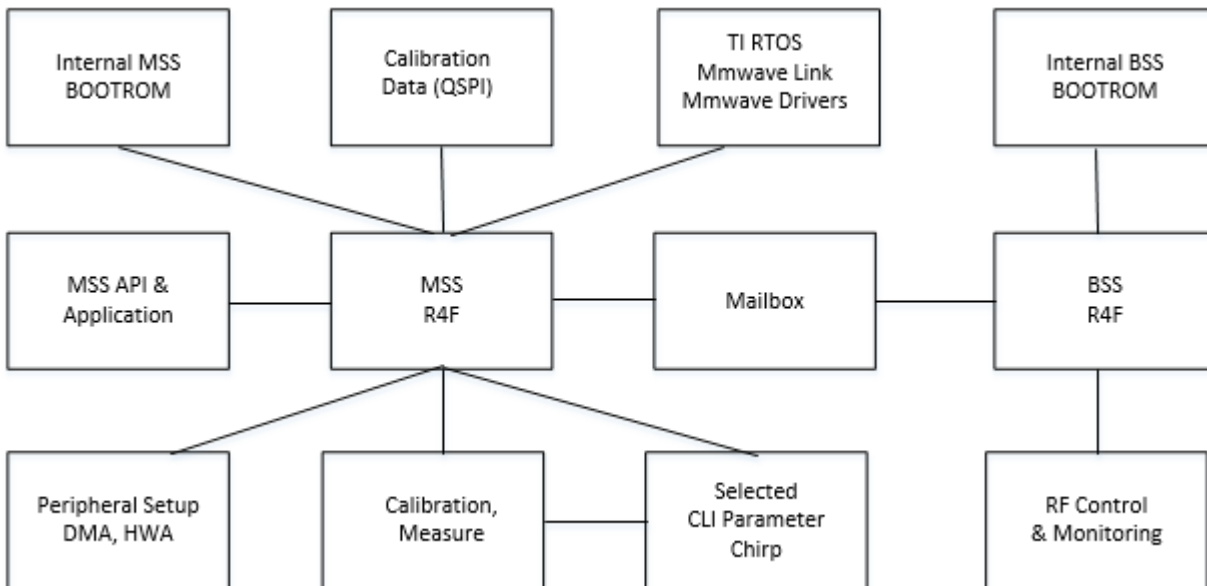
注: In different level-sensing range distances, the FMCW chirp parameters are different; the user must select or redesign a configuration.

Calibration mode – operates differently from the functional software mode. It starts the mmWave configuration, performs the full calibration cycle, and stores the calibration for future use. Calibration is an internal function, and does not include the antenna.

Flashing mode – The SOP[2] signal during the boot process determines if the mmWave industrial sensor is in flashing mode (=1) or functional mode (=0). In flashing mode, the Arm R4F receives data over the control UART port and writes the RSSpatch and MSS functional software to QSPI.

Key elements for the level sensing operation:

- MSP432 performs mmWave power-up sequence (PMIC control).
- MSP432 sets flashing / functional (calibration, measure) mode and releases nRESET.
- IWR1443 responds to mode; for functional mode, it loads the software from QSPI flash.
- IWR1443 MSS software performs calibration and stores to QSPI flash, or reads QSPI flash.
- IWR1443 MSS software sends MMWAVE commands and calibration to the RF BIST BSS processor.
- IWR1443 RF performs sensor measurement, ADC buffer has Rx data, and HWA converts to 1DFFT.
- IWR1443 MSS processor performs averaging finds peak magnitude, and formats a message for SPI.
- IWR1443 MSS signals host interrupt and the MSP432 reads SPI message.
- MSP432 performs the shutdown mmWave sequence.



图 7. TIDEP-0091 Level Sensing Control and Communication Sequence

2.7 mmWave FMCW Configuration, RCS, Antenna Gain, and Configuration Spreadsheet

The mmWave industrial sensor can be used within certain system parameters, and with specific system tuning (adjustment of parameters). The general mmWave link commands implement what is needed to control the RF parameters; the frequency modulated continuous wave (FMCW) parameters can be adjusted. The mmWave sensor has terms of range (distance that can be observed), velocity (the detectable rate of change of position), and in some systems multiple Rx inputs can be used to determine the angle to the detected object.

The key parameters are the reflection of the object the FMCW reflects from RCS, the range to the object R, the transmit power, receiver LNA gain, the antenna directivity, and the amount of time the FMCW signal reflects off the object. See Mmwave_webinar_Dec2017.pdf, for a complete discussion or the training material in the mmWave TIREX Industrial Control Toolbox.

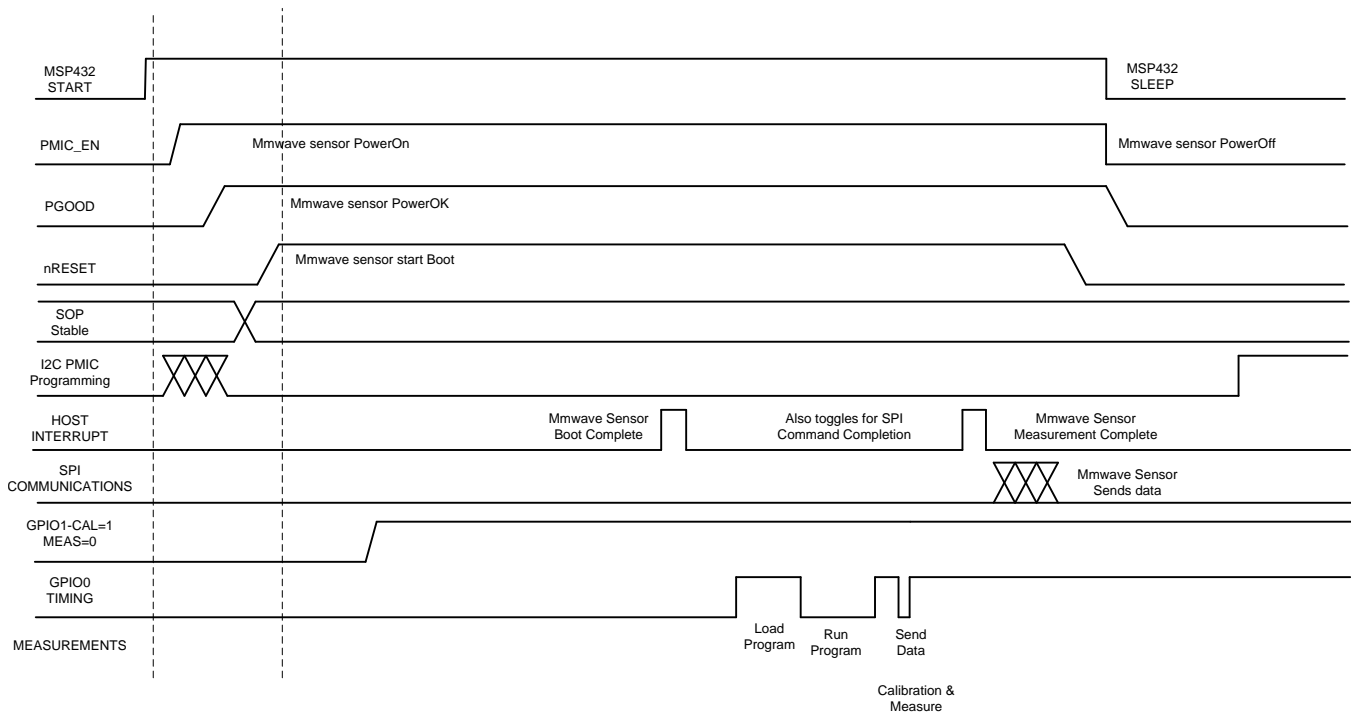
TBD

(1)

In the level-sensing application, the items that are changed are listed below:

- Pt – Power transmitter is the FMCW setting, typically 6 – 12dbm
- Gt – Gain is a combination of system RF loss, and the antenna / lens or horn that is used to emit RF
- RCS – Based on the fluid or object the 77 to 81-GHz signal is reflected from; the shape, material properties, and frequency are all important (example: oil is less reflective than water)
- Gr – Gain is a combination of system RF loss and the antenna / lens or horn that is used to received RF energy
- Tf – The integration time, or the time the radar is transmitting
- Rmax – The range that can be detected

One example is copied from the System FMCW Level Sensing spreadsheet. There are examples of 15, 30, 50, 75, and 100 meters.

A summary from the [spreadsheet](#) is provided to illustrate what can be changed.

注: Rx LNA gain is considered a tuning parameter, but can affect the Rx signal level (24 to 48-db gain). It is normally set to 30 db.

注: The antenna gain of the IWR1443Boost EVM boresight used for calculation is 9 dbi; customers will need a different antenna or waveguide RF launch for horn for longer range.

表 2. Different Range FMCW Parameter, Antenna Gain Values

Use case	Rmax (m)	Antenna Gain Tx/Rx	RCS	Integration Time	[DFEoutrate]	[ChirpBW]	[num chirps]
15	17.7	9/9	.5	.26 ms	7500e3	3.98G	2
30	30.2	12/12	.5	.55 ms	7500e3	3.99G	5
50	50.7	15/15	.5	1.1 ms	7500e3	2.8G	9
75	76.1	18/18	.5	1.4 ms	7500e3	1.8G	11
100	100.6	20/21	.5	1.4 ms	7500e3	1.4G	11

注: See the spreadsheet for the complete parameter set. Increasing the Rx LNA gain and lowering the Tx output power, and changing the number of chirps provides tuning. For hanging the synthesizer slope and numADC samples, refer to [this spreadsheet](#).

With DFE out rate changes the IF (distance bandwidth). The antenna or horn should be designed for the maximum range. Changing the antenna gain can lower the integration time, which lowers sensor power. In some cases, adding another Rx can be used to increase noncoherent combining process gain. See [Programming Chirp Parameters in TI Radar Devices](#) for the FMCW parameter definitions.

2.8 Low-Voltage Power Supply Discussion IWR1443 BOOST EVM and Modifications

The low-voltage power supply on the IWR1443 BOOST EVM consists of a 5-V multiple output PMIC, LP87524B and two RF LDOs TPS7A8101 (1.8 Vout), and a TPS7A8801 (dual 1.3 V out). The IWR1443 mmWave sensor has low ripple and noise allowed input voltage, as shown in the data sheet Table 5-2.

In trying to address a lower power system, TI evaluated the power supply efficiency. Because the mmWave radar industrial sensor does not have a low-power mode, the mmWave radar is power-cycled.

In laboratory tests, TI found that the mmWave radar industrial sensor operating cycle can be divided into:

- Boot phase and SOC initialization, followed by QSPI booting, low 1.8-V and low 1.3-V activity
- Load MSS software, and start mmwavelink commands before RF Init, low 1.3-V activity
- Remaining MMLink commands, partial calibration, and FMCW I, higher power short duration
- R4F and HWA computation and SPI transfer – low 1.3-V activity after frame stops

The LP87524B and RF LDOs are discussed in [XWR1xxx Power Management Optimizations - Low Cost LC Filter Solution](#), where the LP87524J PMIC and LC filters are used. This provides a 10% efficiency improvement. This mode uses 1.0 V instead of 1.3 V, and requires a special RFLDO bypass function in the RL software layer.

Further testing found that significant power was being expended, due to the LP87524 PMIC programmed in forced PWM mode for the 1.8-V power supply and 1.3-V power supply. Testing was done using the LP87524J PMIC, second stage LC filters, and reprogramming the PMIC for:

- BUCK2 Vout 1.3 V, thus the internal IWR1443 RF LDO 1.3 V -> 1.0 V is used
- BUCK2 Forced PWM = 0 – converting this BUCK stage 1.3 V to high efficiency / low current operation
- BUCK3 Forced PWM = 0 – converting this BUCK stage 1.8 V to high efficiency / low current operation

The Altium TIDEP0091 schematic shows this power supply modification.

During lab tests, TI measured the PMIC and LDO / LC filter power efficiency, as shown in [表 3](#).

表 3. Low Voltage Power Supply Configuration

PMIC	RFLDO 1v8	LC Filter 1v8	RFLDO 1v3	LC Filter 1v0/1v3	1v0/1v3	Force PWM	Efficiency	RFLDO Bypass	Notes
LP87524B	TPS7A810 1	no	TPS7A880 1	no	1v3	Force PWM	48%	0	Std EVM
LP87524J	no	yes	no	yes	1v0	Force PWM	58%	1	SWRA577
LP87524J	no	yes	no	yes	1v3	Auto	78%	0	Low power

3 Hardware, Software, Testing Requirements, and Test Results

3.1 Required Hardware and Software

3.1.1 Hardware

The following hardware is required to get the level-sensing demonstration running and set up to develop custom applications:

- An [MSP432P401R LaunchPad EVM](#)
- An [IWR1443 EVM](#)
- A 5-V, 2.5-A power supply for IWR1443 EVM
- A PC for Code Composer Studio™ (CCS) 7.x and the demonstration UART terminal

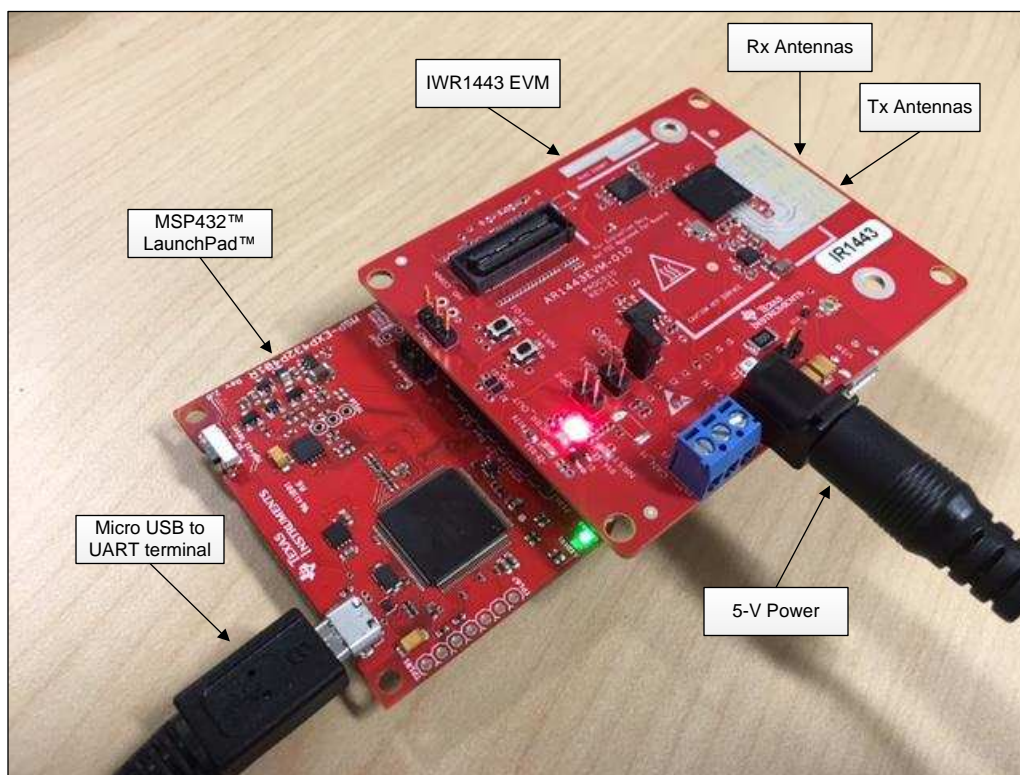

Copyright © 2017, Texas Instruments Incorporated

图 8. Level-Sensing Demonstration Hardware

IWR1443BOOST EVM Hardware modifications – see the IWR1443 EVM BOOST Assembly instructions in the Schematic/Assembly/BOM technical documents, under the IWR1443 BOOST EVM for schematic and physical locations. There is a set of closeup modifications, in the attached EXCEL file.

表 4. IWR1443 EVM BOOST Modification for Low Power Test

Part Designator	Action	Notes
R102	0 Ω, added to allow PMIC_EN to be driven by MSP432 over BP/LP	Required for MSP432 integrated software test, remote for mmWave Studio testing
U2	IWR1443 – device must be an ES3 revision or later to have MSS software loaded from ROM Replace ES1 or ES2 with ES3 part	ES3 part has a different flashing file type; it has the BSS patch and MSS code included in a common file. QSPI speed is 40 Mhz with this version
R164	0-Ω resistor to connect GPIO-0 to BP/LP header for MSP432 timing measurement	Check MSS software, for #define REPORT_IR14_TIME_MEASUREMENTS
U8	Replace LP87524B PMIC with LP87524J PMIC	Additional steps are needed to complete this modification – see SWRA577
U4	Remove TPS7A8101, replace with ferrite bead per SWRA577	Replace with 3 A, .18 uH, 120 Ω at 100-Mhz ferrite bead or inductor Pin U4 (7 or 8) to Pin U4(1 or 2)
R81	Remove feedback resistor	
U5	Remove TPS7A8801, replace with (2) ferrite beads per SWRA577	Replace with 3 A, .18 uH, 120 Ω at 100-Mhz ferrite bead or inductor Pin U5 (1 or 2) to Pin U5(15 or14) Pin U5 (4 or 5) to Pin U5(11 or12)
R132, R121	Remove feedback resistors	
R176	Replace R176 with epoxied two-pin header, and two-pin shunt	Replace with 2-pin jumper, jumper installed for flashing or using USB, removed for low power
R100	Remove resistor	Remote DS2 from 5-V current
R90	Remove resistor	Remote DS1 from 3.3-V current
R103	Remove resistor	Remote DS3 from 5-V current
R117	Remove resistor	Remote DS4 from 5v current
BP-LP J5-7 add wire to SW2 3 or 4	Add wire for AR_NRST to MSP432 control	Add wire for AR_NRST to MSP432 control

WARNING

When the above table modification is done without the I2C update from the MSP_432, the software RFLDO bypass must be set to 1. If the I2C update is performed after this modification OR if there is no modification, the RFLDO bypass must be a 0. Device damage can result from improper setting of this software.

3.1.2 Software

There are two executables required for this design. The first runs in the IWR1443's MSS R4F, and the second runs in the MSP432's M4F. The software required to build the MSS (IWR1443) executable is:

- [Latest mmWave SDK](#). The SDK now will automatically install the required component versions. These components are listed in the SDK's release notes and in the Getting Started Guide located in the /docs folder of the software package. Install the SDK and all required components before installing and building the demonstration source.
- [Code Composer Studio \(CCS\)](#). See the Getting Started Guide for the required version.

The software required for the MSP432 executable is:

- [MSP432 SimpleLink SDK](#), version 1.40.01
- [TI ARM compiler](#), version specified in the Getting Started Guide.

3.2 Testing and Results

3.2.1 Test Setup

3.2.1.1 Building the Demonstration

3.2.1.1.1 Building the MSP432™ Executable

Step-by-step instructions for creating the MSP432 CCS Project and executable are located in the Getting Started Guide, located in the /docs folder inside the software package.

3.2.1.1.2 Building the IWR1443 Executable

Step-by-step instructions for creating the IWR1443 CCS Project and executable are located in the Getting Started Guide, located in the /docs folder inside the software package.

3.2.1.1.3 Running the Demonstration

图 9 shows the proper configuration of the boards for running the demonstration (when both boards have been flashed). The Tx antennas project their beams perpendicularly to the front of the EVM, so position the EVMs facing the object to be measured. Also, the jumper has been removed from SOP2 (required for flashing); place the jumper on only one side of SOP2, so that it does not become lost. Complete step-by-step instructions for flashing and running the demo are provided in the Getting Started Guide in the software package

CCS is not used for running the demonstration, but the software can be debugged using CCS. Full instructions for debugging are provided in the Getting Started Guide.

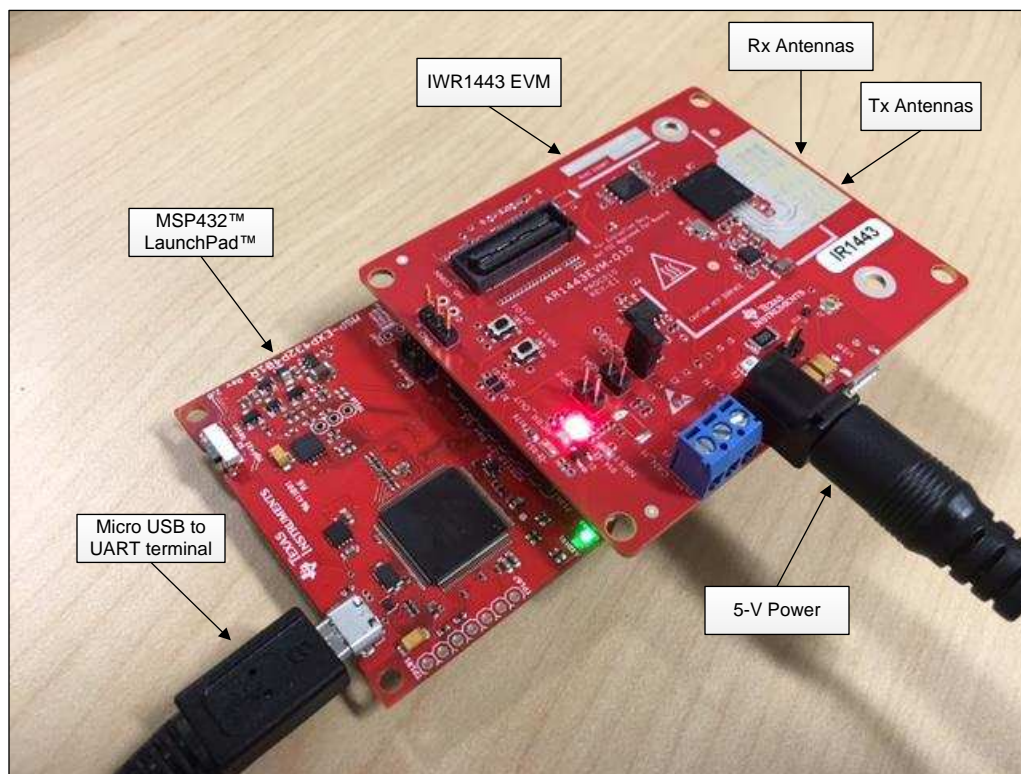

Copyright © 2017, Texas Instruments Incorporated

图 9. Level Sensing Demonstration Hardware

3.2.2 Test Results

3.2.2.1 Timing Measurements

Determining power usage requires knowing how much current is drawn versus the length of time the current is drawn. To determine run times of the various processing steps, an MSP432 48-Mhz timer is used, which captures the clock time at the start of each step then converts the time to milliseconds. This is possible because the MSP432 is controlling the power and reset of the IWR1443. IWR1443's GPIO_0 is also used, toggling up and down throughout a measurement cycle. These changes are captured and timed by the MSP432. If this time measurement is enabled (a build-time option), the results are output to the UART terminal along with the range data.

The times that are captured are:

- IWR boot time: This is the time from when PMIC_EN is pulled high to the time when the MSP432 detects GPIO_0 going high. This marks the start of the IWR application.
- IWR config time: This is time from when GPIO_0 goes high in the previous step to when it goes low. This marks the time when BSS calibration and MSS configuration have run.
- IWR chirp time: This is the time from when GPIO_0 goes low in the previous step to when it goes high a second time. This marks the time of the radar chirp.
- IWR post processing time: This is the time from when GPIO_0 goes high in the previous step to when the SPI transfer is received. This is the amount of time for the chirp outputs to be scanned and transmitted to the MSP432.

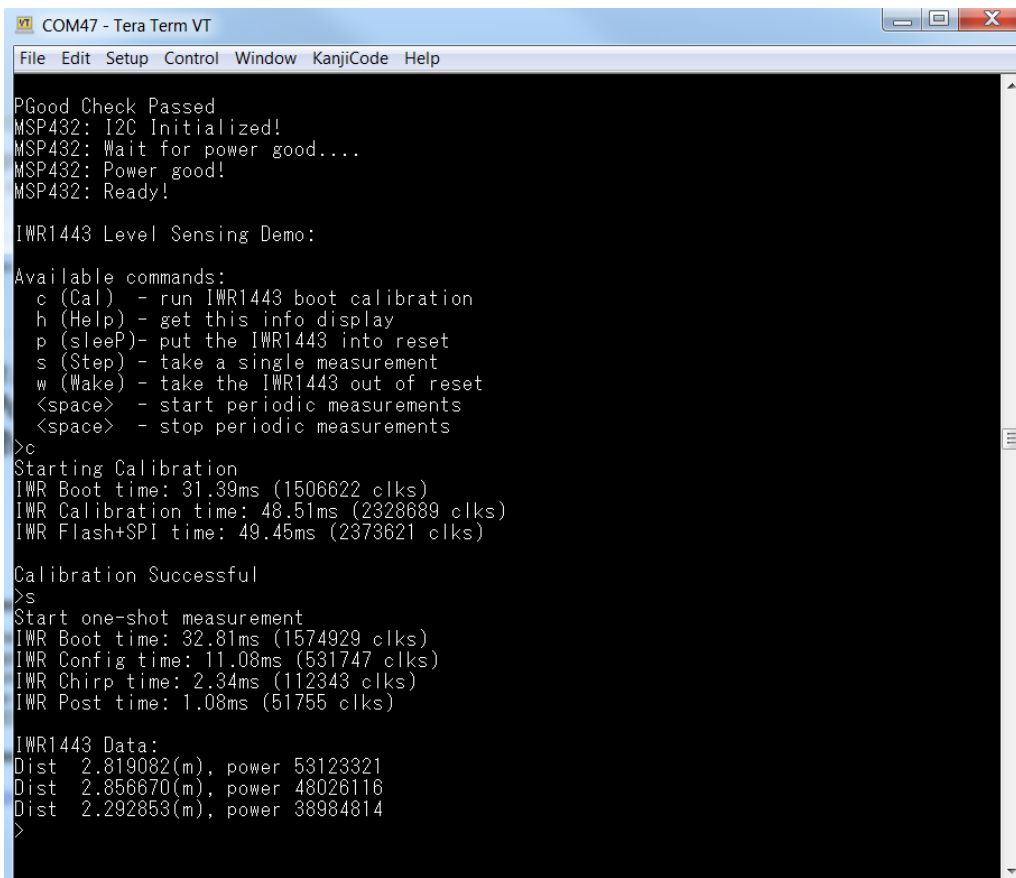

```

COM47 - Tera Term VT
File Edit Setup Control Window KanjiCode Help

PGood Check Passed
MSP432: I2C Initialized!
MSP432: Wait for power good...
MSP432: Power good!
MSP432: Ready!

IWR1443 Level Sensing Demo:

Available commands:
c (Cal) - run IWR1443 boot calibration
h (Help) - get this info display
p (sleep) - put the IWR1443 into reset
s (Step) - take a single measurement
w (Wake) - take the IWR1443 out of reset
<space> - start periodic measurements
<space> - stop periodic measurements
>c
Starting Calibration
IWR Boot time: 31.39ms (1506622 clks)
IWR Calibration time: 48.51ms (2328689 clks)
IWR Flash+SPI time: 49.45ms (2373621 clks)

Calibration Successful
>s
Start one-shot measurement
IWR Boot time: 32.81ms (1574929 clks)
IWR Config time: 11.08ms (531747 clks)
IWR Chirp time: 2.34ms (112343 clks)
IWR Post time: 1.08ms (51755 clks)

IWR1443 Data:
Dist 2.819082(m), power 53123321
Dist 2.856670(m), power 48026116
Dist 2.292853(m), power 38984814
>

```

图 10. Example of Demonstration Output

3.2.2.2 Power Measurements

This test measures the level sensing power using an oscilloscope, 200-mA current probe, and two high-impedance oscilloscope probes. The sample rate is high enough to capture several thousand samples, in the 40-ms (partial calibrate) or 100-ms (full calibration) cycle. In the example shown, the mmWave Power Up, Load Software, Partial Calibration, Measurement, Calculation. Output to the MSP432 has a one-measurement power of 20.4 mj for 2 chirp 15-meter use case.

注: After a QSPI flash update, the first test must be CALIBRATE (to update the QSPI flash with the CALIBRATION data).

图 11 shows the oscilloscope connections. The data from the oscilloscope should be captured with normal triggering 0->1. A picture of the oscilloscope display is shown in 图 12. If the oscilloscope data is captured in CSV format with Time, 5-V current, AR_nRESET, GPIO-0, and WARMRESET, the matlab script can extract the time and power results. The time power changes based on the use case selected. 图 13 shows the example matlab script output in CSV format. 图 14 shows the MSP432 energy trace of the host process.



图 11. Oscilloscope Connections



图 12. Example of Oscilloscope Capture

Typically there are two oscilloscope captures, one with the 5-V supply turned off with a forced oscilloscope capture. This is used to have a mean 5-V current for bias subtraction.

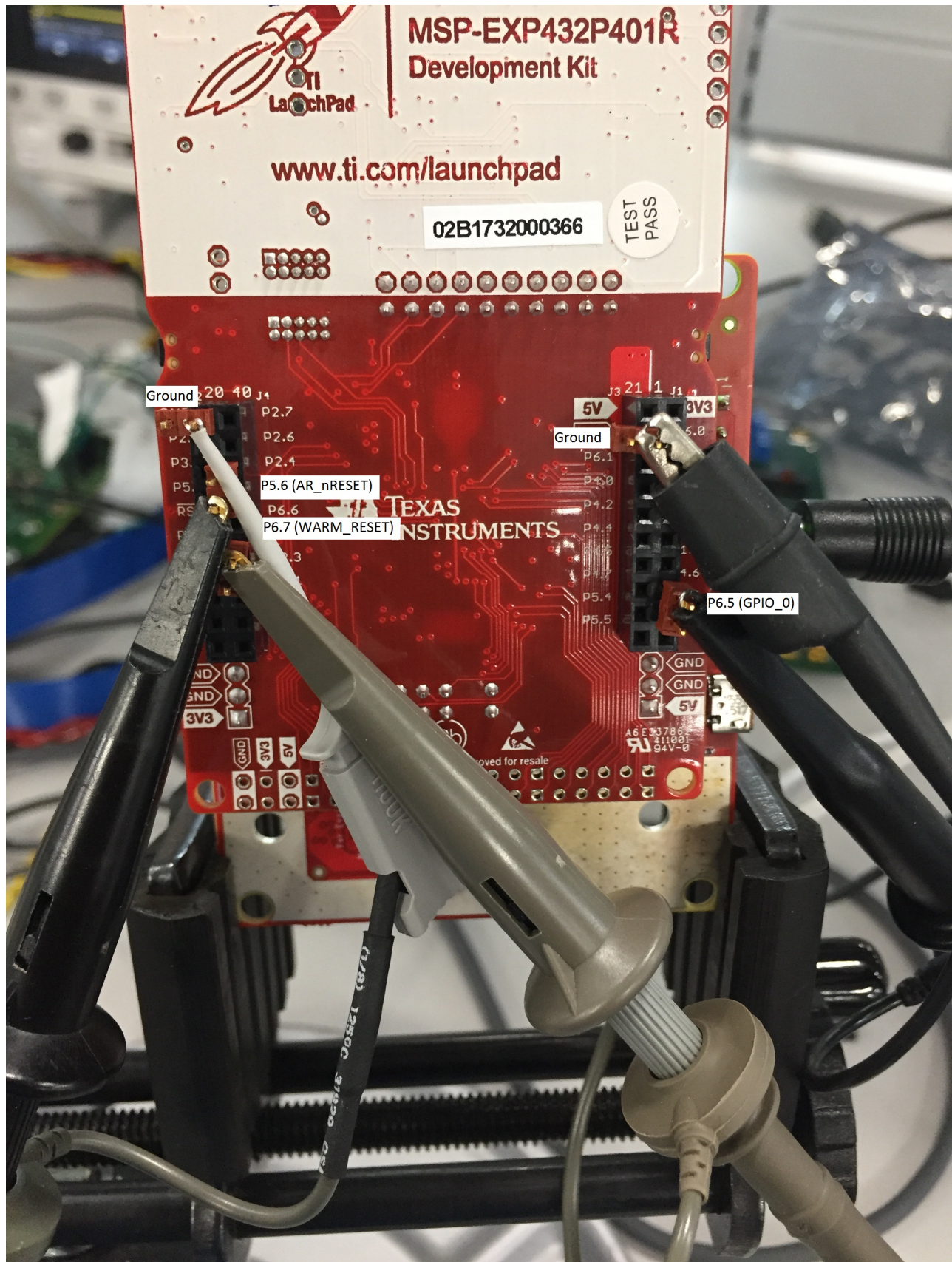
In the actual CSV captured data, the header line is removed, the file is saved, and the Matlab script is run.

- fpath
- fnameGIO
- ofname
- ofexcelname
- chan1_zerocurr are needed

The plotset=1 displays the raw plot, plotset=2 displays the 5-V power versus time trigger, and plotset = 3 saves an output .csv file with the power versus time. In this example, a 2-chirp configuration summary is displayed in 图 13.

A1		Test num					
	A	B	C	D	E	F	G
1	Test num	Duration	starttime	GPIOm	5v cur	5v pow	
2	Test# 1	0.007	0.00025	1	0.030321	0.001061	
3	Test# 2	0.01875	0.00725	5	0.086016	0.008064	
4	Test# 3	0.0113	0.026	7	0.125179	0.007073	
5	Test# 4	0.0022	0.0373	5	0.22949	0.002524	
6	Test# 5	0.0013	0.0395	7	0.085507	0.000556	
7	Test# 6	0.0002	0.0408	5	0.02844	0.000028	
8	Test# 7	0.0008	0.041	1	-0.00185	-7E-06	
9							
10	TotalDurat	5v total pwr					
11	0.04155	0.019299					
12							

图 13. Example of .csv Output File, plotset = 3

In the above example, the total mmWave sensor and low voltage energy is 19.3 mj, the cycle is 41.55 ms.

3.2.2.3 Range Measurements

Because the accuracy of the IWR1443's range measurement has been demonstrated elsewhere, the goal for this testing was not to repeat those tests but simply to show that the built-in chirp configuration is functioning correctly. Testing was performed in an anechoic chamber using a simple tape measure and a 3" corner reflector for the target.



图 14. Range Measurement Setup

4 Design Files

4.1 Schematics

To download the schematics, see the design files at [TIDEP-0091](#).

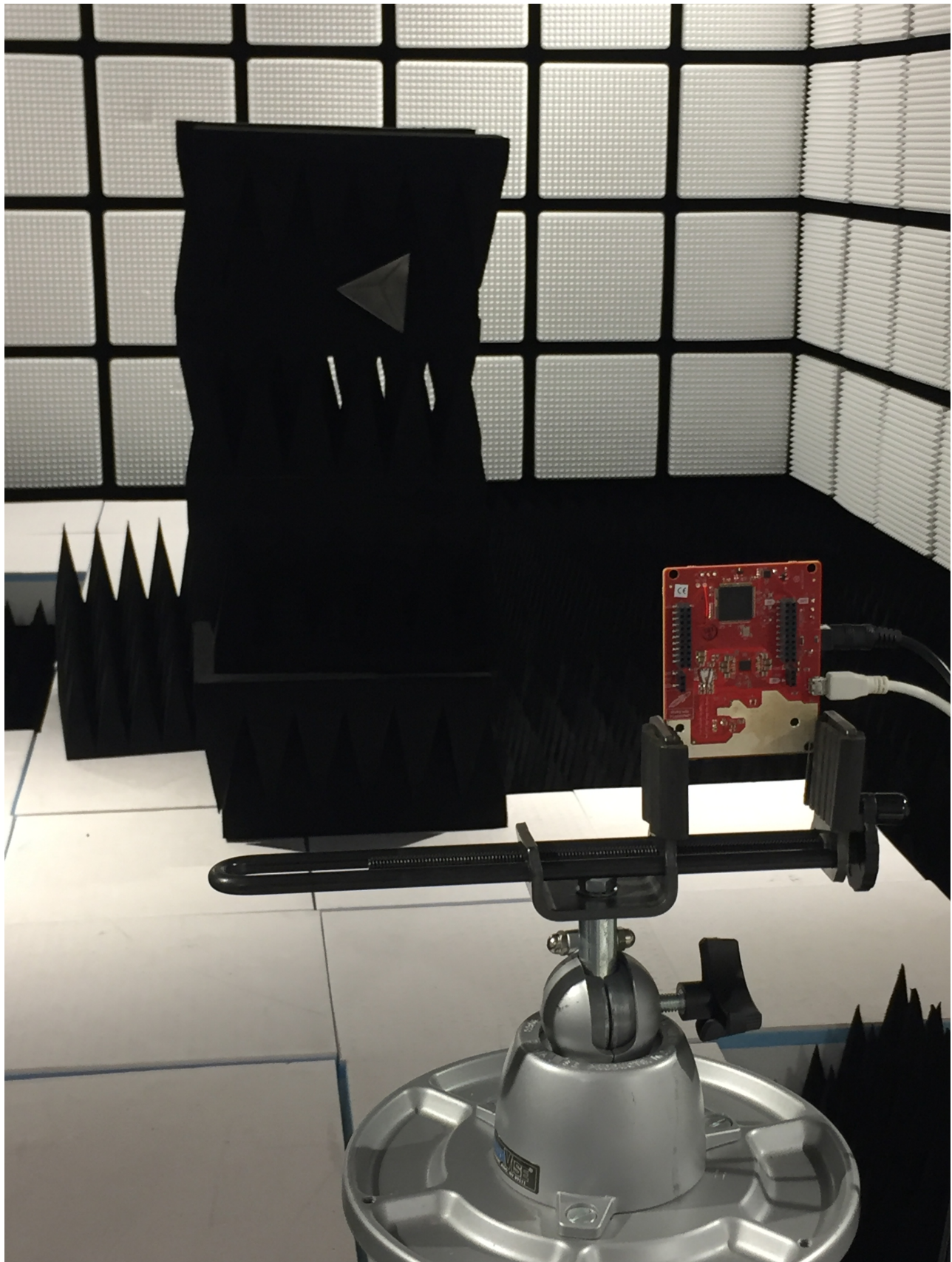
4.2 Bill of Materials

To download the bill of materials (BOM), see the design files at [TIDEP-0091](#).

4.3 Altium Project

To download the Altium project files, see the design files at [TIDEP-0091](#).

4.4 Gerber Files

To download the Gerber files, see the design files at [TIDEP-0091](#).

5 Software Files

To download the software files, see the design files at [TIDEP-0091](#).

6 Related Documentation

1. Texas Instruments, [IWR1443 Industrial Radar Family Technical Reference Manual](#), Technical Reference (SWRU520)
2. Texas Instruments, [MSP432P4xx Family Technical Reference Manual](#), Technical Reference (SLAU356)
3. Texas Instruments, [MSP432P401R SimpleLink Microcontroller LaunchPad Development Kit \(MSP-EXP432P401R\)](#), User's Guide (SLAU597)
4. Texas Instruments, [IWR1443 EVM](#), Tool Folder

6.1 商标

LaunchPad, MSPWare are trademarks of Texas Instruments.
LaunchPad, Code Composer Studio are trademarks of Texas Instruments, Inc..
ARM, Cortex are registered trademarks of Arm Limited.
All other trademarks are the property of their respective owners.

修订版本 B 历史记录

注：之前版本的页码可能与当前版本有所不同。

Changes from A Revision (January 2018) to B Revision	Page
• 更新了“说明”部分。	1
• Updated System Overview section.....	2
• Added Hardware Implementation section.	3
• Added MSP432 Host Controller to mmWave Industrial Sensor section.	4
• Added MSP432 BOOST EVM Description section.	6
• Added MSP432 Host Controller Software Overview section.	7
• Updated TIDEP-0091 MSP432 Host Processor Software Flow image.....	7
• Added mmWave Industrial Sensor IWR1443 Description section.	8
• Added mmWave Industrial Sensor Software section.	9
• Updated IWR1443 BOOST MSS/BSS Software Block Diagram image.....	9
• Added mmWave FMCW Configuration, RCS, Antenna Gain, and Configuration Spreadsheet section.....	11
• Added Low Voltage Power Supply Discussion IWR1443 BOOST EVM and Modifications section.	12
• Removed Block Diagram section.	13
• Removed Highlighted Products section.....	13
• Updated Hardware section.	14
• Updated Example of Demonstration Output image.....	17
• Updated Power Measurements section.....	18
• Updated Range Measurement Setup image.	22

重要声明和免责声明

TI 均以“原样”提供技术性 & 可靠性数据（包括数据表）、设计资源（包括参考设计）、应用或其他设计建议、网络工具、安全信息和其他资源，不保证其中不含任何瑕疵，且不做任何明示或暗示的担保，包括但不限于对适销性、适合某特定用途或不侵犯任何第三方知识产权的暗示担保。

所述资源可供专业开发人员应用 TI 产品进行设计使用。您将对以下行为独自承担全部责任：(1) 针对您的应用选择合适的 TI 产品；(2) 设计、验证并测试您的应用；(3) 确保您的应用满足相应标准以及任何其他安全、安保或其他要求。所述资源如有变更，恕不另行通知。TI 对您使用所述资源的授权仅限于开发资源所涉及 TI 产品的相关应用。除此之外不得复制或展示所述资源，也不提供其它 TI 或任何第三方的知识产权授权许可。如因使用所述资源而产生任何索赔、赔偿、成本、损失及债务等，TI 对此概不负责，并且您须赔偿由此对 TI 及其代表造成的损害。

TI 所提供产品均受 TI 的销售条款 (<http://www.ti.com.cn/zh-cn/legal/termsofsale.html>) 以及 [ti.com.cn](http://www.ti.com.cn) 上或随附 TI 产品提供的其他可适用条款的约束。TI 提供所述资源并不扩展或以其他方式更改 TI 针对 TI 产品所发布的可适用的担保范围或担保免责声明。

邮寄地址：上海市浦东新区世纪大道 1568 号中建大厦 32 楼，邮政编码：200122
Copyright © 2018 德州仪器半导体技术（上海）有限公司

重要声明和免责声明

TI 均以“原样”提供技术性 & 可靠性数据（包括数据表）、设计资源（包括参考设计）、应用或其他设计建议、网络工具、安全信息和其他资源，不保证其中不含任何瑕疵，且不做任何明示或暗示的担保，包括但不限于对适销性、适合某特定用途或不侵犯任何第三方知识产权的暗示担保。

所述资源可供专业开发人员应用 TI 产品进行设计使用。您将对以下行为独自承担全部责任：(1) 针对您的应用选择合适的 TI 产品；(2) 设计、验证并测试您的应用；(3) 确保您的应用满足相应标准以及任何其他安全、安保或其他要求。所述资源如有变更，恕不另行通知。TI 对您使用所述资源的授权仅限于开发资源所涉及 TI 产品的相关应用。除此之外不得复制或展示所述资源，也不提供其它 TI 或任何第三方的知识产权授权许可。如因使用所述资源而产生任何索赔、赔偿、成本、损失及债务等，TI 对此概不负责，并且您须赔偿由此对 TI 及其代表造成的损害。

TI 所提供产品均受 TI 的销售条款 (<http://www.ti.com.cn/zh-cn/legal/termsofsale.html>) 以及 [ti.com.cn](http://www.ti.com.cn) 上或随附 TI 产品提供的其他可适用条款的约束。TI 提供所述资源并不扩展或以其他方式更改 TI 针对 TI 产品所发布的可适用的担保范围或担保免责声明。

邮寄地址：上海市浦东新区世纪大道 1568 号中建大厦 32 楼，邮政编码：200122
Copyright © 2018 德州仪器半导体技术（上海）有限公司