

## **TLC59116FEVM-571**

This user's guide describes the characteristics, setup, and use of the TLC59116FEVM-571 evaluation module (EVM). This EVM helps the user evaluate the features of the Texas Instruments TLC59116F, which is an I<sup>2</sup>C™ bus-controlled, 16-channel LED driver. This user's guide includes setup instructions, a schematic diagram, a bill of materials, printed-circuit board layout drawings, and software instructions.

### **Contents**

1	Introduction .....	2
1.1	Requirements .....	2
2	Setup .....	3
2.1	Input / Output Connector Descriptions .....	3
2.2	Software Setup .....	4
2.3	Hardware Setup .....	5
3	Operation .....	5
3.1	Operation .....	5
4	Schematics, Board Layouts, and Bills of Materials .....	10
4.1	Schematics .....	10
4.2	Layouts .....	13
4.3	Bills of Materials .....	21
5	Related Documentation From Texas Instruments .....	21

### **List of Figures**

1	Driver Board and LED Board Connections .....	3
2	TLC59116 EVM Software Start-up Screen .....	6
3	TLC59116FEVM-571 Schematic .....	11
4	RGBLEDEVM-249 Schematic .....	12
5	TLC59116FEVM-571 Assembly Layer Routing .....	13
6	TLC59116FEVM-571 Top Layer Routing .....	14
7	TLC59116FEVM-571 Layer 2 Routing .....	15
8	TLC59116FEVM-571 Layer 3 Routing .....	16
9	TLC59116FEVM-571 Bottom Layer Routing .....	17
10	RGBLEDEVM-249 Assembly Layer Routing .....	18
11	RGBLEDEVM-249 Top Layer Routing .....	19
12	RGBLEDEVM-249 Bottom Layer Routing.....	20

### **List of Tables**

1	HPA571 Bill of Materials.....	21
2	HPA249A Bill of Materials .....	21

## 1 Introduction

The TLC59116F is an I<sup>2</sup>C bus-controlled, 16-channel LED driver that is optimized for red/green/blue/amber (RGBA) color mixing and backlight application for amusement products. Each LED output has its own 8-bit resolution (256 steps), fixed-frequency, individual PWM controller that operates at 97 kHz, with a duty cycle that is adjustable from 0% to 99.6%. The individual PWM controller allows each LED to be set to a specific brightness value. An additional 8-bit resolution (256 steps) group PWM controller has both a fixed frequency of 190 Hz and an adjustable frequency between 24 Hz to once every 10.73 seconds, with a duty cycle that is adjustable from 0% to 99.6%. The group PWM controller dims or blinks all LEDs with the same value.

### 1.1 Requirements

In order to operate this EVM, the following components must be connected and properly configured. All components, software, and connectors are supplied in the EVM except for the host computer and the dc power supply.

#### 1.1.1 Software

Texas Instruments has provided a compact disc in the EVM kit that contains the software necessary to evaluate the TLC59116FEVM. Check the TLC59116F product folder on the Texas Instruments Web site ([www.ti.com](http://www.ti.com)) for updates to the software.

#### 1.1.2 Host Computer

A personal computer (PC) with a USB port is required to operate this EVM. The TLC59116F software runs on the PC and communicates with the EVM via the USB port on the PC.

Personal Computer Requirements

- Windows™ 2000 or Windows XP operating system
- USB port
- Minimum of 30 MB of free hard disk space (100 MB recommended)
- Minimum of 256 MB of RAM

#### 1.1.3 Power Supply Requirements

A dc power supply capable of delivering 5 V at 1.5 A is required to power the EVM.

#### 1.1.4 Printed-Circuit Board Assemblies

The TLC59116FEVM-571 kit contains two printed-circuit boards (PCB): HPA571 (driver board) and HPA249 (LED board). The driver board contains the TLC59116F integrated circuits (IC) and their required external components. This board contains several jumpers and connectors that enable customization of the board for specific operating conditions. The LED board contains 16 LEDs, each with three individual LEDs in the same package: a red, a green, and a blue LED. The orderable Texas Instruments part number for this PCB is RGBLEDEVM-249. The EVM is designed to drive the LED board directly. The customer can also remove the LED board to drive a custom LED board. Figure 1 shows how these boards are connected.

Windows, Internet Explorer are trademarks of Microsoft Corporation.

I<sup>2</sup>C is a trademark of NXP B.V.

Verisign is a trademark of Verisign, Inc.

All other trademarks are the property of their respective owners.

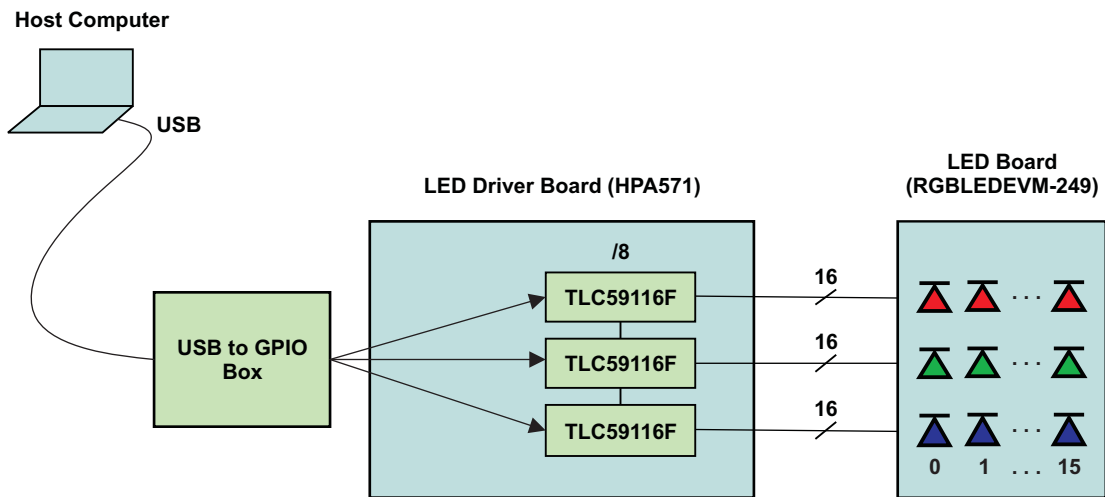

Each LED output has its own 8-bit resolution (256 steps) fixed-frequency individual PWM controller that operates at 97 kHz, with a duty cycle that is adjustable from 0% to 99.6%.

**Figure 1. Driver Board and LED Board Connections**

The user's computer connects to the LED driver board with a USB cable and communicates through an I<sup>2</sup>C bus via the USB to GPIO box. The TLC59116F ICs exchange data with the host computer through the USB and drive the LED board accordingly.

## 2 Setup

This section describes the jumpers and connectors on the EVM as well as how to properly connect, set up, and use the TLC59116FEVM-571.

### 2.1 Input / Output Connector Descriptions

#### 2.1.1 J1 – USB to GPIO Box

This box connects the EVM to the USB port of the host PC through an I<sup>2</sup>C Bus.

#### 2.1.2 J2 – LED Connector

This connector mates to the HPA249 LED board. The user can also connect a custom board to this connector with a standard 30-pin ribbon cable with 0.1-inch pin-to-pin spacing. In order to minimize stray inductance and ringing on the output traces, connections to this connector must be as short as possible.

#### 2.1.3 J3 – LED Connector

This connector mates to the HPA249 LED board. The user can also connect a custom board to this connector with a standard 30-pin ribbon cable with 0.1-inch pin-to-pin spacing. In order to minimize stray inductance and ringing on the output traces, connections to this connector must be as short as possible.

#### 2.1.4 J5 – V<sub>IN</sub>

This is the positive input supply to the EVM. Connect the dc power supply to this end. To minimize power dissipation, the input voltage must be as low as possible. The leads to the input supply must be twisted and kept as short as possible to minimize EMI transmission.

#### 2.1.5 J6 – GND Connector

This is the return for the input supply to the EVM. The leads to the input supply must be twisted and kept as short as possible to minimize EMI transmission.

### 2.1.6 J4 – Input Power Connector

This is a right-angle miniature power jack with a 3.5-mm-diameter connection. The user uses this connector to supply input power to the EVM from an ac-to-dc power adapter. The outer pin on the connector is connected directly to J8 (GND). The input voltage must be at 5 V, otherwise the variation in input voltage results in LED current and brightness being changed.

### 2.1.7 JP1 – Red LED

This jumper must be shorted to connect the OUT15 pin of the red LED driver to the red LED. This jumper can be opened to measure the current flowing into the OUT15 pin from the red LED.

The current through the red LED is set to approximately 20 mA by choosing an appropriate resistor value using the following equation:

$$I_{\text{RED\_LED}} = (V_{\text{IN}} - V_{\text{LED}} - V_{\text{O}})/R$$

For this EVM,

$$I_{\text{RED\_LED}} = (5 - 1.81 - 0.08)/158 \approx 20 \text{ mA}$$

$V_{\text{IN}}$  = Input voltage

$V_{\text{LED}}$  = Average voltage drop across the red LEDs

$V_{\text{O}}$  = Output voltage at device pin

Current-limiting resistor  $R = 158 \Omega$

### 2.1.8 JP2 – Green LED

This jumper must be shorted to connect the OUT15 pin of the green LED driver to the green LED. This jumper can be opened to measure the current flowing into the OUT15 pin from the green LED.

The current through the Green LED is set to approximately 20 mA by choosing an appropriate resistor value using the following equation:

$$I_{\text{GREEN\_LED}} = (V_{\text{IN}} - V_{\text{LED}} - V_{\text{O}})/R$$

For this EVM,

$$I_{\text{GREEN\_LED}} = (5 - 3.4 - 0.07)/76.8 \approx 20 \text{ mA}$$

$V_{\text{IN}}$  = Input voltage

$V_{\text{LED}}$  = Average voltage drop across the green LEDs

$V_{\text{O}}$  = Output voltage at device pin

Current-limiting resistor  $R = 76.8 \Omega$

### 2.1.9 JP3 – Blue LED

This jumper must be shorted to connect the OUT15 pin of the blue LED driver to the blue LED. This jumper can be opened to measure the current flowing into the OUT15 pin from the blue LED.

The current through the blue LED is set to approximately 20 mA by choosing an appropriate resistor value using the following equation:

$$I_{\text{BLUE\_LED}} = (V_{\text{IN}} - V_{\text{LED}} - V_{\text{O}})/R$$

For this EVM,

$$I_{\text{BLUE\_LED}} = (5 - 3.47 - 0.07)/73.2 \approx 20 \text{ mA}$$

$V_{\text{IN}}$  = Input voltage

$V_{\text{LED}}$  = Average voltage drop across the blue LEDs

$V_{\text{O}}$  = Output voltage at device pin

Current-limiting resistor  $R = 73.2 \Omega$

## 2.2 Software Setup

If installing from a compact disc (CD), insert the CD and run Setup.exe, following all the prompts to install the software.

If installing from the World Wide Web, go to the URL [www.ti.com](http://www.ti.com).

---

**NOTE:** This installation page is best viewed with Microsoft Internet Explorer™ browser. (It may not work correctly with other browsers.)

---

When clicking on the install button, the PC gives a security warning and asks if want to installation of this application is desired. Select Install to proceed.

With both types of installation, the software attempt to install the Microsoft .Net Framework 2.0 (if it is not already installed). This framework is required for the software to run.

After installation, the software runs automatically.

During future use of the software, it may prompt for installation of a new version if it becomes available on the [TI Web site](#).

---

**NOTE:** Verisign™ code signing is used to prevent any malicious code from changing this application. If at any time in the future the binaries are modified, the code will no longer attempt to run.

---

## 2.3 Hardware Setup

Install one shorting jumper each across JP1, JP2, and JP3. Connect the LED board (HPA249) to the LED driver board (HPA571).

Connect the LED driver board to the host computer using the USB interface adapter.

Using either the J5 and J6 input power connectors or the J4 power jack connector, connect an input voltage to the TLC59116FEVM board. The TLC59116F uses an input voltage between 5 V and 17 V. Set the input supply current limit to 1.5 A. If using a laboratory supply, use at least 18 AWG twisted wire. Note that some ac/dc power adapters do not provide clean power. Ensure that the input voltage is well regulated to avoid intermittent communication problems. Note that when using  $V_{IN}$  greater than 5 V, current through the LEDs changes.

### CAUTION

Hot-plugging the input supply with long leads can generate transients on the input supply bus that exceed the maximum ratings of the EVM. The input supply must be connected before it is turned on.

Turn on the input supply voltage.

## 3 Operation

This section provides instructions on how to turn on the TLC59116FEVM and operate the software.

### 3.1 Operation

The user can now run the GUI software on the host computer to change the LED programming with the easy-to-use graphical interface.

#### 3.1.1 Running the Software

This EVM uses the same software as the TLC59116-390 EVM.

Click on the *TLC59116 EVM software* icon on the host computer to start the software. If the host computer shows no icon, then use the **start** button in the lower left corner of the screen to browse the program folders to find the software. The default directory for software installation is *Program Files, Texas Instruments TLC59116F EVM Software*. The executable file name is *TLC59116F EVM Software.exe*.

Once started, the software checks the firmware in the DSP board to ensure that it is compatible with the software. If the firmware is incompatible, the software gives the user instructions on how to reprogram it. Once the software is started and communication is established between the GUI and the EVM, the user can use the graphical interface to program the LEDs. If the EVM is properly connected, the software screen looks like [Figure 2](#) when first opened.

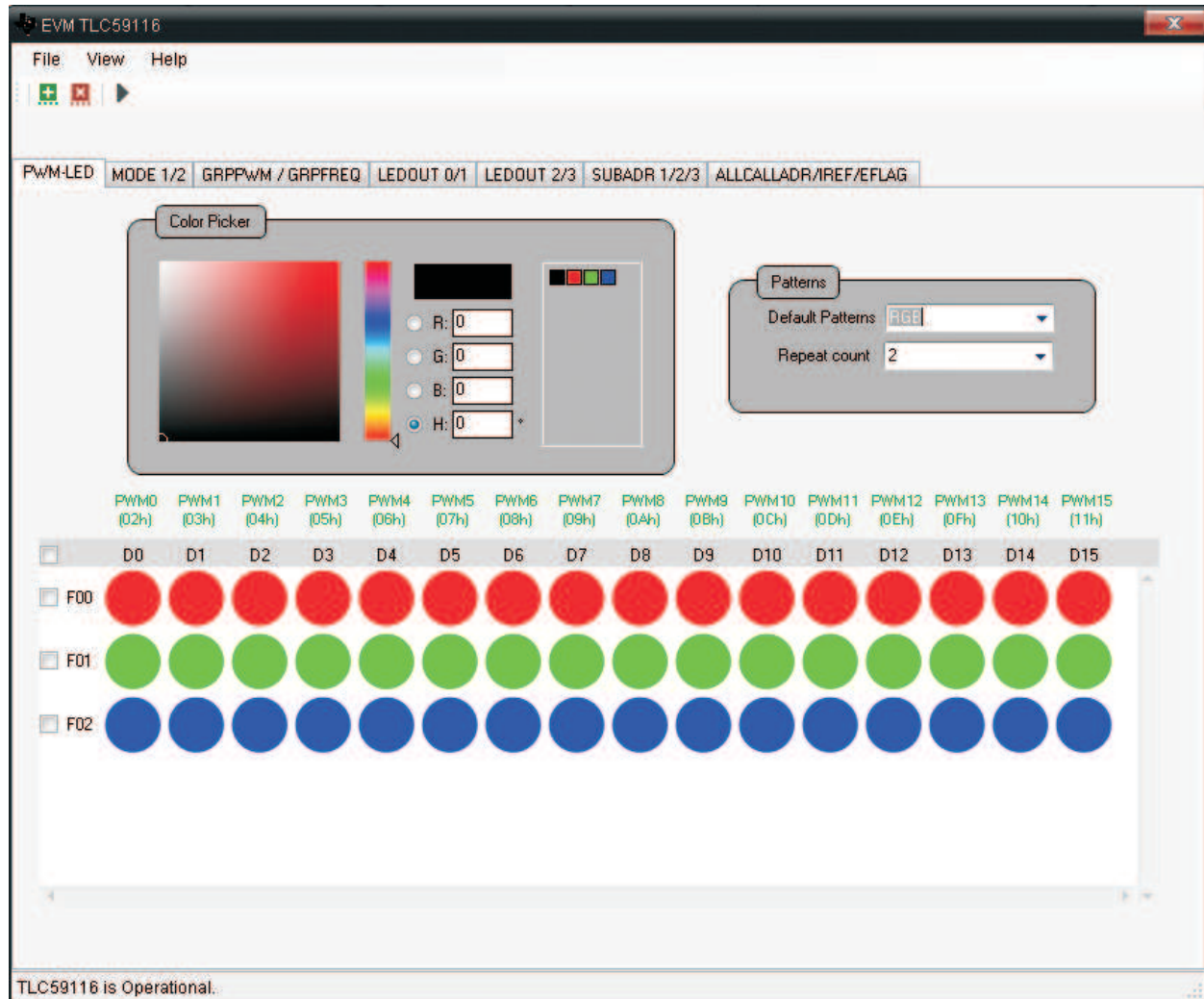
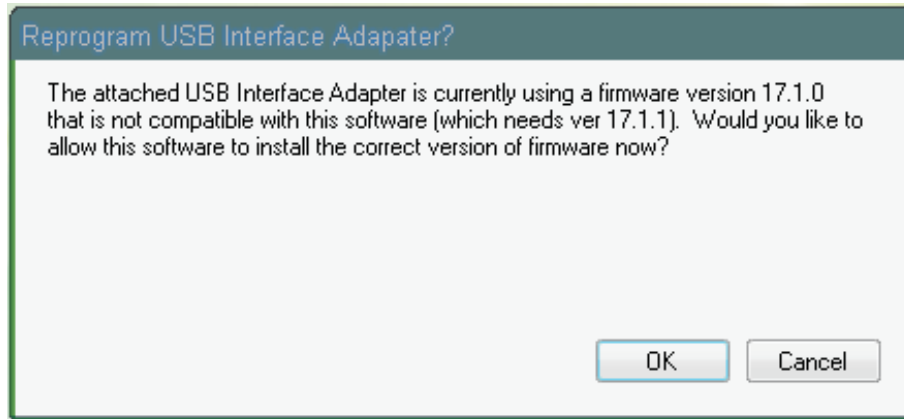

Figure 2. TLC59116 EVM Software Start-up Screen

### 3.1.2 Firmware Installation

If using the GPIO box for the first time with the computer, a window pops up asking for the installation of the correct version of the firmware. The pop up window appears as follows:



Click on OK button so that the correct firmware version is installed for the GPIO box. After clicking OK, another window pops up which appears as follows:

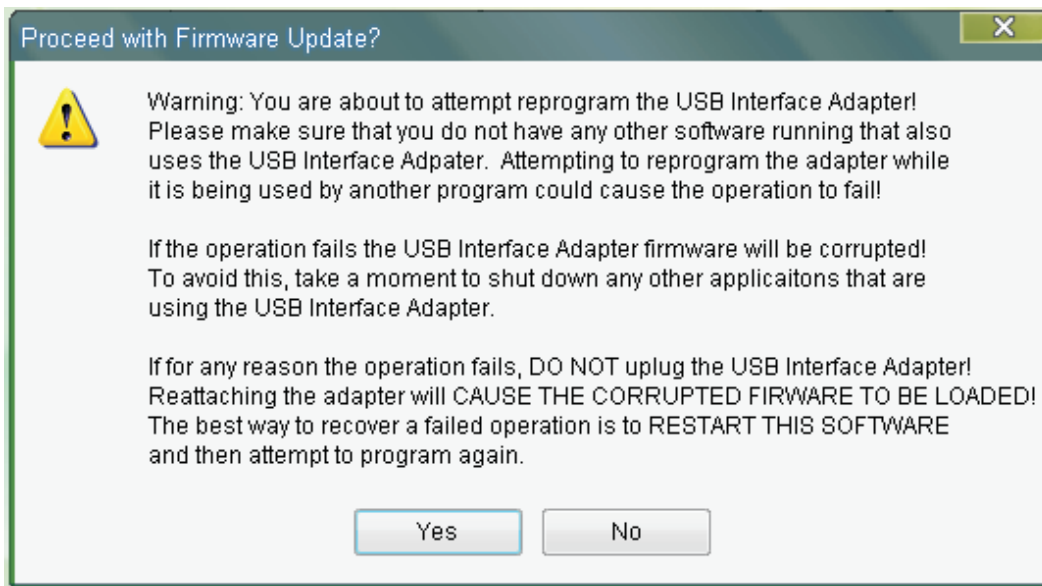

Click on **Yes**. The firmware is installed, and the following window appears.

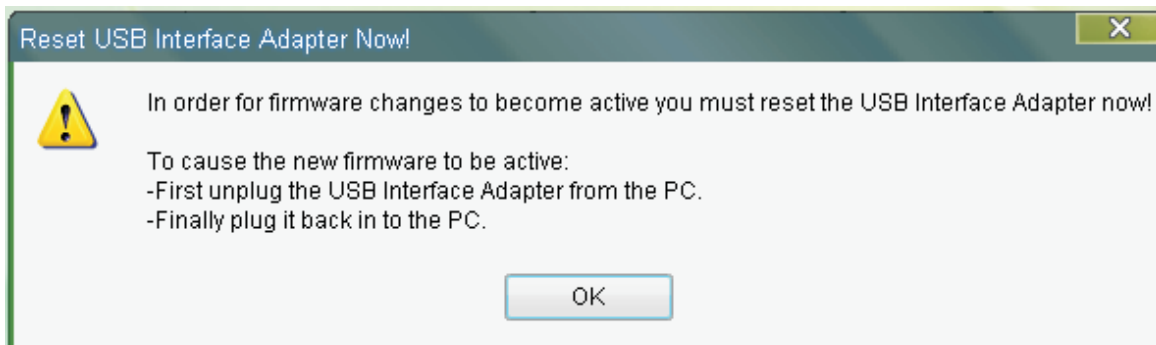

Click on **OK**. Now unplug the USB cable from the computer, and plug it again. Also, close the software and start it again. The software is NOW ready. Note that these steps are necessary to be followed only once for a particular firmware. These windows do not pop up each time the software is used with a GPIO box with a particular firmware.

### **3.1.3 Software Features**

#### **3.1.3.1 Patterns**

This window provides the user with several preprogrammed LED frame patterns. Choosing a pattern immediately programs the LED Frames window with the pattern and then displays the pattern with the LEDs.

#### **3.1.3.2 Color Picker**

This window allows the user to choose the red, green, and blue PWM value for each LED. The software provides three options for choosing the color for an LED. The user can manually enter the PWM values into the three text boxes, use the mouse to pick colors from the color bars, or use the mouse to click on a color from the custom color pallet. The color chosen in the Color Picker window is immediately displayed in the LEDs that are highlighted in the LED Frames window. The user can add custom colors to the pallet by dragging the current color to the custom color pallet. Custom colors can be deleted by right-clicking on the color to be removed.

#### **3.1.3.3 LED Frames**

This window shows the individual frames that are displayed by the LEDs. Changes to the current color in the Color Picker automatically update the selected LEDs or frames in the LED Frames window. Changes in the LED Frame are immediately written to the EVM and displayed by the LEDs. The check boxes allow easy selection of an entire frame or all frames. The user can select a single LED or select multiple LEDs by holding the <shift> or <ctrl> buttons on the host computer keyboard while clicking on the LEDs. The Repeat box in the right side of the LED Frames window tells the EVM how many times to display that frame before moving to the next frame. Note that due to manufacturing tolerances in LED brightness and color, the LED colors displayed in this window are only approximate to the actual LED color on the EVM.

#### **3.1.3.4 File – Save and Load**

This tab allows the user to save and load custom frames. The file also saves all user-selectable settings such as operating frequency and Global Brightness settings.

#### **3.1.3.5 View – LED Display Mode**

When Solid display mode is chosen, the pixel in the LED Frames window shows the LED pixels and their approximate color on the EVM. This color is generated by the mixing of the three individual LED colors. When RGB display mode is chosen, the pixel shows the relative intensity of each individual LED that makes up each pixel.

#### **3.1.3.6 Information Bar – EVM Status**

The information bar displays whether or not the GUI detects the EVM hardware.

#### **3.1.3.7 Other Tabs**

In addition to the options previously described, additional tabs as shown in the following figure, provide the user with full control of all the TLC59116F internal registers. These tabs provide the user with full control of all the TLC59116F internal registers. The tab names correspond to the register names as defined in the data sheet.



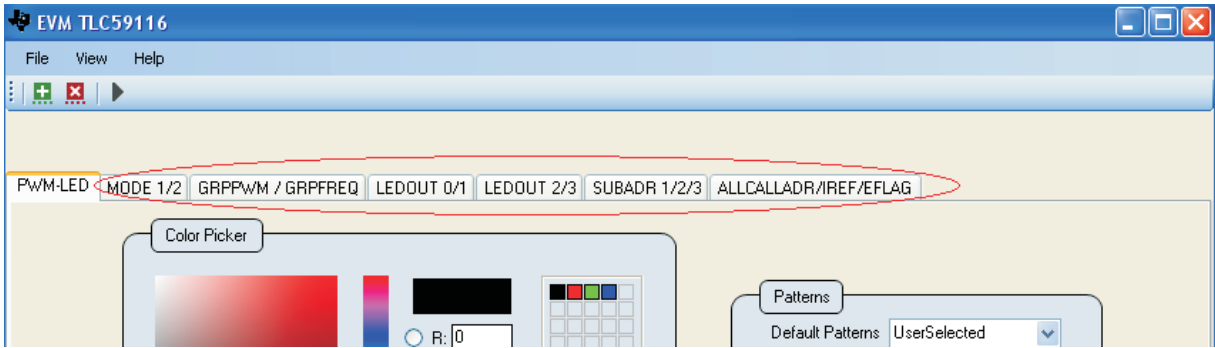

Each tab contains a register as shown in the following illustration.



The 8 bits can be set or reset manually by clicking on them, and then clicking on the write button to the left of these bits. To determine the current status of a register, click the leftmost read button, and the register shows its current status.

In some particular registers, some predefined settings are indicated below the registers. An explanation of these particular cases follows.

#### Particular Cases:

1. **Mode1/2:** In this tab, in addition to the manual control of the registers, users can directly control the registers for some predefined tasks like:
  - (a) Response to I<sup>2</sup>C bus address
  - (b) Normal/Low Power mode
  - (c) Enable/Clear status flag
  - (d) Dimming/Blinking
  - (e) Outputs change

All these conditions are clearly indicated below the registers.

2. **GRPPWM/GRPFREQ:** The Group PWM duty cycle and the Group PWM frequency can be directly set by using the seek button shown above the respective register. The seek button appears as follows:

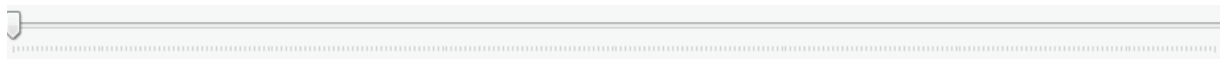

3. **LEDOUT0/1/2/3:** These two tabs allow directly setting the individual bits from the registers and provide the following four options:
  - (a) Default Power State
  - (b) Brightness and Dimming not controlled
  - (c) Brightness controlled by using PWM
  - (d) Brightness and Dimming controlled

When a user selects any of these conditions, the register bits are arranged for the selected particular condition.

4. **IREF:** In the IREF register, the current multiplier and the HC can be set directly to either high or low, using the button below IREF registers.

All the preceding settings are to be done separately for the red part, the green part, and the blue part. Each part can be selected from its corresponding drop-down box at the very top of the window.

## 4 Schematics, Board Layouts, and Bills of Materials

This section provides the TLC59116FEVM-571 and RGBLEDEVM-249 schematic and board layout illustrations, and the bills of materials.

### 4.1 Schematics

The schematic for TLC59116FEVM-571 appears as [Figure 3](#).

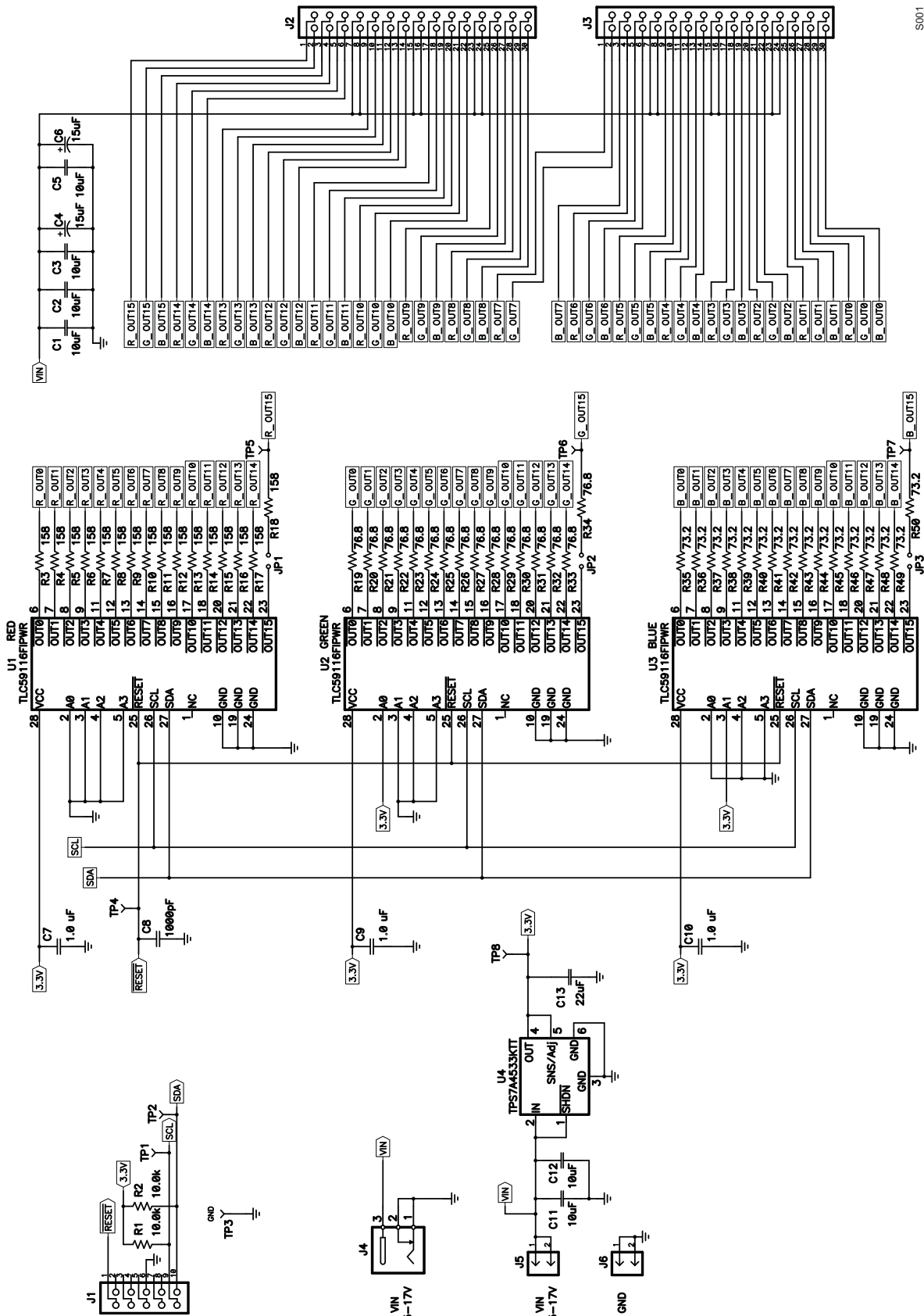

5001

Figure 3. TLC59116FEVM-571 Schematic

The schematic for RGBLEDEM-249 appears as Figure 4 .

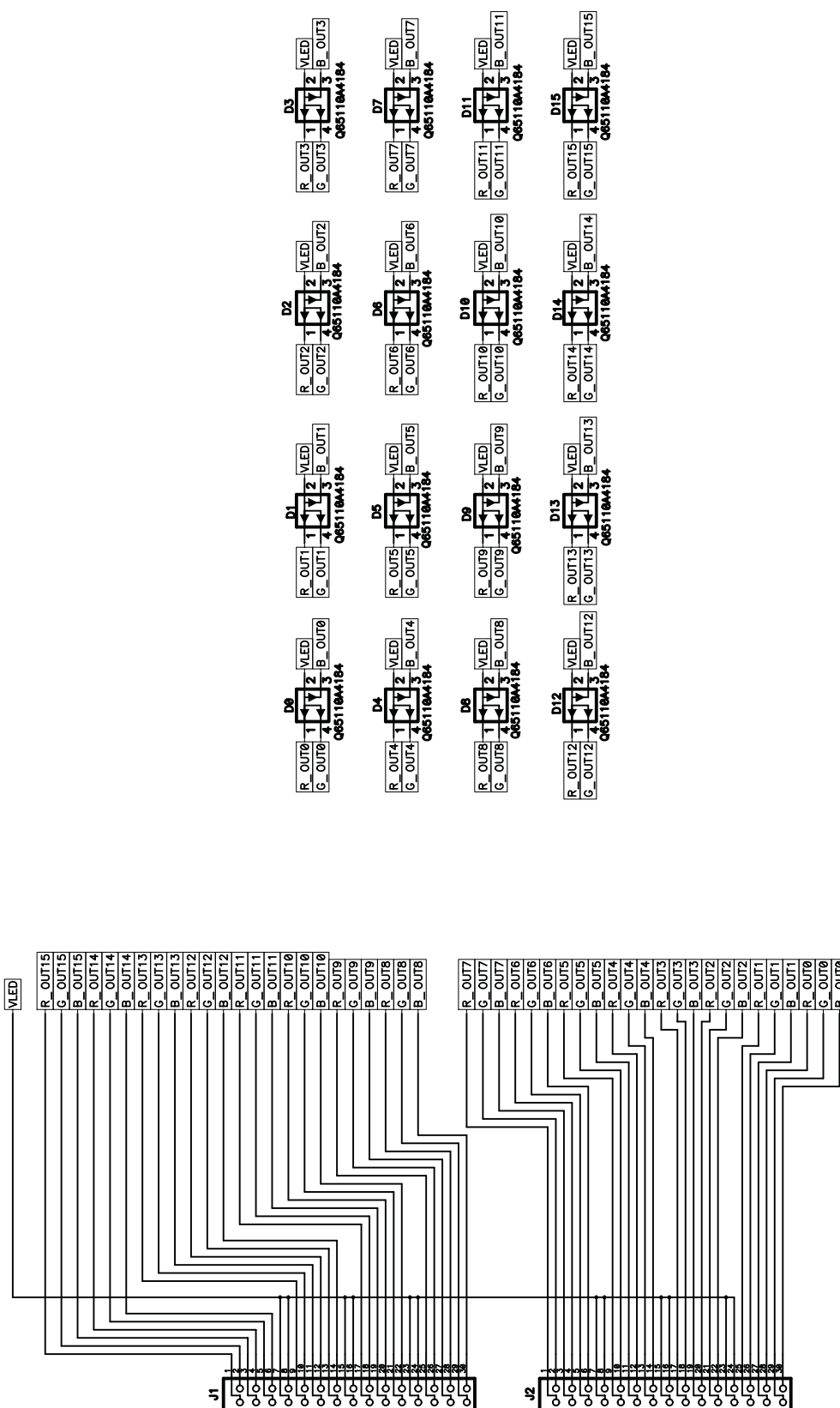
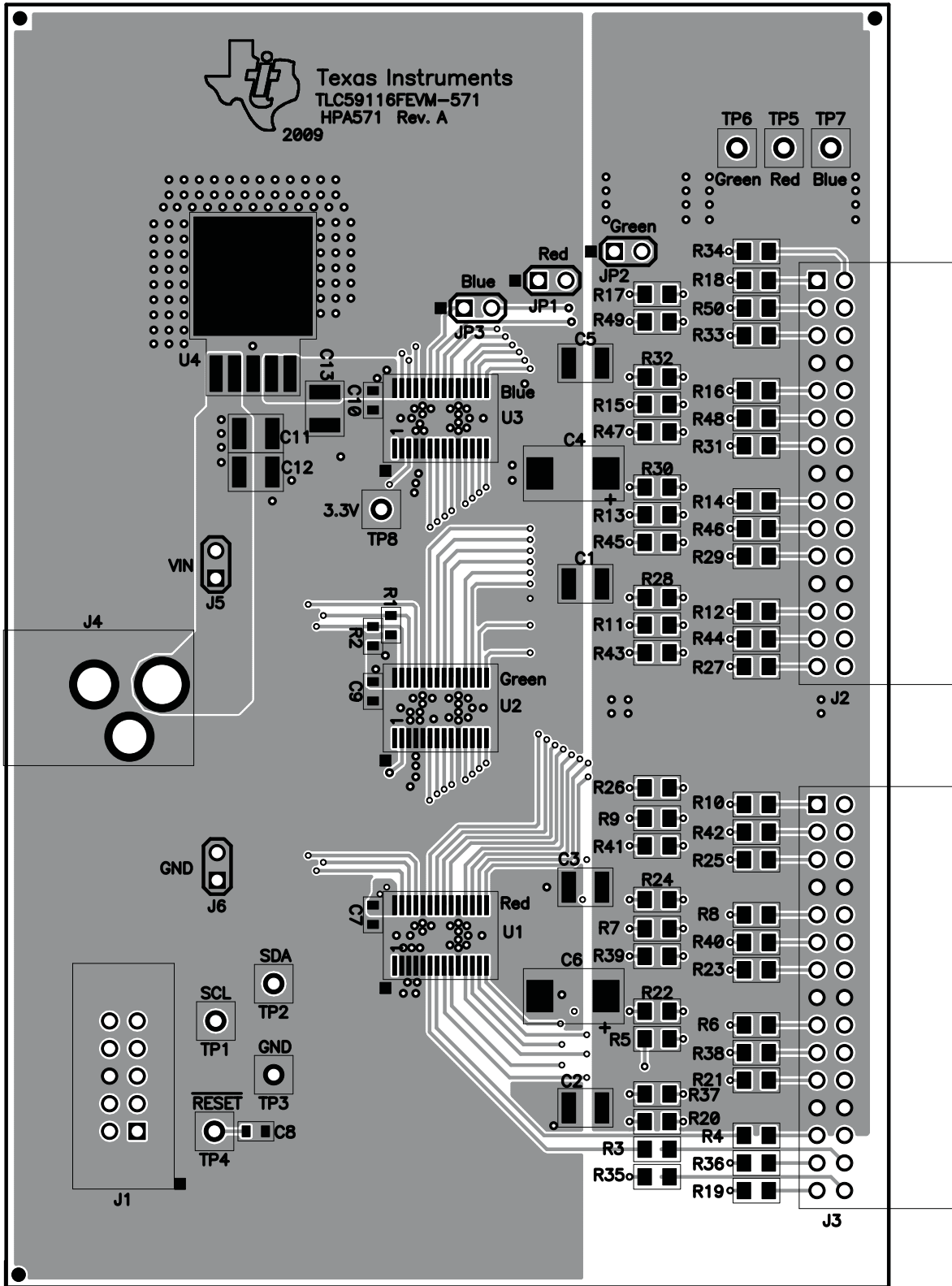

Figure 4. RGBLEDEM-249 Schematic

## 4.2 Layouts

Figure 5 through Figure 9 show the board layout for the TLC59116FEVM-571.



K001

Figure 5. TLC59116FEVM-571 Assembly Layer Routing

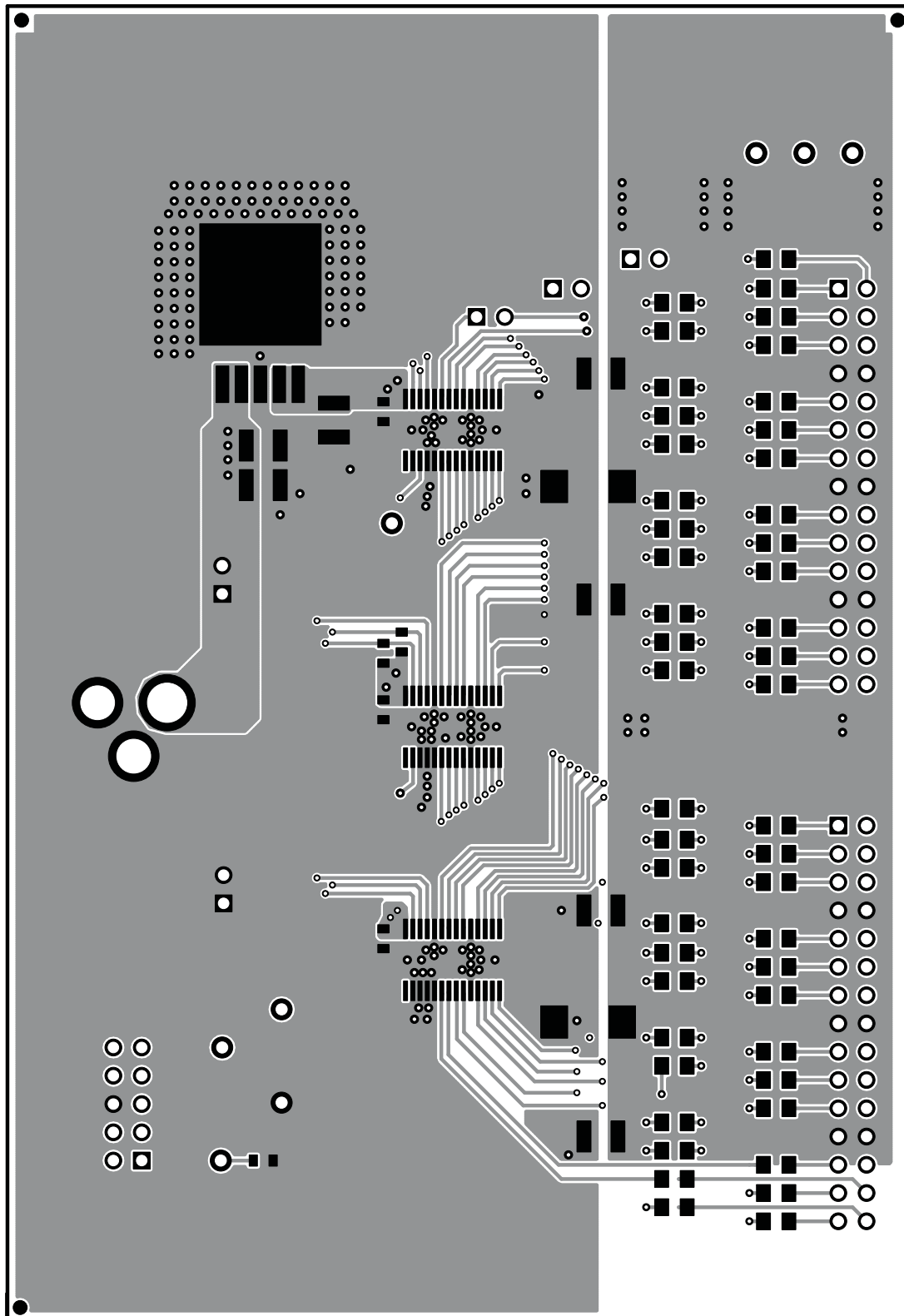

K002

Figure 6. TLC59116FEVM-571 Top Layer Routing

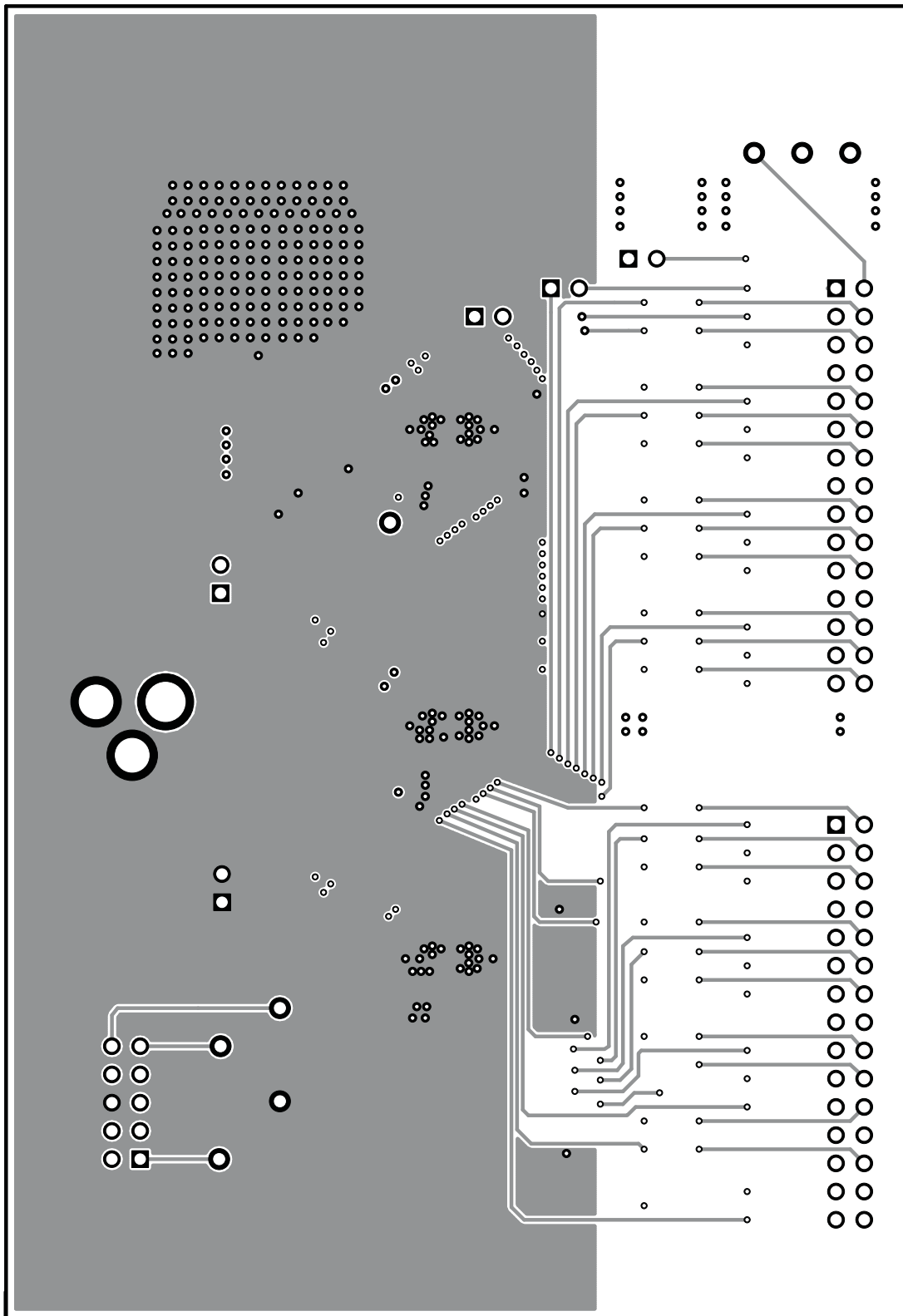

K003

Figure 7. TLC59116FEVM-571 Layer 2 Routing

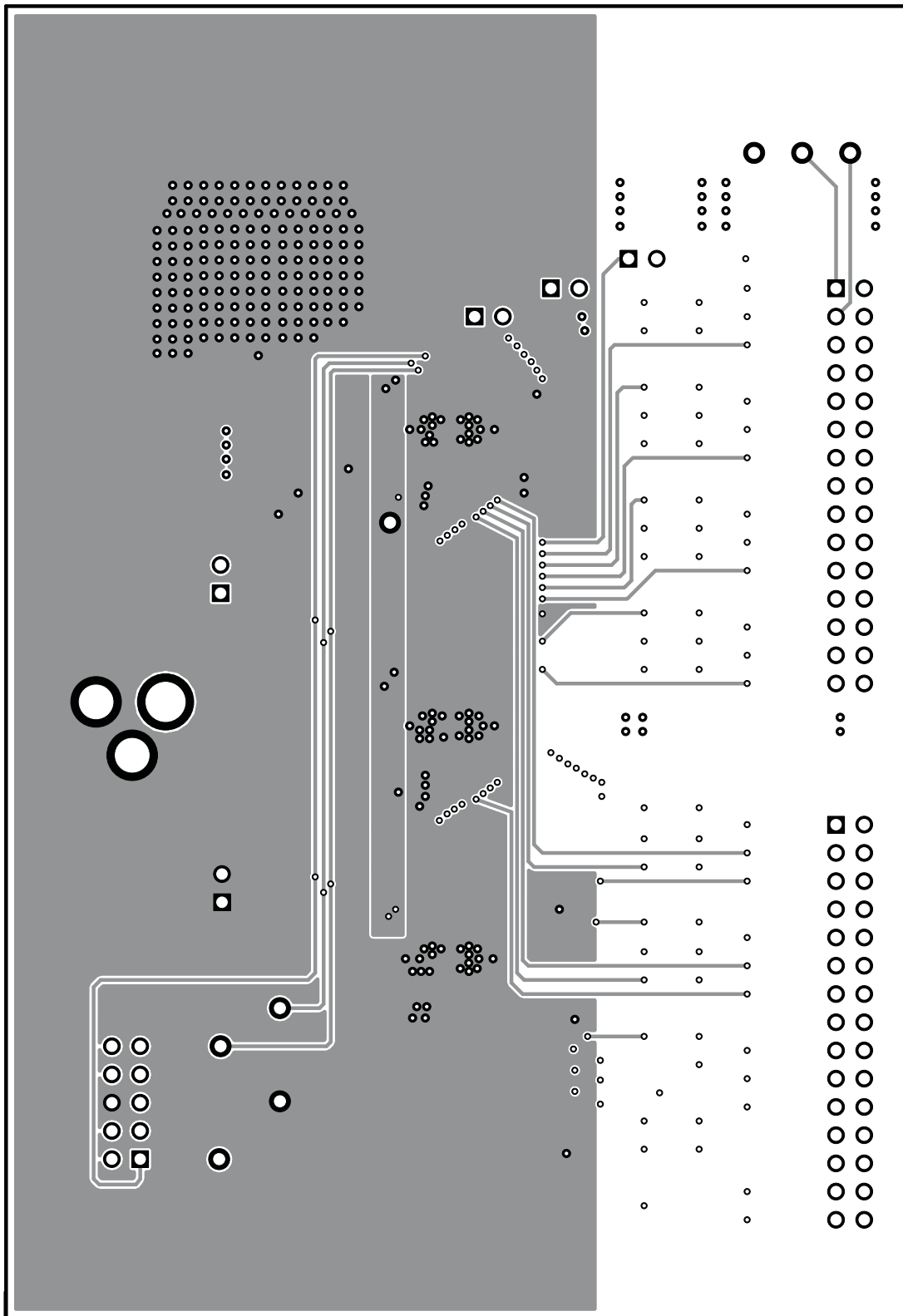

K004

Figure 8. TLC59116FEVM-571 Layer 3 Routing



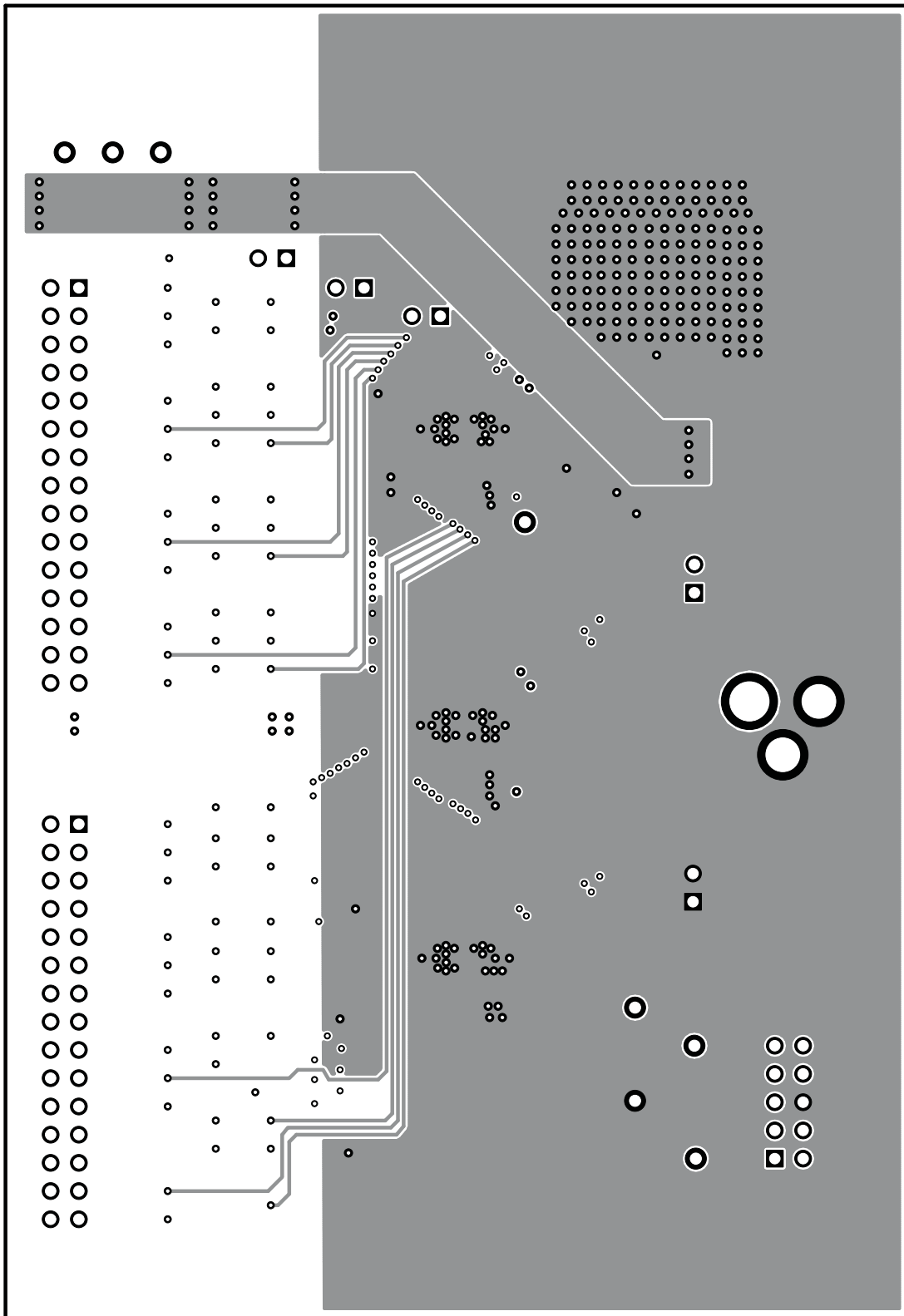

K005

Figure 9. TLC59116FEVM-571 Bottom Layer Routing

Figure 10 through Figure 12 show the board layout for the LED board, RGBLEDEVM-249.

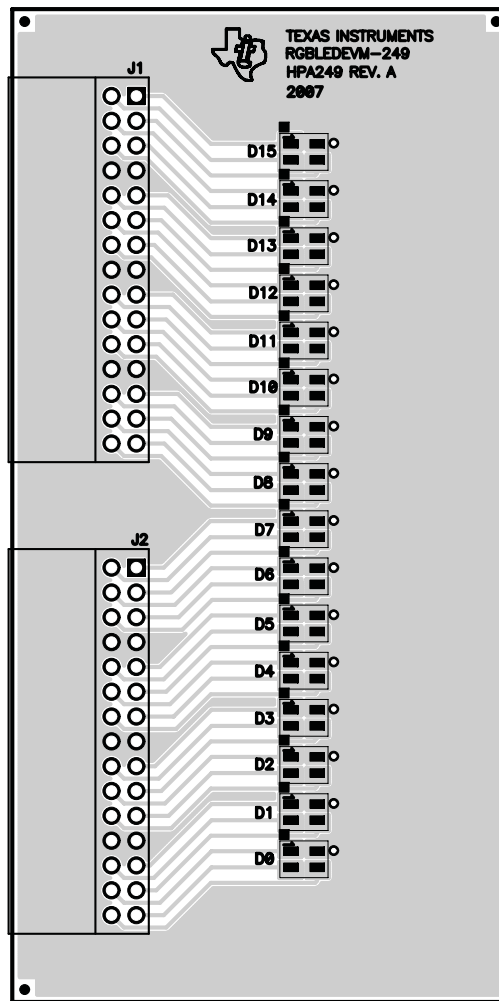

Figure 10. RGBLEDEVM-249 Assembly Layer Routing

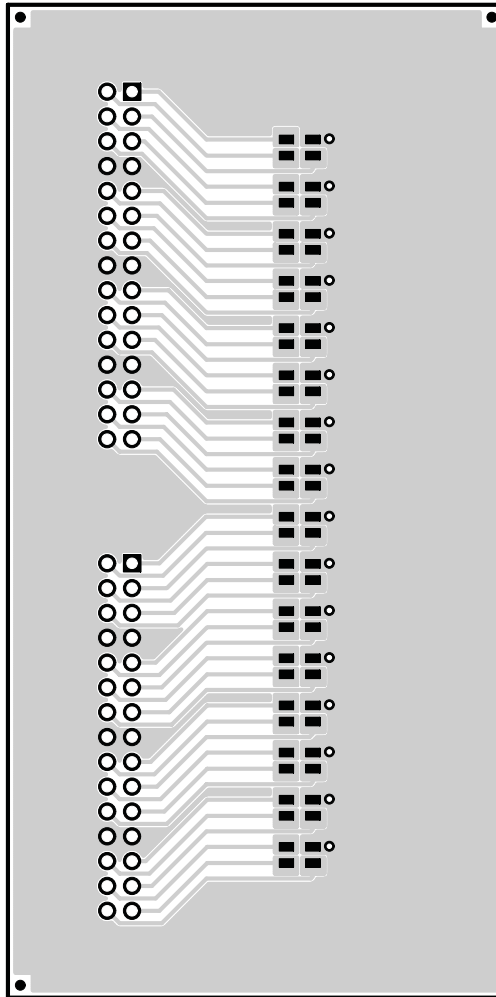

Figure 11. RGBLEDEVM-249 Top Layer Routing

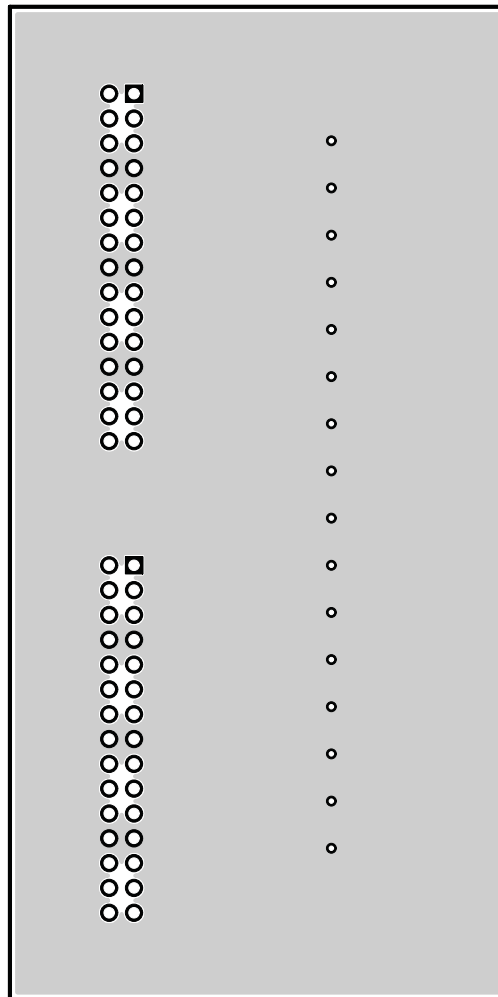

Figure 12. RGBLEDEVM-249 Bottom Layer Routing

### 4.3 Bills of Materials

**Table 1. HPA571 Bill of Materials**

Count	RefDes	Value	Description	Size	Part Number	MFR
6	C1, C2, C3, C5, C11, C12	10 $\mu$ F	Capacitor, ceramic, 25-V, X5R, 10%	1210	Std	Std
2	C4, C6	15 $\mu$ F	Capacitor, POSCAP, 25-V, 90-m $\Omega$ , 20%	7343(D)	25TQC15MV	Sanyo
3	C7, C9, C10	1.0 $\mu$ F	Capacitor, ceramic, 6.3-V, X5R, 10%	0603	Std	Std
1	C8	1000 pF	Capacitor, ceramic, 6.3-V, X5R, 10%	0603	Std	Std
1	C13	22 $\mu$ F	Capacitor, ceramic, 25-V, X5R, 10%	1206	Std	Std
1	J1	N2510-6002RB	Connector, male straight 2x5 pin, 100-mil (2,54-mm) spacing, 4 wall	0.338 in. x 0.788 in. (8,59 mm x 20 mm)	N2510-6002RB	3M
2	J2, J3	PEC15DBAN	Header, male 2x15-pin, 100-mil (2,54-mm) spacing, right-angle	0.100 in. (2,54-mm) x 15 x 2	PEC15DBAN	Sullins
1	J4	RAPC712X	Connector, pin dia. 2.5 mm, dc jack	0.57 in. x 0.35 in. (14,5 mm x 8,9 mm)	RAPC712X	Switchcraft
2	J5, J6	PEC02SAAN	Header, 2-pin, 100-mil (2,54-mm) spacing	0.100 in. (2,54-mm) x 2	PEC02SAAN	Sullins
3	JP1, JP2, JP3	PEC02SAAN	Header, 2-pin, 100-mil (2,54-mm) spacing	0.100 in. (2,54-mm) x 2	PEC02SAAN	Sullins
2	R1, R2	10.0 k $\Omega$	Resistor, chip, 1/16W, 1%	0603	Std	Std
16	R3–R18	158 $\Omega$	Resistor, chip, 1/10W, 1%	0805	Std	Std
16	R19–R34	76.8 $\Omega$	Resistor, chip, 1/10W, 1%	0805	Std	Std
16	R35–R50	73.2 $\Omega$	Resistor, chip, 1/10W, 1%	0805	Std	Std
7	TP1, TP2, TP4–TP8	5000	Test point, red, thru hole color keyed	0.100 in. x 0.100 in. (2,54-mm x 2,54-mm)	5000	Keystone
1	TP3	5001	Test point, black, thru hole color keyed	0.100 in. x 0.100 in. (2,54-mm x 2,54-mm)	5001	Keystone
3	U1, U2, U3	TLC59116FIPWR	IC, 16-chan fast-mode plus I <sup>2</sup> C bus LED driver	TSSOP-28	TLC59116FIPWR	TI
1	U4	TPS7A4533KTT	IC, low-noise fast-transient-response 1.5-A LDO voltage reg.	TO-263-5	TPS7A4533KTT	TI
3	—	—	Shunt, 100-mil (2,54-mm), black	0.100 in. (2,54-mm)	929950-00	3M
1	—	—	PCB, 4.65 in. x 3.2 in. x 0.062 in. (11,81 cm x 8,13 cm x 1,57 mm)	—	HPA571	Any

**Table 2. HPA249A Bill of Materials**

Count	RefDes	Value	Description	Size	Part Number	MFR
16	D0–D15	Q65110A4184	Diode, LED, 20-mA, common anode (LATBT66B)	0.118 x 0.134	Q65110A4184	Osram
2	J1, J2	PPTC152LJBN-RC	Header, female, 2x5-pin, .100 in. (2,54 mm), RA	0.500 in. x 1.520 in. (12,7 mm x 38,6 mm)	PPTC152LJBN-RC	Sullins

## 5 Related Documentation From Texas Instruments

- *TLC59116F, 16-Channel Fm+ I<sup>2</sup>C-Bus Constant-Current LED Sink Driver* data sheet ([SCLS714](#))
- TLC59116 Software

## EVALUATION BOARD/KIT IMPORTANT NOTICE

Texas Instruments (TI) provides the enclosed product(s) under the following conditions:

This evaluation board/kit is intended for use for **ENGINEERING DEVELOPMENT, DEMONSTRATION, OR EVALUATION PURPOSES ONLY** and is not considered by TI to be a finished end-product fit for general consumer use. Persons handling the product(s) must have electronics training and observe good engineering practice standards. As such, the goods being provided are not intended to be complete in terms of required design-, marketing-, and/or manufacturing-related protective considerations, including product safety and environmental measures typically found in end products that incorporate such semiconductor components or circuit boards. This evaluation board/kit does not fall within the scope of the European Union directives regarding electromagnetic compatibility, restricted substances (RoHS), recycling (WEEE), FCC, CE or UL, and therefore may not meet the technical requirements of these directives or other related directives.

Should this evaluation board/kit not meet the specifications indicated in the User's Guide, the board/kit may be returned within 30 days from the date of delivery for a full refund. **THE FOREGOING WARRANTY IS THE EXCLUSIVE WARRANTY MADE BY SELLER TO BUYER AND IS IN LIEU OF ALL OTHER WARRANTIES, EXPRESSED, IMPLIED, OR STATUTORY, INCLUDING ANY WARRANTY OF MERCHANTABILITY OR FITNESS FOR ANY PARTICULAR PURPOSE.**

The user assumes all responsibility and liability for proper and safe handling of the goods. Further, the user indemnifies TI from all claims arising from the handling or use of the goods. Due to the open construction of the product, it is the user's responsibility to take any and all appropriate precautions with regard to electrostatic discharge.

**EXCEPT TO THE EXTENT OF THE INDEMNITY SET FORTH ABOVE, NEITHER PARTY SHALL BE LIABLE TO THE OTHER FOR ANY INDIRECT, SPECIAL, INCIDENTAL, OR CONSEQUENTIAL DAMAGES.**

TI currently deals with a variety of customers for products, and therefore our arrangement with the user **is not exclusive.**

TI assumes **no liability for applications assistance, customer product design, software performance, or infringement of patents or services described herein.**

Please read the User's Guide and, specifically, the Warnings and Restrictions notice in the User's Guide prior to handling the product. This notice contains important safety information about temperatures and voltages. For additional information on TI's environmental and/or safety programs, please contact the TI application engineer or visit [www.ti.com/esh](http://www.ti.com/esh).

No license is granted under any patent right or other intellectual property right of TI covering or relating to any machine, process, or combination in which such TI products or services might be or are used.

### FCC Warning

This evaluation board/kit is intended for use for **ENGINEERING DEVELOPMENT, DEMONSTRATION, OR EVALUATION PURPOSES ONLY** and is not considered by TI to be a finished end-product fit for general consumer use. It generates, uses, and can radiate radio frequency energy and has not been tested for compliance with the limits of computing devices pursuant to part 15 of FCC rules, which are designed to provide reasonable protection against radio frequency interference. Operation of this equipment in other environments may cause interference with radio communications, in which case the user at his own expense will be required to take whatever measures may be required to correct this interference.

### EVM WARNINGS AND RESTRICTIONS

It is important to operate this EVM within the input voltage range of 3.6 V to 17 V.

Exceeding the specified input range may cause unexpected operation and/or irreversible damage to the EVM. If there are questions concerning the input range, please contact a TI field representative prior to connecting the input power.

Applying loads outside of the specified output range may result in unintended operation and/or possible permanent damage to the EVM. Please consult the EVM User's Guide prior to connecting any load to the EVM output. If there is uncertainty as to the load specification, please contact a TI field representative.

During normal operation, some circuit components may have case temperatures greater than 50°C. The EVM is designed to operate properly with certain components above 50°C as long as the input and output ranges are maintained. These components include but are not limited to linear regulators, switching transistors, pass transistors, and current sense resistors. These types of devices can be identified using the EVM schematic located in the EVM User's Guide. When placing measurement probes near these devices during operation, please be aware that these devices may be very warm to the touch.

Mailing Address: Texas Instruments, Post Office Box 655303, Dallas, Texas 75265  
Copyright © 2010, Texas Instruments Incorporated

## IMPORTANT NOTICE AND DISCLAIMER

TI PROVIDES TECHNICAL AND RELIABILITY DATA (INCLUDING DATASHEETS), DESIGN RESOURCES (INCLUDING REFERENCE DESIGNS), APPLICATION OR OTHER DESIGN ADVICE, WEB TOOLS, SAFETY INFORMATION, AND OTHER RESOURCES "AS IS" AND WITH ALL FAULTS, AND DISCLAIMS ALL WARRANTIES, EXPRESS AND IMPLIED, INCLUDING WITHOUT LIMITATION ANY IMPLIED WARRANTIES OF MERCHANTABILITY, FITNESS FOR A PARTICULAR PURPOSE OR NON-INFRINGEMENT OF THIRD PARTY INTELLECTUAL PROPERTY RIGHTS.

These resources are intended for skilled developers designing with TI products. You are solely responsible for (1) selecting the appropriate TI products for your application, (2) designing, validating and testing your application, and (3) ensuring your application meets applicable standards, and any other safety, security, regulatory or other requirements.

These resources are subject to change without notice. TI grants you permission to use these resources only for development of an application that uses the TI products described in the resource. Other reproduction and display of these resources is prohibited. No license is granted to any other TI intellectual property right or to any third party intellectual property right. TI disclaims responsibility for, and you fully indemnify TI and its representatives against any claims, damages, costs, losses, and liabilities arising out of your use of these resources.

TI's products are provided subject to [TI's Terms of Sale](#), [TI's General Quality Guidelines](#), or other applicable terms available either on [ti.com](http://ti.com) or provided in conjunction with such TI products. TI's provision of these resources does not expand or otherwise alter TI's applicable warranties or warranty disclaimers for TI products. Unless TI explicitly designates a product as custom or customer-specified, TI products are standard, catalog, general purpose devices.

TI objects to and rejects any additional or different terms you may propose.

Copyright © 2026, Texas Instruments Incorporated

Last updated 10/2025