

BQ25618 (BMS024) Evaluation Module

This user's guide provides detailed testing instructions for the BQ25618 evaluation modules (EVM). Also included are descriptions of the necessary equipment, equipment setup, and procedures. The reference documentation contains the printed-circuit board layouts, schematics, and the bill of materials (BOM).

Throughout this user's guide, the abbreviations *EVM*, *BQ25618EVM*, *BMS024*, and the term *evaluation module* are synonymous with the BMS024 evaluation module, unless otherwise noted.

Contents

1	Introduction	3
	1.1 EVM Features	3
	1.2 I/O Descriptions	3
2	Test Summary	5
	2.1 Equipment	5
	2.2 Equipment Setup.....	5
	2.3 Software Setup.....	6
	2.4 Test Procedure.....	8
3	PCB Layout Guideline	10
4	Board Layout, Schematic, and Bill of Materials	10
	4.1 Board Layout.....	10
	4.2 Schematic	19
	4.3 Bill of Materials	20

List of Figures

1	Original Test Setup for BMS024A	6
2	BQStudio Device Type Selection Window	6
3	BQStudio Charger Selection Window	6
4	Main Window of BQ2561X EVM Software	7
5	BMS024 Rev. A Top Overlay	11
6	BMS025 Rev. A Top Solder Mask	12
7	BMS025 Rev. A Top Layer	13
8	BMS025 Rev. A MidLayer 1	14
9	BMS025 Rev. A MidLayer 2	15
10	BMS025 Rev. A Bottom Layer	16
11	BMS025 Rev. A Bottom Solder Mask	17
12	BMS025 Rev. A Bottom Overlay	18
13	Schematic	19

List of Tables

1	Device Data Sheets	3
2	EVM I/O Connections	3
3	EVM Jumper Shunt and Switch Installation.....	4
4	Recommended Operating Conditions.....	4
5	BQ25618EVM Bill of Materials	20

Trademarks

All trademarks are the property of their respective owners.

1 Introduction

1.1 EVM Features

For detailed features and operation, see [Table 1](#) for a list of devices and their data sheets.

Table 1. Device Data Sheets

Device	Data Sheet	EVM Label	Variant
BQ25618	SLUSDF8A	BQ25618EVM	001

The BMS024 evaluation module (EVM) is a complete charger module for evaluating an I²C-controlled single-cell NVDC charger using any of the devices listed above.

This EVM does not include the EV2300/EV2400 interface board. To evaluate the EVM, an EV2300/EV2400 interface board must be ordered separately.

1.2 I/O Descriptions

[Table 2](#) lists the input and output connections available on this EVM and their respective descriptions.

Table 2. EVM I/O Connections

Jack	Description
J1(1) - VIN	Positive rail of the charger input voltage
J1(2) - GND	Ground
J2(1) - SYSTEM	Positive rail of the charger system output voltage, typically connected to the system load
J2(2) - GND	Ground
J3(1) - VPB	Positive rail of the charger output voltage for power bank applications in reverse boost mode (OTG). This output also shares the rail with the VIN input rail in forward buck mode
J3(2)-GND	Ground
J4(3) - BATTERY	Positive rail of the charger battery input, connected to the positive terminal of the external battery
J4(2) - BATSNS	Input connected to the positive node of the battery for remote cell voltage measurement
J4(1) - GND	Ground
J5	Input source Micro B USB port
J6	I ² C 4-pin connector for the EV2300/2400 interface board

Table 3 lists the jumper and shunt installations available on this EVM and their respective descriptions.

Table 3. EVM Jumper Shunt and Switch Installation

Jack	Description	BQ25618 Setting
JP1	I/O Pullup rail selection. Selection will have either BAT or SYS as the pullup rail for SDA, SCL, \overline{CE} , \overline{PG} , STAT, and \overline{INT} pins.	Short PULL-UP to SYS
JP2	Remote BATSNS pin connection to Battery input terminal. Disconnect if sensing battery voltage remotely through J4(2). If disconnected with no input on J4(2), charger BATSNS will default connect to BAT pin internally.	Installed
JP3	PMID_GOOD pin connection to control N-Ch. MOSFET for a power bank application. On PMID_GOOD enabled chargers, connect this to control the PMID to VPB load switch.	Installed
JP4	Micro B USB input D+ connection to D+ test point	Not Installed
JP5	Thermistor COOL temperature setting. Connect jumper to simulate charger entering TCOOL (T1-T2) temperature region.	Not installed
JP6	Thermistor COLD temperature setting. Connect jumper to simulate charger entering TCOLD (<T1) temperature region.	Not installed
JP7	VPB status LED indicator connection. On power bank PMID_GOOD enabled chargers, this indicates VPB rail is active.	Installed
JP8	\overline{PG} pin LED indicator connection. On \overline{PG} enabled chargers, this indicates the Power Good status.	Not installed
JP9	STAT pin LED indicator connection. This indicates the current charger Status.	Not installed
JP10	Thermistor NORMAL temperature setting. Connect jumper to simulate charger entering TNORMAL (T2-T3) temperature region.	Installed
JP11	Thermistor WARM temperature setting. Connect jumper to simulate charger entering TWARM (T3-T5) temperature region.	Not Installed
JP12	Thermistor HOT temperature setting. Connect jumper to simulate charger entering THOT (>T5) temperature region.	Not installed
JP13	Micro B USB input D- connection to D- test point.	Not installed
JP14	\overline{CE} pin connection to ground to enable charging. When removed, \overline{CE} pin will pull up to disable charge.	Installed
JP15	PSEL pin input current selection. Connect this to HIGH on PSEL enabled chargers to select 500mA default input current limit. Connect this to LOW on PSEL enabled chargers to select 2.4-A default input current limit .	Short PSEL to LOW
S1	\overline{QON} control switch. Press either for exiting Shipping Mode or System Reset.	Default off

Table 4 lists the recommended operating conditions for this EVM.

Table 4. Recommended Operating Conditions

Symbol	Description	MIN	TYP	MAX	UNIT
V_{VBUS}, V_{VAC}	Input voltage applied to VAC and VBUS pins	3.9		13.5	V
V_{BAT}	Battery voltage applied to BAT pin	0	4.20	4.52	V
I_{VBUS}	Input current into VBUS	0		3.2	A
I_{SW}	Output current (SW)			1.8	A
I_{BAT}	Fast charging current	0		1.5	A
	RMS Discharging current through internal BATFET			5.0	A

2 Test Summary

2.1 Equipment

This section includes a list of supplies required for tests on this EVM.

1. **Power Supplies:** Power supply #1 (PS1): A power supply capable of supplying 5 V at 3 A is required. While this part can handle larger voltage and current, it is not necessary for this procedure.
2. **Loads:** Load #1 (4-Quadrant Supply, Constant Voltage < 4.5 V): A "Kepco" Load, BOP, 20-5M, DC 0 to ± 20 V, 0 to ± 5 A (or higher)
Alternative Option: A 0-20V/0-5A >30-W DC electronic load set in a constant voltage loading mode.
Load #2 (Electronic or Resistive Load): 10 Ω , 5 W (or higher)
3. **Meters:** (6x) "Fluke 75" multimeters, (equivalent or better).
Alternative Option: (4x) equivalent voltage meters and (2x) equivalent current meters. The current meters must be capable of measuring at least 5-A.
4. **Computer:** A computer with at least one USB port and a USB cable. Must have the latest version of Battery Management Studio installed.
5. **USB-TO-GPIO Communication Kit:** EV2300/EV2400 USB-based PC interface board.
6. **Software:** Download BQSTUDIOTEST from www.ti.com.
Double click the *Battery Management Studio* installation file and follow the installation steps. The software supports the Microsoft® Windows® XP, 7, and 10 operating systems.

2.2 Equipment Setup

Use the following instructions to set up the EVM testing equipment:

1. Review EVM connections in [Table 2](#).
2. Set PS1 for 5-V DC, 2-A current limit and then turn off the supply.
3. Connect the output of PS1 in series with a current meter to J1 (VIN and PGND).
4. Connect a voltage meter across TP13 (VAC_VBUS) and TP23 (PGND).
5. Turn on Load #1, set to constant voltage mode, and output to 2.5-V. Disable the load. Connect Load in series with a current meter, ground side, to J4 (BATTERY and PGND) as shown in [Figure 1](#).
6. Connect one voltage meter across TP16 (BAT) and TP22 (PGND), or across J4-3 and J4-1 as shown in [Figure 1](#).
7. Connect one voltage meter across TP19 (SYS) and TP21 (PGND), or across J2-1 and J2-2 as shown in [Figure 1](#).
8. Connect one voltage meter across TP15 (VPB) and TP23 (PGND), or across J3-1 and J3-2 as shown in [Figure 1](#).
9. Connect the EV2300/2400 USB interface board to the computer with a USB cable and from the I2C port to J8 with the 4-pin cable. The connections are shown in [Figure 1](#).

10. Install shunts as shown in Table 3.

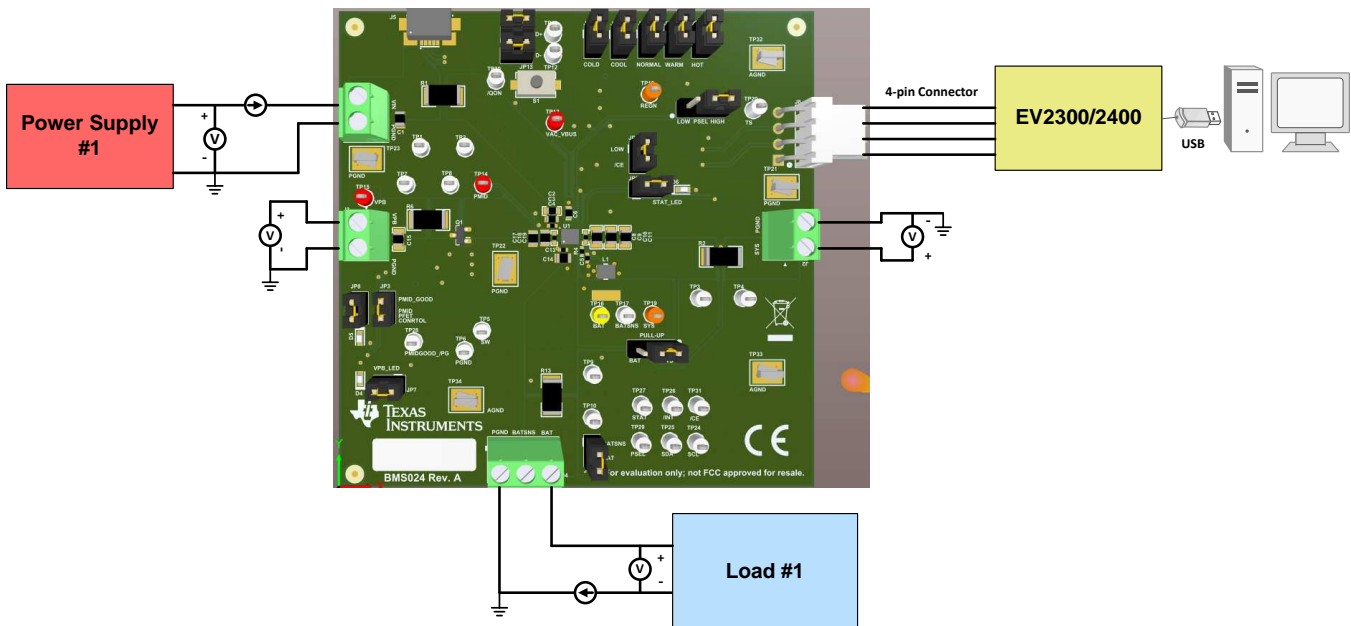
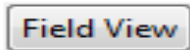

Figure 1. Original Test Setup for BMS024A

2.3 Software Setup

Use the following to set up the EVM testing software:

1. On the computer connected to the EV2300/2400 interface board, launch Battery Management Studio (BQStudio). Select Charger as seen in Figure 2.
2. Select the appropriate configuration file based on the device from the window shown in Figure 3.

3. Choose  , on the window that appears, and the main window of the BQ2561X EVM software will appear, as shown in Figure 4.

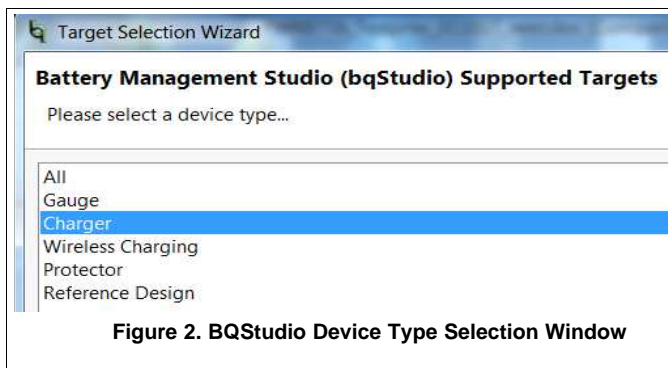

Figure 2. BQStudio Device Type Selection Window

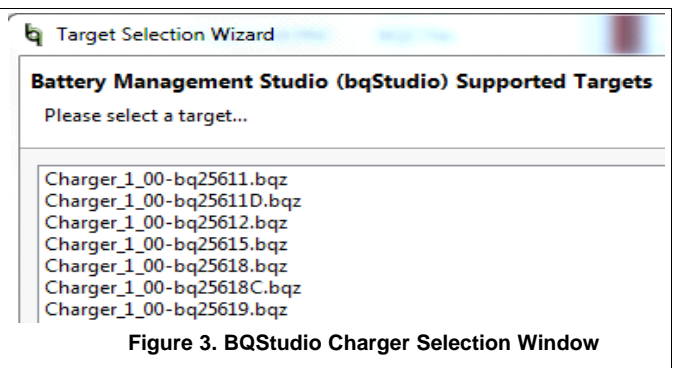

Figure 3. BQStudio Charger Selection Window

The screenshot shows the 'Registers' window in the Battery Management Studio. The interface includes a menu bar (File, View, Window, Help) and a toolbar with buttons for 'Save Registers', 'Load Registers', 'Start Log', 'Write Register', 'Read Register', and 'Auto Read: OFF'. The main area is divided into several sections:

- Multi-bit I2C Pull-down Menu:** Contains various configuration options such as 'Input Current Limit', 'VAC OVP Threshold', 'Minimum System Voltage', 'Recharge Threshold', 'Pre-charge Current Limit', 'Top-Off Timer', 'OTG Boost Regulation Voltage', 'Thermal Regulation Threshold', 'JETA-Warm (T3-T5) VSET', 'JETA-Cool (T1-T2) ISET', 'JETA-Warm (T3-T5) ISET', and 'JETA-Cool Threshold (VT2%)'.
- Single-bit I2C Selection:** A list of checkboxes for features like 'Force DqDim Deletion', 'Disable Remote BATSNS Regulation', 'Enable Termination', 'Enable 2X Extended Safety Timer', 'Disable PWM in OTG', 'Disable O4 BATFET', 'Enable O4 BATFET System Reset with Adapter Present', 'Enable HZ mode', 'Mask INDCPM INT pulse and Fault', 'Register Reset', 'Watch Dog Timer', 'Period: OFF', 'Disable External OVPFET', 'Enable Charge', 'Enable Charge Safety Timer', 'Enable OTG', 'Disable TS Function', 'Enable O4 Turn-off Delay', 'Enable O4 BATFET System Reset via I2C', 'Mask INDCPM INT pulse and Fault', and 'Reset Watchdog Timer'.
- Status:** A grid of status indicators for 'VBUS Adapter Status', 'Power Good Status', 'VSYS Regulation Status', 'WINDPM Status', 'BATSNS pin Status', 'ACOVp Status', 'Charge Status', 'Thermal Regulation Status', 'VBUS Good Status', 'INDCPM Status', and 'Top-Off Timer Status'.
- Fault:** A grid of fault indicators for 'Watchdog Fault', 'OTG Boost Fault', 'Charge Fault', and 'Battery Fault'.
- Part:** Fields for 'Device ID' (BQ2561X ID) and 'Rev ID'.
- Table:** A large table with columns for register addresses (A, 7, 6, 5, 4, 3, 2, 1, 0, D, W, R) and rows for register values (00, 01, 02, 03, 04, 05, 06, 07, 08, 09, 0A, 0B, 0C). Each cell contains a bit value (0 or 1) and a small icon for write/read operations.

At the bottom left, it says 'Watchdog Timer: Off'. At the bottom right, there is a 'TEXAS INSTRUMENTS' logo.

Figure 4. Main Window of BQ2561X EVM Software

2.4 Test Procedure

2.4.1 Initial Settings

Use the following steps for enabling the EVM test setup:

1. Make sure [Section 2.2](#) steps have been followed.
2. Launch the BQ2561X EVM GUI software, if not already done.
3. Turn on PS1:
 - **Measure** → V_{SYS} (SYS-TP19 and PGND-TP21) = 4.20V ±0.3V

NOTE: Completely disconnect Load #1 from BATTERY connections if different value is seen.







2.4.2 Communication Verification

Use the following steps for communication verification :

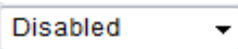
1. In the EVM software, click the  button
 - Verify that the GUI reads **Device ACK OK** in the top right corner.

NOTE: If the device reads **Device ACK Error** verify [Section 2.2](#) and [Section 2.4.1](#) steps have been followed.

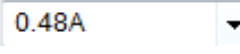
2. In the Field View (see [Figure 4](#)), make the following changes as necessary:

- Set **Watchdog Timer** 
- Set **Input Voltage Limit** 
- Set **Input Current Limit** 
- Set **Charge Voltage Limit** 
- Set **Fast Charge Current Limit** 
- Set **Pre-charge Current Limit** 
- Set **Minimum System Voltage** 
- Check **Enable Charge**
- Uncheck **Enable Termination**

2.4.3 Charger Mode Verification

Use the following steps for charger mode verification:

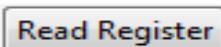
1. PS1 should be on from [Section 2.4.1](#). In the EVM software, click  **twice**.
 - Verify that all Fault statuses read "Normal"

Fault	
Watchdog Fault	Normal
Charge Fault	Normal
Battery Temperature Fault	Normal
OTG Boost Fault	Normal
Battery Fault	Normal

2. Enable Load #1 (see [Section 2.2](#)) and take measurements as follows:
 - **Measure** → V_{SYS} (SYS-TP19 and PGND-TP21) = 3.65V ±0.3V
 - **Measure** → V_{BAT} (BAT-TP16 and PGND-TP22) = 2.5V ±0.2V
 - **Measure** → I_{BAT} = 240mA ±50mA
3. Change Load #1 to 3.7V and take measurements as follows:
 - **Measure** → V_{SYS} (SYS-TP19 and PGND-TP21) = 3.8V ±0.3V
 - **Measure** → V_{BAT} (BAT-TP16 and PGND-TP22) = 3.7V ±0.2V
 - **Measure** → I_{BAT} = 480mA ±200mA
4. In the EVM software set **Fast Charge Current Limit** 0.96A
 - **Measure** → I_{IN} = 500mA ±200mA

2.4.4 Boost Mode Verification

Use the following steps for boost mode verification:

1. Turn off and disconnect PS1 .
2. Set Load #1 to 3.7V and 2A current limit.

NOTE: If Load #1 connected from BATTERY-J4(3) to PGND-J4(1) is not a four quadrant supply, remove Load #1 and use PS1, set to 3.7V, 2A current limit and connect to BATTERY-J4(3) and PGND-J4(1).

3. In the EVM software, check **Enable OTG** .
4. Connect Load #2 across VPB-J3(1) and PGND-J3(2).
 - Across **measure** → I_{IN} = 500mA ±200mA
5. Turn off and disconnect the power supply.
6. Remove Load #2 from the connection.

2.4.5 Helpful Tips

1. The leads and cables to the various power supplies, batteries and loads have resistance. The current meters also have series resistance. The charger dynamically reduces charge current depending on the voltage sensed at its VBUS pin (using the VINDPM feature), BAT pin (as part of normal termination), and TS pin (through its battery temperature monitoring feature via battery thermistor). Therefore, voltmeters must be used to measure the voltage as close to the IC pins as possible instead of relying on the digital readouts of the power supply. If a battery thermistor is not available, make sure shunt JP10 is in place.
2. When using a source meter that can source and sink current as your battery simulator, TI highly recommends adding a large (1000+ μF) capacitor at the EVM BATTERY and GND connector in order to prevent oscillations at the BAT pin due to mismatched impedances of the charger output and source meter input within their respective regulation loop bandwidths. Configuring the source meter for 4-wire sensing eliminates the need for a separate voltmeter to measure the voltage at the BAT pin. When using 4-wire sensing, always ensure that the sensing leads are connected in order to prevent accidental overvoltage by the power leads.
3. For precise measurements of input and output current, especially near termination, the current meter in series with the battery or battery simulator should not be set to auto-range and may need be removed entirely. An alternate method for measuring charge current is to either use an oscilloscope with hall effect current probe or by a differential voltage measurement across the relevant sensing resistors populated on the BMS024 EVM.

3 PCB Layout Guideline

Minimize the switching node rise and fall times for minimum switching loss. Proper layout of the components minimizing high-frequency current path loop is important to prevent electrical and magnetic field radiation and high-frequency resonant problems. This PCB layout priority list must be followed in the order presented for proper layout:

1. Place the input capacitor as close as possible to the PMID pin and GND pin connections and use the shortest copper trace connection or GND plane.
2. Place the inductor input terminal as close to the SW pin as possible. Minimize the copper area of this trace to lower electrical and magnetic field radiation but make the trace wide enough to carry the charging current. Do not use multiple layers in parallel for this connection. Minimize parasitic capacitance from this area to any other trace or plane.
3. Put an output capacitor near to the inductor and the IC. Tie ground connections to the IC ground with a short copper trace connection or GND plane.
4. Route analog ground separately from power ground. Connect analog ground and connect power ground separately. Connect analog ground and power ground together using power pad as the single ground connection point or use a 0- Ω resistor to tie analog ground to power ground.
5. Use a single ground connection to tie the charger power ground to the charger analog ground just beneath the IC. Use ground copper pour but avoid power pins to reduce inductive and capacitive noise coupling.
6. Place decoupling capacitors next to the IC pins and make the trace connection as short as possible.
7. It is critical that the exposed power pad on the backside of the IC package be soldered to the PCB ground. Ensure that there are sufficient thermal vias directly under the IC connecting to the ground plane on the other layers.
8. The via size and number should be enough for a given current path.

See the EVM design for the recommended component placement with trace and via locations.

4 Board Layout, Schematic, and Bill of Materials

4.1 Board Layout

[Figure 5](#) through [Figure 12](#) illustrate the PCB board layouts.

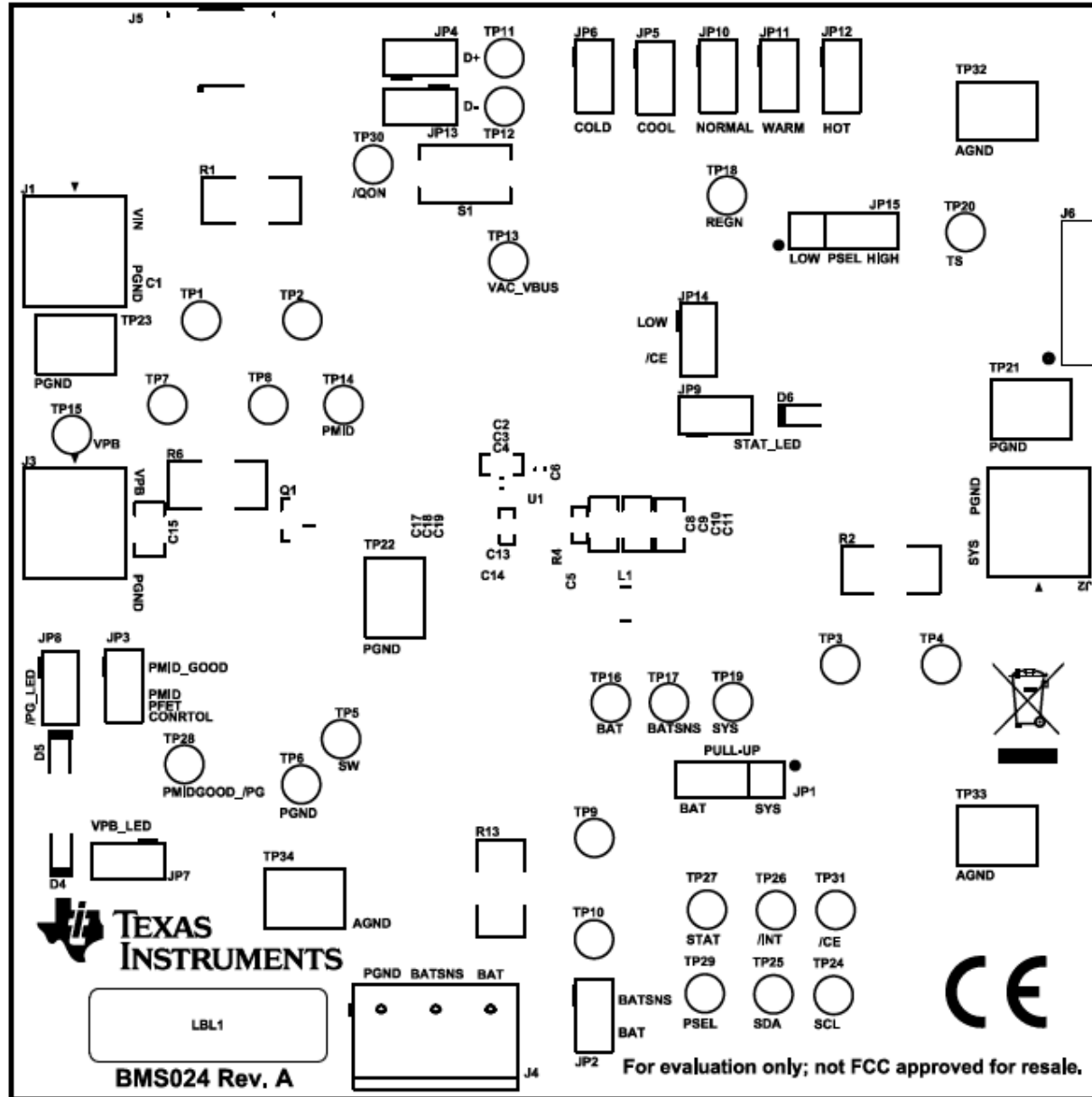

Figure 5. BMS024 Rev. A Top Overlay

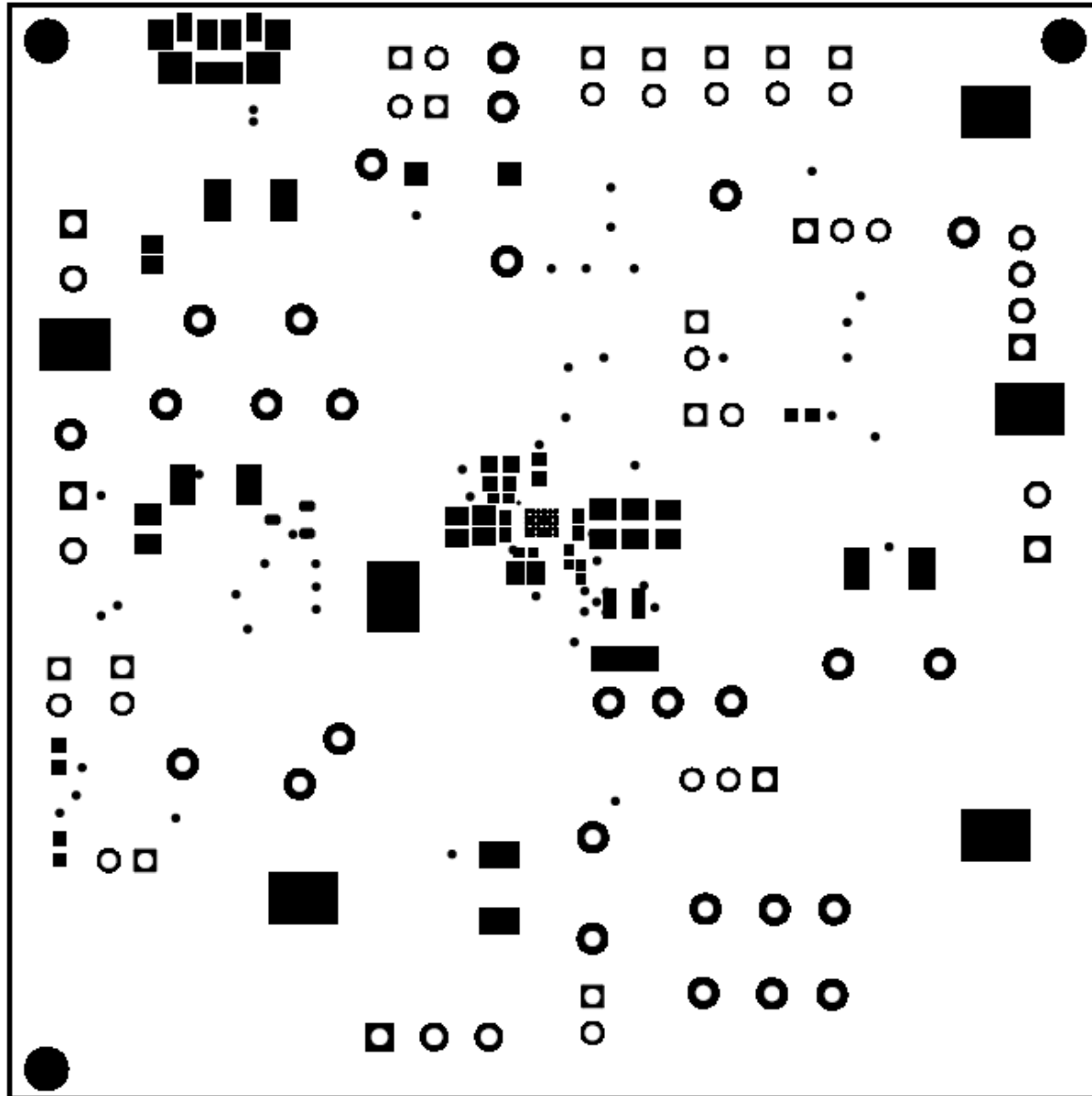

Figure 6. BMS025 Rev. A Top Solder Mask

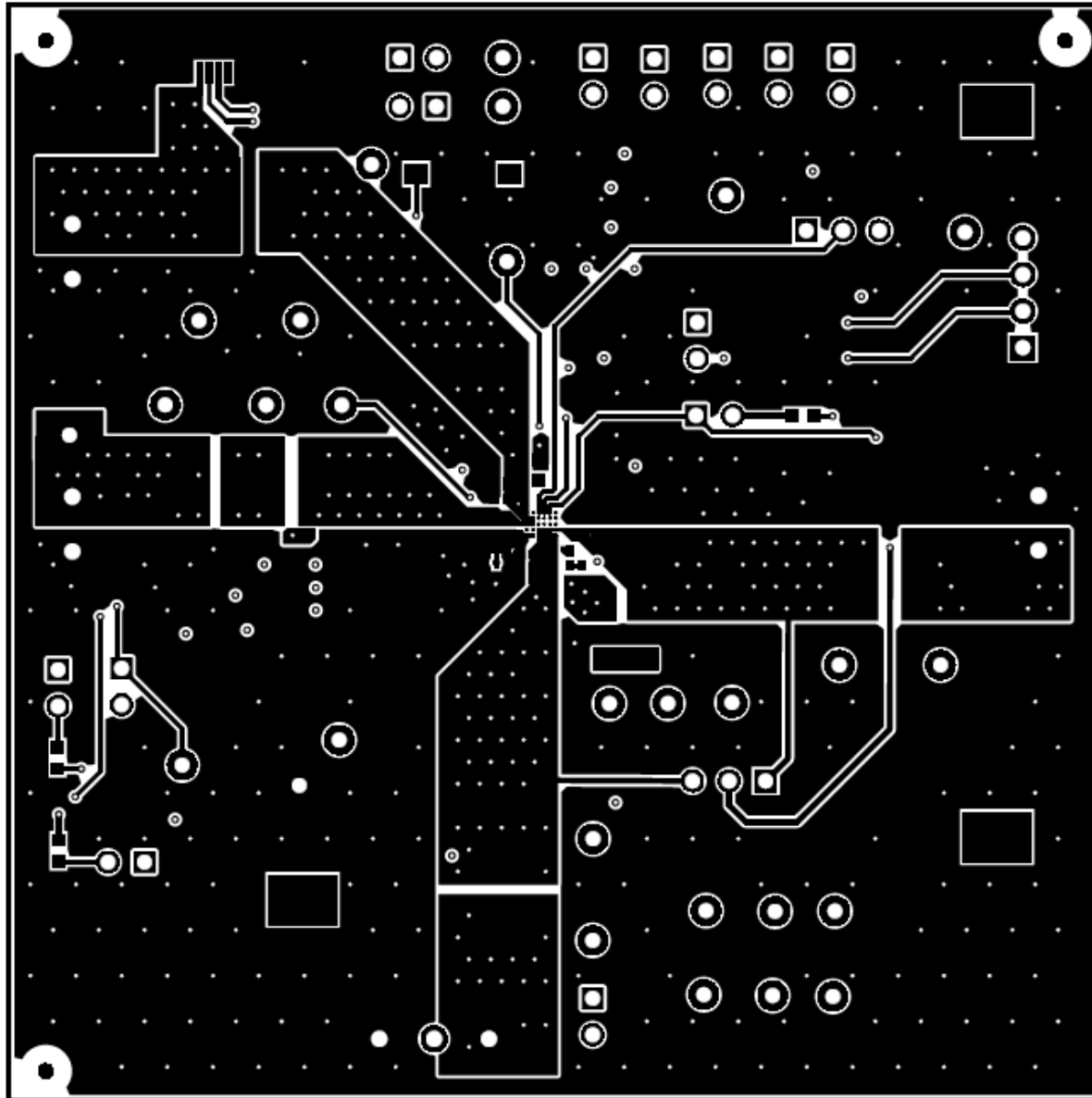

Figure 7. BMS025 Rev. A Top Layer

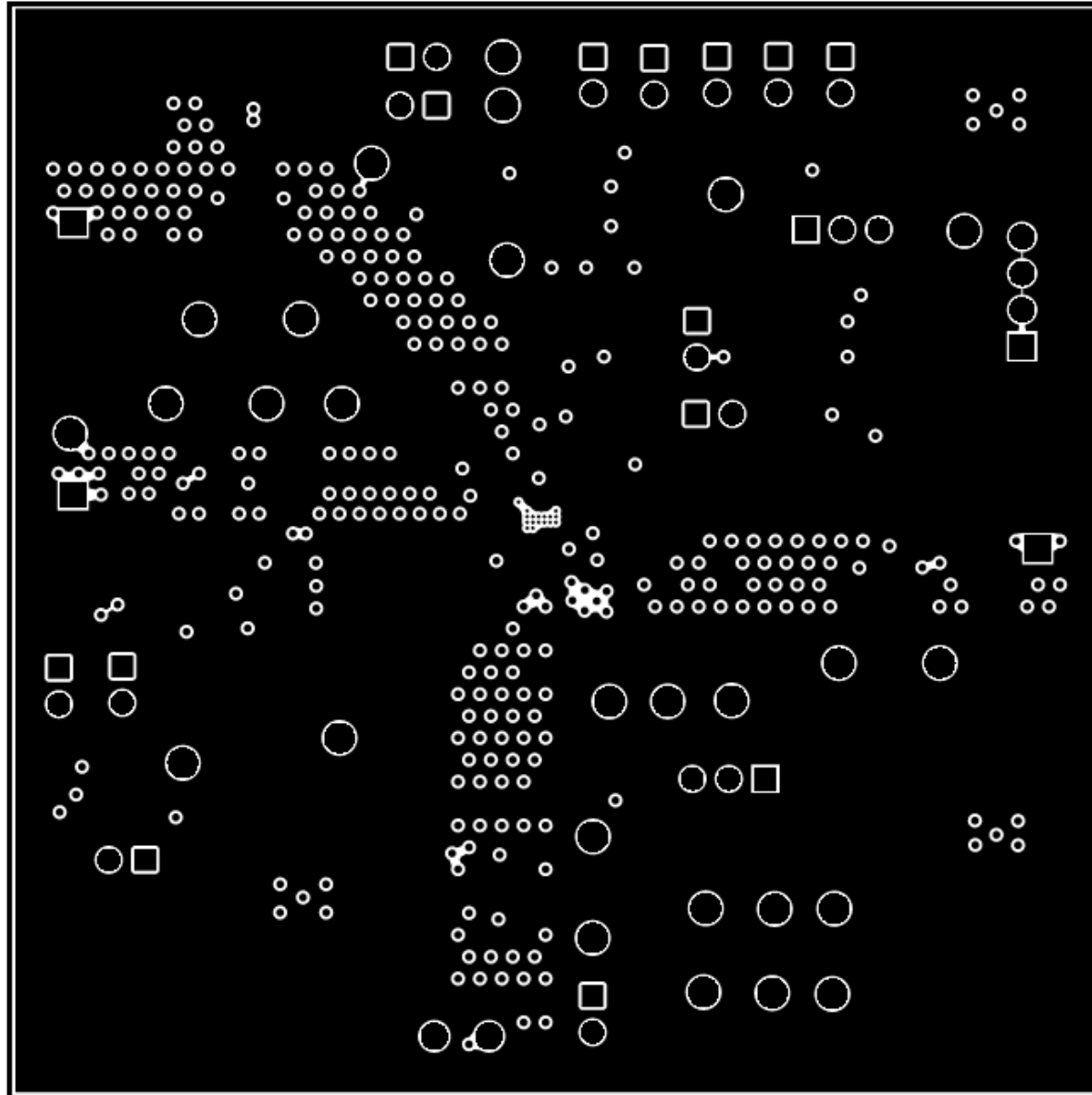

Figure 8. BMS025 Rev. A MidLayer 1

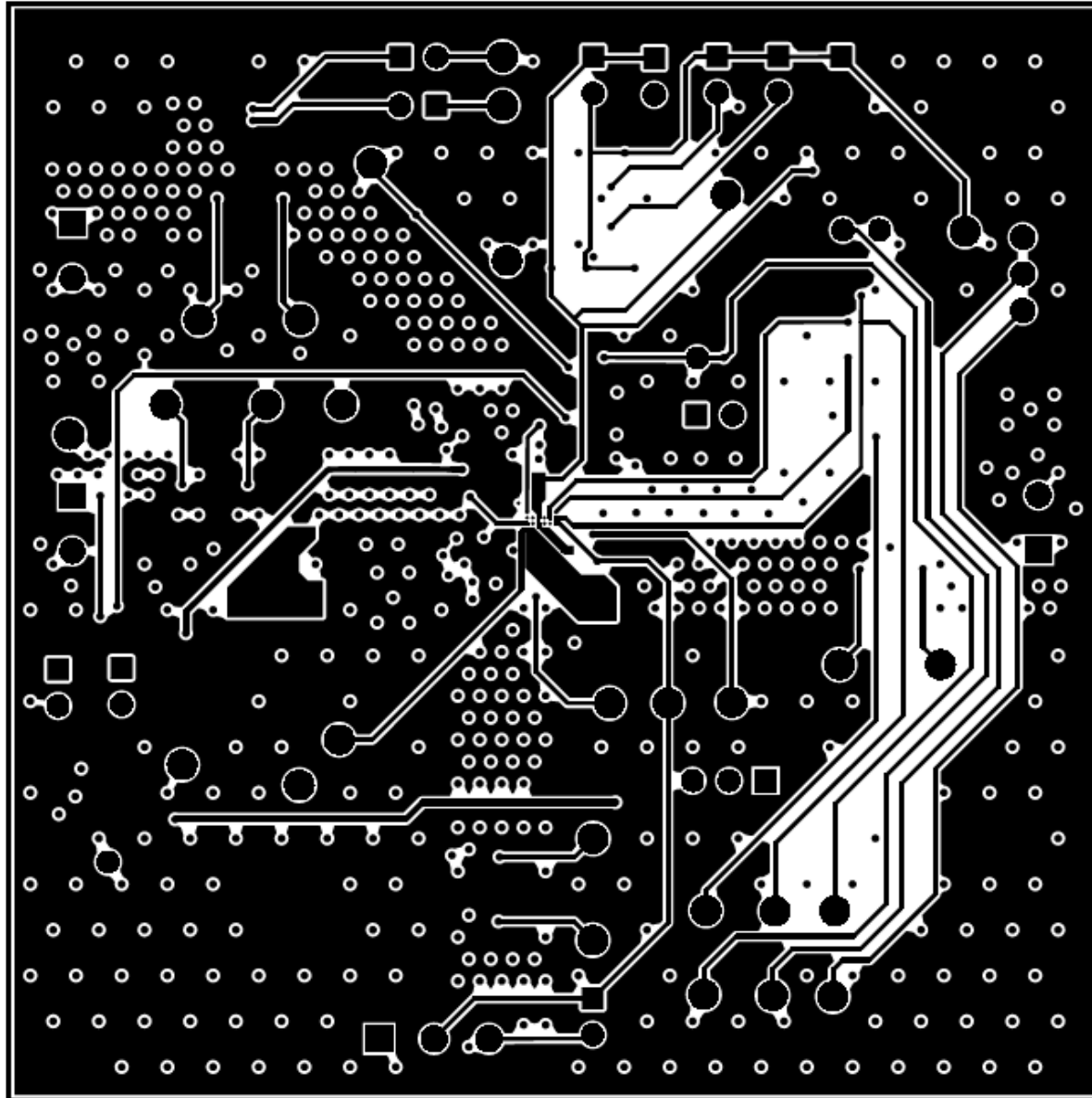

Figure 9. BMS025 Rev. A MidLayer 2

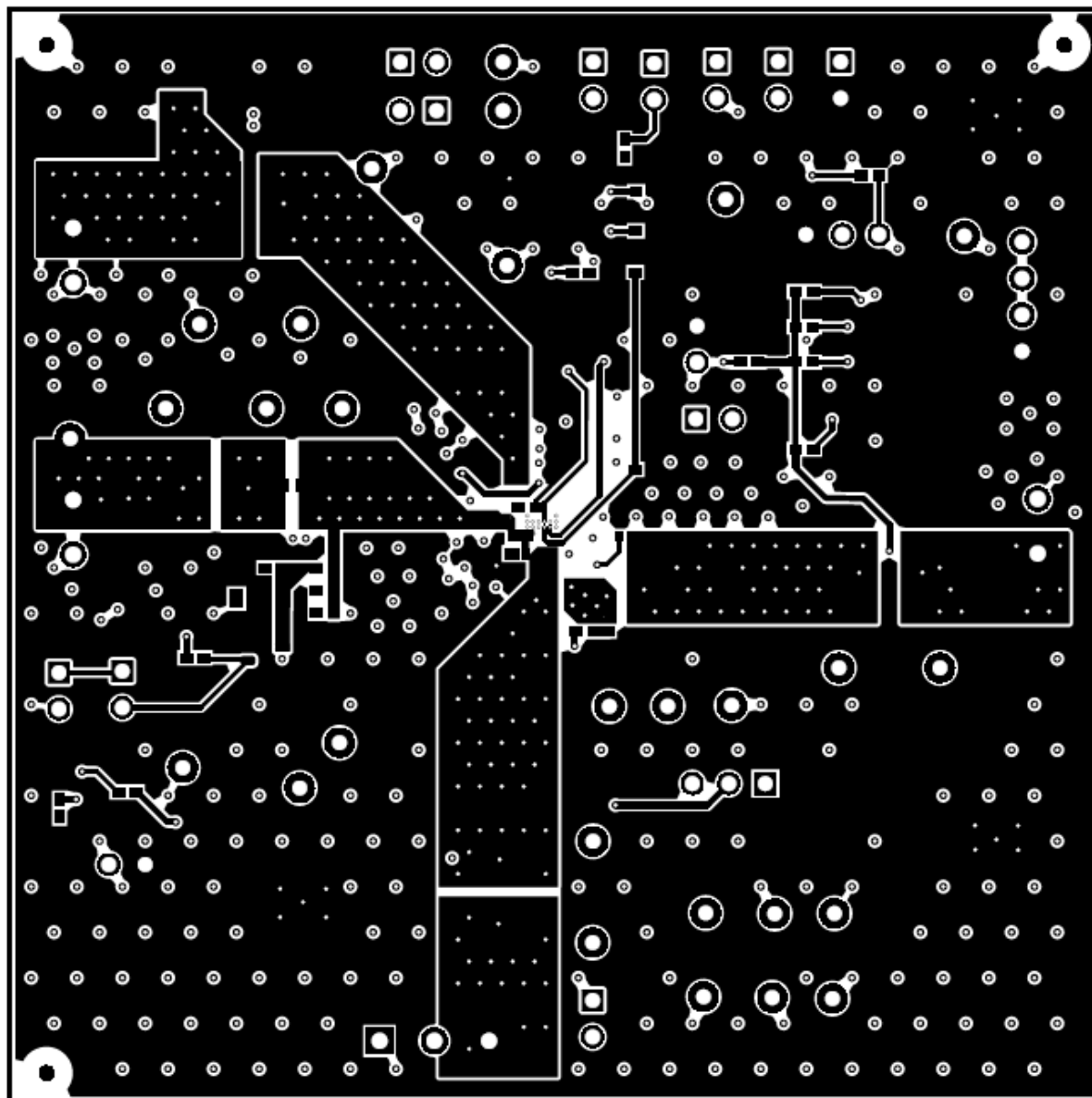

Figure 10. BMS025 Rev. A Bottom Layer

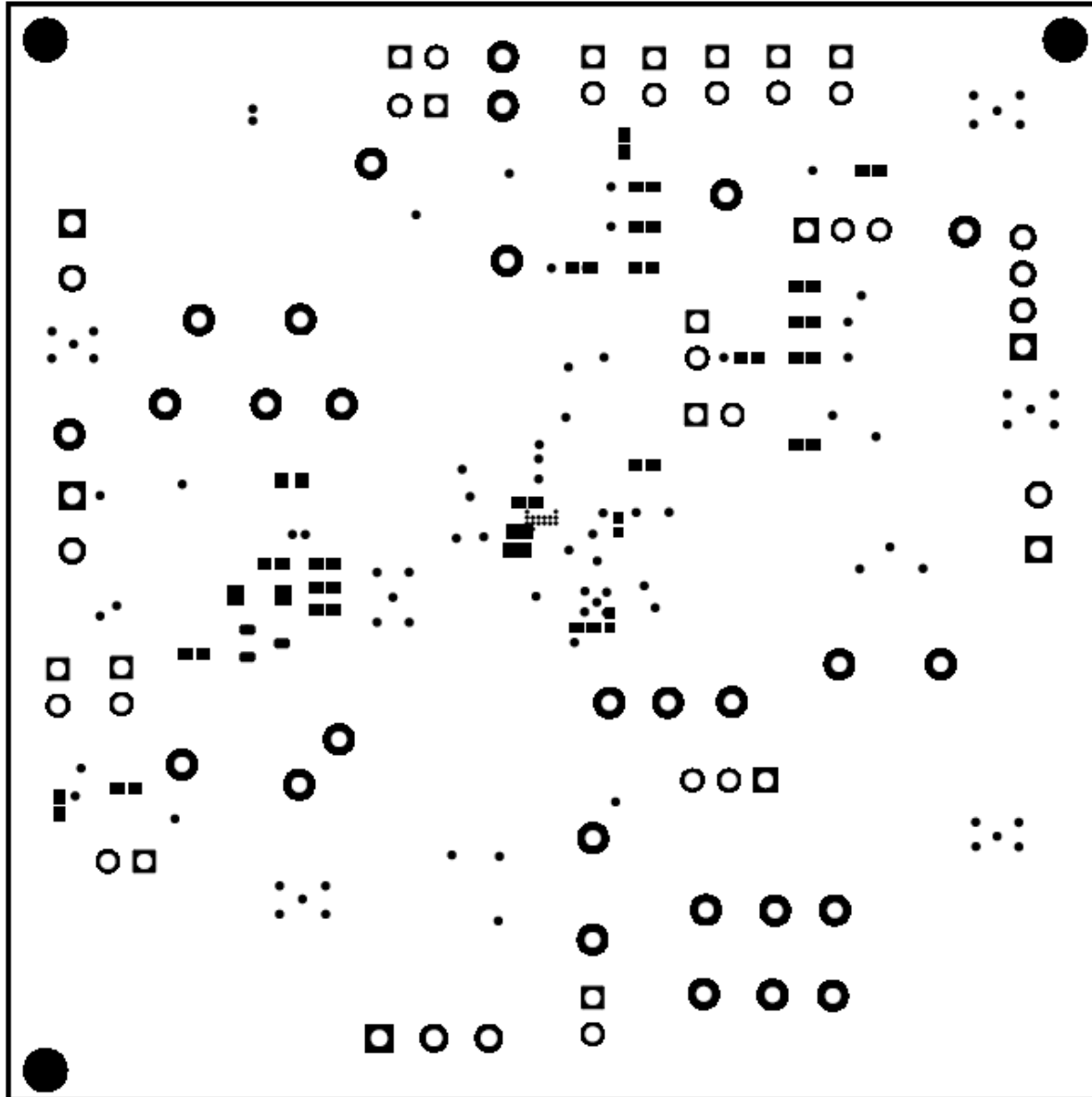

Figure 11. BMS025 Rev. A Bottom Solder Mask

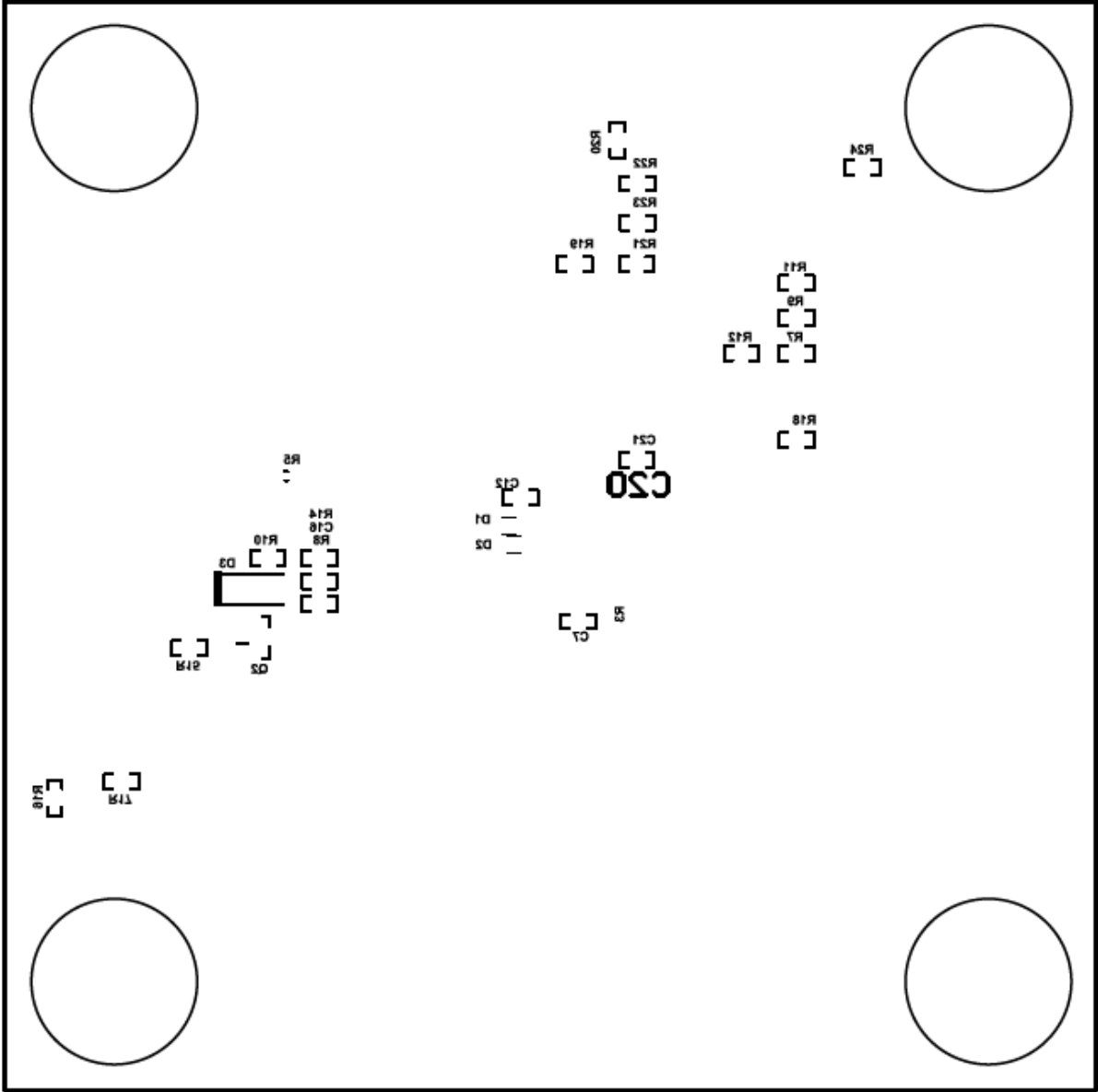

Figure 12. BMS025 Rev. A Bottom Overlay

4.2 Schematic

Figure 13 illustrates the schematic for the BQ25618EVM.

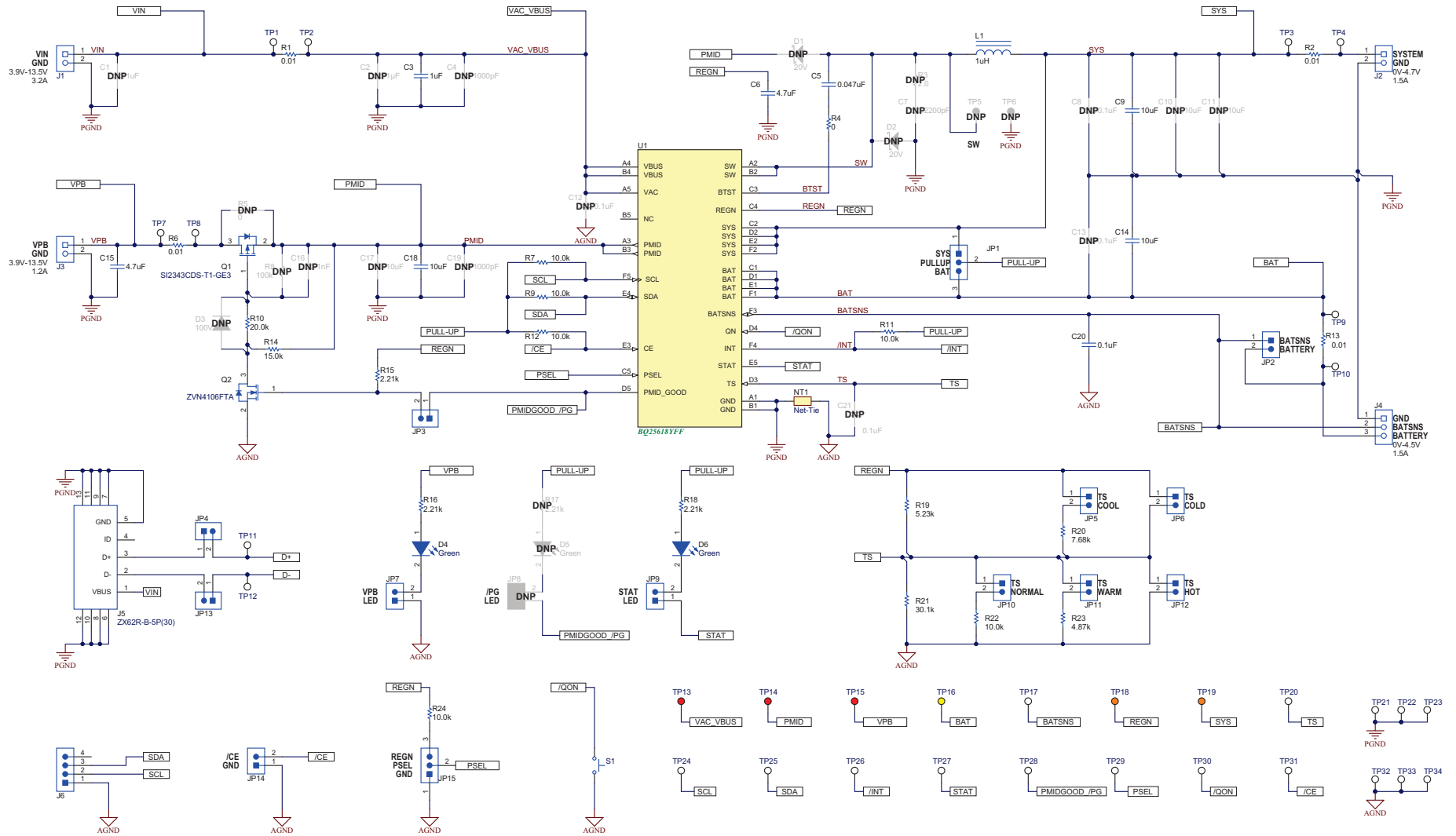

Figure 13. Schematic

4.3 Bill of Materials

Table 5 lists the BQ25618EVM BOM.

Table 5. BQ25618EVM Bill of Materials

Designator	QTY	Value	Description	Package Reference	Part Number	Manufacturer	Alternate Part Number ⁽¹⁾	Alternate Manufacturer ⁽¹⁾
!PCB1	1		Printed Circuit Board		BMS024	Any		
C3	1	1uF	CAP, CERM, 1 uF, 35 V, +/- 10%, X5R, 0603	603	GMK107BJ105KA-T	Taiyo Yuden		
C5	1	0.047uF	CAP, CERM, 0.047 uF, 25 V, +/- 10%, X7R, 0402	402	GRM155R71E473KA88D	MuRata		
C6	1	4.7uF	CAP, CERM, 4.7 uF, 16 V, +/- 10%, X5R, 0603	603	GRM188R61C475KAAJ	MuRata		
C9, C14	2	10uF	CAP, CERM, 10 uF, 16 V, +/- 10%, X7R, 0805	805	CL21B106KOQNNNE	Samsung Electro-Mechanics		
C15	1	4.7uF	CAP, CERM, 4.7 uF, 25 V, +/- 10%, X5R, 0805	805	C0805C475K3PACTU	Kemet		
C18	1	10uF	CAP, CERM, 10 uF, 25 V, +/- 10%, X7S, 0805	805	GRM21BC71E106KE11L	MuRata		
C20	1	0.1uF	CAP, CERM, 0.1 uF, 25 V, +/- 10%, X5R, 0402	402	GRM155R61E104KA87D	MuRata		
D4, D6	2	Green	LED, Green, SMD	1.6x0.8x0.8mm	LTST-C190GKT	Lite-On		
H1, H2, H3, H4	4		Bumpon, Hemisphere, 0.44 X 0.20, Clear	Transparent Bumpon	SJ-5303 (CLEAR)	3M		
J1, J2, J3	3		Conn Term Block, 2POS, 3.81mm, TH	2POS Terminal Block	1727010	Phoenix Contact		
J4	1		Terminal Block Receptacle, 3x1, 3.81mm, R/A, TH	Term Block, 3 pos	1727023	Phoenix Contact		
J5	1		Connector, Receptacle, Micro-USB Type B, Top Mount SMT	Connector USB Mini B	ZX62R-B-5P(30)	Hirose Electric Co. Ltd.		
J6	1		Header (friction lock), 100mil, 4x1, R/A, TH	4x1 R/A Header	22/05/3041	Molex		
JP1, JP15	2		Header, 100mil, 3x1, Tin, TH	Header, 3 PIN, 100mil, Tin	PEC03SAAN	Sullins Connector Solutions		
JP2, JP3, JP4, JP5, JP6, JP7, JP9, JP10, JP11, JP12, JP13, JP14	12		Header, 100mil, 2x1, Tin, TH	Header, 2 PIN, 100mil, Tin	PEC02SAAN	Sullins Connector Solutions		

⁽¹⁾ Unless otherwise noted in the Alternate Part Number and/or Alternate Manufacturer columns, all parts may be substituted with equivalents.

Table 5. BQ25618EVM Bill of Materials (continued)

Designator	QTY	Value	Description	Package Reference	Part Number	Manufacturer	Alternate Part Number ⁽¹⁾	Alternate Manufacturer ⁽¹⁾
L1	1	1uH	Inductor, 1 uH, 3.2 A, 0.028 ohm, SMD	2.5x2mm	MPIM252010F1R0M-LF	Microgate		
LBL1	1		Thermal Transfer Printable Labels, 0.650" W x 0.200" H - 10,000 per roll	PCB Label 0.650 x 0.200 inch	THT-14-423-10	Brady		
Q1	1	-30V	MOSFET, P-CH, -30 V, -5.9 A, SOT-23	SOT-23	SI2343CDS-T1-GE3	Vishay-Siliconix		None
Q2	1	60V	MOSFET, N-CH, 60 V, 0.2 A, AEC-Q101, SOT-23	SOT-23	ZVN4106FTA	Diodes Inc.		None
R1, R2, R6, R13	4	0.01	RES, 0.01, 1%, 1 W, 2010	2010	WSL2010R0100FEA18	Vishay-Dale		
R4	1	0	RES, 0, 5%, 0.063 W, AEC-Q200 Grade 0, 0402	402	CRCW04020000Z0ED	Vishay-Dale		
R7, R9, R11, R12, R22, R24	6	10.0k	RES, 10.0 k, 1%, 0.063 W, AEC-Q200 Grade 0, 0402	402	CRCW040210K0FKED	Vishay-Dale		
R10	1	20.0k	RES, 20.0 k, 1%, 0.063 W, AEC-Q200 Grade 0, 0402	402	CRCW040220K0FKED	Vishay-Dale		
R14	1	15.0k	RES, 15.0 k, 1%, 0.063 W, AEC-Q200 Grade 0, 0402	402	CRCW040215K0FKED	Vishay-Dale		
R15, R16, R18	3	2.21k	RES, 2.21 k, 1%, 0.063 W, AEC-Q200 Grade 0, 0402	402	CRCW04022K21FKED	Vishay-Dale		
R19	1	5.23k	RES, 5.23 k, 1%, 0.063 W, AEC-Q200 Grade 0, 0402	402	CRCW04025K23FKED	Vishay-Dale		
R20	1	7.68k	RES, 7.68 k, 1%, 0.063 W, AEC-Q200 Grade 0, 0402	402	CRCW04027K68FKED	Vishay-Dale		
R21	1	30.1k	RES, 30.1 k, 1%, 0.063 W, AEC-Q200 Grade 0, 0402	402	CRCW040230K1FKED	Vishay-Dale		
R23	1	4.87k	RES, 4.87 k, 1%, 0.063 W, AEC-Q200 Grade 0, 0402	402	CRCW04024K87FKED	Vishay-Dale		
S1	1		Switch, Normally open, 2.3N force, 200k operations, SMD	KSR	KSR221GLFS	C&K Components		
SH-JP1, SH-JP2, SH-JP3, SH-JP7, SH-JP9, SH-JP10, SH-JP14, SH-JP15	8	1x2	Shunt, 100mil, Gold plated, Black	Shunt	SNT-100-BK-G	Samtec	969102-0000-DA	3M

Table 5. BQ25618EVM Bill of Materials (continued)

Designator	QTY	Value	Description	Package Reference	Part Number	Manufacturer	Alternate Part Number ⁽¹⁾	Alternate Manufacturer ⁽¹⁾
TP1, TP2, TP3, TP4, TP7, TP8, TP9, TP10, TP11, TP12, TP17, TP20, TP24, TP25, TP26, TP27, TP28, TP29, TP30, TP31	20		Test Point, Miniature, White, TH	White Miniature Testpoint	5002	Keystone		
TP13, TP14, TP15	3		Test Point, Miniature, Red, TH	Red Miniature Testpoint	5000	Keystone		
TP16	1		Test Point, Miniature, Yellow, TH	Yellow Miniature Testpoint	5004	Keystone		
TP18, TP19	2		Test Point, Miniature, Orange, TH	Orange Miniature Testpoint	5003	Keystone		
TP21, TP22, TP23, TP32, TP33, TP34	6		Test Point, Compact, SMT	Testpoint_Keystone_Compact	5016	Keystone		
U1	1		BQ25618YFF, YFF0030AAAA (DSBGA-30)	YFF0030AAAA	BQ25618YFF	Texas Instruments		Texas Instruments
C1	0	1uF	CAP, CERM, 1 uF, 25 V, +/- 10%, X7R, 0805	805	GRM219R71E105KA88D	MuRata		
C2	0	1uF	CAP, CERM, 1 uF, 25 V, +/- 10%, X5R, 0603	603	TMK107BJ105KA-T	Taiyo Yuden		
C4, C19	0	1000pF	CAP, CERM, 1000 pF, 25 V, +/- 10%, X7R, 0402	402	885012205044	Würth Elektronik		
C7	0	2200pF	CAP, CERM, 2200 pF, 25 V, +/- 10%, X5R, 0402	402	GRM155R61E222KA01D	MuRata		
C8, C12, C13, C21	0	0.1uF	CAP, CERM, 0.1 uF, 25 V, +/- 10%, X5R, 0402	402	GRM155R61E104KA87D	MuRata		
C10, C11	0	10uF	CAP, CERM, 10 uF, 16 V, +/- 10%, X7R, 0805	805	CL21B106KOQNNNE	Samsung Electro-Mechanics		
C16	0	1000pF	CAP, CERM, 1000 pF, 50 V, +/- 1%, C0G/NP0, 0402	402	GRM1555C1H102FA01D	MuRata		
C17	0	10uF	CAP, CERM, 10 uF, 25 V, +/- 10%, X5R, 0805	805	GRM21BR61E106KA73L	MuRata		
D1, D2	0	20V	Diode, Schottky, 20 V, 1 A, 152AD	152AD	NSR10F20NXT5G	ON Semiconductor		
D3	0	100V	Diode, Ultrafast, 100 V, 0.15 A, SOD-123	SOD-123	1N4148W-7-F	Diodes Inc.		

Table 5. BQ25618EVM Bill of Materials (continued)

Designator	QTY	Value	Description	Package Reference	Part Number	Manufacturer	Alternate Part Number ⁽¹⁾	Alternate Manufacturer ⁽¹⁾
D5	0	Green	LED, Green, SMD	1.6x0.8x0.8mm	LTST-C190GKT	Lite-On		
FID1, FID2, FID3, FID4, FID5, FID6	0		Fiducial mark. There is nothing to buy or mount.	N/A	N/A	N/A		
JP8	0		Header, 100mil, 2x1, Tin, TH	Header, 2 PIN, 100mil, Tin	PEC02SAAN	Sullins Connector Solutions		
R3	0	2	RES, 2.0, 5%, 0.063 W, AEC-Q200 Grade 0, 0402	402	CRCW04022R00JNED	Vishay-Dale		
R5	0	0	RES, 0, 5%, 0.1 W, AEC-Q200 Grade 0, 0603	603	CRCW06030000Z0EA	Vishay-Dale		
R8	0	100k	RES, 100 k, 1%, 0.0625 W, 0402	402	RC0402FR-07100KL	Yageo America		
R17	0	2.21k	RES, 2.21 k, 1%, 0.063 W, AEC-Q200 Grade 0, 0402	402	CRCW04022K21FKED	Vishay-Dale		
SH-JP4, SH-JP5, SH-JP6, SH-JP8, SH-JP11, SH-JP12, SH-JP13	0	1x2	Shunt, 100mil, Gold plated, Black	Shunt	SNT-100-BK-G	Samtec	969102-0000-DA	3M
TP5, TP6	0		Test Point, Miniature, White, TH	White Miniature Testpoint	5002	Keystone		

IMPORTANT NOTICE AND DISCLAIMER

TI PROVIDES TECHNICAL AND RELIABILITY DATA (INCLUDING DATASHEETS), DESIGN RESOURCES (INCLUDING REFERENCE DESIGNS), APPLICATION OR OTHER DESIGN ADVICE, WEB TOOLS, SAFETY INFORMATION, AND OTHER RESOURCES "AS IS" AND WITH ALL FAULTS, AND DISCLAIMS ALL WARRANTIES, EXPRESS AND IMPLIED, INCLUDING WITHOUT LIMITATION ANY IMPLIED WARRANTIES OF MERCHANTABILITY, FITNESS FOR A PARTICULAR PURPOSE OR NON-INFRINGEMENT OF THIRD PARTY INTELLECTUAL PROPERTY RIGHTS.

These resources are intended for skilled developers designing with TI products. You are solely responsible for (1) selecting the appropriate TI products for your application, (2) designing, validating and testing your application, and (3) ensuring your application meets applicable standards, and any other safety, security, regulatory or other requirements.

These resources are subject to change without notice. TI grants you permission to use these resources only for development of an application that uses the TI products described in the resource. Other reproduction and display of these resources is prohibited. No license is granted to any other TI intellectual property right or to any third party intellectual property right. TI disclaims responsibility for, and you fully indemnify TI and its representatives against any claims, damages, costs, losses, and liabilities arising out of your use of these resources.

TI's products are provided subject to [TI's Terms of Sale](#), [TI's General Quality Guidelines](#), or other applicable terms available either on ti.com or provided in conjunction with such TI products. TI's provision of these resources does not expand or otherwise alter TI's applicable warranties or warranty disclaimers for TI products. Unless TI explicitly designates a product as custom or customer-specified, TI products are standard, catalog, general purpose devices.

TI objects to and rejects any additional or different terms you may propose.

Copyright © 2026, Texas Instruments Incorporated

Last updated 10/2025