

TI Designs: TIDA-00816

电网物联网参考设计：使用低于 1 GHz 射频连接故障指示灯、数据收集器和微型 RTU



说明

根据 TIDA-00816 参考设计，在多个传感器节点（本例中为故障通道指示灯）和使用 TI 15.4-stack 的收集器之间的星形网络中，使用低于 1GHz 的无线信号进行通信。本设计使用高架故障通道指示灯 (FPI) 和配电自动化中的数据收集器作为应用场景，针对近距离（小于 50m）低功耗进行了优化。TI 的 Simplelink 系列的 CC1310 器件是一款高度集成的单芯片解决方案，结合了低于 1GHz 射频 (RF) 收发器和 Arm® Cortex®M3 MCU。TI 15.4-stack 用于配置美国、ETSI 和中国频段的信标模式通信。通过优化发射功率电平（0 至 +10dBm）和信标间隔（0.3–5s），电流消耗数据可用于 1–300 字节 50kbps 数据速率的单个数据包数据传输。

资源

TIDA-00816	设计文件夹
CC1310	产品文件夹
TPS796	产品文件夹
TPD4E004	产品文件夹
TPD6E004	产品文件夹
TM4C1294NCPDT	产品文件夹
LM4040	产品文件夹
SN74AVC4T245	产品文件夹



咨询我们的 E2E™ 专家

特性

- 适用于 FPI、数据收集器、变电站和配电自动化终端设备的低功耗短距离通信（小于等于 50 米）：
 - 接收低于 **6mA** 的电流，发送低于 **16mA (+10 dBm)** 的电流
 - 星型网络中信标间隔（接收模式下的传感器节点）为五秒时平均电流消耗低于 **20µA**
 - 为美国 (915MHz)、ETSI (868MHz) 和中国 (433MHz) 频段提供电流消耗数据
- 电网自动化中的集成低功耗射频：
 - 网络设置
 - 信标传输和接收
 - 数据交换
 - 故障识别和数据通信
- 使用 **CC1310** 器件的优势：
 - 低有源射频和微控制器 (MCU) 电流消耗，待机电流为 **0.7 µA**（RTC 运行，RAM 和 CPU 保持）
 - 使用 TI 15.4-stack 配置收集器和传感器（故障指示灯）节点之间的信标使能通信
 - TI 的 SimpleLink™ 平台可实现与 MCU 系列的无缝集成

应用

- [故障指示灯](#)，[变送器](#)，[传感器](#)
- [数据收集器](#)，[远程终端装置 \(RTU\)](#)
- [变电站和配电自动化](#)
- [智能电表](#)
- [楼宇自动化](#)：[门窗传感器](#)，[运动检测器](#)

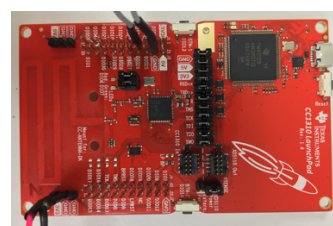
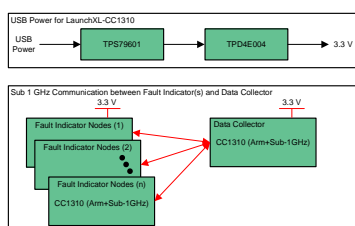



该 TI 参考设计末尾的重要声明表述了授权使用、知识产权问题和其他重要的免责声明和信息。

1 System Description

Utility companies want to reduce the number and duration of power outages because it results in wastage of resources, decrease in productivity, and increased customer inconvenience. Minimizing downtime requires quicker identification of faults and faster data communication. Various fault detection and isolation schemes are used by utilities which involve automation at multiple levels including line monitoring, communication, SCADA for data analysis and processing which is then followed by controlling reclosers.

To minimize the overall downtime, legacy communication networks require greater resilience and better response time. While sub-1 GHz RF communication between the FPI nodes and the data collector offers a reliable connection, these solutions need to operate on very low power because access to backup power sources is limited. FPI harvest energy from the line current which is not available during a fault event. The requirement for wide environmental range inhibits using a conventional capacitor and certain batteries because of cost and form factor. It is critical for the RF communication to optimize the way in which the data is transmitted by conserving energy. Not only is the FPI transmitting fault detection data, but also it has to follow through with the waveform data that includes a certain number of prior and post cycles data for analysis. TI's sub-1 GHz solution offers an extremely low-power consuming RF solution to facilitate integration of RF connectivity to substation and distribution automation end equipment.

Integrating Sub-1 GHz wireless connectivity

Multiple wireless communication technologies are available including near-field communication (NFC), Bluetooth® LE (BLE), ZigBee®, sub-1 GHz, Wi-Fi®, and so forth. The selection of suitable technology for any equipment is dependent on the amount of data transferred, distance, number of nodes, power that is available and response time.

While the [TIDA-010007](#) design shows integrating Wi-Fi as an alternate solution for substations and residential breakers, sub-1 GHz connectivity is the ideal for connecting multiple FI to a single data collector because it is optimized for low power consumption for short bursts of data when distances are beyond BLE range and in the absence of a Wi-Fi network. Wi-Fi has an extremely high data rate, and BLE has higher bandwidth (almost 3 times), which emphasizes the suitability of sub-1 GHz as the easiest way to integrate wireless connectivity in distribution and substation automation applications. The sub-1 GHz RF band is relatively less crowded compared to the 2.4-GHz frequency band. It operates in the Industrial, Scientific, and Medical (ISM) spectrum bands below 1 GHz – typically in the 769–935 MHz, and 315–468 MHz frequency range. Other benefits of sub-1 GHz technology include:

- Provide a standard based network solution with robust performance
- Lower development cost by providing an end-to-end solution
- Future proof deployments with scalable network features

The TIDA-00816 reference design has:

- Power consumption data for low power (average current of 20 μ A for a 5-s beacon interval) and short range (< 50 meters) for US, European Telecommunications Standards Institute (ETSI), and China frequency bands
- Use cases including establishing a Personal Area Network (PAN), setting up and communicating from data collector to FPI and vice versa via beacon mode, data report from FI nodes to data collector, extraction of data by FI node from data collector, and fault indication and communication

1.1 Data Communication Between Data Collector and Multiple Overhead FI Nodes

A fault passage indicator (FPI) or fault indicator (FI) is an end equipment that helps to indicate location of faults along with data logging functionality for power line voltage and current in the grid network. They are also equipped with visual indication for performing visual tracking and audits in the field. Two parts of a fault-indication system are the fault sensing and communicating fault information. The decreasing trend in the power consumed by data acquisition systems makes sure that we have the right solution. Fault communication can happen either through wired or wireless connectivity, the latter being preferable for the field. The challenge lies in making a fault-indicator node able to communicate for years at a time while indicating fault and communicating regularly with a data collector and subsequently to the SCADA network.

This design addresses this challenge with sub-1 GHz connectivity which is suited to this application as the electric poles on which the FI nodes sit are separated by a short distance and it can utilize low power sub-1 GHz star network to communicate with a single data collector. The fault indication can happen immediately as the data collector is always in receive mode, whereas in no fault mode, the FI wakes up intermittently and receives a beacon and can also report health data independent of the beacon, helping conserve power on the power critical FI node.

1.2 Communication Between Multiple End Equipment in Substation Automation

A substation is comprised of multiple monitoring and protection equipment including protection relay, circuit breaker, terminal unit, transducer, data concentrator, and so forth. and expensive assets such as transformers, generators, switchgear, busbars, motors, and so forth. These are inter-connected through a serial wired interface such as RS-232, RS-485, Ethernet, and so forth.

Adding sub-1 GHz connectivity inside a substation can help in connecting sensor nodes to a SCADA network for asset health monitoring and fault indication for equipment in a short range of the control system or a dedicated data collector, for instance, multiple transducers in a substation can be connected via sub-1 GHz connectivity in the manner shown in this reference design

1.3 Key System Specifications

PARAMETER	SPECIFICATIONS	DETAILS
Parameters for sub-1 GHz connectivity	Operating frequency band	<ul style="list-style-type: none"> • US (915 MHz) • ETSI (868 MHz) • China (433 MHz)
	Number of sensor (FPI) nodes connected to data collector	3-9
	Data Rate	50 kbps
	Distance between collector and sensor (FPI) nodes	Up to 50 m
	Transmit power level	0 to +10 dBm
Application use cases	PAN setup by collector	节 2.5.1
	Beacon mode communication	节 2.4.3.1
	Data report from FPI to collector	节 2.5.2
	Data exchange between FPI node and collector	节 2.5.4
	Fault indication and communication	节 2.5.4.1
Hardware and software requirements	for testing RF communication between two LaunchPads	节 3.3.1 and 节 3.3.2
	for measuring current consumption	节 3.3.3

PARAMETER	SPECIFICATIONS	DETAILS
System design theory (IEEE 802.15.4 compliant)	Network topologies, PHY layer, MAC layer, beacon mode, frame formats, CSMA-CA protocol	2.4 节
DC power supply	5-V, 250 mA	USB or DC supply

2 System Overview

2.1 Block Diagram



图 1. TIDA-00816 Block Diagram

The implementation is as follows:

- The LaunchXL-CC1310 LaunchPad can act as both the FI node and data collector node on separately configured LaunchPads
- The power supply to the LaunchPad uses the TPS796xx LDO along with the TPD4 series TVS Diode

This reference design includes power benchmarking for the following cases:

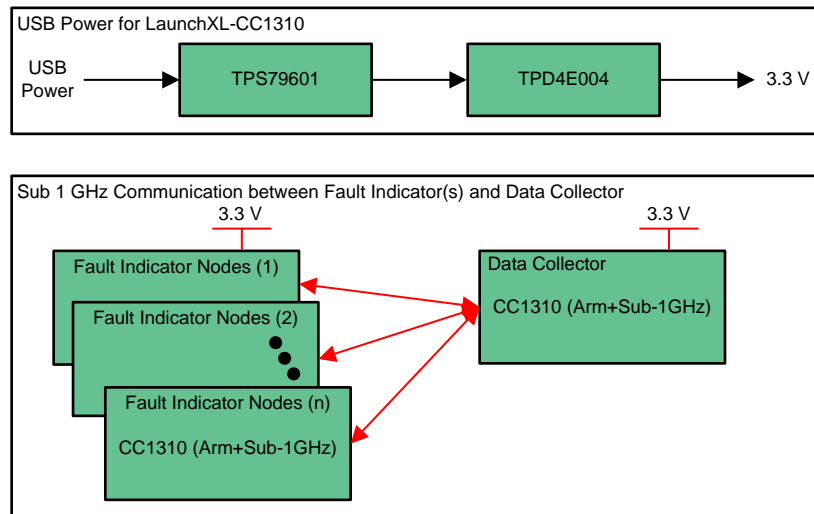
- Configuring beacon interval
- Configuring transmit signal power
- Data transfer from collector to sensor (FPI) node
- Data transfer from sensor (FPI) to collector node

2.2 Design Considerations

Some key design considerations for the TIDA-00816 are:

- **Device selection:** The **CC1310** is TI's ultra-low power sub-1 GHz transceiver with an integrated MCU which offers optimal power consumption for distribution automation applications requiring low-power communication. Other TI devices that offer similar functionality with additional features are **CC1312R** (high performance sub-1 GHz wireless MCU) and the **CC135x** devices offering dual band operation (sub-1 GHz and 2.4 GHz)
- **Software stack selection:** The SimpleLink sub-1 GHz stack solution (TI 15.4-stack) is built on TI's SimpleLink MCU platform. This platform offers a single development environment with code portability to multiple connectivity protocols and is a complete solution for connecting long-range, low power sensors. It offers a standards-based, star-network that makes sub-1 GHz connectivity easy by providing all of the necessary components for a robust system.
- **Selection of mode of operation: Beacon mode** allows saving power on the power-critical FI node by ensuring wakeup only for either receiving beacon or reporting health data to the data collector

- The optimal power level for achieving low current consumption for short range (< 50 m) communication using the CC1310 device is 0 dBm
- Data transfer is done only for the purpose of measuring current consumption and does not have an application-level data exchange between the sensor (FPI) and the collector

This is a generic design implementation that can be modified depending on the type of end equipment. A suitable beacon interval and power level are selected based on the distance between nodes, critical current consumption limits, and memory size on the FI or any other sensor node.

2.3 Highlighted Products

The following sections provide details on the TI products used in this TI design.

2.3.1 CC1310

The CC1310 device is a member of the CC26xx and CC13xx families of cost-effective, ultra-low-power, 2.4-GHz and sub-1 GHz RF devices. The low-power consumption of the CC1310 device does not come at the expense of RF performance; the CC1310 has excellent sensitivity and robustness (selectivity and blocking) performance. The CC1310 device is a highly integrated, true single-chip solution incorporating a complete RF system and an on-chip DC/DC converter. Sensors can be handled in a very low-power manner by a dedicated autonomous ultra-low-power MCU that can be configured to handle analog and digital sensors; thus, the main MCU (Cortex-M3) is able to maximize sleep time. The complete TI-RTOS and device drivers are offered in source code free of charge.

For more details on this device, see the [CC1310 product page](#).

2.3.2 TPS796

The TPS796 family of low-dropout (LDO) low-power linear voltage regulators have a high power-supply rejection ratio (PSRR), ultra-low noise, fast start-up, and excellent line and load transient responses in small outline, 3 × 3 VSON, SOT223-6, and TO-263 packages. When the device is placed in standby mode, the supply current is reduced to less than 1 μ A. The TPS79630 exhibits approximately 40 μ V_{RMS} of output voltage noise at 3.0-V output with a 0.1- μ F bypass capacitor. Applications with analog components that are noise sensitive, such as portable RF electronics, benefit from the high PSRR, low-noise features, and fast response time

For more details on this device, see the [TPS796 product page](#).

2.3.3 TPD4E004

The TPD4E004 device is a low-capacitance transient voltage suppression (TVS) device. The TPD4E004 device is designed to protect sensitive electronics attached to communication lines from electrostatic discharge (ESD). Each of the four channels consists of a pair of diodes that steer ESD current pulses to VCC or GND. The TPD4E004 protects against ESD pulses up to \pm 15-kV Human-Body Model (HBM) and, as specified in IEC 61000-4-2, \pm 8-kV contact discharge, and \pm 12-kV air-gap discharge. This device has 1.6-pF of capacitance per channel, making it ideal for use in high-speed data IO interfaces. The TPD4E004 device is a quad-ESD structure designed for USB, ethernet, and other high-speed applications.

For more details on this device, see the [TPD4E004 product page](#).

2.3.4 Debug Interface

When a continuous debug is required, use the following devices:

- **TM4C1294NCPDT:** Tiva™ C Series microcontrollers have the ability to allow critical, real-time control between performance and power. The microcontrollers also have integrated communication peripherals along with other high-performance analog and digital functions. This offers a strong foundation for many different target uses, spanning from human machine interfaces to networked system management controllers. For more details on this device, see the [TM4C1294NCPDT product page](#).
- **LM4040:** These shunt voltage references are versatile, easy-to-use references that cater to a vast array of applications. The 2-pin fixed-output device requires no external capacitors for operation and is stable with all capacitive loads. For more details on this device, see the [LM4040 product page](#).
- **SN74AVC4T245:** This 4-bit noninverting bus transceiver uses two separate configurable power-supply rails. For more details on this device, see the [SN74AVC4T245 product page](#).
- **TPD6E004:** The TPD6E004 device is a low-capacitance, ± 15 -kV ESD-protection diode array designed to protect sensitive electronics attached to communication lines. For more details on this device, see the [TPD6E004 product page](#).

2.4 System Design Theory

2.4.1 Network Topologies

Introduction

Low-rate wireless personal area networks (LR-WPAN) are simple, low-cost communication networks that introduce wireless connectivity in applications where limited power and relaxed throughput are required. The main intent of PAN is simplicity of installation, reliability in data transfer, extremely low cost, and a reasonable battery life, along with maintaining a simple and flexible protocol.

There are two device types capable of taking part in an IEEE 802.15.4 standard compliant network: a full-function device (FFD) and a reduced-function device (RFD). Only an FFD is capable of serving as a PAN Coordinator. An RFD cannot serve as a PAN coordinator as it is intended for extremely simple application, a light switch for example, it does not have the need to send huge amounts of data and can associate with one FFD, PAN. These features allow an RFD to be implemented using minimal resources and memory capacity.

The two possible network topologies in which an IEEE 802.15.4 standard-based LR-WPAN can operate are:

- Star topology
- Peer to peer topology

In the star topology, the communication establishment is between single/multiple devices and one central and primary controller, called the PAN coordinator. The devices connected to the PAN coordinator can be initiation or termination point for communication on the network. All devices operating on any of the two network topologies have unique addresses, referred to as extended address. In addition to its extended address, a device can be allocated a short address during the association process. The device has the

option to use either of the two address schemes for any and all communication with the PAN coordinator. In most applications, it is found that the PAN coordinator will be powered by mains, while devices will mostly be battery powered, and hence power consumption becomes a more critical parameter on the sensor (FPI) nodes. Applications that benefit from a star topology include Grid Infrastructure devices with home automation, personal computer (PC) peripherals, games, and personal health care.

The peer-to-peer topology also includes a PAN coordinator; which is different from the star topology in that any node is able to communicate with any other node as long as they are in range of one another. Peer to peer connection topology allows implementation of more complex network formations like mesh networking topology. Every independent Personal Area Network (PAN) chooses a unique identifier (ID). This PAN ID allows communication between devices within a network using short addresses and allows communication between devices across independent networks. The mechanism by which identifiers are chosen is outside the scope of this standard.



图 2. Star and Peer-to-Peer Topology Network

2.4.1.1 Star Network Topology

图 2⁽¹⁾ illustrates the basic structure of a star network. After a fully-functional device is activated, it can establish a network on its own and become the PAN coordinator for the network. All the star networks operate independently from all other star networks operating simultaneously around it. The network can achieve this by choosing a PAN ID that is not being used by any other network within the radio communication range. Once the PAN ID is chosen, the PAN coordinator has the ability to allow other devices, to join its network. The high level formation of a star network can be found in the later sections. The PAN coordinator, in essence monitors the channel more often than a sensor node, which can be in sleep or standby mode unless it has a data packet to send or receive.

2.4.2 PHY Layer and MAC Layer

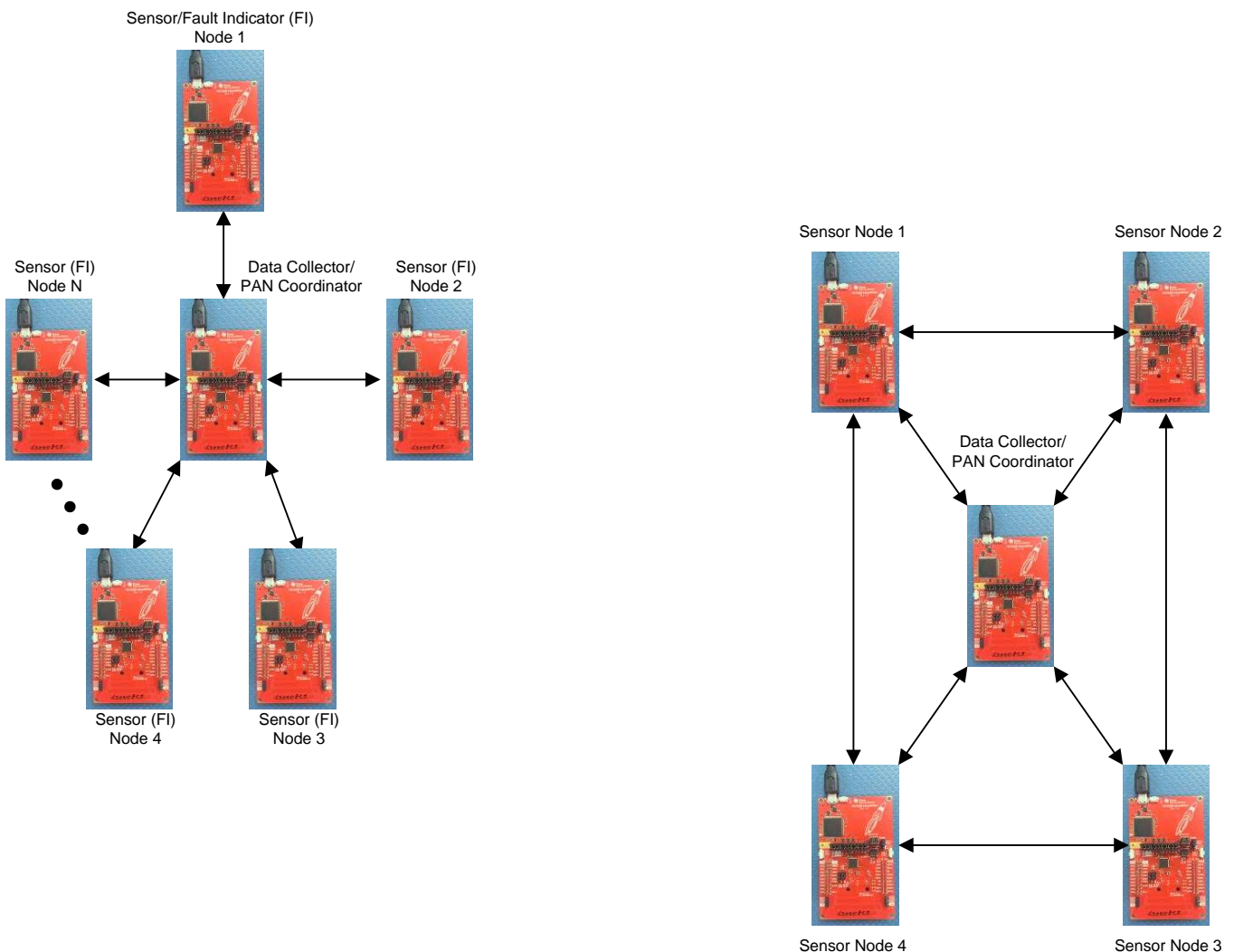
2.4.2.1 PHY Layer

The features of the PHY are activation and deactivation of the radio transceiver, energy detection (ED), link quality indication (LQI), channel selection, CCA, ranging and transmitting as well as receiving packets across the physical medium.

The IEEE 802.15.4 standard lists the multiple responsibilities of the PHY Layer as follows:

- Radio Transceiver Activation and deactivation
- Energy detection (ED) within the current channel
- RX packets LQI (Link Quality Indicator)
- Clear channel assessment (CCA) for carrier sense multiple access with collision avoidance(CSMA-CA)
- Channel frequency selection
- Data transmission and reception
- Precision ranging for ultra-wide band (UWB) PHYs

2.4.2.2 MAC Layer

The MAC sublayer provides two services, as follows:

- MAC data service which enables the transmission and reception of MAC protocol data units (MPDUs) across the PHY data service
- MAC management service: These layers interface to the MAC sublayer management entity (MLME) service access point (SAP) (known as MLME-SAP)

Additionally, the MAC sublayer provides hooks for implementing application-appropriate security mechanisms:

- Beacon management
- Channel access
- GTS management
- Frame validation
- Acknowledged frame delivery
- Association and disassociation

⁽¹⁾ For measuring current consumption on the collector LaunchPad, repeat steps for the jumper settings from the table for the sensor LaunchPad (the DIO2 pin is not grounded for collector).

2.4.3 Modes of Operation

2.4.3.1 Beacon Mode

The IEEE 802.15.4 standard defines beacon-enabled mode of operation where the personal area network (PAN) coordinator device transmits periodic beacons to indicate its presence and allows other devices to perform PAN discovery and synchronization. The beacons provide beacon-related information and also mark the start of the new super-frame. The beacon has information on the super-frame specification, which helps the device intending to join the network to synchronize timing and network related parameters before starting the join process. The beacon helps the existing device in the PAN to maintain the network synchronization. The super-frame is divided into an active and an inactive period. During the active period, devices communicate using the CSMA/CA procedure except in the 863-MHz band where LBT is used for channel access. The inactive period allows the devices in the network to conserve energy.

A network is always started by a fully functional device after performing a MAC sublayer reset. The network operates on a single channel (frequency hopping is not available in this configuration, although frequency agility may be implemented by application-specific means). To select the most optimal channel of operation, the fully functional device (before starting the network) can optionally scan for the channels with the least amount of radio interference by first performing the energy-detect scan to identify the list of channels with the least amount of RF energy. When a list of channels is identified, the fully functional device can (optionally) perform active scan to find the channel with the least number of active networks. When the channel with the least RF energy and lowest number of active networks is selected, the PAN coordinator must set its short address (the PAN identifier) beacon payload and turn on the associate permit flag.

2.4.3.2 Non-Beacon Mode

The IEEE 802.15.4 standard defines the non-beacon mode of network operation where the coordinator does not send out periodic beacons. The non-beacon mode is an asynchronous network mode of operation where the devices communicate by using the CSMA/CA mechanism.

2.4.4 Frame Format

2.4.4.1 Frame Structure

The frame structure has been kept fairly simple and made sufficiently robust to be able to transmit on a noisy channel. The MAC sublayer passes the data frame to the PHY as the PHY service data unit (PSDU), which becomes the PHY Payload. The format of the SHR and PHR is defined for each of the PHYs in their respective clause.

The MHR and MFR are defined in the IEEE 802.15.4 standard.

This standard makes use of Information Elements to exchange formatted data between layers and between devices. An IE is made up of the following :

- Identification
- Length
- IE Content

Devices can accept or discard a particular element if the ID is known, and skip over unknown ID elements



图 3. Schematic View of PDU

2.4.4.2 General MAC Frame Structure

This section shows the general MAC Frame format:

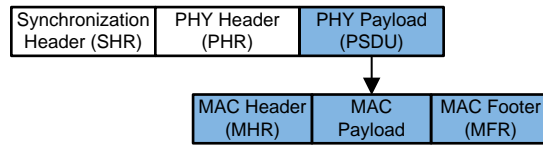

图 4. IEEE 802.15.4 General MAC Frame Format

The parts of each portion of the frame, for instance, MHR may or may not be a part of every frame, but they will always appear in a fixed order as 图 3 shows.

The following sections explain the fields:

- **Frame Control Field**

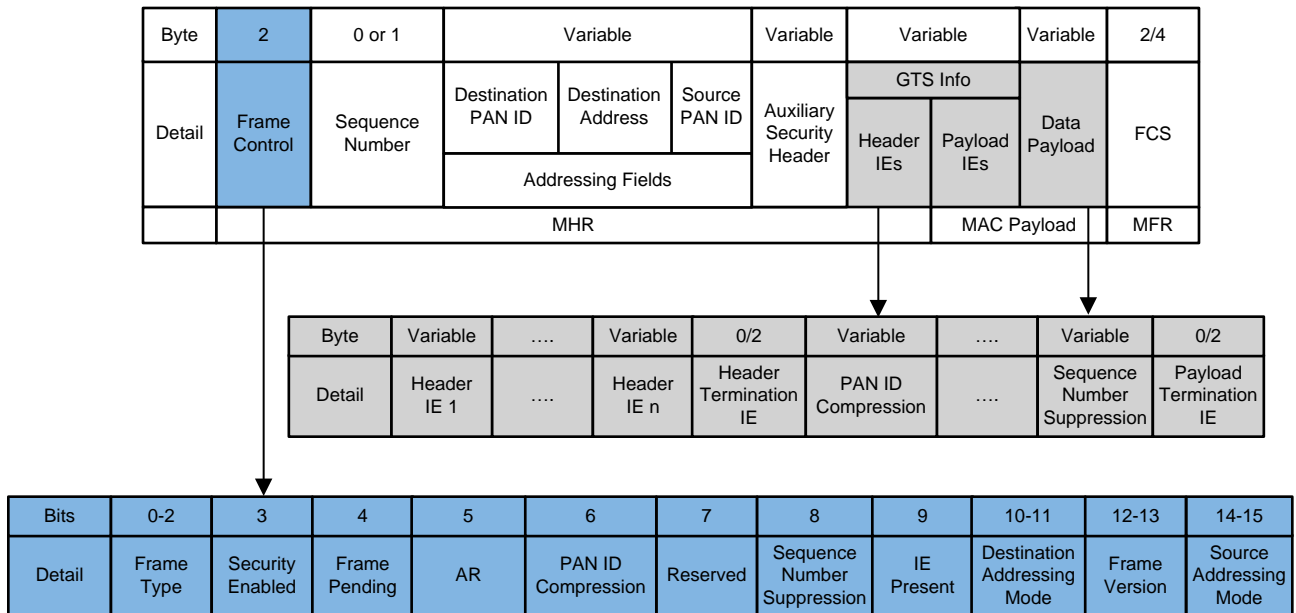
- 表 1 lists the frame type field values and their descriptions.

表 1. Frame Type Field

FRAME TYPE VALUE B2 B1 B0	DESCRIPTION
000	Beacon
001	Data
010	Acknowledgment
011	MAC Command
100	Reserved
101	Multipurpose
110	Fragment, Frak
111	Extended

- *Security Enable Field*: A setting of 1 implies that the frame has protection provided by the MAC sublayer, and also indicates the presence of Auxiliary Security Enable Field.
- *Frame Pending Field*: The field being set means that there is more data pending for the recipient, whereas if not, the field is set to zero. This field is only found in beacon frames and in frames TX in the CAP (devices in a beacon enabled PAN), or in a non-beacon network. At all other times, this field is reset and ignored on reception.
- *AR Field*: This field is the one specifying to the node receiving the frame whether an Ack has to be sent back or not. A value of 0 indicates that an Ack frame TX is not required.
- *PAN ID Compression Field*: used to indicate whether the PAN ID field is present or not. It contains variations based on the frame version that is in use, which can be found in the IEEE 802.15.4 standard. A basic interpretation implies that if both destination and source PAN IDs are present, the MAC sublayer has to perform a check to see that if they are same, the field can be set to 1 and the Source PAN ID will be omitted in this case, and if they are different, both shall be present, and value of the field is 0. In case that only one is present, the value of the field is still 0 and the PAN ID which is present is included in the frame.
- *Sequence Number Suppression*: If this frame is set, it will indicate that the Sequence Number field is suppressed and the field is omitted. If the field is reset, Sequence field is present. The variation in behavior based on frame version is also present in the case of this field
- *IE Present Field*: This field is set if the frame contains Information Elements (IEs), if not, the value is zero. (affected by frame version)
- *Destination Addressing Mode Field*: 表 2 lists the possible values for this field.

表 2. Destination Addressing Mode Values

ADDRESSING MODE VALUE B1 B0	DESCRIPTION
00	PAN ID and address fields absent
01	Reserved
10	Short address (16 bit) present in address field
11	Extended address present in address field

- *Frame Version Field*: This value is in the form of an unsigned integer which specifies the version number belonging to the frame. The table specifying the differences between various frame versions is found as part of the IEEE stack, and is not included here
- *Source Addressing Mode Field*: The values for this field are the same as in 表 2.
- **Sequence Number Field**: The value of this field in a frame specifies the sequence ID for the frame. Beacon Sequence Number (BSN) is the setting for a beacon frame, while Data Sequence Number (DSN) is the setting for all other frames.
- **Destination PAN ID Field**: This field has an unsigned integer value which stores the unique PAN ID of the recipient of the frame. According to the IEEE stack, a value of the broadcast PAN ID shall be accepted as a valid PAN ID by all the devices listening to the channel at that point of time.
- **Source PAN ID Field**: This field has an unsigned integer value which stores the unique PAN ID of the node transmitting the frame. According to the IEEE stack, a value of the broadcast PAN ID shall be accepted as a valid PAN ID by all the devices listening to the channel at that point of time.
- **Source Address Field**: This field specifies the address of the node transmitting the frame. This field depends on the value of the Source Addressing Mode, which has to be a non-zero one for this field to

exist

- **Auxiliary Security Header Field:** All information that is required for a frame to undergo security processing is to be contained in this field, and its existence depends on the value of the Security Enable field being set.
- **IE Field:** This field can contain an information element of variable length. The two subfields, as inferred from 图 4 are as follows:
 - *Header IE:* Follow the Aux. Security Header and are part of the MHR field. They require termination if they are part of the frame
 - *Payload IE:* These come adjacent to the Header IEs, following the MHR portion of the frame and are part of the MAC Payload, meaning that they may be encrypted. Termination is required for a set of Payload IEs
- **Frame Payload Field:** Information which is specific to various frame types (Beacon, Data, Ack and so forth) is contained here. This field may be encrypted if security is enabled.
- **FCS:** As per the IEEE Stack, this field contains a 16 bit ITU-T CRC or a 32 bit CRC equivalent to ANSI X3.66-1979. MHR and MAC Payload are the two parts of the general MAC frame over which FCS is calculated, making the two collectively the calculation field.

Further details are present in the stack documentation.

2.4.4.3 Beacon Superframe

The coordinator defines the format of the superframe which is bounded by beacons sent by the coordinator. The superframe will have an active and an inactive portion, the coordinator is able to switch to low-power mode in the inactive portion of the superframe. The transmission of the beacon frame starts at the beginning of the first slot of every superframe. If a coordinator does not wish to use a superframe structure, it will turn off the beacon transmissions. The beacons are used to synchronize the attached devices, to identify the PAN, and to describe the structure of the superframes.

Any sensor node wishing to communicate during the contention access period (CAP) between two beacons has to compete with other nodes using a slotted CSMA-CA or ALOHA mechanism, as appropriate. For low-latency applications or bandwidth specific applications, the PAN coordinator dedicates portions of the active superframe to that application. These timeslots are called guaranteed time slots (GTSs). The total sum of all GTSs form the contention-free period (CFP), which always appears at the end of the active superframe starting at a slot boundary immediately following the CAP. The PAN coordinator allocates up to seven of these GTSs, and a GTS is allowed to occupy more than one slot period. However, a sufficient portion of the CAP remains for contention-based access of other networked devices or new devices wishing to join the network. All contention-based transactions are completed before the CFP begins. A necessary condition is that each device transmitting in a GTS has to ensure that its transmission is complete before the time of the next GTS or the end of the CFP.



图 5. Beacon Frame Structure

Superframe Structure

A coordinator of a PAN may use a superframe structure, consisting of an active mode and an inactive mode. The coordinator may enter a low power (sleep) mode during the inactive portion. The structure of this superframe is described by the values of macBeaconOrder (BO) and macSuperframeOrder (SO).

The MAC PIB attribute macBeaconOrder describes the interval at which the coordinator shall transmit its Beacon frames. The value of macBeaconOrder and the beacon interval (BI) are related as follows:

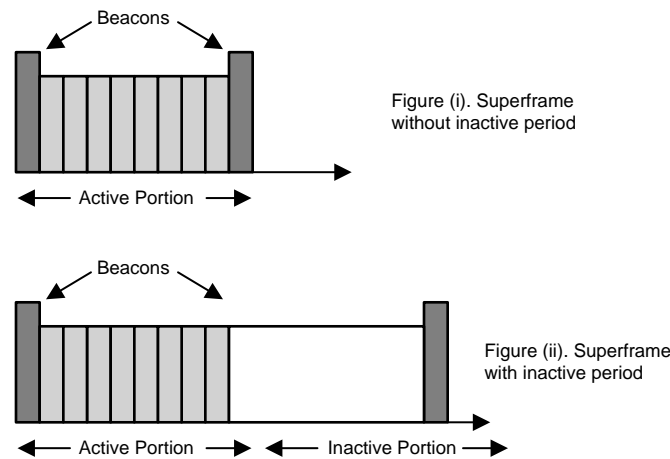
$$BI = aBaseSuperframeDuration \times 2^{\text{macBeaconOrder}} \quad \text{for } 0 < \text{macBeaconOrder} \leq 14 \quad (1)$$

Some special conditions with respect to BO and SO settings follow:

- if BO is set to 15, the beacon frames will only be transmitted by the coordinator when it receives a Beacon Request Command.
- If BO=1, the value of SO is ignored
- If SO = 15, the superframe shall not remain active after the beacon. If macBeaconOrder = 15, the superframe shall not exist (the value of macSuperframeOrder shall be ignored), and macRxOnWhenIdle shall define whether the receiver is enabled during periods of transceiver inactivity.

The MAC PAN Information Base (MAC-PIB) attribute macSuperframeOrder describes the length of the active portion of the superframe, which includes the Beacon frame. The value of macSuperframeOrder, and the superframe duration (SD) are related as follows:

$$SD = aBaseSuperframeDuration \times 2^{\text{macSuperframeOrder}} \quad \text{for } 0 < \text{macSuperframeOrder} \leq \text{macBeaconOrder} \leq 14 \quad (2)$$

For one superframe, the active portion is divided into equally spaced slots of a duration defined in 公式 3:

$$\begin{aligned} \text{Duration of Slots} &= aBaseSlotDuration \times 2^{\text{macSuperframeOrder}} \\ \text{Number of Slots} &= aNumSuperframeSlots \end{aligned} \quad (3)$$

The beacon is transmitted without the use of the CSMA algorithm, at the start of slot 0 (first symbol of PPDU transmitted), immediately followed by the CAP. The CFP follows the CAP, and lasts to the end of the active portion of superframe. All the GTs allocated by the PAN coordinator shall be within the CFP.

The superframe structure shall be used by the PAN if the BO is set to a value between 0 and 14, both inclusive. If BO=15 and SO = 15, the superframe structure shall not be used, which is the case in a Non-beacon enabled PAN, where, the PAN coordinator shall not transmit a beacon until the receipt of a beacon request command, and all transmissions except an Ack frame or the TX after a data request command, will use unslotted CSMA-CA algorithm to access the channel (GTS allocation is not allowed in this mode). 图 7 shows an example of the superframe structure with beacon interval, superframe duration, and CAP and GTSs as part of the CFP.

图 6.



图 7. IEEE 802.15.4 Superframe Structure

Contention Access Period

The *Contention Access Period* commences immediately after the beacon and will be completed before the CFP start on the superframe slot boundary. In case of a zero length CFP, the CAP shall cover the Active period completely. The minimum length of the CAP is termed “aMinCapLength”, and the length can also grow or shrink dynamically to accommodate the size of the CFP. All frames transmitted inside the CAP (except Ack and frames transmitted post a data request) will use the slotted CSMA-CA algorithm to access the channel.

$$\text{Complete transaction for a device transmission in CAP} = \text{data TX (slotted CSMA - CA)} + \text{Ack (minimum length)} + \text{IFS (interframe spacing)} \quad (4)$$

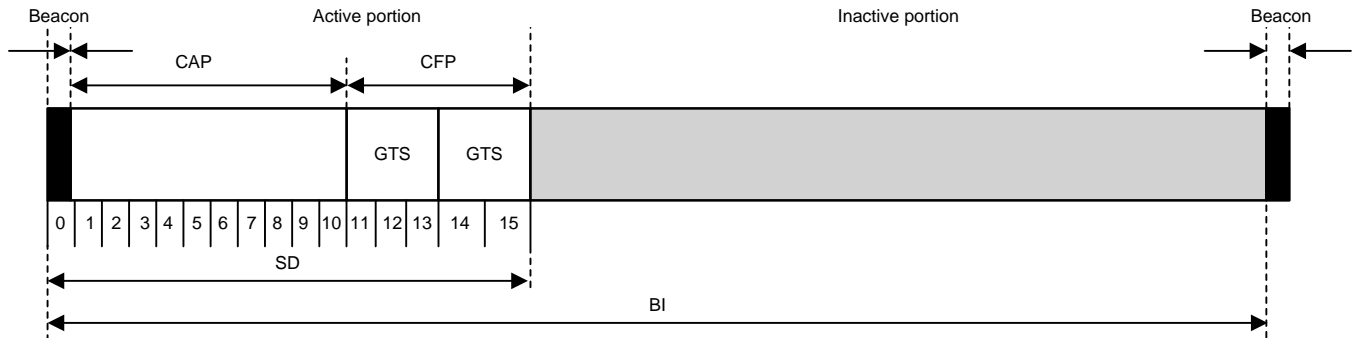
If a device cannot complete the transmission as 图 7 shows, it will defer its TX to the CAP of the next superframe.

Contention Free Period (CFP)

The start of the CFP is marked by the slot boundary immediately after the CAP, and runs till the active portion of the superframe. The GTSs allocated by the PAN Coordinator shall lie within the CFP and have adjacent slots, hence making the duration of the CFP change dynamically based on the combined duration of the allotted GTSs. Transmissions happening in the CFP do not use the CSMA-CA algorithm. Complete transaction for a device transmission in CAP = Data transmit (no CSMA - CA) + Ack + IFS

$$(5)$$

The device must complete its transmission before the end of its GTS.

2.4.4.4 Beacon Frame

图 8 illustrates the Beacon frame format.



图 8. IEEE 802.15.4 Beacon Frame Format

The frame version decides what are the fields that are to be present in the beacon frame. Superframe specification, GTS and the pending address fields are always present. The IE (information element) present field and the Frame control field and their settings depend on the frame version as mentioned previously mentioned.

Beacon Frame MHR Field

The beacon frame MHR has the following fields:

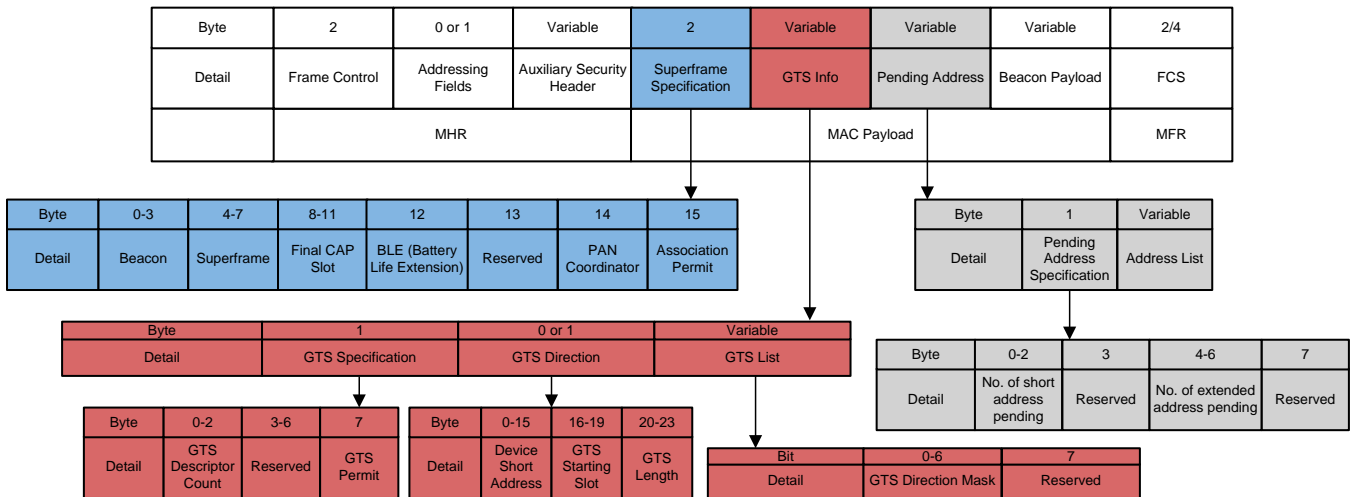
- Frame Type field – indicate beacon frame
- Security Enable – Detect if security is enabled
- Frame Pending – Broadcast frame pending
- If the Frame Version field is not 0b10, all other fields in the Frame Control field shall be set to zero and ignored on reception
- Sequence Number - field shall contain the current value of macBsn if it is a Beacon frame.
- Auxiliary Security Header Field – the beacon frame can be security processed with the information contained here

注: The frame version affects the way the information is reflected in the beacon frame. Details on the frame version are found in the IEEE 802.15.4 standard.

Superframe Specification Field

The format of the superframe specification field is illustrated in the beacon frame structure (see 图 5). The slots that have been explained here are the ones that are specifically important to have a basic understanding of the beacon form of communication between the PAN Coordinator and the FI nodes. For further understanding of the same, kindly refer to the IEEE 802.15.4 standard.

- Beacon Order (BO): The transmission interval or Beacon Interval which specifies the spacing between the transmission of two beacon frames, is specified by Beacon Order.

- Superframe Order (SO): Specifies the part of the BI for which the Superframe is active. The active portion of the beacon defines the time for which the RX of the PAN Coordinator is enabled.
- Final CAP Slot: The last superframe slot that is utilized by the Contention Access Period (CAP).
- The PAN Coordinator field, if set to 1, implies that the beacon has been transmitted by the coordinator and for this reference design, we can assume that this is always the case.
- Association Permit Field: If the value of this field is 1, it means that other devices are allowed to join the network after permission from the PAN Coordinator. A value of 0 implies that no new devices are allowed to join the network, as the coordinator is not accepting joining requests.

GTS Info Field

The GTS Info and the GTS Specification field has been illustrated as part of the beacon frame. The GTS Descriptor Count Field is used to specify how many GTS Descriptor (Length - 3 Byte) are contained in the GTS List part of the frame. In case there is a non-zero value present in this field the size of the CAP shall be adjusted (even to a value below aMinCapLength) to accommodate the increase in the length of the beacon frame owing to inclusion of this field. If the descriptor field value is 0, the GTS Directions and GTS List fields are not part of the Beacon Frame.

GTS Permit Field – A value of 1 indicates that the PAN coordinator is allowing connected nodes to submit requests for GTS slots, else, is set to zero.

The beacon frame diagram also illustrates the GTS Directions field and the GTS mask. The GTS Directions Mask field is used to locate the direction of the GTS in the superframe.

The Bit 0 indicates Direction of first GTS from the GTS List portion of the Beacon, and the rest of the bits follow in the order in which they are added in the list. Every bit that is set to 1 signals a RX-only GTS, whereas a setting of 0 signals a TX-only GTS. The direction of GTS is defined relative to the direction of data frame TX by the node. Its size is defined from the GTS Spec field of the beacon, which also contains a list of the GTS descriptors being maintained. The GTS descriptor format has been illustrated as part of the figure.

GTS Descriptor (shown in [图 8](#)) contains the following elements:

- Device Short Address field contains the short address of the device for which the GTS is being allocated
- GTS Starting Slot: the superframe slot at which the GTS is supposed to start is mentioned here
- GTS Length: Number of adjacent superframe slots covered by the GTS

Pending Address Field

Format the Pending Address field and the Pending Address Specification field as [图 8](#) shows.

The first two bits have the “Number of short addresses pending” field which has the count of the number of short addresses contained in the Beacon’s Address List, whereas the “Number of extended addresses pending” field has the count of the number of extended addresses. The address list field has the address of the nodes that have information that is to be transferred to them from the PAN Coordinator. The limit of seven addresses is applicable to the sum of both short and extended addresses. If the PAN Coordinator has to store a number of addresses more than seven, it shall indicate the same on the beacon frame, and will use a first come first serve basis to ensure that a beacon has maximum seven addresses as per the IEEE 802.15.4 standard.

Beacon Payload Field

The Beacon Payload is an optional field that has a sequence of bytes that can be transmitted as part of the beacon

2.4.4.5 Data Frame

图 9 shows how to format the data frame.

Byte	2	0 or 1	Variable	Variable	Variable		Variable	2/4
Detail	Frame Control	Sequence Number	Addressing Fields	Auxiliary Security Header	GTS Info		Data Payload	FCS
					Header IEs	Payload IEs		
	MHR				MAC Payload		MFR	

图 9. IEEE 802.15.4 Data Frame Format

Data Frame MHR Field

The Frame Control field shall be defines as follows:

- Frame Type: Value that defines frame as data frame
- Security Enable: indicate whether security has been enabled
- All other fields inside frame control field shall be set as decided by the use of the data frame

The Sequence Number field shall contain the value of macDsn. A few settings that vary based on the frame version, details on which can be found in the IEEE 802.15.4 standard

Data Payload Field

This is the field containing bytes of data that are set by the higher layer and can be made part of the data frame transmission.

2.4.4.6 Acknowledgment Frame

The *Acknowledgment frame* (Ack frame) is used to acknowledge a transmission that has been received by the node or the PAN Coordinator in case one was requested by the transmitting node/coordinator. For an Ack frame, if the value in the frame version field is 0b00 or 0b01 signifies that an Imm-Ack (Immediate Acknowledgment) has to be sent for the received transmission. Enhanced Acknowledgment has not been elaborated here. 图 10 shows the format of the Ack frame.

Byte	2	1	2/4
Detail	Frame Control	Sequence Number	FCS
	MHR		MFR

图 10. IEEE 802.15.4 Immediate-Acknowledgment Frame Format

The first scenario where an Ack frame may be required to be sent is the receipt of a Data Request Command to a Coordinator; in which case the coordinator has to send an Ack to acknowledge that the data request has been received. The two possibilities arising in this case are as follows:

- The Coordinator has sufficient time to determine whether there is actually a data frame pending for the device: Value of 1 in the frame pending field in case data is pending and a value of 0 in case the

coordinator does not have any data pending for the corresponding node

- Coordinator does not have sufficient time to check for data: Ack frame is TX with a value of 1 on the Frame Pending field

The second scenario is when a data frame RX or a MAC Command RX is being acknowledged, wherein the frame pending field on the Ack frame has a value of 0.

From the general MAC Frame, the fields other than the frame pending field are all reset in the Imm-Ack frame. The settings for the Enhanced-Acknowledgment frame can be found in the IEEE 802.15.4 standard.

2.4.4.7 IFS and Guard Time

2.4.4.7.1 Interframe Spacing (IFS)

The processing of the data that the PHY layer receives takes a finite amount of time, and to ensure that this time is available to the PHY layer, two adjacent frame transmissions from a node will be separated by one IFS period at minimum. If an ack is required in the first transmission, the separation between Ack frame for the first frame and the second transmission shall be at least one Acknowledgment IFS (AIFS). The length of the IFS is also dependent on the size of the frame transmitted, with frames lesser than a max size, shall have a short IFS (SIFS), whereas frames of length greater than max size defined for SIFS, shall have a long IFS (LIFS).

The following relationship holds to ensure sufficient time for a PHY to transition between TX and RX:
 $AIFS < SIFS < LIFS$ (6)

The CSMA-CA algorithm takes the relationship into account for all TX operations in CAP.

2.4.4.7.2 Guard Time

Guard time is an interval required to prevent collisions between Allowed Transmit intervals, including an SIFS with them between two ATIs. An SIFS separation between two ATIs is a minimum requirement even in case they drift in time. The required time depends on the accuracy of the local clock with respect to ideal time. The reference for a time drift is the start of the preamble of a beacon, and propagation delay is ignored.

$$\text{MaxDrift} = [\text{Clock accuracy}] \times \text{time elapsed since the last synchronizing event} \quad (7)$$

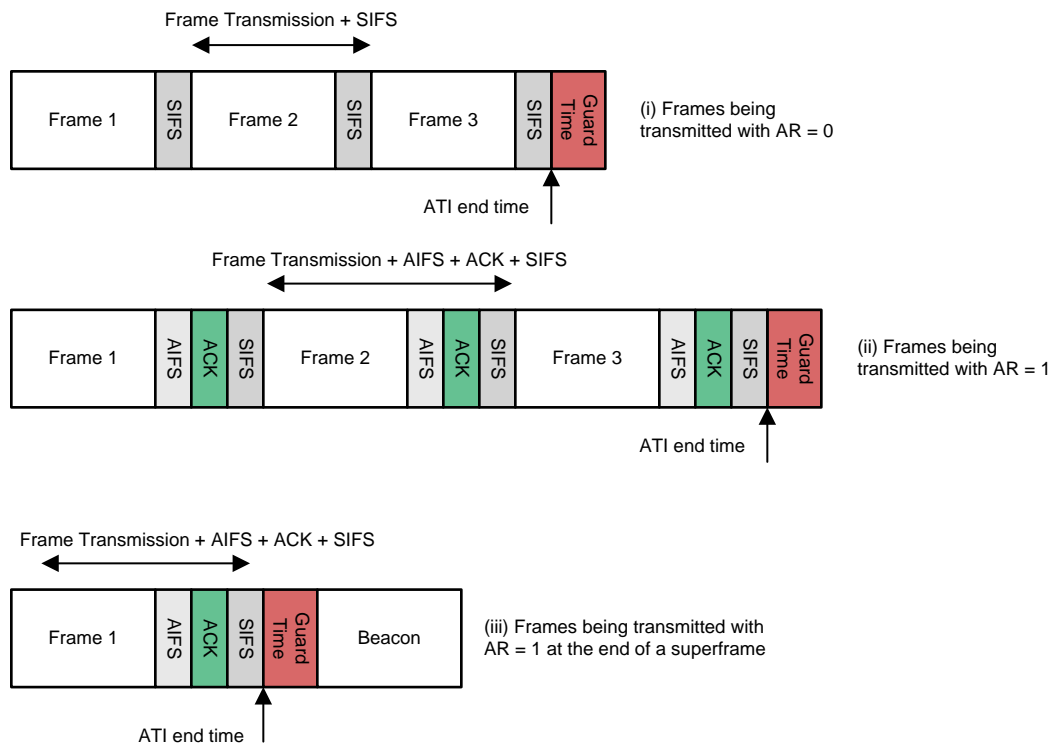

- A No acknowledgment requested; SIFS and guard time interval present
- B Acknowledgment requested for transmitted frame; AIFS, ACK, SIFS and guard time interval present
- C Acknowledgment requested for frame transmitted at the end of beacon superframe

图 11. Frame Transmission

2.4.5 CSMA-CA

The CSMA-CA algorithm is used by a device in the contention access period (CAP) of the Beacon superframe, before the transmission of data or MAC commands transmitted within the CAP. It cannot be used for transmission of beacon frames, Ack frames, or data frames transmitted in the CFP. If the PAN is operating in Beacon Mode, the slotted version of CSMA-CA can be put into use for a device that wants to TX in the CAP. If in Non Beacon Mode or in case that beacon could not be located by the device, the MAC sublayer shall TX using unslotted CSMA-CA. In both cases, CSMA-CA is implemented using backoff periods (units of time, 1 backoff period equals *aUnitBackoffPeriod*, detailed in the IEEE 802.15.4 standard).

For the slotted version, backoff period boundary of each node in the PAN shall be aligned with the superframe slot boundaries of the PAN coordinator, meaning that the start of the first backoff period of each device is aligned with the start of the beacon transmission. In slotted CSMA-CA, the MAC sublayer shall ensure that the PHY commences all of its transmissions on the boundary of a backoff period.

Information on the Non Beacon Mode and unslotted CSMA-CA is found in the TI 15.4 stack documentation and IEEE 802.15.4 standard.

In unslotted CSMA-CA, the backoff periods of one device are not related in time to the backoff periods of any other device in the PAN. Each device shall maintain three variables for each transmission attempt:

- NB- number of times the algorithm had to back off while attempting the current transmission
- CW- Contention Window Length, number of “backoff periods” that need to be clear of channel activity before the transmission can commence
- BE - backoff exponent, which is related to how many backoff periods a device shall wait before attempting to assess a channel

If the algorithm is successful, the MAC sublayer can begin transmission of the frame. If not, channel access failure occurs and the algorithm terminates.

2.4.6 Data Verification (CRC)

A cyclic redundancy check (CRC) is used to detect errors in every Data frame. To protect the serial commands from manipulation or data corruption, a checksum field of 2 bytes is used. This CRC field is computed over the Type and the Data bytes only (SFD and the following two length bytes are excluded).

The formula for the CRC polynomial is:

$$x^{16} + x^{13} + x^{12} + x^{11} + x^{10} + x^8 + x^6 + x^5 + x^2 + 1 \quad (1) \quad (8)$$

The initial value is 0, and the final CRC is complemented. An open source C-code example implementation for such a CRC calculation is found in the firmware of the TIDA-00848, TIDA-01531 or TIDA-01228 reference designs

2.5 Application Scenarios

2.5.1 Personal Area Network (PAN) Setup



图 12. PAN Setup

2.5.1.1 PAN Setup by Collector

Collector, on being powered ON, has to establish the PAN. For this, the initial requirement is the energy scan that it has to perform, which is of two types, first the Passive Scan to detect RF energy, and secondly the Active Scan that has to be performed to check whether the PAN ID of the network is unique and is not in use by any network in its proximity. The sections that follow list the channel scans that must be done by a device.

Channel Scans

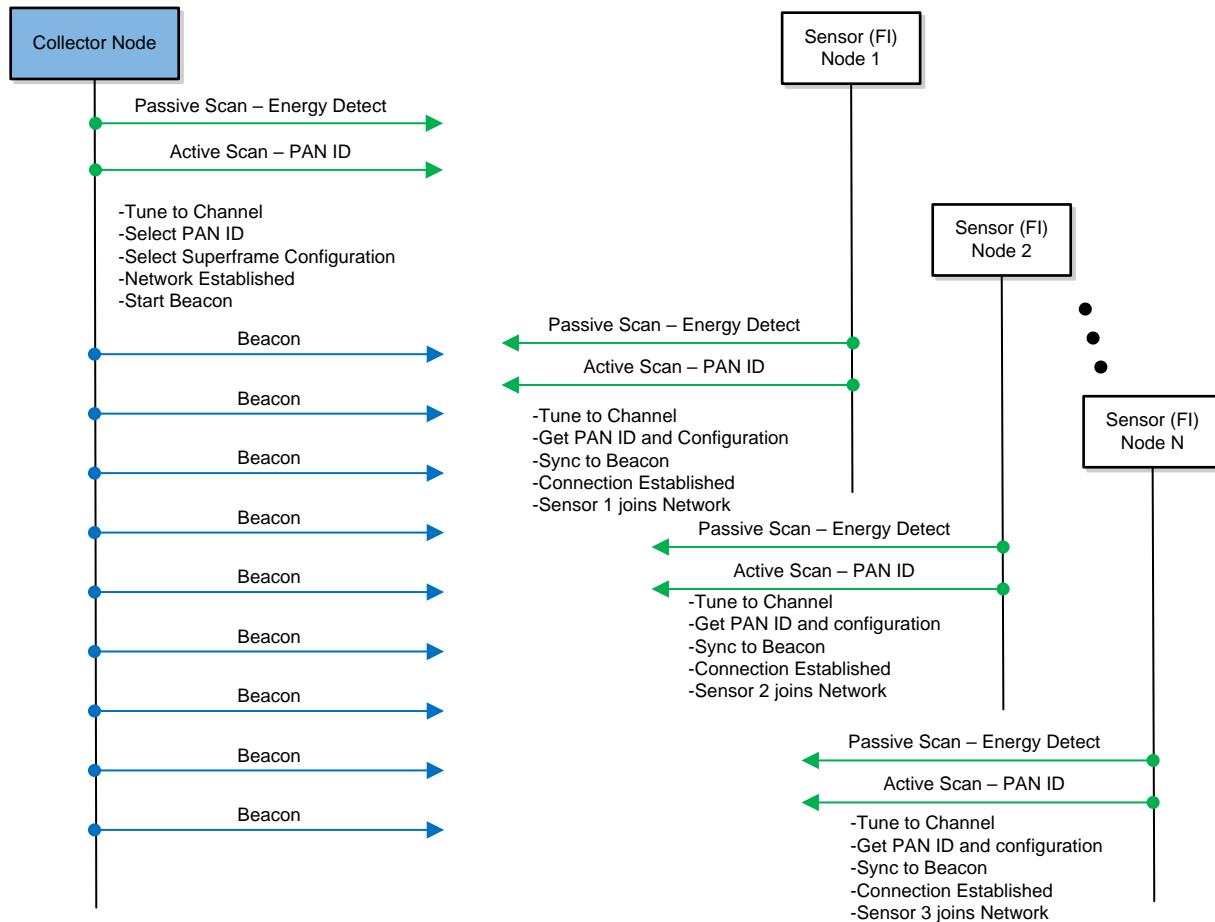
Channel scans that can be performed by the devices are as follows:

- Passive Scan
- Energy Detect Scan
- Active Scan

The device can begin a channel scan once it receives a channel scan instruction. The scanning is performed from the lowest channel number to the highest and as long as the scan is being performed, the device shall be unable to transmit beacons and only be able to receive data frames over the PHY layer which pertains to the channel scan in progress. The beacon transmissions can be started once the scan has been concluded, and the results of the scan have been returned through the corresponding MLME command.

- *ED Scan*: A device can perform an ED Scan to measure the peak level of RF energy in every channel that it has been instructed to scan, the result of which can be utilized by the a prospective PAN Coordinator to select a channel to operate the PAN on. A device can store at minimum one channel ED measurement. The ED channel scan shall end when either all the channels in the band have been scanned or the specified number of channels requested to be scanned is met.
- *Active Scan and Passive Scan*: The previously-mentioned scans allow a device to search its RF range and locate a PAN coordinator (transmitting beacons). The main difference between an active scan and a passive scan is based on the transmission of a Beacon Request command, which happens in an active scan while is omitted in a passive scan. The beacon request command is used by node to extract the beacon from the PAN coordinator, which is ignored in a beacon enabled network. The device shall enable its receiver for a specified period of time to capture the RF energy, and reject all received frames that are not beacon frames. The information from every unique beacon frame (containing a PAN ID and a source address that the device has not received before) that a device receives is stored in the PAN descriptor structure including the channel information, and every node can store one PAN descriptor at minimum. The beacon information is transferred to the higher layer. For a protected beacon frame, the node will unsecure the beacon and record the beacon even if the process results in an error.

Starting a PAN

A reset of the MAC sublayer is a prerequisite for starting a PAN, along with the appropriate channel scans having been performed. The network can only be established by a FFD. Once the appropriate commands have been received by the MAC sublayer, it will update the superframe configuration along with the channel parameters and issue the command for starting the network, after confirming a status of success to the higher layer.

The realignment of a PAN can be referred to from the IEEE 802.15.4 standard.

After completing the scan and identifying the channel on which the network is to function and the selecting the superframe configuration, the PAN Coordinator can tune to the specific channel and the network is started

2.5.1.2 Sensor (FPI) Association to PAN

A sensor (FPI) device on being powered ON and has to join the PAN started by the PAN Coordinator in its RF range. The procedure for the sensor to join the network is quite similar to the PAN Coordinator, where it performs an Energy Detect Scan to check for RF energy and then an active scan to find the channel on which the corresponding PAN has been started.

If beacon tracking has been enabled on the respective sensor node, it will synchronize to the beacon and send a joining request to the PAN Coordinator/Collector, and if approved by the Collector, the sensor (FPI) node can join the network.

After joining the network, as the PAN is in beacon enabled mode, the sensor will go into sleep mode and wake up just before the beacon is to be received. In case there is intimation from the PAN Coordinator that there is data pending for the particular sensor node, then it will send a data request command to RX the data. If, on the other hand, there is data from the Sensor that has to be transmitted to the PAN coordinator, the node can wake up and send that data since the collector has its receiver always ON. These have been elaborated in the following sections:

Sensor (FPI) Association and Dissociation Procedure

Association to a network can be performed by a device in the RF range of the PAN coordinator. It can be started once the MAC Sublayer reset has been performed on the respective device, after which it has to scan the channel (Active or Passive Scan). The results of the scanning process will be used to choose the PAN from the list of PAN descriptors available for the device. Once the PAN has been selected, the MLME (MAC Sublayer) configures the parameters of the PHY and MAC PIB attributes to the values required for association:

- Channel Number
- Channel Page
- PAN ID
- Coordinator extended address/Short address (extracted from beacon)

The Pan coordinator should be having association permit set to ON for any device to be able to associate with its network. A device that is instructed to perform PAN association shall in no way attempt to start its own PAN. The MAC sublayer of the device who wants to associate with the PAN sends an Association Request Command to the coordinator of the PAN, with a notification to higher layer in case the request cannot be sent due to channel issues. There are two steps for the coordinator to respond to the device from which the association request has been received:

- Acknowledge Association request: simply an acknowledgment of request reception and in no way is a successful association
- Association Response Command: The check to be performed at the coordinator level is whether the resources allow the association of the respective device, and it is to be performed in a specific time (macResponseWaitTime). If the answer to the previous question is affirmative, the higher layer will allocate a unique (within PAN) short address to the requesting device, and the MAC sublayer of the coordinator sends an Association Response Command which shall be added to the list of pending messages on the beacon and can be extracted from the same by the requesting device (which will be tracking the beacon)

A special case where a device is allocated a generic short address (0xffff), means that the device has been allowed to join the network but will use its extended address to communicate.

Once the Acknowledgment has been received by the requesting device, it has to wait for a specific time for the response from the coordinator, and if it does not receive the same, it will deem the transaction as failure and terminate tracking the beacon. If a successful association response is received, the short address contained is stored by the device.

2.5.2 Beacon Transmission and Reception

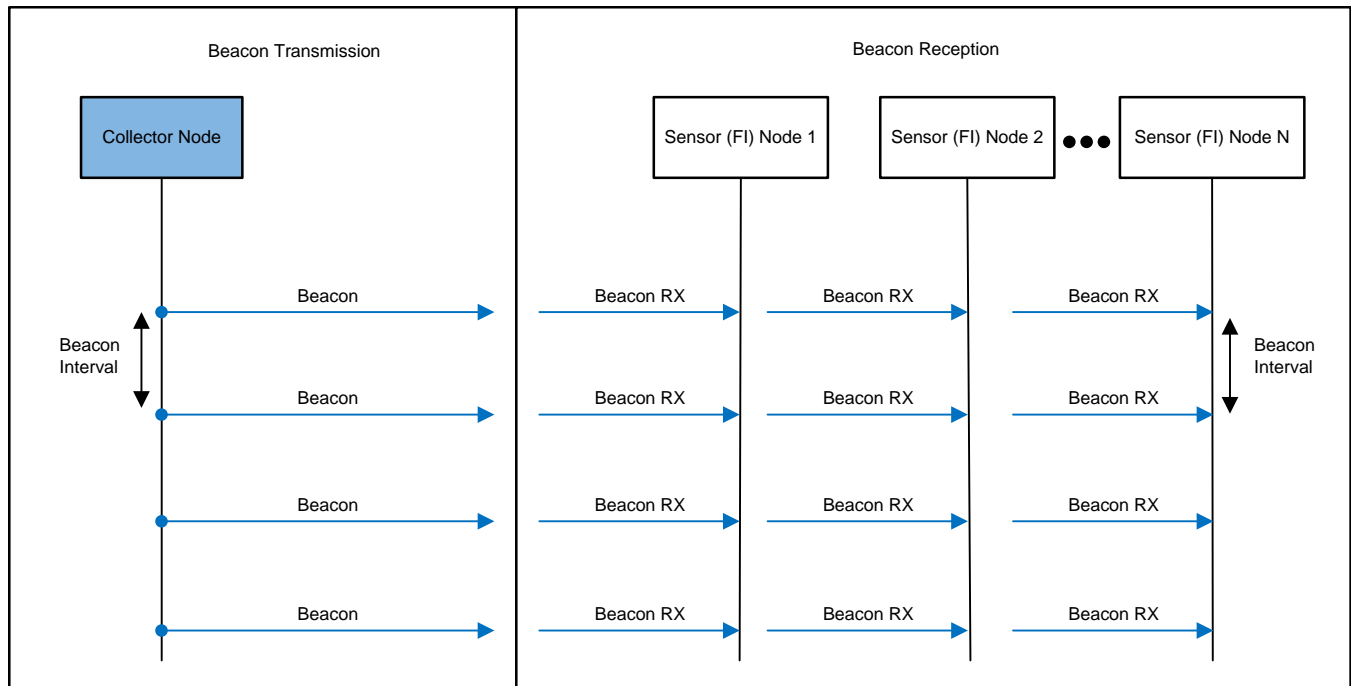

All Sensor (FI) nodes connected to the PAN will track the beacon and enable RX just before the start of the Beacon.

Each Sensor node receives the Beacon Frame and checks whether the beacon has its address in the pending message queue to ensure that it gets the aforementioned data from the collector. If its address is present, a data request is initiated to the collector to obtain the information

图 13. Beacon Transmission (Collector Node) and Reception (FPI Sensor Node)

The PAN coordinator can indicate its presence on a PAN to other devices by transmitting Beacon frames. For networks with Beacon mode enabled, synchronization to the network is performed by receiving and decoding the Beacon frames. Beacons can only be transmitted from an FFD and the primary condition for it to happen is the value of beacon order (BO) being less than 15. The device being the PAN Coordinator, as soon as the command is received, will start transmitting beacons immediately. A device can also lose synchronization with the PAN coordinator in case it fails to receive a pre-defined number of beacons from the coordinator (aMaxLostBeacons), which will have to then be communicated to the higher layer. The extended address or the short address of the PAN coordinator will be used as source address included as part of the beacon frame transmission. A short address of a device not being equal to 0xffff is a condition for a device to be able to transmit beacons. A beacon frame transmission happens at the start of the superframe as 图 13 shows.

The differentiating feature of the beacon mode of communication is the broadcast of the beacon to all the sensor nodes that are connected to the PAN, thereby preventing the tedious task of the collector having to individually communicate to every sensor node that it is connected to.

All the devices in the network can RX the beacon at the same time thereby ensuring that information about the network is reaching all nodes at the same time.

Sensor (FPI) node Synchronization with Beacon

The beacon frames generated by the PAN coordinator provide a way for the nodes on the network to synchronize with the coordinator, and they can be received and decoded by the sensor node. All nodes that are connected to a beacon-enabled PAN (having a value of beacon order < 15) shall be able to acquire beacon synchronization so that they can detect messages that are pending on the coordinator and track the beacon. A node can synchronize to a beacon that comes only from its network (having the same PAN ID). If tracking of beacon is activated, that means that the device will get the beacon and also track it by activating its receiver (RX) in a specific and regular manner, and search for a defined time and if the beacon is not received in this time, the search will be repeated for a specific number of iterations (aMaxLostBeacons) before notifying the higher layer of the same. If a beacon frame received by the device has a source ID and source address that does not match with the PAN ID and coordinator short/extended address, the frame shall be discarded. If the node is tracking beacons (which will be the case with this reference design), the node will enable its receiver just before the starting of the next superframe, doing so with the help of a timer which expires just prior to the starting of the next superframe.

2.5.3 Regular Data Report From Sensor (FPI) to Collector



图 14. Status Report From Sensor (FPI) to Collector

The sensor (FPI) has to report data to the collector and this communication has to repeat after a definite amount of time, which is termed as reporting interval, and can be modified by the PAN coordinator. This reporting of data happens in between the beacon interval where the sensor wakes up and transmits pre-specified data to the coordinator, and the coordinator has to acknowledge the correct reception of the data frame from the sensor.

This report from the Sensor can be utilized for fault indicators in a no-fault scenario where in the interest of saving the huge power consumed by a transmission from the FI device, as it can wake up once every few minutes and transmit health data along with for instance, average voltage and current from the last transmission, and in this way the collector can easily keep a track of all the sensor (FPI) nodes that are connected to it (collector is assumed to have more power at its disposal, such as a dedicated solar panel) and the sensor nodes do not have to be ON for more time than is essentially required, helping reduce the overall power consumption at the sensor node, and increasing its life.

2.5.4 Data Exchange Between Sensor (FPI) and Collector

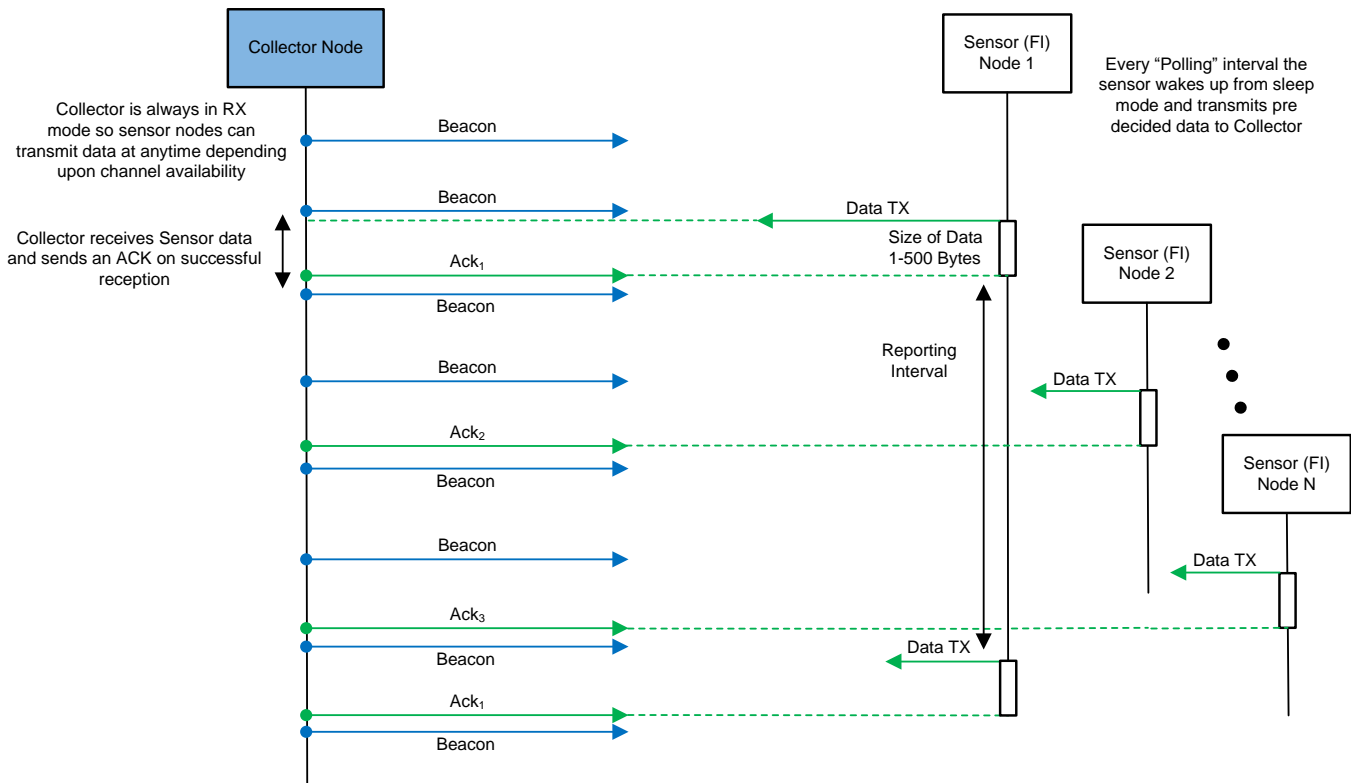

图 15. Data Exchange Between Sensor and Collector

2.5.4.1 Transmission Procedure for a Device in a PAN

If a frame is to be transmitted on a beacon enabled PAN, the device will track the beacon before transmitting, which will be the case with the reference design in focus. The beacon is found and the frame may be transmitted in the appropriate portion of the beacon superframe, for instance, Transmissions in the CAP shall follow a successful application of the slotted version of the CSMA-CA algorithm. If the beacon is not found after a pre-defined time, the frame will be transmitted using an unslotted CSMA algorithm. If the frame is to be a direct transmission (without data request), and it fails to send, the higher layer will get a notification from the MAC sublayer. On the other hand, for an indirect transmission (with data request from nodes), a frame that failed to send will remain a part of the queue until requested for again. Additionally, security features may be performed on the outgoing frame, and once completed, the frame may be transmitted.

Every device shall have a randomly assigned DSN value which is copied into the MHR of the frame and then incremented by one. Only one DSN is generated irrespective of the number of devices it has to communicate with.

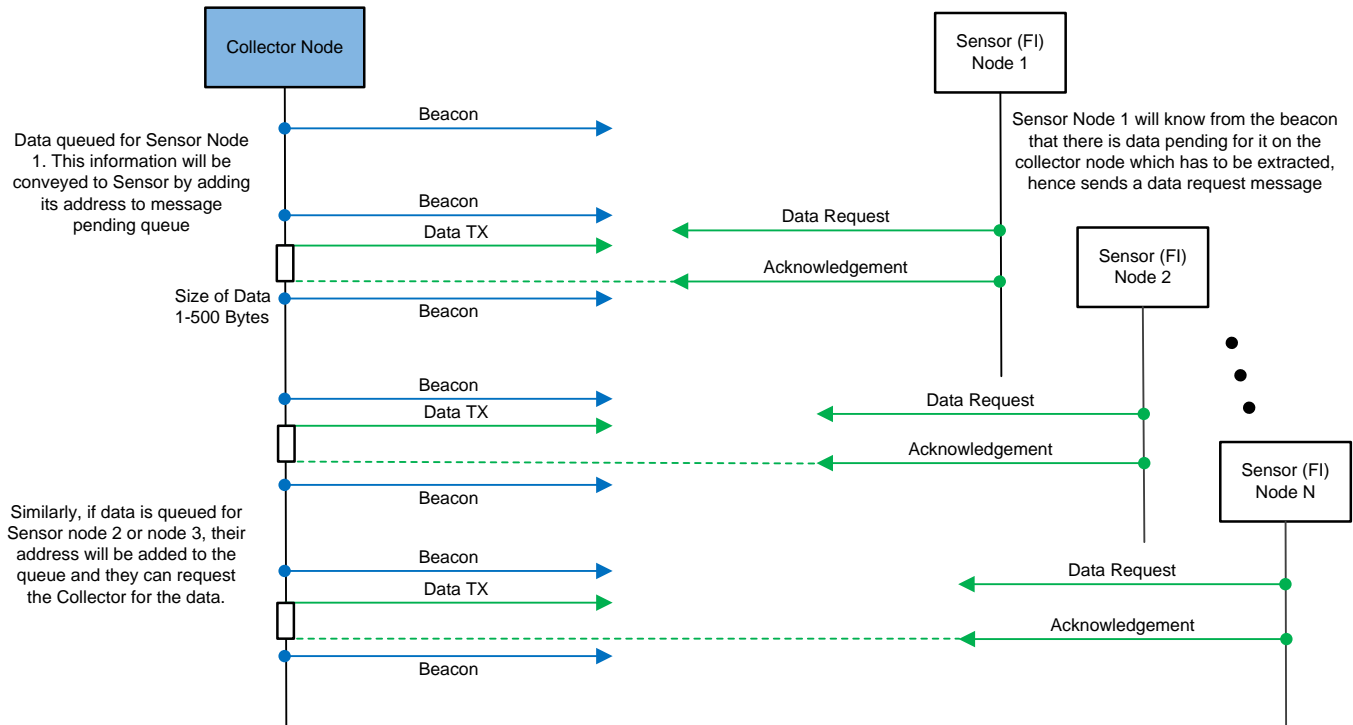
The coordinator will store its current BSN value, and initialize it to a random number. Each generated beacon has this value stored in its MHR which is incremented by one after the transmission.

The use of these 8 bit values for the higher layer is for instance, in detecting retransmitted frames.

The other fields can be as follows:

- Source Address: contain sender device address; preferably the short address in case the device has associated to a network, otherwise the extended address is used for all communication. In case not present, it will assumed to be a reduced function device or the PAN Coordinator
- Destination Address: recipient address, maybe either a short address or an extended address. In case the field is not present, it is assumed the frame is intended for the PAN coordinator/Collector
- PAN ID fields: Set as required

2.5.4.2 Reception and Rejection by a Device in a PAN

During idle periods for the RF radio, the PHY may still receive a task from the higher layer, for instance a TX request (with or without Ack request), or an RX request. On completion of each transceiver task, the MAC sublayer will send a request to the PHY service to enable or disable its receiver. For a beacon-enabled network like this reference design, the RX on request is only considered relevant during the idle periods of the CAP of the incoming superframe.

Owing to the nature of RF communication, a device having switched ON its receiver will be able to receive and decode transmissions from all devices complying with the IEEE 802.15.4 standard and operating on the same channel in the RF range of the device, along with interference from all other sources, and from this, the MAC sublayer will have to filter incoming frames and forward to the higher layer only relevant frames. The first level check for any frame is the FCS which will be recalculated over the MAC payload and the MHR of the incoming frame and comparing the value with the FCS field and deeming it correct if the values match and vice versa. The second check is the promiscuous mode, in which case, no filtering is done and all received frames are passed as it is to the higher layer. The third check is the fact of a scan being in progress, in which case only relevant beacon frames received will be processed, while the others discarded. If all of these checks are passed, the pass requirements for the fourth level check (as per IEEE 802.15.4-2015 standard) are as follows:

- Frame type should not be “reserved”
- Frame version should not be “reserved”
- If destination PAN ID present, should be equal to the macPANID or the broadcast PAN ID
- Destination address should satisfy one of the following requirements:
 - Destination short or extended address should match the device
 - If device is PAN coordinator, only source address is included and destination PAN ID = macPANID
 - Other conditions can be referred from *IEEE 802.15.4 standard*
- If beacon frame is received, source PAN ID = macPANID

If the fourth check is not passed, the frame is discarded.

If a frame that is not a beacon frame is received and the AR field if the superframe is set to request an acknowledgment, then the MAC sublayer shall send an Imm-Ack frame with the same DSN that was stored in the received frame, which makes sure that the sender knows that the right acknowledgment has been sent.

In case the received frame is a secured frame, the MAC sublayer will unsecure using due process before forwarding to higher layer.

2.5.4.3 Acknowledgment of Transmissions in a PAN

No Acknowledgment

If the AR field of a frame is reset, that means that the sender does not require an acknowledgment for the data that it has sent. Hence, no Imm-Ack frame is transmitted from the receiver. Also, after the frame is transmitted from the originating device, it assumes the transmission was successful.

Acknowledgment required

If the AR field of a frame received at the device is SET, the sender of the frame has requested an acknowledgment from the recipient. Hence, the recipient shall generate and send an Imm-Ack frame to the originator (Enh-Ack frame not discussed as part of the reference design). The transmission of the Ack frame shall happen an AIFS (pre-defined value) after the last symbol of the data frame has been received.

2.5.4.4 Re-Transmission of a Frame in a PAN

As per the IEEE 802.15.4 standard, a retransmission procedure will never be performed by a device that did not request an Ack from the recipient as it assumes the transmission to be successful. However, if a device requested an acknowledgment and (a) does not receive one in pre-defined time or (b) receives an Ack with the wrong DSN number, the device will infer a failed transmission for that particular single transmission attempt.

If a single transmission attempt has failed and the transmission was indirect, the coordinator shall not retransmit the frame. Instead, the frame shall remain in the transaction queue of the coordinator and can only be extracted following the reception of a new Data Request command. If a new Data Request command is received, the originating device shall transmit the frame using the same DSN as was used in the original transmission. If the same happens in case of direct transmission, the process of transmission of the frame and the wait for the Ack shall be redone up to a certain fixed number of iterations with the same DSN as the original message, and will be completed within the same portion of the superframe (CAP/GTS), failing which, the TX will be deferred until the next superframe. If after the fixed number of transmissions, the Ack is still not received from the recipient of the frame, the MAC sublayer assumes failed transmission and the higher layer is notified.

Also, if the frame that failed to send had security enabled, it will be retransmitted without changes and will not pass through the security procedure again.

2.5.4.5 Extraction of Pending Data From Coordinator

The IEEE specification says that a device in a beacon enabled network, in the case of this reference design the sensor (FPI) node, can check for pending frames by examination of the received beacon frame, by looking for its own address in the Address list of the beacon. If the MAC sublayer of the coordinator/Data collector allows the sensor (FPI) node to send a data request automatically, the FI will send the data request command to the data collector/PAN coordinator during the Contention Access Period (CAP) of the superframe, with the AR field of the Data Request command set (Ack requested). Since the frame would be meant for the PAN coordinator, destination address info may be omitted.

The coordinator shall send an Ack on successful reception of the data request command. If there is sufficient time available at the coordinator to process the data request command, it will check whether it actually has data pending for the particular sensor (FPI) node, and indicate the same in the Frame Pending field of the Acknowledgment. If the time is not sufficient, the frame pending field will be set to one.

On receiving an Ack frame from the coordinator, with Frame Pending field set to one, the FI node will enable the receiver to RX the data from the data collector. In case there is no data pending, the collector will send a zero length payload without an Ack request which indicates absence of data. If the data is available for the particular FI node, the collector can send the data with or without the use of CSMA-CA algorithm, depending on the portion of the superframe in which the data is being transmitted.

For the requesting FI node, in case the data is not received in specified time or the data is received with zero length payload, it will conclude that there is no data pending on the coordinator. If it does, receive the data, it will send an acknowledgment of the same. If the Frame Pending field of the received frame is one, it means that there is more data pending on the coordinator for that FI node, for which a new data request will have to be sent.

2.5.4.6 Transaction Handling in a PAN

The IEEE standard focuses on very low cost devices, which mostly will be power critical, in this instance the overhead FI nodes as discussed in this reference design. Hence, there are two ways of communication provided for such networks:

- Collector indicates in its beacon that there is data pending for a particular FPI node
- The FPI node polls the Data collector for data

This is termed as an indirect data transmission. A transaction consists of the information contained in the indirect transmission request, at least one of which can be stored at the coordinator. In case more than one transaction are being stored at the collector, the order in which they arrive at the MAC sublayer is the order in which they will be sent to the respective FI nodes. If some data exists for a particular sensor (FPI) node at the collector and is not extracted within a specified time, it is discarded and the expiry of the transmission is indicated to the higher layer, whereas an Ack is received (if AR=1 for the outgoing frame) if the data was successfully received at the intended recipient. The transaction information is discarded and the success of the transmission is indicated to the higher layer.

For GTS transactions, the data collector/PAN coordinator shall only transmit the data in the GTS of the recipient. If there is a pending transaction for the broadcast address, the beacon frame pending field will be set to one so that the FI nodes can enable receiver even after the beacon frame to RX the message sent using the CSMA-CA protocol. If a second message is present, it will be delayed until the next superframe.

2.5.4.7 Transmission Scenarios in a PAN

The radio medium is not a perfect medium and owing to this a transmitted frame may not always reach its intended recipient. The three scenarios elaborated in the IEEE 802.15.4 standard are summarized in the following sections:

Successful data transmission:

- Sender MAC sublayer uses PHY to TX data frame
- Recipient MAC sublayer receives frame, and sends Ack (if AR=1). Data Frame passed to next layer

- Sender MAC receives Ack (within stipulated time). Next layer notified of successful transmission
- Data Transfer complete
- The originator MAC sublayer transmits the Data frame to the recipient

Lost Data frame:

- Sender MAC sublayer uses PHY to TX data frame
- Recipient MAC does not receive frame. No Ack sent
- Sender MAC does not receive Ack in stipulated time. Data Transfer failed
- For direct transmission, steps 1-2 repeated for fixed number of times, which if exceeded with Ack still not received, indication of failure given to higher layer.
- For indirect transmission, data remains in queue until (a) another data request received, or (b) transaction persistence time expires, after which frame is discarded with failure indication to higher layer

Lost Ack frame:

- Sender MAC sublayer uses PHY to TX data frame
- Recipient MAC sublayer receives frame, and sends Ack (if AR=1). Data Frame passed to next layer
- Sender MAC does not receive Ack in stipulated time. Data Transfer failed
- For direct transmission, steps 1-2 repeated for fixed number of times, which if exceeded with Ack still not received, indication of failure given to higher layer.

For indirect transmission, data remains in queue until (a) another data request received and correctly acknowledged, or (b) transaction persistence time expires, after which frame is discarded with failure indication to higher layer

2.5.4.8 Timing Restrictions for Transmission in a PAN

In beacon-enabled networks, the IEEE 802.15.4 standard mentions that certain times may be allocated to devices for transmission, referred to as the allowed transmission interval (ATI). Examples of these include the following:

- Guaranteed Time Slot (GTS): GTS Info field defines start and end time of the GTS as part of the beacon
- Beacon transmission: In a beacon enabled PAN, Superframe duration defines start and end time for the beacon

Frame transmission and the respective Ack frames need to be completed at least one SIFS before ATI end. As per the IEEE spec, A SIFS is required prior to the end of the ATI for the device transmitting or receiving the final frame to switch to receiving or transmitting, respectively, in the event that the device is required to switch

Guard time also has to be accounted for by the devices as explained in the previous sections while calculating the end of ATI. The following rules are specified in the specification:

- Frames with AR=0: Sender will not TX unless available time is greater than the frame TX time plus SIFS
- Frames with AR=1: Sender will not TX unless available time is greater than the added time duration of the following:
 - Frame TX time

- AIFS
- Minimum duration Ack frame (Imm-Ack, as Enh-Ack has not been discussed here)
- SIFS

2.5.5 Fault Identification and Communication



图 16. Fault Detection and Fault Information Broadcast

In this scenario, the trigger of communication between the sensor nodes and the data collector is the detection of fault at any one of the nodes that are part of the network. This detection happens at the fault indicator which then has to notify the Collector node, which is made possible by the assumption that the data collector/PAN coordinator node is not power critical and hence can have its RF receiver switched On at all times, enabling the fault indicator nodes to be able to communicate with it at any given time. The Sensor (FPI) node which detects the fault will send a message to the collector node of the same. This message shall be processed by the collector node, which now has to communicate the fault information (fault detection and fault cycle/time) to all the other nodes so that they can save the requisite data cycles. This happens on the beacon that immediately follows the notification of the fault to the collector node.

Once the broadcast beacon is received by the sensor (FPI) nodes, they will take the necessary action to store the cycles of data surrounding the fault cycle as specified by the collector, and wait for a specific GTS or CAP to transmit the data to the collector. Since there is slight flexibility available in the time data from all the sensor (FPI) nodes is to converge at the data collector, the data can be sent as multiple packets and over multiple superframes.

3 Hardware, Software, Testing Requirements, and Test Results

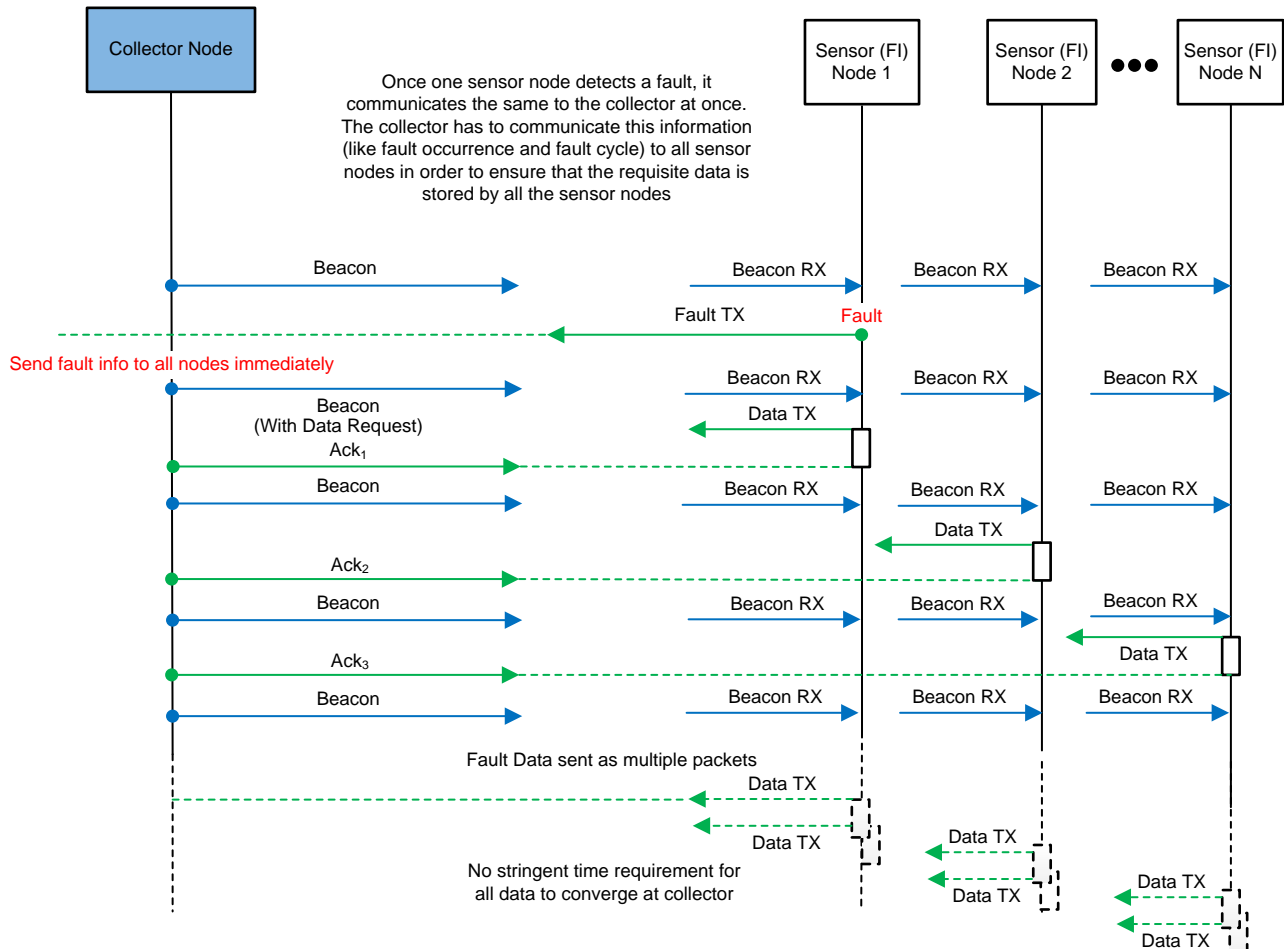
3.1 Hardware

表 3 lists the hardware for this reference design:

表 3. TIDA-00816 Hardware

PART NUMBER	QUANTITY	DESCRIPTION
Launchxl-CC1310	2	1 for sensor application and 1 for collector application
IMETER BOOST	1	Used in this reference design for measuring current consumption
CC3200- Launchxl	1	Used in this reference design for interface to IMETER BOOST for displaying measured current

3.2 Software

表 4 shows the software for this reference design.

表 4. TIDA-00816 Software

SOFTWARE	DESCRIPTION
SimpleLink CC1310 SDK	Software Development Kit for the CC1310 device
TI Resource Explorer Online	Access to training and documentation for this reference design
IMETER BOOST binary file (used for this reference)	IMETER BOOST binary file
SimpleLink CC3200 SDK	Software Development Kit for CC3200

3.3 Test Setup and Procedure

3.3.1 Initial Setup for Testing Sub-1 GHz Communication

Requirement: 2 LaunchXL-CC1310 LaunchPads

Setup:: Complete the following steps for the initial setup:

- Step 1. Send and receive packets with SmartRF™ Studio
- Step 2. Import and run an existing TX example with Code Composer Studio™
- Step 3. Export RF settings from SmartRF Studio to the Code Composer Studio example application
- Step 4. Send data from firmware, receive it using SmartRF Studio
- Step 5. Import and modify an existing RX example with Code Composer Studio
- Step 6. Send data from SmartRF Studio and receive it with the firmware
- Step 7. Test two LaunchPads with the flashed TX and RX firmware

The prerequisites (background and software requirements) are found as part of the *TI SimpleLink Academy* in the following link:

[Simple Link Academy - Basic RF Test](#)

See 表 5 for testing RF communication between two LaunchPads:

表 5. RF Communication Between two LaunchPads

LaunchPad™	JUMPER SETTING	DESCRIPTION
Sensor	5-V USB	Power Supply to Sensor
Collector	5-V USB	Power Supply to Collector

At the end of this exercise, the two CC1310 LaunchPads should be able to communicate with each other in one of the two ways, either through SmartRF Studio or Code Composer Studio .

3.3.2 Setup for Testing Sensor and Collector Configuration

Requirement: 2 LaunchXL-CC1310 LaunchPads

The steps to be performed for the Collector and Sensor setup in separate LaunchPads are as follows:

- Step 1. Building and loading the collector example.
- Step 2. Building and loading the sensor example.
- Step 3. Using the Collector and Sensor:-
 1. Build Sensor project
 2. Debug (Run) Sensor project to load the Sensor LaunchPad
 3. Build Collector project
 4. Debug (Run) Collector project to load the Collector LaunchPad
 5. Reset both LaunchPads
 6. Once PAN is started by collector (Red LED ON), press SW2 to allow joining (Blinking Red LED)
 7. Sensor joining the PAN is indicated by red LED turning “ON” on the sensor LaunchPad

At the end of Step 3, the previously mentioned indications reflect that the LaunchPads are loaded correctly.

注: These steps are to be repeated to implement any configuration change (elaborated in the following sections) that is made in the SDK to reflect on the LaunchPad.

The prerequisites (hardware, software, and background) and detailed procedure settings are found as part of the *TI SimpleLink Academy* in the following link: [SimpleLink Academy Link for Sensor and Collector configuration and implementation](#).

3.3.3 Setup for Measuring Current Consumption

Requirement:

- 2 LaunchXL-CC1310 launch pads
- IMETER BOOST (for measuring current consumption)
- CC3200-LaunchXL (for transmitting current graphs to Laptop GUI)



图 17. TIDA-00816 Test Setup for Current Measurement

See 表 6 for details on the setup for current measurement:

表 6. Current Measurement Setup

LaunchPad™	JUMPER SETTING	DESCRIPTION
1. Sensor	3.3V pin: Connect to Vin- from IMETER GND pin: Power Supply Ground: Sensor GND pin (shown in 图 17)	Power supply to sensor through IMETER Board
	DIO2 pin: Ground	RX pin on the sensor needs to be grounded (only for sensor)
	All jumpers to be removed: • SW0 to GND • Jumpers for LED DIO6 and DIO7 • VSENSE jumper	To make sure only the device consumes power on the board
2. Collector ⁽¹⁾	5V USB	Power supply to the collector
3. IMETER BOOST	Vin+ : Connect 3.8-V power supply	From power supply
	Vin- : Connect to 3.3-V pin on sensor	
	VBUS : Open	
	GND : Connect to GND pin on sensor	
4. CC3200	5V USB	Power supply for CC3200

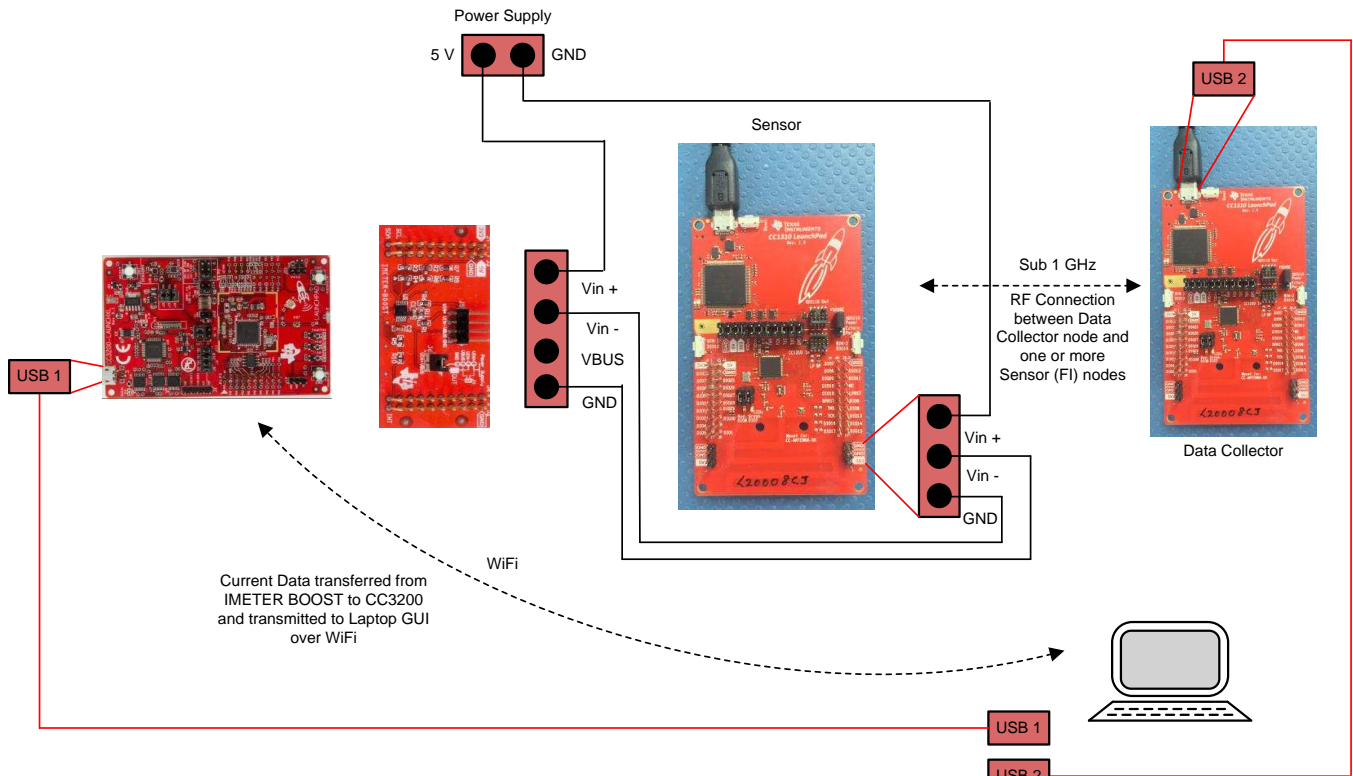
⁽¹⁾ For measuring current consumption on the collector LaunchPad, repeat steps for the jumper settings from the table for the sensor LaunchPad (the DIO2 pin is not grounded for collector).

3.3.4 Procedure for Changing Beacon Interval, Transmit Power, Data Transfer and Frequency of Operation

注: All configuration changes mentioned in the following are implemented with a default 915-MHz configuration.

3.3.4.1 Beacon Interval

Increasing the beacon interval can help increase battery lifetime, as a 5-s beacon consumes almost a quarter of the current consumed with 1-s beacon interval. The sensor is mostly in RX mode for its lifetime and consumes a fixed peak RX current (approximately 6.5 mA), hence the average current can influence overall power consumption.

Procedure:

Set the value of “CONFIG_BEACON_ORDER” in the respective section to change beacon interval for the device in consideration.

Code Composer Studio link to file (Collector project):

\\workspace\collector_cc1310lp\Application\subg\config.h

Code Composer Studio link to file (Sensor project): \\workspace\sensor_cc1310lp\Application\subg\config.h

Web Link to file (Collector Project): [TI Resource Explorer Online](#)

File Path: SimpleLink CC13xo SDK/Examples/Development Tools/CC1310 Launchpad/TI 15.4 stack/collector (or sensor)/TI-RTOS/CCS Compiler/Application/

```

/ * !
Setting beacon order to 15 will disable the beacon, 8 is a good value for
beacon mode
*/
#define CONFIG_MAC_BEACON_ORDER      8
/ * !
Setting superframe order to 15 will disable the superframe, 8 is a good value
for beacon mode
*/
#define CONFIG_MAC_SUPERFRAME_ORDER  8
  
```

3.3.4.2 Transmit Power

A higher power level results in a proportional increase in peak transmit current. The optimal transmit power that should be used for Fault Indicators to be connected in the field for a distance less than 50 m is 0 dBm.

Procedure:

Depending on the PHY that has been chosen, set the value of “CONFIG_TRANSMIT_POWER” in the respective section to change transmit power in dBm for the device in consideration.

Code Composer Studio link to file (Collector project):

\\workspace\collector_cc1310lp\Application\subg\config.h

Code Composer Studio link to file (Sensor project): \\workspace\sensor_cc1310lp\Application\subg\config.h

Web Link to file: [TI Resource Explorer Online](#)

File Path: SimpleLink CC13xo SDK/Examples/Development Tools/CC1310 Launchpad/TI 15.4 stack/
collector (or sensor)/TI-RTOS/CCS Compiler/Application/

Value for Transmit Power in dBm

For US and ETSI band, Default value is 10, allowed values are

-10, 0, 1, 2, 3, 4, 5, 6, 7, 8, 9, 10, 11, 12 and 14dBm.

For China band, allowed values are 6, 10, 13, 14 and 15dBm.

For CC1190, allowed values are between 18, 23, 25, 26 and 27dBm.

When the nodes in the network are close to each other

lowering this value will help reduce saturation */

```
#if CONFIG_RANGE_EXT_MODE
#define CONFIG_TRANSMIT_POWER      27
#else
#if ((CONFIG_PHY_ID == APIMAC_GENERIC_CHINA_433_PHY_128) || (CONFIG_PHY_ID ==
APIMAC_GENERIC_CHINA_LRM_433_PHY_130))
#define CONFIG_TRANSMIT_POWER      14
#else
#define CONFIG_TRANSMIT_POWER      6
#endif
#endif
#endif
```

3.3.4.3 Data Transfer From Collector to Sensor

The need for data transfer from data collector to the sensor (FI) nodes arises as there may be data that needs to be transmitted to an individual FI node or an over the upgrade for which a large amount of data needs to reach all the nodes on the network.

Procedure:

Set the value of “SMSGS_TOGGLE_LED_REQUEST_MSG_LEN” to change the amount of arbitrary data transmitted from the collector to the sensor to test for current consumed by the device(s) on TX or RX of the set amount of data. After the LaunchPads are loaded and the network has been established, press SW1 on the collector LaunchPad to transmit the data and measure the current for the same.

Code Composer Studio link to file (Collector project): \workspace\collector_cc1310lp\Application\smgs.h

Code Composer Studio link to file (Sensor project): \workspace\sensor_cc1310lp\Application\smgs.h

Web Link to file (Collector Project): [TI Resource Explorer Online](#)

File Path: SimpleLink CC13xo SDK/Examples/Development Tools/CC1310 Launchpad/TI 15.4 stack/
collector (or sensor)/TI-RTOS/CCS Compiler/Application/

```
/*! Length of a sensor data message with no configured data fields */
#define SMSGS_BASIC_SENSOR_LEN (3 + SMGS_SENSOR_EXTADDR_LEN)
/*! Length of the tempSensor portion of the sensor data message */
#define SMSGS_SENSOR_TEMP_LEN 4
/*! Length of the lightSensor portion of the sensor data message */
#define SMSGS_SENSOR_LIGHT_LEN 2
/*! Length of the humiditySensor portion of the sensor data message */
#define SMSGS_SENSOR_HUMIDITY_LEN 4
/*! Length of the messageStatistics portion of the sensor data message */
#define SMSGS_SENSOR_MSG_STATS_LEN 44
/*! Length of the configSettings portion of the sensor data message */
#define SMSGS_SENSOR_CONFIG_SETTINGS_LEN 8
/*! Toggle Led Request message length (over-the-air length) */
#define SMSGS_TOGGLE_LED_REQUEST_MSG_LEN 1
/*! Toggle Led Request message length (over-the-air length) */
#define SMSGS_TOGGLE_LED_RESPONSE_MSG_LEN 2
```

3.3.4.4 Data Transfer From Sensor to Collector

Data that is sent from the FI node to the data collector is of extreme importance:

- In normal working mode, the sensor (FI) nodes communicate health data at regular intervals with voltage and current data (shown as demo data for power benchmarking purposes in this reference design)
- In fault scenario, once the data collector communicates to the FI nodes that a fault has occurred and the fault information is received, the nodes will store the requisite cycles of data and then transmit the same to the data collector in single/multiple packets over single/multiple data frames.

Procedure:

Set the value of “SMGS_TOGGLE_LED_REQUEST_MSG_LEN” to change the amount of arbitrary data transmitted from the collector to the sensor to test for current consumed by the device(s) on TX or RX of the set amount of data. After the LaunchPads are loaded and the network has been established, press SW1 on the collector LaunchPad to transmit the data and measure the current for the same.

Code Composer Studio link to file (Collector project): \workspace\collector_cc1310lp\Application\smgs.h

Code Composer Studio link to file (Sensor project): \workspace\sensor_cc1310lp\Application\smgs.h

Web Link to file (Collector Project): [TI Resource Explorer Online](#)

File Path: SimpleLink CC13xo SDK/Examples/Development Tools/CC1310 Launchpad/TI 15.4 stack/collector (or sensor)/TI-RTOS/CCS Compiler/Application/

```

/! Sensor Message Extended Address Length */
#define SMGS_SENSOR_EXTADDR_LEN 8
    
```

3.3.4.5 Configuring Frequency Band (PHY Setting)

The frequency of operation can be changed by changing the PHY configuration of the collector and sensor. The available PHY are:

- APIMAC_STD_US_915_PHY_1 (50 kbps/2-FSK/915-MHz band)
- APIMAC_STD_ETSI_863_PHY_3 (50 kbps/2-FSK/863-MHz band)
- APIMAC_GENERIC_CHINA_433_PHY_128 (50 kbps/2-FSK/433-MHz band)

To make the change, set value of “CONFIG_PHY_ID” to desired PHY value in the “config.h” file.

Code Composer Studio link to file (Collector project):

workspace\collector_cc1310lp\Application\subg\config.h

Code Composer Studio link to file (Sensor project): \workspace\sensor_cc1310lp\Application\subg\config.h

Web Link to file : [TI Resource Explorer Online](#)

File path: SimpleLink CC13xo SDK/Examples/Development Tools/CC1310 Launchpad/TI 15.4 stack/collector (or sensor)/TI-RTOS/CCS Compiler/Application/

```

/! Setting for Phy ID */
#define CONFIG_PHY_ID                (APIMAC_STD_ETSI_863_PHY_3)

#if ((CONFIG_PHY_ID >= APIMAC_MRFSK_STD_PHY_ID_BEGIN) && (CONFIG_PHY_ID <=
APIMAC_MRFSK_STD_PHY_ID_END))
/! Setting for channel page */
#define CONFIG_CHANNEL_PAGE          (APIMAC_CHANNEL_PAGE_9)
#elif ((CONFIG_PHY_ID >= APIMAC_MRFSK_GENERIC_PHY_ID_BEGIN) && (CONFIG_PHY_ID <=
APIMAC_MRFSK_GENERIC_PHY_ID_END))
    
```

```
/*! Setting for channel page */  
#define CONFIG_CHANNEL_PAGE          (APIMAC_CHANNEL_PAGE_10)  
#else  
#error "PHY ID is wrong."  
#endif
```

3.4 Test Results

The measurements were taken using an 868 MHz – ETSI band initially, and then repeated by changing PHY configuration for US (915 MHz) and China (433 MHz) frequency bands

3.4.1 Beacon Interval

Formula for Beacon Order (BO) to Beacon Interval (BI) conversion:

$$BI = aBaseSuperframeDuration \times 2^{BO} / \text{Data Rate} \tag{9}$$

Power Level for all results = +10 dBm

表 7. Average Sensor RX Current

BEACON INTERVAL	433 MHz	868 MHz	915 MHz
4.92 s	16 μ A	16 μ A	16 μ A
1.23 s	62 μ A	65 μ A	65 μ A
0.31 s	241 μ A	275 μ A	260 μ A

图 18 shows beacon reception on a sensor node with a beacon interval of 4.92 s. The sensor node is in receive mode at this time. The glitches that occur as 0.5 mA pulses every 1.5 seconds are VDDR recharge pulses, the reason for these is that in standby, the VDDR voltage will slowly reduce due to leakage and a recharge pulse from the converter is required to adjust the level before the level goes under a given threshold.



图 18. Sensor Current Consumption for a Beacon Interval of 4.92 s

图 19 shows beacon reception on a sensor node with a beacon interval of 1.23 seconds. The beacon interval is reduced by a factor of 4 and the average current goes up by almost the same factor. The VDDR recharge pulses are visible every 1.23 seconds.

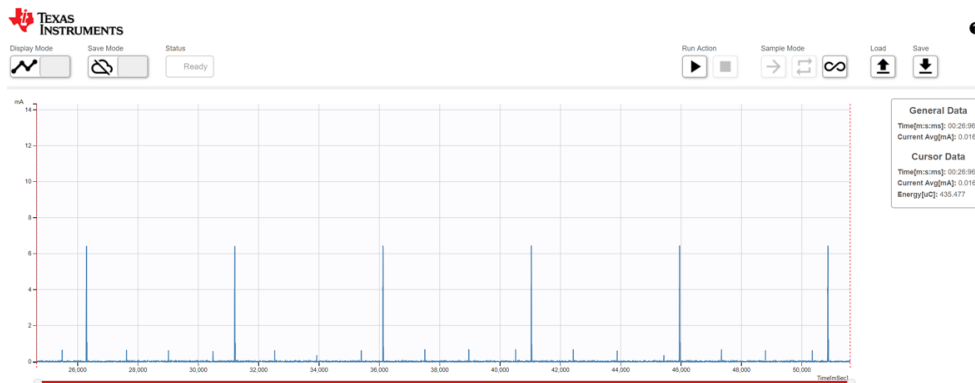

图 19. Sensor Current Consumption for a Beacon Interval of 1.23 s

图 20 shows the lowest beacon interval for which power consumption has been tested (0.3 seconds), and a beacon order of 4, the device can achieve shorter intervals by reducing BO further. The sensor has to wake up more as compared to higher BO values.

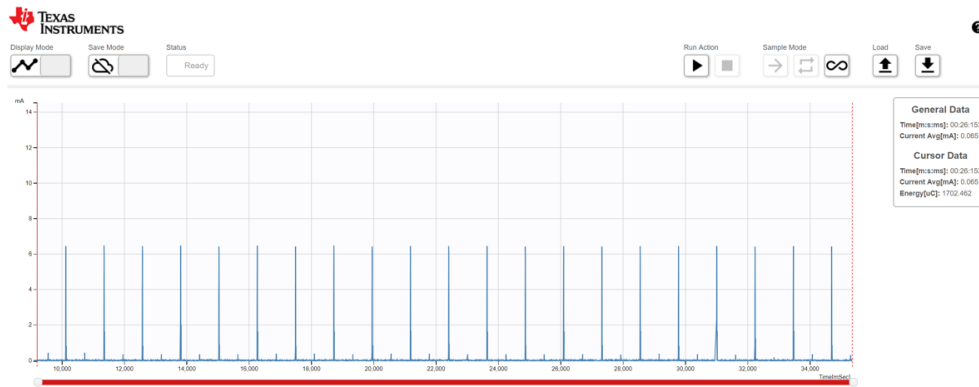

图 20. Sensor Current Consumption for a Beacon Interval of 0.31 s

表 8. Average Collector TX Current for Beacon Transmission

BEACON INTERVAL	868 MHz	433 MHz	915 MHz
4.92 s	6.27 mA	6.1 mA	6.34 mA
1.23 s	6.28 mA	6.12 mA	6.36 mA
0.31 s	6.36 mA	6.23 mA	6.45 mA

图 21 shows collector broadcasting a 4.92 second beacon, and the average current for the collector device remains around 6 mA as the receiver is always switched on to listen in to any transmissions from the sensor devices on the network.

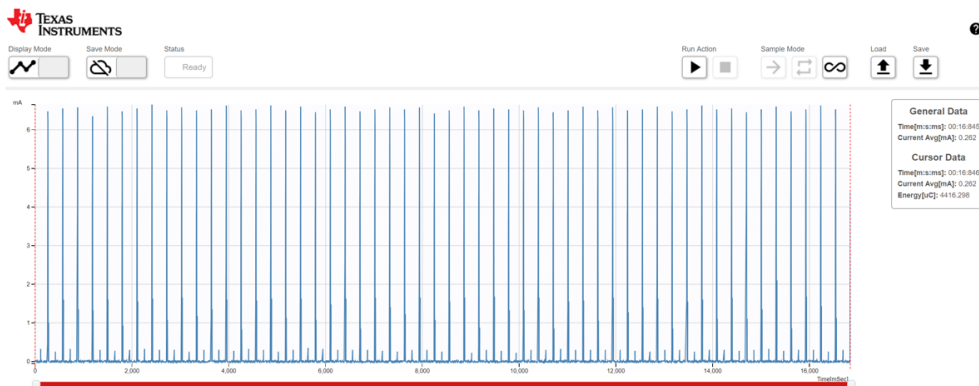

图 21. Collector Current Consumption for a Beacon Interval of 4.92 s

图 22 shows collector broadcasting beacons with a beacon interval of 1.23 seconds. The peak current is 13.5 mA as the transmit power is +10 dBm.

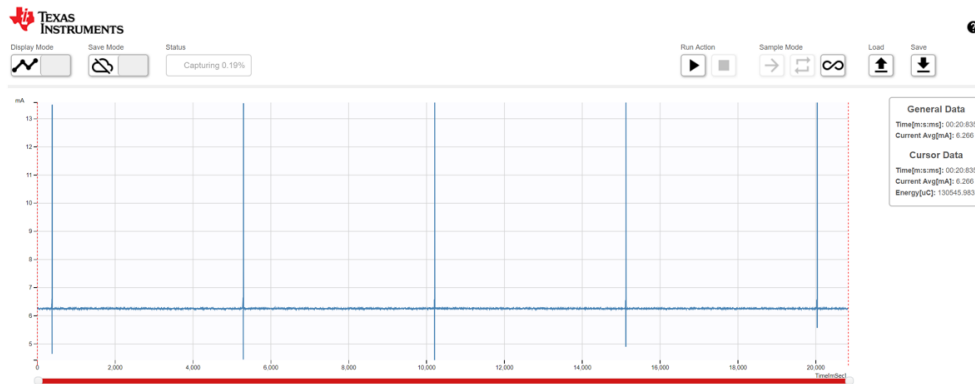

图 22. Collector Current Consumption for a Beacon Interval of 1.23 s

图 23 shows a 0.3-s beacon broadcast from the collector node.

注: The collector does not see a VDDR recharge pulse because the collector never goes into standby mode.

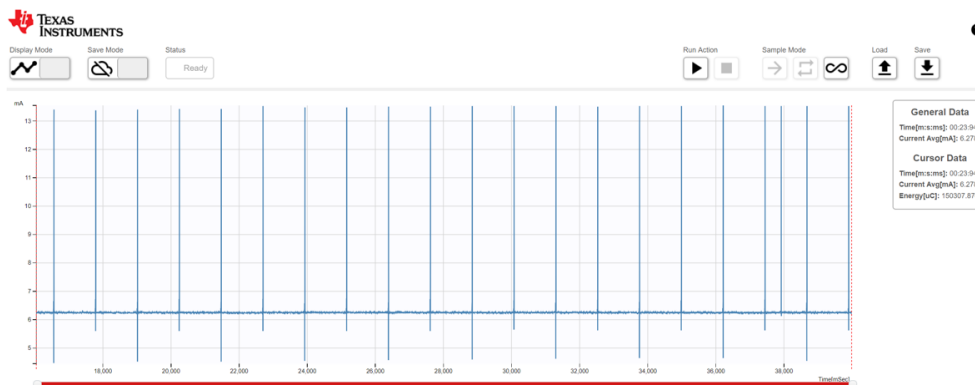

图 23. Collector Current Consumption for a Beacon Interval of 0.31 s

3.4.2 Transmit Power Level

表 9. Peak Current for Sensor Transmission

TRANSMIT POWER	433 MHz	868 MHz	915 MHz
0 dBm	-	8 mA	7.2 mA
6 dBm	13 mA	11 mA	10.5 mA
10 dBm	17 mA	15 mA	13.5 mA

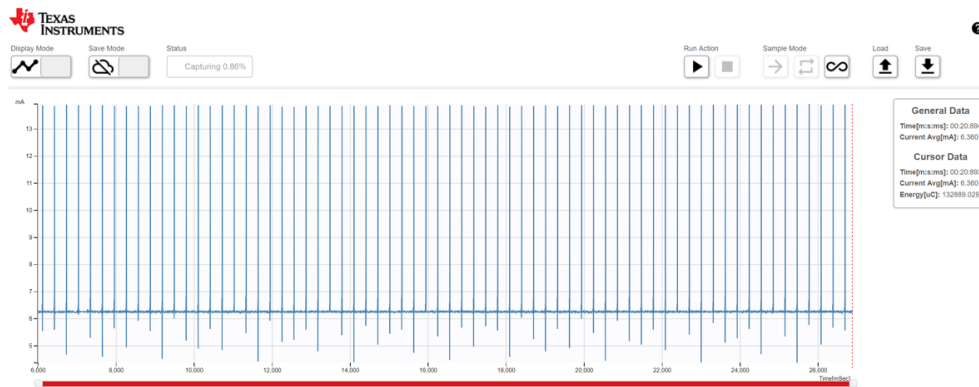
表 10. Peak Current for Collector Transmission

TRANSMIT POWER	433 MHz	868 MHz	915 MHz
0 dBm	-	7.5 mA	7.2 mA
6 dBm	13 mA	10.5 mA	10 mA
10 dBm	17 mA	14.2 mA	14.5 mA

图 24 has a peak current of 13.4 mA which matches the data sheet specification. The beacon interval is 1.23 s.



图 24. Collector Current Consumption for +10-dBm Transmit Power

图 25 illustrates a peak current of 9.5 mA for a lower transmit power setting (+6 dBm).

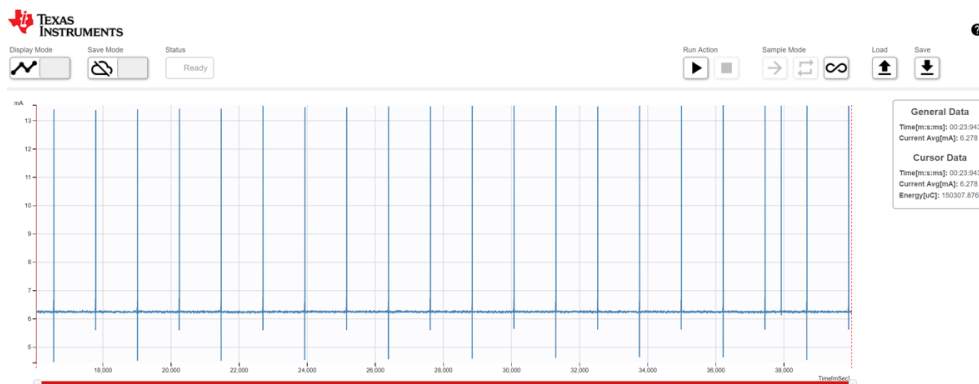

图 25. Collector Current Consumption for +6-dBm Transmit Power

图 26 has a peak current of 7.5 mA. This is the recommended value for short range (< 50 m) communication for conserving energy during power-critical operation.

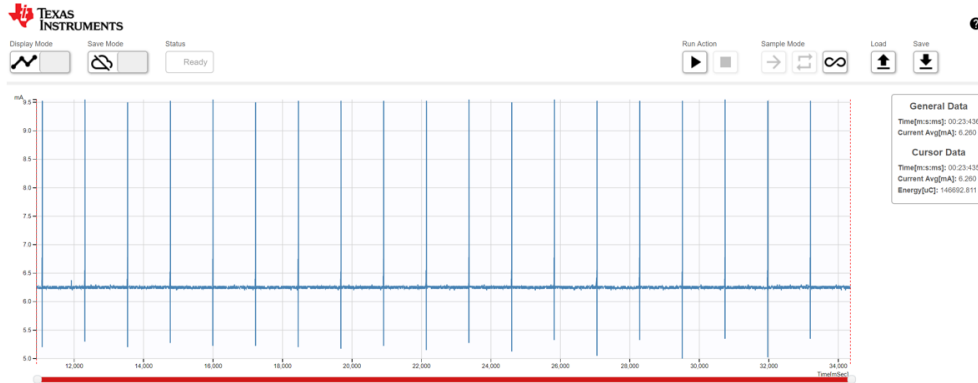

图 26. Collector Current Consumption for 0-dBm Transmit Power

3.4.3 Data Transfer From Collector to Sensor

注: The average current consumption data has been taken over a 150 ms period that included a single data exchange between the FI and the collector.

The power level for all the following results is +6 dBm.

The Beacon Interval for all results is 1.23 s.

There is a certain overhead of data received with every transmission from collector.

表 11. Average Current for Sensor Data Reception

DATA SIZE	433 MHz	868 MHz	915 MHz
1 Byte	3.11 mA	3.14 mA	2.85 mA
150 Byte	3.89 mA	4.21 mA	3.42 mA
300 Byte	5.57 mA	5.34 mA	4.35 mA

图 27 shows the sensor receiving 1-byte of data, As 节 2.5.4 explains, the first peak seen in the graph is the beacon reception followed by a data request, and then the data reception of 1 Byte along with some overhead. The last two peaks consist of an acknowledgment and a response to the LED Toggle command that the sensor has been configured to send after receiving an LED Toggle request.



图 27. Sensor Current Consumption for Reception of 1-Byte Data

图 28 shows the sensor receiving 150 Bytes of data. The reception time increases as more data is being received by the sensor.



图 28. Sensor current consumption for reception of 150-Byte Data

图 29 shows the sensor receiving 300 Bytes of data, with longer reception period due to increase in size of the data transmission from the collector, hence increase in receiver ON time at the sensor.

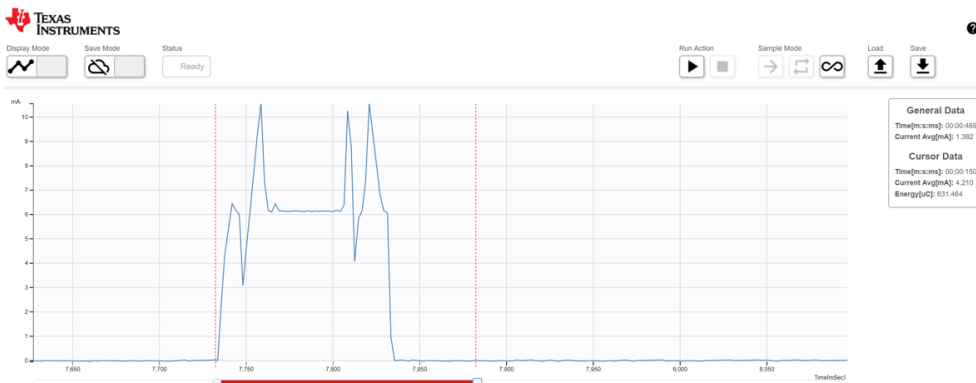

图 29. Sensor Current Consumption for Reception of 300-Byte Data

表 12. Average Current for Collector Data Transmission

TRANSMIT POWER	433 MHz	868 MHz	915 MHz
0 dBm	6.9 mA	6.7 mA	6.66 mA
6 dBm	7.73 mA	7.31 mA	7.16 mA
10 dBm	8.49 mA	7.63 mA	7.76 mA

图 30 illustrates a collector sending 1-Byte data; the first peak is the beacon transmission, followed by the reception of the data request. The second peak is the data transmission followed by the reception of the response to the LED Toggle command from the Sensor node and the acknowledgment of the same.

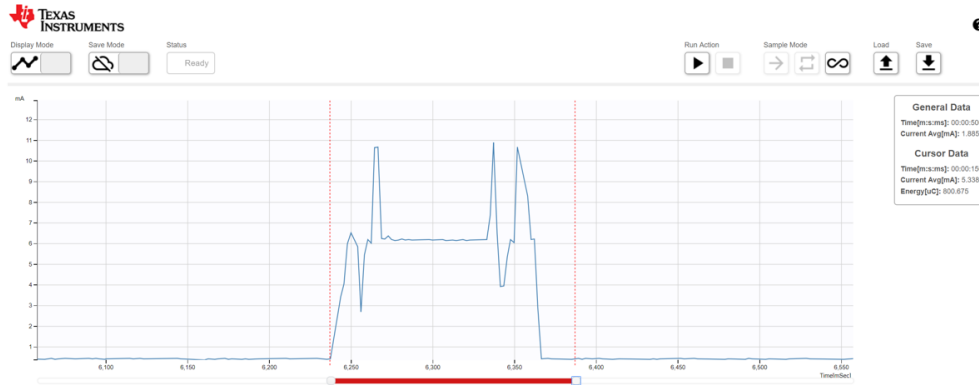

图 30. Collector Current Consumption for Transmission of 1-Byte Data

图 31 shows a collector sending 150 Bytes of data, with a 25 ms transmission period due to increase in data transfer size.

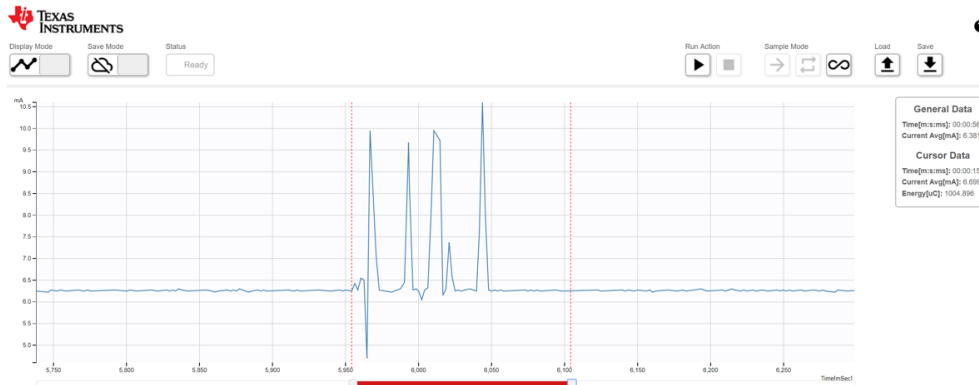

图 31. Collector Current Consumption for Transmission of 150-Byte Data

图 32 illustrates a collector sending 300 Bytes of data, with a 50 ms transmission period due to increase in data transfer size.



图 32. Collector Current Consumption for Transmission of 300-Byte Data

3.4.4 Data Transfer From Sensor to Collector

注: The average current consumption data has been taken over a 150-ms period that included a single data exchange between the FI and the collector.

The beacon interval for all results is 1.23 s.

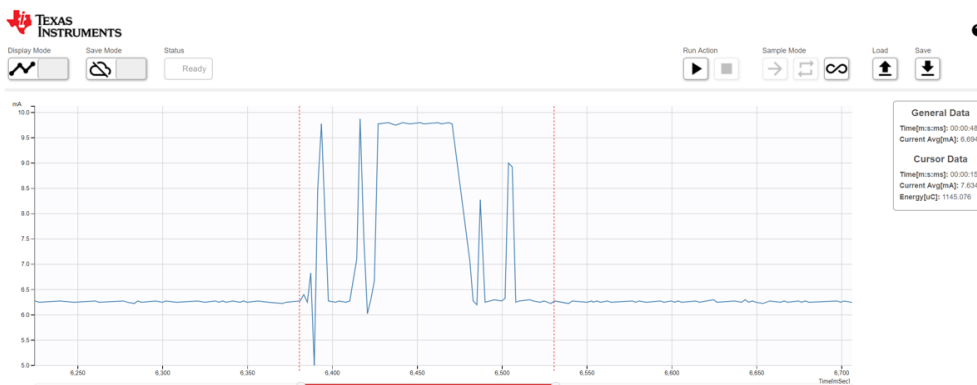
表 13. Average Current for Sensor Data Transmission

TRANSMIT POWER	433 MHz		868 MHz		915 MHz	
	70 B	300 B	70 B	300 B	70 B	300 B
0 dBm	-	-	1.63 mA	3.34 mA	1.22 mA	2.84 mA
6 dBm	1.94 mA	5.47 mA	1.82 mA	4.3 mA	1.76 mA	4.22 mA
10 dBm	2.39 mA	6.47 mA	2.26 mA	4.98 mA	2.21 mA	5.89 mA

图 33 shows the sensor waking up from sleep mode to send 70-byte data in a single transmission.



图 33. Sensor Current Consumption for Transmitting 70-Byte Data

图 34 shows the sensor waking up from sleep mode to send a 300-byte data packet in a single transmission.

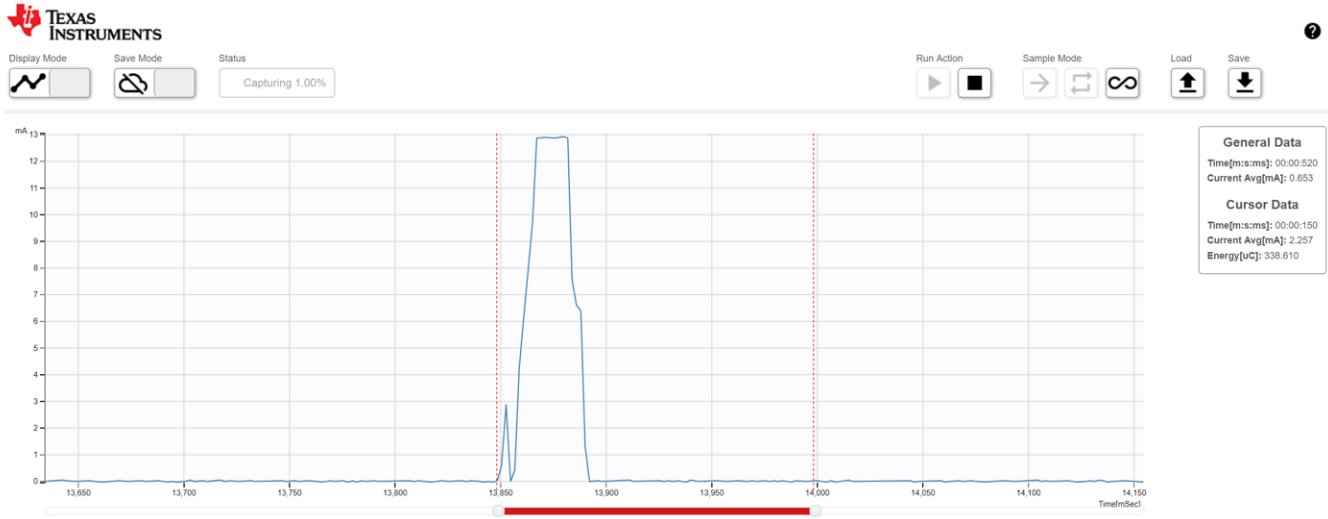

图 34. Sensor Current Consumption for Transmitting 300-Byte Data

图 35 shows the reception of the sensor data at the collector node (70 bytes) after which the collector sends an acknowledgment for the received data. The collector is always in receive mode and hence it can seamlessly receive transmitted sensor data.

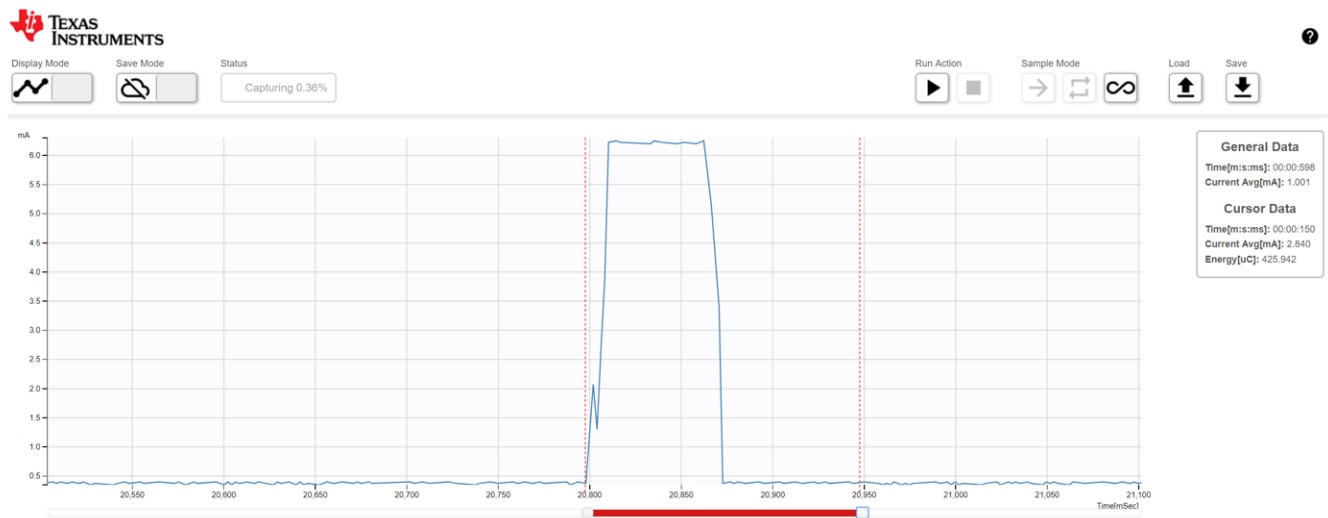

图 35. Collector Current Consumption for Receiving 70-Byte Data

图 36 shows the reception of the sensor data at the collector node (300 bytes) after which the collector sends an acknowledgment for the received data.

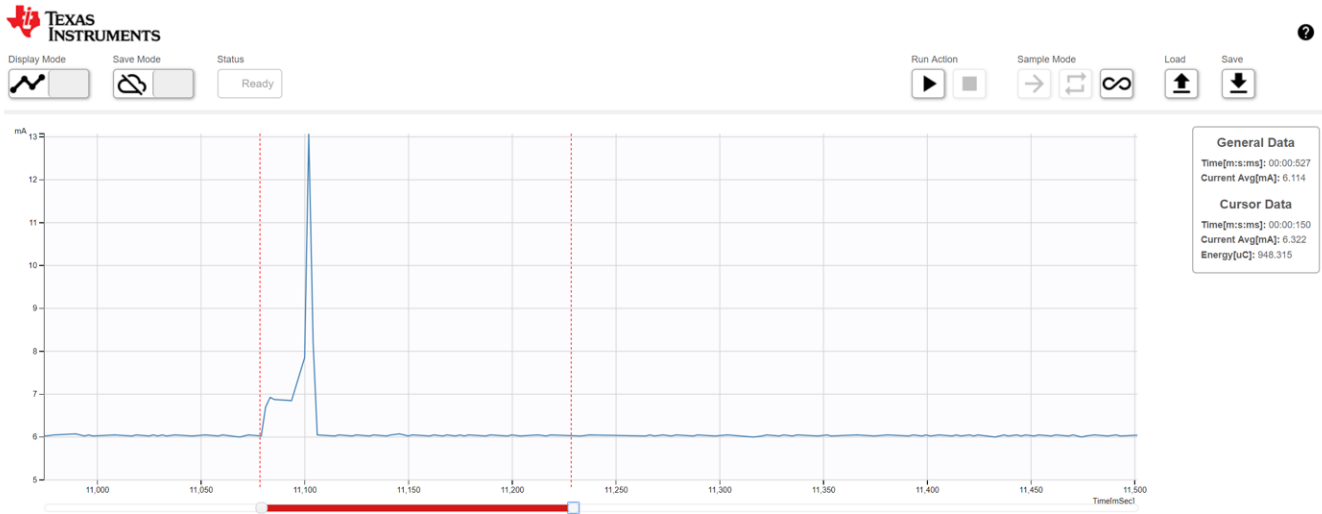

图 36. Collector Current Consumption for Receiving 300-Byte Data

3.4.5 Test Results Summary

表 14 提供了测试结果的摘要。

表 14. Test Results Summary⁽¹⁾

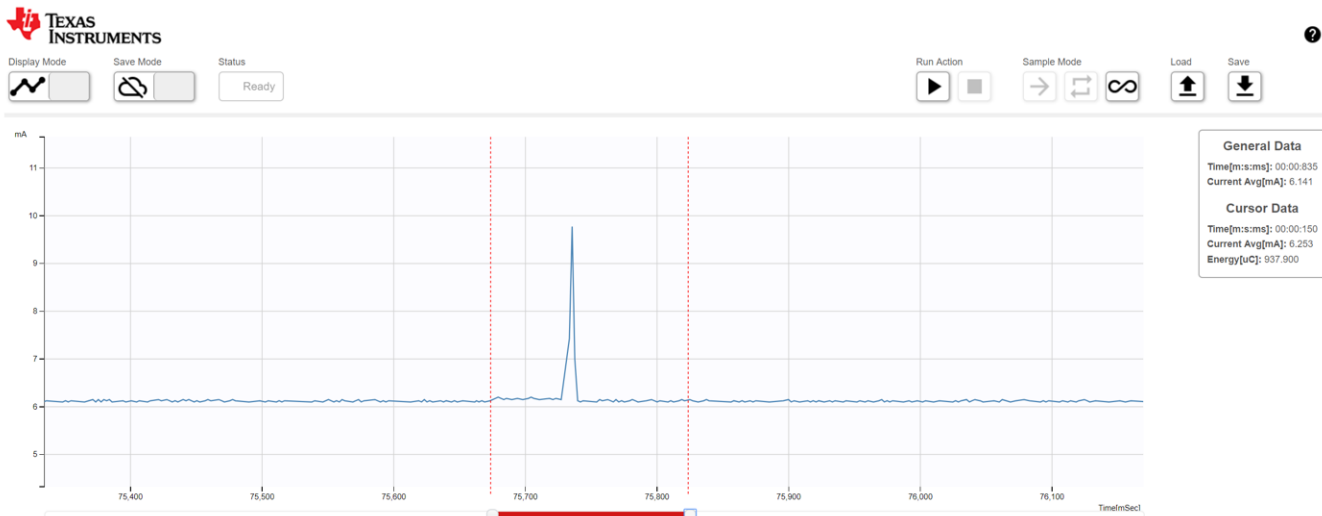
TEST CASE	DESCRIPTION	RESULT
Beacon mode communication	Beacon interval values: 0.3 s, 1.23 s, 4.9 s (collector transmits beacon, sensor node receives beacon)	Average current at the sensor node: <ul style="list-style-type: none"> less than 20 μA for 4.9-s beacon interval less than 65 μA for 1.23-s beacon interval less than 280 μA for 0.3-s beacon interval
Transmit power	0 to +10 dBm (tested for collector and sensor transmission)	Peak current value: <ul style="list-style-type: none"> 0 dBm (915 MHz, 868 MHz): 7.5–8 mA 6 dBm (433 MHz, 915 MHz, 868 MHz): 12–13 mA 10 dBm (433 MHz, 915 MHz, 868 MHz): 15–17 mA
Data exchange	Collector to sensor	Successful reception at sensor node of 1-300 byte data transmitted from collector
	Sensor to collector	Successful reception at collector node of 70-300 byte data transmitted from sensor

⁽¹⁾ All tests for the TIDA-00816, unless specified, were performed for US (915 MHz), ETSI (868 MHz), and China (433 MHz) frequency bands.

4 Design Files

4.1 Schematics

To download the schematics, see the design files at [TIDA-00816](#).

4.2 Bill of Materials

To download the bill of materials (BOM), see the design files at [TIDA-00816](#).

4.3 PCB Layout Recommendations

4.3.1 Layout Prints

To download the layer plots, see the design files at [TIDA-00816](#).

4.4 Altium Project

To download the Altium Designer® project files, see the design files at [TIDA-00816](#).

4.5 Gerber Files

To download the Gerber files, see the design files at [TIDA-00816](#).

4.6 Assembly Drawings

To download the assembly drawings, see the design files at [TIDA-00816](#).

5 Software Files

To download the software files, see the design files at [TIDA-00816](#).

6 Related Documentation

1. IEEE, [IEEE Standard for Low-Rate Wireless Networks – IEEE 802.15.4-2015 \(Revision of IEEE Std 802.15.4-2011\)](#)
2. Texas Instruments, [CC13X0 RF User's Guide](#)
3. Texas Instruments, [CC13x0 TI 15.4-Stack User's Guide](#)
4. Texas Instruments, [SmartRF Studio](#)

6.1 商标

E2E, SimpleLink, SmartRF, Code Composer Studio, LaunchPad are trademarks of Texas Instruments.
Arm, Cortex are registered trademarks of ARM Limited.
Altium Designer is a registered trademark of Altium LLC or its affiliated companies.
Bluetooth is a registered trademark of Bluetooth SIG, Inc..
Wi-Fi is a registered trademark of Wi-Fi Alliance.
ZigBee is a registered trademark of ZigBee Alliance.
All other trademarks are the property of their respective owners.

7 Terminology

FPI- Fault Passage Indicator

FI - Fault Indicator (here, same as FPI)

RTU- Remote Terminal Unit

TX- Transmit

RX- Receive

BO- Beacon Order

SO - Superframe Order

IFS - Inter Frame Spacing

GTS - Guaranteed time slot

AIFS - Acknowledgment Inter Frame Spacing

LIFS - Long Inter Frame Spacing

SIFS - Short Inter Frame Spacing

8 About the Author

HARSH MISRA is a systems engineer at Texas Instruments India where he is responsible for developing reference design solutions for Grid Infrastructure in Industrial Systems. Harsh completed his B.E.(hons) in Electrical and Electronics engineering from BITS Pilani, India

KALLIKUPPA MUNIYAPPA SREENIVASA is a systems architect at Texas Instruments where he is responsible for developing reference design solutions for the industrial segment. Sreenivasa brings to this role his experience in high-speed digital and analog systems design. Sreenivasa earned his bachelor of engineering (BE) in electronics and communication engineering (BE-E&C) from VTU, Mysore, India.

9 Acknowledgments

AMIT KUMBASI, Systems Manager at Texas Instruments, for his inputs and feedback on system architecture, requirements, and technical inputs.

重要声明和免责声明

TI 均以“原样”提供技术性 & 可靠性数据（包括数据表）、设计资源（包括参考设计）、应用或其他设计建议、网络工具、安全信息和其他资源，不保证其中不含任何瑕疵，且不做任何明示或暗示的担保，包括但不限于对适销性、适合某特定用途或不侵犯任何第三方知识产权的暗示担保。

所述资源可供专业开发人员应用 TI 产品进行设计使用。您将对以下行为独自承担全部责任：(1) 针对您的应用选择合适的 TI 产品；(2) 设计、验证并测试您的应用；(3) 确保您的应用满足相应标准以及任何其他安全、安保或其他要求。所述资源如有变更，恕不另行通知。TI 对您使用所述资源的授权仅限于开发资源所涉及 TI 产品的相关应用。除此之外不得复制或展示所述资源，也不提供其它 TI 或任何第三方的知识产权授权许可。如因使用所述资源而产生任何索赔、赔偿、成本、损失及债务等，TI 对此概不负责，并且您须赔偿由此对 TI 及其代表造成的损害。

TI 所提供产品均受 TI 的销售条款 (<http://www.ti.com.cn/zh-cn/legal/termsofsale.html>) 以及 [ti.com.cn](http://www.ti.com.cn) 上或随附 TI 产品提供的其他可适用条款的约束。TI 提供所述资源并不扩展或以其他方式更改 TI 针对 TI 产品所发布的可适用的担保范围或担保免责声明。

邮寄地址：上海市浦东新区世纪大道 1568 号中建大厦 32 楼，邮政编码：200122
Copyright © 2018 德州仪器半导体技术（上海）有限公司

重要声明和免责声明

TI 均以“原样”提供技术性 & 可靠性数据（包括数据表）、设计资源（包括参考设计）、应用或其他设计建议、网络工具、安全信息和其他资源，不保证其中不含任何瑕疵，且不做任何明示或暗示的担保，包括但不限于对适销性、适合某特定用途或不侵犯任何第三方知识产权的暗示担保。

所述资源可供专业开发人员应用 TI 产品进行设计使用。您将对以下行为独自承担全部责任：(1) 针对您的应用选择合适的 TI 产品；(2) 设计、验证并测试您的应用；(3) 确保您的应用满足相应标准以及任何其他安全、安保或其他要求。所述资源如有变更，恕不另行通知。TI 对您使用所述资源的授权仅限于开发资源所涉及 TI 产品的相关应用。除此之外不得复制或展示所述资源，也不提供其它 TI 或任何第三方的知识产权授权许可。如因使用所述资源而产生任何索赔、赔偿、成本、损失及债务等，TI 对此概不负责，并且您须赔偿由此对 TI 及其代表造成的损害。

TI 所提供产品均受 TI 的销售条款 (<http://www.ti.com.cn/zh-cn/legal/termsofsale.html>) 以及 [ti.com.cn](http://www.ti.com.cn) 上或随附 TI 产品提供的其他可适用条款的约束。TI 提供所述资源并不扩展或以其他方式更改 TI 针对 TI 产品所发布的可适用的担保范围或担保免责声明。

邮寄地址：上海市浦东新区世纪大道 1568 号中建大厦 32 楼，邮政编码：200122
Copyright © 2018 德州仪器半导体技术（上海）有限公司