

Filter Pro Session 2005

Section 7

Precision Analog Applications Seminar

Filter Pro Session 2005 Outline

Filter Pro session topics:

- ◆ A quick introduction to the Filter Pro program
- ◆ Filter output, inverting and non-inverting stages
- ◆ Op-amp gain-bandwidth requirements in filter applications

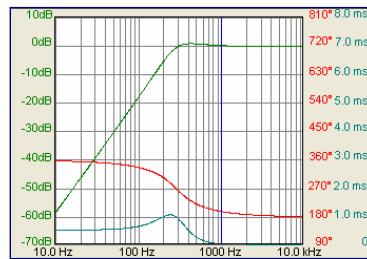
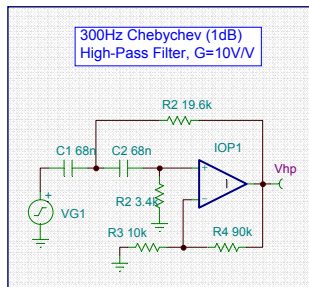

This session provides a quick introduction to Filter Pro for those who are not familiar with the program, or a review for those who are. Then, two more advanced topics will be covered; filter output, inverting and non-inverting stages, and another on determining the gain-bandwidth requirements for op-amps used in filter applications.

Precision Analog Applications Seminar

Filter Pro Session 2005
A Quick Introduction

Filter Pro -

- ◆ Is a filter synthesis tool for designing multi-section, low-pass and high-pass active filters
- ◆ Supports 2nd to 10th order, Multiple-feedback (MFB) and Sallen-Key filter topologies

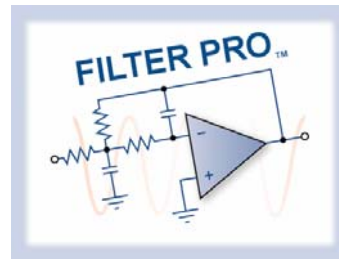

Simply stated, this is what Filter Pro provides the user.

Precision Analog Applications Seminar

Filter Pro Session 2005 A Quick Introduction

The Filter Pro work sheet

Filter entries you make

Filter topology

Passband

no. of poles

Ripple (Chebyshev)

Cutoff freq.

R1 seed (opt.)

Response freq.

Sec. gain

Component Tolerance (opt.)

Topology info

Response Plot

What Filter Pro Returns

Filter Schematic with component values

By section info: G , f_n , "Q"

	Passband Gain (Vout/Vin)	Fc	Response at 10.0 kHz	Req
A	2.006	5.9700	705.11 m	-1.56 dB -127.4°
B	2.489	10.313	2.9406	15.59 dB -78.3°
Totals	4.993	2.0734	14.03 dB	-205.8°

MFB 4-Pole Low-Pass Chebyshev, 0.5dB Ripple, 10.0 kHz Cutoff, Passband Gain of 4.993

Once the general filter properties and requirements have been decided upon, they can be selected within, or entered in to the Filter Pro worksheet.

Filter Pro will provide a starter filter topology and component values. The response may be reviewed and the filter topology altered until the filter's electrical requirements are satisfied.

Upon the response requirements having been met, the topology and component values can be changed or iterated to best suit the user's needs.

Precision Analog Applications Seminar

Filter Pro Session 2005 A Quick Introduction

The Filter Pro Topologies

Multiple Feedback (MFB)

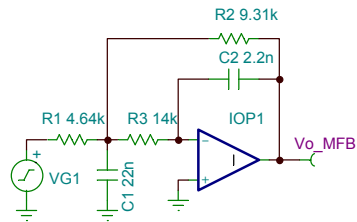

- ◆ inverted stage
- ◆ no common-mode error
- ◆ low component sensitivity

Sallen-Key

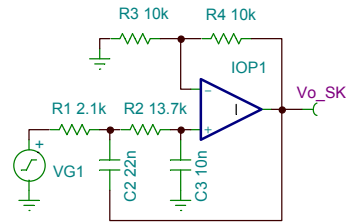

- ◆ non-inverting stage
- ◆ common-mode input C adds to C3
- ◆ $G = +1V/V$, reduces to follower
- ◆ High "Q" sensitivity

Filter Pro supports the Multiple Feedback (MFB) and Sallen-Key filter topologies:

- ◆ The MFB is a popular topology that features low sensitivity to component tolerances.
- ◆ Each 2nd-order MFB section produces an output phase inversion
- ◆ All Sallen-Key filters are non-inverting
- ◆ If the Sallen-Key gain is $+1V/V$ the R3 is eliminated and R4 is 0Ω .
- ◆ The Sallen-Key does not show a high f_n sensitivity to component tolerance. However, the filter "Q" is very sensitive to component tolerance.

Precision Analog Applications Seminar

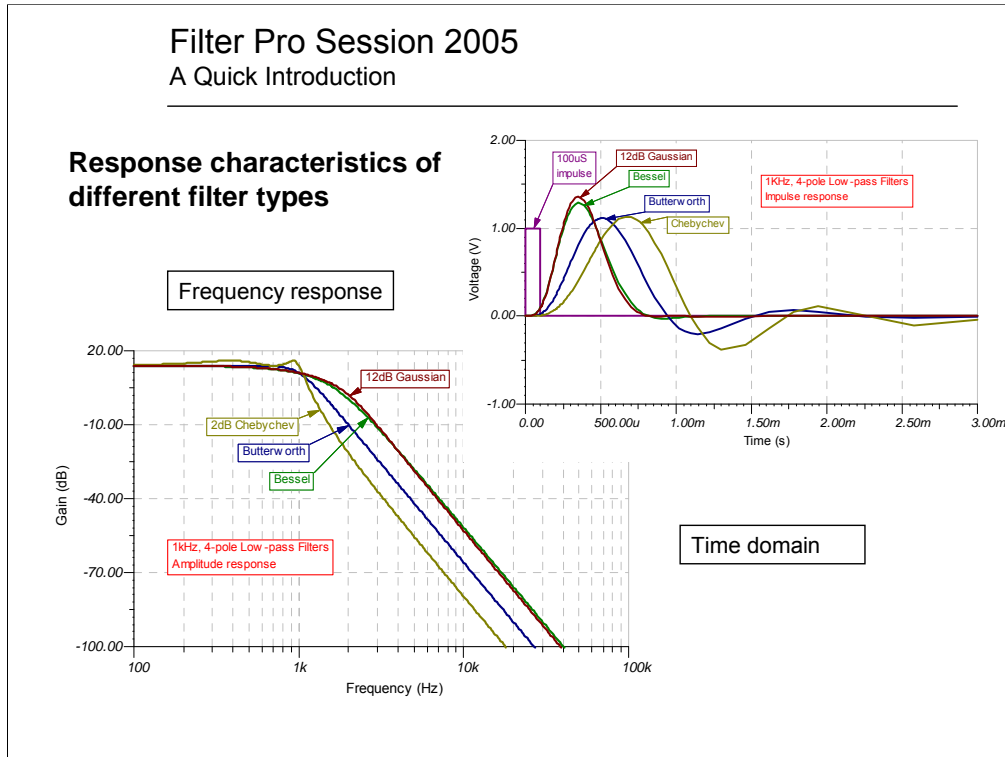

Presented here are frequency and time responses for 4 different filter types; Butterworth, Chebychev, Bessel and 12dB Gaussian low-pass filters.

- ◆ The Butterworth filter is noted for its maximally flat passband response and good pulse response.
- ◆ The Chebychev filter provides better attenuation beyond the passband, but the ringing in response to pulses may be objectionable.
- ◆ The Bessel filter also referred to as a linear phase filter has the best impulse response characteristics but the poorest rejection just beyond cutoff.
- ◆ The 12dB Gaussian filter results which follows a Gaussian distribution. This is most evident with bandpass filters. Its amplitude and pulse responses are similar to the Bessel filter.

Filter Pro Session 2005

Filter output
inverting and non-inverting stages

Output phase inversion may be an issue to consider in some circuit applications. Filter Pro offers the choice of the Multiple Feedback (MFB) and Sallen-Key topologies. The filter topology that best suits the application, relative to inverted or non-inverted output issue, can be selected after considering their output characteristics.

Precision Analog Applications Seminar

Filter Pro Session 2005

Filter output - inverting and non-inverting stages

If output phase inversion is a concern, with Filter Pro:

- ◆ 1st-order sections do not invert
- ◆ MFB 2nd-order sections do invert
- ◆ Sallen-Key 2nd-order sections do not invert

The phase inversion is the normal inversion associated with an inverting amplifier. Remember that filters introduce additional phase shift across frequency and that is in addition to the output inversion of the MFB section.

Precision Analog Applications Seminar

Filter Pro Session 2005

Filter output - inverting and non-inverting stages

Some MFB input/output phase relationships

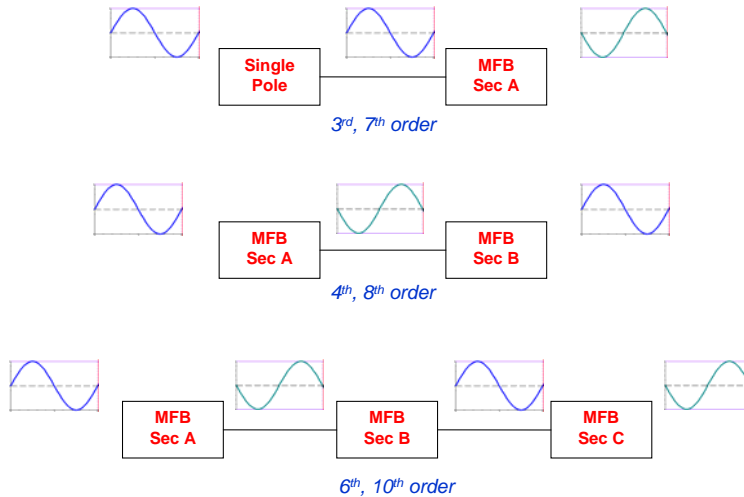

If using the MFB topology consider the following:

- ◆ Each 2nd-order MFB section introduces an output phase inversion
- ◆ A 3rd-order MFB filter inverts the output as well
- ◆ Adding 1 additional MFB section to a filter inverts the output
- ◆ Adding 2 sections returns the same output phase relationship as the preceding section

Precision Analog Applications Seminar

Filter Pro Session 2005

Filter output - inverting and non-inverting stages

Example: A 3rd-order MFB filter has a phase inverted output, but a non-inverting output is required...

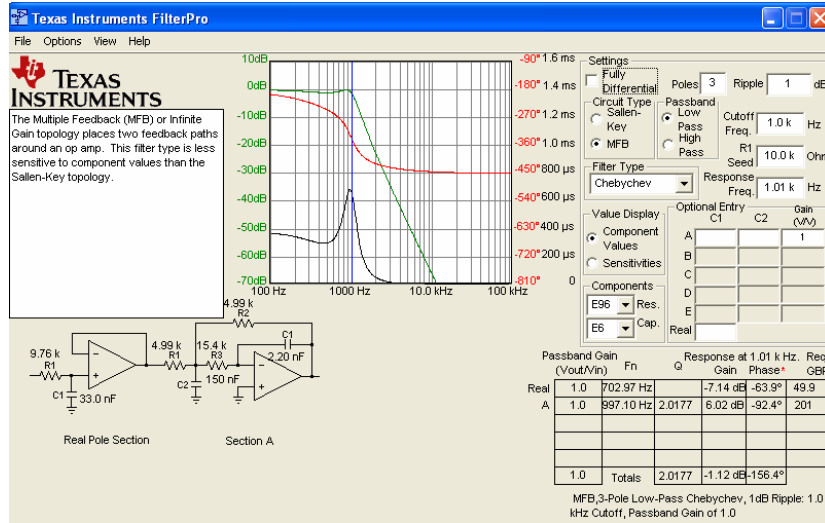

This application calls for a 3rd order Chebyshev MFB low-pass filter, but with a non-inverting output. The non-inverting Sallen-Key would appear to be the logical choice but there could be “Q” sensitivity issues that would rule its use out.

Precision Analog Applications Seminar

Filter Pro Session 2005

Filter output - inverting and non-inverting stages

Real Pole Section

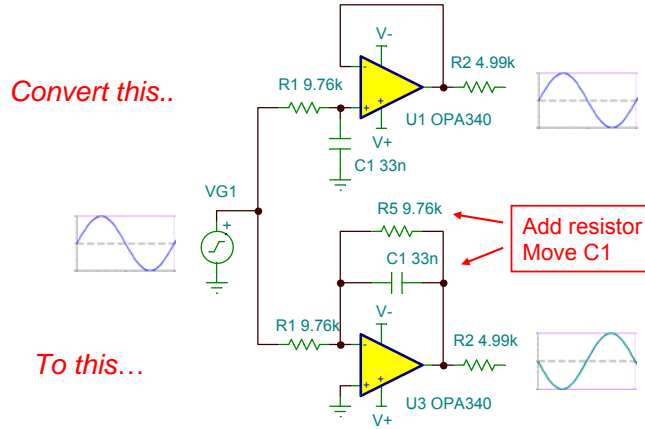

The 1st-order, non-inverting section of the 3rd-order filter is shown in the schematic. It can be converted to an inverting stage by moving C1 as shown and adding a feedback resistor equal in value to the input resistor.

The signal inversion of this first stage, in conjunction with the 2nd-order stage that follows, results in the required input-output relationship.

Precision Analog Applications Seminar

Filter Pro Session 2005

Filter output - inverting and non-inverting stages

3rd-order, 1kHz, 1dB Chebychev filter example ($G = 1V/V$)

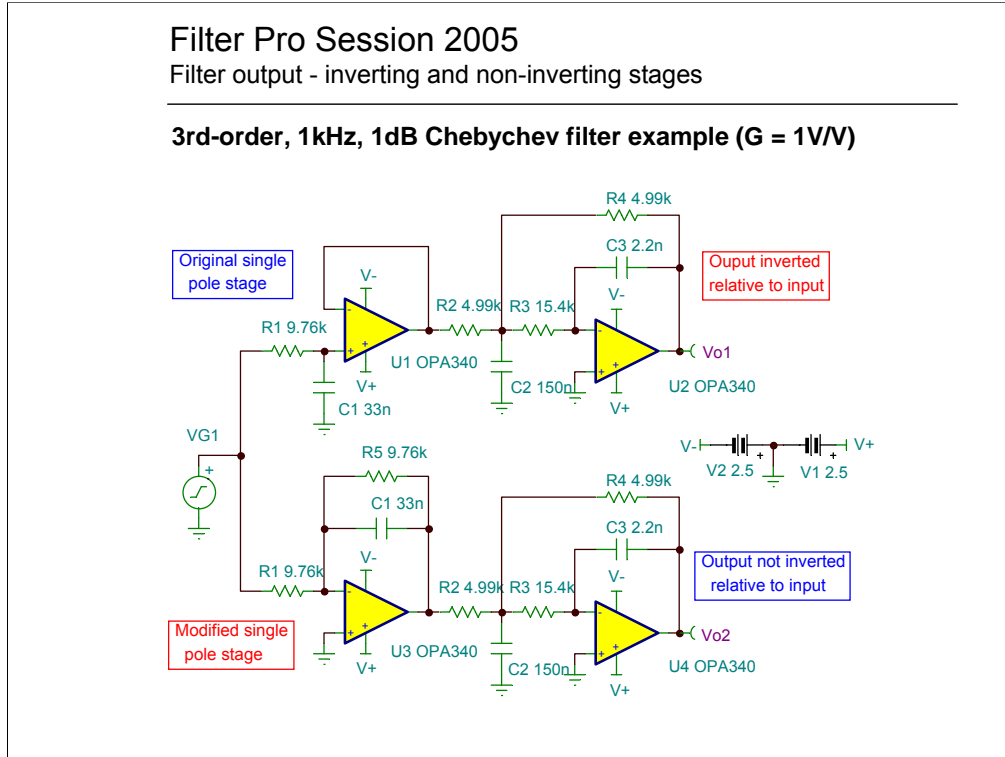

The upper half of the schematic shows the original 3rd order filter, which results in an inverted output. The lower half of the schematic shows the same filter with the first section redesigned such that it inverts at its output. Since the 2nd-order stage that follows it also inverts, the two inversions result in a non-inverting output.

Precision Analog Applications Seminar

Filter Pro Session 2005

Filter output - inverting and non-inverting stages

The filter amplitude response is nearly identical

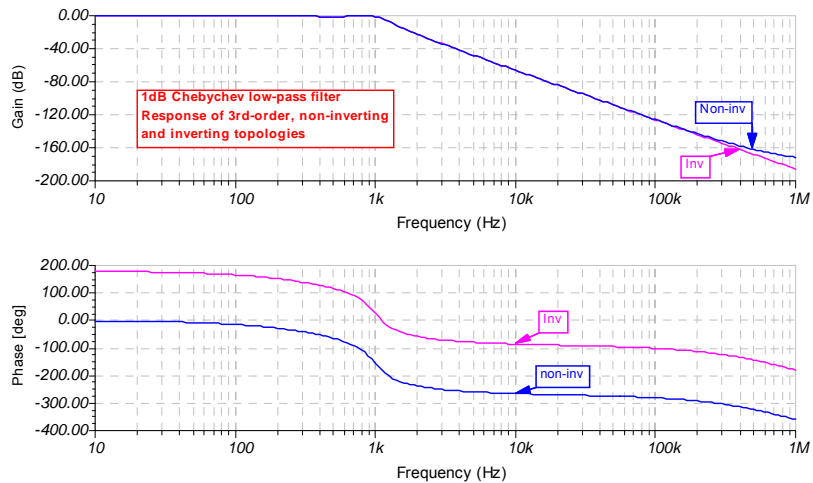

Here is a comparison of the 3rd-order filter's output before and after changing the 1st-order section from a non-inverting stage to an inverting stage. The overall output is now non-inverting. Note the 180 degree difference in the output phase responses. A small amplitude deviation is noted starting around -160dB for the 3rd-order filter that has the non-inverting response. Likely, this would be of no consequence.

Precision Analog Applications Seminar

Filter Pro Session 2005

Filter output - inverting and non-inverting stages

Sallen-Key and MFB sections can be mixed to obtain the required input/output relationship

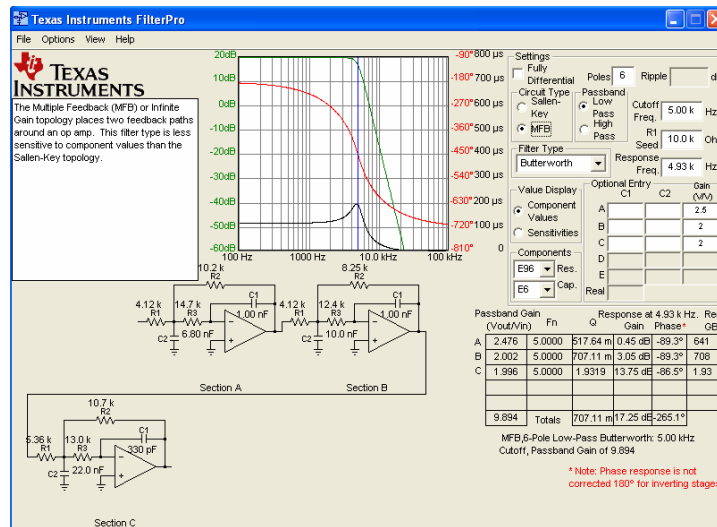

This prototype, 3-section MFB, Butterworth low-pass filter has a gain of 10V/V and an f_c 5of kHz. One phase inversion can be eliminated by replacing a 2nd-order MFB stage with a Sallen-Key stage.

Since the gain, f_n and Q are the same for each stage whether it is an MFB or Sallen-Key, Filter Pro can provide equivalent filter designs for both topologies. However, Filter Pro cannot simultaneously display the resulting filters for both topologies.

It is best to design the filter in one topology and then print the result. Then, select the other topology and let Filter Pro design it. Print that result. Since each stage in the two filters have identical responses, with the possible exception of inverting or non-inverting output, the corresponding stages can be plucked from one filter topology to the other.

Precision Analog Applications Seminar

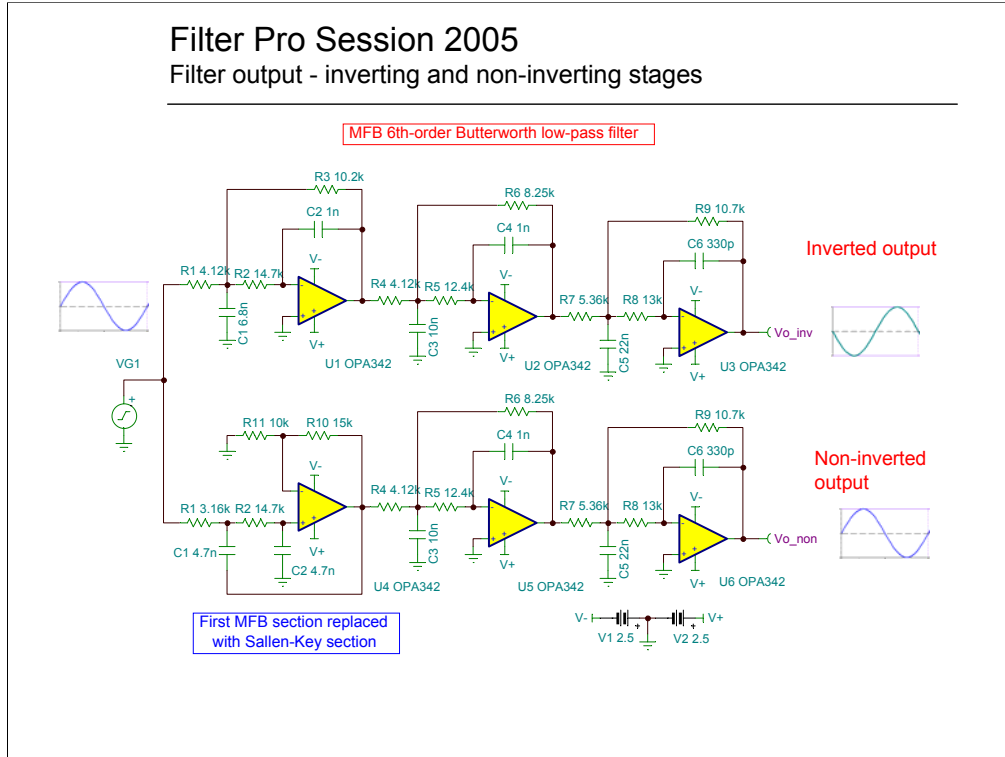

This is a TINA circuit representation for the 3-section, 6th-order, low-pass filter in which the first MFB section has been replaced with a Sallen-Key section. The original MFB filter is shown in the top half, while the modified filter is shown in the lower half.

Precision Analog Applications Seminar

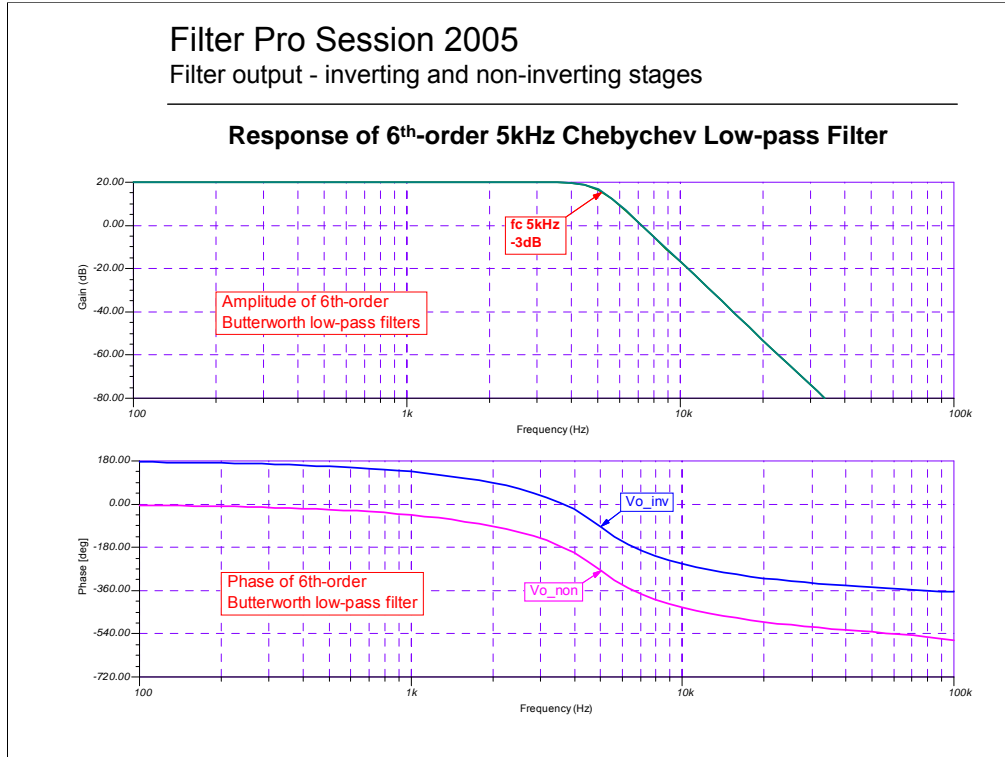

The TINA simulation provides the amplitude and phase response for the 3-section, 6th-order low-pass filter. Note the 180 degree phase difference for the 2 outputs.

The amplitude response is identical for the standard MFB filter and the other MFB filter containing the Sallen-Key input section.

Filter Pro Session 2005

Op-Amp Gain-Bandwidth
Requirements

It is not always intuitively obvious what the bandwidth requirements will be for the op-amps used in a particular filter. The requirements can be quite different from one filter response type to the next, even though they may have the same cut-off frequency.

Precision Analog Applications Seminar

Filter Pro Session 2005
Op-amp gain-bandwidth requirements

Filter Pro uses ideal op-amps having both

- ◆ Infinite bandwidth
- ◆ Infinite Gain

However! →

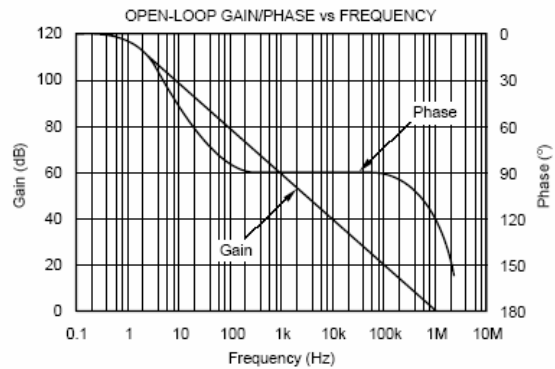

Filter Pro assumes the op-amps used in the filters it synthesizes are ideal. Bandwidth and gain are infinite resulting in mathematically perfect filter responses. Real, non-ideal op-amps will produce far less than ideal response if they do not have sufficient gain and bandwidth to support the filter design criteria.

Precision Analog Applications Seminar

Filter Pro Session 2005

Op-amp gain-bandwidth requirements

Filter Pro calculates each filter section's Gain-Bandwidth Product (GBP) from:

$$\text{GBP}_{\text{section}} = G \cdot f_n \cdot Q$$

where: G is the section gain (V/V)

f_n is the section natural frequency

"Q" is related to the stage damping factor ($Q = 1/2\zeta$)

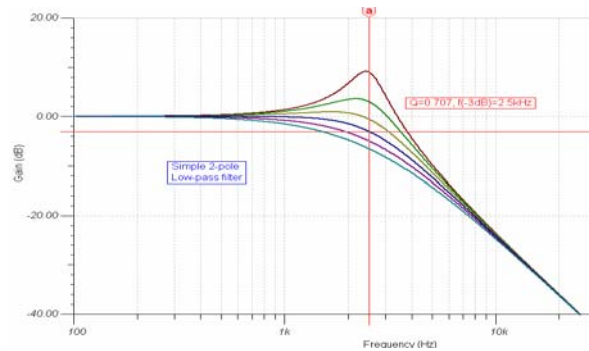

Filter Pro provides a key indicator of the bandwidth required for each filter section. It is referred to as the Gain-Bandwidth Product (GBP). It consists of the product of the passband gain, the section's natural frequency and quality factor "Q." The GBP for each section is listed in the lower right table of the worksheet.

The "Q" is a damping constant determining the selectivity of the frequency response around f_n . Another way to define the "Q" is the ratio of the reactive power to the average power.

Precision Analog Applications Seminar

Filter Pro Session 2005
Op-amp gain-bandwidth requirements

The filter's op-amps should:

- ◆ Fully support the worst case section GBP requirements
- ◆ Have sufficiently high open-loop gain at f_n of the worst case GBP stage

Real op-amps used to support the filter function are selected based on the worst-case section's GBP, such as, the section that has the highest GBP.

Although individual op-amps could be selected to meet the minimum requirements of each stage that isn't usually desired or even practical. Often, a dual or quad op-amp is used in the filter and one is selected that will meet the requirements of all the filter sections.

Precision Analog Applications Seminar

Filter Pro Session 2005

Op-amp gain-bandwidth requirements

Op-amp closed loop gain error

- ◆ The section closed-loop gain (A_{CL}) error is a function of the open-loop gain (A_{OL})

A_{OL} / A_{CL}	Δ error	% error
10^4	10^{-4}	0.01
10^3	10^{-3}	0.10
10^2	10^{-2}	1.00
10^1	10^{-1}	10.0

- ◆ For example, select A_{OL} to be $\geq 100 \cdot A_{CL}$ at f_n for $\leq 1\%$ gain error

The table shows the closed-loop gain error that results from limited open-loop gain. The particular application will dictate the acceptable maximum gain error.

For example if a gain error of 1% is acceptable, then the ratio of open-loop gain (A_{ol}) to closed-loop gain (A_{cl}) should be no less than 100 at the worst-case f_n . Higher gain accuracy will require a higher A_{ol} to A_{cl} ratio.

Precision Analog Applications Seminar

Filter Pro Session 2005

Op-amp gain-bandwidth requirements

Example of a 2-section (4-pole), 2.5kHz Chebychev filter (Section "A" $G = -4V/V$, Section "B" $G = -10V/V$)

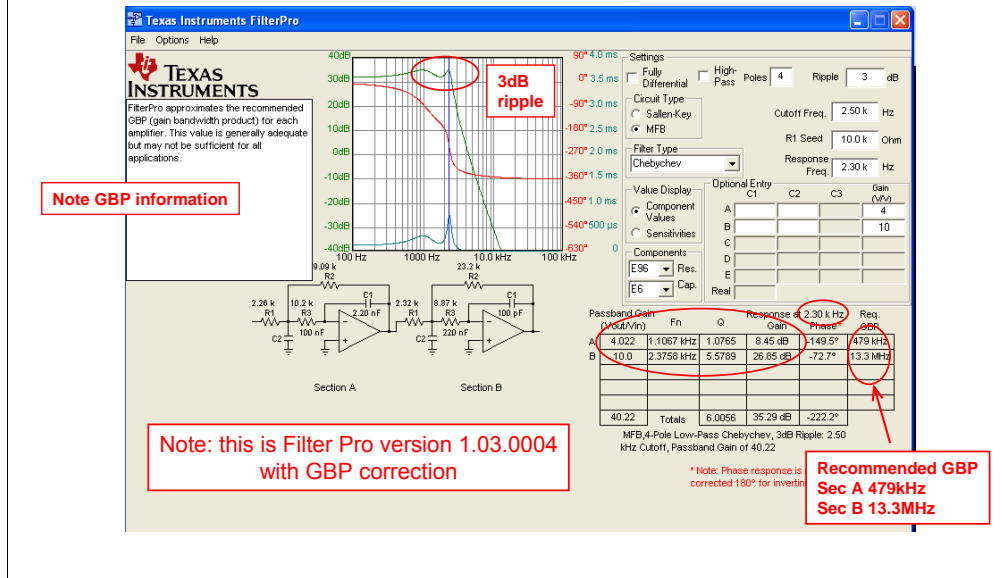

Here is an example of a 2.5kHz Chebychev low-pass filter with a 3dB pass-band ripple and a gain of 40V/V. This filter places some pretty demanding requirements on the op-amps because of a high GBP section (section B). This example is used to illustrate how one goes about selecting an op-amp with sufficient bandwidth to support the requirements of this filter.

Filter sections that have the simultaneously requirements of high cutoff frequency, moderate to high voltage gain and a high "Q" will require a wide bandwidth amplifier.

Precision Analog Applications Seminar

Filter Pro Session 2005

Op-amp gain-bandwidth requirements

The prototype 4-pole Chebychev 2.5kHz Low-pass Filter

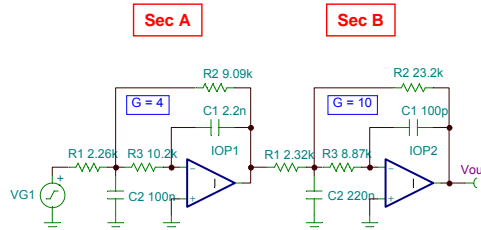

Section	G(V/V)	f_n	"Q"	GBP	GBP +40dB
A	4.0	1.11kHz	1.08	4.79kHz	479kHz
B	10.0	2.38kHz	5.58	132.8kHz	13.3MHz

For Section B

$$GBP_{\text{op-amp}} = G \cdot f_n \cdot Q \cdot 100 = (10\text{V/V}) (2.38\text{kHz}) (5.58) (100) = 13.3\text{MHz}$$

(1% maximum gain error)

Filter Pro internally calculates a GBP of 4.8kHz for Section A, and 133kHz for Section B, and then multiplies each result by 100V/V (40dB). This gain is sufficient to assure a maximum gain error of 1%. A higher open-loop to closed-loop gain ratio would be required for a lower, maximum gain error.

Section B has the greater GBP requirement. Its required gain is the product of the nominal passband gain, 10V/V (20dB), the gain associated with the circuit "Q", 5.58V/V (14.9dB) at f_n and the aforementioned +40dB. Which results in a minimum section gain requirement of 75dB at f_n (Note that a 1% maximum gain error is again used).

$$GBP_{\text{op-amp}} = G \cdot f_n \cdot Q \cdot 100 = (10\text{V/V}) (2.38\text{kHz}) (5.58) (100) = 13.3\text{MHz}$$

Precision Analog Applications Seminar

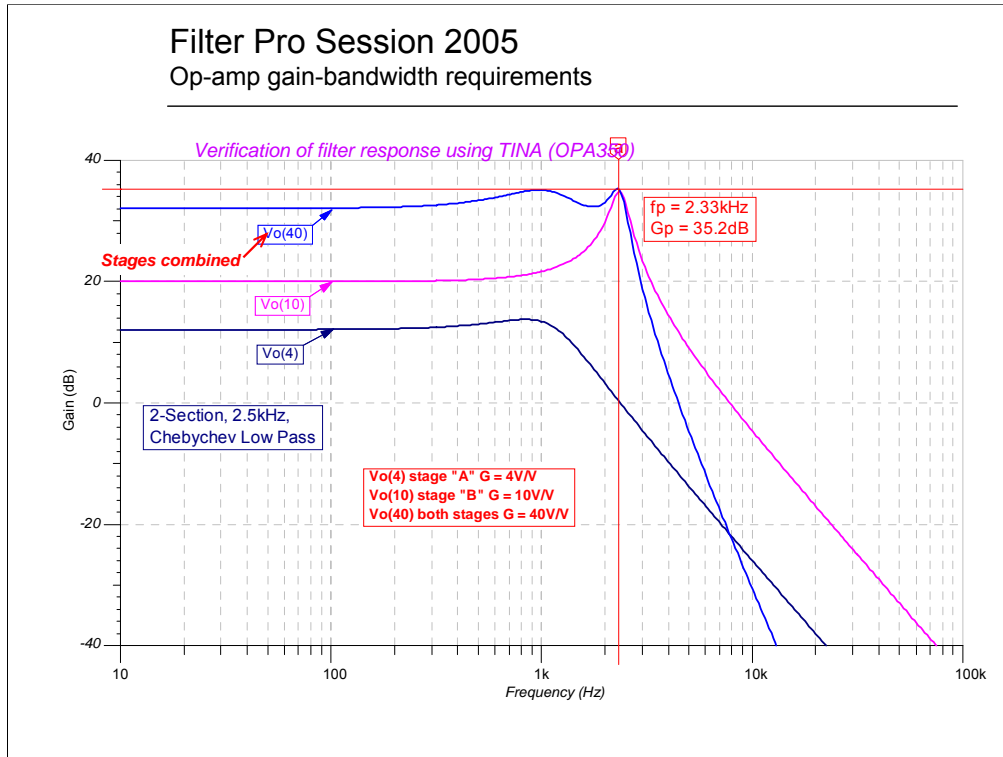

This amplitude vs. frequency plot shows the simulated response of each section, A and B, and the overall filter output. The plot was obtained using the TINA simulation tool.

Filter Pro had calculated that the worst case GBP section was section B. It is labeled in the plot as Vo(10), indicating the stages $G = 10V/V$. Notice the response peaking at f_n due to the stage's higher "Q."

Combining section B's response with the response of section A results in the overall filter response.

Precision Analog Applications Seminar

Filter Pro Session 2005

Op-amp gain-bandwidth requirements

Selecting a suitable op-amp for the filter application

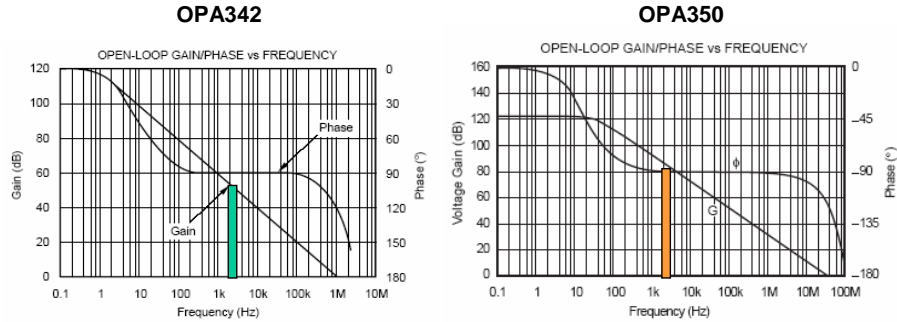

A comparison of 2 CMOS op-amp's open-loop gain over frequency. The OPA350 is a good choice having both sufficient gain and bandwidth.

Once the op-amp's GBP requirement is understood an appropriate op-amp can be selected. Here two different +5V CMOS op-amps are being considered for the 2.5kHz low-pass filter application; the OPA342 and OPA350.

A review of their open-loop gain (A_{ol}) vs. frequency plots shows the OPA342 exhibits approximately 50dB of A_{ol} at 2.5kHz, while the OPA350 has about 82dB A_{ol} at 2.5kHz.

Since section B requires about 75dB of A_{ol} at f_n , the OPA350 easily meets the minimum A_{ol} requirement; however, the OPA342 does not. The OPA350's unity gain crossover frequency of 30MHz, well exceeds the 13.3MHz unity gain bandwidth requirement.

Note that there may be more to selecting an op-amp than just its AC bandwidth performance. In comparison, the OPA350 has a quiescent operating current (I_Q) of about 8mA, while the OPA340 I_Q is only about 150 μ A. Then there are noise specifications which can be quite different for the two amplifiers. Broadband op-amps like the OPA350 use high-speed CMOS processing which is likely to exhibit much higher $1/f$ noise at low frequencies than an op-amp produced on a low speed process. It is wise to check all specifications in addition to the AC bandwidth.

Precision Analog Applications Seminar

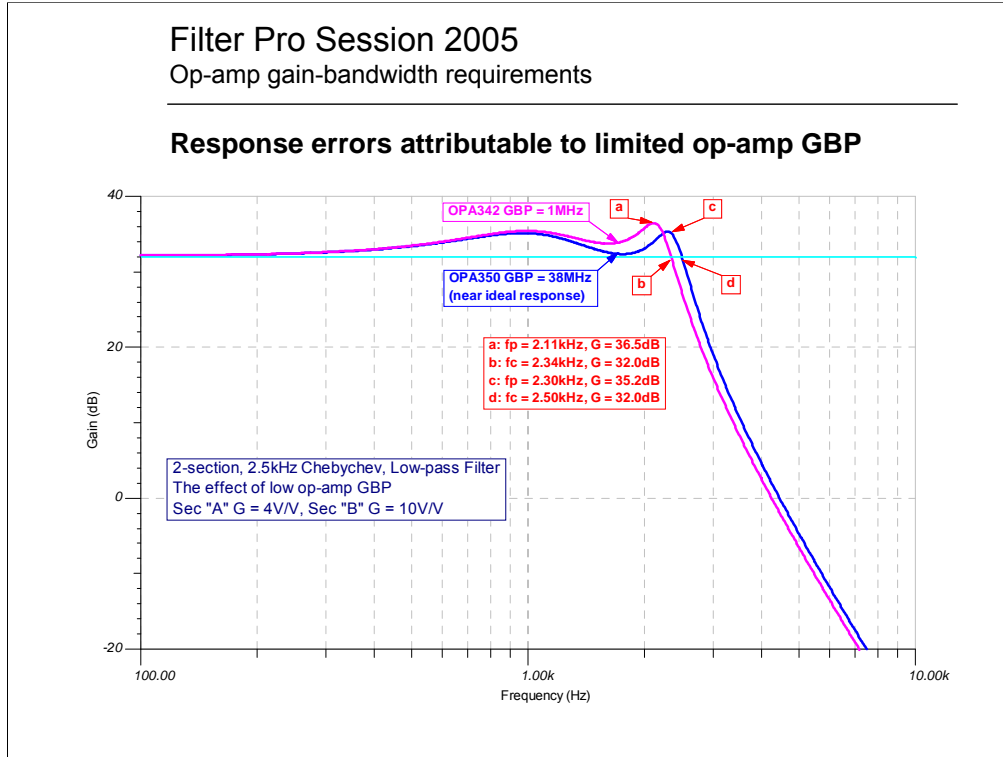

This is a gain vs. frequency plot for the filter with both the OPA342 and OPA350. Although the responses are similar in appearance for the two amplifier types, the OPA342 distorts the filter's cutoff frequency and gain.

The OPA350 produces a near ideal response. This was confirmed using ideal op-amps in the simulation.

Precision Analog Applications Seminar

Filter Pro Session 2005
Op-amp gain-bandwidth requirements

Section gain and GBP requirements

- ◆ The section gains can be iterated using Filter Pro to better match the GBP between sections

Chebychev, Fourth-order, 2.5kHz low-pass			
Sec A	Sec B	GBP A*	GBP B*
V/V	V/V	kHz	kHz
40	1	47.8	13.3
20	2	23.9	26.6
10	4	11.9	53.3
8	5	9.61	66
5	8	5.92	107
4	10	4.79	133
2	20	2.39	266
1	40	1.19	533

* Doesn't include additional Aol/Acl gain

Setting the Section A gain to 20V/V and Section B to 2 V/V produces nearly identical GBP between sections. This gain set results in the lowest GBP of all combinations. Note that the GBP listed does not include the additional gain needed to establish a maximum gain error, such as, x100, x1000, etc.

Admittedly, iterating successfully becomes more difficult as the number of filter sections increases; however, an acceptable compromise can usually be reached.

Precision Analog Applications Seminar

Filter Pro Session 2005

Op-amp gain-bandwidth requirements

The gain has been redistributed to better match the GBP between sections

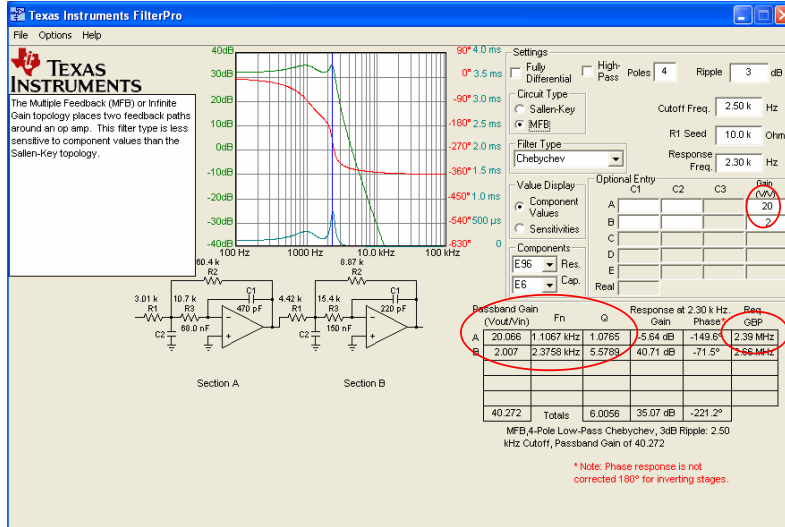

Filter Pro confirms that setting section A gain to 20V/V and section B to 2V/V results in nearly identical GBP for both sections.

Precision Analog Applications Seminar

Filter Pro Session 2005
Op-amp gain-bandwidth requirements

Confirming Section B GBP for a gain of 2V/V:

$$\begin{aligned} GBP_{op-amp} &= G \cdot f_n \cdot Q \cdot 100 \\ &= (2V/V) (2.38kHz) (5.58) (100) = 2.66MHz \end{aligned}$$

The op-amp's GBP requirement is now 1/5th
the previous!

With a near optimal redistribution of gains the required op-amp GBP is now one-fifth the previous value.

Precision Analog Applications Seminar

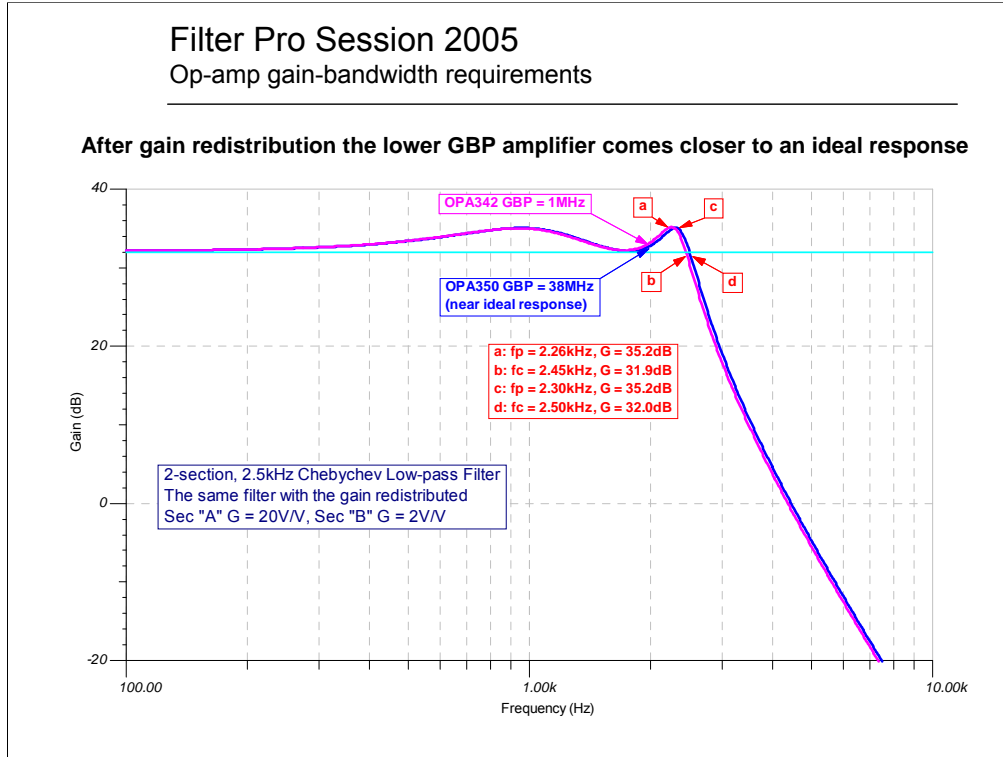

The same two op-amps are used in this filter simulation, but with the gain optimally redistributed. The OPA350 response is unchanged and still near ideal, while the OPA342 with its much lower bandwidth comes very close to providing an ideal response. The gain is only off by about 0.1dB and the frequency inaccuracy is only about 2%.

The OPA340 or OPA341 op-amps with 5.5MHz GBP would serve well in this filter.

Precision Analog Applications Seminar

Filter Pro Session 2005

Where to obtain Filter Pro:

<http://focus.ti.com/docs/toolsw/folders/print/filterpro.html>

or go to: www.ti.com

and enter **Filter Pro** in the **keyword search** box

Precision Analog Applications Seminar