

TSB12LV26-EP

OHCI-Lynx™ PCI-Based IEEE 1394 Host Controller

Data Manual

Contents

<i>Section</i>	<i>Title</i>	<i>Page</i>
1	Introduction	1-1
1.1	Description	1-1
1.2	Features	1-1
1.3	Related Documents	1-2
1.4	Trademarks	1-2
1.5	Ordering Information	1-2
2	Terminal Descriptions	2-1
3	TSB12LV26 Controller Programming Model	3-1
3.1	PCI Configuration Registers	3-3
3.2	Vendor ID Register	3-3
3.3	Device ID Register	3-4
3.4	Command Register	3-4
3.5	Status Register	3-5
3.6	Class Code and Revision ID Register	3-6
3.7	Latency Timer and Class Cache Line Size Register	3-6
3.8	Header Type and BIST Register	3-7
3.9	OHCI Base Address Register	3-7
3.10	TI Extension Base Address Register	3-8
3.11	Subsystem Identification Register	3-8
3.12	Power Management Capabilities Pointer Register	3-9
3.13	Interrupt Line and Pin Register	3-9
3.14	MIN_GNT and MAX_LAT Register	3-10
3.15	OHCI Control Register	3-10
3.16	Capability ID and Next Item Pointer Register	3-11
3.17	Power Management Capabilities Register	3-12
3.18	Power Management Control and Status Register	3-13
3.19	Power Management Extension Register	3-14
3.20	Miscellaneous Configuration Register	3-15
3.21	Link Enhancement Control Register	3-16
3.22	Subsystem Access Register	3-17
3.23	GPIO Control Register	3-18
4	OHCI Registers	4-1
4.1	OHCI Version Register	4-4
4.2	GUID ROM Register	4-5
4.3	Asynchronous Transmit Retries Register	4-6
4.4	CSR Data Register	4-6
4.5	CSR Compare Register	4-7

4.6	CSR Control Register	4-7
4.7	Configuration ROM Header Register	4-8
4.8	Bus Identification Register	4-8
4.9	Bus Options Register	4-9
4.10	GUID High Register	4-10
4.11	GUID Low Register	4-10
4.12	Configuration ROM Mapping Register	4-11
4.13	Posted Write Address Low Register	4-11
4.14	Posted Write Address High Register	4-12
4.15	Vendor ID Register	4-12
4.16	Host Controller Control Register	4-13
4.17	Self-ID Buffer Pointer Register	4-14
4.18	Self-ID Count Register	4-15
4.19	Isochronous Receive Channel Mask High Register	4-16
4.20	Isochronous Receive Channel Mask Low Register	4-17
4.21	Interrupt Event Register	4-18
4.22	Interrupt Mask Register	4-20
4.23	Isochronous Transmit Interrupt Event Register	4-22
4.24	Isochronous Transmit Interrupt Mask Register	4-23
4.25	Isochronous Receive Interrupt Event Register	4-24
4.26	Isochronous Receive Interrupt Mask Register	4-25
4.27	Fairness Control Register	4-25
4.28	Link Control Register	4-26
4.29	Node Identification Register	4-27
4.30	PHY Layer Control Register	4-28
4.31	Isochronous Cycle Timer Register	4-29
4.32	Asynchronous Request Filter High Register	4-30
4.33	Asynchronous Request Filter Low Register	4-32
4.34	Physical Request Filter High Register	4-33
4.35	Physical Request Filter Low Register	4-35
4.36	Physical Upper Bound Register (Optional Register)	4-35
4.37	Asynchronous Context Control Register	4-36
4.38	Asynchronous Context Command Pointer Register	4-37
4.39	Isochronous Transmit Context Control Register	4-38
4.40	Isochronous Transmit Context Command Pointer Register	4-39
4.41	Isochronous Receive Context Control Register	4-39
4.42	Isochronous Receive Context Command Pointer Register	4-41
4.43	Isochronous Receive Context Match Register	4-42
5	GPIO Interface	5-1
6	Serial ROM Interface	6-1
7	Electrical Characteristics	7-1
7.1	Absolute Maximum Ratings Over Operating Temperature Ranges	7-1
7.2	Recommended Operating Conditions	7-2
7.3	Electrical Characteristics Over Recommended Operating Conditions	7-3

7.4	Switching Characteristics for PCI Interface	7-3
7.5	Switching Characteristics for PHY-Link Interface	7-3
8	Mechanical Information	8-1

List of Illustrations

<i>Figure</i>	<i>Title</i>	<i>Page</i>
2-1	Terminal Assignments	2-1
3-1	TSB12LV26 Block Diagram	3-2
5-1	GPIO2 and GPIO3 Logic Diagram	5-1

List of Tables

<i>Table</i>	<i>Title</i>	<i>Page</i>
2-1	Signals Sorted by Terminal Number	2-2
2-2	Signal Names Sorted Alphanumerically to Terminal Number	2-3
2-3	Power Supply Terminals	2-3
2-4	PCI System Terminals	2-4
2-5	PCI Address and Data Terminals	2-4
2-6	PCI Interface Control Terminals	2-5
2-7	IEEE 1394 PHY/Link Terminals	2-6
2-8	Miscellaneous Terminals	2-6
3-1	Bit Field Access Tag Descriptions	3-1
3-2	PCI Configuration Register Map	3-3
3-3	Command Register Description	3-4
3-4	Status Register Description	3-5
3-5	Class Code and Revision ID Register Description	3-6
3-6	Latency Timer and Class Cache Line Size Register Description	3-6
3-7	Header Type and BIST Register Description	3-7
3-8	OHCI Base Address Register Description	3-7
3-9	Subsystem Identification Register Description	3-8
3-10	Interrupt Line and Pin Register Description	3-9
3-11	MIN_GNT and MAX_LAT Register Description	3-10
3-12	OHCI Control Register Description	3-10
3-13	Capability ID and Next Item Pointer Register Description	3-11
3-14	Power Management Capabilities Register Description	3-12
3-15	Power Management Control and Status Register Description	3-13
3-16	Power Management Extension Register Description	3-14
3-17	Miscellaneous Configuration Register	3-15
3-18	Link Enhancement Control Register Description	3-16
3-19	Subsystem Access Register Description	3-17
3-20	GPIO Control Register Description	3-18

4-1	OHCI Register Map	4-1
4-2	OHCI Version Register Description	4-4
4-3	GUID ROM Register Description	4-5
4-4	Asynchronous Transmit Retries Register Description	4-6
4-5	CSR Control Register Description	4-7
4-6	Configuration ROM Header Register Description	4-8
4-7	Bus Options Register Description	4-9
4-8	Configuration ROM Mapping Register Description	4-11
4-9	Posted Write Address Low Register Description	4-11
4-10	Posted Write Address High Register Description	4-12
4-11	Host Controller Control Register Description	4-13
4-12	Self-ID Count Register Description	4-15
4-13	Isochronous Receive Channel Mask High Register Description	4-16
4-14	Isochronous Receive Channel Mask Low Register Description	4-17
4-15	Interrupt Event Register Description	4-18
4-16	Interrupt Mask Register Description	4-20
4-17	Isochronous Transmit Interrupt Event Register Description	4-22
4-18	Isochronous Receive Interrupt Event Register Description	4-24
4-19	Fairness Control Register Description	4-25
4-20	Link Control Register Description	4-26
4-21	Node Identification Register Description	4-27
4-22	PHY Control Register Description	4-28
4-23	Isochronous Cycle Timer Register Description	4-29
4-24	Asynchronous Request Filter High Register Description	4-30
4-25	Asynchronous Request Filter Low Register Description	4-32
4-26	Physical Request Filter High Register Description	4-33
4-27	Physical Request Filter Low Register Description	4-35
4-28	Asynchronous Context Control Register Description	4-36
4-29	Asynchronous Context Command Pointer Register Description	4-37
4-30	Isochronous Transmit Context Control Register Description	4-38
4-31	Isochronous Receive Context Control Register Description	4-39
4-32	Isochronous Receive Context Match Register Description	4-42
6-1	Registers and Bits Loadable Through Serial ROM	6-1
6-2	Serial ROM Map	6-2

1 Introduction

1.1 Description

The Texas Instruments TSB12LV26 device is a PCI-to-1394 host controller compliant with the *PCI Local Bus Specification*, *PCI Bus Power Management Interface Specification*, IEEE Std 1394-1995, and *1394 Open Host Controller Interface Specification*. The chip provides the IEEE 1394 link function and is compatible with 100M bits/s, 200M bits/s, and 400M bits/s serial bus data rates.

As required by the *1394 Open Host Controller Interface Specification* (OHCI) and IEEE Std 1394a-2000, internal control registers are memory-mapped and nonprefetchable. The PCI configuration header is accessed through configuration cycles specified by PCI and provides plug-and-play (PnP) compatibility. Furthermore, the TSB12LV26 device is compliant with the *PCI Bus Power Management Interface Specification*, per the *PC 99 Design Guide* requirements. TSB12LV26 device supports the D0, D2, and D3 power states.

The TSB12LV26 design provides PCI bus master bursting and is capable of transferring a cacheline of data at 132M bytes/s after connection to the memory controller. Since PCI latency can be large, deep FIFOs are provided to buffer 1394 data.

The TSB12LV26 device provides physical write posting buffers and a highly-tuned physical data path for SBP-2 performance. The TSB12LV26 device also provides multiple isochronous contexts, multiple cacheline burst transfers, advanced internal arbitration, and bus-holding buffers on the PHY/link interface.

An advanced CMOS process achieves low power consumption and allows the TSB12LV26 device to operate at PCI clock rates up to 33 MHz.

1.2 Features

The TSB12LV26-EP device supports the following features:

- Controlled Baseline
- One Assembly/Test Site, One Fabrication Site
- Extended Temperature Performance of -40°C to 110°C
- Enhanced Diminishing Manufacturing Sources (DMS) Support
- Enhanced Product Change Notification
- Qualification Pedigree[†]
- 3.3-V and 5-V PCI bus signaling
- 3.3-V supply (core voltage is internally regulated to 1.8 V)
- Serial bus data rates of 100M bits/s, 200M bits/s, and 400M bits/s
- Physical write posting of up to three outstanding transactions
- Serial ROM interface supports 2-wire devices
- External cycle timer control for customized synchronization
- PCI burst transfers and deep FIFOs to tolerate large host latency
- Two general-purpose I/Os
- Fabricated in advanced low-power CMOS process
- Packaged in 100-terminal LQFP (PZ)
- PCI_CLKRUN protocol

[†] Component qualification in accordance with JEDEC and industry standards to ensure reliable operation over an extended temperature range. This includes, but is not limited to, Highly Accelerated Stress Test (HAST) or biased 85/85, temperature cycle, autoclave or unbiased HAST, electromigration, bond intermetallic life, and mold compound life. Such qualification testing should not be viewed as justifying use of this component beyond specified performance and environmental limits.

1.3 Related Documents

- *1394 Open Host Controller Interface Specification* (Revision 1.0)
- *IEEE Standard for a High Performance Serial Bus* (IEEE Std 1394-1995)
- *IEEE Standard for a High Performance Serial Bus—Amendment 1* (IEEE Std 1394a-2000)
- *PC 99 Design Guide*
- *PCI Bus Power Management Interface Specification* (Revision 1.0)
- *PCI Local Bus Specification* (Revision 2.2)
- *Serial Bus Protocol 2* (SBP-2)

1.4 Trademarks

OHCI-Lynx and is a trademark of Texas Instruments.

Other trademarks are the property of their respective owners.

1.5 Ordering Information

ORDERING NUMBER	NAME	VOLTAGE	PACKAGE	TOP-SIDE MARKING
TSB12LV26TPZEP	OHCI-Lynx™ PCI-Based IEEE 1394 Host Controller	3.3 V, 5 V Tolerant I/Os	100-Terminal PQFP	TSB12LV26TEP

2 Terminal Descriptions

This section provides the terminal descriptions for the TSB12LV26 device. Figure 2–1 shows the signal assigned to each terminal in the package. Table 2–1 is a listing of signal names arranged in terminal number order, and Table 2–2 lists terminals in alphanumeric order by signal names.

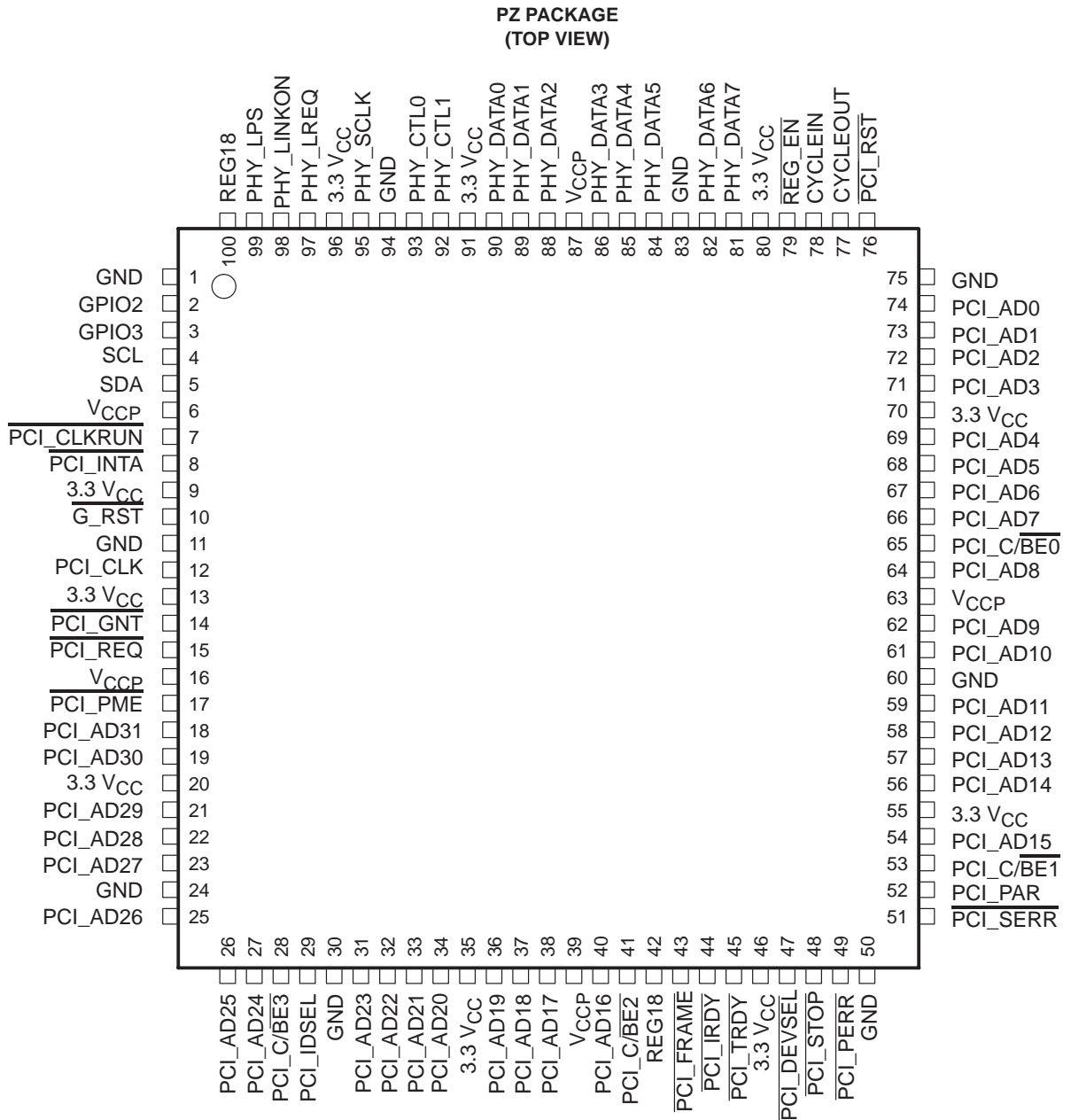

Figure 2–1. Terminal Assignments

Table 2–1. Signals Sorted by Terminal Number

NO.	TERMINAL NAME	NO.	TERMINAL NAME	NO.	TERMINAL NAME	NO.	TERMINAL NAME
1	GND	26	PCI_AD25	51	PCI_SERR	76	PCI_RST
2	GPIO2	27	PCI_AD24	52	PCI_PAR	77	CYCLEOUT
3	GPIO3	28	PCI_C/BE3	53	PCI_C/BE1	78	CYCLEIN
4	SCL	29	PCI_IDSEL	54	PCI_AD15	79	REG_EN
5	SDA	30	GND	55	3.3 VCC	80	3.3 VCC
6	VCCP	31	PCI_AD23	56	PCI_AD14	81	PHY_DATA7
7	PCI_CLKRUN	32	PCI_AD22	57	PCI_AD13	82	PHY_DATA6
8	PCI_INTA	33	PCI_AD21	58	PCI_AD12	83	GND
9	3.3 VCC	34	PCI_AD20	59	PCI_AD11	84	PHY_DATA5
10	G_RST	35	3.3 VCC	60	GND	85	PHY_DATA4
11	GND	36	PCI_AD19	61	PCI_AD10	86	PHY_DATA3
12	PCI_CLK	37	PCI_AD18	62	PCI_AD9	87	VCCP
13	3.3 VCC	38	PCI_AD17	63	VCCP	88	PHY_DATA2
14	PCI_GNT	39	VCCP	64	PCI_AD8	89	PHY_DATA1
15	PCI_REQ	40	PCI_AD16	65	PCI_C/BE0	90	PHY_DATA0
16	VCCP	41	PCI_C/BE2	66	PCI_AD7	91	3.3 VCC
17	PCI_PME	42	REG18	67	PCI_AD6	92	PHY_CTL1
18	PCI_AD31	43	PCI_FRAME	68	PCI_AD5	93	PHY_CTL0
19	PCI_AD30	44	PCI_IRDY	69	PCI_AD4	94	GND
20	3.3 VCC	45	PCI_TRDY	70	3.3 VCC	95	PHY_SCLK
21	PCI_AD29	46	3.3 VCC	71	PCI_AD3	96	3.3 VCC
22	PCI_AD28	47	PCI_DEVSEL	72	PCI_AD2	97	PHY_LREQ
23	PCI_AD27	48	PCI_STOP	73	PCI_AD1	98	PHY_LINKON
24	GND	49	PCI_PERR	74	PCI_AD0	99	PHY_LPS
25	PCI_AD26	50	GND	75	GND	100	REG18

Table 2–2. Signal Names Sorted Alphanumerically to Terminal Number

TERMINAL NAME	NO.	TERMINAL NAME	NO.	TERMINAL NAME	NO.	TERMINAL NAME	NO.
CYCLEIN	78	PCI_AD11	59	PCI_CLK	12	PHY_DATA7	81
CYCLEOUT	77	PCI_AD12	58	$\overline{\text{PCI_CLKRUN}}$	7	PHY_LINKON	98
GND	1	PCI_AD13	57	$\overline{\text{PCI_DEVSEL}}$	47	PHY_LPS	99
GND	11	PCI_AD14	56	$\overline{\text{PCI_FRAME}}$	43	PHY_LREQ	97
GND	24	PCI_AD15	54	$\overline{\text{PCI_GNT}}$	14	PHY_SCLK	95
GND	30	PCI_AD16	40	PCI_IDSEL	29	$\overline{\text{REG_EN}}$	79
GND	50	PCI_AD17	38	$\overline{\text{PCI_INTA}}$	8	REG18	42
GND	60	PCI_AD18	37	$\overline{\text{PCI_IRDY}}$	44	REG18	100
GND	75	PCI_AD19	36	PCI_PAR	52	SCL	4
GND	83	PCI_AD20	34	$\overline{\text{PCI_PERR}}$	49	SDA	5
GND	94	PCI_AD21	33	$\overline{\text{PCI_PME}}$	17	VCCP	6
GPIO2	2	PCI_AD22	32	$\overline{\text{PCI_REQ}}$	15	VCCP	16
GPIO3	3	PCI_AD23	31	$\overline{\text{PCI_RST}}$	76	VCCP	39
$\overline{\text{G_RST}}$	10	PCI_AD24	27	$\overline{\text{PCI_SERR}}$	51	VCCP	63
PCI_AD0	74	PCI_AD25	26	$\overline{\text{PCI_STOP}}$	48	VCCP	87
PCI_AD1	73	PCI_AD26	25	$\overline{\text{PCI_TRDY}}$	45	3.3 VCC	9
PCI_AD2	72	PCI_AD27	23	PHY_CTL0	93	3.3 VCC	13
PCI_AD3	71	PCI_AD28	22	PHY_CTL1	92	3.3 VCC	20
PCI_AD4	69	PCI_AD29	21	PHY_DATA0	90	3.3 VCC	35
PCI_AD5	68	PCI_AD30	19	PHY_DATA1	89	3.3 VCC	46
PCI_AD6	67	PCI_AD31	18	PHY_DATA2	88	3.3 VCC	55
PCI_AD7	66	PCI_C/BE0	65	PHY_DATA3	86	3.3 VCC	70
PCI_AD8	64	PCI_C/BE1	53	PHY_DATA4	85	3.3 VCC	80
PCI_AD9	62	PCI_C/BE2	41	PHY_DATA5	84	3.3 VCC	91
PCI_AD10	61	PCI_C/BE3	28	PHY_DATA6	82	3.3 VCC	96

The terminals in Table 2–3 through Table 2–8 are grouped in tables by functionality, such as PCI system function and power supply function. The terminal numbers are also listed for convenient reference.

Table 2–3. Power Supply Terminals

TERMINAL		I/O	DESCRIPTION
NAME	NO.		
GND	1, 11, 24, 30, 50, 60, 75, 83, 94	I	Device ground terminals
VCCP	6, 16, 39, 63, 87	I	PCI signaling clamp voltage power input. PCI signals are clamped per the <i>PCI Local Bus Specification</i> .
3.3 VCC	9, 13, 20, 35, 46, 55, 70, 80, 91, 96	I	3.3-V power supply terminals

Table 2–4. PCI System Terminals

TERMINAL		I/O	DESCRIPTION
NAME	NO.		
$\overline{G_RST}$	10	I	Global power reset. This reset brings all of the TSB12LV26 internal registers to their default states, including those registers not reset by $\overline{PCI_RST}$. When $\overline{G_RST}$ is asserted, the device is completely nonfunctional. When implementing wake capabilities from the 1394 host controller, it is necessary to implement two resets to the TSB12LV26 device. $\overline{G_RST}$ is designed to be a one-time power-on reset, and $\overline{PCI_RST}$ must be connected to the PCI bus \overline{RST} . If wake capabilities are not required, $\overline{G_RST}$ can be connected to the PCI bus \overline{RST} (see $\overline{PCI_RST}$, terminal 76).
PCI_CLK	12	I	PCI bus clock. Provides timing for all transactions on the PCI bus. All PCI signals are sampled at rising edge of PCI_CLK.
$\overline{PCI_INTA}$	8	O	Interrupt signal. This output indicates interrupts from the TSB12LV26 device to the host. This terminal is implemented as open-drain.
$\overline{PCI_RST}$	76	I	PCI reset. When this bus reset is asserted, the TSB12LV26 device places all output buffers in a high-impedance state and resets all internal registers except device power management context- and vendor-specific bits initialized by host power-on software. When $\overline{PCI_RST}$ is asserted, the device is completely nonfunctional. If this terminal is implemented, it must be connected to the PCI bus \overline{RST} signal. Otherwise, it must be pulled high to link V_{CC} through a 4.7-k Ω resistor, or strapped to the $\overline{G_RST}$ terminal (see $\overline{G_RST}$, terminal 10).

Table 2–5. PCI Address and Data Terminals

TERMINAL		I/O	DESCRIPTION
NAME	NO.		
PCI_AD31	18	I/O	PCI address/data bus. These signals make up the multiplexed PCI address and data bus on the PCI interface. During the address phase of a PCI cycle, AD31–AD0 contain a 32-bit address or other destination information. During the data phase, AD31–AD0 contain data.
PCI_AD30	19		
PCI_AD29	21		
PCI_AD28	22		
PCI_AD27	23		
PCI_AD26	25		
PCI_AD25	26		
PCI_AD24	27		
PCI_AD23	31		
PCI_AD22	32		
PCI_AD21	33		
PCI_AD20	34		
PCI_AD19	36		
PCI_AD18	37		
PCI_AD17	38		
PCI_AD16	40		
PCI_AD15	54		
PCI_AD14	56		
PCI_AD13	57		
PCI_AD12	58		
PCI_AD11	59		
PCI_AD10	61		
PCI_AD9	62		
PCI_AD8	64		
PCI_AD7	66		
PCI_AD6	67		
PCI_AD5	68		
PCI_AD4	69		
PCI_AD3	71		
PCI_AD2	72		
PCI_AD1	73		
PCI_AD0	74		

Table 2–6. PCI Interface Control Terminals

TERMINAL		I/O	DESCRIPTION
NAME	NO.		
PCI_C/BE0 PCI_C/BE1 PCI_C/BE2 PCI_C/BE3	65 53 41 28	I/O	PCI bus commands and byte enables. The command and byte enable signals are multiplexed on the same PCI terminals. During the address phase of a bus cycle PCI_C/BE3–PCI_C/BE0 define the bus command. During the data phase, this 4-bit bus is used as byte enables.
PCI_CLKRUN	7	I/O	Clock run. This terminal provides clock control through the PCI_CLKRUN protocol. An internal pulldown resistor is implemented on this terminal. This terminal is implemented as open-drain.
PCI_DEVSEL	47	I/O	PCI device select. The TSB12LV26 device asserts this signal to claim a PCI cycle as the target device. As a PCI initiator, the TSB12LV26 device monitors this signal until a target responds. If no target responds before time-out occurs, the TSB12LV26 device terminates the cycle with an initiator abort.
PCI_FRAME	43	I/O	PCI cycle frame. This signal is driven by the initiator of a PCI bus cycle. PCI_FRAME is asserted to indicate that a bus transaction is beginning, and data transfers continue while this signal is asserted. When PCI_FRAME is deasserted, the PCI bus transaction is in the final data phase.
PCI_GNT	14	I	PCI bus grant. This signal is driven by the PCI bus arbiter to grant the TSB12LV26 device access to the PCI bus after the current data transaction has completed. This signal may or may not follow a PCI bus request, depending upon the PCI bus parking algorithm.
PCI_IDSEL	29	I	Initialization device select. PCI_IDSEL selects the TSB12LV26 device during configuration space accesses. PCI_IDSEL can be connected to one of the upper 24 PCI address lines on the PCI bus.
PCI_IRDY	44	I/O	PCI initiator ready. PCI_IRDY indicates the ability of the PCI bus initiator to complete the current data phase of the transaction. A data phase is completed upon a rising edge of PCLK where both PCI_IRDY and PCI_TRDY are asserted.
PCI_PAR	52	I/O	PCI parity. In all PCI bus read and write cycles, the TSB12LV26 device calculates even parity across the PCI_AD and PCI_C/BE buses. As an initiator during PCI cycles, the TSB12LV26 device outputs this parity indicator with a one PCI_CLK delay. As a target during PCI cycles, the calculated parity is compared to the initiator parity indicator; a miscompare can result in a parity error assertion (PCI_PERR).
PCI_PERR	49	I/O	PCI parity error indicator. This signal is driven by a PCI device to indicate that calculated parity does not match PCI_PAR when PERR_ENB (bit 6) in the command register at offset 04h in the PCI configuration space (see Section 3.4, <i>Command Register</i>) is set to 1.
PCI_PME	17	O	Power management event. This terminal indicates wake events to the host.
PCI_REQ	15	O	PCI bus request. Asserted by the TSB12LV26 device to request access to the bus as an initiator. The host arbiter asserts the PCI_GNT signal when the TSB12LV26 device has been granted access to the bus.
PCI_SERR	51	O	PCI system error. When SERR_ENB (bit 8) in the command register at offset 04h in the PCI configuration space (see Section 3.4, <i>Command Register</i>) is set to 1, the output is pulsed, indicating an address parity error has occurred. The TSB12LV26 device need not be the target of the PCI cycle to assert this signal. This terminal is implemented as open-drain.
PCI_STOP	48	I/O	PCI cycle stop signal. This signal is driven by a PCI target to request the initiator to stop the current PCI bus transaction. This signal is used for target disconnects, and is commonly asserted by target devices which do not support burst data transfers.
PCI_TRDY	45	I/O	PCI target ready. PCI_TRDY indicates the ability of the PCI bus target to complete the current data phase of the transaction. A data phase is completed upon a rising edge of PCI_CLK where both PCI_IRDY and PCI_TRDY are asserted.

Table 2–7. IEEE 1394 PHY/Link Terminals

TERMINAL		I/O	DESCRIPTION
NAME	NO.		
PHY_CTL1 PHY_CTL0	92 93	I/O	PHY-link interface control. These bidirectional signals control passage of information between the two devices. The TSB12LV26 device can only drive these terminals after the PHY device has granted permission following a link request (PHY_LREQ).
PHY_DATA7 PHY_DATA6 PHY_DATA5 PHY_DATA4 PHY_DATA3 PHY_DATA2 PHY_DATA1 PHY_DATA0	81 82 84 85 86 88 89 90	I/O	PHY-link interface data. These bidirectional signals pass data between the TSB12LV26 and the PHY devices. These terminals are driven by the TSB12LV26 device on transmissions and are driven by the PHY device on receptions. Only PHY_DATA1–PHY_DATA0 are valid for 100M-bit speeds, PHY_DATA3–PHY_DATA0 are valid for 200M-bit speeds, and PHY_DATA7–PHY_DATA0 are valid for 400M-bit speeds.
PHY_LINKON	98	I/O	LinkOn wake indication. The PHY_LINKON signal is pulsed by the PHY device to activate the link, and 3.3-V signaling is required. When connected to the TSB41LV0X C/LKON terminal, a 1-k Ω series resistor is required between the link and PHY device.
PHY_LPS	99	I/O	Link power status. The PHY_LPS signal is asserted when the link is powered on, and 3.3-V signaling is required.
PHY_LREQ	97	O	Link request. This signal is driven by the TSB12LV26 device to initiate a request for the PHY device to perform some service.
PHY_SCLK	95	I	System clock. This input from the PHY device provides a 49.152-MHz clock signal for data synchronization.

Table 2–8. Miscellaneous Terminals

TERMINAL		I/O	DESCRIPTION
NAME	NO.		
CYCLEIN	78	I/O	The CYCLEIN terminal allows an external 8-kHz clock to be used as a cycle timer for synchronization with other system devices. If this terminal is not implemented, it must be pulled high to the link V_{CC} through a 4.7-k Ω resistor.
CYCLEOUT	77	I/O	This terminal provides an 8-kHz cycle timer synchronization signal.
GPIO2	2	I/O	General-purpose I/O [2]. This terminal defaults as an input and if it is not implemented, it is recommended that it be pulled low to ground with a 220- Ω resistor.
GPIO3	3	I/O	General-purpose I/O [3]. This terminal defaults as an input and if it is not implemented, it is recommended that it be pulled low to ground with a 220- Ω resistor.
$\overline{\text{REG_EN}}$	79	I	Regulator enable. This terminal is pulled low to ground through a 220- Ω resistor.
REG18	42 100	I	The REG18 terminals are connected to a 0.01 μF capacitor which, in turn, is connected to ground. The capacitor provides a local bypass for the internal core voltage.
SCL	4	I/O	Serial clock. The TSB12LV26 device determines whether a two-wire serial ROM or no serial ROM is implemented at reset. If a two-wire serial ROM is implemented, this terminal provides the SCL serial clock signaling. This terminal is implemented as open-drain, and for normal operation (a ROM is implemented in the design), this terminal must be pulled high to the ROM V_{CC} with a 2.7-k Ω resistor. Otherwise, it must be pulled low to ground with a 220- Ω resistor.
SDA	5	I/O	Serial data. The TSB12LV26 device determines whether a two-wire serial ROM or no serial ROM is implemented at reset. If a two-wire serial ROM is detected, this terminal provides the SDA serial data signaling. This terminal must be wired low to indicate no serial ROM is present. This terminal is implemented as open-drain, and for normal operation (a ROM is implemented in the design), this terminal must be pulled high to the ROM V_{CC} with a 2.7-k Ω resistor. Otherwise, it must be pulled low to ground with a 220- Ω resistor.

3 TSB12LV26 Controller Programming Model

This section describes the internal registers used to program the TSB12LV26 device. All registers are detailed in the same format: a brief description for each register is followed by the register offset and a bit table describing the reset state for each register.

A bit description table, typically included when the register contains bits of more than one type or purpose, indicates bit field names, field access tags which appear in the *type* column, and a detailed field description. Table 3–1 describes the field access tags.

Table 3–1. Bit Field Access Tag Descriptions

ACCESS TAG	NAME	MEANING
R	Read	Field can be read by software.
W	Write	Field can be written by software to any value.
S	Set	Field can be set by a write of 1. Writes of 0 have no effect.
C	Clear	Field can be cleared by a write of 1. Writes of 0 have no effect.
U	Update	Field can be autonomously updated by the TSB12LV26 device.

Figure 3–1 shows a simplified block diagram of the TSB12LV26 device.

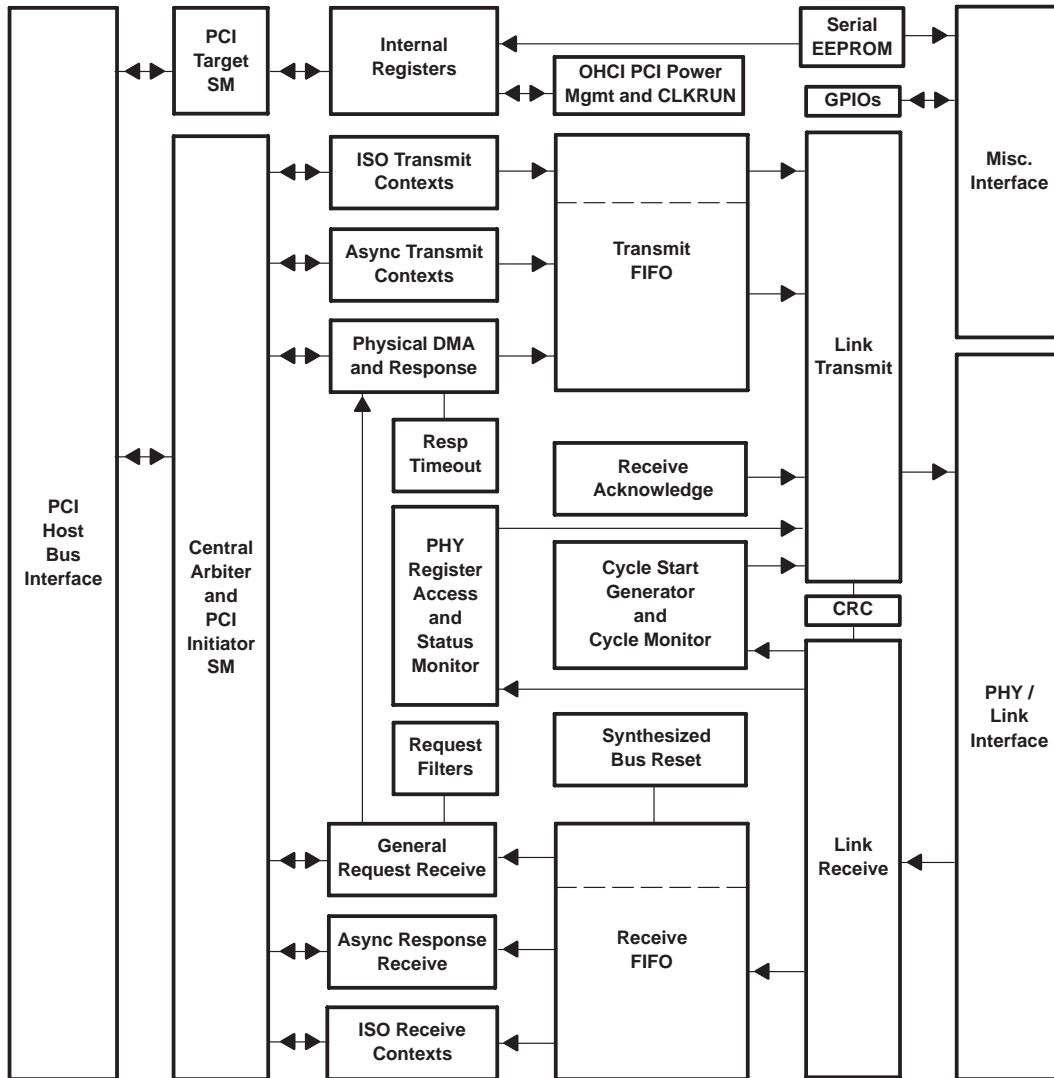

Figure 3-1. TSB12LV26 Block Diagram

3.1 PCI Configuration Registers

The TSB12LV26 device is a single-function PCI device. The configuration header is compliant with the *PCI Local Bus Specification* as a standard header. Table 3–2 illustrates the PCI configuration header that includes both the predefined portion of the configuration space and the user-definable registers.

Table 3–2. PCI Configuration Register Map

REGISTER NAME				OFFSET
Device ID		Vendor ID		00h
Status		Command		04h
Class code			Revision ID	08h
BIST	Header type	Latency timer	Cache line size	0Ch
OHCI registers base address				10h
TI extension registers base address				14h
Reserved				18h
Reserved				1Ch
Reserved				20h
Reserved				24h
Reserved				28h
Subsystem ID		Subsystem vendor ID		2Ch
Reserved				30h
Reserved			Power management capabilities pointer	34h
Reserved				38h
Maximum latency	Minimum grant	Interrupt pin	Interrupt line	3Ch
OHCI control register				40h
Power management capabilities		Next item pointer	Capability ID	44h
PM data	PMCSR_BSE	Power management CSR		48h
Reserved				4Ch–ECh
Miscellaneous configuration register				F0h
Link_Enhancements register				F4h
Subsystem ID alias		Subsystem vendor ID alias		F8h
GPIO3	GPIO2	Reserved		FCh

3.2 Vendor ID Register

The vendor ID register contains a value allocated by the PCI SIG and identifies the manufacturer of the PCI device. The vendor ID assigned to Texas Instruments is 104Ch.

Bit	15	14	13	12	11	10	9	8	7	6	5	4	3	2	1	0
Name	Vendor ID															
Type	R	R	R	R	R	R	R	R	R	R	R	R	R	R	R	R
Default	0	0	0	1	0	0	0	0	0	1	0	0	1	1	0	0

Register: **Vendor ID**
 Type: Read-only
 Offset: 00h
 Default: 104Ch

3.3 Device ID Register

The device ID register contains a value assigned to the TSB12LV26 device by Texas Instruments. The device identification for the TSB12LV26 device is 8020h.

Bit	15	14	13	12	11	10	9	8	7	6	5	4	3	2	1	0
Name	Device ID															
Type	R	R	R	R	R	R	R	R	R	R	R	R	R	R	R	R
Default	1	0	0	0	0	0	0	0	0	0	1	0	0	0	0	0

Register: **Device ID**
 Type: Read-only
 Offset: 02h
 Default: 8020h

3.4 Command Register

The command register provides control over the TSB12LV26 interface to the PCI bus. All bit functions adhere to the definitions in the *PCI Local Bus Specification*, as seen in the following bit descriptions. See Table 3–3 for a complete description of the register contents.

Bit	15	14	13	12	11	10	9	8	7	6	5	4	3	2	1	0
Name	Command															
Type	R	R	R	R	R	R	R	R/W	R	R/W	R	R/W	R	R/W	R/W	R
Default	0	0	0	0	0	0	0	0	0	0	0	0	0	0	0	0

Register: **Command**
 Type: Read/Write, Read-only
 Offset: 04h
 Default: 0000h

Table 3–3. Command Register Description

BIT	FIELD NAME	TYPE	DESCRIPTION
15–10	RSVD	R	Reserved. Bits 15–10 return 0s when read.
9	FBB_ENB	R	Fast back-to-back enable. The TSB12LV26 device does not generate fast back-to-back transactions; therefore, bit 9 returns 0 when read.
8	SERR_ENB	R/W	$\overline{\text{PCI_SERR}}$ enable. When bit 8 is set to 1, the TSB12LV26 $\overline{\text{PCI_SERR}}$ driver is enabled. $\overline{\text{PCI_SERR}}$ can be asserted after detecting an address parity error on the PCI bus.
7	STEP_ENB	R	Address/data stepping control. The TSB12LV26 device does not support address/data stepping; therefore, bit 7 is hardwired to 0.
6	PERR_ENB	R/W	Parity error enable. When bit 6 is set to 1, the TSB12LV26 device is enabled to drive $\overline{\text{PCI_PERR}}$ response to parity errors through the $\overline{\text{PCI_PERR}}$ signal.
5	VGA_ENB	R	VGA palette snoop enable. The TSB12LV26 device does not feature VGA palette snooping; therefore, bit 5 returns 0 when read.
4	MWI_ENB	R/W	Memory write and invalidate enable. When bit 4 is set to 1, the TSB12LV26 device is enabled to generate MWI PCI bus commands. If this bit is cleared, the TSB12LV26 device generates memory write commands instead.
3	SPECIAL	R	Special cycle enable. The TSB12LV26 function does not respond to special cycle transactions; therefore, bit 3 returns 0 when read.
2	MASTER_ENB	R/W	Bus master enable. When bit 2 is set to 1, the TSB12LV26 device is enabled to initiate cycles on the PCI bus.
1	MEMORY_ENB	R/W	Memory response enable. Setting bit 1 to 1 enables the TSB12LV26 device to respond to memory cycles on the PCI bus. This bit must be set to access OHCI registers.
0	IO_ENB	R	I/O space enable. The TSB12LV26 device does not implement any I/O-mapped functionality; therefore, bit 0 returns 0 when read.

3.5 Status Register

The status register provides status over the TSB12LV26 interface to the PCI bus. All bit functions adhere to the definitions in the *PCI Local Bus Specification*, as seen in the following bit descriptions. See Table 3–4 for a complete description of the register contents.

Bit	15	14	13	12	11	10	9	8	7	6	5	4	3	2	1	0
Name	Status															
Type	RCU	RCU	RCU	RCU	RCU	R	R	RCU	R	R	R	R	R	R	R	R
Default	0	0	0	0	0	0	1	0	0	0	0	1	0	0	0	0

Register: **Status**
 Type: Read/Clear/Update, Read-only
 Offset: 06h
 Default: 0210h

Table 3–4. Status Register Description

BIT	FIELD NAME	TYPE	DESCRIPTION
15	PAR_ERR	RCU	Detected parity error. Bit 15 is set to 1 when either an address parity or data parity error is detected.
14	SYS_ERR	RCU	Signaled system error. Bit 14 is set to 1 when $\overline{\text{PCI_SERR}}$ is enabled and the TSB12LV26 device has signaled a system error to the host.
13	MABORT	RCU	Received master abort. Bit 13 is set to 1 when a cycle initiated by the TSB12LV26 device on the PCI bus has been terminated by a master abort.
12	TABORT_REC	RCU	Received target abort. Bit 12 is set to 1 when a cycle initiated by the TSB12LV26 device on the PCI bus was terminated by a target abort.
11	TABORT_SIG	RCU	Signaled target abort. Bit 11 is set to 1 by the TSB12LV26 device when it terminates a transaction on the PCI bus with a target abort.
10–9	PCI_SPEED	R	DEVSEL timing. Bits 10 and 9 encode the timing of $\overline{\text{PCI_DEVSEL}}$ and are hardwired to 01b, indicating that the TSB12LV26 device asserts this signal at a medium speed on nonconfiguration cycle accesses.
8	DATAPAR	RCU	Data parity error detected. Bit 8 is set to 1 when the following conditions have been met: a. $\overline{\text{PCI_PERR}}$ was asserted by any PCI device including the TSB12LV26 device. b. The TSB12LV26 device was the bus master during the data parity error. c. Bit 6 (PERR_ENB) in the command register at offset 04h in the PCI configuration space (see Section 3.4, <i>Command Register</i>) is set to 1.
7	FBB_CAP	R	Fast back-to-back capable. The TSB12LV26 device cannot accept fast back-to-back transactions; therefore, bit 7 is hardwired to 0.
6	UDF	R	User-definable features (UDF) supported. The TSB12LV26 device does not support the UDF; therefore, bit 6 is hardwired to 0.
5	66MHZ	R	66-MHz capable. The TSB12LV26 device operates at a maximum PCI_CLK frequency of 33 MHz; therefore, bit 5 is hardwired to 0.
4	CAPLIST	R	Capabilities list. Bit 4 returns 1 when read, indicating that capabilities additional to standard PCI are implemented. The linked list of PCI power-management capabilities is implemented in this function.
3–0	RSVD	R	Reserved. Bits 3–0 return 0s when read.

3.6 Class Code and Revision ID Register

The class code and revision ID register categorizes the TSB12LV26 device as a serial bus controller (0Ch), controlling an IEEE 1394 bus (00h), with an OHCI programming model (10h). Furthermore, the TI chip revision is indicated in the least significant byte. See Table 3–5 for a complete description of the register contents.

Bit	31	30	29	28	27	26	25	24	23	22	21	20	19	18	17	16
Name	Class code and revision ID															
Type	R	R	R	R	R	R	R	R	R	R	R	R	R	R	R	R
Default	0	0	0	0	1	1	0	0	0	0	0	0	0	0	0	0
Bit	15	14	13	12	11	10	9	8	7	6	5	4	3	2	1	0
Name	Class code and revision ID															
Type	R	R	R	R	R	R	R	R	R	R	R	R	R	R	R	R
Default	0	0	0	1	0	0	0	0	0	0	0	0	0	0	0	0

Register: **Class code and revision ID**
 Type: Read-only
 Offset: 08h
 Default: 0C00 1000h

Table 3–5. Class Code and Revision ID Register Description

BIT	FIELD NAME	TYPE	DESCRIPTION
31–24	BASECLASS	R	Base class. This field returns 0Ch when read, which broadly classifies the function as a serial bus controller.
23–16	SUBCLASS	R	Subclass. This field returns 00h when read, which specifically classifies the function as controlling an IEEE 1394 serial bus.
15–8	PGMIF	R	Programming interface. This field returns 10h when read, indicating that the programming model is compliant with the <i>1394 Open Host Controller Interface Specification</i> .
7–0	CHIPREV	R	Silicon revision. This field returns 00h when read, indicating the silicon revision of the TSB12LV26 device.

3.7 Latency Timer and Class Cache Line Size Register

The latency timer and class cache line size register is programmed by host BIOS to indicate system cache line size and the latency timer associated with the TSB12LV26 device. See Table 3–6 for a complete description of the register contents.

Bit	15	14	13	12	11	10	9	8	7	6	5	4	3	2	1	0
Name	Latency timer and class cache line size															
Type	R/W	R/W	R/W	R/W	R/W	R/W	R/W	R/W	R/W	R/W	R/W	R/W	R/W	R/W	R/W	R/W
Default	0	0	0	0	0	0	0	0	0	0	0	0	0	0	0	0

Register: **Latency timer and class cache line size**
 Type: Read/Write
 Offset: 0Ch
 Default: 0000h

Table 3–6. Latency Timer and Class Cache Line Size Register Description

BIT	FIELD NAME	TYPE	DESCRIPTION
15–8	LATENCY_TIMER	R/W	PCI latency timer. The value in this register specifies the latency timer for the TSB12LV26 device, in units of PCI clock cycles. When the TSB12LV26 device is a PCI bus initiator and asserts PCI_FRAME, the latency timer begins counting from zero. If the latency timer expires before the TSB12LV26 transaction has terminated, the TSB12LV26 device terminates the transaction when its PCI_GNT is deasserted.
7–0	CACHELINE_SZ	R/W	Cache line size. This value is used by the TSB12LV26 device during memory write and invalidate, memory-read line, and memory-read multiple transactions.

3.8 Header Type and BIST Register

The header type and built-in self-test (BIST) register indicates the TSB12LV26 PCI header type and no built-in self-test. See Table 3–7 for a complete description of the register contents.

Bit	15	14	13	12	11	10	9	8	7	6	5	4	3	2	1	0
Name	Header type and BIST															
Type	R	R	R	R	R	R	R	R	R	R	R	R	R	R	R	R
Default	0	0	0	0	0	0	0	0	0	0	0	0	0	0	0	0

Register: **Header type and BIST**
 Type: Read-only
 Offset: 0Eh
 Default: 0000h

Table 3–7. Header Type and BIST Register Description

BIT	FIELD NAME	TYPE	DESCRIPTION
15–8	BIST	R	Built-in self-test. The TSB12LV26 device does not include a BIST; therefore, this field returns 00h when read.
7–0	HEADER_TYPE	R	PCI header type. The TSB12LV26 device includes the standard PCI header, which is communicated by returning 00h when this field is read.

3.9 OHCI Base Address Register

The OHCI base address register is programmed with a base address referencing the memory-mapped OHCI control. When BIOS writes all 1s to this register, the value read back is FFFF F800h, indicating that at least 2K bytes of memory address space are required for the OHCI registers. See Table 3–8 for a complete description of the register contents.

Bit	31	30	29	28	27	26	25	24	23	22	21	20	19	18	17	16
Name	OHCI base address															
Type	R/W	R/W	R/W	R/W	R/W	R/W	R/W	R/W	R/W	R/W	R/W	R/W	R/W	R/W	R/W	R/W
Default	0	0	0	0	0	0	0	0	0	0	0	0	0	0	0	0
Bit	15	14	13	12	11	10	9	8	7	6	5	4	3	2	1	0
Name	OHCI address															
Type	R/W	R/W	R/W	R/W	R/W	R	R	R	R	R	R	R	R	R	R	R
Default	0	0	0	0	0	0	0	0	0	0	0	0	0	0	0	0

Register: **OHCI base address**
 Type: Read/Write, Read-only
 Offset: 10h
 Default: 0000 0000h

Table 3–8. OHCI Base Address Register Description

BIT	FIELD NAME	TYPE	DESCRIPTION
31–11	OHCIREG_PTR	R/W	OHCI register pointer. Specifies the upper 21 bits of the 32-bit OHCI base address register.
10–4	OHCI_SZ	R	OHCI register size. This field returns 0s when read, indicating that the OHCI registers require a 2K-byte region of memory.
3	OHCI_PF	R	OHCI register prefetch. This bit returns 0 when read, indicating that the OHCI registers are nonprefetchable.
2–1	OHCI_MEMTYPE	R	OHCI memory type. This field returns 0s when read, indicating that the OHCI base address register is 32 bits wide and mapping can be done anywhere in the 32-bit memory space.
0	OHCI_MEM	R	OHCI memory indicator. Bit 0 returns 0 when read, indicating that the OHCI registers are mapped into system memory space.

3.10 TI Extension Base Address Register

The TI extension base address register is programmed with a base address referencing the memory-mapped TI extension registers. See Section 3.9, *OHCI Base Address Register* for bit field details.

Bit	31	30	29	28	27	26	25	24	23	22	21	20	19	18	17	16
Name	TI extension base address															
Type	R/W	R/W	R/W	R/W	R/W	R/W	R/W	R/W	R/W	R/W	R/W	R/W	R/W	R/W	R/W	R/W
Default	0	0	0	0	0	0	0	0	0	0	0	0	0	0	0	0
Bit	15	14	13	12	11	10	9	8	7	6	5	4	3	2	1	0
Name	TI extension base address															
Type	R/W	R/W	R/W	R/W	R/W	R	R	R	R	R	R	R	R	R	R	R
Default	0	0	0	0	0	0	0	0	0	0	0	0	0	0	0	0

Register: **TI extension base address**
 Type: Read/Write, Read-only
 Offset: 14h
 Default: 0000 0000h

3.11 Subsystem Identification Register

The subsystem identification register is used for system and option card identification purposes. This register can be initialized from the serial EEPROM or programmed via the subsystem access register at offset F8h in PCI configuration space (see Section 3.22, *Subsystem Access Register*). See Table 3–9 for a complete description of the register contents.

Bit	31	30	29	28	27	26	25	24	23	22	21	20	19	18	17	16
Name	Subsystem identification															
Type	RU	RU	RU	RU	RU	RU	RU	RU	RU	RU	RU	RU	RU	RU	RU	RU
Default	0	0	0	0	0	0	0	0	0	0	0	0	0	0	0	0
Bit	15	14	13	12	11	10	9	8	7	6	5	4	3	2	1	0
Name	Subsystem identification															
Type	RU	RU	RU	RU	RU	RU	RU	RU	RU	RU	RU	RU	RU	RU	RU	RU
Default	0	0	0	0	0	0	0	0	0	0	0	0	0	0	0	0

Register: **Subsystem identification**
 Type: Read/Update
 Offset: 2Ch
 Default: 0000 0000h

Table 3–9. Subsystem Identification Register Description

BIT	FIELD NAME	TYPE	DESCRIPTION
31–16	OHCI_SSID	RU	Subsystem device ID. This field indicates the subsystem device ID.
15–0	OHCI_SSVID	RU	Subsystem vendor ID. This field indicates the subsystem vendor ID.

3.12 Power Management Capabilities Pointer Register

The power management capabilities pointer register provides a pointer into the PCI configuration header where the PCI power-management register block resides. The TSB12LV26 configuration header doublewords at offsets 44h and 48h provide the power-management registers. This register is read-only and returns 44h when read.

Bit	7	6	5	4	3	2	1	0
Name	Power management capabilities pointer							
Type	R	R	R	R	R	R	R	R
Default	0	1	0	0	0	1	0	0

Register: **Power management capabilities pointer**
 Type: Read-only
 Offset: 34h
 Default: 44h

3.13 Interrupt Line and Pin Register

The interrupt line and pin register communicates interrupt line routing information. See Table 3–10 for a complete description of the register contents.

Bit	15	14	13	12	11	10	9	8	7	6	5	4	3	2	1	0
Name	Interrupt line and pin															
Type	R	R	R	R	R	R	R	R	R/W	R/W	R/W	R/W	R/W	R/W	R/W	R/W
Default	0	0	0	0	0	0	0	1	0	0	0	0	0	0	0	0

Register: **Interrupt line and pin**
 Type: Read/Write, Read-only
 Offset: 3Ch
 Default: 0100h

Table 3–10. Interrupt Line and Pin Register Description

BIT	FIELD NAME	TYPE	DESCRIPTION
15–8	INTR_PIN	R	Interrupt pin. This field returns 01h when read, indicating that the TSB12LV26 PCI function signals interrupts on the PCI_INTA terminal.
7–0	INTR_LINE	R/W	Interrupt line. This field is programmed by the system and indicates to software which interrupt line the TSB12LV26 PCI_INTA is connected to.

3.14 MIN_GNT and MAX_LAT Register

The MIN_GNT and MAX_LAT register communicates to the system the desired setting of bits 15–8 in the latency timer and class cache line size register at offset 0Ch in PCI configuration space (see Section 3.7, *Latency Timer and Class Cache Line Size Register*). If a serial EEPROM is detected, the contents of this register are loaded through the serial EEPROM interface after a PCI_RST. If no serial EEPROM is detected, this register returns a default value that corresponds to the MIN_GNT = 2, MAX_LAT = 4. See Table 3–11 for a complete description of the register contents.

Bit	15	14	13	12	11	10	9	8	7	6	5	4	3	2	1	0
Name	MIN_GNT and MAX_LAT															
Type	RU	RU	RU	RU	RU	RU	RU	RU	RU	RU	RU	RU	RU	RU	RU	RU
Default	0	0	0	0	0	1	0	0	0	0	0	0	0	0	1	0

Register: **MIN_GNT and MAX_LAT**
 Type: Read/Update
 Offset: 3Eh
 Default: 0402h

Table 3–11. MIN_GNT and MAX_LAT Register Description

BIT	FIELD NAME	TYPE	DESCRIPTION
15–8	MAX_LAT	RU	Maximum latency. The contents of this field may be used by host BIOS to assign an arbitration priority level to the TSB12LV26 device. The default for this register indicates that the TSB12LV26 device may need to access the PCI bus as often as every 0.25 μs; thus, an extremely high priority level is requested. The contents of this field may also be loaded through the serial EEPROM.
7–0	MIN_GNT	RU	Minimum grant. The contents of this field may be used by host BIOS to assign a latency timer register value to the TSB12LV26 device. The default for this register indicates that the TSB12LV26 device may need to sustain burst transfers for nearly 64 μs; thus, requesting a large value be programmed in bits 15–8 of the TSB12LV26 latency timer and class cache line size register at offset 0Ch in PCI configuration space (see Section 3.7, <i>Latency Timer and Class Cache Line Size Register</i>).

3.15 OHCI Control Register

The OHCI control register is defined by the *1394 Open Host Controller Interface Specification* and provides a bit for big endian PCI support. See Table 3–12 for a complete description of the register contents.

Bit	31	30	29	28	27	26	25	24	23	22	21	20	19	18	17	16
Name	OHCI control															
Type	R	R	R	R	R	R	R	R	R	R	R	R	R	R	R	R
Default	0	0	0	0	0	0	0	0	0	0	0	0	0	0	0	0
Bit	15	14	13	12	11	10	9	8	7	6	5	4	3	2	1	0
Name	OHCI control															
Type	R	R	R	R	R	R	R	R	R	R	R	R	R	R	R	R/W
Default	0	0	0	0	0	0	0	0	0	0	0	0	0	0	0	0

Register: **OHCI control**
 Type: Read/Write, Read-only
 Offset: 40h
 Default: 0000 0000h

Table 3–12. OHCI Control Register Description

BIT	FIELD NAME	TYPE	DESCRIPTION
31–1	RSVD	R	Reserved. Bits 31–1 return 0s when read.
0	GLOBAL_SWAP	R/W	When bit 0 is set to 1, all quadlets read from and written to the PCI interface are byte-swapped (big endian). This bit is loaded from serial EEPROM and must be cleared to 0 for normal IBM-compatible operation.

3.16 Capability ID and Next Item Pointer Register

The capability ID and next item pointer register identifies the linked-list capability item and provides a pointer to the next capability item. See Table 3–13 for a complete description of the register contents.

Bit	15	14	13	12	11	10	9	8	7	6	5	4	3	2	1	0
Name	Capability ID and next item pointer															
Type	R	R	R	R	R	R	R	R	R	R	R	R	R	R	R	R
Default	0	0	0	0	0	0	0	0	0	0	0	0	0	0	0	1

Register: **Capability ID and next item pointer**
 Type: Read-only
 Offset: 44h
 Default: 0001h

Table 3–13. Capability ID and Next Item Pointer Register Description

BIT	FIELD NAME	TYPE	DESCRIPTION
15–8	NEXT_ITEM	R	Next item pointer. The TSB12LV26 device supports only one additional capability that is communicated to the system through the extended capabilities list; therefore, this field returns 00h when read.
7–0	CAPABILITY_ID	R	Capability identification. This field returns 01h when read, which is the unique ID assigned by the PCI SIG for PCI power-management capability.

3.17 Power Management Capabilities Register

The power management capabilities register indicates the capabilities of the TSB12LV26 device related to PCI power management. See Table 3–14 for a complete description of the register contents.

Bit	15	14	13	12	11	10	9	8	7	6	5	4	3	2	1	0
Name	Power management capabilities															
Type	RU	RU	RU	RU	RU	RU	R	R	R	R	R	R	R	R	R	R
Default	0	1	1	0	0	1	0	0	0	0	0	0	0	0	0	1

Register: **Power management capabilities**

Type: Read/Update, Read-only

Offset: 46h

Default: 6401h

Table 3–14. Power Management Capabilities Register Description

BIT	FIELD NAME	TYPE	DESCRIPTION
15	PME_D3COLD	RU	PCI_PME support from D3 _{cold} . This bit can be set to 1 or cleared to 0 via bit 15 (PME_D3COLD) in the miscellaneous configuration register at offset F0h in the PCI configuration space (see Section 3.20, <i>Miscellaneous Configuration Register</i>). The miscellaneous configuration register is loaded from ROM. When this bit is set to 1, it indicates that the TSB12LV26 device is capable of generating a PCI_PME wake event from D3 _{cold} . This bit state is dependent upon the TSB12LV26 V _{AUX} implementation and may be configured by using bit 15 (PME_D3COLD) in the miscellaneous configuration register.
14–11	PME_SUPPORT	RU	PCI_PME support. This 4-bit field indicates the power states from which the TSB12LV26 device may assert PCI_PME. This field returns a value of 1100b by default, indicating that PCI_PME may be asserted from the D3 _{hot} and D2 power states. Bit 13 may be modified by host software using bit 13 (PME_SUPPORT_D2) in the miscellaneous configuration register at offset F0h in the PCI configuration space (see Section 3.20, <i>Miscellaneous Configuration Register</i>).
10	D2_SUPPORT	RU	D2 support. This bit can be set or cleared via bit 10 (D2_SUPPORT) in the miscellaneous configuration register at offset F0h in the PCI configuration space (see Section 3.20, <i>Miscellaneous Configuration Register</i>). The miscellaneous configuration register is loaded from serial EEPROM. When this bit is set to 1, it indicates that D2 support is present. When this bit is cleared, it indicates that D2 support is not present for backward compatibility with the TSB12LV22 device. For normal operation, this bit is set to 1.
9	D1_SUPPORT	R	D1 support. Bit 9 returns a 0 when read, indicating that the TSB12LV26 device does not support the D1 power state.
8	DYN_DATA	R	Dynamic data support. Bit 8 returns a 0 when read, indicating that the TSB12LV26 device does not report dynamic power-consumption data.
7–6	RSVD	R	Reserved. Bits 7 and 6 return 0s when read.
5	DSI	R	Device-specific initialization. Bit 5 returns 0 when read, indicating that the TSB12LV26 device does not require special initialization beyond the standard PCI configuration header before a generic class driver is able to use it.
4	AUX_PWR	R	Auxiliary power source. Since the TSB12LV26 device does not support PCI_PME generation in the D3 _{cold} device state, bit 4 returns 0 when read.
3	PME_CLK	R	PME clock. Bit 3 returns 0 when read, indicating that no host bus clock is required for the TSB12LV26 device to generate PCI_PME.
2–0	PM_VERSION	R	Power-management version. This field returns 001b when read, indicating that the TSB12LV26 device is compatible with the registers described in the <i>PCI Bus Power Management Interface Specification</i> (Revision 1.0).

3.18 Power Management Control and Status Register

The power management control and status register implements the control and status of the PCI power management function. This register is not affected by the internally generated reset caused by the transition from the D3_{hot} to D0 state. See Table 3–15 for a complete description of the register contents.

Bit	15	14	13	12	11	10	9	8	7	6	5	4	3	2	1	0
Name	Power management control and status															
Type	RC	R	R	R	R	R	R	R/W	R	R	R	R	R	R	R/W	R/W
Default	0	0	0	0	0	0	0	0	0	0	0	0	0	0	0	0

Register: **Power management control and status**
 Type: Read/Clear, Read/Write, Read-only
 Offset: 48h
 Default: 0000h

Table 3–15. Power Management Control and Status Register Description

BIT	FIELD NAME	TYPE	DESCRIPTION
15	PME_STS	RC	Bit 15 is set to 1 when the TSB12LV26 device normally asserts the <u>PCI_PME</u> signal, independent of the state of bit 8 (PME_ENB). This bit is cleared by a writeback of 1, which also clears the <u>PCI_PME</u> signal driven by the TSB12LV26 device. Writing a 0 to this bit has no effect.
14–9	DYN_CTRL	R	Dynamic data control. This field returns 0s when read since the TSB12LV26 device does not report dynamic data.
8	PME_ENB	R/W	When bit 8 is set to 1, <u>PCI_PME</u> assertion is enabled. When bit 8 is cleared, <u>PCI_PME</u> assertion is disabled. This bit defaults to 0 if the function does not support <u>PCI_PME</u> generation from D3 _{cold} . If the function supports <u>PCI_PME</u> from D3 _{cold} , this bit is sticky and must be explicitly cleared by the operating system each time it is initially loaded. Functions that do not support <u>PCI_PME</u> generation from any D-state (that is, bits 15–11 in the power management capabilities register at offset 46h in PCI configuration space (see Section 3.17, <i>Power Management Capabilities Register</i>) equal 00000b), may hardwire this bit to be read-only, always returning a 0 when read by system software.
7–5	RSVD	R	Reserved. Bits 7–5 return 0s when read.
4	DYN_DATA	R	Dynamic data. Bit 4 returns 0 when read since the TSB12LV26 device does not report dynamic data.
3–2	RSVD	R	Reserved. Bits 3 and 2 return 0s when read.
1–0	PWR_STATE	R/W	Power state. This 2-bit field sets the TSB12LV26 device power state and is encoded as follows: 00 = Current power state is D0. 01 = Current power state is D1 (not supported by this device). 10 = Current power state is D2. 11 = Current power state is D3 _{hot} .

3.19 Power Management Extension Register

The power management extension register provides extended power management features not applicable to the TSB12LV26 device; thus, it is read-only and returns 0s when read. See Table 3–16 for a complete description of the register contents.

Bit	15	14	13	12	11	10	9	8	7	6	5	4	3	2	1	0
Name	Power management extension															
Type	R	R	R	R	R	R	R	R	R	R	R	R	R	R	R	R
Default	0	0	0	0	0	0	0	0	0	0	0	0	0	0	0	0

Register: **Power management extension**
 Type: Read-only
 Offset: 4Ah
 Default: 0000h

Table 3–16. Power Management Extension Register Description

BIT	FIELD NAME	TYPE	DESCRIPTION
15–8	PM_DATA	R	Power management data. This field returns 00h when read since the TSB12LV26 device does not report dynamic data.
7–0	PMCSR_BSE	R	Power management CSR – bridge support extensions. This field returns 00h when read since the TSB12LV26 device does not provide P2P bridging.

3.20 Miscellaneous Configuration Register

The miscellaneous configuration register provides miscellaneous PCI-related configuration. See Table 3–17 for a complete description of the register contents.

Bit	31	30	29	28	27	26	25	24	23	22	21	20	19	18	17	16
Name	Miscellaneous configuration															
Type	R	R	R	R	R	R	R	R	R	R	R	R	R	R	R	R
Default	0	0	0	0	0	0	0	0	0	0	0	0	0	0	0	0
Bit	15	14	13	12	11	10	9	8	7	6	5	4	3	2	1	0
Name	Miscellaneous configuration															
Type	R/W	R	R/W	R	R	R/W	R	R	R	R	R	R/W	R/W	R/W	R/W	R/W
Default	0	0	1	0	0	1	0	0	0	0	0	0	0	0	0	0

Register: **Miscellaneous configuration**
 Type: Read/Write, Read-only
 Offset: F0h
 Default: 0000 2400h

Table 3–17. Miscellaneous Configuration Register

BIT	FIELD NAME	TYPE	DESCRIPTION
31–16	RSVD	R	Reserved. Bits 31–16 return 0s when read.
15	PME_D3COLD	R/W	PCI_PME support from D3 _{cold} . This bit programs bit 15 (PME_D3COLD) in the power management capabilities register at offset 46h in PCI configuration space (see Section 3.17, <i>Power Management Capabilities Register</i>).
14	RSVD	R	Reserved. Bit 14 returns 0 when read.
13	PME_SUPPORT_D2	R/W	PCI_PME support. This bit programs bit 13 (PME_SUPPORT_D2) in the power management capabilities register at offset 46h in PCI configuration space (see Section 3.17, <i>Power Management Capabilities Register</i>). If wake up from the D2 power state implemented in the TSB12LV26 device is not desired, this bit is cleared to indicate to power-management software that wake-up from D2 is not supported.
12–11	RSVD	R	Reserved. Bits 12 and 11 return 0s when read.
10	D2_SUPPORT	R/W	D2 support. This bit programs bit 10 (D2_SUPPORT) in the power management capabilities register at offset 46h in PCI configuration space (see Section 3.17, <i>Power Management Capabilities Register</i>). If the D2 power state in the TSB12LV26 device is not desired, this bit is cleared to indicate to power-management software that D2 is not supported.
9–5	RSVD	R	Reserved. Bits 9–5 return 0s when read.
4	DIS_TGT_ABT	R/W	Bit 4 defaults to 0, which provides OHCI-Lynx™ compatible target abort signaling. When this bit is set to 1, it enables the no-target-abort mode, in which the TSB12LV26 device returns indeterminate data instead of signaling target abort. The link is divided into the PCI_CLK and SCLK domains. If software tries to access registers in the link that are not active because the SCLK is disabled, a target abort is issued by the link. On some systems, this can cause a problem resulting in a fatal system error. Enabling this bit allows the link to respond to these types of requests by returning FFh. It is recommended that this bit be set to 1.
3	GP2IIC	R/W	When bit 3 is set to 1, the GPIO3 and GPIO2 signals are internally routed to the SCL and SDA, respectively. The GPIO3 and GPIO2 terminals are also placed in a high-impedance state.
2	DISABLE_SCLKGATE	R/W	When bit 2 is set to 1, the internal SCLK runs identically with the chip input. This is a test feature only and must be cleared to 0 (all applications).
1	DISABLE_PCIGATE	R/W	When bit 1 is set to 1, the internal PCI clock runs identically with the chip input. This is a test feature only and must be cleared to 0 (all applications).
0	KEEP_PCLK	R/W	When bit 0 is set to 1, the PCI clock is always kept running through the PCI_CLKRUN protocol. When this bit is cleared, the PCI clock can be stopped using PCI_CLKRUN.

3.21 Link Enhancement Control Register

The link enhancement control register implements TI proprietary bits that are initialized by software or by a serial EEPROM, if present. After these bits are set to 1, their functionality is enabled only if bit 22 (aPhyEnhanceEnable) in the host controller control register at OHCI offset 50h/54h (see Section 4.16, *Host Controller Control Register*) is set to 1. See Table 3–18 for a complete description of the register contents.

Bit	31	30	29	28	27	26	25	24	23	22	21	20	19	18	17	16
Name	Link enhancement control															
Type	R	R	R	R	R	R	R	R	R	R	R	R	R	R	R	R
Default	0	0	0	0	0	0	0	0	0	0	0	0	0	0	0	0
Bit	15	14	13	12	11	10	9	8	7	6	5	4	3	2	1	0
Name	Link enhancement control															
Type	R	R	R/W	R/W	R	R	R	R	R/W	R	R	R	R	R/W	R/W	R
Default	0	0	0	1	0	0	0	0	0	0	0	0	0	0	0	0

Register: **Link enhancement control**

Type: Read/Write, Read-only

Offset: F4h

Default: 0000 1000h

Table 3–18. Link Enhancement Control Register Description

BIT	FIELD NAME	TYPE	DESCRIPTION
31–14	RSVD	R	Reserved. Bits 31–14 return 0s when read.
13–12	atx_thresh	R/W	<p>This field sets the initial AT threshold value, which is used until the AT FIFO is underrun. When the TSB12LV26 device retries the packet, it uses a 2K-byte threshold, resulting in a store-and-forward operation.</p> <ul style="list-style-type: none"> 00 = Threshold ~ 2K bytes resulting in a store-and-forward operation 01 = Threshold ~ 1.7K bytes (default) 10 = Threshold ~ 1K bytes 11 = Threshold ~ 512 bytes <p>These bits fine-tune the asynchronous transmit threshold. For most applications the 1.7-K threshold is optimal. Changing this value may increase or decrease the 1394 latency depending on the average PCI bus latency.</p> <p>Setting the AT threshold to 1.7K, 1K, or 512 bytes results in data being transmitted at these thresholds or when an entire packet has been checked into the FIFO. If the packet to be transmitted is larger than the AT threshold, the remaining data must be received before the AT FIFO is emptied; otherwise, an underrun condition will occur, resulting in a packet error at the receiving node. As a result, the link will then commence store-and-forward operation—that is, wait until it has the complete packet in the FIFO before retransmitting it on the second attempt, to ensure delivery.</p> <p>An AT threshold of 2K results in store-and-forward operation, which means that asynchronous data will not be transmitted until an end-of-packet token is received. Restated, setting the AT threshold to 2K results in only complete packets being transmitted.</p> <p>Note that this device always uses store-and-forward when the asynchronous transmit retries register at OHCI offset 08h (see Section 4.3, <i>Asynchronous Transmit Retries Register</i>) is cleared.</p>
11–8	RSVD	R	Reserved. Bits 11–8 return 0s when read.
7	enab_unfair	R/W	Enable asynchronous priority requests. OHCI-Lynx™ compatible. Setting bit 7 to 1 enables the link to respond to requests with priority arbitration. It is recommended that this bit be set to 1.
6	RSVD	R	This bit is not assigned in the TSB12LV26 follow-on products, since this bit location loaded by the serial EEPROM from the enhancements field corresponds to bit 23 (programPhyEnable) in the host controller control register at OHCI offset 50h/54h (see Section 4.16, <i>Host Controller Control Register</i>).
5–3	RSVD	R	Reserved. Bits 5–3 return 0s when read.

Table 3–18. Link Enhancement Control Register Description (Continued)

BIT	FIELD NAME	TYPE	DESCRIPTION
2	enab_insert_idle	R/W	Enable insert idle. OHCI-Lynx™ compatible. When the PHY device has control of the PHY_CTL0 and PHY_CTL1 control lines and the PHY_DATA0–PHY_DATA7 data lines and the link requests control, the PHY device drives 11b on the PHY_CTL0 and PHY_CTL1 lines. The link can then start driving these lines immediately. Setting bit 2 to 1 inserts an idle state, so the link waits one clock cycle before it starts driving the lines (turnaround time). It is recommended that this bit be set to 1.
1	enab_accel	R/W	Enable acceleration enhancements. OHCI-Lynx™ compatible. When bit 1 is set to 1, the PHY device is notified that the link supports the IEEE 1394a-2000 acceleration enhancements, that is, ack-accelerated, fly-by concatenation, etc. It is recommended that this bit be set to 1.
0	RSVD	R	Reserved. Bit 0 returns 0 when read.

3.22 Subsystem Access Register

Write access to the subsystem access register updates the subsystem identification registers identically to OHCI-Lynx™. The system ID value written to this register may also be read back from this register. See Table 3–19 for a complete description of the register contents.

Bit	31	30	29	28	27	26	25	24	23	22	21	20	19	18	17	16
Name	Subsystem access															
Type	R/W	R/W	R/W	R/W	R/W	R/W	R/W	R/W	R/W	R/W	R/W	R/W	R/W	R/W	R/W	R/W
Default	0	0	0	0	0	0	0	0	0	0	0	0	0	0	0	0
Bit	15	14	13	12	11	10	9	8	7	6	5	4	3	2	1	0
Name	Subsystem access															
Type	R/W	R/W	R/W	R/W	R/W	R/W	R/W	R/W	R/W	R/W	R/W	R/W	R/W	R/W	R/W	R/W
Default	0	0	0	0	0	0	0	0	0	0	0	0	0	0	0	0

Register: **Subsystem access**
 Type: Read/Write
 Offset: F8h
 Default: 0000 0000h

Table 3–19. Subsystem Access Register Description

BIT	FIELD NAME	TYPE	DESCRIPTION
31–16	SUBDEV_ID	R/W	Subsystem device ID alias. This field indicates the subsystem device ID.
15–0	SUBVEN_ID	R/W	Subsystem vendor ID alias. This field indicates the subsystem vendor ID.

3.23 GPIO Control Register

The GPIO control register has the control and status bits for the GPIO2 and GPIO3 ports. See Table 3–20 for a complete description of the register contents.

Bit	31	30	29	28	27	26	25	24	23	22	21	20	19	18	17	16
Name	GPIO control															
Type	R/W	R	R/W	R/W	R	R	R	RWU	R/W	R	R/W	R/W	R	R	R	RWU
Default	0	0	0	0	0	0	0	0	0	0	0	0	0	0	0	0
Bit	15	14	13	12	11	10	9	8	7	6	5	4	3	2	1	0
Name	GPIO control															
Type	R	R	R	R	R	R	R	R	R	R	R	R	R	R	R	R
Default	0	0	0	0	0	0	0	0	0	0	0	0	0	0	0	0

Register: **GPIO control**
 Type: Read/Write/Update, Read/Write, Read-only
 Offset: FCh
 Default: 0000 0000h

Table 3–20. GPIO Control Register Description

BIT	FIELD NAME	TYPE	DESCRIPTION
31	INT_3EN	R/W	When bit 31 is set to 1, a TSB12LV26 general-purpose interrupt event occurs on a level change of the GPIO3 input. This event can generate an interrupt, with mask and event status reported through the interrupt mask register at OHCI offset 88h/8Ch (see Section 4.22, <i>Interrupt Mask Register</i>) and interrupt event register at OHCI offset 80h/84h (see Section 4.21, <i>Interrupt Event Register</i>).
30	RSVD	R	Reserved. Bit 30 returns 0 when read.
29	GPIO_INV3	R/W	GPIO3 polarity invert. When bit 29 is set to 1, the polarity of GPIO3 is inverted.
28	GPIO_ENB3	R/W	GPIO3 enable control. When bit 28 is set to 1, the output is enabled. Otherwise, the output is high impedance.
27–25	RSVD	R	Reserved. Bits 27–25 return 0s when read.
24	GPIO_DATA3	RWU	GPIO3 data. Reads from bit 24 return the logical value of the input to GPIO3. Writes to this bit update the value to drive to GPIO3 when output is enabled.
23	INT_2EN	R/W	When bit 23 is set to 1, a TSB12LV26 general-purpose interrupt event occurs on a level change of the GPIO2 input. This event may generate an interrupt, with mask and event status reported through the interrupt mask register at OHCI offset 88h/8Ch (see Section 4.22, <i>Interrupt Mask Register</i>) and interrupt event register at OHCI offset 80h/84h (see Section 4.21, <i>Interrupt Event Register</i>).
22	RSVD	R	Reserved. Bit 22 returns 0 when read.
21	GPIO_INV2	R/W	GPIO2 polarity invert. When bit 21 is set to 1, the polarity of GPIO2 is inverted.
20	GPIO_ENB2	R/W	GPIO2 enable control. When bit 20 is set to 1, the output is enabled. Otherwise, the output is high impedance.
19–17	RSVD	R	Reserved. Bits 19–17 return 0s when read.
16	GPIO_DATA2	RWU	GPIO2 data. Reads from bit 16 return the logical value of the input to GPIO2. Writes to this bit update the value to drive to GPIO2 when the output is enabled.
15–0	RSVD	R	Reserved. Bits 15–0 return 0s when read.

4 OHCI Registers

The OHCI registers defined by the *1394 Open Host Controller Interface Specification* are memory-mapped into a 2K-byte region of memory pointed to by the OHCI base address register at offset 10h in PCI configuration space (see Section 3.9, *OHCI Base Address Register*). These registers are the primary interface for controlling the TSB12LV26 IEEE 1394 link function.

This section provides the register interface and bit descriptions. Several set/clear register pairs in this programming model are implemented to solve various issues with typical read-modify-write control registers. There are two addresses for a set/clear register: RegisterSet and RegisterClear. See Table 4–1 for a register listing. A 1 bit written to RegisterSet causes the corresponding bit in the set/clear register to be set to 1; a 0 bit leaves the corresponding bit unaffected. A 1 bit written to RegisterClear causes the corresponding bit in the set/clear register to be cleared; a 0 bit leaves the corresponding bit in the set/clear register unaffected.

Typically, a read from either RegisterSet or RegisterClear returns the contents of the set or clear register, respectively. However, sometimes reading the RegisterClear provides a masked version of the set or clear register. The interrupt event register is an example of this behavior.

Table 4–1. OHCI Register Map

DMA CONTEXT	REGISTER NAME	ABBREVIATION	OFFSET
—	OHCI version	Version	00h
	GUID ROM	GUID_ROM	04h
	Asynchronous transmit retries	ATRetries	08h
	CSR data	CSRData	0Ch
	CSR compare data	CSRCompareData	10h
	CSR control	CSRControl	14h
	Configuration ROM header	ConfigROMhdr	18h
	Bus identification	BusID	1Ch
	Bus options	BusOptions	20h
	GUID high	GUIDHi	24h
	GUID low	GUIDLo	28h
	Reserved	—	2Ch–30h
	Configuration ROM map	ConfigROMmap	34h
	Posted write address low	PostedWriteAddressLo	38h
	Posted write address high	PostedWriteAddressHi	3Ch
	Vendor identification	VendorID	40h–4Ch
	Host controller control	HCControlSet	50h
		HCControlClr	54h
	Reserved	—	58h–5Ch

Table 4–1. OHCI Register Map (Continued)

DMA CONTEXT	REGISTER NAME	ABBREVIATION	OFFSET
Self ID	Reserved	—	60h
	Self ID buffer	SelfIDBuffer	64h
	Self ID count	SelfIDCount	68h
	Reserved	—	6Ch
—	Isochronous receive channel mask high	IRChannelMaskHiSet	70h
		IRChannelMaskHiClear	74h
	Isochronous receive channel mask low	IRChannelMaskLoSet	78h
		IRChannelMaskLoClear	7Ch
	Interrupt event	IntEventSet	80h
		IntEventClear	84h
	Interrupt mask	IntMaskSet	88h
		IntMaskClear	8Ch
	Isochronous transmit interrupt event	IsoXmitIntEventSet	90h
		IsoXmitIntEventClear	94h
	Isochronous transmit interrupt mask	IsoXmitIntMaskSet	98h
		IsoXmitIntMaskClear	9Ch
—	Isochronous receive interrupt event	IsoRecvIntEventSet	A0h
		IsoRecvIntEventClear	A4h
	Isochronous receive interrupt mask	IsoRecvIntMaskSet	A8h
		IsoRecvIntMaskClear	ACh
	Reserved		B0h–D8h
	Fairness control	FairnessControl	DCh
	Link control	LinkControlSet	E0h
		LinkControlClear	E4h
	Node identification	NodeID	E8h
	PHY layer control	PhyControl	ECh
	Isochronous cycle timer	IsocycTimer	F0h
	Reserved		F4h–FCh
	Asynchronous request filter high	AsyncRequestFilterHiSet	100h
		AsyncRequestFilterHiClear	104h
	Asynchronous request filter low	AsyncRequestFilterLoSet	108h
		AsyncRequestFilterLoClear	10Ch
	Physical request filter high	PhysicalRequestFilterHiSet	110h
		PhysicalRequestFilterHiClear	114h
	Physical request filter low	PhysicalRequestFilterLoSet	118h
		PhysicalRequestFilterLoClear	11Ch
Physical upper bound	PhysicalUpperBound	120h	
Reserved	—	124h–17Ch	

Table 4–1. OHCI Register Map (Continued)

DMA CONTEXT	REGISTER NAME	ABBREVIATION	OFFSET
Asynchronous Request Transmit [ATRQ]	Asynchronous context control	ContextControlSet	180h
		ContextControlClear	184h
	Reserved	—	188h
	Asynchronous context command pointer	CommandPtr	18Ch
	Reserved	—	190h–19Ch
Asynchronous Response Transmit [ATRS]	Asynchronous context control	ContextControlSet	1A0h
		ContextControlClear	1A4h
	Reserved	—	1A8h
	Asynchronous context command pointer	CommandPtr	1ACh
	Reserved	—	1B0h–1BCh
Asynchronous Request Receive [ARRQ]	Asynchronous context control	ContextControlSet	1C0h
		ContextControlClear	1C4h
	Reserved	—	1C8h
	Asynchronous context command pointer	CommandPtr	1CCh
	Reserved	—	1D0h–1DCh
Asynchronous Response Receive [ARRS]	Asynchronous context control	ContextControlSet	1E0h
		ContextControlClear	1E4h
	Reserved	—	1E8h
	Asynchronous context command pointer	CommandPtr	1ECh
	Reserved	—	1F0h–1FCh
Isochronous Transmit Context n n = 0, 1, 2, 3, ..., 7	Isochronous transmit context control	ContextControlSet	200h + 16*n
		ContextControlClear	204h + 16*n
	Reserved	—	208h + 16*n
	Isochronous transmit context command pointer	CommandPtr	20Ch + 16*n
	Reserved	—	280h–3FCh
Isochronous Receive Context n n = 0, 1, 2, 3	Isochronous receive context control	ContextControlSet	400h + 32*n
		ContextControlClear	404h + 32*n
	Reserved	—	408h + 32*n
	Isochronous receive context command pointer	CommandPtr	40Ch + 32*n
	Context match	ContextMatch	410h + 32*n

4.1 OHCI Version Register

The OHCI version register indicates the OHCI version support and whether or not the serial EEPROM is present. See Table 4–2 for a complete description of the register contents.

Bit	31	30	29	28	27	26	25	24	23	22	21	20	19	18	17	16
Name	OHCI version															
Type	R	R	R	R	R	R	R	R	R	R	R	R	R	R	R	R
Default	0	0	0	0	0	0	0	X	0	0	0	0	0	0	0	1
Bit	15	14	13	12	11	10	9	8	7	6	5	4	3	2	1	0
Name	OHCI version															
Type	R	R	R	R	R	R	R	R	R	R	R	R	R	R	R	R
Default	0	0	0	0	0	0	0	0	0	0	0	0	0	0	0	0

Register: **OHCI version**
 Type: Read-only
 Offset: 00h
 Default: 0X01 0000h

Table 4–2. OHCI Version Register Description

BIT	FIELD NAME	TYPE	DESCRIPTION
31–25	RSVD	R	Reserved. Bits 31–25 return 0s when read.
24	GUID_ROM	R	The TSB12LV26 device sets bit 24 to 1 if the serial EEPROM is detected. If the serial EEPROM is present, the Bus_Info_Block is automatically loaded on system (hardware) reset.
23–16	version	R	Major version of the OHCI. The TSB12LV26 device is compliant with the <i>1394 Open Host Controller Interface Specification</i> ; thus, this field reads 01h.
15–8	RSVD	R	Reserved. Bits 15–8 return 0s when read.
7–0	revision	R	Minor version of the OHCI. The TSB12LV26 device is compliant with the <i>1394 Open Host Controller Interface Specification</i> ; thus, this field reads 00h.

4.2 GUID ROM Register

The GUID ROM register accesses the serial EEPROM and is applicable only if bit 24 (GUID_ROM) in the OHCI version register at OHCI offset 00h (see Section 4.1, *OHCI Version Register*) is set to 1. See Table 4–3 for a complete description of the register contents.

Bit	31	30	29	28	27	26	25	24	23	22	21	20	19	18	17	16
Name	GUID ROM															
Type	RSU	R	R	R	R	R	RSU	R	RU	RU	RU	RU	RU	RU	RU	RU
Default	0	0	0	0	0	0	0	0	X	X	X	X	X	X	X	X
Bit	15	14	13	12	11	10	9	8	7	6	5	4	3	2	1	0
Name	GUID ROM															
Type	R	R	R	R	R	R	R	R	R	R	R	R	R	R	R	R
Default	0	0	0	0	0	0	0	0	0	0	0	0	0	0	0	0

Register: **GUID ROM**
 Type: Read/Set/Update, Read/Update, Read-only
 Offset: 04h
 Default: 00XX 0000h

Table 4–3. GUID ROM Register Description

BIT	FIELD NAME	TYPE	DESCRIPTION
31	addrReset	RSU	Software sets bit 31 to 1 to reset the GUID ROM address to 0. When the TSB12LV26 device completes the reset, it clears this bit. The TSB12LV26 device does not automatically fill bits 23–16 (rdData field) with the 0 th byte.
30–26	RSVD	R	Reserved. Bits 30–26 return 0s when read.
25	rdStart	RSU	A read of the currently addressed byte is started when bit 25 is set to 1. This bit is automatically cleared when the TSB12LV26 device completes the read of the currently addressed GUID ROM byte.
24	RSVD	R	Reserved. Bit 24 returns 0 when read.
23–16	rdData	RU	This field contains the data read from the GUID ROM.
15–0	RSVD	R	Reserved. Bits 15–0 return 0s when read.

4.3 Asynchronous Transmit Retries Register

The asynchronous transmit retries register indicates the number of times the TSB12LV26 device attempts a retry for asynchronous DMA request transmit and for asynchronous physical and DMA response transmit. See Table 4–4 for a complete description of the register contents.

Bit	31	30	29	28	27	26	25	24	23	22	21	20	19	18	17	16
Name	Asynchronous transmit retries															
Type	R	R	R	R	R	R	R	R	R	R	R	R	R	R	R	R
Default	0	0	0	0	0	0	0	0	0	0	0	0	0	0	0	0
Bit	15	14	13	12	11	10	9	8	7	6	5	4	3	2	1	0
Name	Asynchronous transmit retries															
Type	R	R	R	R	R/W	R/W	R/W	R/W	R/W	R/W	R/W	R/W	R/W	R/W	R/W	R/W
Default	0	0	0	0	0	0	0	0	0	0	0	0	0	0	0	0

Register: **Asynchronous transmit retries**
 Type: Read/Write, Read-only
 Offset: 08h
 Default: 0000 0000h

Table 4–4. Asynchronous Transmit Retries Register Description

BIT	FIELD NAME	TYPE	DESCRIPTION
31–29	secondLimit	R	The second limit field returns 0s when read, because outbound dual-phase retry is not implemented.
28–16	cycleLimit	R	The cycle limit field returns 0s when read, because outbound dual-phase retry is not implemented.
15–12	RSVD	R	Reserved. Bits 15–12 return 0s when read.
11–8	maxPhysRespRetries	R/W	The maxPhysRespRetries field tells the physical response unit how many times to attempt to retry the transmit operation for the response packet when a busy acknowledge or ack_data_error is received from the target node.
7–4	maxATRespRetries	R/W	The maxATRespRetries field tells the asynchronous transmit response unit how many times to attempt to retry the transmit operation for the response packet when a busy acknowledge or ack_data_error is received from the target node.
3–0	maxATReqRetries	R/W	The maxATReqRetries field tells the asynchronous transmit DMA request unit how many times to attempt to retry the transmit operation for the response packet when a busy acknowledge or ack_data_error is received from the target node.

4.4 CSR Data Register

The CSR data register accesses the bus-management CSR registers from the host through compare-swap operations. This register contains the data to be stored in a CSR if the compare is successful.

Bit	31	30	29	28	27	26	25	24	23	22	21	20	19	18	17	16
Name	CSR data															
Type	R	R	R	R	R	R	R	R	R	R	R	R	R	R	R	R
Default	X	X	X	X	X	X	X	X	X	X	X	X	X	X	X	X
Bit	15	14	13	12	11	10	9	8	7	6	5	4	3	2	1	0
Name	CSR data															
Type	R	R	R	R	R	R	R	R	R	R	R	R	R	R	R	R
Default	X	X	X	X	X	X	X	X	X	X	X	X	X	X	X	X

Register: **CSR data**
 Type: Read-only
 Offset: 0Ch
 Default: XXXX XXXXh

4.5 CSR Compare Register

The CSR compare register accesses the bus-management CSR registers from the host through compare-swap operations. This register contains the data to be compared with the existing value of the CSR resource.

Bit	31	30	29	28	27	26	25	24	23	22	21	20	19	18	17	16
Name	CSR compare															
Type	R	R	R	R	R	R	R	R	R	R	R	R	R	R	R	R
Default	X	X	X	X	X	X	X	X	X	X	X	X	X	X	X	X
Bit	15	14	13	12	11	10	9	8	7	6	5	4	3	2	1	0
Name	CSR compare															
Type	R	R	R	R	R	R	R	R	R	R	R	R	R	R	R	R
Default	X	X	X	X	X	X	X	X	X	X	X	X	X	X	X	X

Register: **CSR compare**
 Type: Read-only
 Offset: 10h
 Default: XXXX XXXXh

4.6 CSR Control Register

The CSR control register accesses the bus-management CSR registers from the host through compare-swap operations. This register controls the compare-swap operation and selects the CSR resource. See Table 4–5 for a complete description of the register contents.

Bit	31	30	29	28	27	26	25	24	23	22	21	20	19	18	17	16
Name	CSR control															
Type	RU	R	R	R	R	R	R	R	R	R	R	R	R	R	R	R
Default	1	0	0	0	0	0	0	0	0	0	0	0	0	0	0	0
Bit	15	14	13	12	11	10	9	8	7	6	5	4	3	2	1	0
Name	CSR control															
Type	R	R	R	R	R	R	R	R	R	R	R	R	R	R	R/W	R/W
Default	0	0	0	0	0	0	0	0	0	0	0	0	0	0	X	X

Register: **CSR control**
 Type: Read/Write, Read/Update, Read-only
 Offset: 14h
 Default: 8000 000Xh

Table 4–5. CSR Control Register Description

BIT	FIELD NAME	TYPE	DESCRIPTION
31	csrDone	RU	Bit 31 is set to 1 by the TSB12LV26 device when a compare-swap operation is complete. It is cleared whenever this register is written.
30–2	RSVD	R	Reserved. Bits 30–2 return 0s when read.
1–0	csrSel	R/W	This field selects the CSR resource as follows: 00 = BUS_MANAGER_ID 01 = BANDWIDTH_AVAILABLE 10 = CHANNELS_AVAILABLE_HI 11 = CHANNELS_AVAILABLE_LO

4.7 Configuration ROM Header Register

The configuration ROM header register externally maps to the first quadlet of the 1394 configuration ROM, offset FFFF F000 0400h. See Table 4–6 for a complete description of the register contents.

Bit	31	30	29	28	27	26	25	24	23	22	21	20	19	18	17	16
Name	Configuration ROM header															
Type	R/W	R/W	R/W	R/W	R/W	R/W	R/W	R/W	R/W	R/W	R/W	R/W	R/W	R/W	R/W	R/W
Default	0	0	0	0	0	0	0	0	0	0	0	0	0	0	0	0
Bit	15	14	13	12	11	10	9	8	7	6	5	4	3	2	1	0
Name	Configuration ROM header															
Type	R/W	R/W	R/W	R/W	R/W	R/W	R/W	R/W	R/W	R/W	R/W	R/W	R/W	R/W	R/W	R/W
Default	X	X	X	X	X	X	X	X	X	X	X	X	X	X	X	X

Register: **Configuration ROM header**
 Type: Read/Write
 Offset: 18h
 Default: 0000 XXXXh

Table 4–6. Configuration ROM Header Register Description

BIT	FIELD NAME	TYPE	DESCRIPTION
31–24	info_length	R/W	IEEE 1394 bus-management field. Must be valid when bit 17 (linkEnable) in the host controller control register at OHCI offset 50h/54h (see Section 4.16, <i>Host Controller Control Register</i>) is set to 1.
23–16	crc_length	R/W	IEEE 1394 bus-management field. Must be valid when bit 17 (linkEnable) in the host controller control register at OHCI offset 50h/54h (see Section 4.16, <i>Host Controller Control Register</i>) is set to 1.
15–0	rom_crc_value	R/W	IEEE 1394 bus-management field. Must be valid at any time bit 17 (linkEnable) in the host controller control register at OHCI offset 50h/54h (see Section 4.16, <i>Host Controller Control Register</i>) is set to 1. The reset value is undefined if no serial EEPROM is present. If a serial EEPROM is present, this field is loaded from the serial EEPROM.

4.8 Bus Identification Register

The bus identification register externally maps to the first quadlet in the Bus_Info_Block and contains the constant 3133 3934h, which is the ASCII value of 1394.

Bit	31	30	29	28	27	26	25	24	23	22	21	20	19	18	17	16
Name	Bus identification															
Type	R	R	R	R	R	R	R	R	R	R	R	R	R	R	R	R
Default	0	0	1	1	0	0	0	1	0	0	1	1	0	0	1	1
Bit	15	14	13	12	11	10	9	8	7	6	5	4	3	2	1	0
Name	Bus identification															
Type	R	R	R	R	R	R	R	R	R	R	R	R	R	R	R	R
Default	0	0	1	1	1	0	0	1	0	0	1	1	0	1	0	0

Register: **Bus identification**
 Type: Read-only
 Offset: 1Ch
 Default: 3133 3934h

4.9 Bus Options Register

The bus options register externally maps to the second quadlet of the Bus_Info_Block. See Table 4–7 for a complete description of the register contents.

Bit	31	30	29	28	27	26	25	24	23	22	21	20	19	18	17	16
Name	Bus options															
Type	R/W	R/W	R/W	R/W	R/W	R	R	R	R/W	R/W	R/W	R/W	R/W	R/W	R/W	R/W
Default	X	X	X	X	0	0	0	0	X	X	X	X	X	X	X	X
Bit	15	14	13	12	11	10	9	8	7	6	5	4	3	2	1	0
Name	Bus options															
Type	R/W	R/W	R/W	R/W	R	R	R	R	R/W	R/W	R	R	R	R	R	R
Default	1	0	1	0	0	0	0	0	X	X	0	0	0	0	1	0

Register: **Bus options**
 Type: Read/Write, Read-only
 Offset: 20h
 Default: X0XX A0X2h

Table 4–7. Bus Options Register Description

BIT	FIELD NAME	TYPE	DESCRIPTION
31	irmc	R/W	Isochronous resource-manager capable. IEEE 1394 bus-management field. Must be valid when bit 17 (linkEnable) in the host controller control register at OHCI offset 50h/54h (see Section 4.16, <i>Host Controller Control Register</i>) is set to 1.
30	cmc	R/W	Cycle master capable. IEEE 1394 bus-management field. Must be valid when bit 17 (linkEnable) in the host controller control register at OHCI offset 50h/54h (see Section 4.16, <i>Host Controller Control Register</i>) is set to 1.
29	isc	R/W	Isochronous support capable. IEEE 1394 bus-management field. Must be valid when bit 17 (linkEnable) in the host controller control register at OHCI offset 50h/54h (see Section 4.16, <i>Host Controller Control Register</i>) is set to 1.
28	bmc	R/W	Bus manager capable. IEEE 1394 bus-management field. Must be valid when bit 17 (linkEnable) in the host controller control register at OHCI offset 50h/54h (see Section 4.16, <i>Host Controller Control Register</i>) is set to 1.
27	pmc	R/W	Power-management capable. IEEE 1394 bus-management field. When bit 27 is set to 1, this indicates that the node is power-management capable. Must be valid when bit 17 (linkEnable) in the host controller control register at OHCI offset 50h/54h (see Section 4.16, <i>Host Controller Control Register</i>) is set to 1.
26–24	RSVD	R	Reserved. Bits 26–24 return 0s when read.
23–16	cyc_clk_acc	R/W	Cycle master clock accuracy, in parts per million. IEEE 1394 bus-management field. Must be valid when bit 17 (linkEnable) in the host controller control register at OHCI offset 50h/54h (see Section 4.16, <i>Host Controller Control Register</i>) is set to 1.
15–12	max_rec	R/W	Maximum request. IEEE 1394 bus-management field. Hardware initializes this field to indicate the maximum number of bytes in a block request packet that is supported by the implementation. This value, max_rec_bytes, must be 512 or greater, and is calculated by $2^{(\text{max_rec} + 1)}$. Software may change this field; however, this field must be valid at any time bit 17 (linkEnable) in the host controller control register at OHCI offset 50h/54h (see Section 4.16, <i>Host Controller Control Register</i>) is set to 1. A received block write request packet with a length greater than max_rec_bytes may generate an ack_type_error. This field is not affected by a software reset, and defaults to a value indicating 2048 bytes on a system (hardware) reset.
11–8	RSVD	R	Reserved. Bits 11–8 return 0s when read.
7–6	g	R/W	Generation counter. This field is incremented if any portion of the configuration ROM has been incremented since the prior bus reset.
5–3	RSVD	R	Reserved. Bits 5–3 return 0s when read.
2–0	Lnk_spd	R	Link speed. This field returns 010, indicating that the link speeds of 100M bits/s, 200M bits/s, and 400M bits/s are supported.

4.10 GUID High Register

The GUID high register represents the upper quadlet in a 64-bit global unique ID (GUID) which maps to the third quadlet in the Bus_Info_Block. This register contains node_vendor_ID and chip_ID_hi fields. This register initializes to 0s on a system (hardware) reset, which is an illegal GUID value. If a serial EEPROM is detected, the contents of this register are loaded through the serial EEPROM interface after a PCI_RST. At that point, the contents of this register cannot be changed. If no serial EEPROM is detected, the contents of this register are loaded by the BIOS after a PCI_RST. At that point, the contents of this register cannot be changed.

Bit	31	30	29	28	27	26	25	24	23	22	21	20	19	18	17	16
Name	GUID high															
Type	R	R	R	R	R	R	R	R	R	R	R	R	R	R	R	R
Default	0	0	0	0	0	0	0	0	0	0	0	0	0	0	0	0
Bit	15	14	13	12	11	10	9	8	7	6	5	4	3	2	1	0
Name	GUID high															
Type	R	R	R	R	R	R	R	R	R	R	R	R	R	R	R	R
Default	0	0	0	0	0	0	0	0	0	0	0	0	0	0	0	0

Register: **GUID high**
 Type: Read-only
 Offset: 24h
 Default: 0000 0000h

4.11 GUID Low Register

The GUID low register represents the lower quadlet in a 64-bit global unique ID (GUID) which maps to chip_ID_lo in the Bus_Info_Block. This register initializes to 0s on a system (hardware) reset and behaves identically to the GUID high register at OHCI offset 24h (see Section 4.10, *GUID High Register*).

Bit	31	30	29	28	27	26	25	24	23	22	21	20	19	18	17	16
Name	GUID low															
Type	R	R	R	R	R	R	R	R	R	R	R	R	R	R	R	R
Default	0	0	0	0	0	0	0	0	0	0	0	0	0	0	0	0
Bit	15	14	13	12	11	10	9	8	7	6	5	4	3	2	1	0
Name	GUID low															
Type	R	R	R	R	R	R	R	R	R	R	R	R	R	R	R	R
Default	0	0	0	0	0	0	0	0	0	0	0	0	0	0	0	0

Register: **GUID low**
 Type: Read-only
 Offset: 28h
 Default: 0000 0000h

4.12 Configuration ROM Mapping Register

The configuration ROM mapping register contains the start address within system memory that maps to the start address of 1394 configuration ROM for this node. See Table 4–8 for a complete description of the register contents.

Bit	31	30	29	28	27	26	25	24	23	22	21	20	19	18	17	16
Name	Configuration ROM mapping															
Type	R/W	R/W	R/W	R/W	R/W	R/W	R/W	R/W	R/W	R/W	R/W	R/W	R/W	R/W	R/W	R/W
Default	0	0	0	0	0	0	0	0	0	0	0	0	0	0	0	0
Bit	15	14	13	12	11	10	9	8	7	6	5	4	3	2	1	0
Name	Configuration ROM mapping															
Type	R/W	R/W	R/W	R/W	R/W	R/W	R	R	R	R	R	R	R	R	R	R
Default	0	0	0	0	0	0	0	0	0	0	0	0	0	0	0	0

Register: **Configuration ROM mapping**
 Type: Read/Write, Read-only
 Offset: 34h
 Default: 0000 0000h

Table 4–8. Configuration ROM Mapping Register Description

BIT	FIELD NAME	TYPE	DESCRIPTION
31–10	configROMAddr	R/W	If a quadlet read request to 1394 offset FFFF F000 0400h through offset FFFF F000 07FFh is received, the low-order 10 bits of the offset are added to this register to determine the host memory address of the read request.
9–0	RSVD	R	Reserved. Bits 9–0 return 0s when read.

4.13 Posted Write Address Low Register

The posted write address low register communicates error information if a write request is posted and an error occurs while writing the posted data packet. See Table 4–9 for a complete description of the register contents.

Bit	31	30	29	28	27	26	25	24	23	22	21	20	19	18	17	16
Name	Posted write address low															
Type	RU	RU	RU	RU	RU	RU	RU	RU	RU	RU	RU	RU	RU	RU	RU	RU
Default	X	X	X	X	X	X	X	X	X	X	X	X	X	X	X	X
Bit	15	14	13	12	11	10	9	8	7	6	5	4	3	2	1	0
Name	Posted write address low															
Type	RU	RU	RU	RU	RU	RU	RU	RU	RU	RU	RU	RU	RU	RU	RU	RU
Default	X	X	X	X	X	X	X	X	X	X	X	X	X	X	X	X

Register: **Posted write address low**
 Type: Read/Update
 Offset: 38h
 Default: XXXX XXXXh

Table 4–9. Posted Write Address Low Register Description

BIT	FIELD NAME	TYPE	DESCRIPTION
31–0	offsetLo	RU	The lower 32 bits of the 1394 destination offset of the write request that failed.

4.14 Posted Write Address High Register

The posted write address high register communicates error information if a write request is posted and an error occurs while writing the posted data packet. See Table 4–10 for a complete description of the register contents.

Bit	31	30	29	28	27	26	25	24	23	22	21	20	19	18	17	16
Name	Posted write address high															
Type	RU	RU	RU	RU	RU	RU	RU	RU	RU	RU	RU	RU	RU	RU	RU	RU
Default	X	X	X	X	X	X	X	X	X	X	X	X	X	X	X	X
Bit	15	14	13	12	11	10	9	8	7	6	5	4	3	2	1	0
Name	Posted write address high															
Type	RU	RU	RU	RU	RU	RU	RU	RU	RU	RU	RU	RU	RU	RU	RU	RU
Default	X	X	X	X	X	X	X	X	X	X	X	X	X	X	X	X

Register: **Posted write address high**
 Type: Read/Update
 Offset: 3Ch
 Default: XXXX XXXXh

Table 4–10. Posted Write Address High Register Description

BIT	FIELD NAME	TYPE	DESCRIPTION
31–16	sourceID	RU	This field is the 10-bit bus number (bits 31–22) and 6-bit node number (bits 21–16) of the node that issued the write request that failed.
15–0	offsetHi	RU	The upper 16 bits of the 1394 destination offset of the write request that failed.

4.15 Vendor ID Register

The vendor ID register holds the company ID of an organization that specifies any vendor-unique registers. The TSB12LV26 device does not implement Texas Instruments unique behavior with regards to OHCI. Thus, this register is read-only and returns 0s when read.

Bit	31	30	29	28	27	26	25	24	23	22	21	20	19	18	17	16
Name	Vendor ID															
Type	R	R	R	R	R	R	R	R	R	R	R	R	R	R	R	R
Default	0	0	0	0	0	0	0	0	0	0	0	0	0	0	0	0
Bit	15	14	13	12	11	10	9	8	7	6	5	4	3	2	1	0
Name	Vendor ID															
Type	R	R	R	R	R	R	R	R	R	R	R	R	R	R	R	R
Default	0	0	0	0	0	0	0	0	0	0	0	0	0	0	0	0

Register: **Vendor ID**
 Type: Read-only
 Offset: 40h
 Default: 0000 0000h

4.16 Host Controller Control Register

The host controller control set/clear register pair provides flags for controlling the TSB12LV26 device. See Table 4–11 for a complete description of the register contents.

Bit	31	30	29	28	27	26	25	24	23	22	21	20	19	18	17	16
Name	Host controller control															
Type	R	RSC	R	R	R	R	R	R	RC	RSC	R	R	RSC	RSC	RSC	RSCU
Default	0	X	0	0	0	0	0	0	0	0	0	0	0	X	0	0
Bit	15	14	13	12	11	10	9	8	7	6	5	4	3	2	1	0
Name	Host controller control															
Type	R	R	R	R	R	R	R	R	R	R	R	R	R	R	R	R
Default	0	0	0	0	0	0	0	0	0	0	0	0	0	0	0	0

Register: **Host controller control**

Type: Read/Set/Clear/Update, Read/Set/Clear, Read/Clear, Read-only

Offset: 50h set register

54h clear register

Default: X00X 0000h

Table 4–11. Host Controller Control Register Description

BIT	FIELD NAME	TYPE	DESCRIPTION
31	RSVD	R	Reserved. Bit 31 returns 0 when read.
30	noByteSwapData	RSC	Bit 30 controls whether physical accesses to locations outside the TSB12LV26 device itself, as well as any other DMA data accesses, are swapped.
29–24	RSVD	R	Reserved. Bits 29–24 return 0s when read.
23	programPhyEnable	RC	Bit 23 informs upper-level software that lower-level software has consistently configured the IEEE 1394a-2000 enhancements in the link and PHY devices. When this bit is set to 1, generic software such as the OHCI driver is responsible for configuring IEEE 1394a-2000 enhancements in the PHY device and bit 22 (aPhyEnhanceEnable) in the TSB12LV26 device. When this bit is cleared to 0, the generic software may not modify the IEEE 1394a-2000 enhancements in the TSB12LV26 or PHY device and cannot interpret the setting of bit 22 (aPhyEnhanceEnable). This bit is initialized from serial EEPROM.
22	aPhyEnhanceEnable	RSC	When bits 23 (programPhyEnable) and 17 (linkEnable) are 1, the OHCI driver can set bit 22 to 1 to use all IEEE 1394a-2000 enhancements. When bit 23 (programPhyEnable) is cleared to 0, the software does not change PHY enhancements or this bit.
21–20	RSVD	R	Reserved. Bits 21 and 20 return 0s when read.
19	LPS	RSC	Bit 19 controls the link power status. Software must set this bit to 1 to permit link-PHY communication. A 0 prevents link-PHY communication. The OHCI-link is divided into two clock domains (PCI_CLK and PHY_SCLK). If software tries to access any register in the PHY_SCLK domain while the PHY_SCLK is disabled, a target abort is issued by the link. This problem can be avoided by setting bit 4 (DIS_TGT_ABT) to 1 in the miscellaneous configuration register at offset F0h in the PCI configuration space (see Section 3.20, <i>Miscellaneous Configuration Register</i>). This allows the link to respond to these types of requests by returning all Fs (hex). It is recommended that this bit be set to 1 and is programmable via the ROM or BIOS. OHCI registers at offsets DCh–F0h and 100h–11Ch are in the PHY_SCLK domain. After setting LPS software must wait approximately 10 ms before attempting to access any of the OHCI registers. This gives the PHY_SCLK time to stabilize.
18	postedWriteEnable	RSC	Bit 18 enables (1) or disables (0) posted writes. Software must change this bit only when bit 17 (linkEnable) is 0.

Table 4–11. Host Controller Control Register Description (Continued)

BIT	FIELD NAME	TYPE	DESCRIPTION
17	linkEnable	RSC	Bit 17 is cleared to 0 by either a system (hardware) or software reset. Software must set this bit to 1 when the system is ready to begin operation and then force a bus reset. This bit is necessary to keep other nodes from sending transactions before the local system is ready. When this bit is cleared, the TSB12LV26 device is logically and immediately disconnected from the 1394 bus, no packets are received or processed, nor are packets transmitted.
16	SoftReset	RSCU	When bit 16 is set to 1, all TSB12LV26 device states are reset, all FIFOs are flushed, and all OHCI registers are set to their system (hardware) reset values, unless otherwise specified. PCI registers are not affected by this bit. This bit remains set to 1 while the software reset is in progress and reverts back to 0 when the reset has completed.
15–0	RSVD	R	Reserved. Bits 15–0 return 0s when read.

4.17 Self-ID Buffer Pointer Register

The self-ID buffer pointer register points to the 2K-byte aligned base address of the buffer in host memory where the self-ID packets are stored during bus initialization. Bits 31–11 are read/write accessible. Bits 10–0 are reserved, and return 0s when read.

Bit	31	30	29	28	27	26	25	24	23	22	21	20	19	18	17	16
Name	Self-ID buffer pointer															
Type	R/W	R/W	R/W	R/W	R/W	R/W	R/W	R/W	R/W	R/W	R/W	R/W	R/W	R/W	R/W	R/W
Default	X	X	X	X	X	X	X	X	X	X	X	X	X	X	X	X
Bit	15	14	13	12	11	10	9	8	7	6	5	4	3	2	1	0
Name	Self-ID buffer pointer															
Type	R/W	R/W	R/W	R/W	R/W	R	R	R	R	R	R	R	R	R	R	R
Default	X	X	X	X	X	0	0	0	0	0	0	0	0	0	0	0

Register: **Self ID-buffer pointer**
 Type: Read/Write, Read-only
 Offset: 64h
 Default: XXXX XX00h

4.18 Self-ID Count Register

The self-ID count register keeps a count of the number of times the bus self-ID process has occurred, flags self-ID packet errors, and keeps a count of the self-ID data in the self-ID buffer. See Table 4–12 for a complete description of the register contents.

Bit	31	30	29	28	27	26	25	24	23	22	21	20	19	18	17	16
Name	Self-ID count															
Type	RU	R	R	R	R	R	R	R	RU	RU	RU	RU	RU	RU	RU	RU
Default	X	0	0	0	0	0	0	0	X	X	X	X	X	X	X	X
Bit	15	14	13	12	11	10	9	8	7	6	5	4	3	2	1	0
Name	Self-ID count															
Type	R	R	R	R	R	RU	RU	RU	RU	RU	RU	RU	RU	RU	R	R
Default	0	0	0	0	0	0	0	0	0	0	0	0	0	0	0	0

Register: **Self-ID count**
 Type: Read/Update, Read-only
 Offset: 68h
 Default: X0XX 0000h

Table 4–12. Self-ID Count Register Description

BIT	FIELD NAME	TYPE	DESCRIPTION
31	selfIDError	RU	When bit 31 is set to 1, an error was detected during the most recent self-ID packet reception. The contents of the self-ID buffer are undefined. This bit is cleared after a self-ID reception in which no errors are detected. Note that an error can be a hardware error or a host bus write error.
30–24	RSVD	R	Reserved. Bits 30–24 return 0s when read.
23–16	selfIDGeneration	RU	The value in this field increments each time a bus reset is detected. This field rolls over to 0 after reaching 255.
15–11	RSVD	R	Reserved. Bits 15–11 return 0s when read.
10–2	selfIDSize	RU	This field indicates the number of quadlets that have been written into the self-ID buffer for the current bits 23–16 (selfIDGeneration field). This includes the header quadlet and the self-ID data. This field is cleared to 0 when the self-ID reception begins.
1–0	RSVD	R	Reserved. Bits 1 and 0 return 0s when read.

4.19 Isochronous Receive Channel Mask High Register

The isochronous receive channel mask high set/clear register enables packet receives from the upper 32 isochronous data channels. A read from either the set register or clear register returns the content of the isochronous receive channel mask high register. See Table 4–13 for a complete description of the register contents.

Bit	31	30	29	28	27	26	25	24	23	22	21	20	19	18	17	16
Name	Isochronous receive channel mask high															
Type	RSC	RSC	RSC	RSC	RSC	RSC	RSC	RSC	RSC	RSC	RSC	RSC	RSC	RSC	RSC	RSC
Default	X	X	X	X	X	X	X	X	X	X	X	X	X	X	X	X
Bit	15	14	13	12	11	10	9	8	7	6	5	4	3	2	1	0
Name	Isochronous receive channel mask high															
Type	RSC	RSC	RSC	RSC	RSC	RSC	RSC	RSC	RSC	RSC	RSC	RSC	RSC	RSC	RSC	RSC
Default	X	X	X	X	X	X	X	X	X	X	X	X	X	X	X	X

Register: **Isochronous receive channel mask high**

Type: Read/Set/Clear

Offset: 70h set register

74h clear register

Default: XXXX XXXXh

Table 4–13. Isochronous Receive Channel Mask High Register Description

BIT	FIELD NAME	TYPE	DESCRIPTION
31	isoChannel63	RSC	When bit 31 is set to 1, the TSB12LV26 device is enabled to receive from isochronous channel number 63.
30	isoChannel62	RSC	When bit 30 is set to 1, the TSB12LV26 device is enabled to receive from isochronous channel number 62.
29	isoChannel61	RSC	When bit 29 is set to 1, the TSB12LV26 device is enabled to receive from isochronous channel number 61.
28	isoChannel60	RSC	When bit 28 is set to 1, the TSB12LV26 device is enabled to receive from isochronous channel number 60.
27	isoChannel59	RSC	When bit 27 is set to 1, the TSB12LV26 device is enabled to receive from isochronous channel number 59.
26	isoChannel58	RSC	When bit 26 is set to 1, the TSB12LV26 device is enabled to receive from isochronous channel number 58.
25	isoChannel57	RSC	When bit 25 is set to 1, the TSB12LV26 device is enabled to receive from isochronous channel number 57.
24	isoChannel56	RSC	When bit 24 is set to 1, the TSB12LV26 device is enabled to receive from isochronous channel number 56.
23	isoChannel55	RSC	When bit 23 is set to 1, the TSB12LV26 device is enabled to receive from isochronous channel number 55.
22	isoChannel54	RSC	When bit 22 is set to 1, the TSB12LV26 device is enabled to receive from isochronous channel number 54.
21	isoChannel53	RSC	When bit 21 is set to 1, the TSB12LV26 device is enabled to receive from isochronous channel number 53.
20	isoChannel52	RSC	When bit 20 is set to 1, the TSB12LV26 device is enabled to receive from isochronous channel number 52.
19	isoChannel51	RSC	When bit 19 is set to 1, the TSB12LV26 device is enabled to receive from isochronous channel number 51.
18	isoChannel50	RSC	When bit 18 is set to 1, the TSB12LV26 device is enabled to receive from isochronous channel number 50.
17	isoChannel49	RSC	When bit 17 is set to 1, the TSB12LV26 device is enabled to receive from isochronous channel number 49.
16	isoChannel48	RSC	When bit 16 is set to 1, the TSB12LV26 device is enabled to receive from isochronous channel number 48.
15	isoChannel47	RSC	When bit 15 is set to 1, the TSB12LV26 device is enabled to receive from isochronous channel number 47.
14	isoChannel46	RSC	When bit 14 is set to 1, the TSB12LV26 device is enabled to receive from isochronous channel number 46.
13	isoChannel45	RSC	When bit 13 is set to 1, the TSB12LV26 device is enabled to receive from isochronous channel number 45.
12	isoChannel44	RSC	When bit 12 is set to 1, the TSB12LV26 device is enabled to receive from isochronous channel number 44.
11	isoChannel43	RSC	When bit 11 is set to 1, the TSB12LV26 device is enabled to receive from isochronous channel number 43.
10	isoChannel42	RSC	When bit 10 is set to 1, the TSB12LV26 device is enabled to receive from isochronous channel number 42.
9	isoChannel41	RSC	When bit 9 is set to 1, the TSB12LV26 device is enabled to receive from isochronous channel number 41.
8	isoChannel40	RSC	When bit 8 is set to 1, the TSB12LV26 device is enabled to receive from isochronous channel number 40.
7	isoChannel39	RSC	When bit 7 is set to 1, the TSB12LV26 device is enabled to receive from isochronous channel number 39.

Table 4–13. Isochronous Receive Channel Mask High Register Description (Continued)

BIT	FIELD NAME	TYPE	DESCRIPTION
6	isoChannel38	RSC	When bit 6 is set to 1, the TSB12LV26 device is enabled to receive from isochronous channel number 38.
5	isoChannel37	RSC	When bit 5 is set to 1, the TSB12LV26 device is enabled to receive from isochronous channel number 37.
4	isoChannel36	RSC	When bit 4 is set to 1, the TSB12LV26 device is enabled to receive from isochronous channel number 36.
3	isoChannel35	RSC	When bit 3 is set to 1, the TSB12LV26 device is enabled to receive from isochronous channel number 35.
2	isoChannel34	RSC	When bit 2 is set to 1, the TSB12LV26 device is enabled to receive from isochronous channel number 34.
1	isoChannel33	RSC	When bit 1 is set to 1, the TSB12LV26 device is enabled to receive from isochronous channel number 33.
0	isoChannel32	RSC	When bit 0 is set to 1, the TSB12LV26 device is enabled to receive from isochronous channel number 32.

4.20 Isochronous Receive Channel Mask Low Register

The isochronous receive channel mask low set/clear register enables packet receives from the lower 32 isochronous data channels. See Table 4–14 for a complete description of the register contents.

Bit	31	30	29	28	27	26	25	24	23	22	21	20	19	18	17	16
Name	Isochronous receive channel mask low															
Type	RSC	RSC	RSC	RSC	RSC	RSC	RSC	RSC	RSC	RSC	RSC	RSC	RSC	RSC	RSC	RSC
Default	X	X	X	X	X	X	X	X	X	X	X	X	X	X	X	X
Bit	15	14	13	12	11	10	9	8	7	6	5	4	3	2	1	0
Name	Isochronous receive channel mask low															
Type	RSC	RSC	RSC	RSC	RSC	RSC	RSC	RSC	RSC	RSC	RSC	RSC	RSC	RSC	RSC	RSC
Default	X	X	X	X	X	X	X	X	X	X	X	X	X	X	X	X

Register: **Isochronous receive channel mask low**
 Type: Read/Set/Clear
 Offset: 78h set register
 7Ch clear register
 Default: XXXX XXXXh

Table 4–14. Isochronous Receive Channel Mask Low Register Description

BIT	FIELD NAME	TYPE	DESCRIPTION
31	isoChannel31	RSC	When bit 31 is set to 1, the TSB12LV26 device is enabled to receive from isochronous channel number 31.
30	isoChannel30	RSC	When bit 30 is set to 1, the TSB12LV26 device is enabled to receive from isochronous channel number 30.
29–2	isoChanneln	RSC	Bits 29 through 2 (isoChanneln, where n = 29, 28, 27, ..., 2) follow the same pattern as bits 31 and 30.
1	isoChannel1	RSC	When bit 1 is set to 1, the TSB12LV26 device is enabled to receive from isochronous channel number 1.
0	isoChannel0	RSC	When bit 0 is set to 1, the TSB12LV26 device is enabled to receive from isochronous channel number 0.

4.21 Interrupt Event Register

The interrupt event set/clear register reflects the state of the various TSB12LV26 interrupt sources. The interrupt bits are set to 1 by an asserting edge of the corresponding interrupt signal or by writing a 1 in the corresponding bit in the set register. The only mechanism to clear a bit in this register is to write a 1 to the corresponding bit in the clear register.

This register is fully compliant with the *1394 Open Host Controller Interface Specification*, and the TSB12LV26 device adds a vendor-specific interrupt function to bit 30. When the interrupt event register is read, the return value is the bit-wise AND function of the interrupt event and interrupt mask registers. See Table 4–15 for a complete description of the register contents.

Bit	31	30	29	28	27	26	25	24	23	22	21	20	19	18	17	16
Name	Interrupt event															
Type	R	RSC	R	R	R	RSCU	RSCU	RSCU	RSCU	RSCU	RSCU	RSCU	RSCU	R	RSCU	RSCU
Default	0	X	0	0	0	X	X	X	X	X	X	X	X	0	X	X
Bit	15	14	13	12	11	10	9	8	7	6	5	4	3	2	1	0
Name	Interrupt event															
Type	R	R	R	R	R	R	RSCU	RSCU	RU	RU	RSCU	RSCU	RSCU	RSCU	RSCU	RSCU
Default	0	0	0	0	0	0	X	X	X	X	X	X	X	X	X	X

Register: **Interrupt event**
 Type: Read/Set/Clear/Update, Read/Set/Clear, Read/Update, Read-only
 Offset: 80h set register
 84h clear register [returns the contents of the interrupt event register bit-wise ANDed with the interrupt mask register when read]
 Default: XXXX 0XXXh

Table 4–15. Interrupt Event Register Description

BIT	FIELD NAME	TYPE	DESCRIPTION
31	RSVD	R	Reserved. Bit 31 returns 0 when read.
30	vendorSpecific	RSC	This vendor-specific interrupt event is reported when either of the general-purpose interrupts are asserted. The general-purpose interrupts are enabled by setting the corresponding bits INT3_EN and INT_2EN (bits 31 and 23, respectively) to 1 in the GPIO control register at offset FCh in the PCI configuration space (see Section 3.23, <i>GPIO Control Register</i>).
29–27	RSVD	R	Reserved. Bits 29–27 return 0s when read.
26	phyRegRcvd	RSCU	The TSB12LV26 device has received a PHY register data byte which can be read from bits 23–16 in the PHY layer control register at OHCI offset ECh (see Section 4.30, <i>PHY Layer Control Register</i>).
25	cycleTooLong	RSCU	If bit 21 (cycleMaster) in the link control register at OHCI offset E0h/E4h (see Section 4.28, <i>Link Control Register</i>) is set to 1, this indicates that over 125 μs have elapsed between the start of sending a cycle start packet and the end of a subaction gap. Bit 21 (cycleMaster) in the link control register is cleared by this event.
24	unrecoverableError	RSCU	This event occurs when the TSB12LV26 device encounters any error that forces it to stop operations on any or all of its subunits, for example, when a DMA context sets its dead bit to 1. While bit 24 is set to 1, all normal interrupts for the context(s) that caused this interrupt are blocked from being set to 1.
23	cycleInconsistent	RSCU	A cycle start was received that had values for the cycleSeconds and cycleCount fields that are different from the values in bits 31–25 (cycleSeconds field) and bits 24–12 (cycleCount field) in the isochronous cycle timer register at OHCI offset F0h (see Section 4.31, <i>Isochronous Cycle Timer Register</i>).
22	cycleLost	RSCU	A lost cycle is indicated when no cycle_start packet is sent or received between two successive cycleSynch events. A lost cycle can be predicted when a cycle_start packet does not immediately follow the first subaction gap after the cycleSynch event or if an arbitration reset gap is detected after a cycleSynch event without an intervening cycle start. Bit 22 may be set to 1 either when a lost cycle occurs or when logic predicts that one will occur.
21	cycle64Seconds	RSCU	Indicates that the 7 th bit of the cycle second counter has changed.

Table 4–15. Interrupt Event Register Description (Continued)

BIT	FIELD NAME	TYPE	DESCRIPTION
20	cycleSynch	RSCU	Indicates that a new isochronous cycle has started. Bit 20 is set to 1 when the low-order bit of the cycle count toggles.
19	phy	RSCU	Indicates that the PHY device requests an interrupt through a status transfer.
18	RSVD	R	Reserved. Bit 18 returns 0 when read.
17	busReset	RSCU	Indicates that the PHY device has entered bus reset mode.
16	selfIDcomplete	RSCU	A self-ID packet stream has been received. It is generated at the end of the bus initialization process. Bit 16 is turned off simultaneously when bit 17 (busReset) is turned on.
15–10	RSVD	R	Reserved. Bits 15–10 return 0s when read.
9	lockRespErr	RSCU	Indicates that the TSB12LV26 device sent a lock response for a lock request to a serial bus register, but did not receive an ack_complete.
8	postedWriteErr	RSCU	Indicates that a host bus error occurred while the TSB12LV26 device was trying to write a 1394 write request, which had already been given an ack_complete, into system memory.
7	isochRx	RU	Isynchronous receive DMA interrupt. Indicates that one or more isochronous receive contexts have generated an interrupt. This is not a latched event; it is the logical OR of all bits in the isochronous receive interrupt event register at OHCI offset A0h/A4h (see Section 4.25, <i>Isynchronous Receive Interrupt Event Register</i>) and the isochronous receive interrupt mask register at OHCI offset A8h/ACh (see Section 4.26, <i>Isynchronous Receive Interrupt Mask Register</i>). The isochronous receive interrupt event register indicates which contexts have been interrupted.
6	isochTx	RU	Isynchronous transmit DMA interrupt. Indicates that one or more isochronous transmit contexts have generated an interrupt. This is not a latched event; it is the logical OR of all bits in the isochronous transmit interrupt event register at OHCI offset 90h/94h (see Section 4.23, <i>Isynchronous Transmit Interrupt Event Register</i>) and the isochronous transmit interrupt mask register at OHCI offset 98h/9Ch (see Section 4.24, <i>Isynchronous Transmit Interrupt Mask Register</i>). The isochronous transmit interrupt event register indicates which contexts have been interrupted.
5	RSPkt	RSCU	Indicates that a packet was sent to an asynchronous receive response context buffer and the descriptor xferStatus and resCount fields have been updated.
4	RQPkt	RSCU	Indicates that a packet was sent to an asynchronous receive request context buffer and the descriptor xferStatus and resCount fields have been updated.
3	ARRS	RSCU	Asynchronous receive response DMA interrupt. Bit 3 is conditionally set to 1 upon completion of an ARRS DMA context command descriptor.
2	ARRQ	RSCU	Asynchronous receive request DMA interrupt. Bit 2 is conditionally set to 1 upon completion of an ARRQ DMA context command descriptor.
1	respTxComplete	RSCU	Asynchronous response transmit DMA interrupt. Bit 1 is conditionally set to 1 upon completion of an ATRS DMA command.
0	reqTxComplete	RSCU	Asynchronous request transmit DMA interrupt. Bit 0 is conditionally set to 1 upon completion of an ATRQ DMA command.

4.22 Interrupt Mask Register

The interrupt mask set/clear register enables the various TSB12LV26 interrupt sources. Reads from either the set register or the clear register always return the contents of the interrupt mask register. In all cases except masterIntEnable (bit 31) and VendorSpecific (bit 30), the enables for each interrupt event align with the interrupt event register bits detailed in Table 4–15. See Table 4–16 for a description of bits 31 and 30.

This register is fully compliant with the *1394 Open Host Controller Interface Specification*, and the TSB12LV26 device adds a vendor-specific interrupt function to bit 30.

Bit	31	30	29	28	27	26	25	24	23	22	21	20	19	18	17	16
Name	Interrupt mask															
Type	RSCU	RSC	R	R	R	RSC	RSC	RSC	RSC	RSC	RSC	RSC	RSC	R	RSC	RSC
Default	X	X	0	0	0	X	X	X	X	X	X	X	X	0	X	X
Bit	15	14	13	12	11	10	9	8	7	6	5	4	3	2	1	0
Name	Interrupt mask															
Type	R	R	R	R	R	R	RSC	RSC	RSC	RSC	RSC	RSC	RSC	RSC	RSC	RSC
Default	0	0	0	0	0	0	X	X	X	X	X	X	X	X	X	X

Register: **Interrupt mask**
 Type: Read/Set/Clear/Update, Read/Set/Clear, Read/Update, Read-only
 Offset: 88h set register
 8Ch clear register
 Default: XXXX 0XXXh

Table 4–16. Interrupt Mask Register Description

BIT	FIELD NAME	TYPE	DESCRIPTION
31	masterIntEnable	RSCU	Master interrupt enable. If bit 31 is set to 1, external interrupts are generated in accordance with the interrupt mask register. If this bit is cleared, external interrupts are not generated regardless of the interrupt mask register settings.
30	vendorSpecific	RSC	When this bit and bit 30 (vendorSpecific) in the interrupt event register at OHCI offset 80h/84h (see Section 4.21, <i>Interrupt Event Register</i>) are set to 1, this vendor-specific interrupt mask enables interrupt generation.
29–27	RSVD	R	Reserved. Bits 29–27 return 0s when read.
26	phyRegRcvd	RSC	When this bit and bit 26 (phyRegRcvd) in the interrupt event register at OHCI offset 80h/84h (see Section 4.21, <i>Interrupt Event Register</i>) are set to 1, this PHY-register interrupt mask enables interrupt generation.
25	cycleTooLong	RSC	When this bit and bit 25 (cycleTooLong) in the interrupt event register at OHCI offset 80h/84h (see Section 4.21, <i>Interrupt Event Register</i>) are set to 1, this cycle-too-long interrupt mask enables interrupt generation.
24	unrecoverableError	RSC	When this bit and bit 24 (unrecoverableError) in the interrupt event register at OHCI offset 80h/84h (see Section 4.21, <i>Interrupt Event Register</i>) are set to 1, this unrecoverable-error interrupt mask enables interrupt generation.
23	cycleInconsistent	RSC	When this bit and bit 23 (cycleInconsistent) in the interrupt event register at OHCI offset 80h/84h (see Section 4.21, <i>Interrupt Event Register</i>) are set to 1, this inconsistent-cycle interrupt mask enables interrupt generation.
22	cycleLost	RSC	When this bit and bit 22 (cycleLost) in the interrupt event register at OHCI offset 80h/84h (see Section 4.21, <i>Interrupt Event Register</i>) are set to 1, this lost-cycle interrupt mask enables interrupt generation.
21	cycle64Seconds	RSC	When this bit and bit 21 (cycle64Seconds) in the interrupt event register at OHCI offset 80h/84h (see Section 4.21, <i>Interrupt Event Register</i>) are set to 1, this 64-second-cycle interrupt mask enables interrupt generation.
20	cycleSynch	RSC	When this bit and bit 20 (cycleSynch) in the interrupt event register at OHCI offset 80h/84h (see Section 4.21, <i>Interrupt Event Register</i>) are set to 1, this isochronous-cycle interrupt mask enables interrupt generation.

Table 4–16. Interrupt Mask Register Description (Continued)

BIT	FIELD NAME	TYPE	DESCRIPTION
19	phy	RSC	When this bit and bit 19 (phy) in the interrupt event register at OHCI offset 80h/84h (see Section 4.21, <i>Interrupt Event Register</i>) are set to 1, this PHY-status-transfer interrupt mask enables interrupt generation.
18	RSVD	R	Reserved. Bit 18 returns 0 when read.
17	busReset	RSC	When this bit and bit 17 (busReset) in the interrupt event register at OHCI offset 80h/84h (see Section 4.21, <i>Interrupt Event Register</i>) are set to 1, this bus-reset interrupt mask enables interrupt generation.
16	selfIDcomplete	RSC	When this bit and bit 16 (selfIDcomplete) in the interrupt event register at OHCI offset 80h/84h (see Section 4.21, <i>Interrupt Event Register</i>) are set to 1, this self-ID-complete interrupt mask enables interrupt generation.
15–10	RSVD	R	Reserved. Bits 15–10 return 0s when read.
9	lockRespErr	RSC	When this bit and bit 9 (lockRespErr) in the interrupt event register at OHCI offset 80h/84h (see Section 4.21, <i>Interrupt Event Register</i>) are set to 1, this lock-response-error interrupt mask enables interrupt generation.
8	postedWriteErr	RSC	When this bit and bit 8 (postedWriteErr) in the interrupt event register at OHCI offset 80h/84h (see Section 4.21, <i>Interrupt Event Register</i>) are set to 1, this posted-write-error interrupt mask enables interrupt generation.
7	isochRx	RSC	When this bit and bit 7 (isochRx) in the interrupt event register at OHCI offset 80h/84h (see Section 4.21, <i>Interrupt Event Register</i>) are set to 1, this isochronous-receive-DMA interrupt mask enables interrupt generation.
6	isochTx	RSC	When this bit and bit 6 (isochTx) in the interrupt event register at OHCI offset 80h/84h (see Section 4.21, <i>Interrupt Event Register</i>) are set to 1, this isochronous-transmit-DMA interrupt mask enables interrupt generation.
5	RSPkt	RSC	When this bit and bit 5 (RSPkt) in the interrupt event register at OHCI offset 80h/84h (see Section 4.21, <i>Interrupt Event Register</i>) are set to 1, this receive-response-packet interrupt mask enables interrupt generation.
4	RQPkt	RSC	When this bit and bit 4 (RQPkt) in the interrupt event register at OHCI offset 80h/84h (see Section 4.21, <i>Interrupt Event Register</i>) are set to 1, this receive-request-packet interrupt mask enables interrupt generation.
3	ARRS	RSC	When this bit and bit 3 (ARRS) in the interrupt event register at OHCI offset 80h/84h (see Section 4.21, <i>Interrupt Event Register</i>) are set to 1, this asynchronous-receive-response-DMA interrupt mask enables interrupt generation.
2	ARRQ	RSC	When this bit and bit 2 (ARRQ) in the interrupt event register at OHCI offset 80h/84h (see Section 4.21, <i>Interrupt Event Register</i>) are set to 1, this asynchronous-receive-request-DMA interrupt mask enables interrupt generation.
1	respTxComplete	RSC	When this bit and bit 1 (respTxComplete) in the interrupt event register at OHCI offset 80h/84h (see Section 4.21, <i>Interrupt Event Register</i>) are set to 1, this response-transmit-complete interrupt mask enables interrupt generation.
0	reqTxComplete	RSC	When this bit and bit 0 (reqTxComplete) in the interrupt event register at OHCI offset 80h/84h (see Section 4.21, <i>Interrupt Event Register</i>) are set to 1, this request-transmit-complete interrupt mask enables interrupt generation.

4.23 Isochronous Transmit Interrupt Event Register

The isochronous transmit interrupt event set/clear register reflects the interrupt state of the isochronous transmit contexts. An interrupt is generated on behalf of an isochronous transmit context if an OUTPUT_LAST* command completes and its interrupt bits are set to 1. Upon determining that the isoChTx (bit 6) interrupt in the interrupt event register at OHCI offset 80h/84h (see Section 4.21, *Interrupt Event Register*) has occurred, software can check this register to determine which context(s) caused the interrupt. The interrupt bits are set to 1 by an asserting edge of the corresponding interrupt signal, or by writing a 1 in the corresponding bit in the set register. The only mechanism to clear a bit in this register is to write a 1 to the corresponding bit in the clear register. See Table 4–17 for a complete description of the register contents.

Bit	31	30	29	28	27	26	25	24	23	22	21	20	19	18	17	16
Name	Isochronous transmit interrupt event															
Type	R	R	R	R	R	R	R	R	R	R	R	R	R	R	R	R
Default	0	0	0	0	0	0	0	0	0	0	0	0	0	0	0	0
Bit	15	14	13	12	11	10	9	8	7	6	5	4	3	2	1	0
Name	Isochronous transmit interrupt event															
Type	R	R	R	R	R	R	R	R	RSC	RSC	RSC	RSC	RSC	RSC	RSC	RSC
Default	0	0	0	0	0	0	0	0	X	X	X	X	X	X	X	X

Register: **Isochronous transmit interrupt event**
 Type: Read/Set/Clear, Read-only
 Offset: 90h set register
 94h clear register [returns the contents of the isochronous transmit interrupt event register bit-wise ANDed with the isochronous transmit interrupt mask register when read]
 Default: 0000 00XXh

Table 4–17. Isochronous Transmit Interrupt Event Register Description

BIT	FIELD NAME	TYPE	DESCRIPTION
31–8	RSVD	R	Reserved. Bits 31–8 return 0s when read.
7	isoXmit7	RSC	Isochronous transmit channel 7 caused the interrupt event register bit 6 (isoChTx) interrupt.
6	isoXmit6	RSC	Isochronous transmit channel 6 caused the interrupt event register bit 6 (isoChTx) interrupt.
5	isoXmit5	RSC	Isochronous transmit channel 5 caused the interrupt event register bit 6 (isoChTx) interrupt.
4	isoXmit4	RSC	Isochronous transmit channel 4 caused the interrupt event register bit 6 (isoChTx) interrupt.
3	isoXmit3	RSC	Isochronous transmit channel 3 caused the interrupt event register bit 6 (isoChTx) interrupt.
2	isoXmit2	RSC	Isochronous transmit channel 2 caused the interrupt event register bit 6 (isoChTx) interrupt.
1	isoXmit1	RSC	Isochronous transmit channel 1 caused the interrupt event register bit 6 (isoChTx) interrupt.
0	isoXmit0	RSC	Isochronous transmit channel 0 caused the interrupt event register bit 6 (isoChTx) interrupt.

4.24 Isochronous Transmit Interrupt Mask Register

The isochronous transmit interrupt mask set/clear register enables the isochTx interrupt source on a per-channel basis. Reads from either the set register or the clear register always return the contents of the isochronous transmit interrupt mask register. In all cases, the enables for each interrupt event align with the isochronous transmit interrupt event register bits detailed in Table 4–17.

Bit	31	30	29	28	27	26	25	24	23	22	21	20	19	18	17	16
Name	Isochronous transmit interrupt mask															
Type	R	R	R	R	R	R	R	R	R	R	R	R	R	R	R	R
Default	0	0	0	0	0	0	0	0	0	0	0	0	0	0	0	0
Bit	15	14	13	12	11	10	9	8	7	6	5	4	3	2	1	0
Name	Isochronous transmit interrupt mask															
Type	R	R	R	R	R	R	R	R	RSC	RSC	RSC	RSC	RSC	RSC	RSC	RSC
Default	0	0	0	0	0	0	0	0	X	X	X	X	X	X	X	X

Register: **Isochronous transmit interrupt mask**
 Type: Read/Set/Clear, Read-only
 Offset: 98h set register
 9Ch clear register
 Default: 0000 00XXh

4.25 Isochronous Receive Interrupt Event Register

The isochronous receive interrupt event set/clear register reflects the interrupt state of the isochronous receive contexts. An interrupt is generated on behalf of an isochronous receive context if an INPUT_* command completes and its interrupt bits are set to 1. Upon determining that the isoRx (bit 7) interrupt in the interrupt event register at OHCI offset 80h/84h (see Section 4.21, *Interrupt Event Register*) has occurred, software can check this register to determine which context(s) caused the interrupt. The interrupt bits are set to 1 by the asserting edge of the corresponding interrupt signal, or by writing a 1 to the corresponding bit in the set register. The only mechanism to clear a bit in this register is to write a 1 to the corresponding bit in the clear register. See Table 4–18 for a complete description of the register contents.

Bit	31	30	29	28	27	26	25	24	23	22	21	20	19	18	17	16
Name	Isochronous receive interrupt event															
Type	R	R	R	R	R	R	R	R	R	R	R	R	R	R	R	R
Default	0	0	0	0	0	0	0	0	0	0	0	0	0	0	0	0
Bit	15	14	13	12	11	10	9	8	7	6	5	4	3	2	1	0
Name	Isochronous receive interrupt event															
Type	R	R	R	R	R	R	R	R	R	R	R	R	RSC	RSC	RSC	RSC
Default	0	0	0	0	0	0	0	0	0	0	0	0	X	X	X	X

Register: **Isochronous receive interrupt event**
 Type: Read/Set/Clear, Read-only
 Offset: A0h set register
 A4h clear register [returns the contents of the isochronous receive interrupt event register bit-wise ANDed with the isochronous receive mask register when read]
 Default: 0000 000Xh

Table 4–18. Isochronous Receive Interrupt Event Register Description

BIT	FIELD NAME	TYPE	DESCRIPTION
31–4	RSVD	R	Reserved. Bits 31–4 return 0s when read.
3	isoRecv3	RSC	Isochronous receive channel 3 caused the interrupt event register bit 7 (isoRx) interrupt.
2	isoRecv2	RSC	Isochronous receive channel 2 caused the interrupt event register bit 7 (isoRx) interrupt.
1	isoRecv1	RSC	Isochronous receive channel 1 caused the interrupt event register bit 7 (isoRx) interrupt.
0	isoRecv0	RSC	Isochronous receive channel 0 caused the interrupt event register bit 7 (isoRx) interrupt.

4.26 Isochronous Receive Interrupt Mask Register

The isochronous receive interrupt mask set/clear register enables the isochRx interrupt source on a per-channel basis. Reads from either the set register or the clear register always return the contents of the isochronous receive interrupt mask register. In all cases, the enables for each interrupt event align with the event register bits detailed in Table 4–18.

Bit	31	30	29	28	27	26	25	24	23	22	21	20	19	18	17	16
Name	Isochronous receive interrupt mask															
Type	R	R	R	R	R	R	R	R	R	R	R	R	R	R	R	R
Default	0	0	0	0	0	0	0	0	0	0	0	0	0	0	0	0
Bit	15	14	13	12	11	10	9	8	7	6	5	4	3	2	1	0
Name	Isochronous receive interrupt mask															
Type	R	R	R	R	R	R	R	R	R	R	R	R	RSC	RSC	RSC	RSC
Default	0	0	0	0	0	0	0	0	0	0	0	0	X	X	X	X

Register: **Isochronous receive interrupt mask**
 Type: Read/Set/Clear, Read-only
 Offset: A8h set register
 ACh clear register
 Default: 0000 000Xh

4.27 Fairness Control Register

The fairness control register provides a mechanism by which software can direct the host controller to transmit multiple asynchronous requests during a fairness interval. See Table 4–19 for a complete description of the register contents.

Bit	31	30	29	28	27	26	25	24	23	22	21	20	19	18	17	16
Name	Fairness control															
Type	R	R	R	R	R	R	R	R	R	R	R	R	R	R	R	R
Default	0	0	0	0	0	0	0	0	0	0	0	0	0	0	0	0
Bit	15	14	13	12	11	10	9	8	7	6	5	4	3	2	1	0
Name	Fairness control															
Type	R	R	R	R	R	R	R	R	R/W	R/W	R/W	R/W	R/W	R/W	R/W	R/W
Default	0	0	0	0	0	0	0	0	0	0	0	0	0	0	0	0

Register: **Fairness control**
 Type: Read-only, Read/Write
 Offset: DCh
 Default: 0000 0000h

Table 4–19. Fairness Control Register Description

BIT	FIELD NAME	TYPE	DESCRIPTION
31–8	RSVD	R	Reserved. Bits 31–8 return 0s when read.
7–0	pri_req	R/W	This field specifies the maximum number of priority arbitration requests for asynchronous request packets that the link is permitted to make of the PHY device during a fairness interval.

4.28 Link Control Register

The link control set/clear register provides the control flags that enable and configure the link core protocol portions of the TSB12LV26 device. It contains controls for the receiver and cycle timer. See Table 4–20 for a complete description of the register contents.

Bit	31	30	29	28	27	26	25	24	23	22	21	20	19	18	17	16
Name	Link control															
Type	R	R	R	R	R	R	R	R	R	RSC	RSCU	RSC	R	R	R	R
Default	0	0	0	0	0	0	0	0	0	X	X	X	0	0	0	0
Bit	15	14	13	12	11	10	9	8	7	6	5	4	3	2	1	0
Name	Link control															
Type	R	R	R	R	R	RSC	RSC	R	R	R	R	R	R	R	R	R
Default	0	0	0	0	0	X	X	0	0	0	0	0	0	0	0	0

Register: **Link control**
 Type: Read/Set/Clear/Update, Read/Set/Clear, Read-only
 Offset: E0h set register
 E4h clear register
 Default: 00X0 0X00h

Table 4–20. Link Control Register Description

BIT	FIELD NAME	TYPE	DESCRIPTION
31–23	RSVD	R	Reserved. Bits 31–23 return 0s when read.
22	cycleSource	RSC	When bit 22 is set to 1, the cycle timer uses an external source (CYCLEIN) to determine when to roll over the cycle timer. When this bit is cleared, the cycle timer rolls over when the timer reaches 3072 cycles of the 24.576-MHz clock (125 μs).
21	cycleMaster	RSCU	When bit 21 is set to 1 and the PHY device has notified the TSB12LV26 device that the PHY device is root, the TSB12LV26 device generates a cycle start packet every time the cycle timer rolls over, based on the setting of bit 22 (cycleSource). When bit 21 is cleared, the OHCI-Lynx™ accepts received cycle start packets to maintain synchronization with the node that is sending them. Bit 21 is automatically cleared when bit 25 (cycleTooLong) in the interrupt event register at OHCI offset 80h/84h (see Section 4.21, <i>Interrupt Event Register</i>) is set to 1. Bit 21 cannot be set to 1 until bit 25 (cycleTooLong) is cleared.
20	CycleTimerEnable	RSC	When bit 20 is set to 1, the cycle timer offset counts cycles of the 24.576-MHz clock and rolls over at the appropriate time, based on the settings of the above bits. When this bit is cleared, the cycle timer offset does not count.
19–11	RSVD	R	Reserved. Bits 19–11 return 0s when read.
10	RcvPhyPkt	RSC	When bit 10 is set to 1, the receiver accepts incoming PHY packets into the AR request context if the AR request context is enabled. This bit does not control receipt of self-ID packets.
9	RcvSelfID	RSC	When bit 9 is set to 1, the receiver accepts incoming self-ID packets. Before setting this bit to 1, software must ensure that the self-ID buffer pointer register contains a valid address.
8–0	RSVD	R	Reserved. Bits 8–0 return 0s when read.

4.29 Node Identification Register

The node identification register contains the address of the node on which the OHCI-Lynx™ chip resides, and indicates the valid node number status. The 16-bit combination of the busNumber field (bits 15–6) and the NodeNumber field (bits 5–0) is referred to as the node ID. See Table 4–21 for a complete description of the register contents.

Bit	31	30	29	28	27	26	25	24	23	22	21	20	19	18	17	16
Name	Node identification															
Type	RU	RU	R	R	RU	R	R	R	R	R	R	R	R	R	R	R
Default	0	0	0	0	0	0	0	0	0	0	0	0	0	0	0	0
Bit	15	14	13	12	11	10	9	8	7	6	5	4	3	2	1	0
Name	Node identification															
Type	RWU	RWU	RWU	RWU	RWU	RWU	RWU	RWU	RWU	RWU	RU	RU	RU	RU	RU	RU
Default	1	1	1	1	1	1	1	1	1	1	X	X	X	X	X	X

Register: **Node identification**
 Type: Read/Write/Update, Read/Update, Read-only
 Offset: E8h
 Default: 0000 FFXXh

Table 4–21. Node Identification Register Description

BIT	FIELD NAME	TYPE	DESCRIPTION
31	iDValid	RU	Bit 31 indicates whether or not the TSB12LV26 device has a valid node number. It is cleared when a 1394 bus reset is detected, and set to 1 when the TSB12LV26 device receives a new node number from the PHY device.
30	root	RU	Bit 30 is set to 1 during the bus reset process if the attached PHY device is root.
29–28	RSVD	R	Reserved. Bits 29 and 28 return 0s when read.
27	CPS	RU	Bit 27 is set to 1 if the PHY device is reporting that cable power status is OK.
26–16	RSVD	R	Reserved. Bits 26–16 return 0s when read.
15–6	BusNumber	RWU	This field identifies the specific 1394 bus the TSB12LV26 device belongs to when multiple 1394-compatible buses are connected via a bridge.
5–0	NodeNumber	RU	This field is the physical node number established by the PHY device during self-ID. It is automatically set to the value received from the PHY device after the self-ID phase. If the PHY device sets the NodeNumber to 63, software must not set bit 15 (run) in the asynchronous context control register (see Section 4.37, <i>Asynchronous Context Control Register</i>) for either of the AT DMA contexts.

4.30 PHY Layer Control Register

The PHY layer control register reads or writes a PHY register. See Table 4–22 for a complete description of the register contents.

Bit	31	30	29	28	27	26	25	24	23	22	21	20	19	18	17	16
Name	PHY layer control															
Type	RU	R	R	R	RU	RU	RU	RU	RU	RU	RU	RU	RU	RU	RU	RU
Default	0	0	0	0	0	0	0	0	0	0	0	0	0	0	0	0
Bit	15	14	13	12	11	10	9	8	7	6	5	4	3	2	1	0
Name	PHY layer control															
Type	RWU	RWU	R	R	R/W	R/W	R/W	R/W	R/W	R/W	R/W	R/W	R/W	R/W	R/W	R/W
Default	0	0	0	0	0	0	0	0	0	0	0	0	0	0	0	0

Register: **PHY layer control**
 Type: Read/Write/Update, Read/Write, Read/Update, Read-only
 Offset: ECh
 Default: 0000 0000h

Table 4–22. PHY Layer Control Register Description

BIT	FIELD NAME	TYPE	DESCRIPTION
31	rdDone	RU	Bit 31 is cleared to 0 by the TSB12LV26 device when either bit 15 (rdReg) or bit 14 (wrReg) is set to 1. This bit is set to 1 when a register transfer is received from the PHY device.
30–28	RSVD	R	Reserved. Bits 30–28 return 0s when read.
27–24	rdAddr	RU	This field is the address of the register most recently received from the PHY device.
23–16	rdData	RU	This field is the contents of a PHY register that has been read.
15	rdReg	RWU	Bit 15 is set to 1 by software to initiate a read request to a PHY register, and is cleared by hardware when the request has been sent. Bits 14 (wrReg) and 15 (rdReg) must not both be set to 1 simultaneously.
14	wrReg	RWU	Bit 14 is set to 1 by software to initiate a write request to a PHY register, and is cleared by hardware when the request has been sent. Bits 14 (wrReg) and 15 (rdReg) must not both be set to 1 simultaneously.
13–12	RSVD	R	Reserved. Bits 13 and 12 return 0s when read.
11–8	regAddr	R/W	This field is the address of the PHY register to be written or read.
7–0	wrData	R/W	This field is the data to be written to a PHY register and is ignored for reads.

4.31 Isochronous Cycle Timer Register

The isochronous cycle timer register indicates the current cycle number and offset. When the TSB12LV26 device is cycle master, this register is transmitted with the cycle start message. When the TSB12LV26 device is not cycle master, this register is loaded with the data field in an incoming cycle start. In the event that the cycle start message is not received, the fields can continue incrementing on their own (if programmed) to maintain a local time reference. See Table 4–23 for a complete description of the register contents.

Bit	31	30	29	28	27	26	25	24	23	22	21	20	19	18	17	16
Name	Isochronous cycle timer															
Type	RWU	RWU	RWU	RWU	RWU	RWU	RWU	RWU	RWU	RWU	RWU	RWU	RWU	RWU	RWU	RWU
Default	X	X	X	X	X	X	X	X	X	X	X	X	X	X	X	X
Bit	15	14	13	12	11	10	9	8	7	6	5	4	3	2	1	0
Name	Isochronous cycle timer															
Type	RWU	RWU	RWU	RWU	RWU	RWU	RWU	RWU	RWU	RWU	RWU	RWU	RWU	RWU	RWU	RWU
Default	X	X	X	X	X	X	X	X	X	X	X	X	X	X	X	X

Register: **Isochronous cycle timer**
 Type: Read/Write/Update
 Offset: F0h
 Default: XXXX XXXXh

Table 4–23. Isochronous Cycle Timer Register Description

BIT	FIELD NAME	TYPE	DESCRIPTION
31–25	cycleSeconds	RWU	This field counts seconds [rollovers from bits 24–12 (cycleCount field)] modulo 128.
24–12	cycleCount	RWU	This field counts cycles [rollovers from bits 11–0 (cycleOffset field)] modulo 8000.
11–0	cycleOffset	RWU	This field counts 24.576-MHz clocks modulo 3072, that is, 125 μs. If an external 8-kHz clock configuration is being used, this field must be cleared to 0 at each tick of the external clock.

4.32 Asynchronous Request Filter High Register

The asynchronous request filter high set/clear register enables asynchronous receive requests on a per-node basis, and handles the upper node IDs. When a packet is destined for either the physical request context or the ARRQ context, the source node ID is examined. If the bit corresponding to the node ID is not set to 1 in this register, the packet is not acknowledged and the request is not queued. The node ID comparison is done if the source node is on the same bus as the TSB12LV26 device. Nonlocal bus-sourced packets are not acknowledged unless bit 31 in this register is set to 1. See Table 4–24 for a complete description of the register contents.

Bit	31	30	29	28	27	26	25	24	23	22	21	20	19	18	17	16
Name	Asynchronous request filter high															
Type	RSC	RSC	RSC	RSC	RSC	RSC	RSC	RSC	RSC	RSC	RSC	RSC	RSC	RSC	RSC	RSC
Default	0	0	0	0	0	0	0	0	0	0	0	0	0	0	0	0
Bit	15	14	13	12	11	10	9	8	7	6	5	4	3	2	1	0
Name	Asynchronous request filter high															
Type	RSC	RSC	RSC	RSC	RSC	RSC	RSC	RSC	RSC	RSC	RSC	RSC	RSC	RSC	RSC	RSC
Default	0	0	0	0	0	0	0	0	0	0	0	0	0	0	0	0

Register: **Asynchronous request filter high**
 Type: Read/Set/Clear
 Offset: 100h set register
 104h clear register
 Default: 0000 0000h

Table 4–24. Asynchronous Request Filter High Register Description

BIT	FIELD NAME	TYPE	DESCRIPTION
31	asynReqAllBuses	RSC	If bit 31 is set to 1, all asynchronous requests received by the TSB12LV26 device from nonlocal bus nodes are accepted.
30	asynReqResource62	RSC	If bit 30 is set to 1 for local bus node number 62, asynchronous requests received by the TSB12LV26 device from that node are accepted.
29	asynReqResource61	RSC	If bit 29 is set to 1 for local bus node number 61, asynchronous requests received by the TSB12LV26 device from that node are accepted.
28	asynReqResource60	RSC	If bit 28 is set to 1 for local bus node number 60, asynchronous requests received by the TSB12LV26 device from that node are accepted.
27	asynReqResource59	RSC	If bit 27 is set to 1 for local bus node number 59, asynchronous requests received by the TSB12LV26 device from that node are accepted.
26	asynReqResource58	RSC	If bit 26 is set to 1 for local bus node number 58, asynchronous requests received by the TSB12LV26 device from that node are accepted.
25	asynReqResource57	RSC	If bit 25 is set to 1 for local bus node number 57, asynchronous requests received by the TSB12LV26 device from that node are accepted.
24	asynReqResource56	RSC	If bit 24 is set to 1 for local bus node number 56, asynchronous requests received by the TSB12LV26 device from that node are accepted.
23	asynReqResource55	RSC	If bit 23 is set to 1 for local bus node number 55, asynchronous requests received by the TSB12LV26 device from that node are accepted.
22	asynReqResource54	RSC	If bit 22 is set to 1 for local bus node number 54, asynchronous requests received by the TSB12LV26 device from that node are accepted.
21	asynReqResource53	RSC	If bit 21 is set to 1 for local bus node number 53, asynchronous requests received by the TSB12LV26 device from that node are accepted.
20	asynReqResource52	RSC	If bit 20 is set to 1 for local bus node number 52, asynchronous requests received by the TSB12LV26 device from that node are accepted.
19	asynReqResource51	RSC	If bit 19 is set to 1 for local bus node number 51, asynchronous requests received by the TSB12LV26 device from that node are accepted.

Table 4–24. Asynchronous Request Filter High Register Description (Continued)

BIT	FIELD NAME	TYPE	DESCRIPTION
18	asynReqResource50	RSC	If bit 18 is set to 1 for local bus node number 50, asynchronous requests received by the TSB12LV26 device from that node are accepted.
17	asynReqResource49	RSC	If bit 17 is set to 1 for local bus node number 49, asynchronous requests received by the TSB12LV26 device from that node are accepted.
16	asynReqResource48	RSC	If bit 16 is set to 1 for local bus node number 48, asynchronous requests received by the TSB12LV26 device from that node are accepted.
15	asynReqResource47	RSC	If bit 15 is set to 1 for local bus node number 47, asynchronous requests received by the TSB12LV26 device from that node are accepted.
14	asynReqResource46	RSC	If bit 14 is set to 1 for local bus node number 46, asynchronous requests received by the TSB12LV26 device from that node are accepted.
13	asynReqResource45	RSC	If bit 13 is set to 1 for local bus node number 45, asynchronous requests received by the TSB12LV26 device from that node are accepted.
12	asynReqResource44	RSC	If bit 12 is set to 1 for local bus node number 44, asynchronous requests received by the TSB12LV26 device from that node are accepted.
11	asynReqResource43	RSC	If bit 11 is set to 1 for local bus node number 43, asynchronous requests received by the TSB12LV26 device from that node are accepted.
10	asynReqResource42	RSC	If bit 10 is set to 1 for local bus node number 42, asynchronous requests received by the TSB12LV26 device from that node are accepted.
9	asynReqResource41	RSC	If bit 9 is set to 1 for local bus node number 41, asynchronous requests received by the TSB12LV26 device from that node are accepted.
8	asynReqResource40	RSC	If bit 8 is set to 1 for local bus node number 40, asynchronous requests received by the TSB12LV26 device from that node are accepted.
7	asynReqResource39	RSC	If bit 7 is set to 1 for local bus node number 39, asynchronous requests received by the TSB12LV26 device from that node are accepted.
6	asynReqResource38	RSC	If bit 6 is set to 1 for local bus node number 38, asynchronous requests received by the TSB12LV26 device from that node are accepted.
5	asynReqResource37	RSC	If bit 5 is set to 1 for local bus node number 37, asynchronous requests received by the TSB12LV26 device from that node are accepted.
4	asynReqResource36	RSC	If bit 4 is set to 1 for local bus node number 36, asynchronous requests received by the TSB12LV26 device from that node are accepted.
3	asynReqResource35	RSC	If bit 3 is set to 1 for local bus node number 35, asynchronous requests received by the TSB12LV26 device from that node are accepted.
2	asynReqResource34	RSC	If bit 2 is set to 1 for local bus node number 34, asynchronous requests received by the TSB12LV26 device from that node are accepted.
1	asynReqResource33	RSC	If bit 1 is set to 1 for local bus node number 33, asynchronous requests received by the TSB12LV26 device from that node are accepted.
0	asynReqResource32	RSC	If bit 0 is set to 1 for local bus node number 32, asynchronous requests received by the TSB12LV26 device from that node are accepted.

4.33 Asynchronous Request Filter Low Register

The asynchronous request filter low set/clear register enables asynchronous receive requests on a per-node basis and handles the lower node IDs. Other than filtering different node IDs, this register behaves identically to the asynchronous request filter high register. See Table 4–25 for a complete description of the register contents.

Bit	31	30	29	28	27	26	25	24	23	22	21	20	19	18	17	16
Name	Asynchronous request filter low															
Type	RSC	RSC	RSC	RSC	RSC	RSC	RSC	RSC	RSC	RSC	RSC	RSC	RSC	RSC	RSC	RSC
Default	0	0	0	0	0	0	0	0	0	0	0	0	0	0	0	0
Bit	15	14	13	12	11	10	9	8	7	6	5	4	3	2	1	0
Name	Asynchronous request filter low															
Type	RSC	RSC	RSC	RSC	RSC	RSC	RSC	RSC	RSC	RSC	RSC	RSC	RSC	RSC	RSC	RSC
Default	0	0	0	0	0	0	0	0	0	0	0	0	0	0	0	0

Register: **Asynchronous request filter low**
 Type: Read/Set/Clear
 Offset: 108h set register
 10Ch clear register
 Default: 0000 0000h

Table 4–25. Asynchronous Request Filter Low Register Description

BIT	FIELD NAME	TYPE	DESCRIPTION
31	asynReqResource31	RSC	If bit 31 is set to 1 for local bus node number 31, asynchronous requests received by the TSB12LV26 device from that node are accepted.
30	asynReqResource30	RSC	If bit 30 is set to 1 for local bus node number 30, asynchronous requests received by the TSB12LV26 device from that node are accepted.
29–2	asynReqResourcen	RSC	Bits 29 through 2 (asynReqResourcen, where n = 29, 28, 27, ..., 2) follow the same pattern as bits 31 and 30.
1	asynReqResource1	RSC	If bit 1 is set to 1 for local bus node number 1, asynchronous requests received by the TSB12LV26 device from that node are accepted.
0	asynReqResource0	RSC	If bit 0 is set to 1 for local bus node number 0, asynchronous requests received by the TSB12LV26 device from that node are accepted.

4.34 Physical Request Filter High Register

The physical request filter high set/clear register enables physical receive requests on a per-node basis, and handles the upper node IDs. When a packet is destined for the physical request context, and the node ID has been compared against the ARRQ registers, then the comparison is done again with this register. If the bit corresponding to the node ID is not set to 1 in this register, the request is handled by the ARRQ context instead of the physical request context. The node ID comparison is done if the source node is on the same bus as the TSB12LV26 device. Nonlocal bus-sourced packets are not acknowledged unless bit 31 in this register is set to 1. See Table 4–26 for a complete description of the register contents.

Bit	31	30	29	28	27	26	25	24	23	22	21	20	19	18	17	16
Name	Physical request filter high															
Type	RSC	RSC	RSC	RSC	RSC	RSC	RSC	RSC	RSC	RSC	RSC	RSC	RSC	RSC	RSC	RSC
Default	0	0	0	0	0	0	0	0	0	0	0	0	0	0	0	0
Bit	15	14	13	12	11	10	9	8	7	6	5	4	3	2	1	0
Name	Physical request filter high															
Type	RSC	RSC	RSC	RSC	RSC	RSC	RSC	RSC	RSC	RSC	RSC	RSC	RSC	RSC	RSC	RSC
Default	0	0	0	0	0	0	0	0	0	0	0	0	0	0	0	0

Register: **Physical request filter high**
 Type: Read/Set/Clear
 Offset: 110h set register
 114h clear register
 Default: 0000 0000h

Table 4–26. Physical Request Filter High Register Description

BIT	FIELD NAME	TYPE	DESCRIPTION
31	physReqAllBusses	RSC	If bit 31 is set to 1, all physical requests received by the TSB12LV26 device from nonlocal bus nodes are accepted.
30	physReqResource62	RSC	If bit 30 is set to 1 for local bus node number 62, physical requests received by the TSB12LV26 device from that node are handled through the physical request context.
29	physReqResource61	RSC	If bit 29 is set to 1 for local bus node number 61, physical requests received by the TSB12LV26 device from that node are handled through the physical request context.
28	physReqResource60	RSC	If bit 28 is set to 1 for local bus node number 60, physical requests received by the TSB12LV26 device from that node are handled through the physical request context.
27	physReqResource59	RSC	If bit 27 is set to 1 for local bus node number 59, physical requests received by the TSB12LV26 device from that node are handled through the physical request context.
26	physReqResource58	RSC	If bit 26 is set to 1 for local bus node number 58, physical requests received by the TSB12LV26 device from that node are handled through the physical request context.
25	physReqResource57	RSC	If bit 25 is set to 1 for local bus node number 57, physical requests received by the TSB12LV26 device from that node are handled through the physical request context.
24	physReqResource56	RSC	If bit 24 is set to 1 for local bus node number 56, physical requests received by the TSB12LV26 device from that node are handled through the physical request context.
23	physReqResource55	RSC	If bit 23 is set to 1 for local bus node number 55, physical requests received by the TSB12LV26 device from that node are handled through the physical request context.
22	physReqResource54	RSC	If bit 22 is set to 1 for local bus node number 54, physical requests received by the TSB12LV26 device from that node are handled through the physical request context.
21	physReqResource53	RSC	If bit 21 is set to 1 for local bus node number 53, physical requests received by the TSB12LV26 device from that node are handled through the physical request context.
20	physReqResource52	RSC	If bit 20 is set to 1 for local bus node number 52, physical requests received by the TSB12LV26 device from that node are handled through the physical request context.

Table 4–26. Physical Request Filter High Register Description (Continued)

BIT	FIELD NAME	TYPE	DESCRIPTION
19	physReqResource51	RSC	If bit 19 is set to 1 for local bus node number 51, physical requests received by the TSB12LV26 device from that node are handled through the physical request context.
18	physReqResource50	RSC	If bit 18 is set to 1 for local bus node number 50, physical requests received by the TSB12LV26 device from that node are handled through the physical request context.
17	physReqResource49	RSC	If bit 17 is set to 1 for local bus node number 49, physical requests received by the TSB12LV26 device from that node are handled through the physical request context.
16	physReqResource48	RSC	If bit 16 is set to 1 for local bus node number 48, physical requests received by the TSB12LV26 device from that node are handled through the physical request context.
15	physReqResource47	RSC	If bit 15 is set to 1 for local bus node number 47, physical requests received by the TSB12LV26 device from that node are handled through the physical request context.
14	physReqResource46	RSC	If bit 14 is set to 1 for local bus node number 46, physical requests received by the TSB12LV26 device from that node are handled through the physical request context.
13	physReqResource45	RSC	If bit 13 is set to 1 for local bus node number 45, physical requests received by the TSB12LV26 device from that node are handled through the physical request context.
12	physReqResource44	RSC	If bit 12 is set to 1 for local bus node number 44, physical requests received by the TSB12LV26 device from that node are handled through the physical request context.
11	physReqResource43	RSC	If bit 11 is set to 1 for local bus node number 43, physical requests received by the TSB12LV26 device from that node are handled through the physical request context.
10	physReqResource42	RSC	If bit 10 is set to 1 for local bus node number 42, physical requests received by the TSB12LV26 device from that node are handled through the physical request context.
9	physReqResource41	RSC	If bit 9 is set to 1 for local bus node number 41, physical requests received by the TSB12LV26 device from that node are handled through the physical request context.
8	physReqResource40	RSC	If bit 8 is set to 1 for local bus node number 40, physical requests received by the TSB12LV26 device from that node are handled through the physical request context.
7	physReqResource39	RSC	If bit 7 is set to 1 for local bus node number 39, physical requests received by the TSB12LV26 device from that node are handled through the physical request context.
6	physReqResource38	RSC	If bit 6 is set to 1 for local bus node number 38, physical requests received by the TSB12LV26 device from that node are handled through the physical request context.
5	physReqResource37	RSC	If bit 5 is set to 1 for local bus node number 37, physical requests received by the TSB12LV26 device from that node are handled through the physical request context.
4	physReqResource36	RSC	If bit 4 is set to 1 for local bus node number 36, physical requests received by the TSB12LV26 device from that node are handled through the physical request context.
3	physReqResource35	RSC	If bit 3 is set to 1 for local bus node number 35, physical requests received by the TSB12LV26 device from that node are handled through the physical request context.
2	physReqResource34	RSC	If bit 2 is set to 1 for local bus node number 34, physical requests received by the TSB12LV26 device from that node are handled through the physical request context.
1	physReqResource33	RSC	If bit 1 is set to 1 for local bus node number 33, physical requests received by the TSB12LV26 device from that node are handled through the physical request context.
0	physReqResource32	RSC	If bit 0 is set to 1 for local bus node number 32, physical requests received by the TSB12LV26 device from that node are handled through the physical request context.

4.35 Physical Request Filter Low Register

The physical request filter low set/clear register enables physical receive requests on a per-node basis, and handles the lower node IDs. When a packet is destined for the physical request context, and the node ID has been compared against the asynchronous request filter registers, then the node ID comparison is done again with this register. If the bit corresponding to the node ID is not set to 1 in this register, the request is handled by the asynchronous request context instead of the physical request context. See Table 4–27 for a complete description of the register contents.

Bit	31	30	29	28	27	26	25	24	23	22	21	20	19	18	17	16
Name	Physical request filter low															
Type	RSC	RSC	RSC	RSC	RSC	RSC	RSC	RSC	RSC	RSC	RSC	RSC	RSC	RSC	RSC	RSC
Default	0	0	0	0	0	0	0	0	0	0	0	0	0	0	0	0
Bit	15	14	13	12	11	10	9	8	7	6	5	4	3	2	1	0
Name	Physical request filter low															
Type	RSC	RSC	RSC	RSC	RSC	RSC	RSC	RSC	RSC	RSC	RSC	RSC	RSC	RSC	RSC	RSC
Default	0	0	0	0	0	0	0	0	0	0	0	0	0	0	0	0

Register: **Physical request filter low**
 Type: Read/Set/Clear
 Offset: 118h set register
 11Ch clear register
 Default: 0000 0000h

Table 4–27. Physical Request Filter Low Register Description

BIT	FIELD NAME	TYPE	DESCRIPTION
31	physReqResource31	RSC	If bit 31 is set to 1 for local bus node number 31, physical requests received by the TSB12LV26 device from that node are handled through the physical request context.
30	physReqResource30	RSC	If bit 30 is set to 1 for local bus node number 30, physical requests received by the TSB12LV26 device from that node are handled through the physical request context.
29–2	physReqResourcen	RSC	Bits 29 through 2 (physReqResourcen, where n = 29, 28, 27, ..., 2) follow the same pattern as bits 31 and 30.
1	physReqResource1	RSC	If bit 1 is set to 1 for local bus node number 1, physical requests received by the TSB12LV26 device from that node are handled through the physical request context.
0	physReqResource0	RSC	If bit 0 is set to 1 for local bus node number 0, physical requests received by the TSB12LV26 device from that node are handled through the physical request context.

4.36 Physical Upper Bound Register (Optional Register)

The physical upper bound register is an optional register and is not implemented. This register returns all 0s when read.

Bit	31	30	29	28	27	26	25	24	23	22	21	20	19	18	17	16
Name	Physical upper bound															
Type	R	R	R	R	R	R	R	R	R	R	R	R	R	R	R	R
Default	0	0	0	0	0	0	0	0	0	0	0	0	0	0	0	0
Bit	15	14	13	12	11	10	9	8	7	6	5	4	3	2	1	0
Name	Physical upper bound															
Type	R	R	R	R	R	R	R	R	R	R	R	R	R	R	R	R
Default	0	0	0	0	0	0	0	0	0	0	0	0	0	0	0	0

Register: **Physical upper bound**
 Type: Read-only
 Offset: 120h
 Default: 0000 0000h

4.37 Asynchronous Context Control Register

The asynchronous context control set/clear register controls the state and indicates status of the DMA context. See Table 4–28 for a complete description of the register contents.

Bit	31	30	29	28	27	26	25	24	23	22	21	20	19	18	17	16
Name	Asynchronous context control															
Type	R	R	R	R	R	R	R	R	R	R	R	R	R	R	R	R
Default	0	0	0	0	0	0	0	0	0	0	0	0	0	0	0	0
Bit	15	14	13	12	11	10	9	8	7	6	5	4	3	2	1	0
Name	Asynchronous context control															
Type	RSCU	R	R	RSU	RU	RU	R	R	RU	RU	RU	RU	RU	RU	RU	RU
Default	0	0	0	X	0	0	0	0	X	X	X	X	X	X	X	X

Register: **Asynchronous context control**
 Type: Read/Set/Clear/Update, Read/Set/Update, Read/Update, Read-only
 Offset: 180h set register [ATRQ]
 184h clear register [ATRQ]
 1A0h set register [ATRS]
 1A4h clear register [ATRS]
 1C0h set register [ARRQ]
 1C4h clear register [ARRQ]
 1E0h set register [ARRS]
 1E4h clear register [ARRS]
 Default: 0000 X0XXh

Table 4–28. Asynchronous Context Control Register Description

BIT	FIELD NAME	TYPE	DESCRIPTION
31–16	RSVD	R	Reserved. Bits 31–16 return 0s when read.
15	run	RSCU	Bit 15 is set to 1 by software to enable descriptor processing for the context and cleared by software to stop descriptor processing. The TSB12LV26 device changes this bit only on a system (hardware) or software reset.
14–13	RSVD	R	Reserved. Bits 14 and 13 return 0s when read.
12	wake	RSU	Software sets bit 12 to 1 to cause the TSB12LV26 device to continue or resume descriptor processing. The TSB12LV26 device clears this bit on every descriptor fetch.
11	dead	RU	The TSB12LV26 device sets bit 11 to 1 when it encounters a fatal error, and clears the bit when software clears bit 15 (run).
10	active	RU	The TSB12LV26 device sets bit 10 to 1 when it is processing descriptors.
9–8	RSVD	R	Reserved. Bits 9 and 8 return 0s when read.
7–5	spd	RU	This field indicates the speed at which a packet was received or transmitted and only contains meaningful information for receive contexts. This field is encoded as: 000 = 100M bits/sec 001 = 200M bits/sec 010 = 400M bits/sec All other values are reserved.
4–0	eventcode	RU	This field holds the acknowledge sent by the link core for this packet or an internally generated error code if the packet was not transferred successfully.

4.38 Asynchronous Context Command Pointer Register

The asynchronous context command pointer register contains a pointer to the address of the first descriptor block that the TSB12LV26 device accesses when software enables the context by setting bit 15 (run) in the asynchronous context control register (see Section 4.37) to 1. See Table 4–29 for a complete description of the register contents.

Bit	31	30	29	28	27	26	25	24	23	22	21	20	19	18	17	16
Name	Asynchronous context command pointer															
Type	RWU	RWU	RWU	RWU	RWU	RWU	RWU	RWU	RWU	RWU	RWU	RWU	RWU	RWU	RWU	RWU
Default	X	X	X	X	X	X	X	X	X	X	X	X	X	X	X	X
Bit	15	14	13	12	11	10	9	8	7	6	5	4	3	2	1	0
Name	Asynchronous context command pointer															
Type	RWU	RWU	RWU	RWU	RWU	RWU	RWU	RWU	RWU	RWU	RWU	RWU	RWU	RWU	RWU	RWU
Default	X	X	X	X	X	X	X	X	X	X	X	X	X	X	X	X

Register: **Asynchronous context command pointer**

Type: Read/Write/Update

Offset: 18Ch [ATRQ]

1ACh [ATRS]

1CCh [ARRQ]

1ECh [ARRS]

Default: XXXX XXXXh

Table 4–29. Asynchronous Context Command Pointer Register Description

BIT	FIELD NAME	TYPE	DESCRIPTION
31–4	descriptorAddress	RWU	Contains the upper 28 bits of the address of a 16-byte aligned descriptor block.
3–0	Z	RWU	Indicates the number of contiguous descriptors at the address pointed to by the descriptor address. If Z is 0, it indicates that the descriptorAddress field (bits 31–4) is not valid.

4.39 Isochronous Transmit Context Control Register

The isochronous transmit context control set/clear register controls options, state, and status for the isochronous transmit DMA contexts. The n value in the following register addresses indicates the context number (n = 0, 1, 2, 3, ..., 7). See Table 4–30 for a complete description of the register contents.

Bit	31	30	29	28	27	26	25	24	23	22	21	20	19	18	17	16
Name	Isochronous transmit context control															
Type	RSCU	RSC	RSC	RSC	RSC	RSC	RSC	RSC	RSC	RSC	RSC	RSC	RSC	RSC	RSC	RSC
Default	X	X	X	X	X	X	X	X	X	X	X	X	X	X	X	X
Bit	15	14	13	12	11	10	9	8	7	6	5	4	3	2	1	0
Name	Isochronous transmit context control															
Type	RSC	R	R	RSU	RU	RU	R	R	RU	RU	RU	RU	RU	RU	RU	RU
Default	0	0	0	X	0	0	0	0	X	X	X	X	X	X	X	X

Register: **Isochronous transmit context control**
 Type: Read/Set/Clear/Update, Read/Set/Clear, Read/Set/Update, Read/Update, Read-only
 Offset: 200h + (16 * n) set register
 204h + (16 * n) clear register
 Default: XXXX X0XXh

Table 4–30. Isochronous Transmit Context Control Register Description

BIT	FIELD NAME	TYPE	DESCRIPTION
31	cycleMatchEnable	RSCU	When bit 31 is set to 1, processing occurs such that the packet described by the context first descriptor block is transmitted in the cycle whose number is specified in the cycleMatch field (bits 30–16). The cycleMatch field (bits 30–16) must match the low-order two bits of cycleSeconds and the 13-bit cycleCount field in the cycle start packet that is sent or received immediately before isochronous transmission begins. Since the isochronous transmit DMA controller may work ahead, the processing of the first descriptor block may begin slightly in advance of the actual cycle in which the first packet is transmitted. The effects of this bit, however, are impacted by the values of other bits in this register and are explained in the <i>1394 Open Host Controller Interface Specification</i> . Once the context has become active, hardware clears this bit.
30–16	cycleMatch	RSC	This field contains a 15-bit value, corresponding to the low-order two bits in the bus isochronous cycle timer register at OHCI offset F0h (see Section 4.31, <i>Isochronous Cycle Timer Register</i>) cycleSeconds field (bits 31–25) and the cycleCount field (bits 24–12). If bit 31 (cycleMatchEnable) is set to 1, this isochronous transmit DMA context becomes enabled for transmits when the low-order two bits of the bus isochronous cycle timer register cycleSeconds field (bits 31–25) and the cycleCount field (bits 24–12) value equal this field (cycleMatch) value.
15	run	RSC	Bit 15 is set to 1 by software to enable descriptor processing for the context and cleared by software to stop descriptor processing. The TSB12LV26 device changes this bit only on a system (hardware) or software reset.
14–13	RSVD	R	Reserved. Bits 14 and 13 return 0s when read.
12	wake	RSU	Software sets bit 12 to 1 to cause the TSB12LV26 device to continue or resume descriptor processing. The TSB12LV26 device clears this bit on every descriptor fetch.
11	dead	RU	The TSB12LV26 device sets bit 11 to 1 when it encounters a fatal error, and clears the bit when software clears bit 15 (run).
10	active	RU	The TSB12LV26 device sets bit 10 to 1 when it is processing descriptors.
9–8	RSVD	R	Reserved. Bits 9 and 8 return 0s when read.
7–5	spd	RU	This field is not meaningful for isochronous transmit contexts.
4–0	event code	RU	Following an OUTPUT_LAST* command, the error code is indicated in this field. Possible values are: ack_complete, evt_descriptor_read, evt_data_read, and evt_unknown.

4.40 Isochronous Transmit Context Command Pointer Register

The isochronous transmit context command pointer register contains a pointer to the address of the first descriptor block that the TSB12LV26 device accesses when software enables an isochronous transmit context by setting bit 15 (run) in the isochronous transmit context control register (see Section 4.39, *Isochronous Transmit Context Control Register*) to 1. The n value in the following register addresses indicates the context number (n = 0, 1, 2, 3, ..., 7).

Bit	31	30	29	28	27	26	25	24	23	22	21	20	19	18	17	16
Name	Isochronous transmit context command pointer															
Type	R	R	R	R	R	R	R	R	R	R	R	R	R	R	R	R
Default	X	X	X	X	X	X	X	X	X	X	X	X	X	X	X	X
Bit	15	14	13	12	11	10	9	8	7	6	5	4	3	2	1	0
Name	Isochronous transmit context command pointer															
Type	R	R	R	R	R	R	R	R	R	R	R	R	R	R	R	R
Default	X	X	X	X	X	X	X	X	X	X	X	X	X	X	X	X

Register: **Isochronous transmit context command pointer**

Type: Read-only

Offset: 20Ch + (16 * n)

Default: XXXX XXXXh

4.41 Isochronous Receive Context Control Register

The isochronous receive context control set/clear register controls options, state, and status for the isochronous receive DMA contexts. The n value in the following register addresses indicates the context number (n = 0, 1, 2, 3). See Table 4–31 for a complete description of the register contents.

Bit	31	30	29	28	27	26	25	24	23	22	21	20	19	18	17	16
Name	Isochronous receive context control															
Type	RSC	RSC	RSCU	RSC	R	R	R	R	R	R	R	R	R	R	R	R
Default	X	X	X	X	0	0	0	0	0	0	0	0	0	0	0	0
Bit	15	14	13	12	11	10	9	8	7	6	5	4	3	2	1	0
Name	Isochronous receive context control															
Type	RSCU	R	R	RSU	RU	RU	R	R	RU	RU	RU	RU	RU	RU	RU	RU
Default	0	0	0	X	0	0	0	0	X	X	X	X	X	X	X	X

Register: **Isochronous receive context control**

Type: Read/Set/Clear/Update, Read/Set/Clear, Read/Update, Read-only

Offset: 400h + (32 * n) set register

404h + (32 * n) clear register

Default: X000 X0XXh

Table 4–31. Isochronous Receive Context Control Register Description

BIT	FIELD NAME	TYPE	DESCRIPTION
31	bufferFill	RSC	When bit 31 is set to 1, received packets are placed back-to-back to completely fill each receive buffer. When this bit is cleared, each received packet is placed in a single buffer. If bit 28 (multiChanMode) is set to 1, this bit must also be set to 1. The value of this bit must not be changed while bit 10 (active) or bit 15 (run) is set to 1.
30	isochHeader	RSC	When bit 30 is set to 1, received isochronous packets include the complete 4-byte isochronous packet header seen by the link layer. The end of the packet is marked with xferStatus in the first doublet, and a 16-bit timeStamp indicating the time of the most recently received (or sent) cycleStart packet. When this bit is cleared, the packet header is stripped from received isochronous packets. The packet header, if received, immediately precedes the packet payload. The value of this bit must not be changed while bit 10 (active) or bit 15 (run) is set to 1.

Table 4–31. Isochronous Receive Context Control Register Description (Continued)

BIT	FIELD NAME	TYPE	DESCRIPTION
29	cycleMatchEnable	RSCU	When bit 29 is set to 1 and the 13-bit cycleMatch field (bits 24–12) in the isochronous receive context match register (see Section 4.43, <i>Isochronous Receive Context Match Register</i>) matches the 13-bit cycleCount field in the cycleStart packet, the context begins running. The effects of this bit, however, are impacted by the values of other bits in this register. Once the context has become active, hardware clears this bit. The value of this bit must not be changed while bit 10 (active) or bit 15 (run) is set to 1.
28	multiChanMode	RSC	When bit 28 is set to 1, the corresponding isochronous receive DMA context receives packets for all isochronous channels enabled in the isochronous receive channel mask high register at OHCI offset 70h/74h (see Section 4.19, <i>Isochronous Receive Channel Mask High Register</i>) and isochronous receive channel mask low register at OHCI offset 78h/7Ch (see Section 4.20, <i>Isochronous Receive Channel Mask Low Register</i>). The isochronous channel number specified in the isochronous receive context match register (see Section 4.43, <i>Isochronous Receive Context Match Register</i>) is ignored. When this bit is cleared, the isochronous receive DMA context receives packets for that single channel specified in the isochronous receive context match register (see Section 4.43). Only one isochronous receive DMA context may use the isochronous receive channel mask registers (see Sections 4.19 and 4.20). If more than one isochronous receive context control register has this bit set to 1, results are undefined. The value of this bit must not be changed while bit 10 (active) or bit 15 (run) is set to 1.
27–16	RSVD	R	Reserved. Bits 27–16 return 0s when read.
15	run	RSCU	Bit 15 is set to 1 by software to enable descriptor processing for the context and cleared by software to stop descriptor processing. The TSB12LV26 device changes this bit only on a system (hardware) or software reset.
14–13	RSVD	R	Reserved. Bits 14 and 13 return 0s when read.
12	wake	RSU	Software sets bit 12 to 1 to cause the TSB12LV26 device to continue or resume descriptor processing. The TSB12LV26 device clears this bit on every descriptor fetch.
11	dead	RU	The TSB12LV26 device sets bit 11 to 1 when it encounters a fatal error, and clears the bit when software clears bit 15 (run).
10	active	RU	The TSB12LV26 device sets bit 10 to 1 when it is processing descriptors.
9–8	RSVD	R	Reserved. Bits 9 and 8 return 0s when read.
7–5	spd	RU	This field indicates the speed at which the packet was received. 000 = 100M bits/sec 001 = 200M bits/sec 010 = 400M bits/sec All other values are reserved.
4–0	event code	RU	For bufferFill mode, possible values are: ack_complete, evt_descriptor_read, evt_data_write, and evt_unknown. Packets with data errors (either dataLength mismatches or dataCRC errors) and packets for which a FIFO overrun occurred are backed out. For packet-per-buffer mode, possible values are: ack_complete, ack_data_error, evt_long_packet, evt_overrun, evt_descriptor_read, evt_data_write, and evt_unknown.

4.42 Isochronous Receive Context Command Pointer Register

The isochronous receive context command pointer register contains a pointer to the address of the first descriptor block that the TSB12LV26 device accesses when software enables an isochronous receive context by setting bit 15 (run) in the isochronous receive context control register (see Section 4.41, *Isochronous Receive Context Control Register*) to 1. The n value in the following register addresses indicates the context number (n = 0, 1, 2, 3).

Bit	31	30	29	28	27	26	25	24	23	22	21	20	19	18	17	16
Name	Isochronous receive context command pointer															
Type	R	R	R	R	R	R	R	R	R	R	R	R	R	R	R	R
Default	X	X	X	X	X	X	X	X	X	X	X	X	X	X	X	X
Bit	15	14	13	12	11	10	9	8	7	6	5	4	3	2	1	0
Name	Isochronous receive context command pointer															
Type	R	R	R	R	R	R	R	R	R	R	R	R	R	R	R	R
Default	X	X	X	X	X	X	X	X	X	X	X	X	X	X	X	X

Register: **Isochronous receive context command pointer**

Type: Read-only

Offset: 40Ch + (32 * n)

Default: XXXX XXXXh

4.43 Isochronous Receive Context Match Register

The isochronous receive context match register starts an isochronous receive context running on a specified cycle number, filters incoming isochronous packets based on tag values, and waits for packets with a specified sync value. The n value in the following register addresses indicates the context number (n = 0, 1, 2, 3). See Table 4–32 for a complete description of the register contents.

Bit	31	30	29	28	27	26	25	24	23	22	21	20	19	18	17	16
Name	Isochronous receive context match															
Type	R/W	R/W	R/W	R/W	R	R	R	R/W	R/W	R/W	R/W	R/W	R/W	R/W	R/W	R/W
Default	X	X	X	X	0	0	0	X	X	X	X	X	X	X	X	X
Bit	15	14	13	12	11	10	9	8	7	6	5	4	3	2	1	0
Name	Isochronous receive context match															
Type	R/W	R/W	R/W	R/W	R/W	R/W	R/W	R/W	R	R/W	R/W	R/W	R/W	R/W	R/W	R/W
Default	X	X	X	X	X	X	X	X	0	X	X	X	X	X	X	X

Register: **Isochronous receive context match**
 Type: Read/Write, Read-only
 Offset: 410Ch + (32 * n)
 Default: XXXX XXXXh

Table 4–32. Isochronous Receive Context Match Register Description

BIT	FIELD NAME	TYPE	DESCRIPTION
31	tag3	R/W	If bit 31 is set to 1, this context matches on isochronous receive packets with a tag field of 11b.
30	tag2	R/W	If bit 30 is set to 1, this context matches on isochronous receive packets with a tag field of 10b.
29	tag1	R/W	If bit 29 is set to 1, this context matches on isochronous receive packets with a tag field of 01b.
28	tag0	R/W	If bit 28 is set to 1, this context matches on isochronous receive packets with a tag field of 00b.
27	RSVD	R	Reserved. Bit 27 returns 0 when read.
26–12	cycleMatch	R/W	This field contains a 15-bit value corresponding to the low-order two bits of cycleSeconds and the 13-bit cycleCount field in the cycleStart packet. If bit 29 (cycleMatchEnable) in the isochronous receive context control register (see Section 4.41, <i>Isochronous Receive Context Control Register</i>) is set to 1, this context is enabled for receives when the two low-order bits in the isochronous cycle timer register at OHCI offset F0h (see Section 4.31, <i>Isochronous Cycle Timer Register</i>) cycleSeconds field (bits 31–25) and cycleCount field (bits 24–12) value equal this field (cycleMatch) value.
11–8	sync	R/W	This 4-bit field is compared to the sync field of each isochronous packet for this channel when the command descriptor w field is set to 11b.
7	RSVD	R	Reserved. Bit 7 returns 0 when read.
6	tag1SyncFilter	R/W	If bit 6 and bit 29 (tag1) are set to 1, packets with tag 01b are accepted into the context if the two most significant bits of the packets sync field are 00b. Packets with tag values other than 01b are filtered according to bit 28 (tag0), bit 30 (tag2), and bit 31 (tag3) without any additional restrictions. If this bit is cleared, this context matches on isochronous receive packets as specified in bits 28–31 (tag0–tag3) with no additional restrictions.
5–0	channelNumber	R/W	This 6-bit field indicates the isochronous channel number for which this isochronous receive DMA context accepts packets.

5 GPIO Interface

The general-purpose input/output (GPIO) interface consists of two GPIO ports. GPIO2 and GPIO3 power up as general-purpose inputs and are programmable via the GPIO control register. Figure 5–1 shows the logic diagram for GPIO2 and GPIO3 implementation.

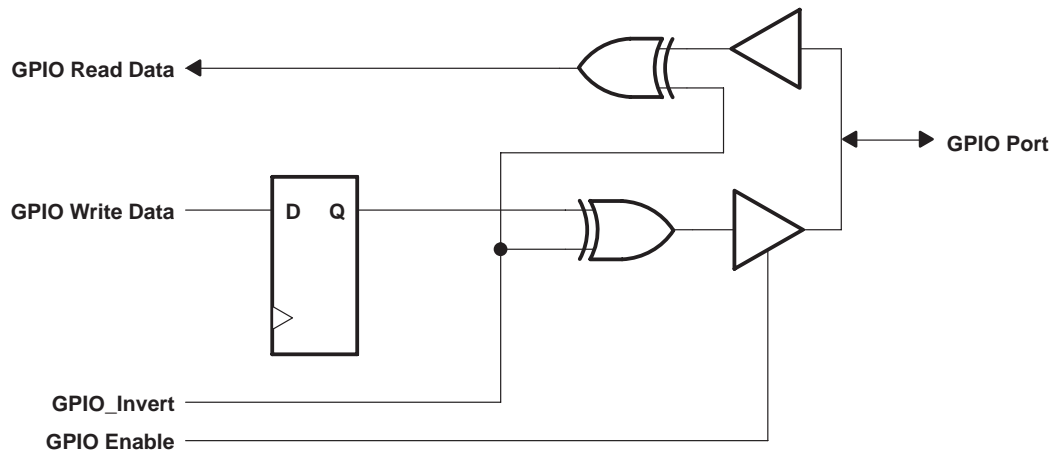

Figure 5–1. GPIO2 and GPIO3 Logic Diagram

6 Serial EEPROM Interface

The TSB12LV26 device provides a serial bus interface to initialize the 1394 global unique ID register and a few PCI configuration registers through a serial EEPROM. The TSB12LV26 device communicates with the serial EEPROM via the 2-wire serial interface.

After power up the serial interface initializes the locations listed in Table 6–1. While the TSB12LV26 device is accessing the serial EEPROM, all incoming PCI slave accesses are terminated with retry status. Table 6–2 shows the serial EEPROM memory map required for initializing the TSB12LV26 registers.

NOTE: If a ROM is implemented in the design, it must be programmed. An unprogrammed ROM defaults to all 1s, which adversely impacts device operation.

Table 6–1. Registers and Bits Loadable Through Serial EEPROM

EEPROM OFFSET	OHCI/PCI CONFIGURATION OFFSET	REGISTER	BITS LOADED FROM EEPROM
00h	PCI register (3Eh)	PCI maximum latency, PCI minimum grant	15–0
01h	PCI register (2Dh)	PCI vendor ID	15–0
03h	PCI register (2Ch)	PCI subsystem ID	15–0
05h (bit 6)	OHCI register (50h)	Host controller control	23
05h	PCI register (F4h)	Link enhancements control	7, 2, 1
06h–0Ah	OHCI register (24h)	GUID high	31–0
0Bh–0Eh	OHCI register(28h)	GUID low	31–0
10h	PCI register (F4h)	Link enhancements control	13, 12
11h–12h	PCI register (F0h)	PCI miscellaneous	15, 13, 10, 4–0
13h	PCI register (40h)	PCI OHCI	0

Table 6–2. Serial EEPROM Map

BYTE ADDRESS	BYTE DESCRIPTION							
00	PCI maximum latency (0h)				PCI minimum grant (0h)			
01	PCI vendor ID							
02	PCI vendor ID (msbyte)							
03	PCI subsystem ID (lsbyte)							
04	PCI subsystem ID							
05	[7] Link_enhancement- Control.enab_unfair	[6] HCControl. ProgramPhy Enable	[5–3] RSVD	[2] Link_enhancement- Control.enab_ insert_idle	[1] Link_enhancement- Control.enab_accel	[0] RSVD		
06	Mini ROM address							
07	GUID high (lsbyte 0)							
08	GUID high (byte 1)							
09	GUID high (byte 2)							
0A	GUID high (msbyte 3)							
0B	GUID low (lsbyte 0)							
0C	GUID low (byte 1)							
0D	GUID low (byte 2)							
0E	GUID low (msbyte 3)							
0F	Checksum							
10	[15–14] RSVD	[13–12] AT threshold	[11–8] RSVD					
11	[7–5] RSVD			[4] Disable Target Abort	[3] GP2IIC	[2] Disable SCLK gate	[1] Disable PCI gate	[0] Keep PCI
12	[15] PME D3 Cold	[14] RSVD	[13] PME Support D2	[12–11] RSVD	[10] D2 support	[9–8] RSVD		
13	[7–1] RSVD						[0] Global swap	
14	RSVD							
15–1E	RSVD							
1F	RSVD							

7 Electrical Characteristics

7.1 Absolute Maximum Ratings Over Operating Temperature Ranges†

Supply voltage range, V_{CC}	-0.5 V to 3.6 V
Supply voltage range, V_{CCP}	-0.5 V to 5.5 V
Input voltage range for PCI, V_I	-0.5 to $V_{CCP} + 0.5$ V
Input voltage range for miscellaneous and PHY interface, V_I	-0.5 to $V_{CCI} + 0.5$ V
Output voltage range for PCI, V_O	-0.5 to $V_{CCP} + 0.5$ V
Input voltage range for miscellaneous and PHY interface, V_O	-0.5 to $V_{CCP} + 0.5$ V
Input clamp current, I_{IK} ($V_I < 0$ or $V_I > V_{CC}$) (see Note 1)	± 20 mA
Output clamp current, I_{OK} ($V_O < 0$ or $V_O > V_{CC}$) (see Note 2)	± 20 mA
Operating free-air temperature range	-40°C to 110°C
Storage temperature range	-65°C to 150°C

† Stresses beyond those listed under absolute maximum ratings may cause permanent damage to the device. These are stress ratings only, and functional operation of the device at these or any other conditions beyond those indicated under recommended operating conditions is not implied. Exposure to absolute-maximum-rated conditions for extended periods may affect device reliability.

- NOTES: 1. Applies to external input and bidirectional buffers. $V_I > V_{CCP}$.
 2. Applies to external output and bidirectional buffers. $V_O > V_{CCP}$.

7.2 Recommended Operating Conditions

		OPERATION	MIN	NOM	MAX	UNIT
V _{CC}	Core voltage	3.3 V	3	3.3	3.6	V
V _{CCP}	PCI I/O clamping voltage	3.3 V	3	3.3	3.6	V
		5 V	4.5	5	5.5	
V _{IH} [†]	High-level input voltage	PCI	3.3 V	2	3.6	V
			5 V	0.475 V _{CCP}	V _{CCP}	
		PHY interface		2	3.6	
	Miscellaneous [‡]		2	V _{CCP}		
V _{IL} [†]	Low-level input voltage	PCI	3.3 V	0	0.325 V _{CCP}	V
			5 V	0	0.8	
		PHY interface		0	0.8	
		Miscellaneous [‡]		0	0.8	
V _I	Input voltage	PCI	3.3 V	0	V _{CCP}	V
		PHY interface		0	3.6	
		Miscellaneous [‡]		0	V _{CCP}	
V _O [§]	Output voltage	PCI	3.3 V	0	V _{CCP}	V
		PHY interface		0	3.6	
		Miscellaneous [‡]		0	V _{CCP}	
t _t	Input transition time (t _r and t _f)	PCI		0	6	ns
T _A	Operating ambient temperature		-40	25	110	°C

[†] Applies for external inputs and bidirectional buffers without hysteresis.

[‡] Miscellaneous terminals are: GPIO2 (2), GPIO3 (3), SDA (5), SCL (4), CYCLEOUT (77).

[§] Applies to external output buffers.

7.3 Electrical Characteristics Over Recommended Operating Conditions (unless otherwise noted)

		OPERATION	TEST CONDITIONS	MIN	MAX	UNIT
V_{OH}	High-level output voltage	PCI	$I_{OH} = -0.5 \text{ mA}$	0.9 V_{CC}		V
			$I_{OH} = -2 \text{ mA}$	2.4		
	PHY interface	$I_{OH} = -4 \mu\text{A}$	2.8			
		$I_{OH} = -8 \text{ mA}$	$V_{CC} - 0.6$			
Miscellaneous [†]	$I_{OH} = -4 \text{ mA}$	$V_{CC} - 0.6$				
V_{OL}^{\dagger}	Low-level output voltage	PCI	$I_{OL} = 1.5 \text{ mA}$	0.1 V_{CC}		V
			$I_{OL} = 6 \text{ mA}$	0	0.55	
		PHY interface	$I_{OL} = 4 \text{ mA}$	0.4		
			$I_{OL} = 8 \text{ mA}$			
Miscellaneous [†]	$I_{OL} = 4 \text{ mA}$	0.5				
I_{OZ}	3-state output high-impedance	Output pins	3.6 V	$V_O = V_{CC}$ or GND	± 20	μA
I_{IL}	Low-level input current	Input pins	3.6 V	$V_I = \text{GND}^{\dagger}$	± 20	μA
		I/O pins [†]	3.6 V	$V_I = \text{GND}^{\dagger}$	± 20	
I_{IH}	High-level input current	PCI [†]	3.6 V	$V_I = V_{CC}^{\dagger}$	± 20	μA
		Others [†]	3.6 V	$V_I = V_{CC}^{\dagger}$	± 20	

[†] For I/O terminals, input leakage (I_{IL} and I_{IH}) includes I_{OZ} of the disabled output.

[‡] Miscellaneous terminals are: GPIO2 (2), GPIO3 (3), SDA (5), SCL (4), CYCLEOUT (77).

7.4 Switching Characteristics for PCI Interface[§]

PARAMETER		MEASURED	MIN	MAX	UNIT
t_{su}	Setup time before PCLK	-50% to 50%	7		ns
t_h	Hold time before PCLK	-50% to 50%	0		ns
t_{val}	Delay time, PHY_CLK to data valid	-50% to 50%	2	11	ns

[§] These parameters are ensured by design.

7.5 Switching Characteristics for PHY-Link Interface[§]

PARAMETER		MEASURED	MIN	MAX	UNIT
t_{su}	Setup time, Dn, CTLn, LREQ to PHY_CLK	-50% to 50%	6		ns
t_h	Hold time, Dn, CTLn, LREQ before PHY_CLK	-50% to 50%	0		ns
t_d	Delay time, PHY_CLK to Dn, CTLn	-50% to 50%	2	11	ns

[§] These parameters are ensured by design.

PACKAGING INFORMATION

Orderable part number	Status (1)	Material type (2)	Package Pins	Package qty Carrier	RoHS (3)	Lead finish/ Ball material (4)	MSL rating/ Peak reflow (5)	Op temp (°C)	Part marking (6)
TSB12LV26TPZEP	Active	Production	LQFP (PZ) 100	90 JEDEC TRAY (10+1)	Yes	NIPDAU	Level-3-260C-168 HR	-40 to 105	TSB12LV26TEP
TSB12LV26TPZEP.A	Active	Production	LQFP (PZ) 100	90 JEDEC TRAY (10+1)	Yes	NIPDAU	Level-3-260C-168 HR	-40 to 105	TSB12LV26TEP
V62/03627-01XE	Active	Production	LQFP (PZ) 100	90 JEDEC TRAY (10+1)	Yes	NIPDAU	Level-3-260C-168 HR	-40 to 105	TSB12LV26TEP

(1) **Status:** For more details on status, see our [product life cycle](#).

(2) **Material type:** When designated, preproduction parts are prototypes/experimental devices, and are not yet approved or released for full production. Testing and final process, including without limitation quality assurance, reliability performance testing, and/or process qualification, may not yet be complete, and this item is subject to further changes or possible discontinuation. If available for ordering, purchases will be subject to an additional waiver at checkout, and are intended for early internal evaluation purposes only. These items are sold without warranties of any kind.

(3) **RoHS values:** Yes, No, RoHS Exempt. See the [TI RoHS Statement](#) for additional information and value definition.

(4) **Lead finish/Ball material:** Parts may have multiple material finish options. Finish options are separated by a vertical ruled line. Lead finish/Ball material values may wrap to two lines if the finish value exceeds the maximum column width.

(5) **MSL rating/Peak reflow:** The moisture sensitivity level ratings and peak solder (reflow) temperatures. In the event that a part has multiple moisture sensitivity ratings, only the lowest level per JEDEC standards is shown. Refer to the shipping label for the actual reflow temperature that will be used to mount the part to the printed circuit board.

(6) **Part marking:** There may be an additional marking, which relates to the logo, the lot trace code information, or the environmental category of the part.

Multiple part markings will be inside parentheses. Only one part marking contained in parentheses and separated by a "~" will appear on a part. If a line is indented then it is a continuation of the previous line and the two combined represent the entire part marking for that device.

Important Information and Disclaimer: The information provided on this page represents TI's knowledge and belief as of the date that it is provided. TI bases its knowledge and belief on information provided by third parties, and makes no representation or warranty as to the accuracy of such information. Efforts are underway to better integrate information from third parties. TI has taken and continues to take reasonable steps to provide representative and accurate information but may not have conducted destructive testing or chemical analysis on incoming materials and chemicals. TI and TI suppliers consider certain information to be proprietary, and thus CAS numbers and other limited information may not be available for release.

In no event shall TI's liability arising out of such information exceed the total purchase price of the TI part(s) at issue in this document sold by TI to Customer on an annual basis.

OTHER QUALIFIED VERSIONS OF TSB12LV26-EP :

- Catalog : [TSB12LV26](#)

NOTE: Qualified Version Definitions:

- Catalog - TI's standard catalog product

TRAY

Chamfer on Tray corner indicates Pin 1 orientation of packed units.

*All dimensions are nominal

Device	Package Name	Package Type	Pins	SPQ	Unit array matrix	Max temperature (°C)	L (mm)	W (mm)	K0 (µm)	P1 (mm)	CL (mm)	CW (mm)
TSB12LV26TPZEP	PZ	LQFP	100	90	6 x 15	150	315	135.9	7620	20.3	15.4	15.45
TSB12LV26TPZEP.A	PZ	LQFP	100	90	6 x 15	150	315	135.9	7620	20.3	15.4	15.45
V62/03627-01XE	PZ	LQFP	100	90	6 x 15	150	315	135.9	7620	20.3	15.4	15.45

PZ0100A

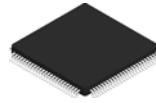

PACKAGE OUTLINE

LQFP - 1.6 mm max height

PLASTIC QUAD FLATPACK

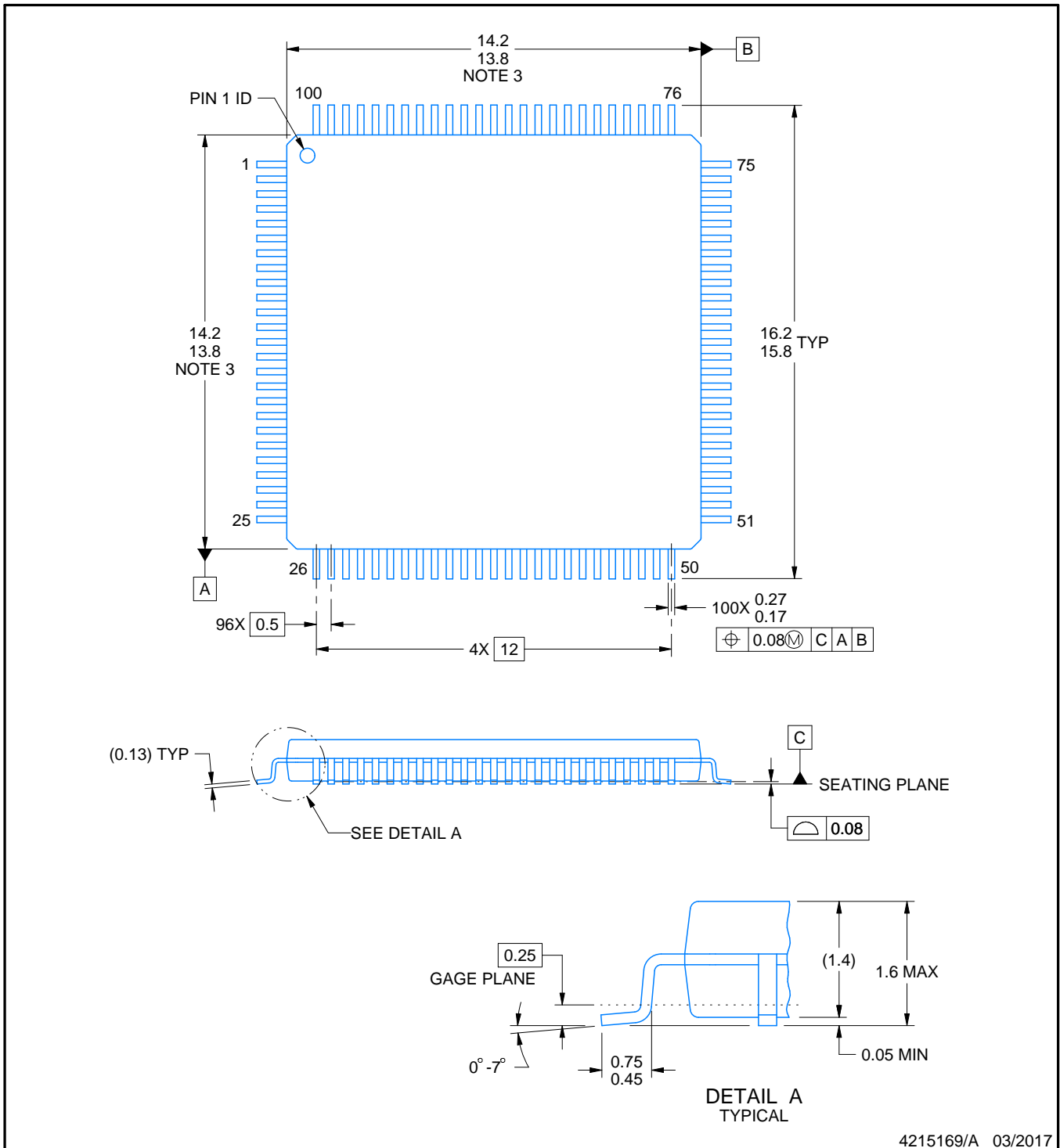

4215169/A 03/2017

NOTES:

1. All linear dimensions are in millimeters. Any dimensions in parenthesis are for reference only. Dimensioning and tolerancing per ASME Y14.5M.
2. This drawing is subject to change without notice.
3. This dimension does not include mold flash, protrusions, or gate burrs. Mold flash, protrusions, or gate burrs shall not exceed 0.15 mm per side.
4. Reference JEDEC registration MS-026.

EXAMPLE BOARD LAYOUT

PZ0100A

LQFP - 1.6 mm max height

PLASTIC QUAD FLATPACK

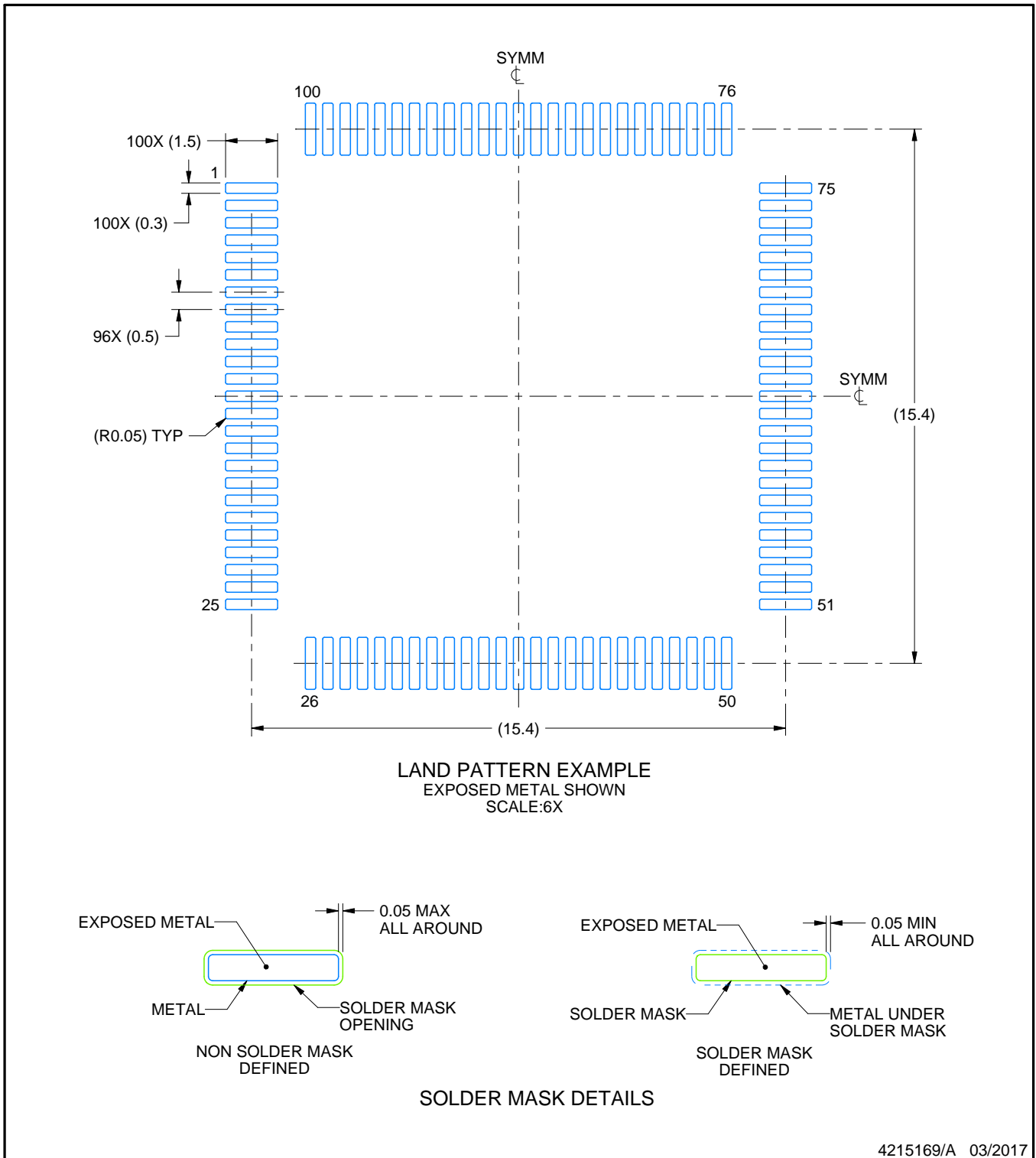

NOTES: (continued)

5. Publication IPC-7351 may have alternate designs.
6. Solder mask tolerances between and around signal pads can vary based on board fabrication site.
7. For more information, see Texas Instruments literature number SLMA004 (www.ti.com/lit/slma004).

EXAMPLE STENCIL DESIGN

PZ0100A

LQFP - 1.6 mm max height

PLASTIC QUAD FLATPACK

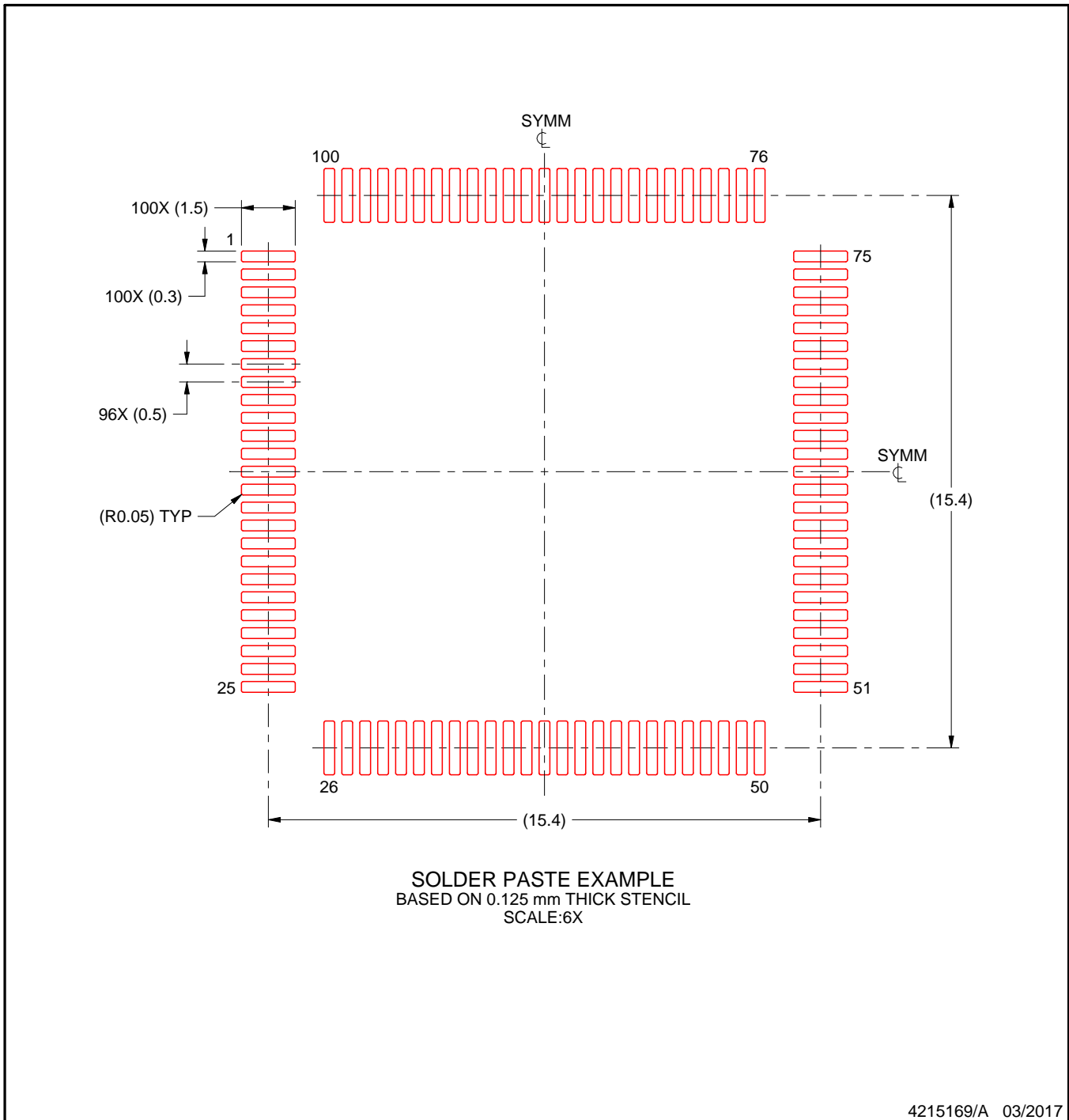

NOTES: (continued)

8. Laser cutting apertures with trapezoidal walls and rounded corners may offer better paste release. IPC-7525 may have alternate design recommendations.
9. Board assembly site may have different recommendations for stencil design.

IMPORTANT NOTICE AND DISCLAIMER

TI PROVIDES TECHNICAL AND RELIABILITY DATA (INCLUDING DATASHEETS), DESIGN RESOURCES (INCLUDING REFERENCE DESIGNS), APPLICATION OR OTHER DESIGN ADVICE, WEB TOOLS, SAFETY INFORMATION, AND OTHER RESOURCES "AS IS" AND WITH ALL FAULTS, AND DISCLAIMS ALL WARRANTIES, EXPRESS AND IMPLIED, INCLUDING WITHOUT LIMITATION ANY IMPLIED WARRANTIES OF MERCHANTABILITY, FITNESS FOR A PARTICULAR PURPOSE OR NON-INFRINGEMENT OF THIRD PARTY INTELLECTUAL PROPERTY RIGHTS.

These resources are intended for skilled developers designing with TI products. You are solely responsible for (1) selecting the appropriate TI products for your application, (2) designing, validating and testing your application, and (3) ensuring your application meets applicable standards, and any other safety, security, regulatory or other requirements.

These resources are subject to change without notice. TI grants you permission to use these resources only for development of an application that uses the TI products described in the resource. Other reproduction and display of these resources is prohibited. No license is granted to any other TI intellectual property right or to any third party intellectual property right. TI disclaims responsibility for, and you fully indemnify TI and its representatives against any claims, damages, costs, losses, and liabilities arising out of your use of these resources.

TI's products are provided subject to [TI's Terms of Sale](#), [TI's General Quality Guidelines](#), or other applicable terms available either on [ti.com](#) or provided in conjunction with such TI products. TI's provision of these resources does not expand or otherwise alter TI's applicable warranties or warranty disclaimers for TI products. Unless TI explicitly designates a product as custom or customer-specified, TI products are standard, catalog, general purpose devices.

TI objects to and rejects any additional or different terms you may propose.

Copyright © 2025, Texas Instruments Incorporated

Last updated 10/2025