

TPS61322 6.5 μ A 静态电流、1.8A 开关电流升压转换器

1 特性

- 工作输入电压范围：0.9V 至 5.5V
- 输出电压范围：1.8V 至 5.5V
- VOUT 引脚静态电流为 6.5 μ A
- 温度范围内输出电压精度为 $\pm 3\%$
- 最小开关峰值电流限制：
 - TPS613223A 为 0.42A
 - TPS61322 为 0.5 A
 - TPS613221A 和 TPS613226A 为 0.75A
 - TPS613222A 为 1.10A
- 10mA 负载条件下进行 1.5V 至 2.2V 转换时效率高于 90%
- 热关断保护
- 2.9mm \times 1.3mm 3 引脚 SOT 封装和 2.9mm \times 1.6mm 5 引脚 SOT 封装
- 使用 TPS61322 并借助 [WEBENCH® Power Designer](#) 创建定制设计

2 应用

- 1 至 3 节碱性电池或镍氢电池供电型应用
- 游戏控制
- 平板电脑
- 便携式电子产品
- 医疗设备

3 说明

TPS61322 是一款具有仅 6.5 μ A 静态电流的同步升压转换器。TPS61322 可以为由碱性电池、镍氢可再充电电池或单节锂离子电池供电的产品提供电源解决方案。该升压转换器建立在采用同步整流的迟滞控制拓扑基础之上，能够以最小静态电流实现最高的效率。TPS61322 也支持使用小型外部电感器和电容器。10mA 负载条件下进行 1.5V 输入至 2.2V 输出转换时效率高于 90%。

TPS61322 还可以通过外部肖特基二极管支持高输出电流应用。利用与内部整流器 FET 并联的外部肖特基二极管，TPS61322A 可以在进行 3V 输入电压至 5V 输出电压转换时提供高于 500mA 的输出电流能力。

可以在内部将输出电压设置为 1.8V 至 5.5V 范围内的某个固定输出（单位增量为 0.1V）。因此，仅需两个外部组件即可实现所需的输出电压。TPS61322 还具有热关断保护功能。

TPS61322 采用 2.9mm \times 1.3mm 3 引脚 SOT 封装或 2.9mm \times 1.6mm 5 引脚 SOT 封装。

器件信息(1)

| 器件型号 | 封装 | 封装尺寸 (标称值) |
|----------|------------|-----------------|
| TPS61322 | SOT-23 (3) | 2.90mm x 1.30mm |
| | SOT-23 (5) | 2.90mm x 1.60mm |

(1) 如需了解所有可用封装，请参阅数据表末尾的可订购产品附录。

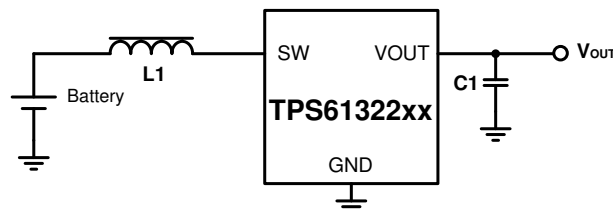

典型应用电路



Table of Contents

| | | | |
|--|-----------|--|-----------|
| 1 特性 | 1 | 8.1 Application Information..... | 11 |
| 2 应用 | 1 | 8.2 Typical Application..... | 11 |
| 3 说明 | 1 | 8.3 System Examples..... | 21 |
| 4 Device Comparison Table | 3 | 9 Power Supply Recommendations | 22 |
| 5 Pin Configuration and Functions | 3 | 10 Layout | 23 |
| Pin Functions..... | 3 | 10.1 Layout Guidelines..... | 23 |
| 6 Specifications | 4 | 10.2 Layout Examples..... | 24 |
| 6.1 Absolute Maximum Ratings..... | 4 | 11 Device and Documentation Support | 25 |
| 6.2 ESD Ratings..... | 4 | 11.1 Device Support..... | 25 |
| 6.3 Recommended Operating Conditions..... | 4 | 11.2 Documentation Support..... | 25 |
| 6.4 Thermal Information..... | 4 | 11.3 Receiving Notification of Documentation Updates.. | 25 |
| 6.5 Electrical Characteristics..... | 5 | 11.4 支持资源..... | 25 |
| 6.6 Typical Characteristics..... | 6 | 11.5 Trademarks..... | 25 |
| 7 Detailed Description | 9 | 11.6 静电放电警告..... | 25 |
| 7.1 Overview..... | 9 | 11.7 术语表..... | 26 |
| 7.2 Functional Block Diagram..... | 9 | 12 Revision History | 26 |
| 7.3 Feature Description..... | 9 | 13 Mechanical, Packaging, and Orderable Information | 26 |
| 8 Application and Implementation | 11 | | |

4 Device Comparison Table

| PART NUMBER | OUTPUT VOLTAGE | TYPICAL CURRENT LIMIT |
|---------------------------|----------------|-----------------------|
| TPS61322 | 2.2 V | 0.75A |
| TPS613221A | 3.3 V | 1.2 A |
| TPS613222A | 5 V | 1.8 A |
| TPS613223A | 2 V | 0.75 A |
| TPS613224A ⁽¹⁾ | 2.5 V | 0.75 A |
| TPS613225A ⁽¹⁾ | 3 V | 1.2 A |
| TPS613226A | 3.6 V | 1.2 A |

(1) Product Preview. Contact TI factory for more information.

5 Pin Configuration and Functions



图 5-1. DBZ Package 3-Pin SOT Top View



图 5-2. DBV Package 5-Pin SOT Top View

Pin Functions

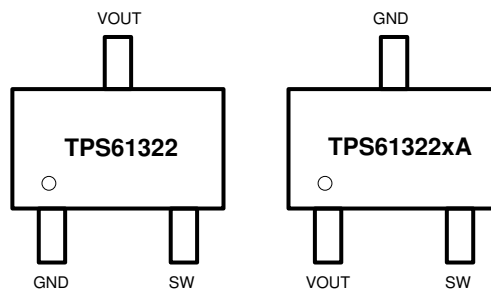
| PIN | | | NAME | TYPE | DESCRIPTION |
|----------|------------|-----|------|------|---|
| TPS61322 | TPS61322xA | DBV | | | |
| 1 | 3 | 2 | GND | PWR | Ground of the IC. |
| 2 | 2 | 1 | SW | PWR | The switch pin of the converter. It is connected to the inductor. |
| 3 | 1 | 4 | VOUT | PWR | Boost converter output. |
| - | - | 3 | NC | - | No connection inside the device. |
| - | - | 5 | NC | - | No connection inside the device. |

6 Specifications

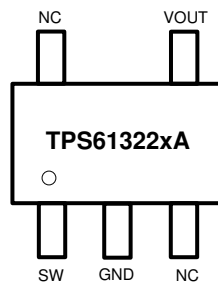
6.1 Absolute Maximum Ratings

over operating free-air temperature range (unless otherwise noted)⁽¹⁾

| | MIN | MAX | UNIT |
|--|-------|-----|------|
| Voltage range at terminals ⁽²⁾ SW, VOUT | - 0.3 | 6.0 | V |
| Operating Junction Temperature, T _J | - 40 | 150 | °C |
| Storage Temperature, T _{stg} | - 65 | 150 | °C |

(1) Stresses beyond those listed under *Absolute Maximum Ratings* may cause permanent damage to the device. These are stress ratings only, which do not imply functional operation of the device at these or any other conditions beyond those indicated under *Recommended Operating Conditions*. Exposure to absolute-maximum-rated conditions for extended periods may affect device reliability.

(2) All voltage values are with respect to network ground terminal.

6.2 ESD Ratings

| | | VALUE | UNIT |
|--|--|-------|------|
| V _(ESD) Electrostatic discharge | Human-body model (HBM), per ANSI/ESDA/JEDEC JS-001 ⁽¹⁾ | ±2000 | V |
| | Charged-device model (CDM), per JEDEC specification JESD22-C101 ⁽²⁾ | ±500 | |

(1) JEDEC document JEP155 states that 500-V HBM allows safe manufacturing with a standard ESD control process.

(2) JEDEC document JEP157 states that 250-V CDM allows safe manufacturing with a standard ESD control process.

6.3 Recommended Operating Conditions

over operating free-air temperature range (unless otherwise noted)

| | MIN | NOM | MAX | UNIT |
|---|-----|-----|-----|------|
| V _{IN} Input voltage range | 0.9 | | 5.5 | V |
| V _{OUT} Output voltage range | 1.8 | | 5.5 | V |
| L Inductor (effective) | 0.7 | 2.2 | 13 | μH |
| C _{OUT} Output capacitor (effective) | 4.7 | 16 | 100 | μF |
| T _J Operating junction temperature | -40 | | 125 | °C |

6.4 Thermal Information

| THERMAL METRIC ⁽¹⁾ | TPS61322 | | UNIT |
|--|--------------|--------------|------|
| | DBZ (SOT-23) | DBV (SOT-23) | |
| | 3-PIN | 5-PIN | |
| R _{θJA} Junction-to-ambient thermal resistance | 322.2 | 189.7 | °C/W |
| R _{θJC(top)} Junction-to-case (top) thermal resistance | 107.0 | 109.4 | °C/W |
| R _{θJB} Junction-to-board thermal resistance | 65.8 | 56.5 | °C/W |
| ψ _{JT} Junction-to-top characterization parameter | 7.5 | 33.3 | °C/W |
| ψ _{JB} Junction-to-board characterization parameter | 64.5 | 56.5 | °C/W |
| R _{θJC(bot)} Junction-to-case (bottom) thermal resistance | N/A | N/A | °C/W |

(1) For more information about traditional and new thermal metrics, see the [Semiconductor and IC Package Thermal Metrics](#) application report.

6.5 Electrical Characteristics

$T_J = -40^{\circ}\text{C}$ to $+125^{\circ}\text{C}$ and $V_{IN} = 0.9\text{ V}$ to 5.5 V . Typical values are at $V_{IN} = 1.2\text{ V}$, $T_J = 25^{\circ}\text{C}$, unless otherwise noted

| PARAMETER | | TEST CONDITIONS | MIN | TYP | MAX | UNIT | |
|---------------------|---|---|---|-------|------|--------------------|---|
| POWER SUPPLY | | | | | | | |
| V_{IN} | Input voltage range | | 0.9 | | 5.5 | V | |
| V_{VOUT_START} | Minimum voltage for startup at VOUT pin | $R_{Load} \geq 250\Omega$, $T_J = -40^{\circ}\text{C}$ to 85°C | | 0.83 | 0.87 | V | |
| I_Q | Quiescent current into VOUT pin | $V_{OUT} = 1.2 \times \text{Target}$ | | 6.5 | 10 | μA | |
| OUTPUT | | | | | | | |
| V_{OUT} | | TPS61322 | $V_{IN} < V_{OUT}$, $T_J = -40^{\circ}\text{C}$ to 125°C | 2.134 | 2.2 | 2.266 | V |
| | | TPS613221A | $V_{IN} < V_{OUT}$, $T_J = -40^{\circ}\text{C}$ to 125°C | 3.2 | 3.3 | 3.4 | V |
| | | TPS613222A | $V_{IN} < V_{OUT}$, $T_J = -40^{\circ}\text{C}$ to 125°C | 4.85 | 5.0 | 5.15 | V |
| | | TPS613223A | $V_{IN} < V_{OUT}$, $T_J = -40^{\circ}\text{C}$ to 125°C | 1.94 | 2.0 | 2.06 | V |
| | | TPS613226A | $V_{IN} < V_{OUT}$, $T_J = -40^{\circ}\text{C}$ to 125°C | 3.49 | 3.6 | 3.71 | V |
| I_{SW_LKG} | Leakage current into SW pin | $V_{SW} = V_{OUT} = 1.2 \times \text{Target}$ | | 3.5 | | nA | |
| POWER SWITCH | | | | | | | |
| $R_{DS(on)_LS}$ | Low side switch on resistance | TPS61322 | | 300 | | $\text{m}\Omega$ | |
| | | TPS613221A | | 200 | | $\text{m}\Omega$ | |
| | | TPS613222A | | 150 | | $\text{m}\Omega$ | |
| | | TPS613223A | | 400 | | $\text{m}\Omega$ | |
| | | TPS613226A | | 190 | | $\text{m}\Omega$ | |
| $R_{DS(on)_HS}$ | High side switch on resistance | TPS61322 | | 1300 | | $\text{m}\Omega$ | |
| | | TPS613221A | | 1000 | | $\text{m}\Omega$ | |
| | | TPS613222A | | 750 | | $\text{m}\Omega$ | |
| | | TPS613223A | | 1680 | | $\text{m}\Omega$ | |
| | | TPS613226A | | 950 | | $\text{m}\Omega$ | |
| I_{LIM} | Peak switch current limit | TPS61322 | | 0.50 | 0.75 | 1.20 | A |
| | | TPS613221A | | 0.75 | 1.20 | 1.60 | A |
| | | TPS613222A | | 1.10 | 1.80 | 2.50 | A |
| | | TPS613223A | | 0.42 | 0.75 | 1.2 | A |
| | | TPS613226A | | 0.75 | 1.20 | 1.60 | A |
| Protection | | | | | | | |
| T_{SD} | Over-temperature protection | T_J rising | | 150 | | $^{\circ}\text{C}$ | |
| T_{SD_HYS} | Over-temperature protection hysteresis | | | 20 | | $^{\circ}\text{C}$ | |

6.6 Typical Characteristics

T_J = 25°C unless otherwise noted.



图 6-1. Load Efficiency with Different Inputs



图 6-2. Load Regulation

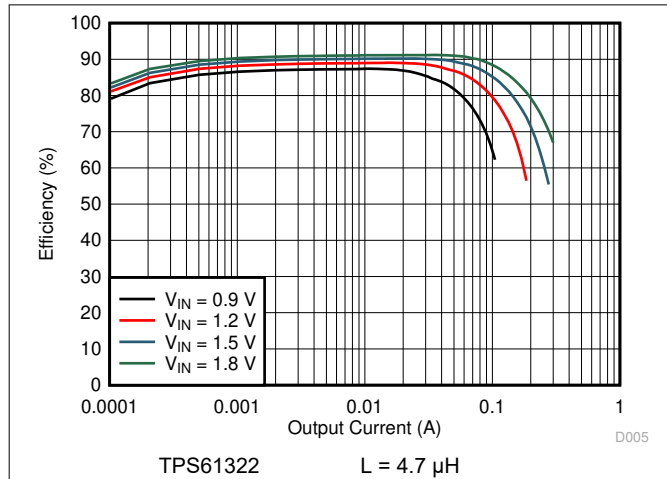

图 6-3. Load Efficiency with Different Inputs

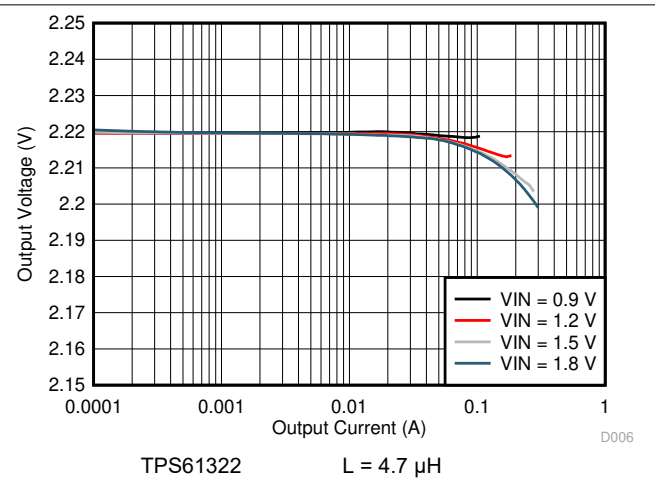

图 6-4. Load Regulation

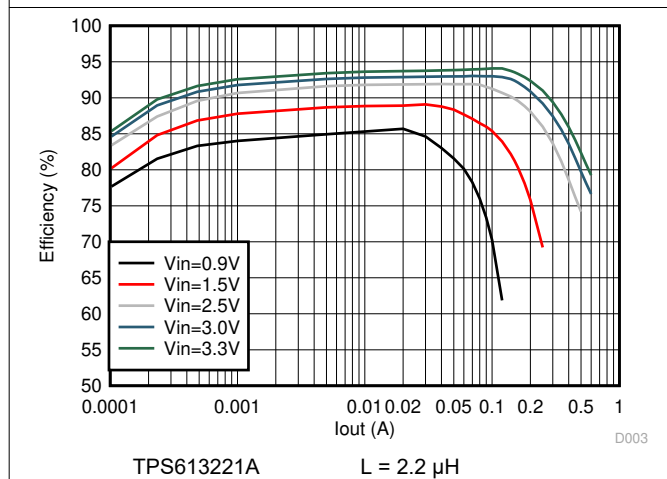

图 6-5. Load Efficiency with Different Inputs

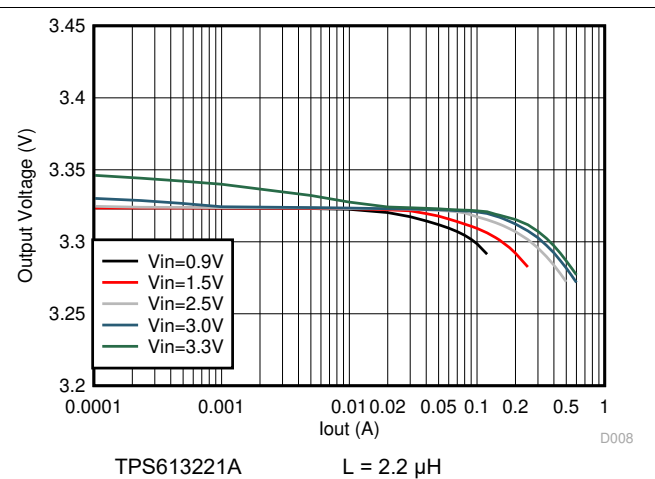

图 6-6. Load Regulation

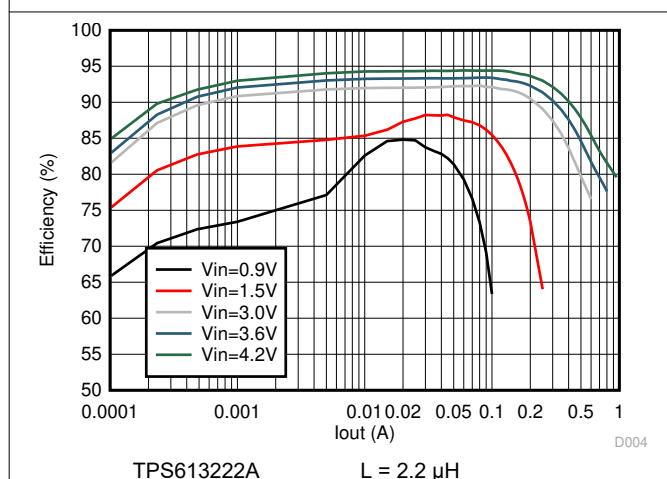

图 6-7. Load Efficiency with Different Inputs

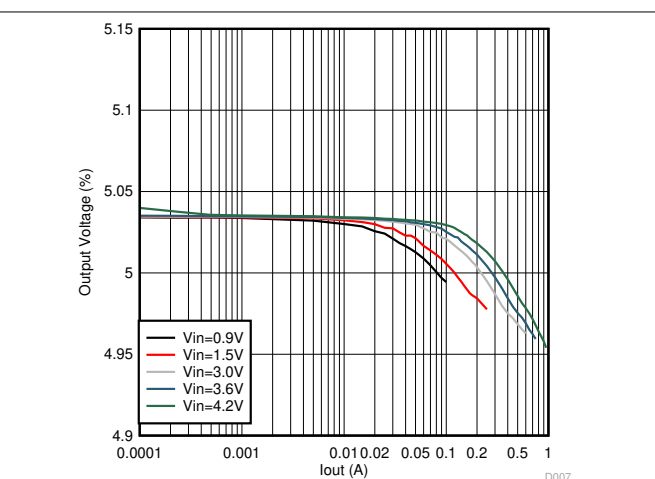

图 6-8. Load Regulation

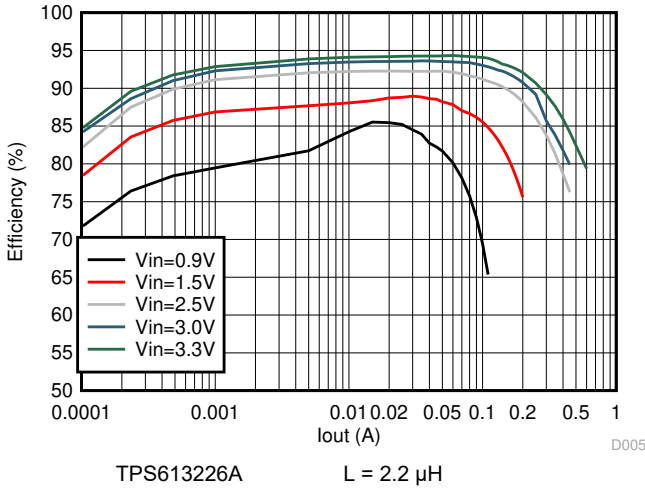

图 6-9. Load Efficiency with Different Inputs

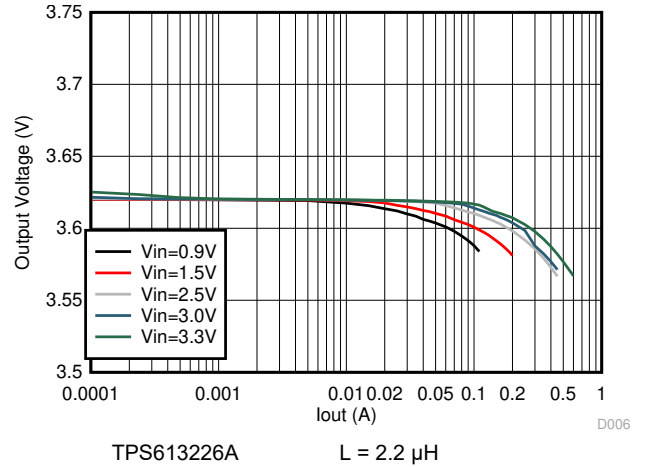

图 6-10. Load Regulation

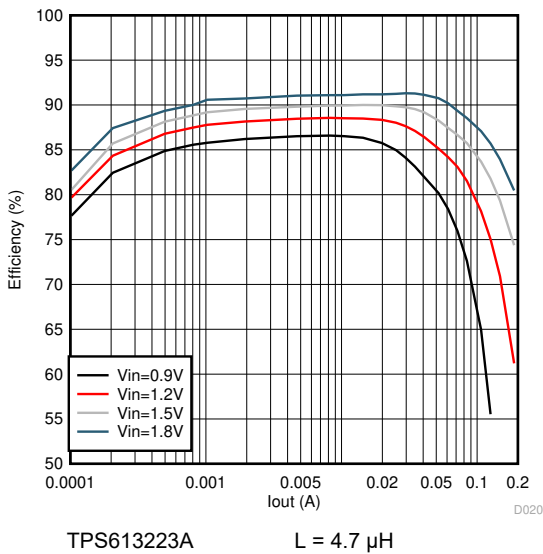

图 6-11. Current Limit with Different Temperature

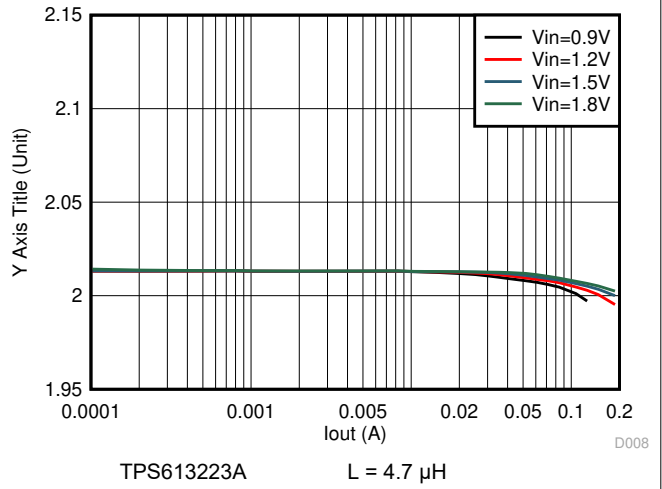

图 6-12. Current Limit with Different Temperature

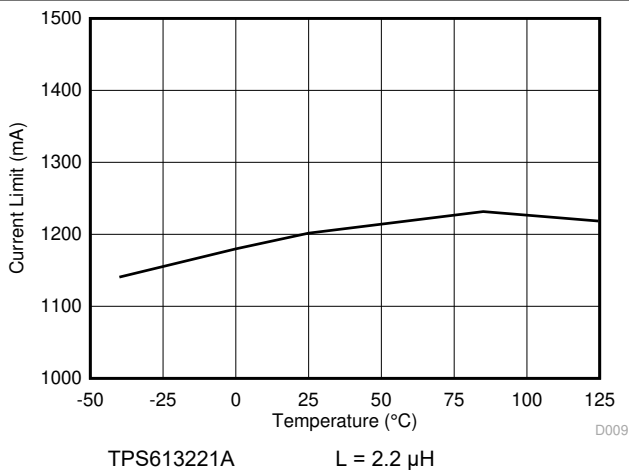

7 Detailed Description

7.1 Overview

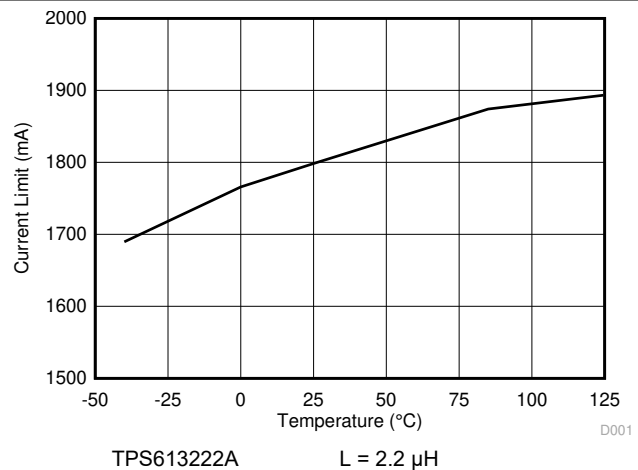
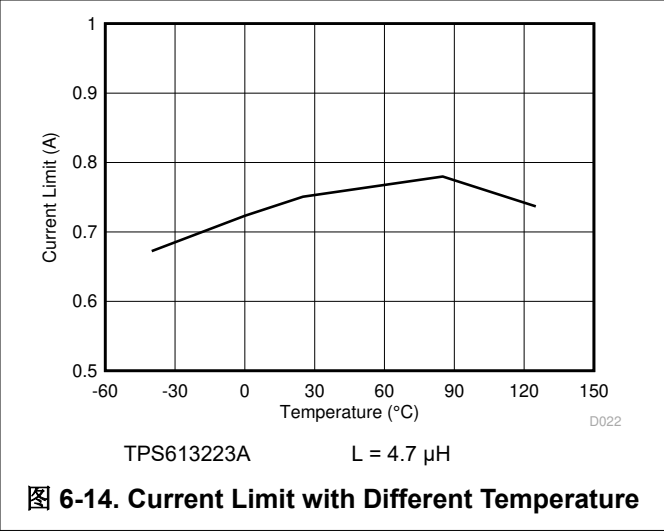
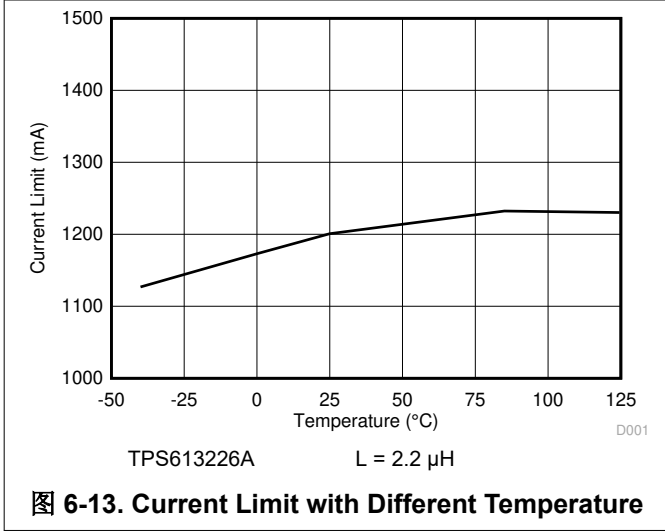
The TPS61322xx is a low quiescent current, high efficiency synchronous boost converter. The TPS61322xx uses hysteretic current control scheme. The TPS61322xx is designed for systems powered by alkaline battery, NiMH rechargeable battery, Li-ion battery or Li-polymer battery. The input voltage range is from 0.9 V to 5.5 V. After start-up is completed, the TPS61322xx can work with the input voltage down to 0.4 V. The TPS61322xx consumes only 6.5- μ A quiescent current and achieves high efficiency under light load conditions. The TPS61322xx is designed as an always-on power. Higher than 90% efficiency is achieved under 10-mA load from 1.5-V input voltage to 2.2-V output voltage conversion to extend battery lifetime. The TPS61322A can support as high as 500-mA output current from 3-V input voltage to 5-V output voltage conversion with an external schottky diode in parallel with internal high-side MOSFET.

7.2 Functional Block Diagram

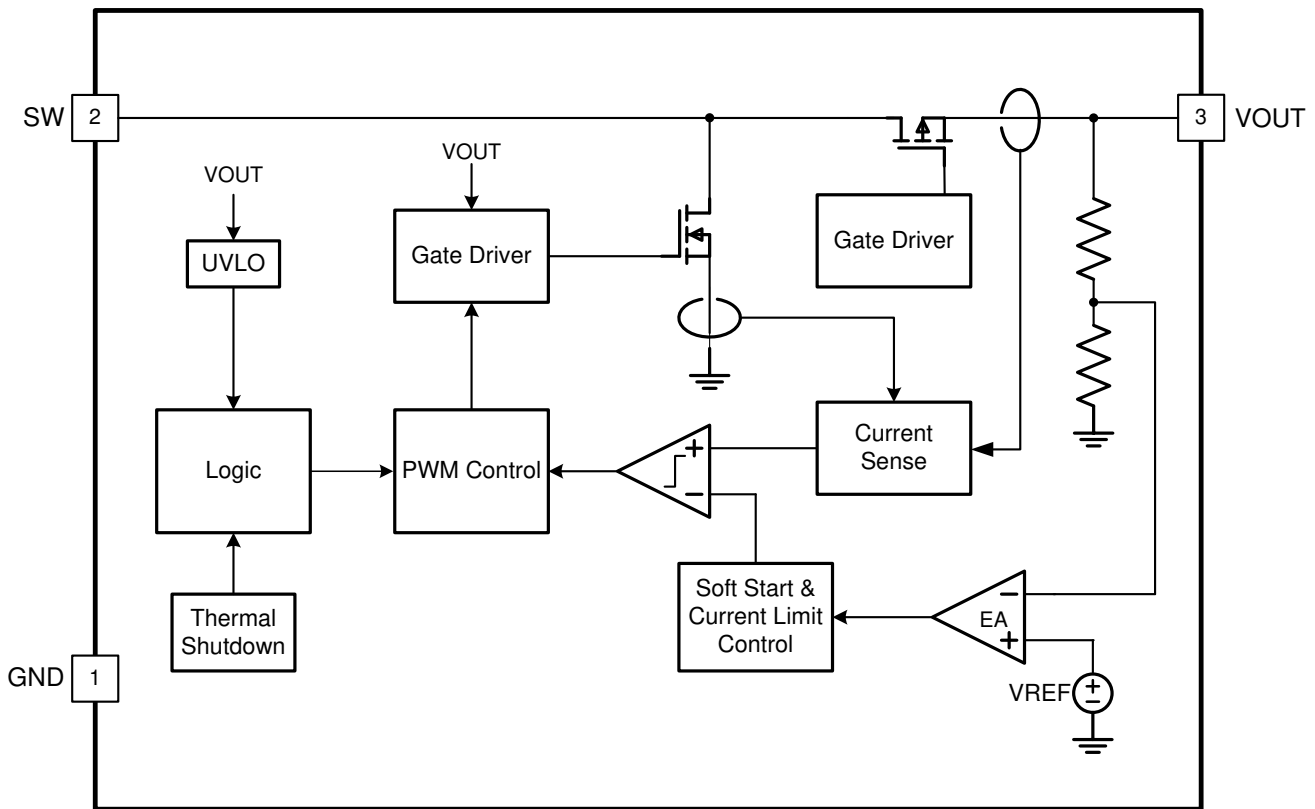

Copyright © 2017, Texas Instruments Incorporated

7.3 Feature Description

7.3.1 Soft Start

When the input voltage is applied, the high side MOSFET is turned on. The input voltage charges the output capacitors through the inductor and the high side MOSFET. When the output capacitors are charged to 0.83-V typical value, the TPS61322xx starts switching at 1.6-MHz fixed frequency and the high-side MOSFET is turned off. When the output voltage goes up to typical 1.6 V, an internal soft-start control circuit ramps the reference voltage to 0.8 V within 2 ms. In this way, the soft-start function reduces the input inrush current. After the output voltage reaches the target value, soft start ends, and the inductor peak current is determined by the output of an internal error amplifier. After start-up, the TPS61322xx can work with the input voltage down to 0.4 V.

7.3.2 Boost Controller Circuit

The TPS61322xx boost converter is controlled by a hysteretic current mode scheme. The TPS61322xx regulates the output voltage by keeping the inductor ripple constant of 200-mA typical value and adjusting the offset of this inductor current depending on the output load. If the required average input current is lower than average inductor current defined by this constant ripple current, the inductor current becomes discontinuous to keep the efficiency high under light load conditions. 图 7-1 illustrates the hysteretic current operation.

The output voltage V_{OUT} is monitored via the internal feedback network connected to a voltage error amplifier. To regulate the output voltage, the voltage error amplifier compares this feedback voltage to the internal voltage reference and adjusts the required offset of the inductor current accordingly.



图 7-1. Hysteretic Current Operation

7.3.3

The TPS61322xx boost converter can increase the output load capacity by connecting an external schottky diode from SW pin to VOUT pin. Higher than 500 mA output current is supported for 5-V output voltage applications such as USB OTG and HDMI power supply. For such applications, an adaptive constant off time circuit will generate the signal to turn off high-side FET. The inductor current ripple is greater than 200 mA if with this external diode. A higher inductance can help reduce the inductor current ripple.

7.3.4 Undervoltage Lockout

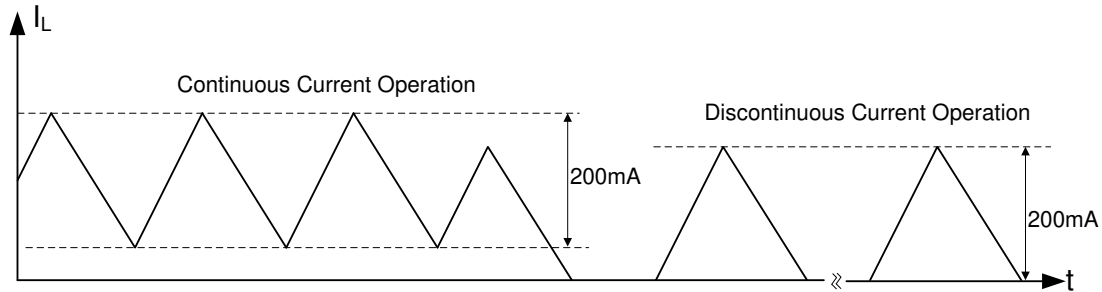
An undervoltage lockout function stops operation of the converter if the input voltage drops below the typical undervoltage lockout threshold of 0.4 V while the output voltage is still higher than 1.8 V. A hysteresis of 100 mV is added so that the device does not switch again until the input voltage goes up to 0.5 V.

7.3.5 Current Limit Operation

The TPS61322xx employs cycle-by-cycle peak current limit operation. If the inductor peak current hits the peak current limit I_{LIM} , the low-side MOSFET is turned off and stops the further increase of the inductor current. In this case the output voltage drops until power balance between the input side and output side is achieved. If the output voltage drops below the input voltage, the inductor current will be clamped by the DCR of the inductor and the on-resistance ($R_{ds,on}$) of the high-side MOSFET.

7.3.6 Overtemperature Protection

The TPS61322xx has a built-in temperature sensor which monitors the internal junction temperature in boost mode operation. If the junction temperature exceeds the threshold 150°C, the device stops operating. As soon as the junction temperature drops below the shutdown temperature minus the hysteresis, typically 130°C, the device starts operating again.

7.3.7 Device Functional Modes

- 节 7.3.2 - Continuous and discontinuous current operation
- Protective mechanisms
 - 节 7.3.5
 - 节 7.3.4
 - 节 7.3.6

8 Application and Implementation

备注

以下应用部分中的信息不属于 TI 器件规格的范围，TI 不担保其准确性和完整性。TI 的客户应负责确定器件是否适用于其应用。客户应验证并测试其设计，以确保系统功能。

8.1 Application Information

The TPS61322xx is designed to operate at a wide input voltage range from 0.9-V to 5.5-V. The minimum peak switch current limit is 0.5 A for TPS61322, with 0.75 A for TPS613221A and 1.1 A for TPS613222A. The TPS61322xx supports output voltage from 1.8 V to 5.5 V with increment of 0.1 V, refer to [节 4](#) for device details to select the right device for the target applications. Use the following design procedure to select component values for the TPS61322xx.

8.2 Typical Application

8.2.1 Boost without Schottky Diode

A typical application example is the wireless mouse, which normally requires 2.2-V voltage as its supply voltage and consumes less than 50-mA current from one-cell alkaline battery. The following design procedure can be used to select external component values for TPS61322xx.

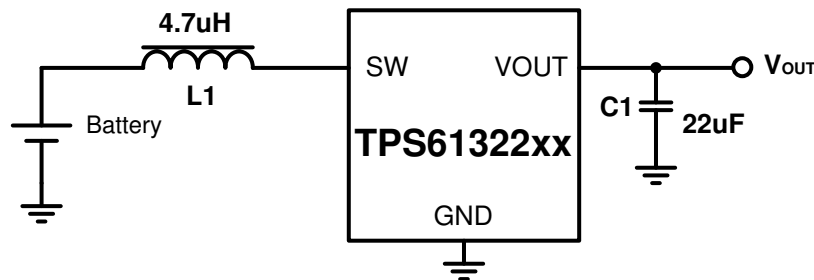

Copyright © 2017, Texas Instruments Incorporated

图 8-1. Typical Application Circuit without Schottky Diode

8.2.1.1 Design Requirements

表 8-1. Design Requirements

| PARAMETERS | VALUES |
|-----------------------|----------------|
| Input voltage | 0.9 V to 1.6 V |
| Output voltage | 2.2 V |
| Output current | 50 mA |
| Output voltage ripple | ±10 mV |

8.2.1.2 Detailed Design Procedure

8.2.1.2.1 Custom Design With WEBENCH® Tools

[Click here](#) to create a custom design using the TPS61322 device with the WEBENCH® Power Designer.

1. Start by entering the input voltage (V_{IN}), output voltage (V_{OUT}), and output current (I_{OUT}) requirements.
2. Optimize the design for key parameters such as efficiency, footprint, and cost using the optimizer dial.
3. Compare the generated design with other possible solutions from Texas Instruments.

The WEBENCH Power Designer provides a customized schematic along with a list of materials with real-time pricing and component availability.

In most cases, these actions are available:

- Run electrical simulations to see important waveforms and circuit performance
- Run thermal simulations to understand board thermal performance
- Export customized schematic and layout into popular CAD formats
- Print PDF reports for the design, and share the design with colleagues

Get more information about WEBENCH tools at www.ti.com/WEBENCH.

8.2.1.2.2 Maximum Output Current

For boost converters, the maximum output current capability is determined by the input to output ratio, the efficiency, the inductor current ripple and the current limit. The maximum output current can be estimated by [方程式 1](#)

$$I_{OUT (max)} = \frac{V_{IN} \times (I_{LIM} - \frac{I_{LH}}{2}) \times \eta}{V_{OUT}} \quad (1)$$

where

- I_{LIM} is the peak inductor current limit
- I_{LH} is the inductor current ripple
- η is the boost converter power convert efficiency

Minimum input voltage, maximum boost output voltage and minimum current limit should be used as the worst case condition for the estimation.

In this example, assume the power efficiency is 70% at the minimum input voltage of 0.9 V. The calculated maximum output current is 114 mA, which satisfies the application requirements.

8.2.1.2.3 Inductor Selection

Because the inductor affects steady state operation, transient behavior, and loop stability, the inductor is the most important component in power regulator design. There are three important inductor specifications, inductor value, saturation current, and dc resistance (DCR).

The TPS61322xx is optimized to work with inductor values between 0.7 μH and 13 μH . The inductor values affect the switching frequency. The estimated switching frequency in continuous conduction mode (CCM) can be calculated by [方程式 2](#). The switching frequency f_{SW} is not a constant value, which is determined by the inductance, the inductor current ripple, the input voltage and the output voltage. The current ripple I_{LH} is fixed to 200 mA typically, but it can be affected by the inductor value indirectly. Normally when a smaller inductor value is applied, the inductor current ramps up and down more quickly. The current ripple becomes bigger because the internal current comparator has delay to respond. If a smaller inductor peak current is required in applications, a higher inductor value can be used. However, The inductor and output capacitor must be considered together for the loop stability. The output capacitor and the inductance will influence the bandwidth and phase margin of the converter. Consequently, with a larger inductor, a bigger capacitor normally must be used to ensure the same

L/C ratio for a stable loop. For best stability consideration, a 4.7- μ H inductor is recommended for 2.2-V output voltage application.

$$f_{SW} = \frac{V_{IN} \times (V_{OUT} - V_{IN} \times \eta)}{L \times I_{LH} \times V_{OUT}} \quad (2)$$

where

- f_{SW} is the switching frequency of the converter
- I_{LH} is the inductor current ripple
- η is the boost converter power convert efficiency

Having selected the inductance value, follow [方程式 3](#) to [方程式 5](#) to calculate the inductor's peak current for the application. Depending on different load conditions, the TPS61322xx works in continuous current mode or discontinuous conduction mode(DCM). In different modes, the peak currents of the inductor are also different. [方程式 3](#) provides an easy way to estimate whether the device works in CCM or DCM. [方程式 4](#) shows the peak current when the device works in CCM and [方程式 5](#) shows the peak current when the device works in DCM.

$$\frac{V_{OUT} \times I_{OUT}}{V_{IN} \times \eta} > \frac{I_{LH}}{2} \quad (3)$$

where

- I_{LH} is the inductor current ripple
- η is the boost converter power convert efficiency

$$I_{L,peak} = \frac{V_{OUT} \times I_{OUT}}{V_{IN} \times \eta} + \frac{I_{LH}}{2} \quad (4)$$

where

- $I_{L,peak}$ is the peak current of the inductor
- I_{LH} is the inductor current ripple
- η is the boost converter power convert efficiency

$$I_{L,peak} = I_{LH} \quad (5)$$

where

- $I_{L,peak}$ is the peak inductor.
- I_{LH} is the inductor current ripple

The saturation current of the inductor must be higher than the calculated peak inductor current, otherwise the excessive peak current in the inductor harms the device and reduces the system reliability.

8.2.1.2.4

In this example, the maximum load for the boost converter is 50 mA, the minimum input voltage is 0.9 V, and the efficiency under this condition can be estimated at 80%, so the boost converter works in continuous operation mode by the calculation. The inductor peak current is calculated as 258 mA. To have some margin, a 4.7- μ H inductor with at least 300 mA saturation current is recommended for this application. A 10- μ H inductor can be used as well by increasing the output capacitance to higher than 22 μ F to make the loop stable. [表 8-2](#) lists the recommended inductors for TPS61322xx device.

表 8-2. List of Inductors

| INDUCTANCE [μ H] | SATURATION CURRENT [A] | DC RESISTANCE [m Ω] | SIZE (L×W×H)(mm) | PART NUMBER | MANUFACTURER ⁽¹⁾ |
|-----------------------|------------------------|-----------------------------|------------------|--------------------|-----------------------------|
| 4.7 | 1.7 | 165 | 2.5 × 2 × 1.2 | DFE252012P-4R7M=P2 | MURATA |
| 4.7 | 1.5 | 141 | 3 × 3 × 1.5 | 74438335047 | Würth |

表 8-2. List of Inductors (续)

| INDUCTANCE [μH] | SATURATION CURRENT [A] | DC RESISTANCE [mΩ] | SIZE (L×W×H)(mm) | PART NUMBER | MANUFACTURER ⁽¹⁾ |
|-----------------|------------------------|--------------------|------------------|------------------|-----------------------------|
| 4.7 | 1.5 | 209 | 2.5 × 2 × 1.2 | SDEM25201B-4R7MS | CYNTEC |

(1) See [Third-party Products Disclaimer](#)

8.2.1.2.5 Capacitor Selection

For better output voltage filtering, TI recommends low ESR X5R or X7R ceramic capacitors.

For the output capacitor at the VOUT pin, TI recommends small ceramic capacitors. Place the capacitors as close as possible to the VOUT and GND pins of the device to depress the SW spike. The device can normally work with SW negative spike of -0.7V within 1ns. However, larger negative spike may potentially shoot the MOSFET inside. If, for any reason, the application requires the use of large capacitors that cannot be placed close to the device, the use of a small ceramic capacitor with a capacitance value of 1 μF in parallel to the large one is recommended. Place this small capacitor as close as possible to the VOUT and GND pins of the device.

Considering loop stability, for inductance of 4.7 μH, the minimal output capacitor value is 10 μF (effective value). Refer to [表 8-3](#) for inductor and capacitor combination. Increasing the output capacitor makes the output ripple smaller.

When selecting capacitors, ceramic capacitor's derating effect under DC bias voltage must be considered. Choose the right nominal capacitance by checking capacitor's DC bias characteristics. In this example, GRM188R60J106ME84D, which is a 10-μF ceramic capacitor with high effective capacitance value at DC biased condition, is selected for V_{OUT} rail. Two 10-μF capacitors in parallel are recommended to get the desired effective capacitance.

8.2.1.2.6

表 8-3. List of Inductor and Capacitor

| INDUCTANCE [μH] | CAPACITANCE [μF] | LOAD [mA] | PACKAGE | PART NUMBER | MANUFACTURER ⁽¹⁾ |
|-----------------|------------------|-----------|---------|--------------------|-----------------------------|
| 1.0 | 2 × 10 | 50 | 0603 | GRM188R60J106ME84D | MURATA |
| 2.2 | 2 × 10 | 50 | 0603 | GRM188R60J106ME84D | MURATA |
| 4.7 | 22 | 50 | 0805 | GRM21BZ71A226ME15 | MURATA |

(1) See [Third-party Products Disclaimer](#)

TPS61322

ZHCSI34E - JANUARY 2018 - REVISED FEBRUARY 2024

8.2.1.3 Application Curves



图 8-2. Switching Waveform at Light Load



图 8-3. Switching Waveform at Heavy Load

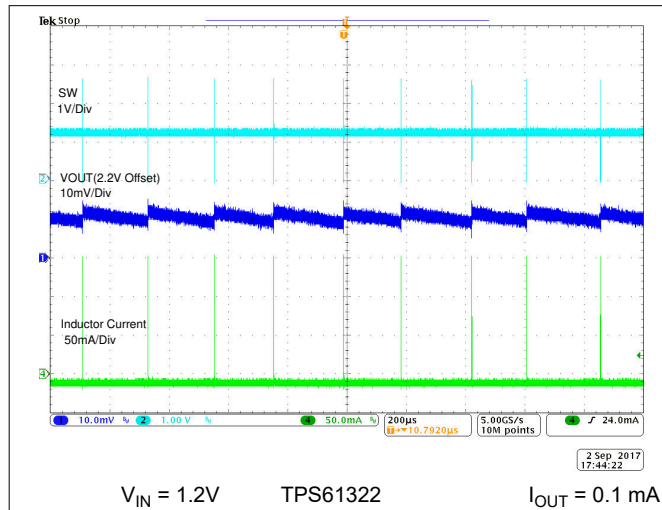

图 8-4. Start-up by VIN

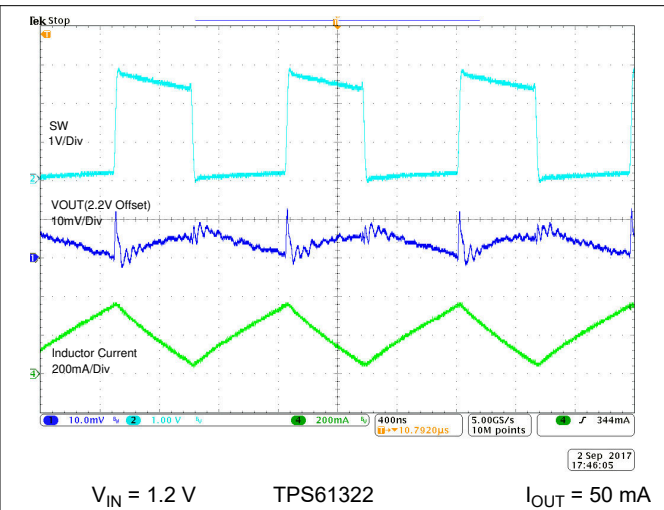

图 8-5. Line Transient

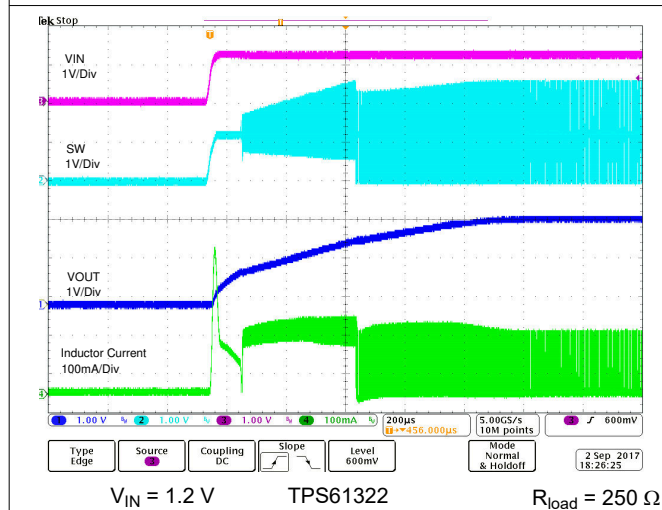

图 8-6. Load Transient

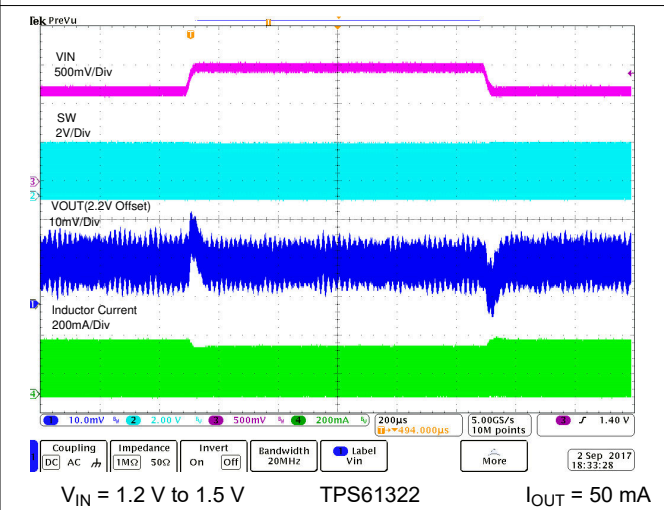

图 8-7. Load Transient

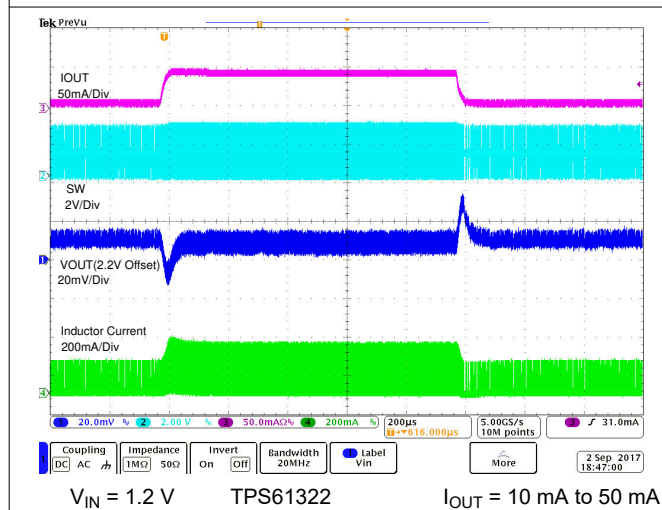

Wurth Electronics, 74438335XXX family

2.2 μH, 4.7 μH, 10 μH

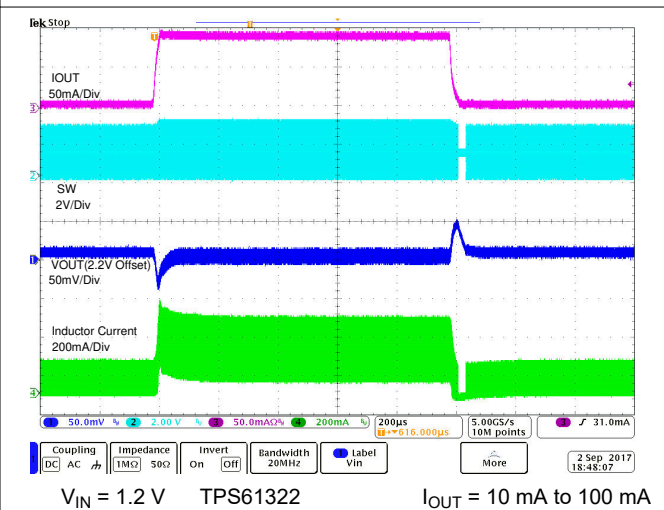
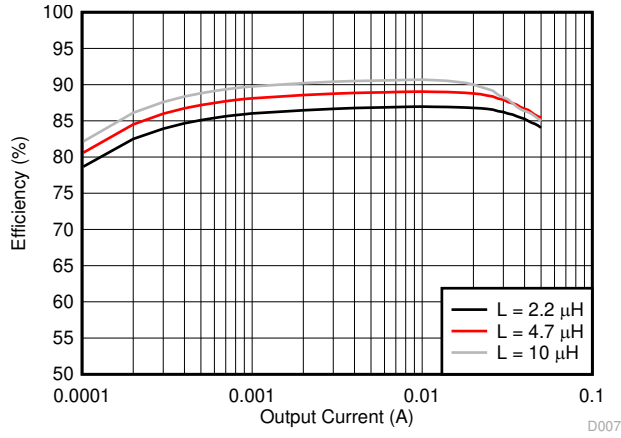
$V_{IN} = 1.2 V$

TPS61322

图 8-8. Efficiency with Different Inductance

8.2.2 Boost with Schottky Diode

Another typical application example is the USB OTG which normally requires 5-V output as its supply voltage and consumes as high as 500-mA current. The following design procedure can be used to select external component values for this application.



图 8-9. Typical Application Circuit with Schottky Diode

8.2.2.1 Design Requirements

表 8-4. Design Requirements

| PARAMETERS | VALUES |
|-----------------------|---------------|
| Input voltage | 3 V to 4.35 V |
| Output voltage | 5 V |
| Output current | 500 mA |
| Output voltage ripple | ± 25 mV |

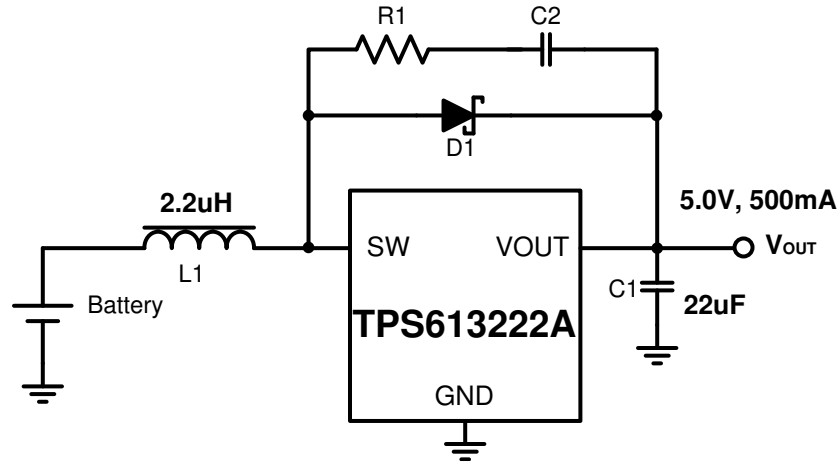
8.2.2.2 Detailed Design Procedure

8.2.2.2.1 Inductor Selection

The peak current is calculated according to 方程式 4 和 方程式 5. The saturation current of the inductor must be higher than the calculated peak inductor current.

In this example, the maximum load for the boost converter is 500 mA, and the minimum input voltage is 3 V. Assuming the efficiency under this condition is 90%, and a typical 2.2- μ H inductor is adopted in this application, so the boost converter works in continuous operation mode by the calculation. The current ripple is 500mA and the inductor peak current is calculated as 1.18 A. To leave some margin, a 2.2- μ H inductor with at least 1.4-A saturation current is recommended for this application. 表 8-5 lists the recommended inductors for TPS613222A device.

表 8-5. List of Inductors

| INDUCTANCE [μ H] | SATURATION CURRENT [A] | DC RESISTANCE [m Ω] | SIZE (L×W×H) (mm) | PART NUMBER | MANUFACTURER ⁽¹⁾ |
|-----------------------|------------------------|-----------------------------|-------------------|-------------------|-----------------------------|
| 2.2 | 2.3 | 82 | 2.5 × 2 × 1.2 | DFE252012F-2R2M | MURATA |
| 2.2 | 2.4 | 89 | 2.5 × 2 × 1 | HMLQ25201T-2R2MSR | CYNTEC |
| 2.2 | 2.5 | 75 | 3.2 × 2.5 × 1.2 | HMME32251B--2R2MS | CYNTEC |

(1) See [Third-party Products Disclaimer](#)

8.2.2.2.2 Schottky Diode Selection

The high switching frequency of TPS61322xx demands a high-speed rectifying switch for optimum efficiency. Ensure that the average and peak current rating of the diode exceeds the average output current and peak inductor current. In addition, the reverse breakdown voltage of the diode must exceed the maximum output voltage of the converter. A snubber circuit consisting of a resistor R1 and a capacitor C2 is needed if the Schottky diode D1 is soldered. The capacitance of C2 must be larger than triple times of the diode capacitance. The typical value of the resistor R1 is 5 Ω, and the typical value of the capacitor C2 is 120 pF.

8.2.2.2.3 Capacitor Selection

Refer to 节 8.2.1.2.5 for the detailed design steps.表 8-6 lists the recommended inductor and capacitor combination. Three 10- μ F capacitors in parallel are recommended to get the desired effective capacitance.

表 8-6. List of Inductor and Capacitor

| INDUCTANCE [μH] | CAPACITANCE [μF] | LOAD [mA] | PACKAGE | PART NUMBER | MANUFACTURER ⁽¹⁾ |
|-----------------|------------------|-----------|---------|--------------------|-----------------------------|
| 1 | 3 × 10 | 500 | 0603 | GRM188R60J106ME84D | MURATA |
| 2.2 | 3 × 10 | 500 | 0603 | GRM188R60J106ME84D | MURATA |
| 4.7 | 2 × 22 | 500 | 0805 | GRM21BZ71A226ME15 | MURATA |

(1) See [Third-party Products Disclaimer](#)

8.2.2.3 Application Curves



图 8-10. Switching Waveform at Light Load



图 8-11. Switching Waveform at Heavy Load

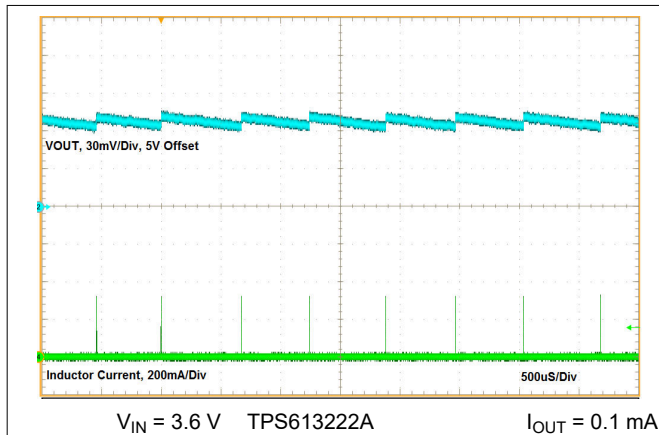

图 8-12. Switching Waveform at Heavy Load

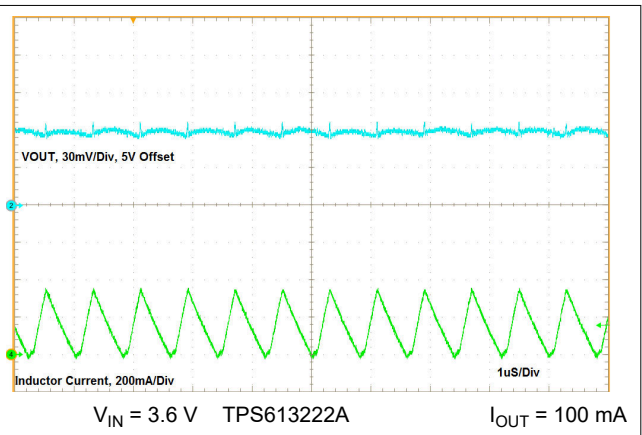

图 8-13. Start-up by VIN

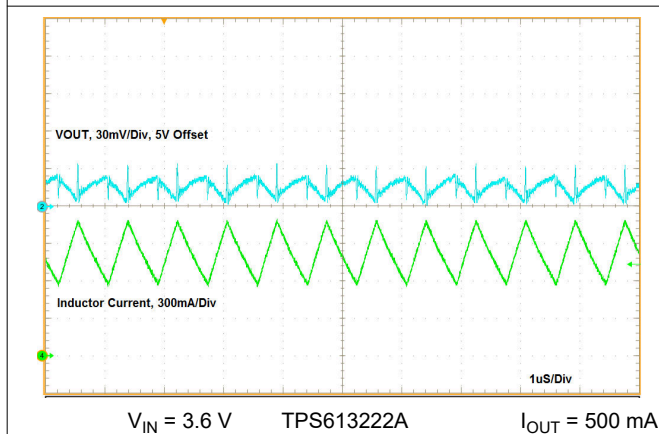

$V_{IN} = 2.7\text{ V to } 4.3\text{ V}$ TPS613222A $I_{OUT} = 500\text{ mA}$

图 8-14. Line Transient

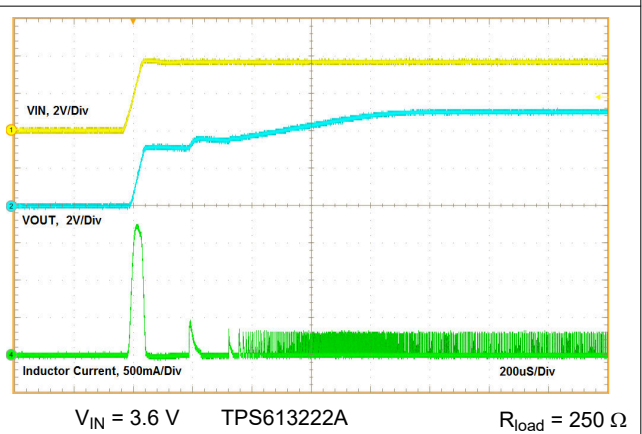
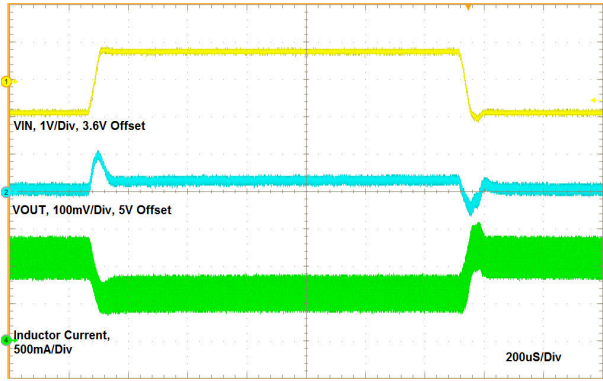
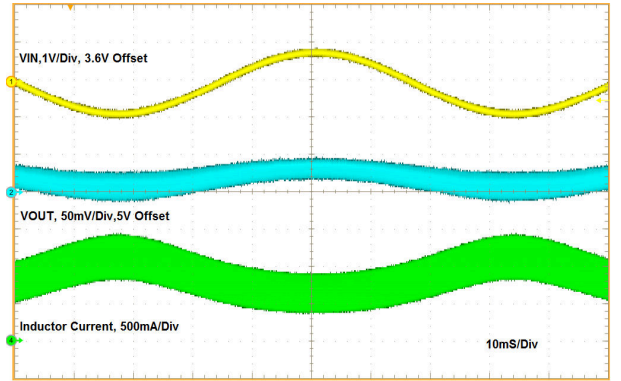

$V_{IN} = 2.7\text{ V to } 4.4\text{ V}$ TPS613222A $I_{OUT} = 500\text{ mA}$

图 8-15. Line Regulation

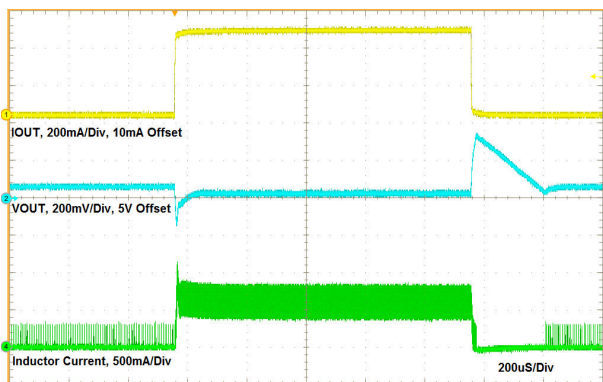

$V_{IN} = 3.6\text{ V}$ TPS613222A $I_{OUT} = 10\text{ mA to } 500\text{ mA}$

图 8-16. Load Transient

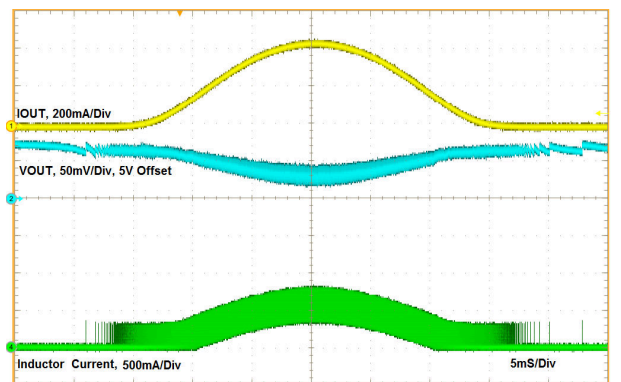

$V_{IN} = 3.6\text{ V}$ TPS613222A $I_{OUT} = 0\text{ mA to } 500\text{ mA}$

图 8-17. Load Regulation

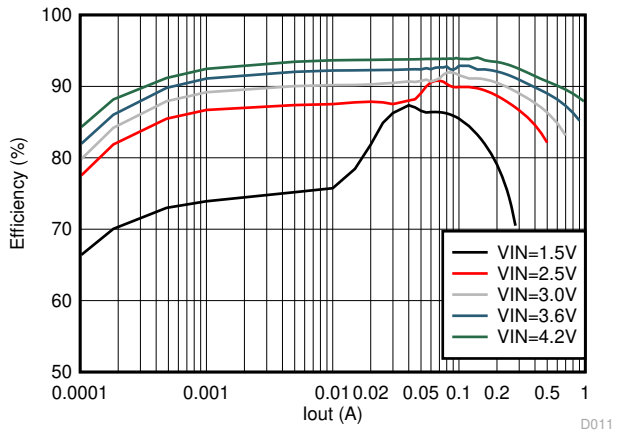

TPS613222A $L = 2.2\text{ }\mu\text{H}$ D1:ZLLS410TA

图 8-18. Efficiency with Different Input Voltage

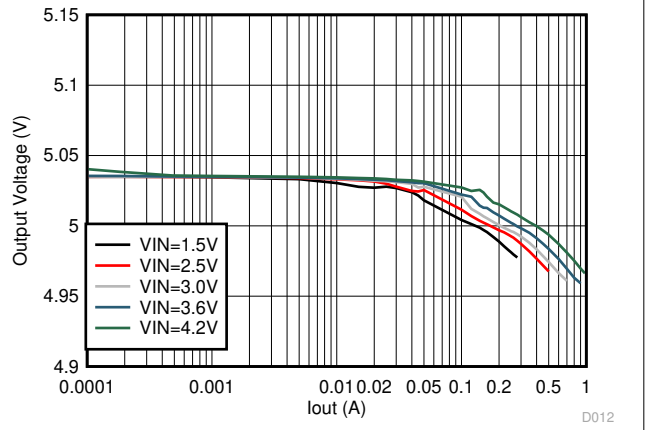

TPS613222A $L = 2.2\text{ }\mu\text{H}$ D1:ZLLS410TA

图 8-19. Load Regulation

8.3 System Examples

TPS61322xx can be easily shut down with an external switch Q1 as shown in 图 8-20. The switch can be mechanical switch, a P-channel MOSFET, or a PNP transistor. For a mechanical switch, there is no control logic needed to turn on or turn off the switch.



图 8-20. True Shutdown for TPS61322xx

8.3.1 Detail Design Schematics

The 图 8-21 shows the application circuit when the power supply of the micro controller unit (MCU) is not less than the battery voltage. The 图 8-22 shows the application circuit when the power supply of the micro controller unit (MCU) is less than the battery voltage.

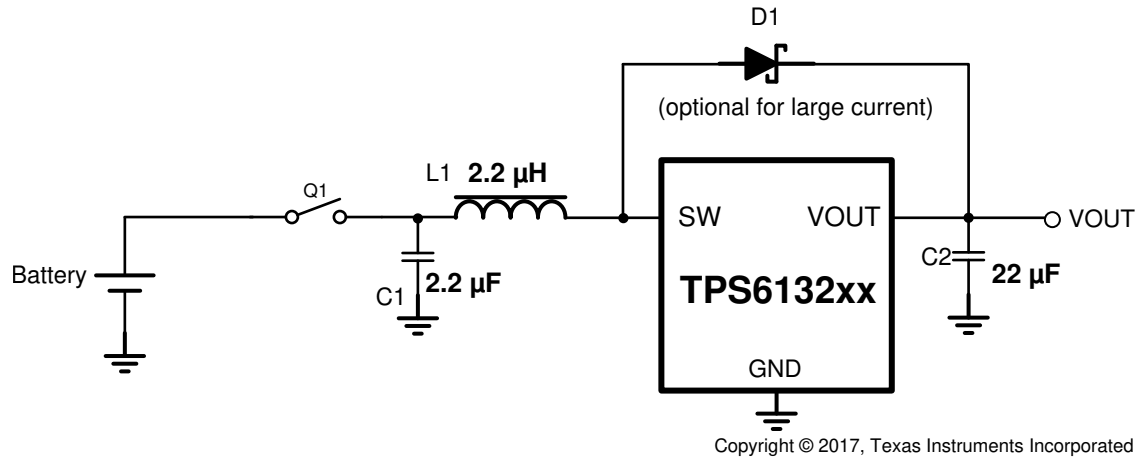

图 8-21. True Shutdown, V_MCU Voltage No Less than Battery Voltage



图 8-22. True Shutdown, V_MCU Voltage Less than Battery Voltage

9 Power Supply Recommendations

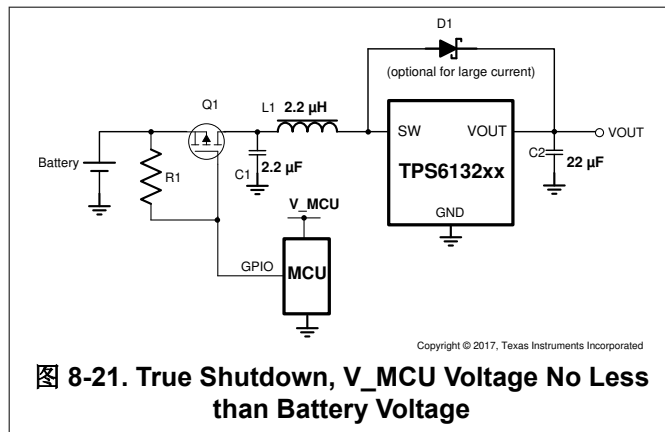
The TPS61322xx is designed to operate from an input voltage supply range between 0.9 V to 5.5 V. The power supply can be alkaline battery, NiMH rechargeable battery, Li-Mn battery or rechargeable Li-ion battery. The input supply must be well regulated with the rating of the TPS61322xx.

10 Layout

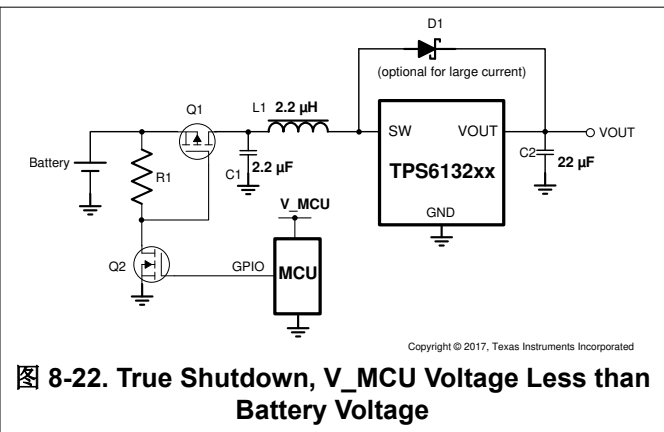
10.1 Layout Guidelines

As for all switching power supplies, the layout is an important step in the design, especially at high peak currents and high switching frequencies. If the layout is not carefully done, the regulator could show stability problems as well as EMI problems. Therefore, use wide and short traces for the main current path and for the power ground paths. Place the output capacitor, as well as the inductor, as close as possible to the device.

10.2 Layout Examples

A large ground plane on the top and bottom is good for thermal performance.

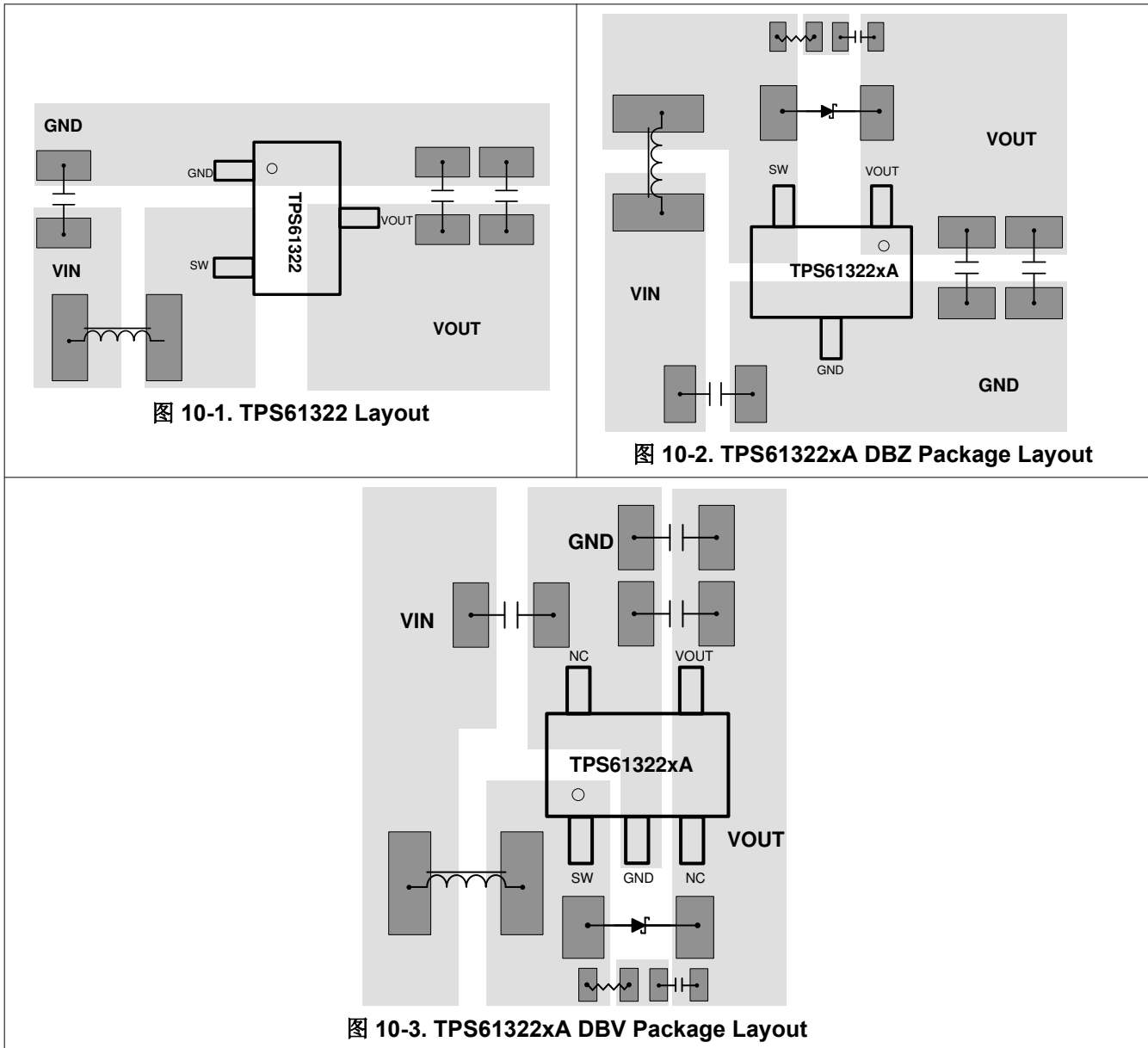

11 Device and Documentation Support

11.1 Device Support

11.1.1 第三方产品免责声明

TI 发布的与第三方产品或服务有关的信息，不能构成与此类产品或服务或保修的适用性有关的认可，不能构成此类产品或服务单独或与任何 TI 产品或服务一起的表示或认可。

11.1.2 Development Support

11.1.2.1 Custom Design With WEBENCH® Tools

[Click here](#) to create a custom design using the TPS61322 device with the WEBENCH® Power Designer.

1. Start by entering the input voltage (V_{IN}), output voltage (V_{OUT}), and output current (I_{OUT}) requirements.
2. Optimize the design for key parameters such as efficiency, footprint, and cost using the optimizer dial.
3. Compare the generated design with other possible solutions from Texas Instruments.

The WEBENCH Power Designer provides a customized schematic along with a list of materials with real-time pricing and component availability.

In most cases, these actions are available:

- Run electrical simulations to see important waveforms and circuit performance
- Run thermal simulations to understand board thermal performance
- Export customized schematic and layout into popular CAD formats
- Print PDF reports for the design, and share the design with colleagues

Get more information about WEBENCH tools at www.ti.com/WEBENCH.

11.2 Documentation Support

11.2.1 Related Documentation

For related documentation see the following:

[TPS61322-BMC001 Evaluation Module User's Guide](#)

11.3 Receiving Notification of Documentation Updates

To receive notification of documentation updates, navigate to the device product folder on ti.com. In the upper right corner, click on *Alert me* to register and receive a weekly digest of any product information that has changed. For change details, review the revision history included in any revised document.

11.4 支持资源

[TI E2E™ 中文支持论坛](#) 是工程师的重要参考资料，可直接从专家处获得快速、经过验证的解答和设计帮助。搜索现有解答或提出自己的问题，获得所需的快速设计帮助。

链接的内容由各个贡献者“按原样”提供。这些内容并不构成 TI 技术规范，并且不一定反映 TI 的观点；请参阅 TI 的 [使用条款](#)。

11.5 Trademarks

TI E2E™ is a trademark of Texas Instruments.

WEBENCH® is a registered trademark of Texas Instruments.

所有商标均为其各自所有者的财产。

11.6 静电放电警告



静电放电 (ESD) 会损坏这个集成电路。德州仪器 (TI) 建议通过适当的预防措施处理所有集成电路。如果不遵守正确的处理和安装程序，可能会损坏集成电路。

ESD 的损坏小至导致微小的性能降级，大至整个器件故障。精密的集成电路可能更容易受到损坏，这是因为非常细微的参数更改都可能会导致器件与其发布的规格不相符。

11.7 术语表

TI 术语表 本术语表列出并解释了术语、首字母缩略词和定义。

12 Revision History

注：以前版本的页码可能与当前版本的页码不同

Changes from February 19, 2019 to February 21, 2024 (from Revision D (February 2019) to Revision E (February 2024))

| | Page |
|---|------|
| • Updated second paragraph with additional information..... | 15 |

Changes from Revision C (May 2018) to Revision D (February 2019)

| | Page |
|--|------|
| • 从 TPS61322 标题中删除了“准 GPN”并将“TPS61322xx”更改成了“TPS61322” | 1 |
| • 添加了 WEBENCH 链接..... | 1 |
| • Changed the NFET symbol in 节 7.2 | 9 |
| • Added 节 7.3.7 | 10 |

Changes from Revision B (April 2018) to Revision C (May 2018)

| | Page |
|--|------|
| • Deleted Cross Reference to 节 4 and the Electrical Characteristics table footnotes regarding device TPS61223A, that was <i>Product Preview</i> device in the SLVSDY5B revision..... | 3 |
| • Deleted Cross Reference to 节 6.5 footnote regarding device TPS61223A, that was <i>Product Preview</i> in the SLVSDY5B revision. | 5 |
| • Added graphs pertaining to TPS613223A device to the Typical Characteristics matrix. | 6 |

Changes from Revision A (January 2018) to Revision B (April 2018)

| | Page |
|---|------|
| • Deleted Cross Reference to 节 4 and the Electrical Characteristics table footnotes regarding devices TPS61221A, TPS61222A, and TPS61226A that were <i>Product Preview</i> devices in the SLVSDY5A revision.... | 3 |
| • Deleted Cross Reference to 节 6.5 footnote regarding devices TPS61221A, TPS61222A, and TPS61226A that were <i>Product Preview</i> in the SLVSDY5A revision. | 5 |
| • Added 图 6-3 , 图 6-4 and 图 6-5 | 6 |
| • Added 图 6-7 , 图 6-8 , and 图 6-11 | 6 |

Changes from Revision * (September 2017) to Revision A (January 2018)

| | Page |
|---------------------------|------|
| • 2018 年 1 月量产数据发布。 | 1 |

13 Mechanical, Packaging, and Orderable Information

The following pages include mechanical, packaging, and orderable information. This information is the most current data available for the designated devices. This data is subject to change without notice and revision of this document. For browser-based versions of this data sheet, refer to the left-hand navigation.

PACKAGING INFORMATION

| Orderable part number | Status (1) | Material type (2) | Package Pins | Package qty Carrier | RoHS (3) | Lead finish/ Ball material (4) | MSL rating/ Peak reflow (5) | Op temp (°C) | Part marking (6) |
|--------------------------------|---------------|----------------------|------------------|-----------------------|-------------|--------------------------------------|-----------------------------------|--------------|---------------------|
| TPS613221ADBVR | Active | Production | SOT-23 (DBV) 5 | 3000 LARGE T&R | Yes | NIPDAU SN | Level-1-260C-UNLIM | -40 to 125 | 1N4L |
| TPS613221ADBVR.B | Active | Production | SOT-23 (DBV) 5 | 3000 LARGE T&R | Yes | NIPDAU | Level-1-260C-UNLIM | -40 to 125 | 1N4L |
| TPS613221ADBVT | Active | Production | SOT-23 (DBV) 5 | 250 SMALL T&R | Yes | NIPDAU SN | Level-1-260C-UNLIM | -40 to 125 | 1N4L |
| TPS613221ADBVT.B | Active | Production | SOT-23 (DBV) 5 | 250 SMALL T&R | Yes | NIPDAU | Level-1-260C-UNLIM | -40 to 125 | 1N4L |
| TPS613222ADBVR | Active | Production | SOT-23 (DBV) 5 | 3000 LARGE T&R | Yes | NIPDAU SN | Level-1-260C-UNLIM | -40 to 125 | 1N5L |
| TPS613222ADBVR.B | Active | Production | SOT-23 (DBV) 5 | 3000 LARGE T&R | Yes | NIPDAU | Level-1-260C-UNLIM | -40 to 125 | 1N5L |
| TPS613222ADBVT | Active | Production | SOT-23 (DBV) 5 | 250 SMALL T&R | Yes | NIPDAU SN | Level-1-260C-UNLIM | -40 to 125 | 1N5L |
| TPS613222ADBVT.B | Active | Production | SOT-23 (DBV) 5 | 250 SMALL T&R | Yes | NIPDAU | Level-1-260C-UNLIM | -40 to 125 | 1N5L |
| TPS613222ADBVTG4 | Active | Production | SOT-23 (DBV) 5 | 250 SMALL T&R | Yes | NIPDAU | Level-1-260C-UNLIM | -40 to 125 | 1N5L |
| TPS613222ADBVTG4.B | Active | Production | SOT-23 (DBV) 5 | 250 SMALL T&R | Yes | NIPDAU | Level-1-260C-UNLIM | -40 to 125 | 1N5L |
| TPS613223ADBVR | Active | Production | SOT-23 (DBV) 5 | 3000 LARGE T&R | Yes | NIPDAU SN | Level-1-260C-UNLIM | -40 to 125 | 1NRL |
| TPS613223ADBVR.B | Active | Production | SOT-23 (DBV) 5 | 3000 LARGE T&R | Yes | NIPDAU | Level-1-260C-UNLIM | -40 to 125 | 1NRL |
| TPS613223ADBVT | Active | Production | SOT-23 (DBV) 5 | 250 SMALL T&R | Yes | NIPDAU SN | Level-1-260C-UNLIM | -40 to 125 | 1NRL |
| TPS613223ADBVT.B | Active | Production | SOT-23 (DBV) 5 | 250 SMALL T&R | Yes | NIPDAU | Level-1-260C-UNLIM | -40 to 125 | 1NRL |
| TPS613226ADBVR | Active | Production | SOT-23 (DBV) 5 | 3000 LARGE T&R | Yes | NIPDAU SN | Level-1-260C-UNLIM | -40 to 125 | 1N6L |
| TPS613226ADBVR.B | Active | Production | SOT-23 (DBV) 5 | 3000 LARGE T&R | Yes | NIPDAU | Level-1-260C-UNLIM | -40 to 125 | 1N6L |
| TPS613226ADBVT | Active | Production | SOT-23 (DBV) 5 | 250 SMALL T&R | Yes | NIPDAU SN | Level-1-260C-UNLIM | -40 to 125 | 1N6L |
| TPS613226ADBVT.B | Active | Production | SOT-23 (DBV) 5 | 250 SMALL T&R | Yes | SN | Level-1-260C-UNLIM | -40 to 125 | 1N6L |
| TPS61322DBZR | Active | Production | SOT-23 (DBZ) 3 | 3000 LARGE T&R | Yes | NIPDAU SN | Level-1-260C-UNLIM | -40 to 125 | 1EME |
| TPS61322DBZR.B | Active | Production | SOT-23 (DBZ) 3 | 3000 LARGE T&R | Yes | NIPDAU | Level-1-260C-UNLIM | -40 to 125 | 1EME |
| TPS61322DBZT | Active | Production | SOT-23 (DBZ) 3 | 250 SMALL T&R | Yes | NIPDAU SN | Level-1-260C-UNLIM | -40 to 125 | 1EME |
| TPS61322DBZT.B | Active | Production | SOT-23 (DBZ) 3 | 250 SMALL T&R | Yes | NIPDAU | Level-1-260C-UNLIM | -40 to 125 | 1EME |
| XTPS61322DBZT | Obsolete | Preproduction | SOT-23 (DBZ) 3 | - | - | Call TI | Call TI | -40 to 125 | |

(1) **Status:** For more details on status, see our [product life cycle](#).

(2) **Material type:** When designated, preproduction parts are prototypes/experimental devices, and are not yet approved or released for full production. Testing and final process, including without limitation quality assurance, reliability performance testing, and/or process qualification, may not yet be complete, and this item is subject to further changes or possible discontinuation. If available for ordering, purchases will be subject to an additional waiver at checkout, and are intended for early internal evaluation purposes only. These items are sold without warranties of any kind.

(3) **RoHS values:** Yes, No, RoHS Exempt. See the [TI RoHS Statement](#) for additional information and value definition.

(4) **Lead finish/Ball material:** Parts may have multiple material finish options. Finish options are separated by a vertical ruled line. Lead finish/Ball material values may wrap to two lines if the finish value exceeds the maximum column width.

(5) **MSL rating/Peak reflow:** The moisture sensitivity level ratings and peak solder (reflow) temperatures. In the event that a part has multiple moisture sensitivity ratings, only the lowest level per JEDEC standards is shown. Refer to the shipping label for the actual reflow temperature that will be used to mount the part to the printed circuit board.

(6) **Part marking:** There may be an additional marking, which relates to the logo, the lot trace code information, or the environmental category of the part.

Multiple part markings will be inside parentheses. Only one part marking contained in parentheses and separated by a "~" will appear on a part. If a line is indented then it is a continuation of the previous line and the two combined represent the entire part marking for that device.

Important Information and Disclaimer: The information provided on this page represents TI's knowledge and belief as of the date that it is provided. TI bases its knowledge and belief on information provided by third parties, and makes no representation or warranty as to the accuracy of such information. Efforts are underway to better integrate information from third parties. TI has taken and continues to take reasonable steps to provide representative and accurate information but may not have conducted destructive testing or chemical analysis on incoming materials and chemicals. TI and TI suppliers consider certain information to be proprietary, and thus CAS numbers and other limited information may not be available for release.

In no event shall TI's liability arising out of such information exceed the total purchase price of the TI part(s) at issue in this document sold by TI to Customer on an annual basis.

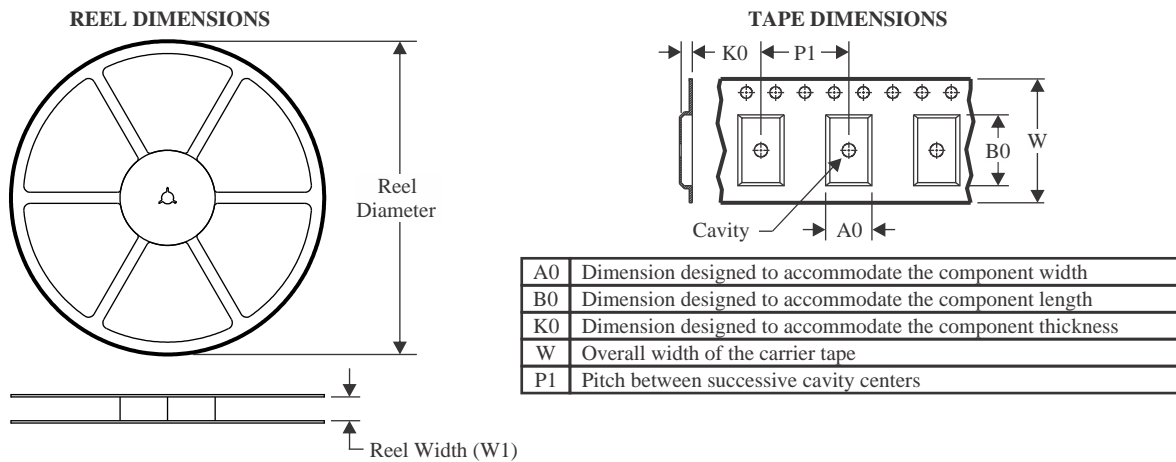
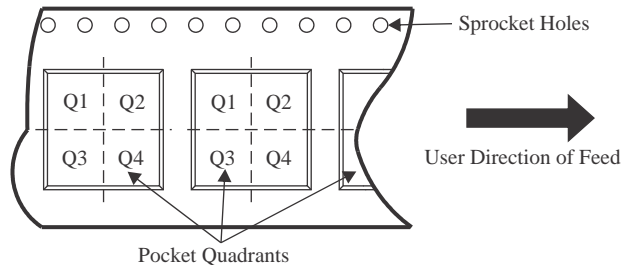
TAPE AND REEL INFORMATION

QUADRANT ASSIGNMENTS FOR PIN 1 ORIENTATION IN TAPE

*All dimensions are nominal

| Device | Package Type | Package Drawing | Pins | SPQ | Reel Diameter (mm) | Reel Width W1 (mm) | A0 (mm) | B0 (mm) | K0 (mm) | P1 (mm) | W (mm) | Pin1 Quadrant |
|------------------|--------------|-----------------|------|------|--------------------|--------------------|---------|---------|---------|---------|--------|---------------|
| TPS613221ADBVR | SOT-23 | DBV | 5 | 3000 | 178.0 | 8.4 | 3.2 | 3.2 | 1.4 | 4.0 | 8.0 | Q3 |
| TPS613221ADBVT | SOT-23 | DBV | 5 | 250 | 180.0 | 8.4 | 3.2 | 3.2 | 1.4 | 4.0 | 8.0 | Q3 |
| TPS613222ADBVR | SOT-23 | DBV | 5 | 3000 | 180.0 | 8.4 | 3.2 | 3.2 | 1.4 | 4.0 | 8.0 | Q3 |
| TPS613222ADBVR | SOT-23 | DBV | 5 | 3000 | 180.0 | 8.4 | 3.2 | 3.2 | 1.4 | 4.0 | 8.0 | Q3 |
| TPS613222ADBVT | SOT-23 | DBV | 5 | 250 | 180.0 | 8.4 | 3.2 | 3.2 | 1.4 | 4.0 | 8.0 | Q3 |
| TPS613222ADBVT | SOT-23 | DBV | 5 | 250 | 180.0 | 8.4 | 3.2 | 3.2 | 1.4 | 4.0 | 8.0 | Q3 |
| TPS613222ADBVTG4 | SOT-23 | DBV | 5 | 250 | 180.0 | 8.4 | 3.2 | 3.2 | 1.4 | 4.0 | 8.0 | Q3 |
| TPS613223ADBVR | SOT-23 | DBV | 5 | 3000 | 180.0 | 8.4 | 3.2 | 3.2 | 1.4 | 4.0 | 8.0 | Q3 |
| TPS613223ADBVR | SOT-23 | DBV | 5 | 3000 | 180.0 | 8.4 | 3.2 | 3.2 | 1.4 | 4.0 | 8.0 | Q3 |
| TPS613223ADBVT | SOT-23 | DBV | 5 | 250 | 180.0 | 8.4 | 3.2 | 3.2 | 1.4 | 4.0 | 8.0 | Q3 |
| TPS613223ADBVT | SOT-23 | DBV | 5 | 250 | 180.0 | 8.4 | 3.2 | 3.2 | 1.4 | 4.0 | 8.0 | Q3 |
| TPS613226ADBVR | SOT-23 | DBV | 5 | 3000 | 178.0 | 8.4 | 3.2 | 3.2 | 1.4 | 4.0 | 8.0 | Q3 |
| TPS613226ADBVT | SOT-23 | DBV | 5 | 250 | 180.0 | 8.4 | 3.2 | 3.2 | 1.4 | 4.0 | 8.0 | Q3 |
| TPS61322DBZR | SOT-23 | DBZ | 3 | 3000 | 178.0 | 9.0 | 3.15 | 2.77 | 1.22 | 4.0 | 8.0 | Q3 |
| TPS61322DBZR | SOT-23 | DBZ | 3 | 3000 | 180.0 | 8.4 | 3.2 | 2.85 | 1.3 | 4.0 | 8.0 | Q3 |
| TPS61322DBZR | SOT-23 | DBZ | 3 | 3000 | 180.0 | 8.4 | 2.9 | 3.35 | 1.35 | 4.0 | 8.0 | Q3 |

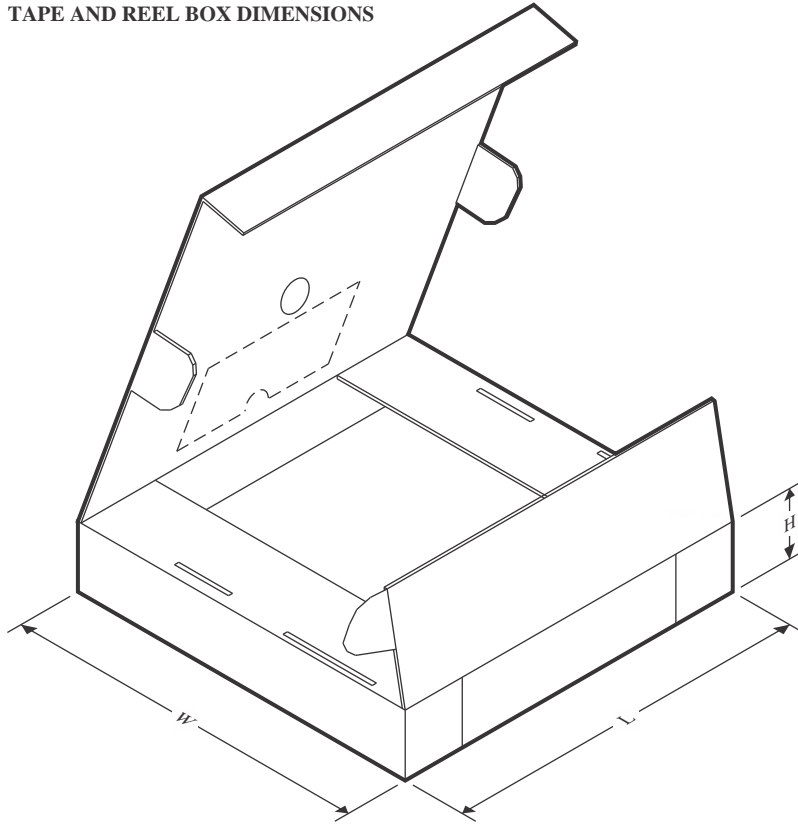
| Device | Package Type | Package Drawing | Pins | SPQ | Reel Diameter (mm) | Reel Width W1 (mm) | A0 (mm) | B0 (mm) | K0 (mm) | P1 (mm) | W (mm) | Pin1 Quadrant |
|--------------|--------------|-----------------|------|-----|--------------------|--------------------|---------|---------|---------|---------|--------|---------------|
| TPS61322DBZT | SOT-23 | DBZ | 3 | 250 | 178.0 | 9.0 | 3.15 | 2.77 | 1.22 | 4.0 | 8.0 | Q3 |
| TPS61322DBZT | SOT-23 | DBZ | 3 | 250 | 180.0 | 8.4 | 2.9 | 3.35 | 1.35 | 4.0 | 8.0 | Q3 |
| TPS61322DBZT | SOT-23 | DBZ | 3 | 250 | 180.0 | 8.4 | 3.2 | 2.85 | 1.3 | 4.0 | 8.0 | Q3 |

TAPE AND REEL BOX DIMENSIONS

*All dimensions are nominal

| Device | Package Type | Package Drawing | Pins | SPQ | Length (mm) | Width (mm) | Height (mm) |
|------------------|--------------|-----------------|------|------|-------------|------------|-------------|
| TPS613221ADBVR | SOT-23 | DBV | 5 | 3000 | 208.0 | 191.0 | 35.0 |
| TPS613221ADBVT | SOT-23 | DBV | 5 | 250 | 210.0 | 185.0 | 35.0 |
| TPS613222ADBVR | SOT-23 | DBV | 5 | 3000 | 210.0 | 185.0 | 35.0 |
| TPS613222ADBVT | SOT-23 | DBV | 5 | 250 | 210.0 | 185.0 | 35.0 |
| TPS613222ADBVT | SOT-23 | DBV | 5 | 250 | 210.0 | 185.0 | 35.0 |
| TPS613222ADBVTG4 | SOT-23 | DBV | 5 | 250 | 210.0 | 185.0 | 35.0 |
| TPS613223ADBVR | SOT-23 | DBV | 5 | 3000 | 210.0 | 185.0 | 35.0 |
| TPS613223ADBVT | SOT-23 | DBV | 5 | 250 | 210.0 | 185.0 | 35.0 |
| TPS613223ADBVT | SOT-23 | DBV | 5 | 250 | 210.0 | 185.0 | 35.0 |
| TPS613226ADBVR | SOT-23 | DBV | 5 | 3000 | 208.0 | 191.0 | 35.0 |
| TPS613226ADBVT | SOT-23 | DBV | 5 | 250 | 210.0 | 185.0 | 35.0 |
| TPS61322DBZR | SOT-23 | DBZ | 3 | 3000 | 180.0 | 180.0 | 18.0 |
| TPS61322DBZR | SOT-23 | DBZ | 3 | 3000 | 210.0 | 185.0 | 35.0 |
| TPS61322DBZR | SOT-23 | DBZ | 3 | 3000 | 210.0 | 185.0 | 35.0 |
| TPS61322DBZT | SOT-23 | DBZ | 3 | 250 | 180.0 | 180.0 | 18.0 |
| TPS61322DBZT | SOT-23 | DBZ | 3 | 250 | 210.0 | 185.0 | 35.0 |

| Device | Package Type | Package Drawing | Pins | SPQ | Length (mm) | Width (mm) | Height (mm) |
|--------------|--------------|-----------------|------|-----|-------------|------------|-------------|
| TPS61322DBZT | SOT-23 | DBZ | 3 | 250 | 210.0 | 185.0 | 35.0 |

EXAMPLE BOARD LAYOUT

DBV0005A

SOT-23 - 1.45 mm max height

SMALL OUTLINE TRANSISTOR

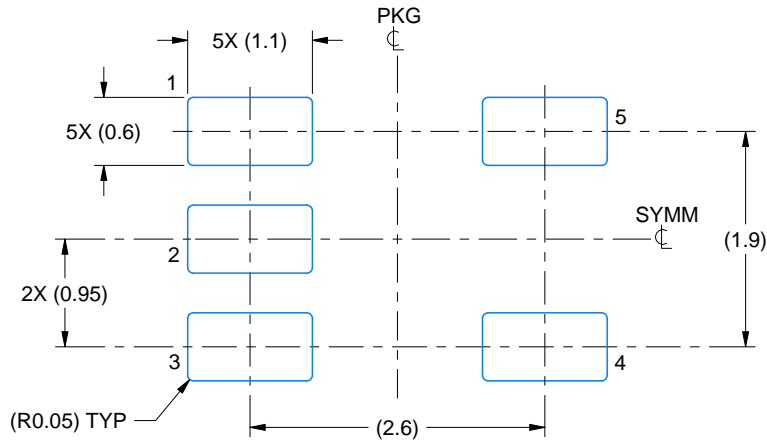

LAND PATTERN EXAMPLE
EXPOSED METAL SHOWN
SCALE:15X

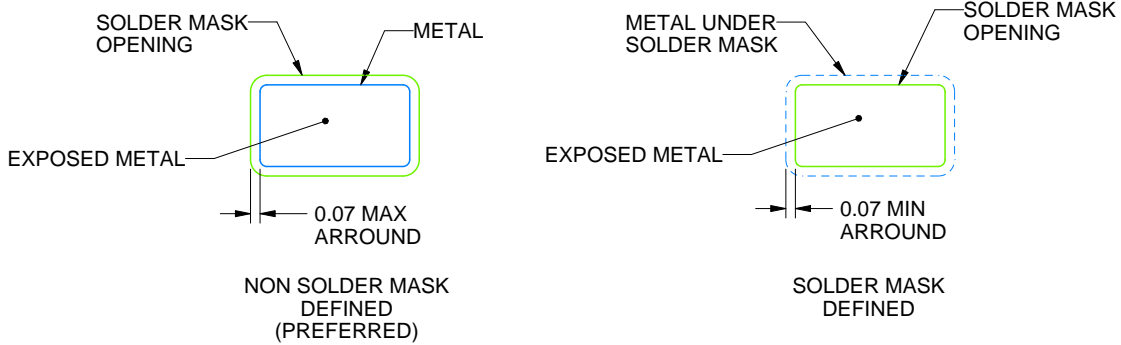

SOLDER MASK DETAILS

4214839/K 08/2024

NOTES: (continued)

- 6. Publication IPC-7351 may have alternate designs.
- 7. Solder mask tolerances between and around signal pads can vary based on board fabrication site.

EXAMPLE STENCIL DESIGN

DBV0005A

SOT-23 - 1.45 mm max height

SMALL OUTLINE TRANSISTOR

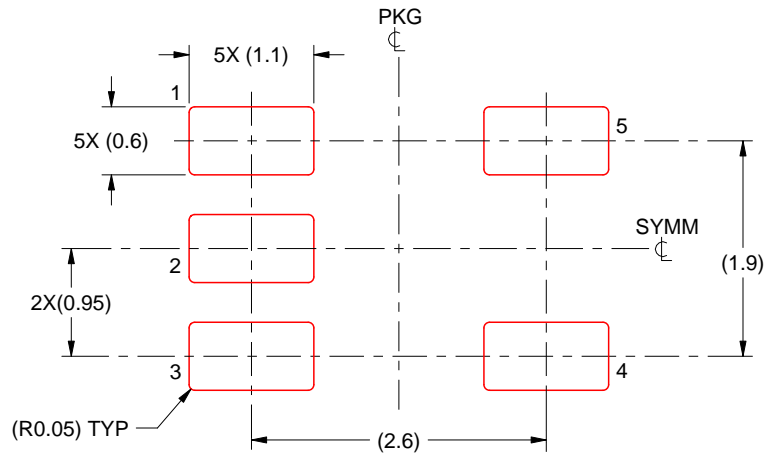

SOLDER PASTE EXAMPLE
BASED ON 0.125 mm THICK STENCIL
SCALE:15X

4214839/K 08/2024

NOTES: (continued)

8. Laser cutting apertures with trapezoidal walls and rounded corners may offer better paste release. IPC-7525 may have alternate design recommendations.
9. Board assembly site may have different recommendations for stencil design.

DBZ0003A

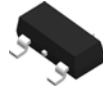

PACKAGE OUTLINE

SOT-23 - 1.12 mm max height

SMALL OUTLINE TRANSISTOR

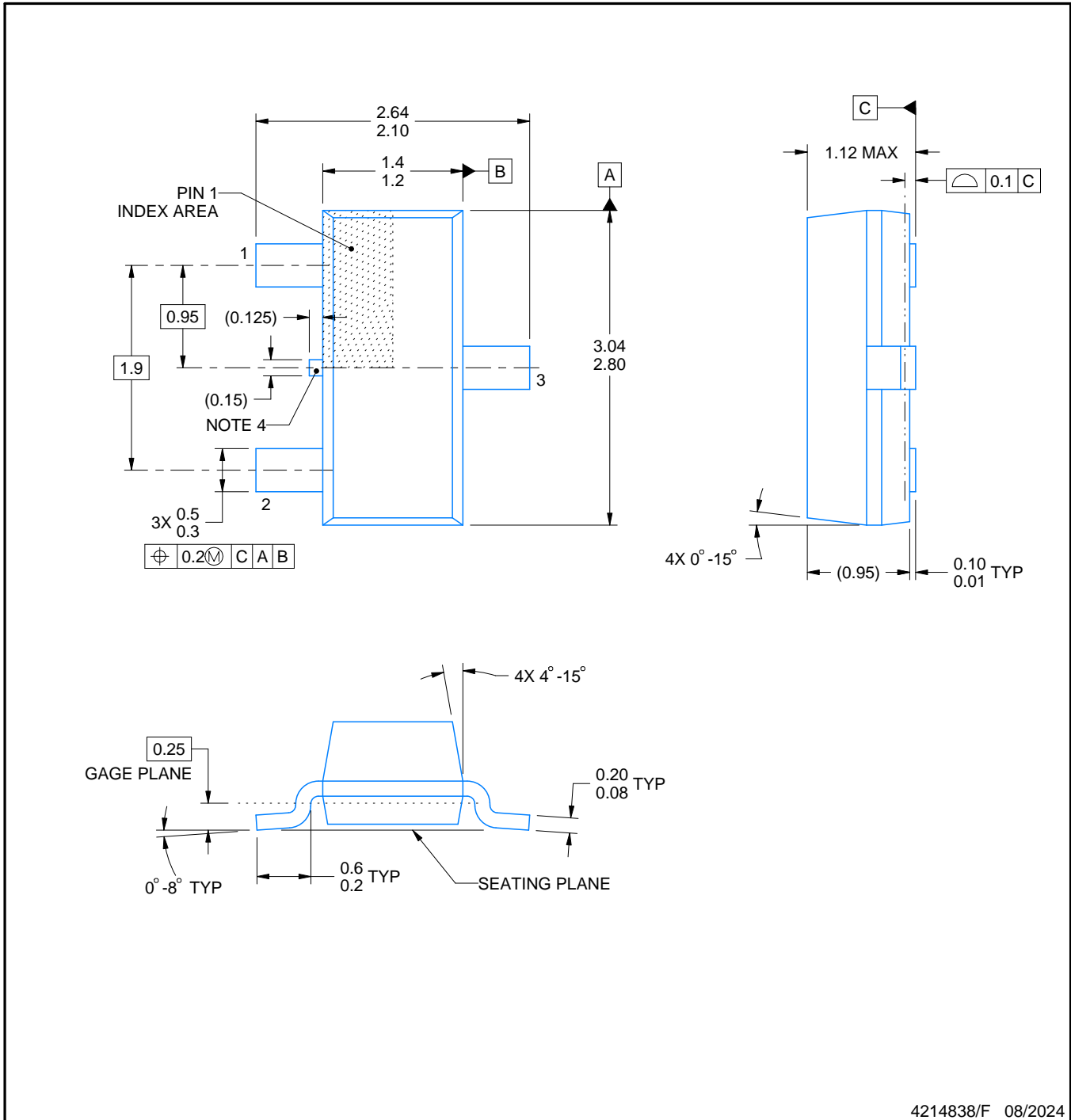

4214838/F 08/2024

NOTES:

1. All linear dimensions are in millimeters. Any dimensions in parenthesis are for reference only. Dimensioning and tolerancing per ASME Y14.5M.
2. This drawing is subject to change without notice.
3. Reference JEDEC registration TO-236, except minimum foot length.
4. Support pin may differ or may not be present.
5. Body dimensions do not include mold flash, protrusions, or gate burrs. Mold flash, protrusions, or gate burrs shall not exceed 0.25mm per side

EXAMPLE BOARD LAYOUT

DBZ0003A

SOT-23 - 1.12 mm max height

SMALL OUTLINE TRANSISTOR

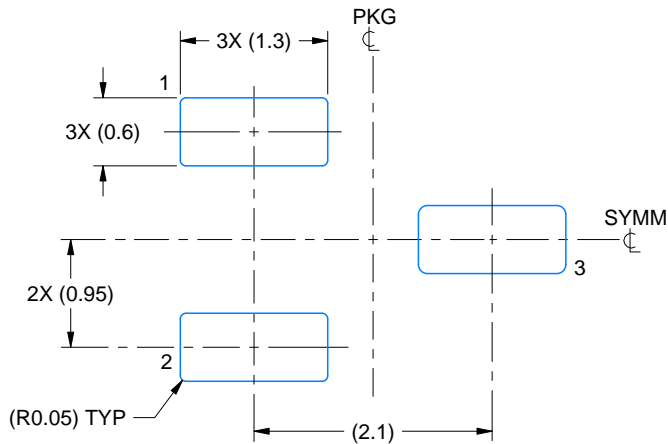

LAND PATTERN EXAMPLE
SCALE:15X

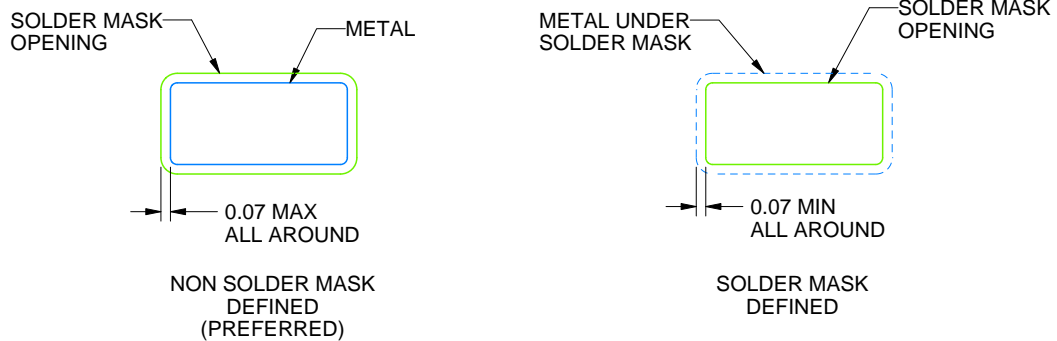

SOLDER MASK DETAILS

4214838/F 08/2024

NOTES: (continued)

5. Publication IPC-7351 may have alternate designs.
6. Solder mask tolerances between and around signal pads can vary based on board fabrication site.

EXAMPLE STENCIL DESIGN

DBZ0003A

SOT-23 - 1.12 mm max height

SMALL OUTLINE TRANSISTOR

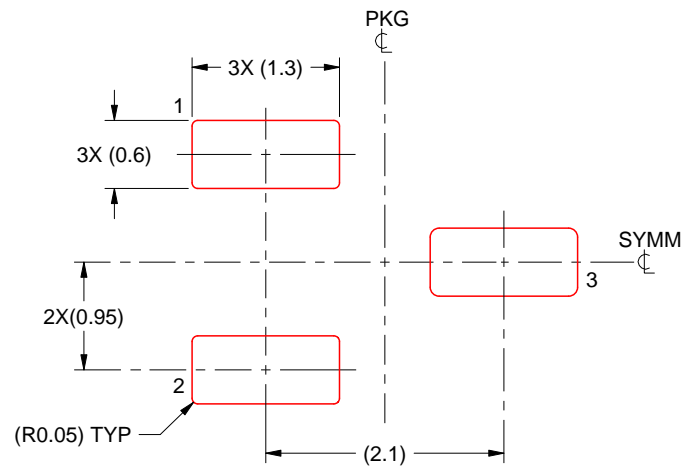

SOLDER PASTE EXAMPLE
BASED ON 0.125 THICK STENCIL
SCALE:15X

4214838/F 08/2024

NOTES: (continued)

7. Laser cutting apertures with trapezoidal walls and rounded corners may offer better paste release. IPC-7525 may have alternate design recommendations.
8. Board assembly site may have different recommendations for stencil design.

重要通知和免责声明

TI“按原样”提供技术和可靠性数据（包括数据表）、设计资源（包括参考设计）、应用或其他设计建议、网络工具、安全信息和其他资源，不保证没有瑕疵且不做任何明示或暗示的担保，包括但不限于对适销性、与某特定用途的适用性或不侵犯任何第三方知识产权的暗示担保。

这些资源可供使用 TI 产品进行设计的熟练开发人员使用。您将自行承担以下全部责任：(1) 针对您的应用选择合适的 TI 产品，(2) 设计、验证并测试您的应用，(3) 确保您的应用满足相应标准以及任何其他安全、安保法规或其他要求。

这些资源如有变更，恕不另行通知。TI 授权您仅可将这些资源用于研发本资源所述的 TI 产品的相关应用。严禁以其他方式对这些资源进行复制或展示。您无权使用任何其他 TI 知识产权或任何第三方知识产权。对于因您对这些资源的使用而对 TI 及其代表造成的任何索赔、损害、成本、损失和债务，您将全额赔偿，TI 对此概不负责。

TI 提供的产品受 [TI 销售条款](#)、[TI 通用质量指南](#) 或 [ti.com](#) 上其他适用条款或 TI 产品随附的其他适用条款的约束。TI 提供这些资源并不会扩展或以其他方式更改 TI 针对 TI 产品发布的适用的担保或担保免责声明。除非德州仪器 (TI) 明确将某产品指定为定制产品或客户特定产品，否则其产品均为按确定价格收入目录的标准通用器件。

TI 反对并拒绝您可能提出的任何其他或不同的条款。

版权所有 © 2026，德州仪器 (TI) 公司

最后更新日期：2025 年 10 月