

具有 $\overline{\text{MR}}$ 和可编程延迟功能的 TPS3840-Q1 汽车类毫微 I_Q 电压监控器

1 特性

- 符合汽车类应用要求
- 具有符合 AEC-Q100 标准的下列特性：
 - 器件温度等级 1: -40°C 至 $+125^{\circ}\text{C}$ 的环境工作温度范围
 - 器件 HBM ESD 分类等级 2
 - 器件 CDM ESD 分类等级 C7B
- 宽工作电压范围: 1.5V 至 10V
 - 利用外部电阻器来扩展输入电压范围
- 毫微电源电流: 350nA (典型值)、700nA (最大值)
- 固定阈值电压 (V_{IT})
 - 阈值范围为 1.6V 至 4.9V (阶跃为 0.1V)
 - 高精度: 1% (典型值)、1.5% (最大值)
 - 内置的迟滞 ($V_{\text{IT+}}$)
 - $1.6\text{V} < V_{\text{IT}} \leq 3.0\text{V} = 100\text{mV}$ (典型值)
 - $3.1\text{V} \leq V_{\text{IT}} < 4.9\text{V} = 200\text{mV}$ (典型值)
- 快速启动延迟 (t_{STRT}): 350 μs (最大值)
- 基于电容器的可编程复位延时时间:
 - t_{D} : 50 μs (无电容器) 至 6.2s (10 μF)
- 低电平有效手动复位 ($\overline{\text{MR}}$)
- 三种输出拓扑:
 - TPS3840DL-Q1: 漏极开路, 低电平有效 ($\overline{\text{RESET}}$)
 - TPS3840PL-Q1: 推挽, 低电平有效 ($\overline{\text{RESET}}$)
 - TPS3840PH-Q1: 推挽, 高电平有效 (RESET)
- 封装: 5 引脚 SOT-23 (DBV)

2 应用

- 汽车音响主机和仪表组
- 汽车显示屏、集成驾驶舱和驾驶员监控
- 远程信息处理控制单元和紧急呼叫

3 说明

TPS3840-Q1 系列电压监控器或复位 IC 可在高电压电平下工作, 同时能够在整个 V_{DD} 和温度范围内保持非常低的静态电流。TPS3840-Q1 可提供低功耗、高精度和低传播延迟 ($t_{\text{p_HL}} = 30\mu\text{s}$ 典型值) 的最佳组合。

当 V_{DD} 上的电压降至负电压阈值 (V_{IT}) 以下或手动复位被拉至低逻辑 ($V_{\overline{\text{MR_L}}}$) 时, 复位输出信号会置位。当 V_{DD} 升至 V_{IT} 加迟滞 ($V_{\text{IT+}}$) 以上以及手动复位 ($\overline{\text{MR}}$) 悬空或高于 $V_{\overline{\text{MR_H}}}$ 、复位延时时间 (t_{D}) 已过期时, 复位信号会清除。可以通过在 CT 引脚和地之间连接一个电容器对复位延时时间进行编程。对于快速复位, 可以将 CT 引脚悬空。

其他特性: 低上电复位电压 (V_{POR})、针对 $\overline{\text{MR}}$ 和 V_{DD} 的内置毛刺抑制保护、内置迟滞、低漏极开路输出漏电流 ($I_{\text{LKG(OD)}}$)。TPS3840-Q1 是一款用于汽车应用和 电池供电/低功耗 应用的完美电压监控 解决方案。

器件信息(1)

器件型号	封装	封装尺寸 (标称值)
TPS3840-Q1	SOT-23 (5) (DBV)	2.90mm × 1.60mm

(1) 有关封装详细信息, 请参阅数据表末尾的机械制图附录。

典型应用电路

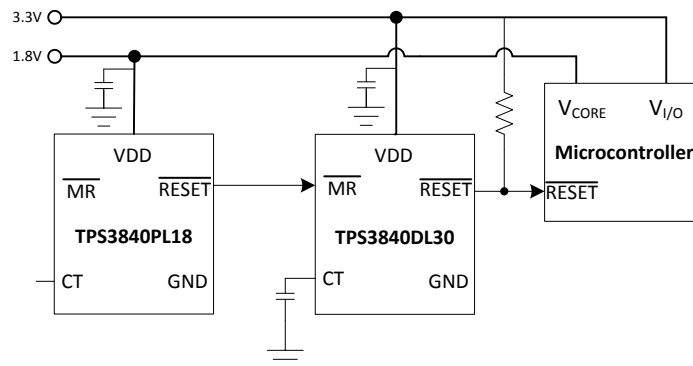

目录

1	特性	1	8.3	Feature Description.....	16
2	应用	1	8.4	Device Functional Modes.....	19
3	说明	1	9	Application and Implementation	20
4	修订历史记录	2	9.1	Application Information.....	20
5	Device Comparison Table	3	9.2	Typical Application	20
6	Pin Configuration and Functions	4	10	Power Supply Recommendations	25
7	Specifications	5	11	Layout	25
7.1	Absolute Maximum Ratings	5	11.1	Layout Guidelines	25
7.2	ESD Ratings	5	11.2	Layout Example	25
7.3	Recommended Operating Conditions.....	5	12	器件和文档支持	26
7.4	Thermal Information	5	12.1	器件命名规则.....	26
7.5	Electrical Characteristics.....	6	12.2	社区资源.....	27
7.6	Timing Requirements	7	12.3	商标.....	27
7.7	Typical Characteristics	9	12.4	静电放电警告.....	27
8	Detailed Description	16	12.5	Glossary	27
8.1	Overview	16	13	机械、封装和可订购信息.....	27
8.2	Functional Block Diagram	16			

4 修订历史记录

注：之前版本的页码可能与当前版本有所不同。

Changes from Original (April 2019) to Revision A	Page
• 将“预告信息”更改为“生产数据发布”.....	1

5 Device Comparison Table

Device Comparison Table shows the variants planned to release at RTM, however other voltages from 表 3 at the end of datasheet can be sample upon request, please contact TI sales representative for details.

PART NUMBER	OUTPUT TOPOLOGY	THRESHOLD (V_{it}) (V)	HYSTERESIS (mV)
TPS3840DL16DBVRQ1 ⁽¹⁾	Open-Drain, Active-Low	1.6	100
TPS3840DL25DBVRQ1 ⁽¹⁾	Open-Drain, Active-Low	2.5	100
TPS3840DL28DBVRQ1 ⁽¹⁾	Open-Drain, Active-Low	2.8	100
TPS3840DL29DBVRQ1 ⁽¹⁾	Open-Drain, Active-Low	2.9	100
TPS3840DL30DBVRQ1 ⁽¹⁾	Open-Drain, Active-Low	3.0	100
TPS3840DL31DBVRQ1 ⁽¹⁾	Open-Drain, Active-Low	3.1	200
TPS3840DL41DBVRQ1 ⁽¹⁾	Open-Drain, Active-Low	4.1	200
TPS3840DL42DBVRQ1 ⁽¹⁾	Open-Drain, Active-Low	4.2	200
TPS3840DL44DBVRQ1 ⁽¹⁾	Open-Drain, Active-Low	4.4	200
TPS3840DL45DBVRQ1 ⁽¹⁾	Open-Drain, Active-Low	4.5	200
TPS3840PL25DBVRQ1 ⁽²⁾	Push-Pull, Active-Low	2.5	100
TPS3840PH27DBVRQ1 ⁽³⁾	Push-Pull, Active-High	2.7	100
TPS3840PH30DBVRQ1 ⁽³⁾	Push-Pull, Active-High	3.0	100

(1) TPS3840DL-Q1: Open-Drain, Active-Low ($\overline{\text{RESET}}$)

(2) TPS3840PL-Q1: Push-Pull, Active-Low ($\overline{\text{RESET}}$)

(3) TPS3840PH-Q1: Push-Pull, Active-High ($\overline{\text{RESET}}$)

6 Pin Configuration and Functions

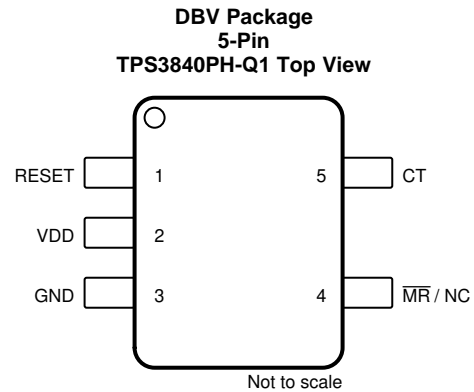

Pin Functions

NAME	PIN		I/O	DESCRIPTION
	TPS3840PL-Q1, TPS3840DL-Q1	TPS3840PH-Q1		
RESET	N/A	1	O	Active-High Output Reset Signal: This pin is driven high when either the $\overline{\text{MR}}$ pin is driven to a logic low or VDD voltage falls below the negative voltage threshold ($V_{\text{IT-}}$). RESET remains high (asserted) for the delay time period (t_{D}) after both $\overline{\text{MR}}$ is floating or above $V_{\overline{\text{MR_L}}}$ and VDD voltage rise above $V_{\text{IT+}}$.
$\overline{\text{RESET}}$	1	N/A	O	Active-Low Output Reset Signal: This pin is driven logic low when either the $\overline{\text{MR}}$ pin is driven to a logic low or VDD voltage falls below the negative voltage threshold ($V_{\text{IT-}}$). $\overline{\text{RESET}}$ remains low (asserted) for the delay time period (t_{D}) after both $\overline{\text{MR}}$ is floating or above $V_{\overline{\text{MR_L}}}$ and VDD voltage rise above $V_{\text{IT+}}$.
VDD	2	2	I	Input Supply Voltage. TPS3840-Q1 monitors VDD voltage
GND	3	3	–	Ground
$\overline{\text{MR}}$ / NC	4	4	I	Manual Reset. Pull this pin to a logic low ($V_{\overline{\text{MR_L}}}$) to assert a reset signal in the output pin. After the $\overline{\text{MR}}$ pin is left floating or pull to $V_{\overline{\text{MR_H}}}$ the output goes to the nominal state after the reset delay time(t_{D}) expires. $\overline{\text{MR}}$ can be left floating when not in use. NC stands for "No Connection" or floating.
CT	5	5	-	Capacitor Time Delay Pin. The CT pin offers a user-programmable delay time. Connect an external capacitor on this pin to adjust time delay. When not in use leave pin floating for the smallest fixed time delay.

7 Specifications

7.1 Absolute Maximum Ratings

over operating free-air temperature range, unless otherwise noted⁽¹⁾

		MIN	MAX	UNIT
Voltage	VDD	-0.3	12	V
	$\overline{\text{RESET}}$ (TPS3840PL)	-0.3	$V_{\text{DD}} + 0.3$	
	RESET (TPS3840PH)	-0.3	$V_{\text{DD}} + 0.3$	
	$\overline{\text{RESET}}$ (TPS3840DL)	-0.3	12	
	$\overline{\text{MR}}$ ⁽²⁾	-0.3	12	
	CT	-0.3	5.5	
Current	$\overline{\text{RESET}}$ pin and RESET pin		± 70	mA
Temperature ⁽³⁾	Operating junction temperature, T_{J}	-40	150	°C
	Storage, T_{stg}	-65	150	

- (1) Stresses beyond those listed under *Absolute Maximum Rating* may cause permanent damage to the device. These are stress ratings only, which do not imply functional operation of the device at these or any other conditions beyond those indicated under *Recommended Operating Condition*. Exposure to absolute-maximum-rated conditions for extended periods may affect device reliability.
- (2) If the logic signal driving MR is less than V_{DD} , then additional current flows into V_{DD} and out of MR. V_{MR} should not be higher than V_{DD} .
- (3) As a result of the low dissipated power in this device, it is assumed that $T_{\text{J}} = T_{\text{A}}$.

7.2 ESD Ratings

			VALUE	UNIT
$V_{\text{(ESD)}}$	Electrostatic discharge	Human body model (HBM), per ANSI/ESDA/JEDEC JS-001 ⁽¹⁾	± 2000	V
		Charged device model (CDM), per JEDEC specification JESD22-C101 ⁽²⁾	± 750	

- (1) JEDEC document JEP155 states that 500-V HBM allows safe manufacturing with a standard ESD control process.
- (2) JEDEC document JEP157 states that 250-V CDM allows safe manufacturing with a standard ESD control process.

7.3 Recommended Operating Conditions

over operating free-air temperature range (unless otherwise noted)

		MIN	NOM	MAX	UNIT
V_{DD}	Input supply voltage	1.5		10	V
$V_{\overline{\text{RESET}}}$, V_{RESET}	$\overline{\text{RESET}}$ pin and RESET pin voltage	0		10	V
$I_{\overline{\text{RESET}}}$, I_{RESET}	$\overline{\text{RESET}}$ pin and RESET pin current	0		± 5	mA
T_{J}	Junction temperature (free air temperature)	-40		125	°C
$V_{\overline{\text{MR}}}$ ⁽¹⁾	Manual reset pin voltage	0		V_{DD}	V

- (1) If the logic signal driving MR is less than V_{DD} , then additional current flows into V_{DD} and out of MR. V_{MR} should not be higher than V_{DD} .

7.4 Thermal Information

THERMAL METRIC ⁽¹⁾		TPS3840	UNIT
		DBV (SOT23-5)	
		5 PINS	
$R_{\theta\text{JA}}$	Junction-to-ambient thermal resistance	187.5	°C/W
$R_{\theta\text{JC(top)}}$	Junction-to-case (top) thermal resistance	109.2	°C/W
$R_{\theta\text{JB}}$	Junction-to-board thermal resistance	92.8	°C/W
Ψ_{JT}	Junction-to-top characterization parameter	35.4	°C/W
Ψ_{JB}	Junction-to-board characterization parameter	92.5	°C/W
$R_{\theta\text{JC(bot)}}$	Junction-to-case (bottom) thermal resistance	N/A	°C/W

- (1) For more information about traditional and new thermal metrics, see the [Semiconductor and IC Package Thermal Metrics](#) application report.

7.5 Electrical Characteristics

At $1.5\text{ V} \leq V_{DD} \leq 10\text{ V}$, $\overline{\text{MR}} = \text{Open}$, $\overline{\text{RESET}}$ pull-up resistor ($R_{\text{pull-up}}$) = 100 k Ω to VDD, output reset load (C_{LOAD}) = 10 pF and over the operating free-air temperature range – 40°C to 125°C, unless otherwise noted. Typical values are at $T_J = 25^\circ\text{C}$.

PARAMETER		TEST CONDITIONS	MIN	TYP	MAX	UNIT
COMMON PARAMETERS						
V_{DD}	Input supply voltage		1.5		10	V
V_{IT-}	Negative-going input threshold accuracy ⁽¹⁾	-40°C to 125°C	-1.5	1	1.5	%
V_{HYS}	Hysteresis on V_{IT-} pin	$V_{IT-} = 3.1\text{ V to }4.9\text{ V}$	175	200	225	mV
V_{HYS}	Hysteresis on V_{IT-} pin	$V_{IT-} = 1.6\text{ V to }3.0\text{ V}$	75	100	125	mV
I_{DD}	Supply current into VDD pin	$V_{DD} = 1.5\text{ V} < V_{DD} < 10\text{ V}$ $V_{DD} > V_{IT+}$ ⁽²⁾ $T_A = -40^\circ\text{C to }125^\circ\text{C}$		300	700	nA
$V_{\overline{\text{MR}}_L}$	Manual reset logic low input ⁽³⁾				600	mV
$V_{\overline{\text{MR}}_H}$	Manual reset logic high input ⁽³⁾		$0.7V_{DD}$			V
$R_{\overline{\text{MR}}}$	Manual reset internal pull-up resistance			100		k Ω
R_{CT}	CT pin internal resistance		350	500	650	k Ω
TPS3840PL (Push-Pull Active-Low)						
V_{POR}	Power on Reset Voltage ⁽⁴⁾	$V_{OL(max)} = 200\text{ mV}$ $I_{OUT(Sink)} = 200\text{ nA}$			300	mV
V_{OL}	Low level output voltage	$1.5\text{ V} < V_{DD} < 5\text{ V}$ $V_{DD} < V_{IT-}$ $I_{OUT(Sink)} = 2\text{ mA}$			200	mV
V_{OH}	High level output voltage	$1.5\text{ V} < V_{DD} < 5\text{ V}$ $V_{DD} > V_{IT+}$ ⁽²⁾ $I_{OUT(Source)} = 2\text{ mA}$	$0.8V_{DD}$			V
		$5\text{ V} < V_{DD} < 10\text{ V}$ $V_{DD} > V_{IT+}$ ⁽²⁾ $I_{OUT(Source)} = 5\text{ mA}$	$0.8V_{DD}$			V
TPS3840PH (Push-Pull Active-High)						
V_{POR}	Power on Reset Voltage ⁽⁴⁾	$V_{OH}, I_{OUT(Source)} = 500\text{ nA}$			950	mV
V_{OL}	Low level output voltage	$1.5\text{ V} < V_{DD} < 5\text{ V}$ $V_{DD} > V_{IT+}$ ⁽²⁾ $I_{OUT(Sink)} = 2\text{ mA}$			200	mV
		$1.5\text{ V} < V_{DD} < 5\text{ V}$ $V_{DD} > V_{IT+}$ ⁽²⁾ $I_{OUT(Sink)} = 5\text{ mA}$			200	mV
V_{OH}	High level output voltage	$1.5\text{ V} < V_{DD} < 5\text{ V}, V_{DD} < V_{IT-}$, $I_{OUT(Source)} = 2\text{ mA}$	$0.8V_{DD}$			V
TPS3840DL (Open-Drain)						
V_{POR}	Power on Reset Voltage ⁽⁴⁾	$V_{OL(max)} = 0.2\text{ V}$ $I_{OUT(Sink)} = 5.6\text{ uA}$			950	mV
V_{OL}	Low level output voltage	$1.5\text{ V} < V_{DD} < 5\text{ V}$ $V_{DD} < V_{IT-}$ $I_{OUT(Sink)} = 2\text{ mA}$			200	mV
$I_{lkg(OD)}$	Open-Drain output leakage current	$\overline{\text{RESET}}$ pin in High Impedance, $V_{DD} = V_{\text{RESET}} = 5.5\text{ V}$ $V_{IT+} < V_{DD}$			90	nA

(1) V_{IT-} threshold voltage range from 1.6 V to 4.9 V in 100 mV steps, for released versions see Device Voltage Thresholds table.

(2) $V_{IT+} = V_{HYS} + V_{IT-}$.

(3) If the logic signal driving $\overline{\text{MR}}$ is less than VDD, then additional current flows into VDD and out of $\overline{\text{MR}}$.

(4) V_{POR} is the minimum V_{DD} voltage level for a controlled output state. V_{DD} slew rate $\leq 100\text{ mV}/\mu\text{s}$.

7.6 Timing Requirements

At $1.5\text{ V} \leq V_{DD} \leq 10\text{ V}$, $\overline{MR} = \text{Open}$, \overline{RESET} pull-up resistor ($R_{\text{pull-up}} = 100\text{ k}\Omega$ to V_{DD} , output reset load ($C_{\text{LOAD}} = 10\text{ pF}$ and over the operating free-air temperature range -40°C to 125°C , V_{DD} slew rate $< 100\text{ mV} / \mu\text{s}$, unless otherwise noted. Typical values are at $T_J = 25^\circ\text{C}$.

PARAMETER		TEST CONDITIONS	MIN	TYP	MAX	UNIT
t_{STRT}	Startup Delay ⁽¹⁾	CT pin open	100	220	350	μs
$t_{\text{P_HL}}$	Propagation detect delay for V_{DD} falling below $V_{\text{IT-}}$	$V_{DD} = V_{\text{IT+}}$ to $(V_{\text{IT-}}) - 10\%$ ⁽²⁾		15	30	μs
t_{D}	Reset time delay	CT pin = open			50	μs
		CT pin = 10 nF		6.2		ms
		CT pin = 1 μF		619		ms
$t_{\text{GL_VIT-}}$	Glitch immunity $V_{\text{IT-}}$	5% $V_{\text{IT-}}$ overdrive ⁽³⁾		10		μs
$t_{\text{MR_PW}}$	\overline{MR} pin pulse duration to initiate reset			300		ns
$t_{\text{MR_RES}}$	Propagation delay from \overline{MR} low to reset	$V_{DD} = 4.5\text{ V}$, $\overline{MR} < V_{\text{MR_L}}$		700		ns
$t_{\text{MR_ID}}$	Delay from release \overline{MR} to deassert reset	$V_{DD} = 4.5\text{ V}$, $\overline{MR} = V_{\text{MR_L}}$ to $V_{\text{MR_H}}$		t_{D}		ms

- (1) When V_{DD} starts from less than the specified minimum V_{DD} and then exceeds $V_{\text{IT+}}$, reset is release after the startup delay (t_{STRT}), a capacitor at CT pin will add t_{D} delay to t_{STRT} time
- (2) $t_{\text{P_HL}}$ measured from threshold trip point ($V_{\text{IT-}}$) to V_{OL} for active low variants and V_{OH} for active high variants.
- (3) Overdrive % = $[(V_{DD} / V_{\text{IT-}}) - 1] \times 100\%$

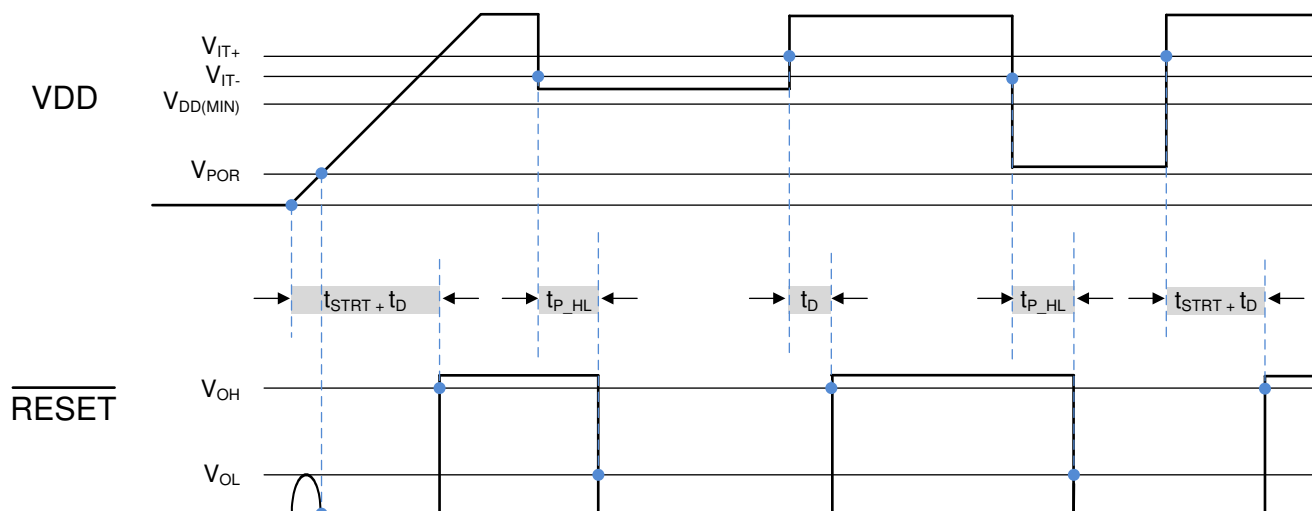

- (1) $t_{\text{D (no cap)}}$ is included in t_{STRT} time delay. If t_{D} delay is programmed by an external capacitor connected to CT pin then t_{D} programmed time will be added to the startup time, V_{DD} slew rate = $100\text{ mV} / \mu\text{s}$.
- (2) Open-Drain timing diagram assumes pull-up resistor is connected to \overline{RESET}

图 3. Timing Diagram TPS3840DL-Q1 (Open-Drain Active-Low)



- (3) $t_{D (no\ cap)}$ is included in t_{STRT} time delay. If t_D delay is programmed by an external capacitor connected to CT pin, then t_D programmed time will be added to the startup time. VDD slew rate = 100 mV / μ s.

图 4. Timing Diagram TPS3840PL-Q1 (Push-Pull Active-Low)

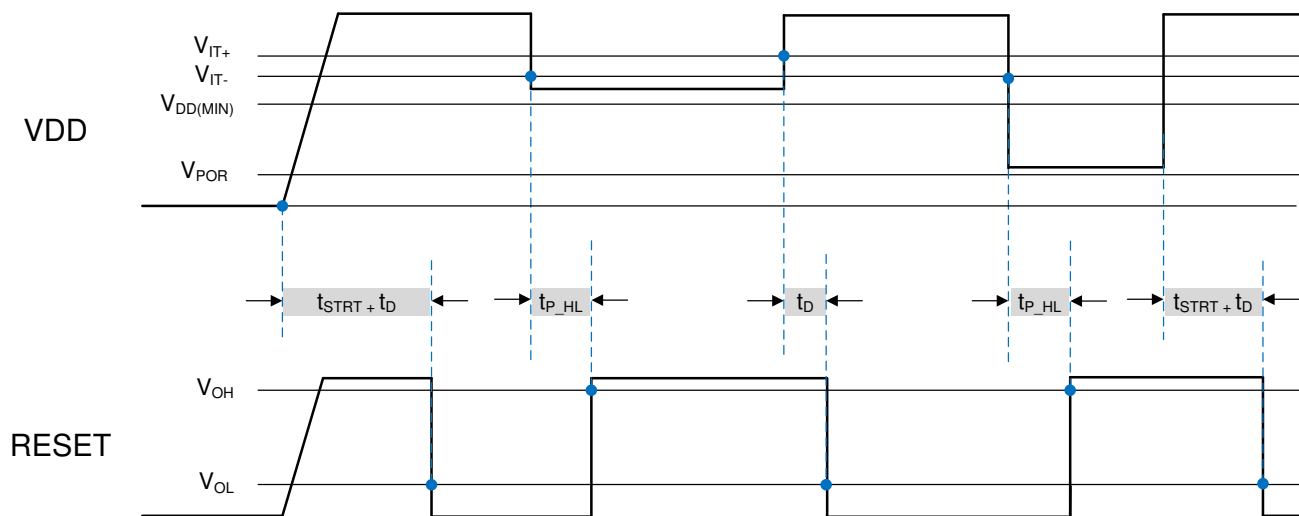

- (4) $t_{D (no\ cap)}$ is included in t_{STRT} time delay. If t_D delay is programmed by an external capacitor connected to CT pin, then t_D programmed time will be added to the total startup time. VDD slew rate = 100 mV / μ s.

图 5. Timing Diagram TPS3840PH-Q1 (Push-Pull Active-High)

7.7 Typical Characteristics

Typical characteristics show the typical performance of the TPS3840-Q1 device. Test conditions are $T_J = 25^\circ\text{C}$, $V_{DD} = 3.3\text{ V}$, $R_{\text{pull-up}} = 100\text{ k}\Omega$, $C_{\text{Load}} = 50\text{ pF}$, unless otherwise noted.



图 6. Supply Current vs Supply Voltage for TPS3840DL49-Q1



图 7. Supply Current vs Supply Voltage for TPS3840PL49-Q1

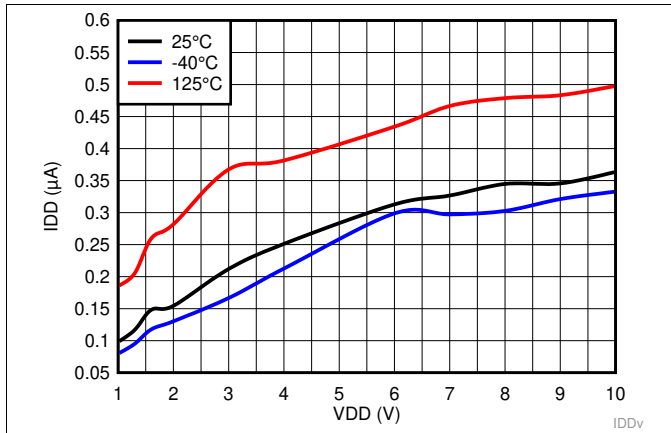

图 8. Supply Current vs Supply Voltage for TPS3840PH49-Q1

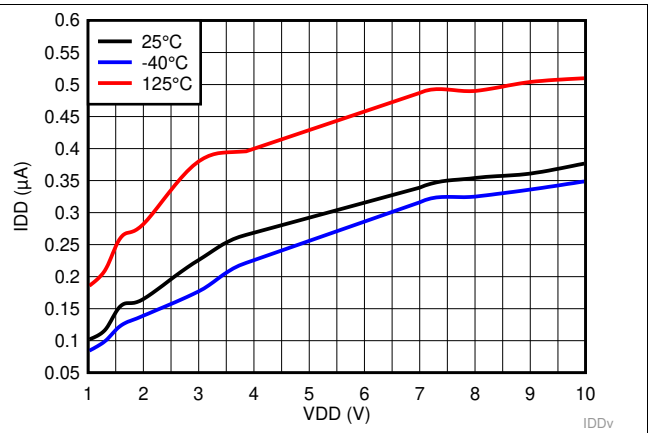

图 9. Negative-going Input Threshold Accuracy over Temperature for TPS3840DL-Q1

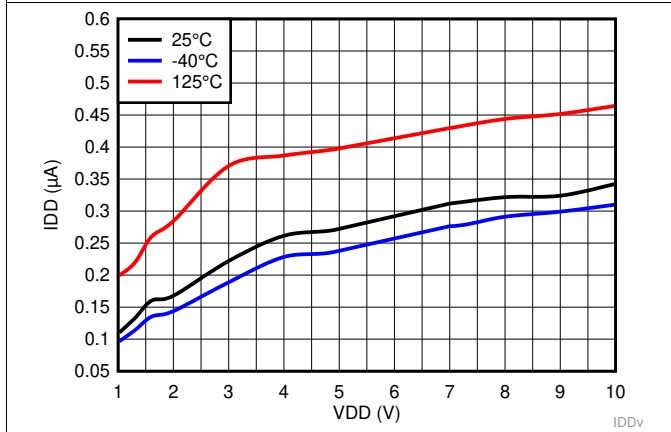

图 10. Negative-going Input Threshold Accuracy over Temperature for TPS3840PL-Q1

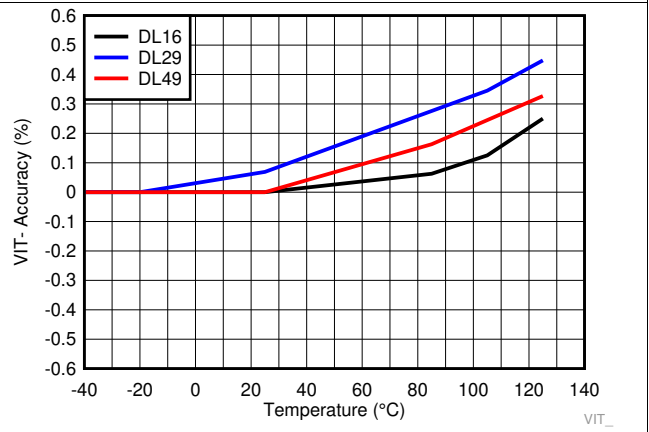

图 11. Negative-going Input Threshold Accuracy over Temperature for TPS3840PH-Q1

Typical Characteristics (接下页)

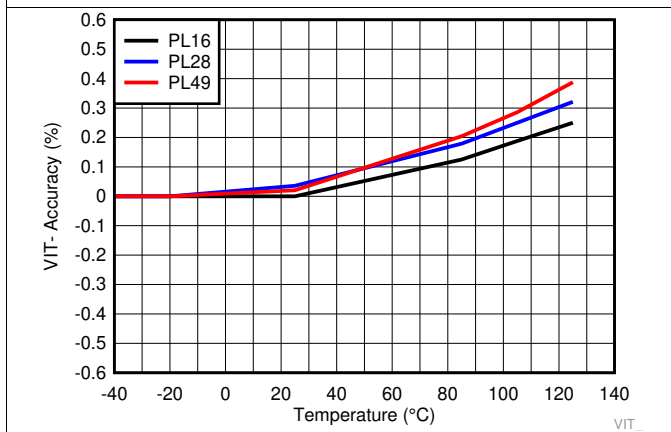
Typical characteristics show the typical performance of the TPS3840-Q1 device. Test conditions are $T_J = 25^\circ\text{C}$, $V_{DD} = 3.3\text{ V}$, $R_{\text{pull-up}} = 100\text{ k}\Omega$, $C_{\text{Load}} = 50\text{ pF}$, unless otherwise noted.

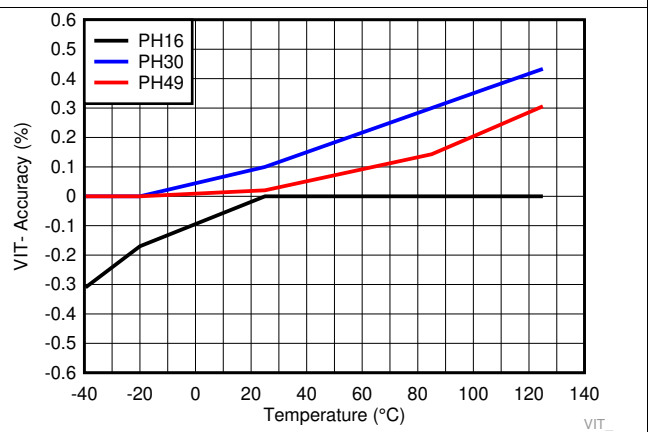
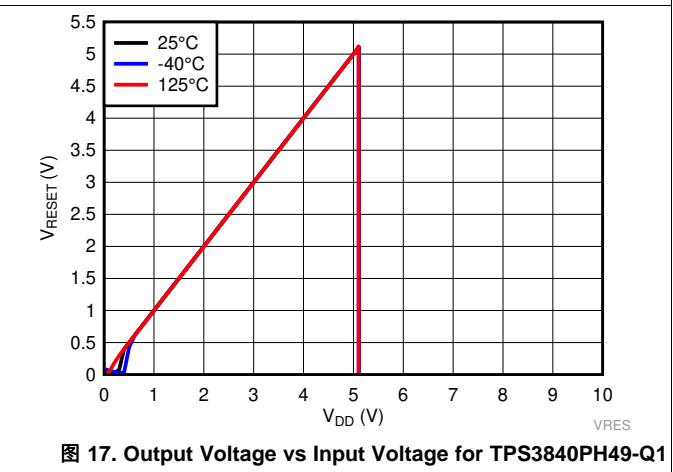
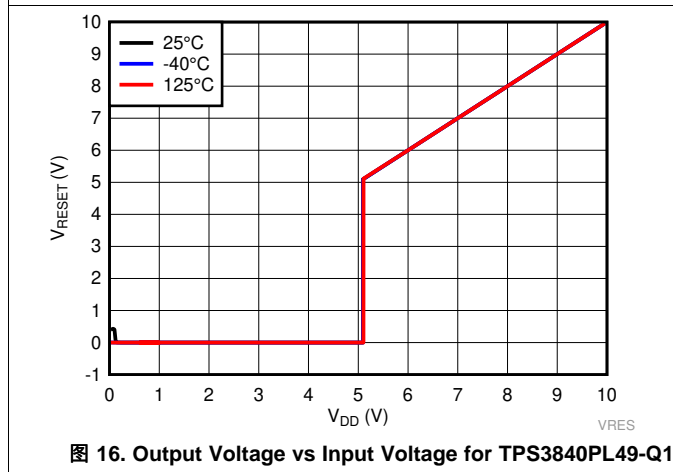
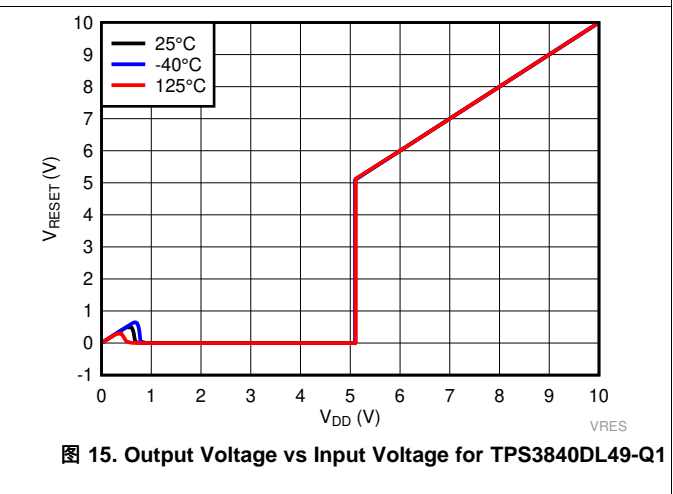
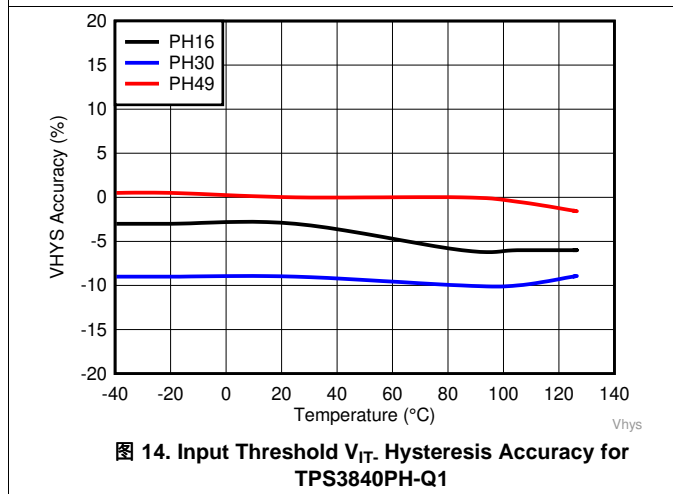
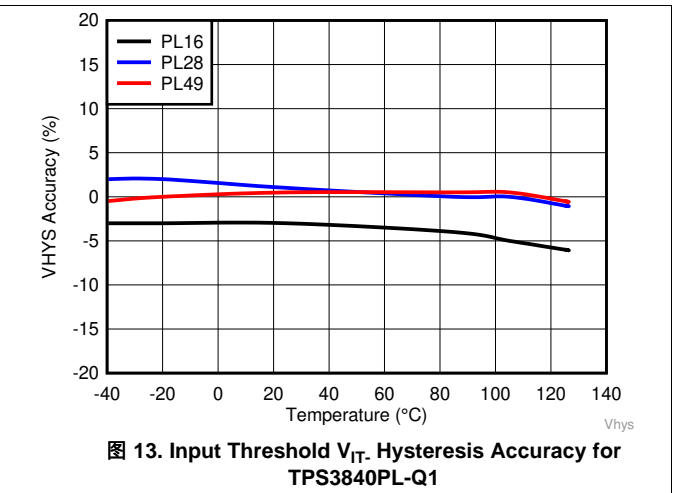
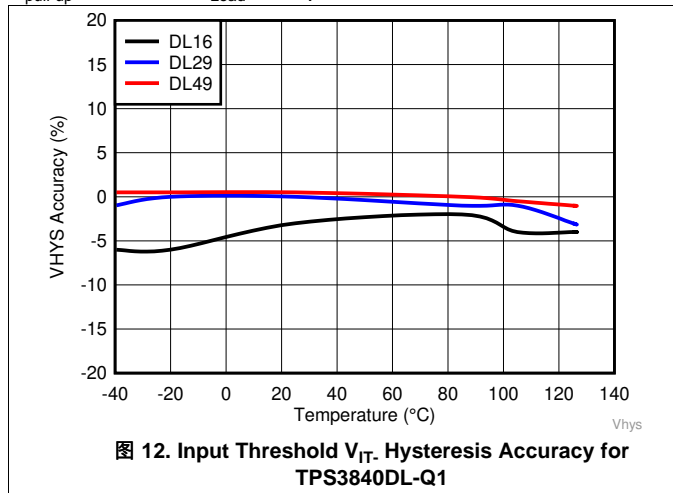

Typical Characteristics (接下页)

Typical characteristics show the typical performance of the TPS3840-Q1 device. Test conditions are $T_J = 25^\circ\text{C}$, $V_{DD} = 3.3\text{ V}$, $R_{\text{pull-up}} = 100\text{ k}\Omega$, $C_{\text{Load}} = 50\text{ pF}$, unless otherwise noted.



图 18. Low Level Output Voltage vs I_{RESET} for TPS3840DL49-Q1



图 19. Low Level Output Voltage vs V_{DD} for TPS3840DL49-Q1

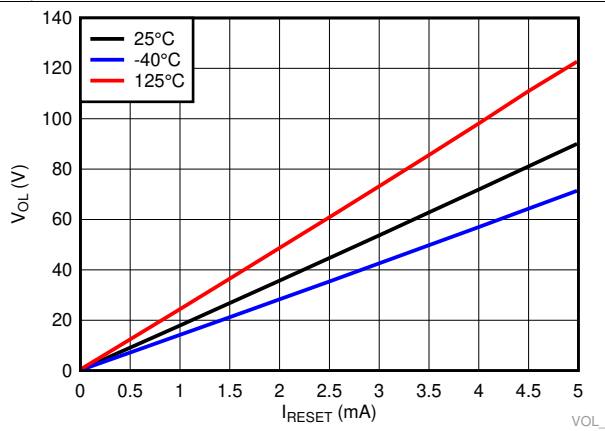

图 20. Low Level Output Voltage vs I_{RESET} for TPS3840PL49-Q1

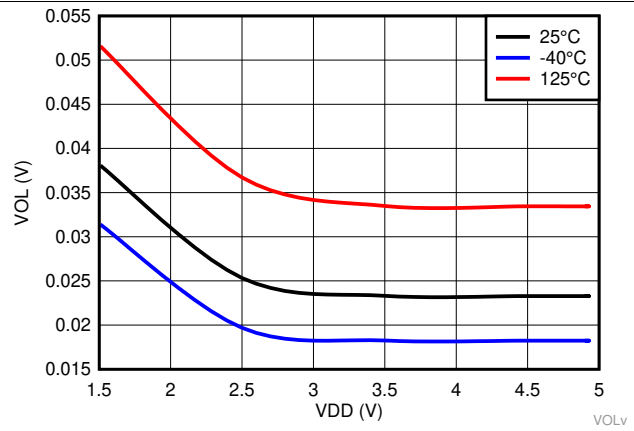

图 21. Low Level Output Voltage vs V_{DD} for TPS3840PL49-Q1

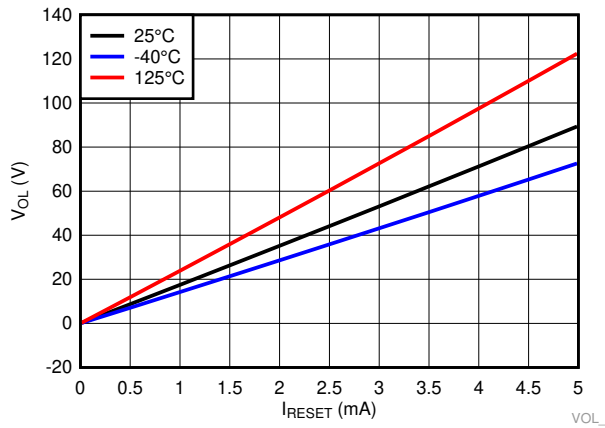

图 22. Low Level Output Voltage vs I_{RESET} for TPS3840PH49-Q1

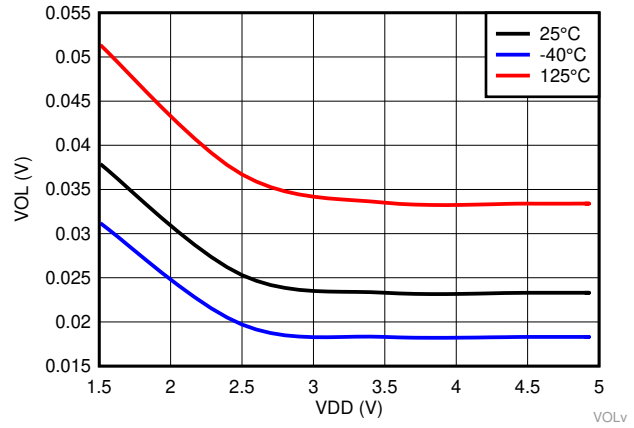

图 23. Low Level Output Voltage vs V_{DD} for TPS3840PH49-Q1

Typical Characteristics (接下页)

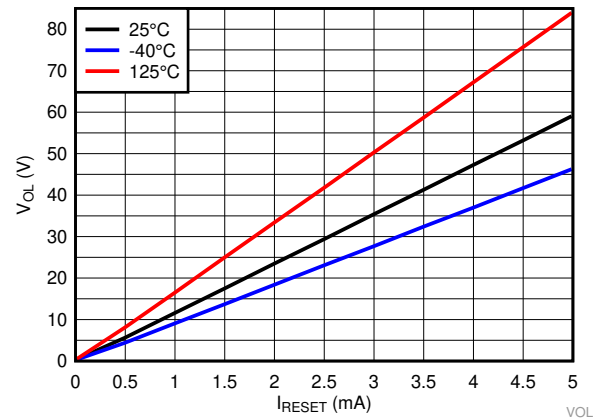
Typical characteristics show the typical performance of the TPS3840-Q1 device. Test conditions are $T_J = 25^\circ\text{C}$, $V_{DD} = 3.3\text{ V}$, $R_{\text{pull-up}} = 100\text{ k}\Omega$, $C_{\text{Load}} = 50\text{ pF}$, unless otherwise noted.

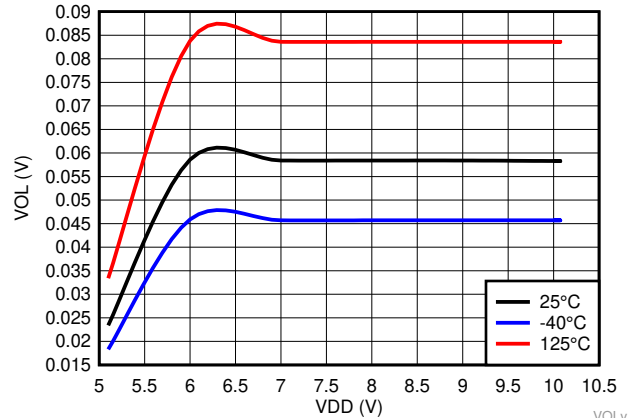

图 24. High Level Output Voltage vs I_{RESET} for TPS3840PL49-Q1



图 25. High Level Output Voltage over Temperature for TPS3840PL49-Q1



图 26. High Level Output Voltage vs I_{RESET} for TPS3840PH49-Q1

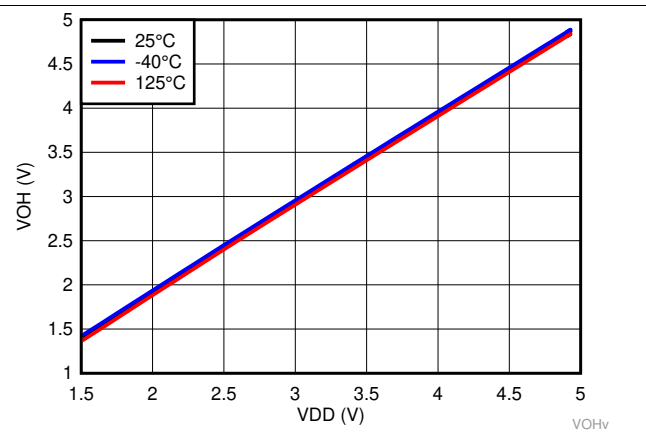

图 27. High Level Output Voltage over Temperature for TPS3840PH49-Q1

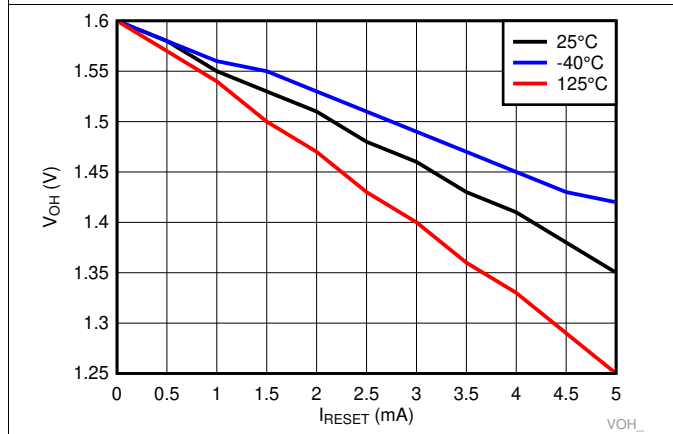

图 28. Manual Reset Logic Low Voltage Threshold Over Temperature for TPS3840DL-Q1

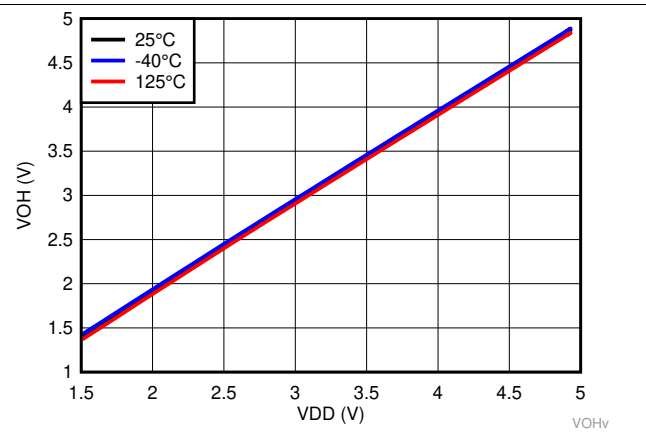

图 29. Manual Reset Logic Low Voltage Threshold Over Temperature for TPS3840PL-Q1

Typical Characteristics (接下页)

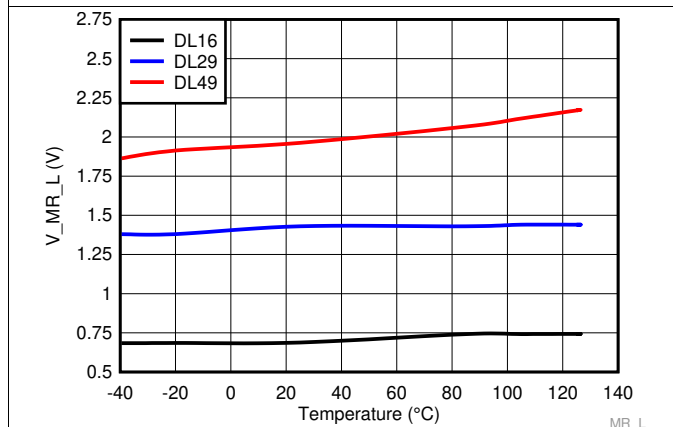
Typical characteristics show the typical performance of the TPS3840-Q1 device. Test conditions are $T_J = 25^\circ\text{C}$, $V_{DD} = 3.3\text{ V}$, $R_{\text{pull-up}} = 100\text{ k}\Omega$, $C_{\text{Load}} = 50\text{ pF}$, unless otherwise noted.

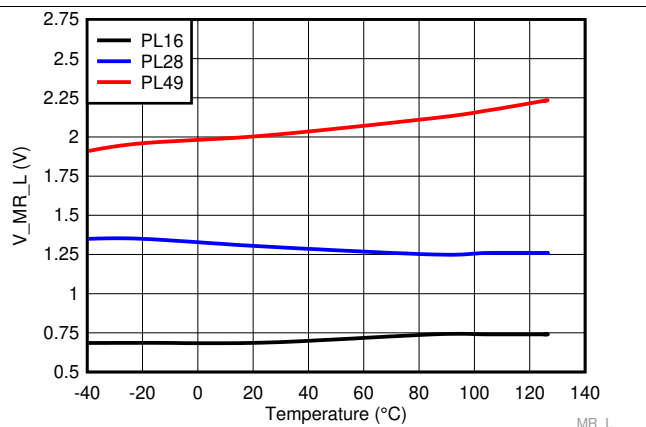
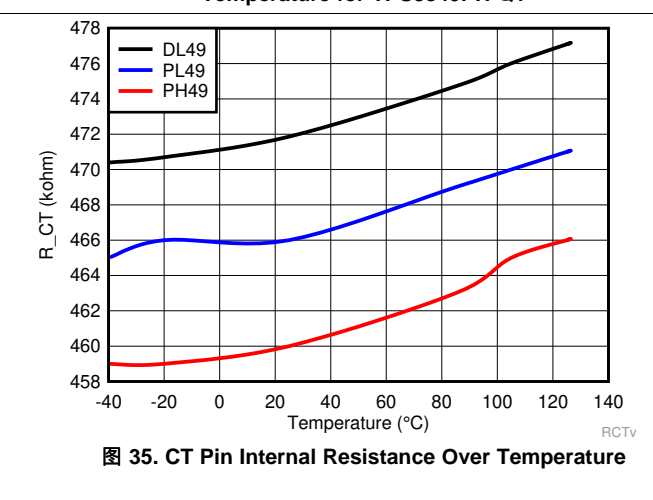
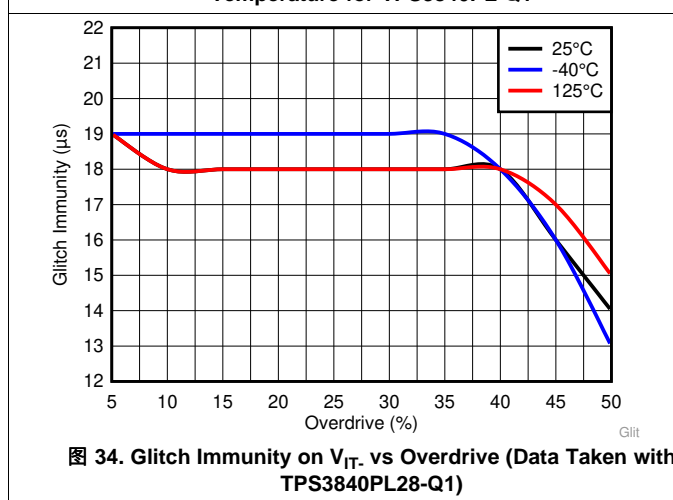
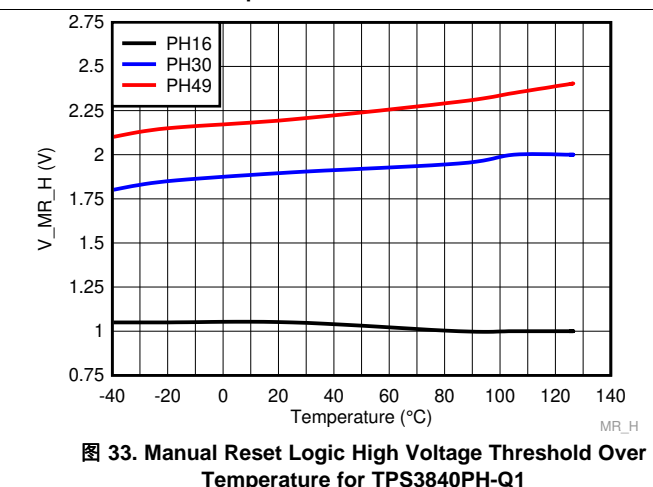
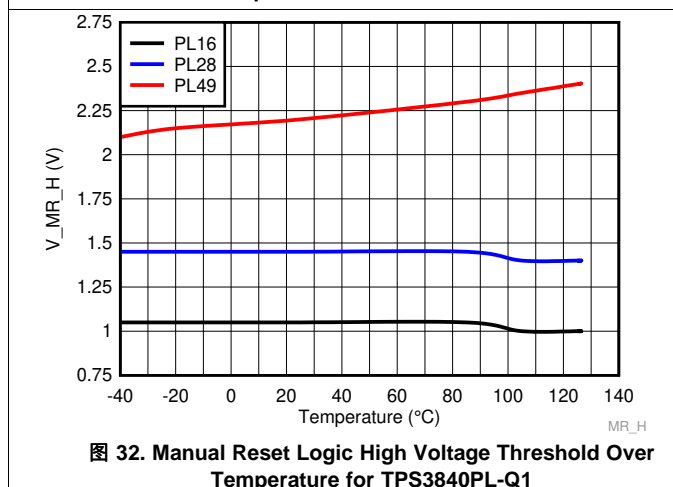
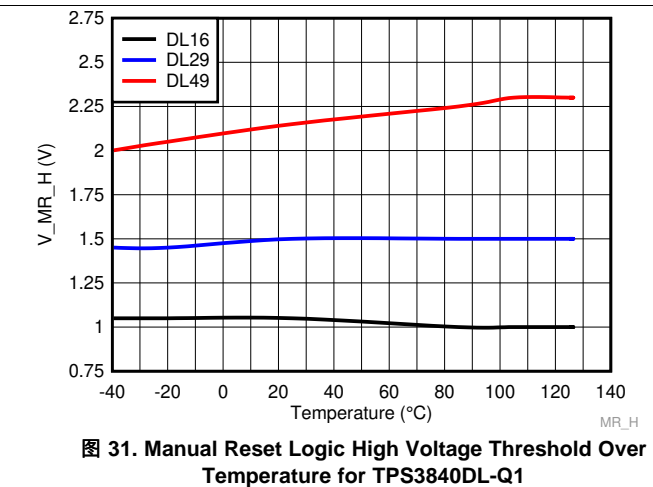
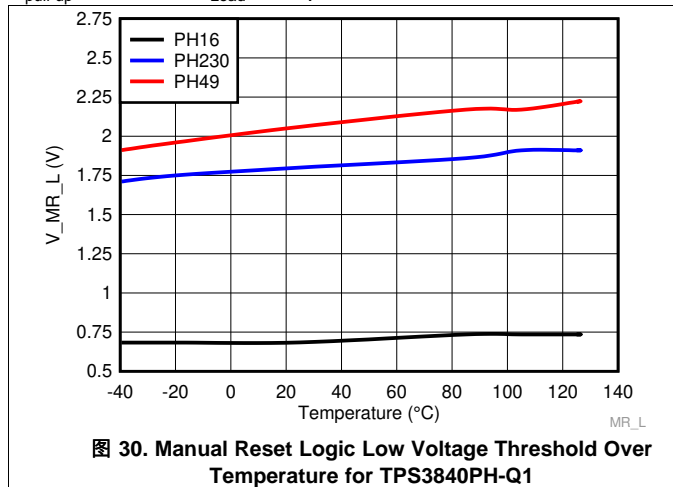

Typical Characteristics (接下页)

Typical characteristics show the typical performance of the TPS3840-Q1 device. Test conditions are $T_J = 25^\circ\text{C}$, $V_{DD} = 3.3\text{ V}$, $R_{\text{pull-up}} = 100\text{ k}\Omega$, $C_{\text{Load}} = 50\text{ pF}$, unless otherwise noted.

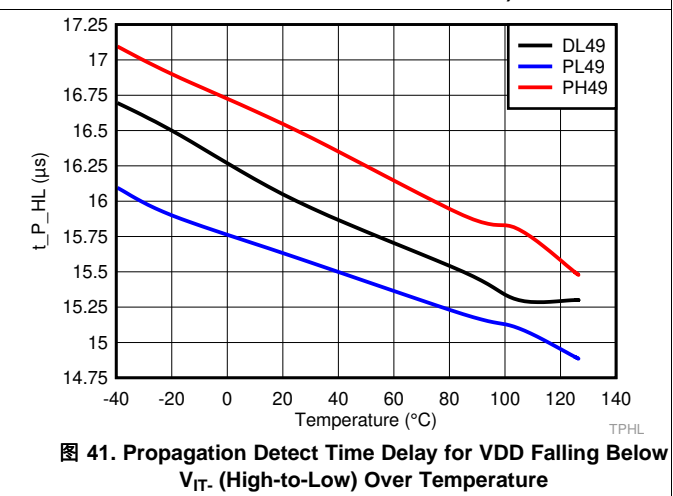
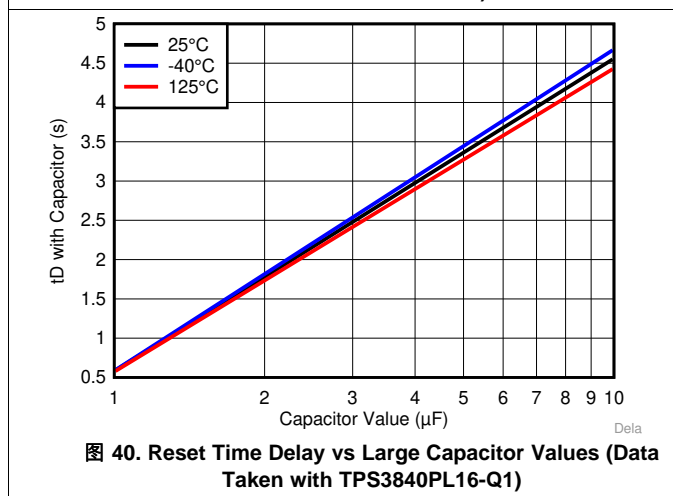
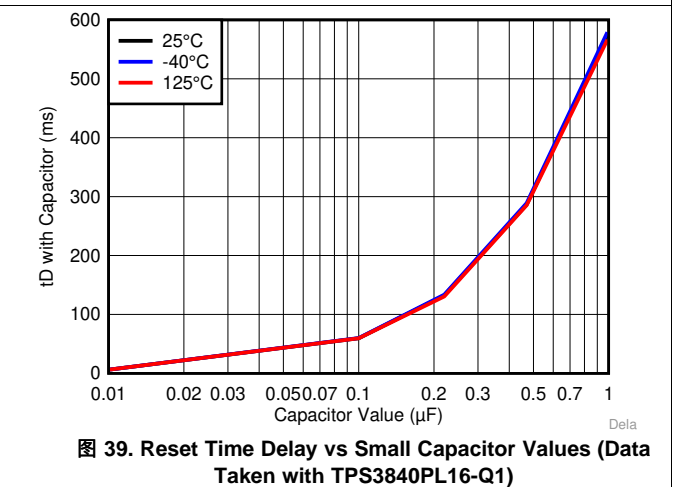
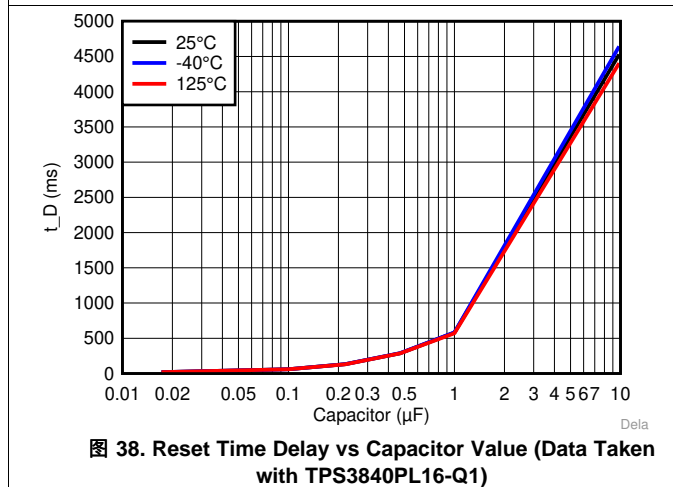
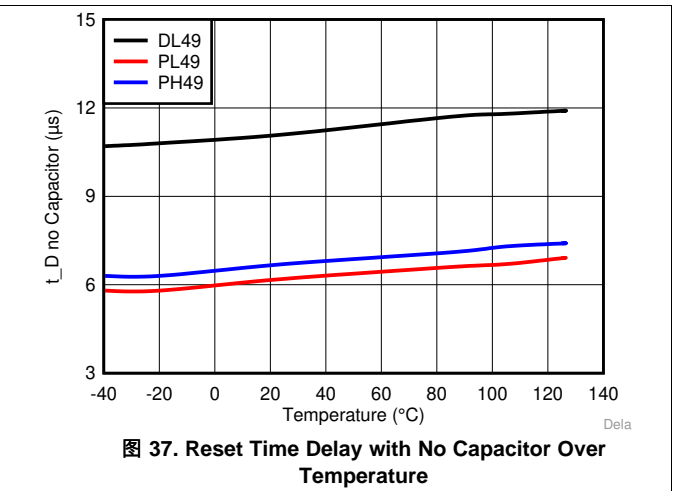
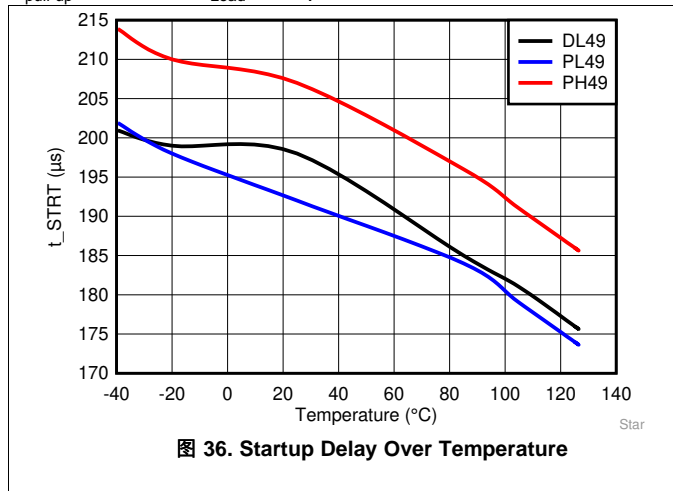

Typical Characteristics (接下页)

Typical characteristics show the typical performance of the TPS3840-Q1 device. Test conditions are $T_J = 25^\circ\text{C}$, $V_{DD} = 3.3\text{ V}$, $R_{\text{pull-up}} = 100\text{ k}\Omega$, $C_{\text{Load}} = 50\text{ pF}$, unless otherwise noted.

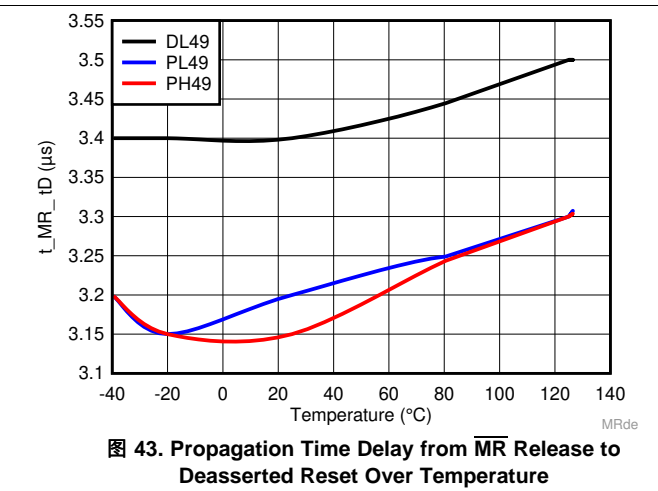
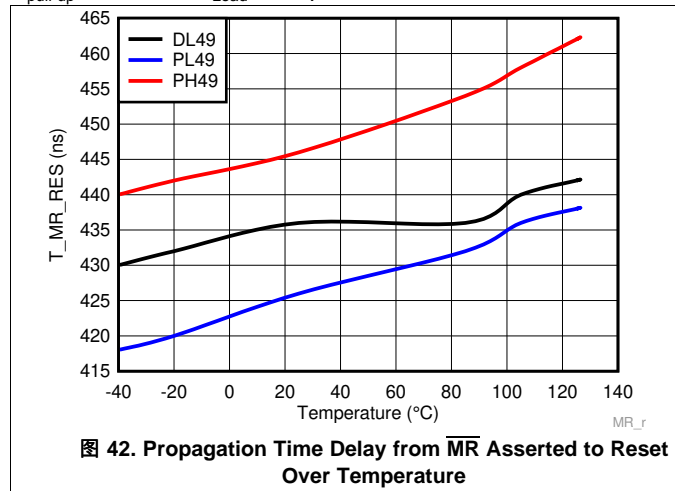

8 Detailed Description

8.1 Overview

The TPS3840-Q1 is a family of wide VDD and nano-quiescent current voltage detectors with fixed threshold voltage. TPS3840-Q1 features include programmable reset time delay using external capacitor, active-low manual reset, 1% typical monitor threshold accuracy with hysteresis and glitch immunity.

Fixed negative threshold voltages (V_{IT-}) can be factory set from 1.6 V to 4.9 V (see 表 3 for available options). TPS3840-Q1 is available in SOT-23 5 pin industry standard package.

8.2 Functional Block Diagram

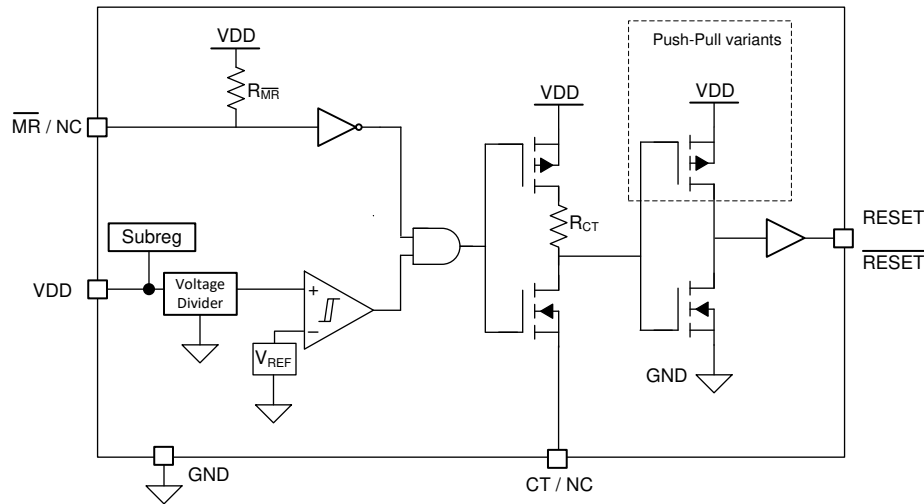

Copyright © 2019, Texas Instruments Incorporated

8.3 Feature Description

8.3.1 Input Voltage (VDD)

VDD pin is monitored by the internal comparator to indicate when VDD falls below the fixed threshold voltage. VDD also functions as the supply for the internal bandgap, internal regulator, state machine, buffers and other control logic blocks. Good design practice involve placing a 0.1 uF to 1 uF bypass capacitor at VDD input for noisy applications to ensure enough charge is available for the device to power up correctly.

Feature Description (接下页)

8.3.1.1 VDD Hysteresis

The internal comparator has built-in hysteresis to avoid erroneous output reset release. If the voltage at the VDD pin falls below V_{IT-} , the output reset is asserted. When the voltage at the VDD pin goes above V_{IT-} plus hysteresis (V_{HYS}) the output reset is deasserted after t_D delay.



图 44. Hysteresis Diagram

8.3.1.2 VDD Transient Immunity

The TPS3840-Q1 is immune to quick voltage transients or excursion on VDD. Sensitivity to transients depends on both pulse duration and overdrive. Overdrive is defined by how much VDD deviates from the specified threshold. Threshold overdrive is calculated as a percent of the threshold in question, as shown in 公式 1.

$$\text{Overdrive} = | (V_{DD} / V_{IT-} - 1) \times 100\% | \quad (1)$$



图 45. Overdrive vs Pulse Duration

8.3.2 User-Programmable Reset Time Delay

The reset time delay can be set to a minimum value of 50 μs by leaving the CT pin floating, or a maximum value of approximately 6.2 seconds by connecting 10 μF delay capacitor. The reset time delay (t_D) can be programmed by connecting a capacitor no larger than 10 μF between CT pin and GND.

The relationship between external capacitor (C_{CT_EXT}) in F at CT pin and the time delay (t_D) in seconds is given by 公式 2.

$$t_D = -\ln(0.29) \times R_{CT} \times C_{CT_EXT} + t_D(\text{no cap}) \quad (2)$$

公式 2 is simplified to 公式 3 by plugging R_{CT} and $t_D(\text{no cap})$ given in [Electrical Characteristics](#) section:

$$t_D = 618937 \times C_{CT_EXT} + 50 \mu\text{s} \quad (3)$$

公式 4 solves for external capacitor value (C_{CT_EXT}) in units of F where t_D is in units of seconds

$$C_{CT_EXT} = (t_D - 50 \mu\text{s}) \div 618937 \quad (4)$$

The reset delay varies according to three variables: the external capacitor variance (C_{CT}), CT pin internal resistance (R_{CT}) provided in the [Electrical Characteristics](#) table, and a constant. The minimum and maximum variance due to the constant is shown in [Equation 5](#) and [Equation 6](#).

$$s t_D(\text{minimum}) = -\ln(0.36) \times R_{CT(\text{min})} \times C_{CT(\text{min})} + t_D(\text{no cap, min}) \quad (5)$$

$$t_D(\text{maximum}) = -\ln(0.26) \times R_{CT(\text{max})} \times C_{CT(\text{max})} + t_D(\text{no cap, max}) \quad (6)$$

Feature Description (接下页)

The recommended maximum delay capacitor for the TPS3840 is limited to 10 μF as this ensures there is enough time for the capacitor to fully discharge when the reset condition occurs. When a voltage fault occurs, the previously charged up capacitor discharges, and if the monitored voltage returns from the fault condition before the delay capacitor discharges completely, the delay capacitor will begin charging from a voltage above zero and the reset delay will be shorter than expected. Larger delay capacitors can be used so long as the capacitor has enough time to fully discharge during the duration of the voltage fault.

8.3.3 Manual Reset ($\overline{\text{MR}}$) Input

The manual reset ($\overline{\text{MR}}$) input allows a processor GPIO or other logic circuits to initiate a reset. A logic low on $\overline{\text{MR}}$ with pulse duration longer than $t_{\overline{\text{MR_RES}}}$ will causes reset output to assert. After $\overline{\text{MR}}$ returns to a logic high ($V_{\overline{\text{MR_H}}}$) and VDD is above $V_{\text{IT+}}$, reset is deasserted after the user programmed reset time delay (t_{D}) expires.

If $\overline{\text{MR}}$ is not controlled externally, then $\overline{\text{MR}}$ can be left disconnected. If the logic signal controlling $\overline{\text{MR}}$ is less than VDD, then additional current flows from VDD into $\overline{\text{MR}}$ internally. For minimum current consumption, drive $\overline{\text{MR}}$ to either VDD or GND. $V_{\overline{\text{MR}}}$ must not be higher than VDD voltage.



图 46. Timing Diagram $\overline{\text{MR}}$ and $\overline{\text{RESET}}$ (TPS3840DL-Q1)

8.3.4 Output Logic

8.3.4.1 $\overline{\text{RESET}}$ Output, Active-Low

$\overline{\text{RESET}}$ (Active-Low) applies to TPS3840DL-Q1 (Open-Drain) and TPS3840PL-Q1 (Push-Pull) hence the "L" in the device name. $\overline{\text{RESET}}$ remains high (deasserted) as long as VDD is above the negative threshold ($V_{\text{IT-}}$) and the $\overline{\text{MR}}$ pin is floating or above $V_{\overline{\text{MR_H}}}$. If VDD falls below the negative threshold ($V_{\text{IT-}}$) or if MR is driven low, then $\overline{\text{RESET}}$ is asserted.

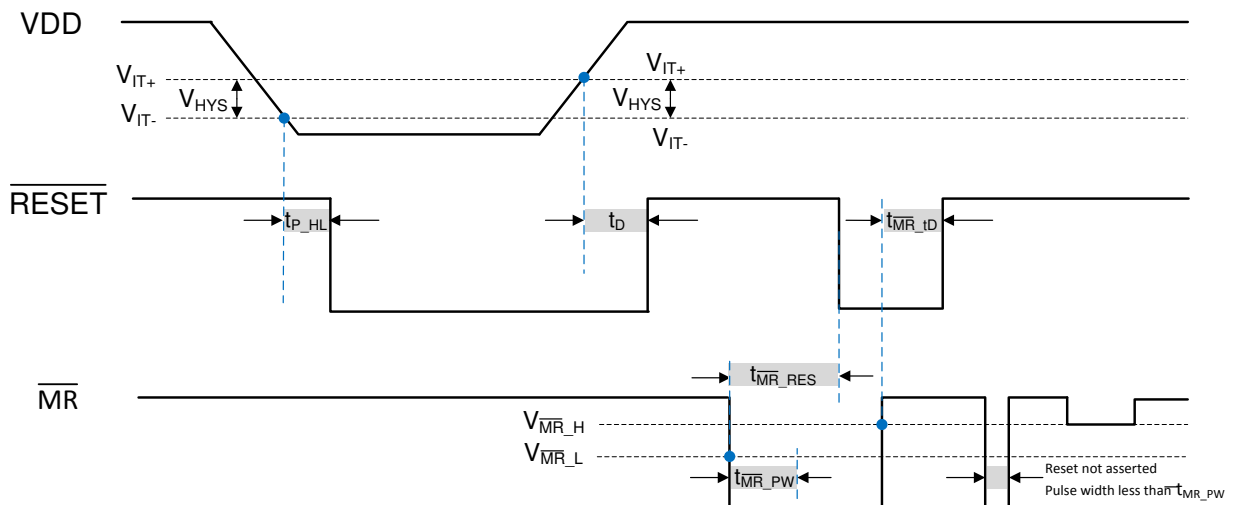
When $\overline{\text{MR}}$ is again logic high or floating and VDD rise above $V_{\text{IT+}}$, the delay circuit will hold $\overline{\text{RESET}}$ low for the specified reset time delay (t_{D}). When the reset time delay has elapsed, the $\overline{\text{RESET}}$ pin goes back to logic high voltage (V_{OH}).

The TPS3840DL-Q1 (Open-Drain) version, denoted with "D" in the device name, requires a pull-up resistor to hold $\overline{\text{RESET}}$ pin high. Connect the pull-up resistor to the desired pull-up voltage source and $\overline{\text{RESET}}$ can be pulled up to any voltage up to 10 V independent of the VDD voltage. To ensure proper voltage levels, give some consideration when choosing the pull-up resistor values. The pull-up resistor value determines the actual V_{OL} , the output capacitive loading, and the output leakage current ($I_{\text{LKG(OD)}}$).

The Push-Pull variants (TPS3840PL and TPS3840PH), denoted with "P" in the device name, does not require a pull-up resistor.

Feature Description (接下页)

8.3.4.2 RESET Output, Active-High

RESET (active-high), denoted with no bar above the pin label, applies only to TPS3840PH-Q1 push-pull active-high version. RESET remains low (deasserted) as long as VDD is above the threshold (V_{IT-}) and the manual reset signal (MR) is logic high or floating. If VDD falls below the negative threshold (V_{IT-}) or if MR is driven low, then RESET is asserted driving the RESET pin to high voltage (V_{OH}).

When \overline{MR} is again logic high and VDD is above V_{IT+} , the delay circuit will hold RESET high for the specified reset time delay (t_D). When the reset time delay has elapsed, the RESET pin goes back to low voltage (V_{OL}).

8.4 Device Functional Modes

表 1 summarizes the various functional modes of the device. Logic high is represented by "H" and logic low is represented by "L".

表 1. Truth Table

VDD	\overline{MR}	RESET	\overline{RESET}
$VDD < V_{POR}$	Ignored	Undefined	Undefined
$V_{POR} < VDD < V_{IT-}^{(1)}$	Ignored	H	L
$VDD \geq V_{IT-}$	L	H	L
$VDD \geq V_{IT-}$	H	L	H
$VDD \geq V_{IT-}$	Floating	L	H

(1) When V_{DD} falls below $V_{DD(MIN)}$, undervoltage-lockout (UVLO) takes effect and output reset is held asserted until V_{DD} falls below V_{POR} .

8.4.1 Normal Operation ($V_{DD} > V_{DD(min)}$)

When VDD is greater than $V_{DD(min)}$, the reset signal is determined by the voltage on the VDD pin with respect to the trip point (V_{IT-}) and the logic state of \overline{MR} .

- \overline{MR} high: the reset signal corresponds to VDD with respect to the threshold voltage.
- \overline{MR} low: in this mode, the reset is asserted regardless of the threshold voltage.

8.4.2 VDD Between VPOR and $V_{DD(min)}$

When the voltage on VDD is less than the $V_{DD(min)}$ voltage, and greater than the power-on-reset voltage (V_{POR}), the reset signal is asserted.

8.4.3 Below Power-On-Reset ($V_{DD} < V_{POR}$)

When the voltage on VDD is lower than V_{POR} , the device does not have enough bias voltage to internally pull the asserted output low or high and reset voltage level is undefined.

9 Application and Implementation

注

Information in the following applications sections is not part of the TI component specification, and TI does not warrant its accuracy or completeness. TI's customers are responsible for determining suitability of components for their purposes. Customers should validate and test their design implementation to confirm system functionality.

9.1 Application Information

The following sections describe in detail how to properly use this device, depending on the requirements of the final application.

9.2 Typical Application

9.2.1 Design 1: Dual Rail Monitoring with Power-Up Sequencing

A typical application for the TPS3840-Q1 is voltage rail monitoring and power-up sequencing as shown in 图 47. The TPS3840-Q1 can be used to monitor any rail above 1.6 V. In this design application, two TPS3840-Q1 devices monitor two separate voltage rails and sequences the rails upon power-up. The TPS3840PL30-Q1 is used to monitor the 3.3-V main power rail and the TPS3840DL16-Q1 is used to monitor the 1.8-V rail provided by the LDO for other system peripherals. The RESET output of the TPS3840PL30-Q1 is connected to the ENABLE input of the LDO. A reset event is initiated on either voltage supervisor when the VDD voltage is less than V_{IT} , or when MR is driven low by an external source.



图 47. TPS3840-Q1 Voltage Rail Monitor and Power-Up Sequencer Design Block Diagram

9.2.1.1 Design Requirements

This design requires voltage supervision on two separate rails: 3.3-V and 1.8-V rails. The voltage rail needs to sequence upon power up with the 3.3-V rail coming up first followed by the 1.8-V rail at least 25 ms after.

PARAMETER	DESIGN REQUIREMENT	DESIGN RESULT
Two Rail Voltage Supervision	Monitor 3.3-V and 1.8-V rails	Two TPS3840-Q1 devices provide voltage monitoring with 1% accuracy with device options available in 0.1 V variations
Voltage Rail Sequencing	Power up the 3.3-V rail first followed by 1.8-V rail 25 ms after	The CT capacitor on TPS38240PL28 is set to 0.047 μF for a reset time delay of 29 ms typical
Output logic voltage	3.3-V Open-Drain	3.3-V Open-Drain
Maximum device current consumption	1 μA	Each TPS3840-Q1 requires 350 nA typical

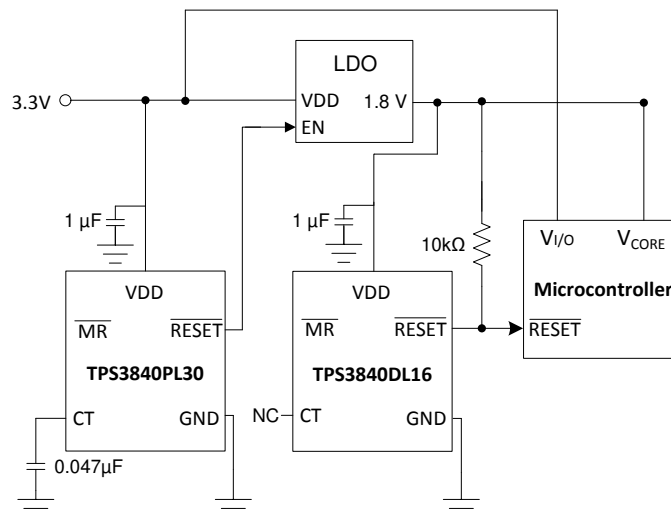
9.2.1.2 Detailed Design Procedure

The primary constraint for this application is choosing the correct device to monitor the supply voltage of the microprocessor. The TPS3840-Q1 can monitor any voltage between 1.6 V and 10 V and is available in 0.1 V increments. Depending on how far away from the nominal voltage rail the user wants the voltage supervisor to trigger determines the correct voltage supervisor variant to choose. In this example, the first TPS3840-Q1 triggers when the 3.3-V rail falls to 3.0 V. The second TPS3840-Q1 triggers a reset when the 1.8-V rail falls to 1.6 V. The secondary constraint for this application is the reset time delay that must be at least 25 ms to allow the microprocessor, and all other devices using the 3.3-V rail, enough time to startup correctly before the 1.8-V rail is enabled via the LDO. Because a minimum time is required, the user must account for capacitor tolerance. For applications with ambient temperatures ranging from -40°C to $+125^{\circ}\text{C}$, C_{CT} can be calculated using R_{CT} and solving for C_{CT} in 公式 2. Solving 公式 2 for 25 ms gives a minimum capacitor value of $0.04 \mu\text{F}$ which is rounded up to a standard value $0.047 \mu\text{F}$ to account for capacitor tolerance.

A $1\text{-}\mu\text{F}$ decoupling capacitor is connected to the VDD pin as a good analog design practice. The pull-up resistor is only required for the Open-Drain device variants and is calculated to maintain the $\overline{\text{RESET}}$ current within the $\pm 5\text{ mA}$ limit found in the *Recommended Operating Conditions*: $R_{\text{Pull-up}} = V_{\text{Pull-up}} \div 5\text{ mA}$. For this design, a standard $10\text{-k}\Omega$ pull-up resistor is selected to minimize current draw when $\overline{\text{RESET}}$ is asserted. Keep in mind the lower the pull-up resistor, the higher V_{OL} . The $\overline{\text{MR}}$ pin can be connected to an external signal if desired or left floating if not used due to the internal pull-up resistor to VDD.

9.2.1.3 Application Curves



图 48. Startup Sequence Highlighting the Delay Between 3.3V and 1.8V Rails

9.2.2 Design 2: Automotive Off-Battery Monitoring

The initial power stage in automotive applications starts with the 12 V battery. Variation of the battery voltage is common between 9 V and 16 V. Furthermore, if cold-cranking and load dump conditions are considered, voltage transients can occur as low as 3 V and as high as 42V. In this design example, we are highlighting the ability for low power, direct off-battery voltage supervision. [图 49](#) illustrates an example of how the TPS3840-Q1 is monitoring the battery voltage while being powered by it as well. For more information, read this [application report](#) on how to achieve nano-amp I_Q voltage supervision in automotive, wide-vin applications.

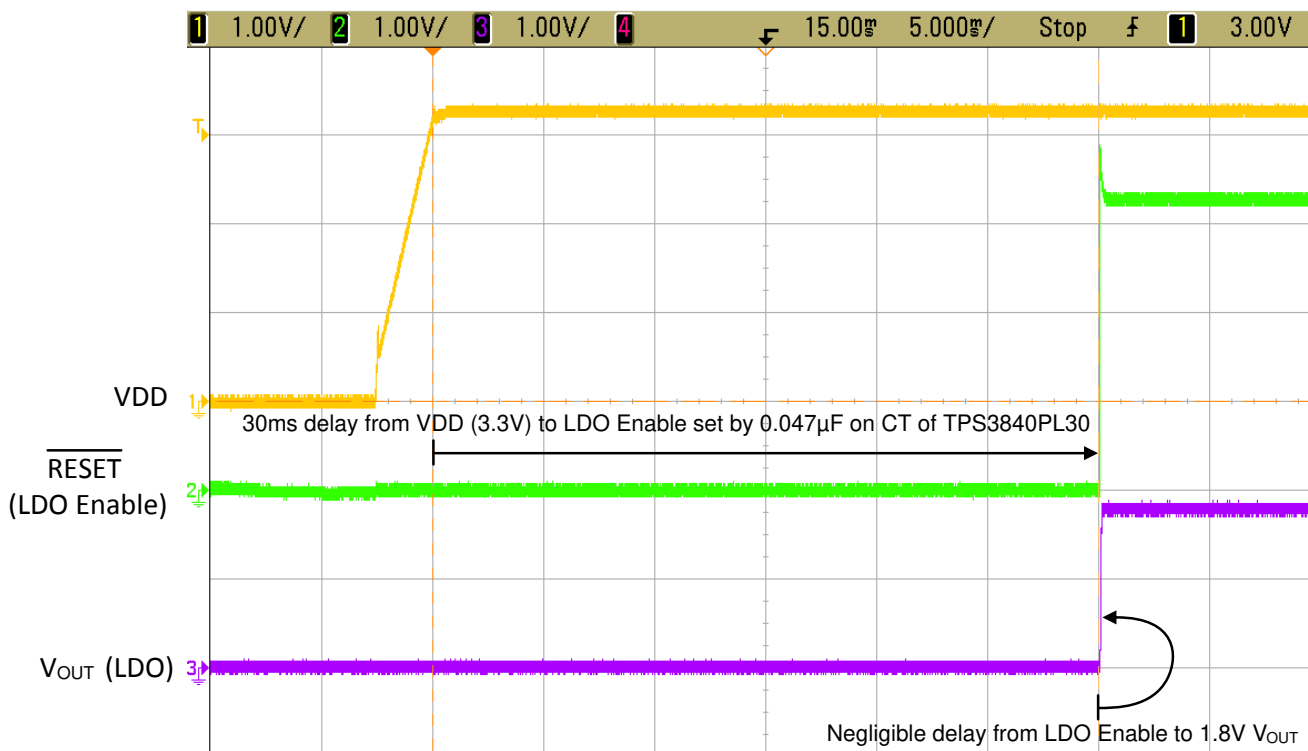

图 49. Fast Start Undervoltage Supervisor with Level-Shifted Input

9.2.2.1 Design Requirements

This design requires voltage supervision on a 12-V power supply voltage rail with possibility of the 12-V rail rising up as high as 42 V. The undervoltage fault occurs when the power supply voltage drops below 7.7 V.

PARAMETER	DESIGN REQUIREMENT	DESIGN RESULT
Power Rail Voltage Supervision	Monitor 12-V power supply for undervoltage condition, trigger a undervoltage fault at 7.7 V.	TPS3840-Q1 provides voltage monitoring with 1% accuracy with device options available in 0.1 V variations. Resistor dividers are calculated based on device variant and desired threshold voltage.
Maximum Input Power	Operate with power supply input up to 42 V.	The TPS3840-Q1 limits VDD to 10 V but can monitor voltages higher than the maximum VDD voltage with the use of an external resistor divider.
Output logic voltage	Open-Drain Output Topology	Due to large variance in battery voltage, an open-drain output is recommended to provide the correct reset signal.
Maximum system current consumption	35 uA when power supply is at 12 V typical	TPS3840-Q1 requires 350 nA (typical) and the external resistor divider will also consume current. There is a tradeoff between current consumption and voltage monitor accuracy but generally set the resistor divider to consume 100 times current into VDD.
Voltage Monitor Accuracy	Typical voltage monitor accuracy of 2.5%.	The TPS3840-Q1 has 1% typical voltage monitor accuracy. By decreasing the ratio of resistor values, the resistor divider will consume more current but the accuracy will increase. The resistor tolerance also needs to be accounted for.
Delay when returning from fault condition	RESET delay of at least 200 ms when returning from a undervoltage fault.	$C_{CT} = 0.33 \mu\text{F}$ sets 204 ms delay

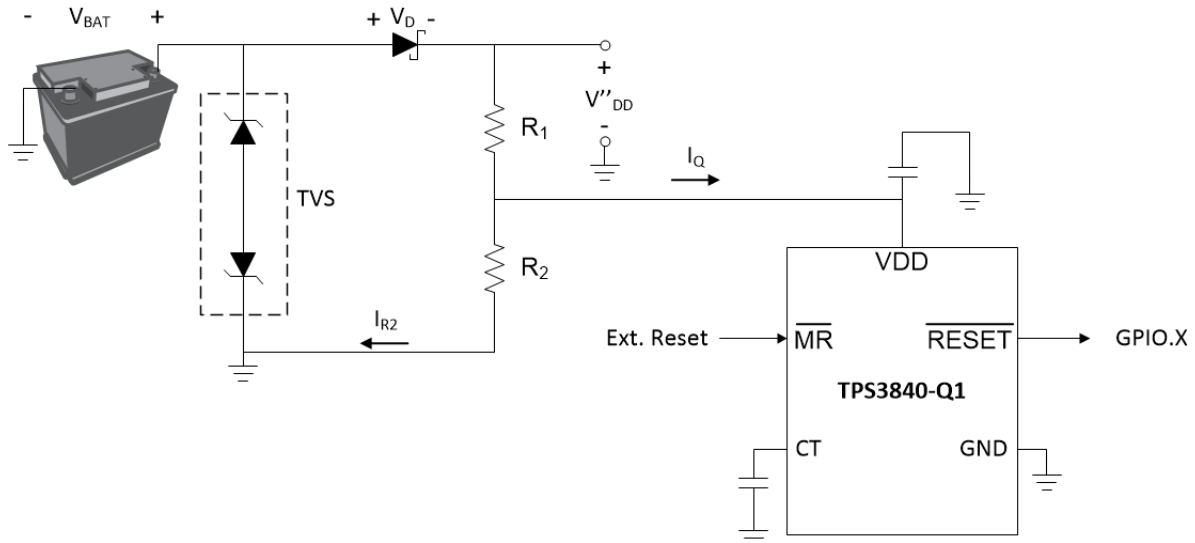
9.2.2.2 Detailed Design Procedure

The primary constraint for this application is monitoring a 12-V rail while preventing the VDD pin on TPS3840-Q1 from exceeding the recommended maximum of 10 V. This is accomplished by sizing the resistor divider so that when the 12-V rail drops to 7.7 V, the VDD pin for TPS3840-Q1 will be at 1.6 V which is the V_{IT-} threshold for triggering a undervoltage condition for TPS3840DL16-Q1 as shown in 公式 7. Reasonably sized resistors were selected for the voltage divider. While selecting lower resistor values may increase current, this allows for additional accuracy from the resistor divider.

$$V_{\text{rail_trigger}} = V_{IT-} \times (R_2 \div (R_1 + R_2)) \quad (7)$$

where $V_{\text{rail_trigger}}$ is the trigger voltage of the rail being monitored, V_{IT-} is the falling threshold on the VDD pin of TPS3840, and R_1 and R_2 are the top and bottom resistors of the external resistor divider. V_{IT-} is fixed per device variant and is 1.6 V for TPS3840DL16-Q1. Substituting in the values from 图 49, the undervoltage trigger threshold for the rail is set to 7.7 V. Given that $R_1 = 100 \text{ k}\Omega$, $R_2 = 26.2 \text{ k}\Omega$.

Because the undervoltage trigger of 10 V on the rail corresponds to 1.6 V undervoltage threshold trigger of the TPS3840-Q1 device, there is room for the rail to rise up while maintaining less than 10 V on the VDD pin of the TPS3840-Q1. 公式 8 shows the maximum rail voltage that still meets the 10 V maximum at the VDD pin for TPS3840-Q1.

$$V_{\text{rail_max}} = 10 \text{ V} \times (26.2 \text{ k}\Omega \div (100 \text{ k}\Omega + 26.2 \text{ k}\Omega)) = 48.168 \text{ V} \quad (8)$$

This means the monitored voltage rail can go as high as 48.168 V and not violate the recommended maximum for the VDD pin on TPS3840-Q1. This is useful when monitoring a voltage rail that has a wide range that may go much higher than the nominal rail voltage such as in this case. Notice that the resistor values chosen are less than 100kΩ to preserve the accuracy set by the internal resistor divider. Good design practice recommends using a 0.1-μF capacitor on the VDD pin and this capacitance may need to increase when using an external resistor divider.

9.2.2.3 Application Curves: TPS3840EVM

These application curves are taken with the *TPS3840EVM* using the TPS3840-Q1. Please see the *TPS3840EVM User Guide* for more information. The scope of the test below was to ensure that normal operation was maintained under typical cold crank and load dump conditions. This was verified by observing the input changing to its minimum and maximum value and the output remained both defined and accurate.



图 50. TPS3840-Q1 Warm-Start Test Pulse



图 51. TPS3840-Q1 Cold-Start Test Pulse



图 52. TPS3840-Q1 Cold Crank Test Pulse

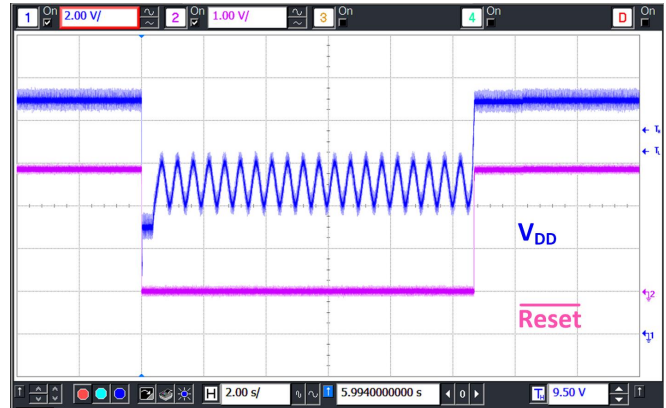

图 53. TPS3840-Q1 Load Dump Test Pulse

10 Power Supply Recommendations

These devices are designed to operate from an input supply with a voltage range between 1.5 V and 10 V. TI recommends an input supply capacitor between the VDD pin and GND pin. This device has a 12-V absolute maximum rating on the VDD pin. If the voltage supply providing power to VDD is susceptible to any large voltage transient that can exceed 12 V, additional precautions must be taken.

11 Layout

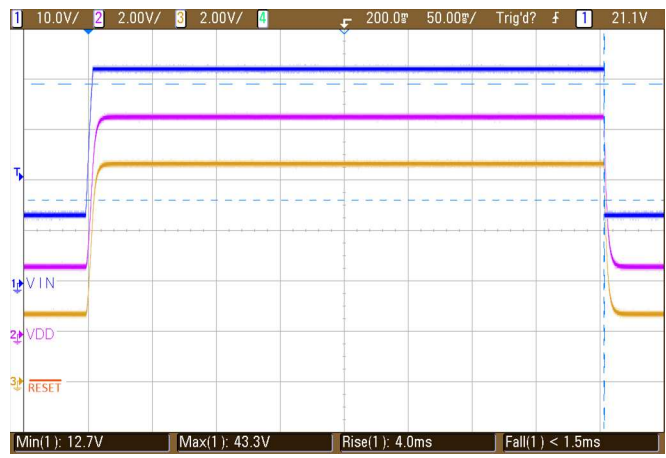
11.1 Layout Guidelines

Make sure that the connection to the VDD pin is low impedance. Good analog design practice recommends placing a minimum 0.1- μ F ceramic capacitor as near as possible to the VDD pin. If a capacitor is not connected to the CT pin, then minimize parasitic capacitance on this pin so the rest time delay is not adversely affected.

- Make sure that the connection to the VDD pin is low impedance. Good analog design practice is to place a >0.1- μ F ceramic capacitor as near as possible to the VDD pin.
- If a C_{CT} capacitor is used, place these components as close as possible to the CT pin. If the CT pin is left unconnected, make sure to minimize the amount of parasitic capacitance on the pin to <5 pF.
- Place the pull-up resistors on $\overline{\text{RESET}}$ pin as close to the pin as possible.

11.2 Layout Example

The layout example in shows how the TPS3840-Q1 is laid out on a printed circuit board (PCB) with a user-defined delay.



图 54. TPS3840-Q1 Recommended Layout

12 器件和文档支持

12.1 器件命名规则

表 2 显示了如何根据器件型号来解译器件的功能。

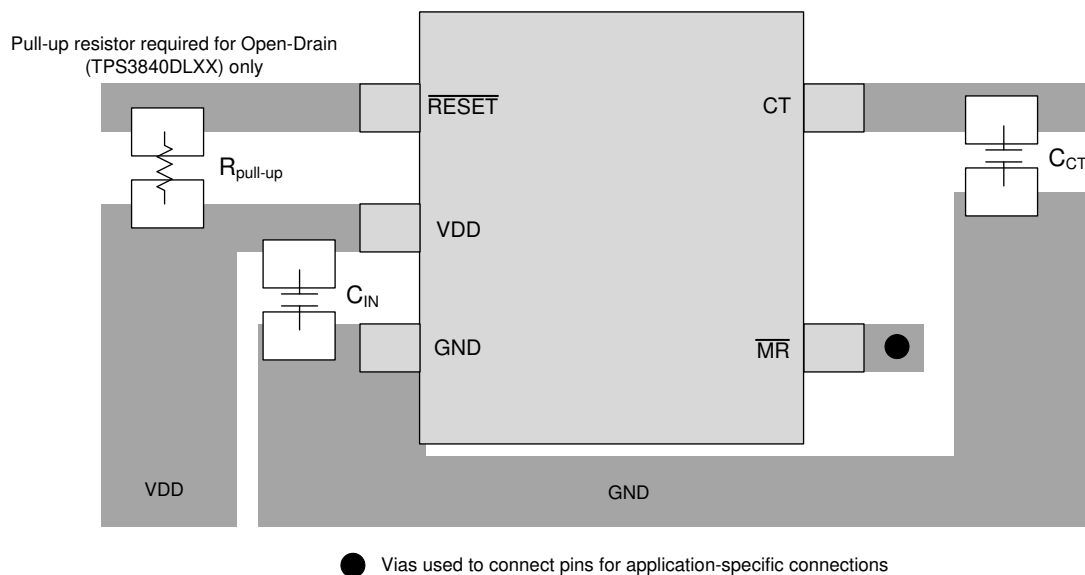
表 2. 器件命名约定

说明	命名规则	值
工程原型预发布样片	P	工程原型样片
器件型号	TPS3840	TPS3840-Q1
型号代码 (输出拓扑)	DL	漏极开路, 低电平有效
	PH	推挽, 高电平有效
	PL	推挽, 低电平有效
检测电压选项	## (两个字符)	示例: 16 表示 1.6V 阈值
封装	DBV	SOT23-5
卷带	R	大卷带
汽车后缀	Q1	表示器件符合 AEC-Q100 标准

表 3 显示了 TPS3840-Q1 的可能型号。有关所显示的其他选项的详细信息和供货情况, 请联系德州仪器 (TI); 最低订购量适用。

表 3. 器件阈值

产品			电压阈值 (V _{IT})	迟滞 (V _{HYST})
漏极开路, 低电平有效	推挽, 低电平有效	推挽, 高电平有效	典型值 (V)	典型值 (V)
TPS3840DL16-Q1	TPS3840PL16-Q1	TPS3840PH16-Q1	1.6	0.100
TPS3840DL17-Q1	TPS3840PL17-Q1	TPS3840PH17-Q1	1.7	0.100
TPS3840DL18-Q1	TPS3840PL18-Q1	TPS3840PH18-Q1	1.8	0.100
TPS3840DL19-Q1	TPS3840PL19-Q1	TPS3840PH19-Q1	1.9	0.100
TPS3840DL20-Q1	TPS3840PL20-Q1	TPS3840PH20-Q1	2.0	0.100
TPS3840DL21-Q1	TPS3840PL21-Q1	TPS3840PH21-Q1	2.1	0.100
TPS3840DL22-Q1	TPS3840PL22-Q1	TPS3840PH22-Q1	2.2	0.100
TPS3840DL23-Q1	TPS3840PL23-Q1	TPS3840PH23-Q1	2.3	0.100
TPS3840DL24-Q1	TPS3840PL24-Q1	TPS3840PH24-Q1	2.4	0.100
TPS3840DL25-Q1	TPS3840PL25-Q1	TPS3840PH25-Q1	2.5	0.100
TPS3840DL26-Q1	TPS3840PL26-Q1	TPS3840PH26-Q1	2.6	0.100
TPS3840DL27-Q1	TPS3840PL27-Q1	TPS3840PH27-Q1	2.7	0.100
TPS3840DL28-Q1	TPS3840PL28-Q1	TPS3840PH28-Q1	2.8	0.100
TPS3840DL29-Q1	TPS3840PL29-Q1	TPS3840PH29-Q1	2.9	0.100
TPS3840DL30-Q1	TPS3840PL30-Q1	TPS3840PH30-Q1	3.0	0.100
TPS3840DL31-Q1	TPS3840PL31-Q1	TPS3840PH31-Q1	3.1	0.200
TPS3840DL32-Q1	TPS3840PL32-Q1	TPS3840PH32-Q1	3.2	0.200
TPS3840DL33-Q1	TPS3840PL33-Q1	TPS3840PH33-Q1	3.3	0.200
TPS3840DL34-Q1	TPS3840PL34-Q1	TPS3840PH34-Q1	3.4	0.200
TPS3840DL35-Q1	TPS3840PL35-Q1	TPS3840PH35-Q1	3.5	0.200
TPS3840DL36-Q1	TPS3840PL36-Q1	TPS3840PH36-Q1	3.6	0.200
TPS3840DL37-Q1	TPS3840PL37-Q1	TPS3840PH37-Q1	3.7	0.200
TPS3840DL38-Q1	TPS3840PL38-Q1	TPS3840PH38-Q1	3.8	0.200
TPS3840DL39-Q1	TPS3840PL39-Q1	TPS3840PH39-Q1	3.9	0.200
TPS3840DL40-Q1	TPS3840PL40-Q1	TPS3840PH40-Q1	4.0	0.200
TPS3840DL41-Q1	TPS3840PL41-Q1	TPS3840PH41-Q1	4.1	0.200
TPS3840DL42-Q1	TPS3840PL42-Q1	TPS3840PH42-Q1	4.2	0.200

表 3. 器件阈值 (接下页)

产品			电压阈值 (V_{IT})	迟滞 (V_{HYST})
漏极开路, 低电平有效	推挽, 低电平有效	推挽, 高电平有效	典型值 (V)	典型值 (V)
TPS3840DL43-Q1	TPS3840PL43-Q1	TPS3840PH43-Q1	4.3	0.200
TPS3840DL44-Q1	TPS3840PL44-Q1	TPS3840PH44-Q1	4.4	0.200
TPS3840DL45-Q1	TPS3840PL45-Q1	TPS3840PH45-Q1	4.5	0.200
TPS3840DL46-Q1	TPS3840PL46-Q1	TPS3840PH46-Q1	4.6	0.200
TPS3840DL47-Q1	TPS3840PL47-Q1	TPS3840PH47-Q1	4.7	0.200
TPS3840DL48-Q1	TPS3840PL48-Q1	TPS3840PH48-Q1	4.8	0.200
TPS3840DL49-Q1	TPS3840PL49-Q1	TPS3840PH49-Q1	4.9	0.200

12.2 社区资源

[TI E2E™ support forums](#) are an engineer's go-to source for fast, verified answers and design help — straight from the experts. Search existing answers or ask your own question to get the quick design help you need.

Linked content is provided "AS IS" by the respective contributors. They do not constitute TI specifications and do not necessarily reflect TI's views; see TI's [Terms of Use](#).

12.3 商标

E2E is a trademark of Texas Instruments.

All other trademarks are the property of their respective owners.

12.4 静电放电警告



ESD 可能会损坏该集成电路。德州仪器 (TI) 建议通过适当的预防措施处理所有集成电路。如果不遵守正确的处理措施和安装程序, 可能会损坏集成电路。

ESD 的损坏小至导致微小的性能降级, 大至整个器件故障。精密的集成电路可能更容易受到损坏, 这是因为非常细微的参数更改都可能会导致器件与其发布的规格不相符。

12.5 Glossary

[SLYZ022](#) — *TI Glossary*.

This glossary lists and explains terms, acronyms, and definitions.

13 机械、封装和可订购信息

以下页面包含机械、封装和可订购信息。这些信息是指定器件的最新可用数据。数据如有变更, 恕不另行通知, 且不会对此文档进行修订。如需获取此数据表的浏览器版本, 请查阅左侧的导航栏。

PACKAGING INFORMATION

Orderable part number	Status (1)	Material type (2)	Package Pins	Package qty Carrier	RoHS (3)	Lead finish/ Ball material (4)	MSL rating/ Peak reflow (5)	Op temp (°C)	Part marking (6)
TPS3840DL16DBVRQ1	Active	Production	SOT-23 (DBV) 5	3000 LARGE T&R	Yes	NIPDAU SN	Level-1-260C-UNLIM	-40 to 125	DQ16
TPS3840DL16DBVRQ1.A	Active	Production	SOT-23 (DBV) 5	3000 LARGE T&R	Yes	NIPDAU	Level-1-260C-UNLIM	-40 to 125	DQ16
TPS3840DL16DBVRQ1.B	Active	Production	SOT-23 (DBV) 5	3000 LARGE T&R	-	Call TI	Call TI	-40 to 125	
TPS3840DL18DBVRQ1	Active	Production	SOT-23 (DBV) 5	3000 LARGE T&R	Yes	NIPDAU SN	Level-1-260C-UNLIM	-40 to 125	DQ18
TPS3840DL18DBVRQ1.A	Active	Production	SOT-23 (DBV) 5	3000 LARGE T&R	Yes	NIPDAU	Level-1-260C-UNLIM	-40 to 125	DQ18
TPS3840DL18DBVRQ1.B	Active	Production	SOT-23 (DBV) 5	3000 LARGE T&R	-	Call TI	Call TI	-40 to 125	
TPS3840DL20DBVRQ1	Active	Production	SOT-23 (DBV) 5	3000 LARGE T&R	Yes	NIPDAU SN	Level-1-260C-UNLIM	-40 to 125	DQ20
TPS3840DL20DBVRQ1.A	Active	Production	SOT-23 (DBV) 5	3000 LARGE T&R	Yes	NIPDAU	Level-1-260C-UNLIM	-40 to 125	DQ20
TPS3840DL20DBVRQ1.B	Active	Production	SOT-23 (DBV) 5	3000 LARGE T&R	-	Call TI	Call TI	-40 to 125	
TPS3840DL25DBVRQ1	Active	Production	SOT-23 (DBV) 5	3000 LARGE T&R	Yes	NIPDAU	Level-1-260C-UNLIM	-40 to 125	DQ25
TPS3840DL25DBVRQ1.A	Active	Production	SOT-23 (DBV) 5	3000 LARGE T&R	Yes	NIPDAU	Level-1-260C-UNLIM	-40 to 125	DQ25
TPS3840DL28DBVRQ1	Active	Production	SOT-23 (DBV) 5	3000 LARGE T&R	Yes	NIPDAU SN	Level-1-260C-UNLIM	-40 to 125	DQ28
TPS3840DL28DBVRQ1.A	Active	Production	SOT-23 (DBV) 5	3000 LARGE T&R	Yes	SN	Level-1-260C-UNLIM	-40 to 125	DQ28
TPS3840DL28DBVRQ1.B	Active	Production	SOT-23 (DBV) 5	3000 LARGE T&R	-	Call TI	Call TI	-40 to 125	
TPS3840DL29DBVRQ1	Active	Production	SOT-23 (DBV) 5	3000 LARGE T&R	Yes	NIPDAU SN	Level-1-260C-UNLIM	-40 to 125	DQ29
TPS3840DL29DBVRQ1.A	Active	Production	SOT-23 (DBV) 5	3000 LARGE T&R	Yes	SN	Level-1-260C-UNLIM	-40 to 125	DQ29
TPS3840DL29DBVRQ1.B	Active	Production	SOT-23 (DBV) 5	3000 LARGE T&R	-	Call TI	Call TI	-40 to 125	
TPS3840DL30DBVRQ1	Active	Production	SOT-23 (DBV) 5	3000 LARGE T&R	Yes	NIPDAU SN	Level-1-260C-UNLIM	-40 to 125	DQ30
TPS3840DL30DBVRQ1.A	Active	Production	SOT-23 (DBV) 5	3000 LARGE T&R	Yes	NIPDAU	Level-1-260C-UNLIM	-40 to 125	DQ30
TPS3840DL30DBVRQ1.B	Active	Production	SOT-23 (DBV) 5	3000 LARGE T&R	-	Call TI	Call TI	-40 to 125	
TPS3840DL31DBVRQ1	Active	Production	SOT-23 (DBV) 5	3000 LARGE T&R	Yes	NIPDAU SN	Level-1-260C-UNLIM	-40 to 125	DQ31
TPS3840DL31DBVRQ1.A	Active	Production	SOT-23 (DBV) 5	3000 LARGE T&R	Yes	NIPDAU	Level-1-260C-UNLIM	-40 to 125	DQ31
TPS3840DL31DBVRQ1.B	Active	Production	SOT-23 (DBV) 5	3000 LARGE T&R	-	Call TI	Call TI	-40 to 125	
TPS3840DL32DBVRQ1	Active	Production	SOT-23 (DBV) 5	3000 LARGE T&R	Yes	NIPDAU SN	Level-1-260C-UNLIM	-40 to 125	DQ32
TPS3840DL32DBVRQ1.A	Active	Production	SOT-23 (DBV) 5	3000 LARGE T&R	Yes	NIPDAU	Level-1-260C-UNLIM	-40 to 125	DQ32
TPS3840DL32DBVRQ1.B	Active	Production	SOT-23 (DBV) 5	3000 LARGE T&R	-	Call TI	Call TI	-40 to 125	
TPS3840DL37DBVRQ1	Active	Production	SOT-23 (DBV) 5	3000 LARGE T&R	Yes	NIPDAU	Level-1-260C-UNLIM	-40 to 125	DQ37
TPS3840DL37DBVRQ1.A	Active	Production	SOT-23 (DBV) 5	3000 LARGE T&R	Yes	NIPDAU	Level-1-260C-UNLIM	-40 to 125	DQ37
TPS3840DL40DBVRQ1	Active	Production	SOT-23 (DBV) 5	3000 LARGE T&R	Yes	NIPDAU SN	Level-1-260C-UNLIM	-40 to 125	DQ40

Orderable part number	Status (1)	Material type (2)	Package Pins	Package qty Carrier	RoHS (3)	Lead finish/ Ball material (4)	MSL rating/ Peak reflow (5)	Op temp (°C)	Part marking (6)
TPS3840DL40DBVRQ1.A	Active	Production	SOT-23 (DBV) 5	3000 LARGE T&R	Yes	SN	Level-1-260C-UNLIM	-40 to 125	DQ40
TPS3840DL40DBVRQ1.B	Active	Production	SOT-23 (DBV) 5	3000 LARGE T&R	-	Call TI	Call TI	-40 to 125	
TPS3840DL41DBVRQ1	Active	Production	SOT-23 (DBV) 5	3000 LARGE T&R	Yes	NIPDAU SN	Level-1-260C-UNLIM	-40 to 125	DQ41
TPS3840DL41DBVRQ1.A	Active	Production	SOT-23 (DBV) 5	3000 LARGE T&R	Yes	SN	Level-1-260C-UNLIM	-40 to 125	DQ41
TPS3840DL41DBVRQ1.B	Active	Production	SOT-23 (DBV) 5	3000 LARGE T&R	-	Call TI	Call TI	-40 to 125	
TPS3840DL42DBVRQ1	Active	Production	SOT-23 (DBV) 5	3000 LARGE T&R	Yes	NIPDAU	Level-1-260C-UNLIM	-40 to 125	DQ42
TPS3840DL42DBVRQ1.A	Active	Production	SOT-23 (DBV) 5	3000 LARGE T&R	Yes	NIPDAU	Level-1-260C-UNLIM	-40 to 125	DQ42
TPS3840DL44DBVRQ1	Active	Production	SOT-23 (DBV) 5	3000 LARGE T&R	Yes	NIPDAU SN	Level-1-260C-UNLIM	-40 to 125	DQ44
TPS3840DL44DBVRQ1.A	Active	Production	SOT-23 (DBV) 5	3000 LARGE T&R	Yes	SN	Level-1-260C-UNLIM	-40 to 125	DQ44
TPS3840DL45DBVRQ1	Active	Production	SOT-23 (DBV) 5	3000 LARGE T&R	Yes	NIPDAU SN	Level-1-260C-UNLIM	-40 to 125	DQ45
TPS3840DL45DBVRQ1.A	Active	Production	SOT-23 (DBV) 5	3000 LARGE T&R	Yes	NIPDAU	Level-1-260C-UNLIM	-40 to 125	DQ45
TPS3840DL45DBVRQ1.B	Active	Production	SOT-23 (DBV) 5	3000 LARGE T&R	-	Call TI	Call TI	-40 to 125	
TPS3840DL46DBVRQ1	Active	Production	SOT-23 (DBV) 5	3000 LARGE T&R	Yes	NIPDAU SN	Level-1-260C-UNLIM	-40 to 125	DQ46
TPS3840DL46DBVRQ1.A	Active	Production	SOT-23 (DBV) 5	3000 LARGE T&R	Yes	NIPDAU	Level-1-260C-UNLIM	-40 to 125	DQ46
TPS3840DL46DBVRQ1.B	Active	Production	SOT-23 (DBV) 5	3000 LARGE T&R	-	Call TI	Call TI	-40 to 125	
TPS3840DL47DBVRQ1	Active	Production	SOT-23 (DBV) 5	3000 LARGE T&R	Yes	NIPDAU SN	Level-1-260C-UNLIM	-40 to 125	DQ47
TPS3840DL47DBVRQ1.A	Active	Production	SOT-23 (DBV) 5	3000 LARGE T&R	Yes	NIPDAU	Level-1-260C-UNLIM	-40 to 125	DQ47
TPS3840DL47DBVRQ1.B	Active	Production	SOT-23 (DBV) 5	3000 LARGE T&R	-	Call TI	Call TI	-40 to 125	
TPS3840PH27DBVRQ1	Active	Production	SOT-23 (DBV) 5	3000 LARGE T&R	Yes	NIPDAU SN	Level-1-260C-UNLIM	-40 to 125	QH27
TPS3840PH27DBVRQ1.A	Active	Production	SOT-23 (DBV) 5	3000 LARGE T&R	Yes	SN	Level-1-260C-UNLIM	-40 to 125	QH27
TPS3840PH27DBVRQ1.B	Active	Production	SOT-23 (DBV) 5	3000 LARGE T&R	-	Call TI	Call TI	-40 to 125	
TPS3840PH30DBVRQ1	Active	Production	SOT-23 (DBV) 5	3000 LARGE T&R	Yes	NIPDAU SN	Level-1-260C-UNLIM	-40 to 125	QH30
TPS3840PH30DBVRQ1.A	Active	Production	SOT-23 (DBV) 5	3000 LARGE T&R	Yes	NIPDAU	Level-1-260C-UNLIM	-40 to 125	QH30
TPS3840PH30DBVRQ1.B	Active	Production	SOT-23 (DBV) 5	3000 LARGE T&R	-	Call TI	Call TI	-40 to 125	
TPS3840PL16DBVRQ1	Active	Production	SOT-23 (DBV) 5	3000 LARGE T&R	Yes	NIPDAU SN	Level-1-260C-UNLIM	-40 to 125	QL16
TPS3840PL16DBVRQ1.A	Active	Production	SOT-23 (DBV) 5	3000 LARGE T&R	Yes	NIPDAU	Level-1-260C-UNLIM	-40 to 125	QL16
TPS3840PL25DBVRQ1	Active	Production	SOT-23 (DBV) 5	3000 LARGE T&R	Yes	NIPDAU	Level-1-260C-UNLIM	-40 to 125	QL25
TPS3840PL25DBVRQ1.A	Active	Production	SOT-23 (DBV) 5	3000 LARGE T&R	Yes	NIPDAU	Level-1-260C-UNLIM	-40 to 125	QL25
TPS3840PL28DBVRQ1	Active	Production	SOT-23 (DBV) 5	3000 LARGE T&R	Yes	NIPDAU SN	Level-1-260C-UNLIM	-40 to 125	QL28
TPS3840PL28DBVRQ1.A	Active	Production	SOT-23 (DBV) 5	3000 LARGE T&R	Yes	SN	Level-1-260C-UNLIM	-40 to 125	QL28
TPS3840PL28DBVRQ1.B	Active	Production	SOT-23 (DBV) 5	3000 LARGE T&R	-	Call TI	Call TI	-40 to 125	

Orderable part number	Status (1)	Material type (2)	Package Pins	Package qty Carrier	RoHS (3)	Lead finish/ Ball material (4)	MSL rating/ Peak reflow (5)	Op temp (°C)	Part marking (6)
TPS3840PL29DBVRQ1	Active	Production	SOT-23 (DBV) 5	3000 LARGE T&R	Yes	NIPDAU SN	Level-1-260C-UNLIM	-40 to 125	QL29
TPS3840PL29DBVRQ1.A	Active	Production	SOT-23 (DBV) 5	3000 LARGE T&R	Yes	SN	Level-1-260C-UNLIM	-40 to 125	QL29
TPS3840PL29DBVRQ1.B	Active	Production	SOT-23 (DBV) 5	3000 LARGE T&R	-	Call TI	Call TI	-40 to 125	
TPS3840PL30DBVRQ1	Active	Production	SOT-23 (DBV) 5	3000 LARGE T&R	Yes	NIPDAU SN	Level-1-260C-UNLIM	-40 to 125	QL30
TPS3840PL30DBVRQ1.A	Active	Production	SOT-23 (DBV) 5	3000 LARGE T&R	Yes	NIPDAU	Level-1-260C-UNLIM	-40 to 125	QL30
TPS3840PL30DBVRQ1.B	Active	Production	SOT-23 (DBV) 5	3000 LARGE T&R	-	Call TI	Call TI	-40 to 125	
TPS3840PL31DBVRQ1	Active	Production	SOT-23 (DBV) 5	3000 LARGE T&R	Yes	NIPDAU SN	Level-1-260C-UNLIM	-40 to 125	QL31
TPS3840PL31DBVRQ1.A	Active	Production	SOT-23 (DBV) 5	3000 LARGE T&R	Yes	NIPDAU	Level-1-260C-UNLIM	-40 to 125	QL31
TPS3840PL31DBVRQ1.B	Active	Production	SOT-23 (DBV) 5	3000 LARGE T&R	-	Call TI	Call TI	-40 to 125	
TPS3840PL40DBVRQ1	Active	Production	SOT-23 (DBV) 5	3000 LARGE T&R	Yes	NIPDAU SN	Level-1-260C-UNLIM	-40 to 125	QL40
TPS3840PL40DBVRQ1.A	Active	Production	SOT-23 (DBV) 5	3000 LARGE T&R	Yes	NIPDAU	Level-1-260C-UNLIM	-40 to 125	QL40
TPS3840PL40DBVRQ1.B	Active	Production	SOT-23 (DBV) 5	3000 LARGE T&R	-	Call TI	Call TI	-40 to 125	
TPS3840PL43DBVRQ1	Active	Production	SOT-23 (DBV) 5	3000 LARGE T&R	Yes	NIPDAU SN	Level-1-260C-UNLIM	-40 to 125	QL43
TPS3840PL43DBVRQ1.A	Active	Production	SOT-23 (DBV) 5	3000 LARGE T&R	Yes	NIPDAU	Level-1-260C-UNLIM	-40 to 125	QL43

(1) **Status:** For more details on status, see our [product life cycle](#).

(2) **Material type:** When designated, preproduction parts are prototypes/experimental devices, and are not yet approved or released for full production. Testing and final process, including without limitation quality assurance, reliability performance testing, and/or process qualification, may not yet be complete, and this item is subject to further changes or possible discontinuation. If available for ordering, purchases will be subject to an additional waiver at checkout, and are intended for early internal evaluation purposes only. These items are sold without warranties of any kind.

(3) **RoHS values:** Yes, No, RoHS Exempt. See the [TI RoHS Statement](#) for additional information and value definition.

(4) **Lead finish/Ball material:** Parts may have multiple material finish options. Finish options are separated by a vertical ruled line. Lead finish/Ball material values may wrap to two lines if the finish value exceeds the maximum column width.

(5) **MSL rating/Peak reflow:** The moisture sensitivity level ratings and peak solder (reflow) temperatures. In the event that a part has multiple moisture sensitivity ratings, only the lowest level per JEDEC standards is shown. Refer to the shipping label for the actual reflow temperature that will be used to mount the part to the printed circuit board.

(6) **Part marking:** There may be an additional marking, which relates to the logo, the lot trace code information, or the environmental category of the part.

Multiple part markings will be inside parentheses. Only one part marking contained in parentheses and separated by a "-" will appear on a part. If a line is indented then it is a continuation of the previous line and the two combined represent the entire part marking for that device.

Important Information and Disclaimer:The information provided on this page represents TI's knowledge and belief as of the date that it is provided. TI bases its knowledge and belief on information provided by third parties, and makes no representation or warranty as to the accuracy of such information. Efforts are underway to better integrate information from third parties. TI has taken and continues to take reasonable steps to provide representative and accurate information but may not have conducted destructive testing or chemical analysis on incoming materials and chemicals. TI and TI suppliers consider certain information to be proprietary, and thus CAS numbers and other limited information may not be available for release.

In no event shall TI's liability arising out of such information exceed the total purchase price of the TI part(s) at issue in this document sold by TI to Customer on an annual basis.

OTHER QUALIFIED VERSIONS OF TPS3840-Q1 :

- Catalog : [TPS3840](#)

NOTE: Qualified Version Definitions:

- Catalog - TI's standard catalog product

TAPE AND REEL INFORMATION

QUADRANT ASSIGNMENTS FOR PIN 1 ORIENTATION IN TAPE

*All dimensions are nominal

Device	Package Type	Package Drawing	Pins	SPQ	Reel Diameter (mm)	Reel Width W1 (mm)	A0 (mm)	B0 (mm)	K0 (mm)	P1 (mm)	W (mm)	Pin1 Quadrant
TPS3840DL16DBVRQ1	SOT-23	DBV	5	3000	180.0	8.4	3.2	3.2	1.4	4.0	8.0	Q3
TPS3840DL18DBVRQ1	SOT-23	DBV	5	3000	180.0	8.4	3.2	3.2	1.4	4.0	8.0	Q3
TPS3840DL20DBVRQ1	SOT-23	DBV	5	3000	180.0	8.4	3.2	3.2	1.4	4.0	8.0	Q3
TPS3840DL25DBVRQ1	SOT-23	DBV	5	3000	180.0	8.4	3.2	3.2	1.4	4.0	8.0	Q3
TPS3840DL28DBVRQ1	SOT-23	DBV	5	3000	180.0	8.4	3.2	3.2	1.4	4.0	8.0	Q3
TPS3840DL29DBVRQ1	SOT-23	DBV	5	3000	180.0	8.4	3.2	3.2	1.4	4.0	8.0	Q3
TPS3840DL30DBVRQ1	SOT-23	DBV	5	3000	180.0	8.4	3.2	3.2	1.4	4.0	8.0	Q3
TPS3840DL31DBVRQ1	SOT-23	DBV	5	3000	180.0	8.4	3.2	3.2	1.4	4.0	8.0	Q3
TPS3840DL32DBVRQ1	SOT-23	DBV	5	3000	180.0	8.4	3.2	3.2	1.4	4.0	8.0	Q3
TPS3840DL37DBVRQ1	SOT-23	DBV	5	3000	180.0	8.4	3.2	3.2	1.4	4.0	8.0	Q3
TPS3840DL40DBVRQ1	SOT-23	DBV	5	3000	180.0	8.4	3.2	3.2	1.4	4.0	8.0	Q3
TPS3840DL41DBVRQ1	SOT-23	DBV	5	3000	180.0	8.4	3.2	3.2	1.4	4.0	8.0	Q3
TPS3840DL42DBVRQ1	SOT-23	DBV	5	3000	180.0	8.4	3.2	3.2	1.4	4.0	8.0	Q3
TPS3840DL44DBVRQ1	SOT-23	DBV	5	3000	180.0	8.4	3.2	3.2	1.4	4.0	8.0	Q3
TPS3840DL45DBVRQ1	SOT-23	DBV	5	3000	180.0	8.4	3.2	3.2	1.4	4.0	8.0	Q3
TPS3840DL46DBVRQ1	SOT-23	DBV	5	3000	180.0	8.4	3.2	3.2	1.4	4.0	8.0	Q3

Device	Package Type	Package Drawing	Pins	SPQ	Reel Diameter (mm)	Reel Width W1 (mm)	A0 (mm)	B0 (mm)	K0 (mm)	P1 (mm)	W (mm)	Pin1 Quadrant
TPS3840DL47DBVRQ1	SOT-23	DBV	5	3000	180.0	8.4	3.2	3.2	1.4	4.0	8.0	Q3
TPS3840PH27DBVRQ1	SOT-23	DBV	5	3000	180.0	8.4	3.2	3.2	1.4	4.0	8.0	Q3
TPS3840PH30DBVRQ1	SOT-23	DBV	5	3000	180.0	8.4	3.2	3.2	1.4	4.0	8.0	Q3
TPS3840PL16DBVRQ1	SOT-23	DBV	5	3000	180.0	8.4	3.2	3.2	1.4	4.0	8.0	Q3
TPS3840PL25DBVRQ1	SOT-23	DBV	5	3000	180.0	8.4	3.2	3.2	1.4	4.0	8.0	Q3
TPS3840PL28DBVRQ1	SOT-23	DBV	5	3000	180.0	8.4	3.2	3.2	1.4	4.0	8.0	Q3
TPS3840PL29DBVRQ1	SOT-23	DBV	5	3000	180.0	8.4	3.2	3.2	1.4	4.0	8.0	Q3
TPS3840PL30DBVRQ1	SOT-23	DBV	5	3000	180.0	8.4	3.2	3.2	1.4	4.0	8.0	Q3
TPS3840PL31DBVRQ1	SOT-23	DBV	5	3000	180.0	8.4	3.2	3.2	1.4	4.0	8.0	Q3
TPS3840PL40DBVRQ1	SOT-23	DBV	5	3000	180.0	8.4	3.2	3.2	1.4	4.0	8.0	Q3
TPS3840PL43DBVRQ1	SOT-23	DBV	5	3000	180.0	8.4	3.2	3.2	1.4	4.0	8.0	Q3

TAPE AND REEL BOX DIMENSIONS

*All dimensions are nominal

Device	Package Type	Package Drawing	Pins	SPQ	Length (mm)	Width (mm)	Height (mm)
TPS3840DL16DBVRQ1	SOT-23	DBV	5	3000	210.0	185.0	35.0
TPS3840DL18DBVRQ1	SOT-23	DBV	5	3000	210.0	185.0	35.0
TPS3840DL20DBVRQ1	SOT-23	DBV	5	3000	210.0	185.0	35.0
TPS3840DL25DBVRQ1	SOT-23	DBV	5	3000	210.0	185.0	35.0
TPS3840DL28DBVRQ1	SOT-23	DBV	5	3000	210.0	185.0	35.0
TPS3840DL29DBVRQ1	SOT-23	DBV	5	3000	210.0	185.0	35.0
TPS3840DL30DBVRQ1	SOT-23	DBV	5	3000	210.0	185.0	35.0
TPS3840DL31DBVRQ1	SOT-23	DBV	5	3000	210.0	185.0	35.0
TPS3840DL32DBVRQ1	SOT-23	DBV	5	3000	210.0	185.0	35.0
TPS3840DL37DBVRQ1	SOT-23	DBV	5	3000	210.0	185.0	35.0
TPS3840DL40DBVRQ1	SOT-23	DBV	5	3000	210.0	185.0	35.0
TPS3840DL41DBVRQ1	SOT-23	DBV	5	3000	210.0	185.0	35.0
TPS3840DL42DBVRQ1	SOT-23	DBV	5	3000	210.0	185.0	35.0
TPS3840DL44DBVRQ1	SOT-23	DBV	5	3000	210.0	185.0	35.0
TPS3840DL45DBVRQ1	SOT-23	DBV	5	3000	210.0	185.0	35.0
TPS3840DL46DBVRQ1	SOT-23	DBV	5	3000	210.0	185.0	35.0
TPS3840DL47DBVRQ1	SOT-23	DBV	5	3000	210.0	185.0	35.0
TPS3840PH27DBVRQ1	SOT-23	DBV	5	3000	210.0	185.0	35.0

Device	Package Type	Package Drawing	Pins	SPQ	Length (mm)	Width (mm)	Height (mm)
TPS3840PH30DBVRQ1	SOT-23	DBV	5	3000	210.0	185.0	35.0
TPS3840PL16DBVRQ1	SOT-23	DBV	5	3000	210.0	185.0	35.0
TPS3840PL25DBVRQ1	SOT-23	DBV	5	3000	210.0	185.0	35.0
TPS3840PL28DBVRQ1	SOT-23	DBV	5	3000	210.0	185.0	35.0
TPS3840PL29DBVRQ1	SOT-23	DBV	5	3000	210.0	185.0	35.0
TPS3840PL30DBVRQ1	SOT-23	DBV	5	3000	210.0	185.0	35.0
TPS3840PL31DBVRQ1	SOT-23	DBV	5	3000	210.0	185.0	35.0
TPS3840PL40DBVRQ1	SOT-23	DBV	5	3000	210.0	185.0	35.0
TPS3840PL43DBVRQ1	SOT-23	DBV	5	3000	210.0	185.0	35.0

EXAMPLE BOARD LAYOUT

DBV0005A

SOT-23 - 1.45 mm max height

SMALL OUTLINE TRANSISTOR



LAND PATTERN EXAMPLE
EXPOSED METAL SHOWN
SCALE:15X



SOLDER MASK DETAILS

4214839/K 08/2024

NOTES: (continued)

- 6. Publication IPC-7351 may have alternate designs.
- 7. Solder mask tolerances between and around signal pads can vary based on board fabrication site.

EXAMPLE STENCIL DESIGN

DBV0005A

SOT-23 - 1.45 mm max height

SMALL OUTLINE TRANSISTOR



SOLDER PASTE EXAMPLE
BASED ON 0.125 mm THICK STENCIL
SCALE:15X

4214839/K 08/2024

NOTES: (continued)

8. Laser cutting apertures with trapezoidal walls and rounded corners may offer better paste release. IPC-7525 may have alternate design recommendations.
9. Board assembly site may have different recommendations for stencil design.

重要通知和免责声明

TI“按原样”提供技术和可靠性数据（包括数据表）、设计资源（包括参考设计）、应用或其他设计建议、网络工具、安全信息和其他资源，不保证没有瑕疵且不做任何明示或暗示的担保，包括但不限于对适销性、与某特定用途的适用性或不侵犯任何第三方知识产权的暗示担保。

这些资源可供使用 TI 产品进行设计的熟练开发人员使用。您将自行承担以下全部责任：(1) 针对您的应用选择合适的 TI 产品，(2) 设计、验证并测试您的应用，(3) 确保您的应用满足相应标准以及任何其他安全、安保法规或其他要求。

这些资源如有变更，恕不另行通知。TI 授权您仅可将这些资源用于研发本资源所述的 TI 产品的相关应用。严禁以其他方式对这些资源进行复制或展示。您无权使用任何其他 TI 知识产权或任何第三方知识产权。对于因您对这些资源的使用而对 TI 及其代表造成的任何索赔、损害、成本、损失和债务，您将全额赔偿，TI 对此概不负责。

TI 提供的产品受 [TI 销售条款](#)、[TI 通用质量指南](#) 或 [ti.com](#) 上其他适用条款或 TI 产品随附的其他适用条款的约束。TI 提供这些资源并不会扩展或以其他方式更改 TI 针对 TI 产品发布的适用的担保或担保免责声明。除非德州仪器 (TI) 明确将某产品指定为定制产品或客户特定产品，否则其产品均为按确定价格收入目录的标准通用器件。

TI 反对并拒绝您可能提出的任何其他或不同的条款。

版权所有 © 2026，德州仪器 (TI) 公司

最后更新日期：2025 年 10 月