

TPS2296xC 具有反向电流保护和受控接通功能的 5.5V、3A、13mΩ 导通电阻负载开关

1 特性

- 集成 N 通道负载开关
- 输入电压范围：1V 至 5.5V
- 内部导通 FET $R_{\text{DS(ON)}} = 8\text{m}\Omega$ (典型值)
- 超低导通电阻
 - $R_{\text{ON}} = 13\text{m}\Omega$ (典型值)，此时 $V_{\text{IN}} = 5\text{V}$
 - $R_{\text{ON}} = 14\text{m}\Omega$ (典型值)，此时 $V_{\text{IN}} = 3.3\text{V}$
 - $R_{\text{ON}} = 18\text{m}\Omega$ (典型值)，此时 $V_{\text{IN}} = 1.8\text{V}$
- 3A 最大持续开关电流
- 反向电流保护 (禁用时)
- 低关断电流 (760nA)
- 1.3V GPIO 低阈值控制输入
- 受控转换率可避免浪涌电流
- 快速输出放电 (只适用于 TPS22964)
- 六引脚晶圆级芯片规模封装 (标称尺寸 - 请参见附录了解详细信息)
 - 0.9mm x 1.4mm, 0.5mm 焊球间距, 0.5mm 高度 (YZP)
- 经测试, 静电放电 (ESD) 性能符合 JESD 22 规范
 - 2kV 人体模型 (A114-B, II 类)
 - 500V 充电器件模型 (C101)

2 应用

- 智能手机
- 笔记本电脑和 超极本™
- 平板电脑
- 固态硬盘 (SSD)
- 数字电视 (DTV)/IP 机顶盒
- POS 终端及媒体网关

4 简化电路原理图

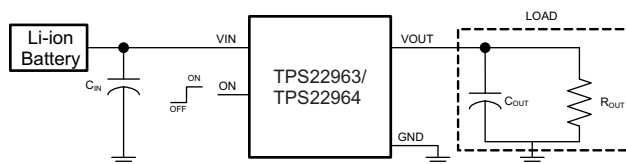

3 说明

TPS22963/64 是一款具有受控接通功能的小型超低 R_{ON} 负载开关。此器件包含一个低 $R_{\text{DS(ON)}}$ N 通道金属氧化物半导体场效应晶体管 (MOSFET)，可在 1V 至 5.5V 输入电压范围内运行并支持高达 3A 的开关电流。采用集成电荷泵偏置 NMOS 开关，从而获得一个低开关导通电阻。此开关可由一个打开/关闭输入 (ON) 控制，此输入可与低压 GPIO 控制信号直接对接。TPS22963/64 器件的上升时间受到内部控制以避免浪涌电流。

TPS22963/64 提供反向电流保护。当电源开关禁用时，该器件将防止电流流向开关输入端。反向电流保护功能只有在在该器件禁用时才有效，以便允许某些应用中特意的反向电流 (开关使能时)。

TPS22963/64 采用超小型、节省空间的 6 引脚晶圆级芯片 (WCSP) 封装，额定工作环境温度范围为 -40°C 至 85°C 。

器件信息(1)

器件型号	封装	封装尺寸 (标称值)
TPS2296xC	DSBGA (6)	1.40mm x 0.90mm

(1) 要了解所有可用封装，请见数据表末尾的可订购产品附录。

目录

1	特性	1	10	Detailed Description	14
2	应用	1	10.1	Overview	14
3	说明	1	10.2	Functional Block Diagram	14
4	简化电路原理图	1	10.3	Feature Description	15
5	修订历史记录	2	10.4	Device Functional Modes	15
6	Device Comparison Table	3	11	Application and Implementation	15
7	Pin Configuration and Functions	3	11.1	Application Information	15
8	Specifications	4	11.2	Typical Application	17
8.1	Absolute Maximum Ratings	4	12	Power Supply Recommendations	19
8.2	ESD Ratings	4	13	Layout	19
8.3	Recommended Operating Conditions	4	13.1	Layout Guidelines	19
8.4	Thermal Information	4	13.2	Layout Example	19
8.5	Electrical Characteristics	5	14	器件和文档支持	20
8.6	Switching Characteristics	6	14.1	相关链接	20
8.7	Typical Electrical Characteristics	7	14.2	商标	20
8.8	Typical Switching Characteristics	9	14.3	静电放电警告	20
8.9	Typical AC Scope Captures at $T_A = 25^\circ\text{C}$	10	14.4	术语表	20
9	Parametric Measurement Information	13	15	机械封装和可订购信息	20

5 修订历史记录

Changes from Original (June 2013) to Revision A

Page

- 已添加 引脚配置和功能部分, ESD 额定值表, 特性描述部分, 器件功能模式, 应用和实施部分, 电源相关建议部分, 布局部分, 器件和文档支持部分以及机械、封装和可订购信息部分

1

6 Device Comparison Table

	R_{ON} (Typ) at 3.3 V	Rise Time (Typ) at 3.3 V ⁽¹⁾	Quick Output Discharge (QOD) ⁽²⁾	Maximum Output Current	Enable
TPS22963C	14 m Ω	715 μ s	No	3 A	Active High
TPS22964C	14 m Ω	715 μ s	Yes	3 A	Active High

- (1) Additional rise time options are possible. Contact factory for more information.
(2) This feature discharges the output of the switch to ground through a 273 Ω resistor, preventing the output from floating (only in TPS22964C).

7 Pin Configuration and Functions

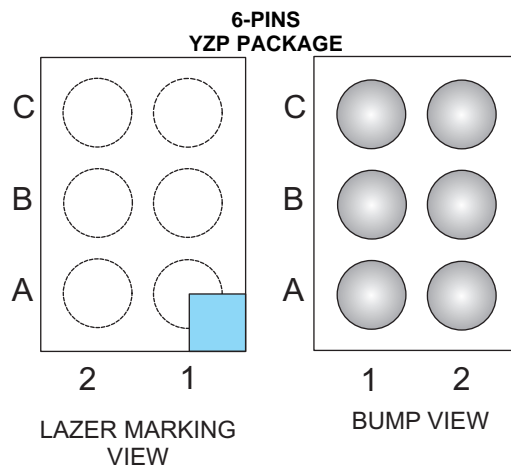

Pin Assignments (YZP Package)

C	GND	ON
B	VOUT	VIN
A	VOUT	VIN
	1	2

Pin Functions

PIN		I/O	DESCRIPTION
TPS22963/64	NAME		
C1	GND	-	Ground
C2	ON	I	Switch control input, active high. Do not leave floating
A1, B1	VOUT	O	Switch output
A2, B2	VIN	I	Switch input. Use a bypass capacitor to ground (ceramic)

8 Specifications

8.1 Absolute Maximum Ratings

over operating free-air temperature range (unless otherwise noted)

		MIN	MAX	UNIT
V_{IN}	Input voltage range	-0.3	6	V
V_{OUT}	Output voltage range	-0.3	6	V
V_{ON}	ON pin voltage range	-0.3	6	V
I_{MAX}	Maximum continuous switch current		3	A
I_{PLS}	Maximum pulsed switch current, 100 μ s pulse, 2% duty cycle, $T_A = -40^\circ\text{C}$ to 85°C		4	A
T_A	Operating free air temperature range	-40	85	$^\circ\text{C}$
T_J	Maximum junction temperature		125	$^\circ\text{C}$
T_{stg}	Storage temperature range	-65	150	$^\circ\text{C}$

8.2 ESD Ratings

		VALUE	UNIT
$V_{(ESD)}$	Electrostatic discharge	Human-body model (HBM), per ANSI/ESDA/JEDEC JS-001 ⁽¹⁾	± 2000
		Charged-device model (CDM), per JEDEC specification JESD22-C101 ⁽²⁾	± 500

- (1) JEDEC document JEP155 states that 500-V HBM allows safe manufacturing with a standard ESD control process. Manufacturing with less than 500-V HBM is possible with the necessary precautions.
- (2) JEDEC document JEP157 states that 250-V CDM allows safe manufacturing with a standard ESD control process. Manufacturing with less than 250-V CDM is possible with the necessary precautions.

8.3 Recommended Operating Conditions

over operating free-air temperature range (unless otherwise noted)

		MIN	TYP	MAX	UNIT
V_{IN}	Input voltage range	1		5.5	V
V_{OUT}	Output voltage range	0		5.5	V
$V_{IH, ON}$	High-level ON voltage	$V_{IN} = 2.5\text{ V to }5.5\text{ V}$	1.3	5.5	V
		$V_{IN} = 1\text{ V to }2.49\text{ V}$	1.1	5.5	
$V_{IL, ON}$	Low-level ON voltage	$V_{IN} = 2.5\text{ V to }5.5\text{ V}$	0	0.6	V
		$V_{IN} = 1\text{ V to }2.49\text{ V}$	0	0.4	
C_{IN}	Input capacitor		1 ⁽¹⁾		μF

- (1) Refer to the application section

8.4 Thermal Information

THERMAL METRIC ⁽¹⁾	TPS2296xC		UNIT
	YZP		
	6 PINS		
$R_{\theta JA}$	Junction-to-ambient thermal resistance	132.0	$^\circ\text{C/W}$
$R_{\theta Jctop}$	Junction-to-case (top) thermal resistance	1.4	
$R_{\theta JB}$	Junction-to-board thermal resistance	22.8	
Ψ_{JT}	Junction-to-top characterization parameter	5.7	
Ψ_{JB}	Junction-to-board characterization parameter	22.6	

- (1) For more information about traditional and new thermal metrics, see the *IC Package Thermal Metrics* application report, [SPRA953](http://www.ti.com/lit/zip/SPR953).

8.5 Electrical Characteristics

 $V_{IN} = 1\text{ V to }5.5\text{ V}$, $T_A = -40^\circ\text{C to }85^\circ\text{C}$ (unless otherwise noted)

PARAMETER		TEST CONDITIONS	T_A	MIN	TYP	MAX	UNIT
$I_{Q, VIN}$	Quiescent current	$I_{OUT} = 0$, $V_{ON} = V_{IN} = 5\text{ V}$	Full		66.5	96	μA
		$I_{OUT} = 0$, $V_{ON} = V_{IN} = 4.5\text{ V}$	Full		57	82	
		$I_{OUT} = 0$, $V_{ON} = V_{IN} = 3.3\text{ V}$	Full		38	60	
		$I_{OUT} = 0$, $V_{ON} = V_{IN} = 2.5\text{ V}$	Full		33.3	55	
		$I_{OUT} = 0$, $V_{ON} = V_{IN} = 1.8\text{ V}$	Full		28.3	45	
		$I_{OUT} = 0$, $V_{ON} = V_{IN} = 1.2\text{ V}$	Full		22.8	36	
		$I_{OUT} = 0$, $V_{ON} = V_{IN} = 1.1\text{ V}$	Full		21.6	34	
		$I_{OUT} = 0$, $V_{ON} = V_{IN} = 1\text{ V}$	Full		20.3	33	
$I_{SD, VIN}$	Shut down current	$V_{ON} = 0$, $V_{IN} = 5\text{ V}$, $V_{OUT} = 0\text{ V}$	Full		0.76	2	μA
		$V_{ON} = 0$, $V_{IN} = 1\text{ V}$, $V_{OUT} = 0\text{ V}$	Full		0.07	0.8	
R_{ON}	On-resistance	$V_{IN} = 5\text{ V}$, $I_{OUT} = -200\text{ mA}$	25°C		13.3	21	$\text{m}\Omega$
			Full			26	
		$V_{IN} = 4.5\text{ V}$, $I_{OUT} = -200\text{ mA}$	25°C		13.3	21	$\text{m}\Omega$
			Full			26	
		$V_{IN} = 3.3\text{ V}$, $I_{OUT} = -200\text{ mA}$	25°C		13.8	22	$\text{m}\Omega$
			Full			27	
		$V_{IN} = 2.5\text{ V}$, $I_{OUT} = -200\text{ mA}$	25°C		15.4	24	$\text{m}\Omega$
			Full			29	
		$V_{IN} = 1.8\text{ V}$, $I_{OUT} = -200\text{ mA}$	25°C		18.2	28	$\text{m}\Omega$
			Full			33	
		$V_{IN} = 1.2\text{ V}$, $I_{OUT} = -200\text{ mA}$	25°C		25.6	37	$\text{m}\Omega$
			Full			44	
		$V_{IN} = 1.1\text{ V}$, $I_{OUT} = -200\text{ mA}$	25°C		28.7	41	$\text{m}\Omega$
			Full			50	
		$V_{IN} = 1\text{ V}$, $I_{OUT} = -200\text{ mA}$	25°C		33.8	48	$\text{m}\Omega$
			Full			60	
$V_{HYS, ON}$	ON pin hysteresis	$V_{IN} = 5\text{ V}$	Full		115	mV	
		$V_{IN} = 4.5\text{ V}$	Full		105		
		$V_{IN} = 3.3\text{ V}$	Full		80		
		$V_{IN} = 2.5\text{ V}$	Full		65		
		$V_{IN} = 1.8\text{ V}$	Full		50		
		$V_{IN} = 1.2\text{ V}$	Full		35		
		$V_{IN} = 1.1\text{ V}$	Full		30		
		$V_{IN} = 1\text{ V}$	Full		30		
I_{ON}	ON pin leakage current	$V_{ON} = 1.1\text{ V to }5.5\text{ V}$	Full			150	nA
$I_{RC, VIN}$	Reverse current when disabled	$V_{IN} = V_{ON} = 0\text{ V}$, $V_{OUT} = 5\text{ V}$	25°C		-0.02	μA	
			85°C		-2.1		
$R_{PD}^{(1)}$	Output pulldown resistance	$V_{ON} = 0\text{ V}$, $I_{OUT} = 2\text{ mA}$	Full		273	325	Ω

(1) Available in TPS22964 only.

8.6 Switching Characteristics

PARAMETER	TEST CONDITION	TPS22963/64	UNIT
		TYP	
$V_{IN} = 5.0\text{ V}$, $T_A = 25^\circ\text{C}$ (unless otherwise noted)			
t_{ON} Turn-ON time	$R_{OUT} = 10\ \Omega$, $C_{IN} = 1\ \mu\text{F}$, $C_{OUT} = 0.1\ \mu\text{F}$	928	μs
t_{OFF} Turn-OFF time	$R_{OUT} = 10\ \Omega$, $C_{IN} = 1\ \mu\text{F}$, $C_{OUT} = 0.1\ \mu\text{F}$	2.5	
t_R VOUT rise time	$R_{OUT} = 10\ \Omega$, $C_{IN} = 1\ \mu\text{F}$, $C_{OUT} = 0.1\ \mu\text{F}$	890	
t_F VOUT fall time	$R_{OUT} = 10\ \Omega$, $C_{IN} = 1\ \mu\text{F}$, $C_{OUT} = 0.1\ \mu\text{F}$	2.1	
t_D Delay time	$R_{OUT} = 10\ \Omega$, $C_{IN} = 1\ \mu\text{F}$, $C_{OUT} = 0.1\ \mu\text{F}$	561	
$V_{IN} = 4.5\text{ V}$, $T_A = 25^\circ\text{C}$ (unless otherwise noted)			
t_{ON} Turn-ON time	$R_{OUT} = 10\ \Omega$, $C_{IN} = 1\ \mu\text{F}$, $C_{OUT} = 0.1\ \mu\text{F}$	905	μs
t_{OFF} Turn-OFF time	$R_{OUT} = 10\ \Omega$, $C_{IN} = 1\ \mu\text{F}$, $C_{OUT} = 0.1\ \mu\text{F}$	2.6	
t_R VOUT rise time	$R_{OUT} = 10\ \Omega$, $C_{IN} = 1\ \mu\text{F}$, $C_{OUT} = 0.1\ \mu\text{F}$	859	
t_F VOUT fall time	$R_{OUT} = 10\ \Omega$, $C_{IN} = 1\ \mu\text{F}$, $C_{OUT} = 0.1\ \mu\text{F}$	2.1	
t_D Delay time	$R_{OUT} = 10\ \Omega$, $C_{IN} = 1\ \mu\text{F}$, $C_{OUT} = 0.1\ \mu\text{F}$	560	
$V_{IN} = 3.3\text{ V}$, $T_A = 25^\circ\text{C}$ (unless otherwise noted)			
t_{ON} Turn-ON time	$R_{OUT} = 10\ \Omega$, $C_{IN} = 1\ \mu\text{F}$, $C_{OUT} = 0.1\ \mu\text{F}$	836	μs
t_{OFF} Turn-OFF time	$R_{OUT} = 10\ \Omega$, $C_{IN} = 1\ \mu\text{F}$, $C_{OUT} = 0.1\ \mu\text{F}$	2.8	
t_R VOUT rise time	$R_{OUT} = 10\ \Omega$, $C_{IN} = 1\ \mu\text{F}$, $C_{OUT} = 0.1\ \mu\text{F}$	715	
t_F VOUT fall time	$R_{OUT} = 10\ \Omega$, $C_{IN} = 1\ \mu\text{F}$, $C_{OUT} = 0.1\ \mu\text{F}$	2	
t_D Delay time	$R_{OUT} = 10\ \Omega$, $C_{IN} = 1\ \mu\text{F}$, $C_{OUT} = 0.1\ \mu\text{F}$	553	
$V_{IN} = 1.8\text{ V}$, $T_A = 25^\circ\text{C}$ (unless otherwise noted)			
t_{ON} Turn-ON time	$R_{OUT} = 10\ \Omega$, $C_{IN} = 1\ \mu\text{F}$, $C_{OUT} = 0.1\ \mu\text{F}$	822	μs
t_{OFF} Turn-OFF time	$R_{OUT} = 10\ \Omega$, $C_{IN} = 1\ \mu\text{F}$, $C_{OUT} = 0.1\ \mu\text{F}$	2.8	
t_R VOUT rise time	$R_{OUT} = 10\ \Omega$, $C_{IN} = 1\ \mu\text{F}$, $C_{OUT} = 0.1\ \mu\text{F}$	651	
t_F VOUT fall time	$R_{OUT} = 10\ \Omega$, $C_{IN} = 1\ \mu\text{F}$, $C_{OUT} = 0.1\ \mu\text{F}$	2	
t_D Delay time	$R_{OUT} = 10\ \Omega$, $C_{IN} = 1\ \mu\text{F}$, $C_{OUT} = 0.1\ \mu\text{F}$	558	
$V_{IN} = 1.2\text{ V}$, $T_A = 25^\circ\text{C}$ (unless otherwise noted)			
t_{ON} Turn-ON time	$R_{OUT} = 10\ \Omega$, $C_{IN} = 1\ \mu\text{F}$, $C_{OUT} = 0.1\ \mu\text{F}$	852	μs
t_{OFF} Turn-OFF time	$R_{OUT} = 10\ \Omega$, $C_{IN} = 1\ \mu\text{F}$, $C_{OUT} = 0.1\ \mu\text{F}$	3.2	
t_R VOUT rise time	$R_{OUT} = 10\ \Omega$, $C_{IN} = 1\ \mu\text{F}$, $C_{OUT} = 0.1\ \mu\text{F}$	535	
t_F VOUT fall time	$R_{OUT} = 10\ \Omega$, $C_{IN} = 1\ \mu\text{F}$, $C_{OUT} = 0.1\ \mu\text{F}$	1.8	
t_D Delay time	$R_{OUT} = 10\ \Omega$, $C_{IN} = 1\ \mu\text{F}$, $C_{OUT} = 0.1\ \mu\text{F}$	594	
$V_{IN} = 1.1\text{ V}$, $T_A = 25^\circ\text{C}$ (unless otherwise noted)			
t_{ON} Turn-ON time	$R_{OUT} = 10\ \Omega$, $C_{IN} = 1\ \mu\text{F}$, $C_{OUT} = 0.1\ \mu\text{F}$	861	μs
t_{OFF} Turn-OFF time	$R_{OUT} = 10\ \Omega$, $C_{IN} = 1\ \mu\text{F}$, $C_{OUT} = 0.1\ \mu\text{F}$	3.5	
t_R VOUT rise time	$R_{OUT} = 10\ \Omega$, $C_{IN} = 1\ \mu\text{F}$, $C_{OUT} = 0.1\ \mu\text{F}$	518	
t_F VOUT fall time	$R_{OUT} = 10\ \Omega$, $C_{IN} = 1\ \mu\text{F}$, $C_{OUT} = 0.1\ \mu\text{F}$	1.9	
t_D Delay time	$R_{OUT} = 10\ \Omega$, $C_{IN} = 1\ \mu\text{F}$, $C_{OUT} = 0.1\ \mu\text{F}$	604	

8.7 Typical Electrical Characteristics



图 1. On Resistance vs V_{IN}



图 2. On Resistance vs Temperature

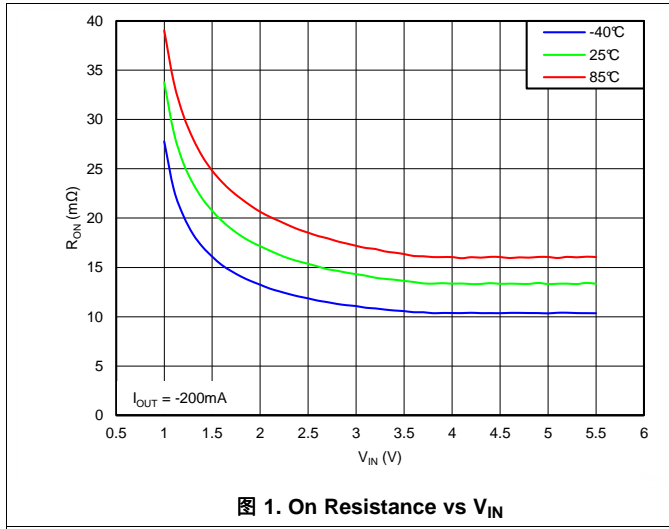

图 3. Quiescent Current vs V_{IN}

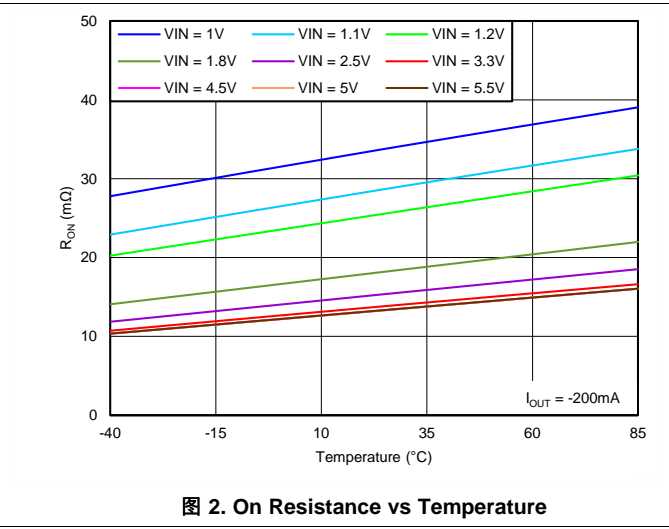

图 4. Quiescent Current vs Temperature

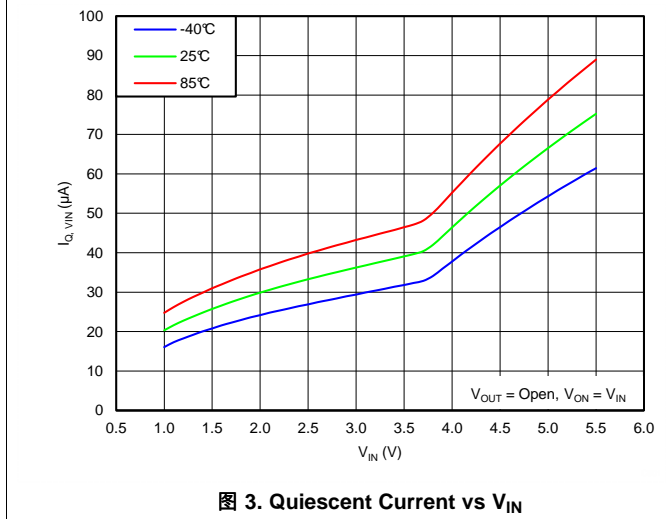

图 5. Shut Down Current vs V_{IN}

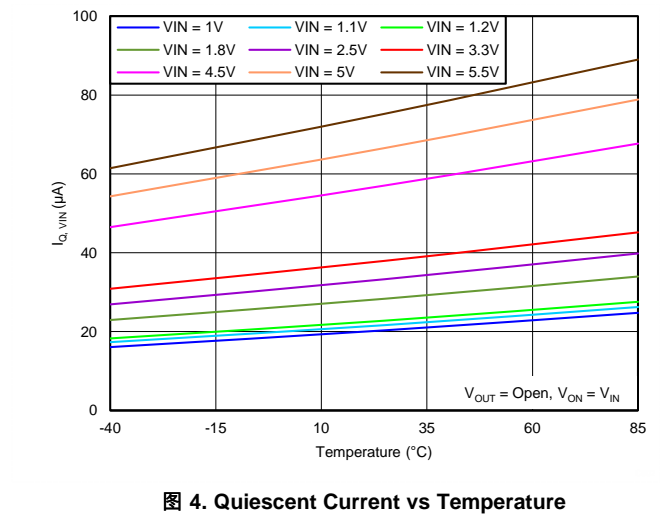

图 6. Shut Down Current vs Temperature

Typical Electrical Characteristics (接下页)

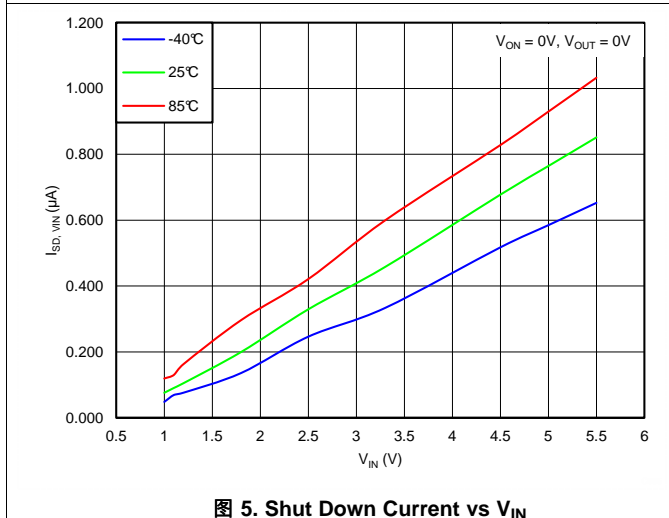

图 7. Output Pulldown Resistance vs VIN

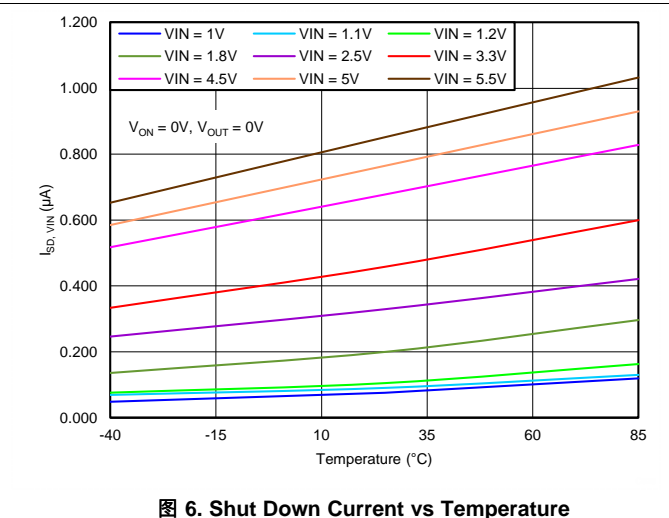

图 8. On Pin Hysteresis vs VIN

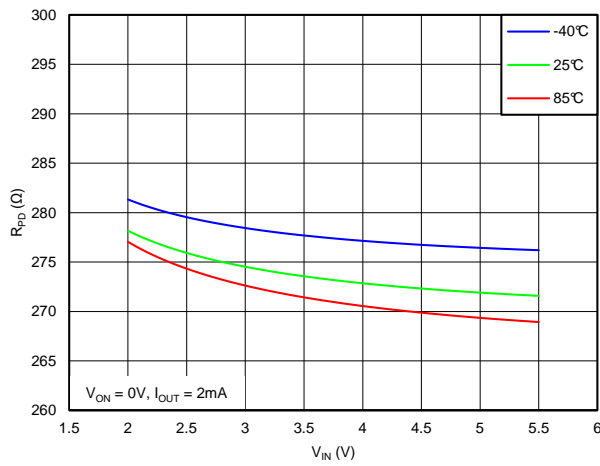

图 9. Output Voltage vs V_ON Rising

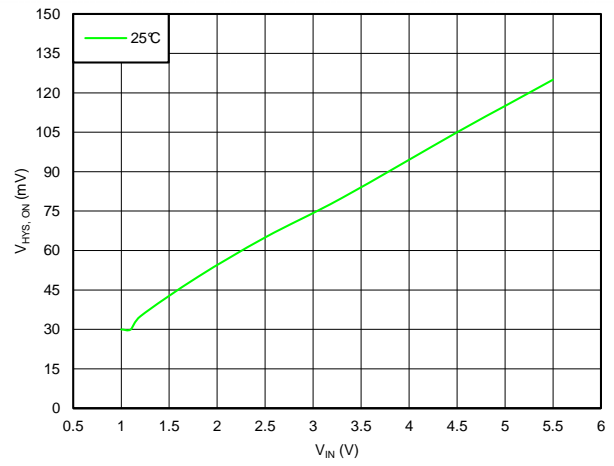

图 10. Output Voltage vs V_ON Falling

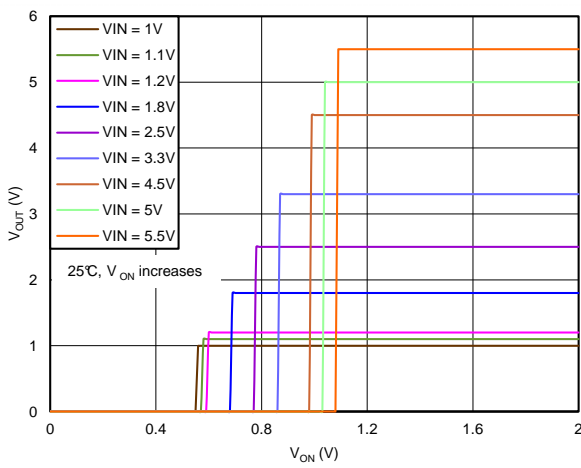

图 11. Reverse Current When Disabled vs Temperature

8.8 Typical Switching Characteristics

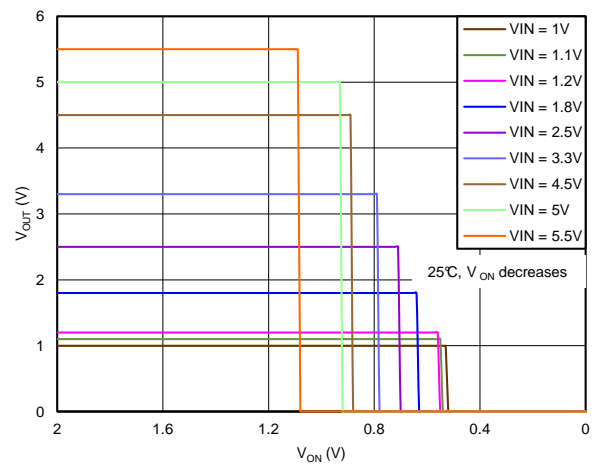

8.9 Typical AC Scope Captures at $T_A = 25^\circ\text{C}$

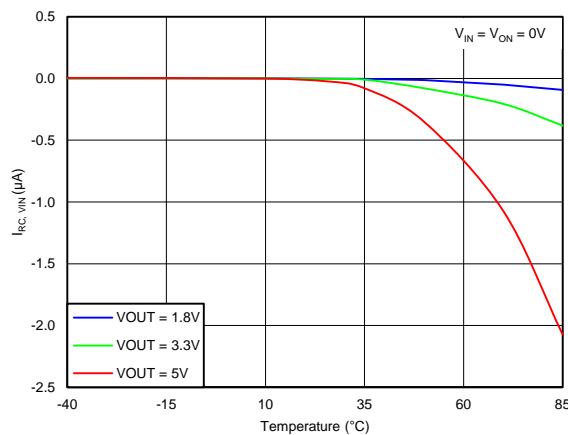
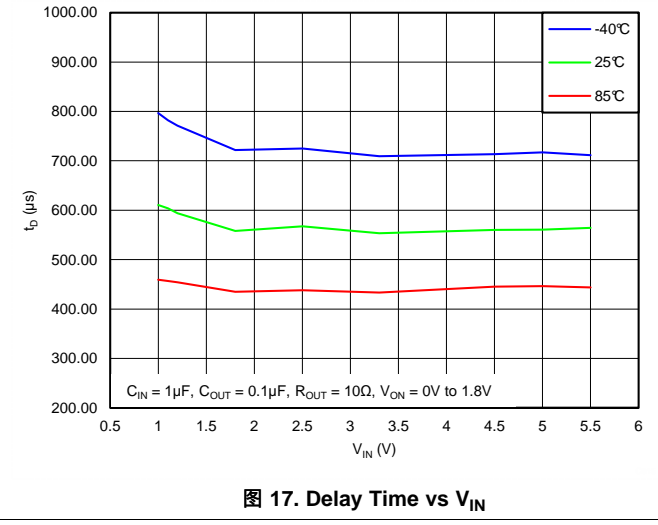
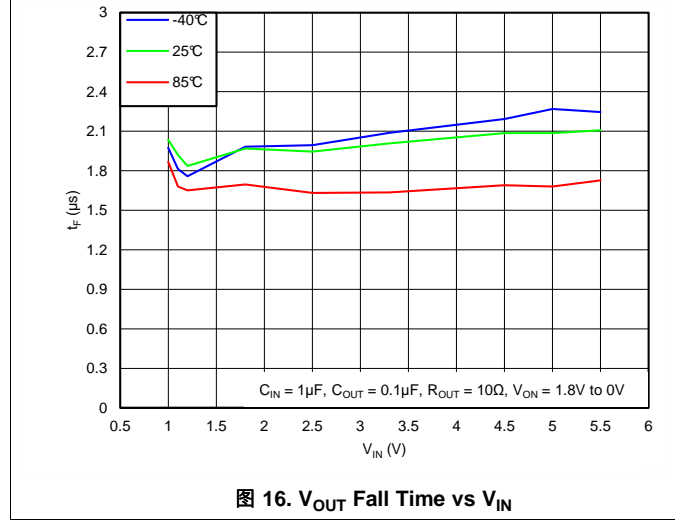
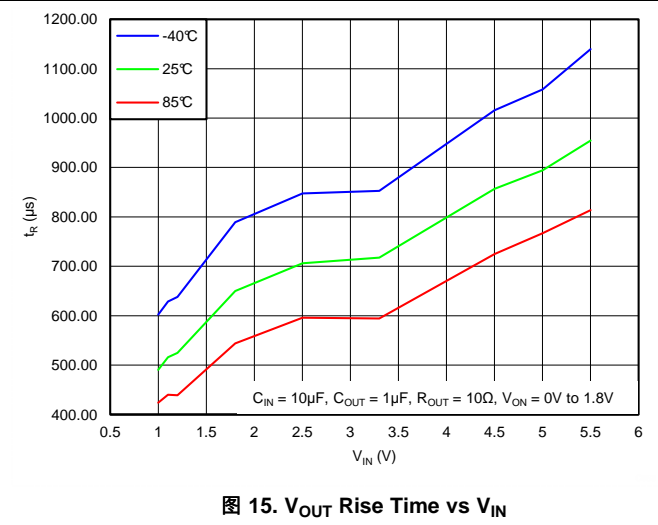
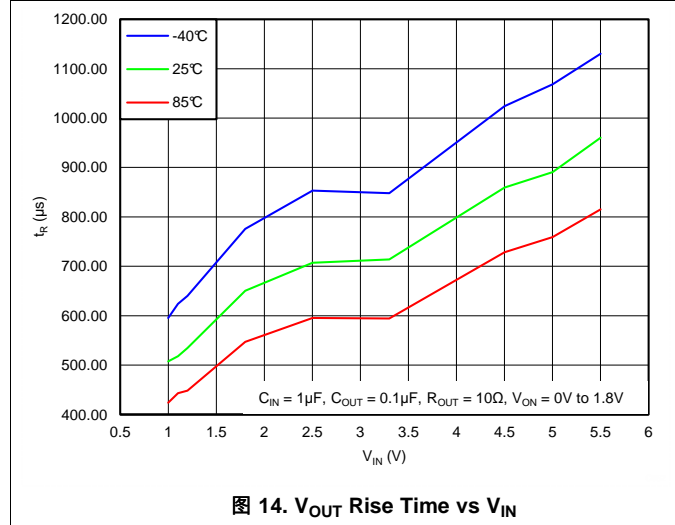
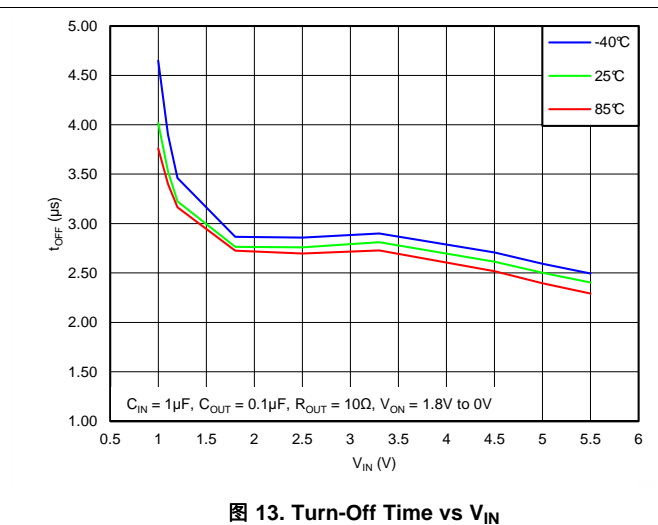
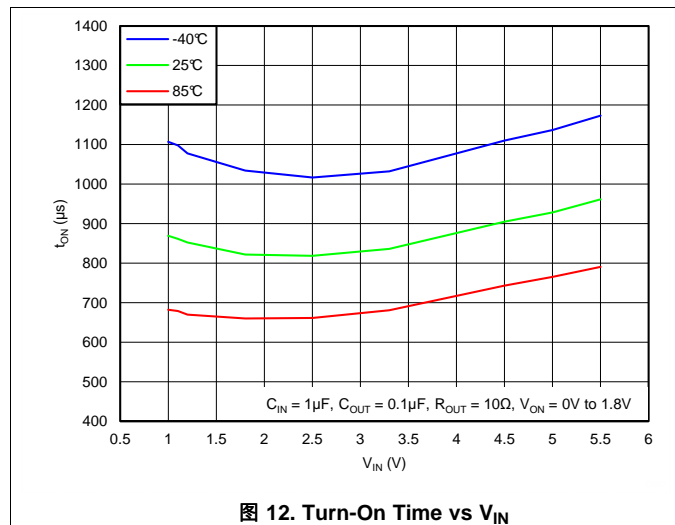
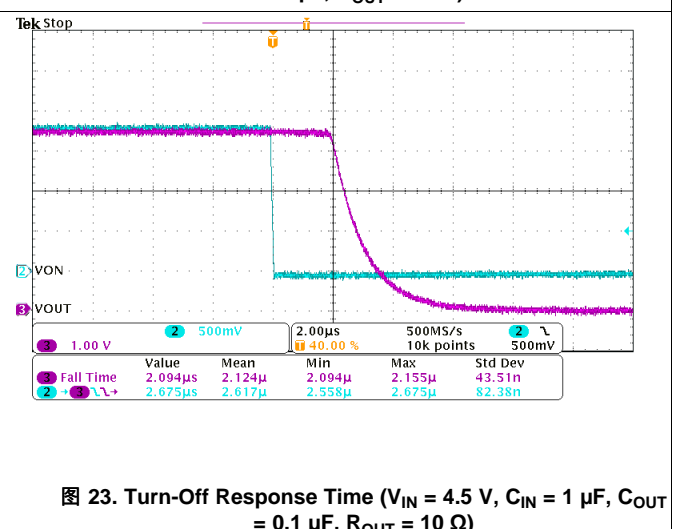
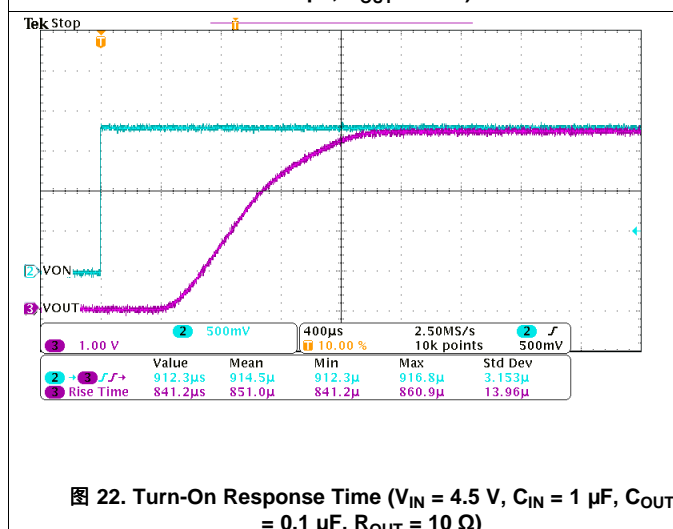
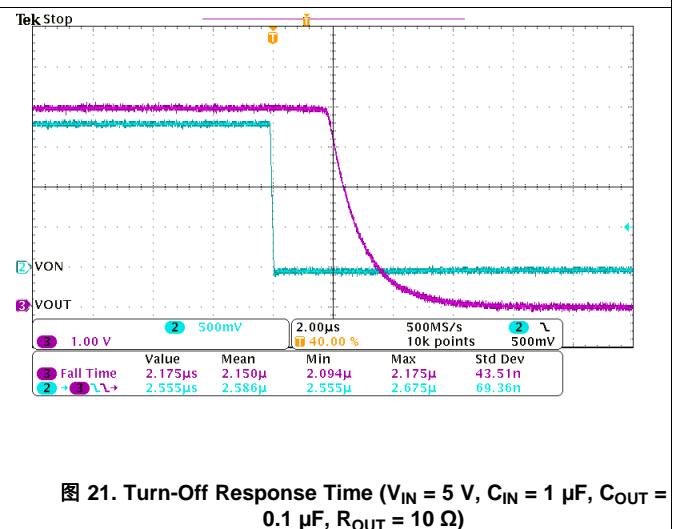
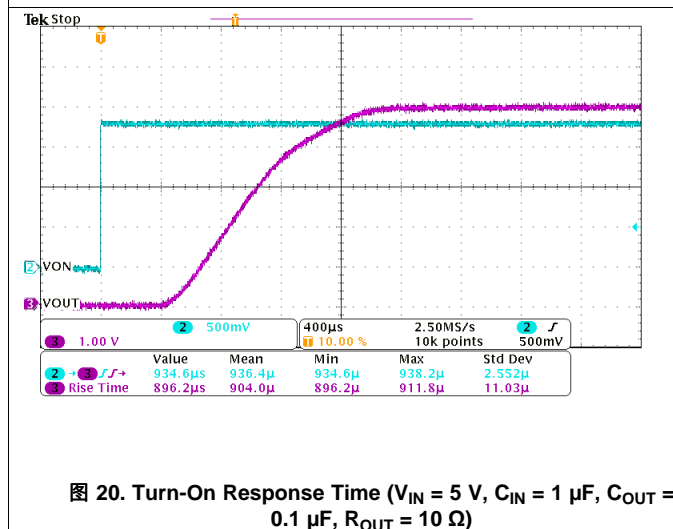
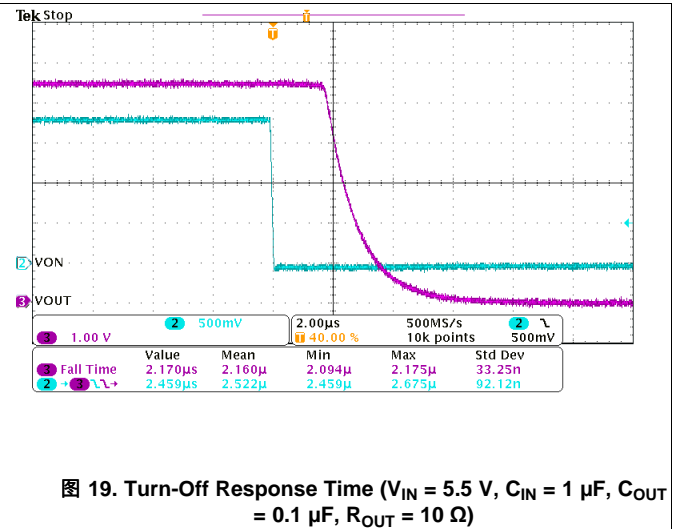
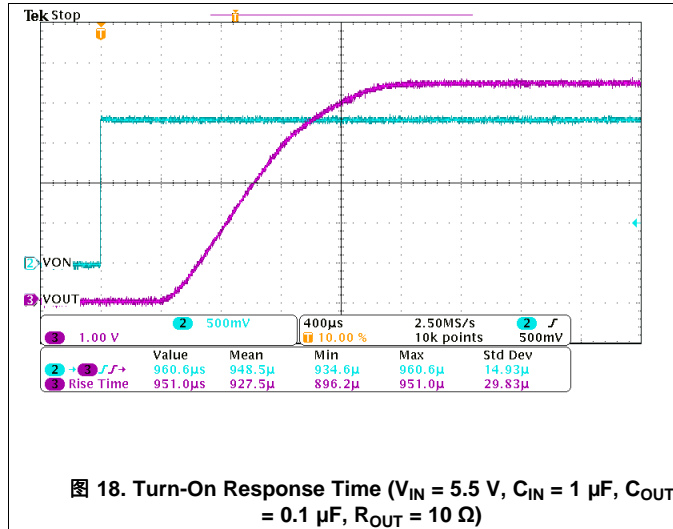

Typical AC Scope Captures at $T_A = 25^\circ\text{C}$ (接下页)



图 24. Turn-On Response Time ($V_{IN} = 3.3\text{ V}$, $C_{IN} = 1\ \mu\text{F}$, $C_{OUT} = 0.1\ \mu\text{F}$, $R_{OUT} = 10\ \Omega$)



图 25. Turn-Off Response Time ($V_{IN} = 3.3\text{ V}$, $C_{IN} = 1\ \mu\text{F}$, $C_{OUT} = 0.1\ \mu\text{F}$, $R_{OUT} = 10\ \Omega$)

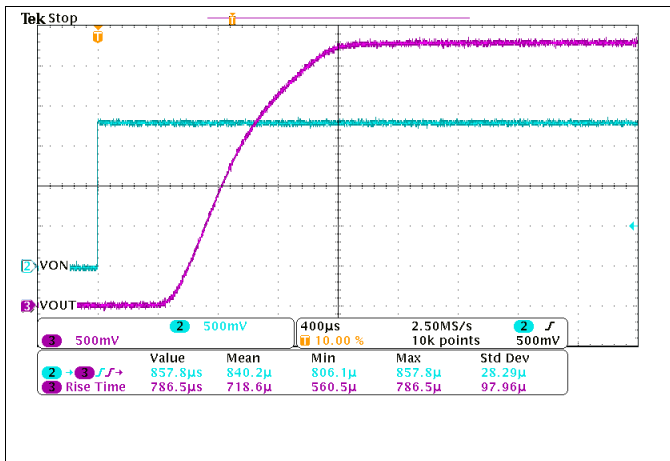

图 26. Turn-On Response Time ($V_{IN} = 2.5\text{ V}$, $C_{IN} = 1\ \mu\text{F}$, $C_{OUT} = 0.1\ \mu\text{F}$, $R_{OUT} = 10\ \Omega$)

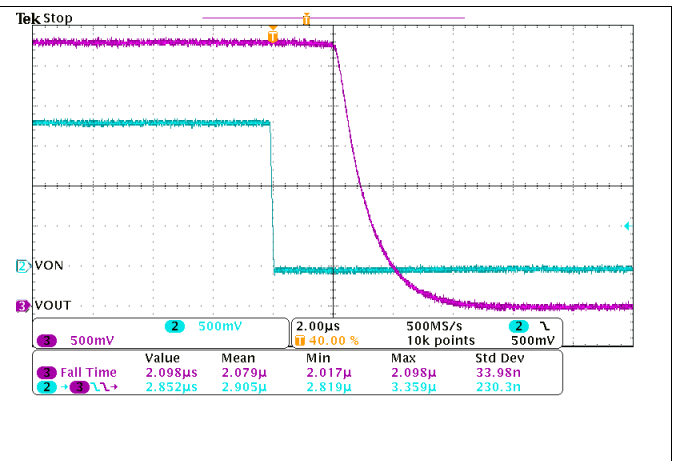

图 27. Turn-Off Response Time ($V_{IN} = 2.5\text{ V}$, $C_{IN} = 1\ \mu\text{F}$, $C_{OUT} = 0.1\ \mu\text{F}$, $R_{OUT} = 10\ \Omega$)

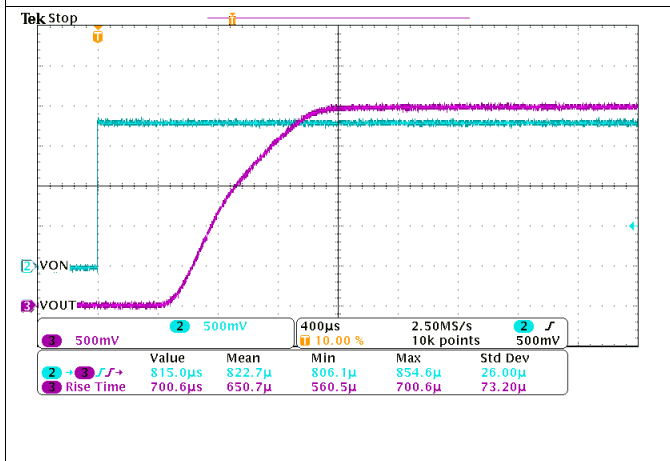

图 28. Turn-On Response Time ($V_{IN} = 1.8\text{ V}$, $C_{IN} = 1\ \mu\text{F}$, $C_{OUT} = 0.1\ \mu\text{F}$, $R_{OUT} = 10\ \Omega$)

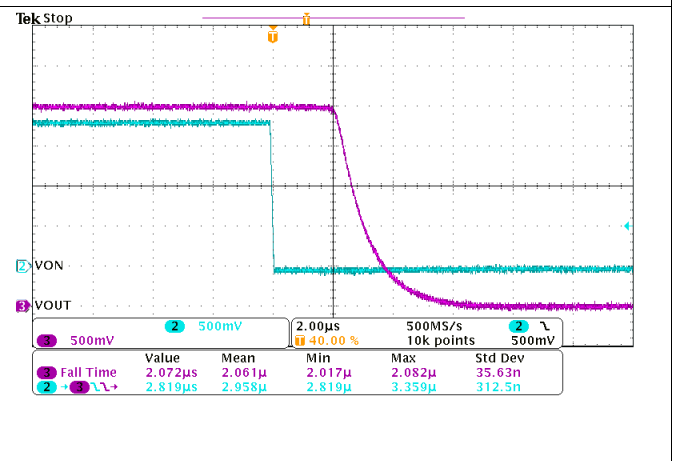

图 29. Turn-Off Response Time ($V_{IN} = 1.8\text{ V}$, $C_{IN} = 1\ \mu\text{F}$, $C_{OUT} = 0.1\ \mu\text{F}$, $R_{OUT} = 10\ \Omega$)

Typical AC Scope Captures at $T_A = 25^\circ\text{C}$ (接下页)

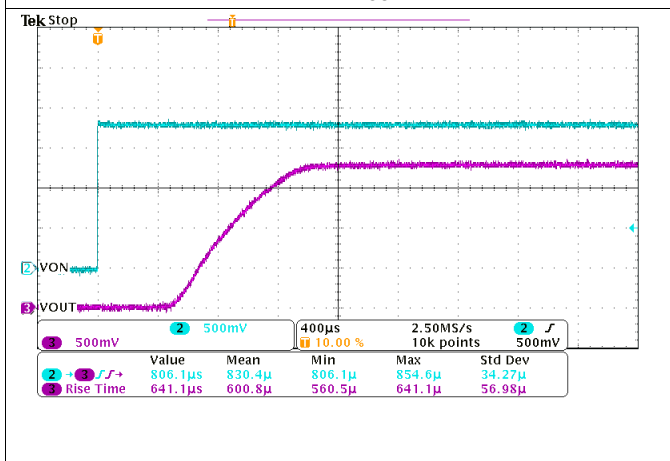

图 30. Turn-On Response Time ($V_{IN} = 1.2\text{ V}$, $C_{IN} = 1\ \mu\text{F}$, $C_{OUT} = 0.1\ \mu\text{F}$, $R_{OUT} = 10\ \Omega$)

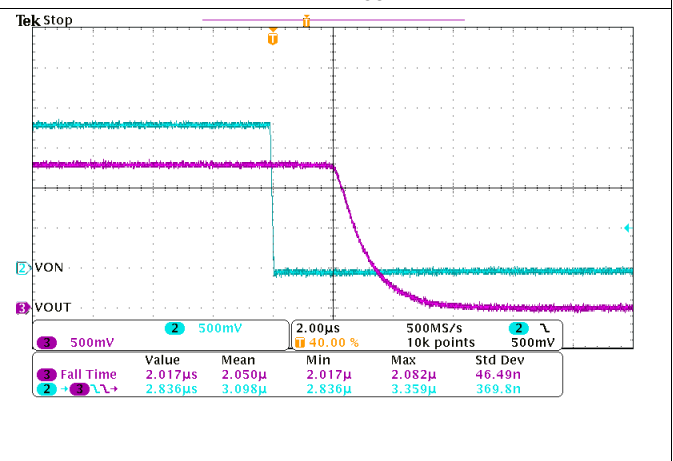

图 31. Turn-Off Response Time ($V_{IN} = 1.2\text{ V}$, $C_{IN} = 1\ \mu\text{F}$, $C_{OUT} = 0.1\ \mu\text{F}$, $R_{OUT} = 10\ \Omega$)

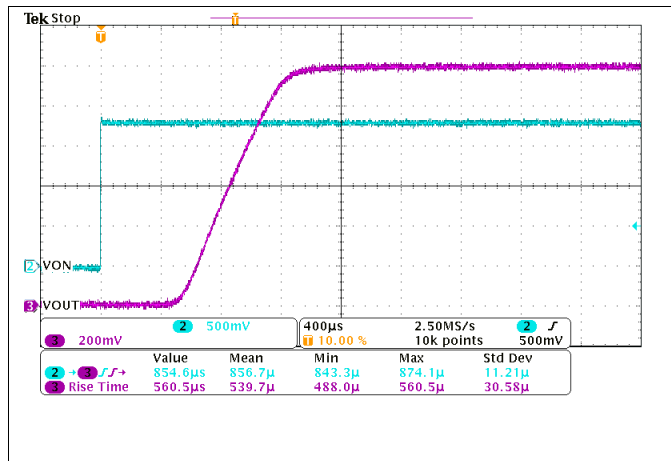

图 32. Turn-On Response Time ($V_{IN} = 1.1\text{ V}$, $C_{IN} = 1\ \mu\text{F}$, $C_{OUT} = 0.1\ \mu\text{F}$, $R_{OUT} = 10\ \Omega$)

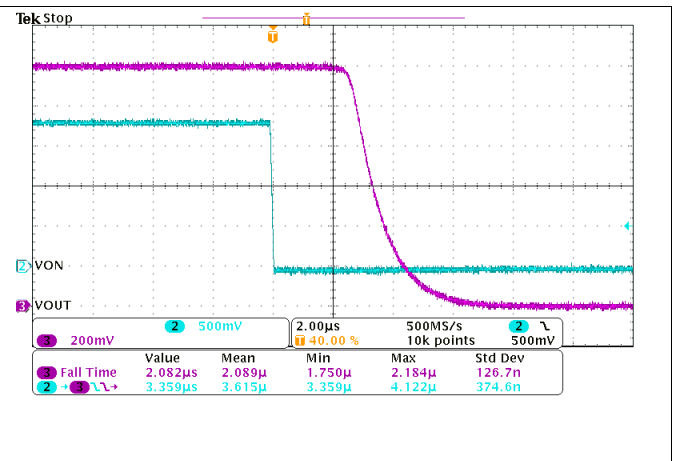

图 33. Turn-Off Response Time ($V_{IN} = 1.1\text{ V}$, $C_{IN} = 1\ \mu\text{F}$, $C_{OUT} = 0.1\ \mu\text{F}$, $R_{OUT} = 10\ \Omega$)

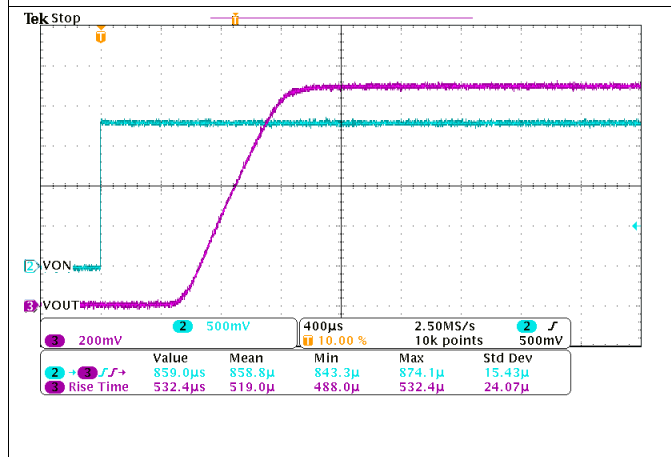

图 34. Turn-On Response Time ($V_{IN} = 1\text{ V}$, $C_{IN} = 1\ \mu\text{F}$, $C_{OUT} = 0.1\ \mu\text{F}$, $R_{OUT} = 10\ \Omega$)

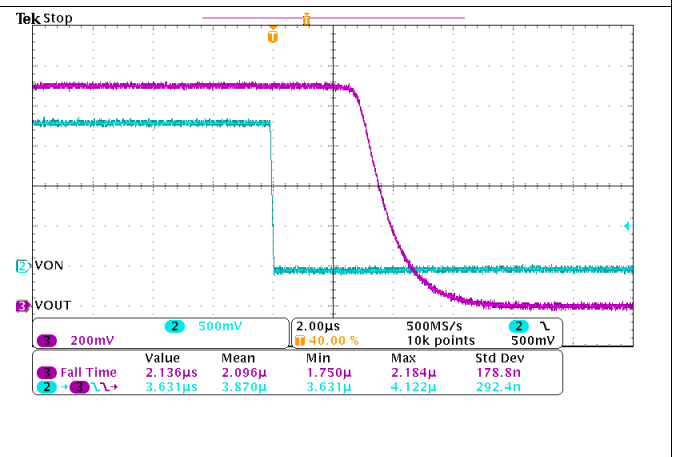

图 35. Turn-Off Response Time ($V_{IN} = 1\text{ V}$, $C_{IN} = 1\ \mu\text{F}$, $C_{OUT} = 0.1\ \mu\text{F}$, $R_{OUT} = 10\ \Omega$)

9 Parametric Measurement Information

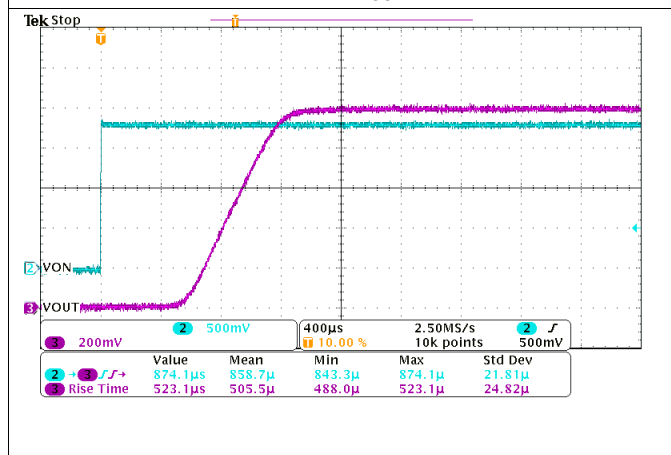

图 36. Test Circuit

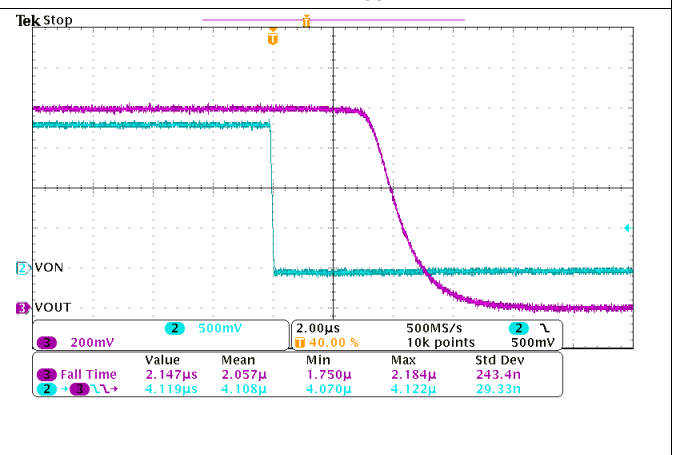

A. Rise and fall times of the control signal are 100 ns.

图 37. Timing Waveforms

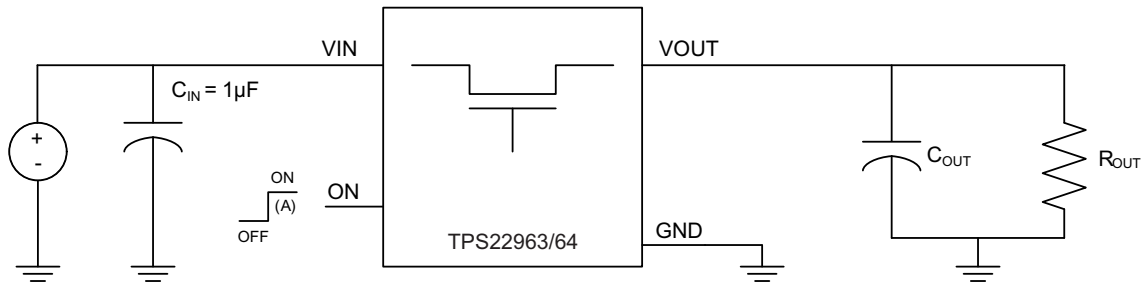
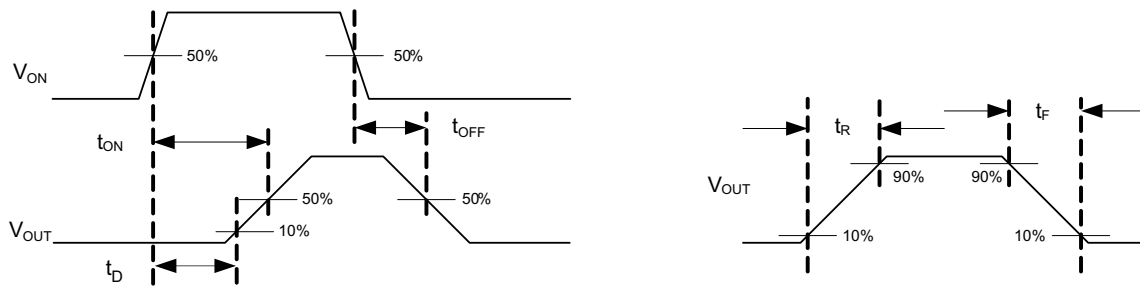
10 Detailed Description

10.1 Overview

The TPS22963/64 is a single channel, 3-A load switch in a small, space saving CSP-6 package. These devices implement an N-channel MOSFET to provide an ultra-low On-resistance for a low voltage drop across the device. A controlled rise time is used in applications to limit the inrush current.

10.2 Functional Block Diagram

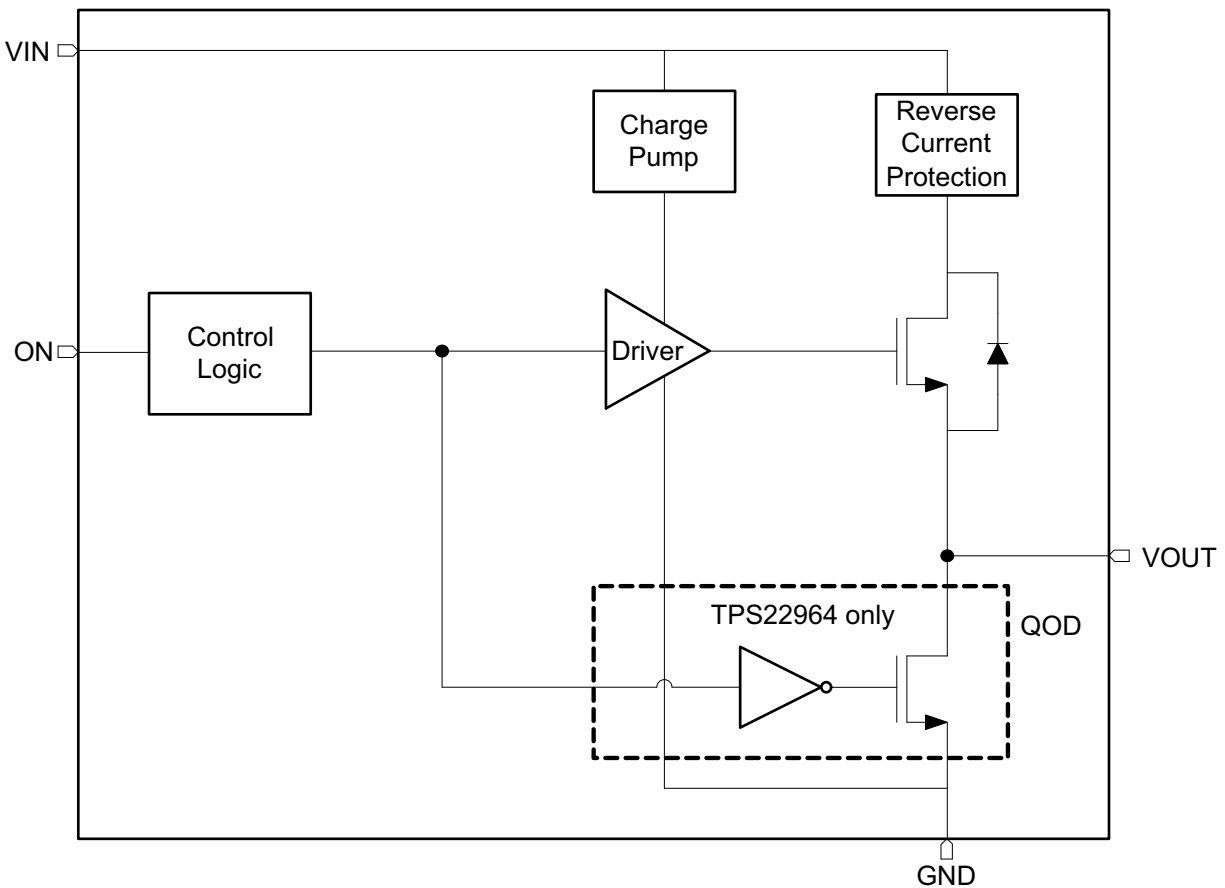

10.3 Feature Description

10.3.1 On/Off Control

The ON pin controls the state of the switch. It is an active “High” pin and has a low threshold making it capable of interfacing with low voltage GPIO control signals. It can be used with any microcontroller with 1.2 V, 1.8 V, 2.5 V, 3.3 V or 5.5 V GPIOs. Applying V_{IH} on the ON pin will put the switch in the ON-state and V_{IL} will put the switch in the OFF-state.

10.3.2 Quick Output Discharge

The TPS22964 includes the Quick Output Discharge (QOD) feature. When the switch is disabled, a discharge resistance with a typical value of 273Ω is connected between the output and ground. This resistance pulls down the output and prevents it from floating when the device is disabled.

10.4 Device Functional Modes

表 1. Function Table

ON	VIN to VOUT	OUTPUT DISCHARGE ^{(1) (2)}
L	OFF	ACTIVE
H	ON	DISABLED

- (1) This feature discharges the output of the switch to ground through a 273 Ω resistor, preventing the output from floating.
- (2) This feature is in the TPS22964 device only (not in the TPS22963).

11 Application and Implementation

注

Information in the following applications sections is not part of the TI component specification, and TI does not warrant its accuracy or completeness. TI's customers are responsible for determining suitability of components for their purposes. Customers should validate and test their design implementation to confirm system functionality.

11.1 Application Information

11.1.1 Input Capacitor

It is recommended to place a capacitor (C_{IN}) between VIN and GND pins of TPS22963/64. This capacitor helps to limit the voltage drop on the input voltage supply when the switch turns ON into a discharged load capacitor. A 1-μF ceramic capacitor that is placed close to the IC pins is usually sufficient. Higher values of C_{IN} can be used to further reduce the voltage drop in high current applications.

11.1.2 Output Capacitor

It is recommended to place a capacitor (C_{OUT}) between VOUT and GND pins of TPS22963/64. This capacitor acts as a low pass filter along with the switch ON-resistance to remove any voltage glitches coming from the input voltage source. It is generally recommended to have C_{IN} greater than C_{OUT} so that once the switch is turned ON, C_{OUT} can charge up to V_{IN} without V_{IN} dropping significantly. A 0.1-μF ceramic capacitor that is placed close to the IC pins is usually sufficient.

Application Information (接下页)

11.1.3 Standby Power Reduction



图 38. Standby Power Reduction

Any end equipment that is being powered from the battery has a need to reduce current consumption in order to keep the battery charged for a longer time. TPS22963/64 helps to accomplish this by turning off the supply to the modules that are in standby state and hence significantly reduces the leakage current overhead of the standby modules.

11.1.4 Reverse Current Protection

The reverse current protection feature prevents the current to flow from VOUT to VIN when TPS22963/64 is disabled. This feature is particularly useful when the output of TPS22963/64 needs to be driven by another voltage source after TPS22963/64 is disabled (for example in a power multiplexer application). In order for this feature to work, TPS22963/64 has to be disabled and either of the following conditions shall be met: $V_{IN} > 1\text{ V}$ or $V_{OUT} > 1\text{ V}$.

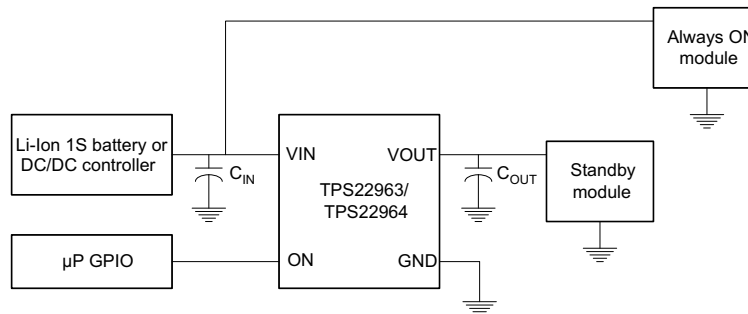
图 39 demonstrates the ideal behavior of reverse current protection circuit in TPS22963/64. After the device is disabled via the ON pin and VOUT is forced to an external voltage V_{FORCE} , a very small amount of current given by $I_{RC,VIN}$ will flow from VOUT to VIN. This will prevent any extra current loading on the voltage source supplying the V_{FORCE} voltage.

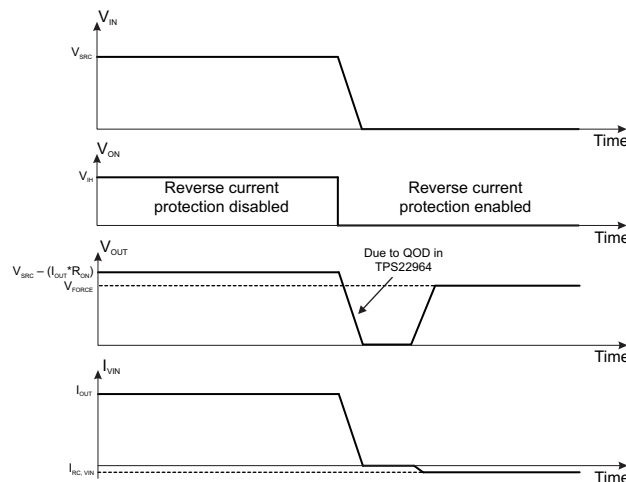

I_{VIN} = Current through VIN pin.

V_{SRC} = Input voltage applied to the device.

V_{FORCE} = External voltage source forced at VOUT pin of the device.

I_{OUT} = Output load current.

图 39. Reverse Current Protection

Application Information (接下页)

11.1.5 Power Supply Sequencing Without a GPIO Input



图 40. Power Supply Sequencing Without a GPIO Input

In many end equipments, there is a need to power up various modules in a pre-determined manner. TPS22963/64 can solve the problem of power sequencing without adding any complexity to the overall system. 图 40 shows the configuration required for powering up two modules in a fixed sequence. The output of the first load switch is tied to the enable of the second load switch, so when Module 1 is powered the second load switch is enabled and Module 2 is powered.

11.2 Typical Application

TPS22963/64 is an ultra-low ON-resistance, 3-A integrated load switch that is capable of interfacing directly with 1S battery in portable consumer devices such as smartphones, tablets etc. Its wide input voltage range (1 V to 5.5 V) makes it suitable to be used for lower voltage rails as well inside different end equipments to accomplish power sequencing, inrush current control and reducing leakage current in sub-systems that are in standby mode. 图 41 shows the typical application circuit of TPS22963/64.

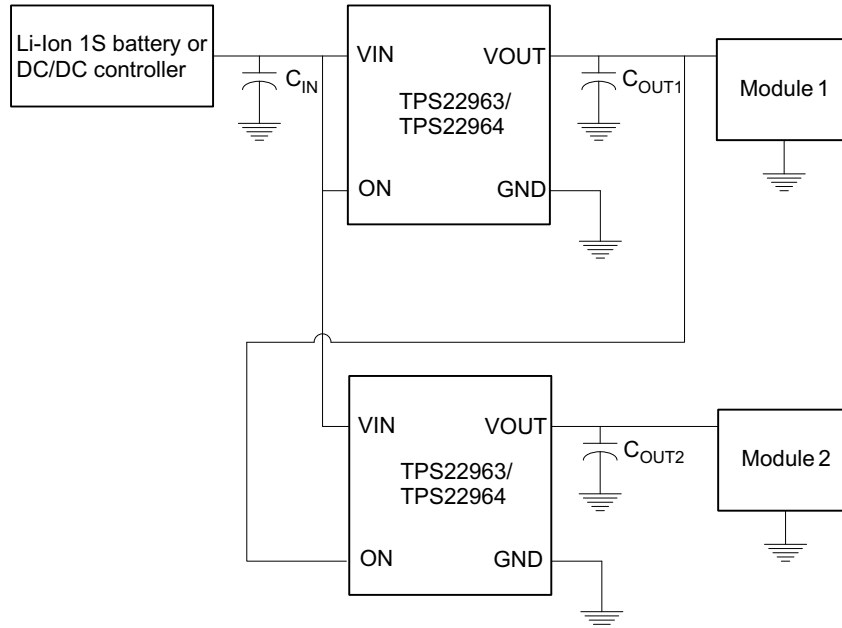

图 41. Typical Application Circuit

11.2.1 Design Requirements

DESIGN PARAMETER	EXAMPLE VALUE
V_{IN}	3.3 V
C_L	4.7 μ F
Maximum Acceptable Inrush Current	30 mA

11.2.2 Detailed Design Procedure

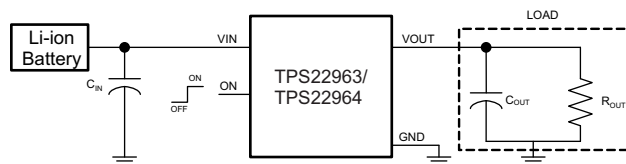
11.2.2.1 Managing Inrush Current

When the switch is enabled, the output capacitors must be charged up from 0 V to the set value (3.3 V in this example). This charge arrives in the form of inrush current. Inrush current can be calculated using the following equation:

$$I_{\text{INRUSH}} = C_L \times \frac{dV_{\text{OUT}}}{dt}$$

where

- C = output capacitance
- dV = output voltage
- dt = rise time

(1)

The TPS22963/64 offers a controlled rise time for minimizing inrush current. This device can be selected based upon the minimum acceptable rise time which can be calculated using the design requirements and the inrush current equation. An output capacitance of 4.7 μF will be used since the amount of inrush current increases with output capacitance:

$$30 \text{ mA} = 4.7 \text{ } \mu\text{F} \times 3.3 \text{ V} / dt \tag{2}$$

$$dt = 517 \text{ } \mu\text{s} \tag{3}$$

To ensure an inrush current of less than 30 mA, a device with a rise time greater than 517 μs must be used. The TPS22963/64 has a typical rise time of 715 μs at 3.3 V which meets the above design requirements.

11.2.3 Application Curves

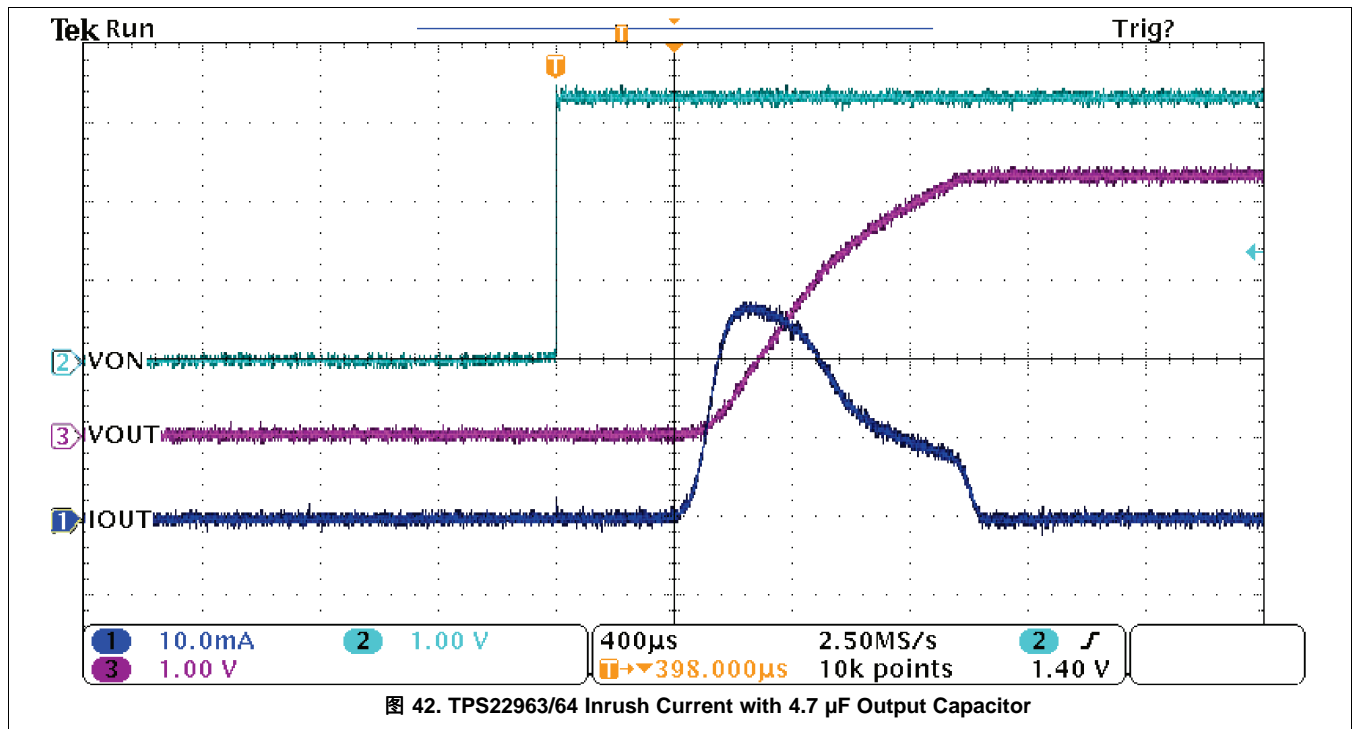

12 Power Supply Recommendations

The device is designed to operate with a VIN range of 1 V to 5.5 V. This supply must be well regulated and placed as close to the device terminal as possible with the recommended 1 μF bypass capacitor. If the supply is located more than a few inches from the device terminals, additional bulk capacitance may be required in addition to the ceramic bypass capacitors. If additional bulk capacitance is required, an electrolytic, tantalum, or ceramic capacitor of 10 μF may be sufficient.

13 Layout

13.1 Layout Guidelines

For best performance, all traces should be as short as possible. To be most effective, the input and output capacitors should be placed close to the device to minimize the effects that parasitic trace inductances may have on normal operation. Using wide traces for VIN, VOUT and GND will help minimize the parasitic electrical effects.

For higher reliability, the maximum IC junction temperature, $T_{J(max)}$, should be restricted to 125°C under normal operating conditions. Junction temperature is directly proportional to power dissipation in the device and the two are related by 公式 4.

$$T_J = T_A + \Theta_{JA} \times P_D$$

where

- T_J = Junction temperature of the device
- T_A = Ambient temperature
- P_D = Power dissipation inside the device
- Θ_{JA} = Junction to ambient thermal resistance. See Thermal Information section of the datasheet. This parameter is highly dependent on board layout.

(4)

13.2 Layout Example



图 43. Layout Example

14 器件和文档支持

14.1 相关链接

以下表格列出了快速访问链接。范围包括技术文档、支持与社区资源、工具和软件，并且可以快速访问样片或购买链接。

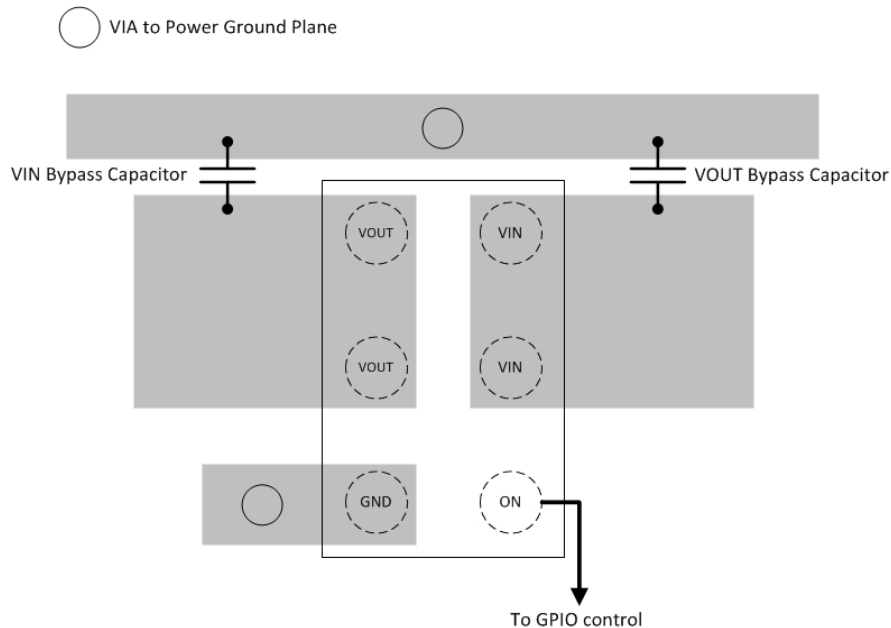
表 2. 相关链接

器件	产品文件夹	样片与购买	技术文档	工具与软件	支持与社区
TPS22963C	请单击此处	请单击此处	请单击此处	请单击此处	请单击此处
TPS22964C	请单击此处	请单击此处	请单击此处	请单击此处	请单击此处

14.2 商标

超极本 is a trademark of Intel Corporation in the U.S. and/or other countries.
All other trademarks are the property of their respective owners.

14.3 静电放电警告



这些装置包含有限的内置 ESD 保护。存储或装卸时，应将导线一起截短或将装置放置于导电泡棉中，以防止 MOS 门极遭受静电损伤。

14.4 术语表

[SLYZ022](#) — TI 术语表。

这份术语表列出并解释术语、首字母缩略词和定义。

15 机械封装和可订购信息

以下页中包括机械封装和可订购信息。 这些信息是针对指定器件可提供的最新数据。 这些数据会在无通知且不对本文档进行修订的情况下发生改变。 欲获得该数据表的浏览器版本，请查阅左侧的导航栏。

PACKAGING INFORMATION

Orderable part number	Status (1)	Material type (2)	Package Pins	Package qty Carrier	RoHS (3)	Lead finish/ Ball material (4)	MSL rating/ Peak reflow (5)	Op temp (°C)	Part marking (6)
TPS22963CZPZR	Active	Production	DSBGA (YZP) 6	3000 LARGE T&R	Yes	SNAGCU	Level-1-260C-UNLIM	-40 to 85	BD
TPS22963CZPZR.A	Active	Production	DSBGA (YZP) 6	3000 LARGE T&R	Yes	SNAGCU	Level-1-260C-UNLIM	-40 to 85	BD
TPS22963CZPZPT	Active	Production	DSBGA (YZP) 6	250 SMALL T&R	Yes	SNAGCU	Level-1-260C-UNLIM	-40 to 85	BD
TPS22963CZPZPT.A	Active	Production	DSBGA (YZP) 6	250 SMALL T&R	Yes	SNAGCU	Level-1-260C-UNLIM	-40 to 85	BD
TPS22964C2YZPZR	Active	Production	DSBGA (YZP) 6	6000 JUMBO T&R	Yes	SNAGCU	Level-1-260C-UNLIM	-40 to 85	DK
TPS22964C2YZPZR.A	Active	Production	DSBGA (YZP) 6	6000 JUMBO T&R	Yes	SNAGCU	Level-1-260C-UNLIM	-40 to 85	DK
TPS22964CZPZR	Active	Production	DSBGA (YZP) 6	3000 LARGE T&R	Yes	SNAGCU	Level-1-260C-UNLIM	-40 to 85	DK
TPS22964CZPZR.A	Active	Production	DSBGA (YZP) 6	3000 LARGE T&R	Yes	SNAGCU	Level-1-260C-UNLIM	-40 to 85	DK
TPS22964CZPZPT	Active	Production	DSBGA (YZP) 6	250 SMALL T&R	Yes	SNAGCU	Level-1-260C-UNLIM	-40 to 85	DK
TPS22964CZPZPT.A	Active	Production	DSBGA (YZP) 6	250 SMALL T&R	Yes	SNAGCU	Level-1-260C-UNLIM	-40 to 85	DK

(1) **Status:** For more details on status, see our [product life cycle](#).

(2) **Material type:** When designated, preproduction parts are prototypes/experimental devices, and are not yet approved or released for full production. Testing and final process, including without limitation quality assurance, reliability performance testing, and/or process qualification, may not yet be complete, and this item is subject to further changes or possible discontinuation. If available for ordering, purchases will be subject to an additional waiver at checkout, and are intended for early internal evaluation purposes only. These items are sold without warranties of any kind.

(3) **RoHS values:** Yes, No, RoHS Exempt. See the [TI RoHS Statement](#) for additional information and value definition.

(4) **Lead finish/Ball material:** Parts may have multiple material finish options. Finish options are separated by a vertical ruled line. Lead finish/Ball material values may wrap to two lines if the finish value exceeds the maximum column width.

(5) **MSL rating/Peak reflow:** The moisture sensitivity level ratings and peak solder (reflow) temperatures. In the event that a part has multiple moisture sensitivity ratings, only the lowest level per JEDEC standards is shown. Refer to the shipping label for the actual reflow temperature that will be used to mount the part to the printed circuit board.

(6) **Part marking:** There may be an additional marking, which relates to the logo, the lot trace code information, or the environmental category of the part.

Multiple part markings will be inside parentheses. Only one part marking contained in parentheses and separated by a "~" will appear on a part. If a line is indented then it is a continuation of the previous line and the two combined represent the entire part marking for that device.

Important Information and Disclaimer: The information provided on this page represents TI's knowledge and belief as of the date that it is provided. TI bases its knowledge and belief on information provided by third parties, and makes no representation or warranty as to the accuracy of such information. Efforts are underway to better integrate information from third parties. TI has taken and continues to take reasonable steps to provide representative

and accurate information but may not have conducted destructive testing or chemical analysis on incoming materials and chemicals. TI and TI suppliers consider certain information to be proprietary, and thus CAS numbers and other limited information may not be available for release.

In no event shall TI's liability arising out of such information exceed the total purchase price of the TI part(s) at issue in this document sold by TI to Customer on an annual basis.

TAPE AND REEL INFORMATION

QUADRANT ASSIGNMENTS FOR PIN 1 ORIENTATION IN TAPE

*All dimensions are nominal

Device	Package Type	Package Drawing	Pins	SPQ	Reel Diameter (mm)	Reel Width W1 (mm)	A0 (mm)	B0 (mm)	K0 (mm)	P1 (mm)	W (mm)	Pin1 Quadrant
TPS22963CYZPR	DSBGA	YZP	6	3000	180.0	8.4	1.04	1.54	0.56	4.0	8.0	Q1
TPS22963CYZPT	DSBGA	YZP	6	250	180.0	8.4	1.04	1.54	0.56	4.0	8.0	Q1
TPS22964C2YZPR	DSBGA	YZP	6	6000	180.0	8.4	1.04	1.57	0.6	2.0	8.0	Q1
TPS22964CYZPR	DSBGA	YZP	6	3000	180.0	8.4	1.04	1.54	0.56	4.0	8.0	Q1
TPS22964CYZPT	DSBGA	YZP	6	250	180.0	8.4	1.04	1.54	0.56	4.0	8.0	Q1

TAPE AND REEL BOX DIMENSIONS



*All dimensions are nominal

Device	Package Type	Package Drawing	Pins	SPQ	Length (mm)	Width (mm)	Height (mm)
TPS22963CZPR	DSBGA	YZP	6	3000	182.0	182.0	20.0
TPS22963CZPT	DSBGA	YZP	6	250	182.0	182.0	20.0
TPS22964C2YZPR	DSBGA	YZP	6	6000	182.0	182.0	20.0
TPS22964CZPR	DSBGA	YZP	6	3000	182.0	182.0	20.0
TPS22964CZPT	DSBGA	YZP	6	250	182.0	182.0	20.0

YZP0006



PACKAGE OUTLINE

DSBGA - 0.5 mm max height

DIE SIZE BALL GRID ARRAY

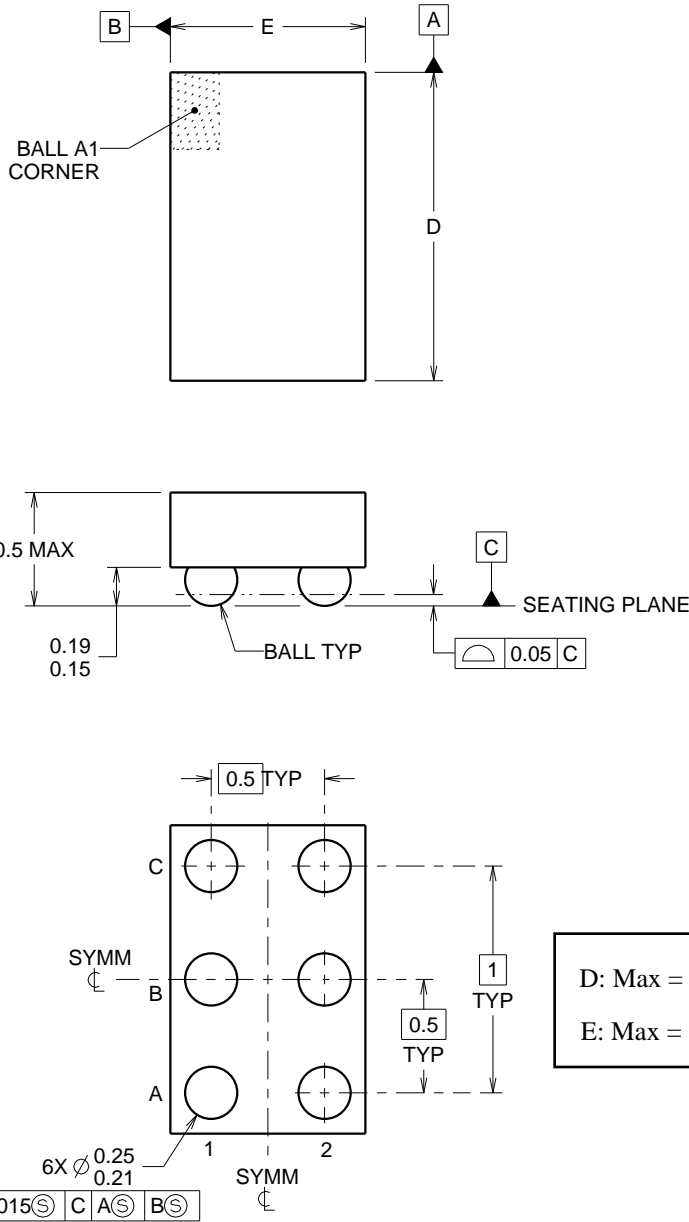

4219524/A 06/2014

NOTES:

NanoFree Is a trademark of Texas Instruments.

1. All linear dimensions are in millimeters. Any dimensions in parenthesis are for reference only. Dimensioning and tolerancing per ASME Y14.5M.
2. This drawing is subject to change without notice.
3. NanoFree™ package configuration.

EXAMPLE BOARD LAYOUT

YZP0006

DSBGA - 0.5 mm max height

DIE SIZE BALL GRID ARRAY



LAND PATTERN EXAMPLE
SCALE:40X



SOLDER MASK DETAILS
NOT TO SCALE

4219524/A 06/2014

NOTES: (continued)

- Final dimensions may vary due to manufacturing tolerance considerations and also routing constraints. For more information, see Texas Instruments literature number SBVA017 (www.ti.com/lit/sbva017).

EXAMPLE STENCIL DESIGN

YZP0006

DSBGA - 0.5 mm max height

DIE SIZE BALL GRID ARRAY

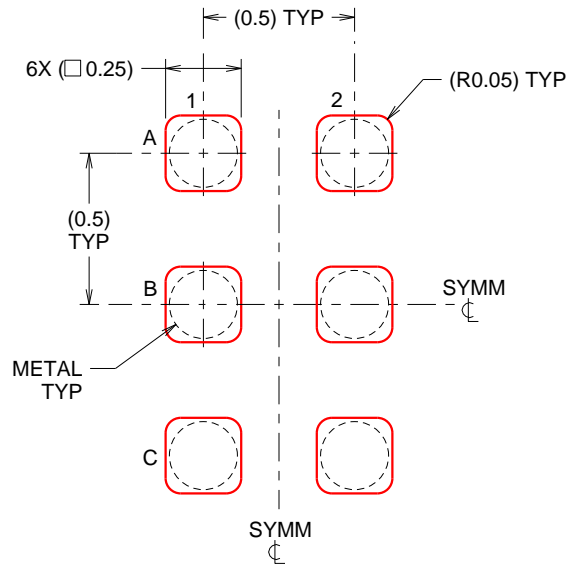

SOLDER PASTE EXAMPLE
BASED ON 0.1 mm THICK STENCIL
SCALE:40X

4219524/A 06/2014

NOTES: (continued)

5. Laser cutting apertures with trapezoidal walls and rounded corners may offer better paste release.

重要通知和免责声明

TI“按原样”提供技术和可靠性数据（包括数据表）、设计资源（包括参考设计）、应用或其他设计建议、网络工具、安全信息和其他资源，不保证没有瑕疵且不做任何明示或暗示的担保，包括但不限于对适销性、与某特定用途的适用性或不侵犯任何第三方知识产权的暗示担保。

这些资源可供使用 TI 产品进行设计的熟练开发人员使用。您将自行承担以下全部责任：(1) 针对您的应用选择合适的 TI 产品，(2) 设计、验证并测试您的应用，(3) 确保您的应用满足相应标准以及任何其他安全、安保法规或其他要求。

这些资源如有变更，恕不另行通知。TI 授权您仅可将这些资源用于研发本资源所述的 TI 产品的相关应用。严禁以其他方式对这些资源进行复制或展示。您无权使用任何其他 TI 知识产权或任何第三方知识产权。对于因您对这些资源的使用而对 TI 及其代表造成的任何索赔、损害、成本、损失和债务，您将全额赔偿，TI 对此概不负责。

TI 提供的产品受 [TI 销售条款](#)、[TI 通用质量指南](#) 或 [ti.com](#) 上其他适用条款或 TI 产品随附的其他适用条款的约束。TI 提供这些资源并不会扩展或以其他方式更改 TI 针对 TI 产品发布的适用的担保或担保免责声明。除非德州仪器 (TI) 明确将某产品指定为定制产品或客户特定产品，否则其产品均为按确定价格收入目录的标准通用器件。

TI 反对并拒绝您可能提出的任何其他或不同的条款。

版权所有 © 2025，德州仪器 (TI) 公司

最后更新日期：2025 年 10 月