

## 双通道、限流、配电开关

 查询样品: [TPS2052C](#), [TPS2062C](#), [TPS2062C-2](#), [TPS2066C](#), [TPS2066C-2](#), [TPS2060C](#), [TPS2064C](#), [TPS2064C-2](#), [TPS2002C](#), [TPS2003C](#)

### 特性

- 双电源开关系列
- **0.5A, 1A, 1.5A, 2A** 的额定电流
- 准确度为  $\pm 20\%$  的电流限值容限
- 快速过流响应 - **2 $\mu$ s** (典型值)
- **70m $\Omega$**  (典型值) 高侧 N 通道金属氧化物半导体场效应晶体管 (MOSFET)
- 工作电压范围: **4.5V 至 5.5V**
- 去尖峰脉冲故障报告 (**FLT $\bar{x}$** )
- 所选的具有 (**TPS20xxC**) 和不具有 (**TPS20xxC-2**) 输出放电的部件

- 反向电流阻断
- 内置软启动
- 与现有的 **TI 开关系列产品** 引脚到引脚相对应
- 环境温度范围: **-40°C 至 85°C**

### 应用范围

- **USB** 端口/集线器、笔记本、台式机
- 高清数字电视
- 机顶盒
- 短路保护功能

### 说明

TPS20xxC 和 TPS20xxC-2 双配电开关系列产品用于诸如 USB 等有可能遇到高电容负载和短路的应用。这一系列产品为电流介于 0.5A 和 2A 之间的应用提供具有固定电流限值阈值的多种器件。

当输出负载超过电流限值阈值时, TPS20xxC 和 TPS20xxC-2 通过运行在恒定电流模式下来将输出电流限制在安全的水平上。这就在所有条件下提供了一个可预计的故障电流。当输出被短接时, 快速过载响应时间减轻了主 5V 电源提供稳压电源的负担。为了大大减少打开和关闭期间的电流冲击, 电源开关的上升和下降次数受到控制。



Figure 1. TYPICAL APPLICATION

Table 1. Devices

RATED CURRENT	DEVICES	STATUS			
		MSOP-8 (PowerPad™)	SON -10	SOIC-8	SON-8
0.5 A	TPS2052C	Active	—	—	—
1 A	TPS2062C and 66C	Active and Active	—	Active and Active	—
1 A	TPS2062C-2 and 66C-2	— and Active	—	—	Active and —
1.5 A	TPS2060C and 64C	Active and Active	—	—	—
1.5 A	TPS2064C-2	Active	—	—	—
2 A	TPS2002C and 03C	—	Active and Active	—	—



Please be aware that an important notice concerning availability, standard warranty, and use in critical applications of Texas Instruments semiconductor products and disclaimers thereto appears at the end of this data sheet.

PowerPAD is a trademark of Texas Instruments.

PRODUCTION DATA information is current as of publication date. Products conform to specifications per the terms of the Texas Instruments standard warranty. Production processing does not necessarily include testing of all parameters.



This integrated circuit can be damaged by ESD. Texas Instruments recommends that all integrated circuits be handled with appropriate precautions. Failure to observe proper handling and installation procedures can cause damage.

ESD damage can range from subtle performance degradation to complete device failure. Precision integrated circuits may be more susceptible to damage because very small parametric changes could cause the device not to meet its published specifications.

### DEVICE INFORMATION<sup>(1)(2)</sup>

MAXIMUM OPERATING CURRENT	ENABLE	OUTPUT DISCHARGE	BASE PART NUMBER	PACKAGE DEVICES and MARKING <sup>(3)</sup>			
				SOIC-8 (D)	MSOP-8 (DGN) PowerPAD™	SON-10 (DRC)	SON-8 (DRB)
0.5	High	Y	TPS2052C	–	PYNI	–	–
1	Low	Y	TPS2062C	2062C	VRBQ	–	–
1	Low	N	TPS2062C-2	–	–	–	PYVI
1	High	Y	TPS2066C	2066C	VRDQ	–	–
1	High	N	TPS2066C-2	–	PYUI	–	–
1.5	Low	Y	TPS2060C	–	VRAQ	–	–
1.5	High	Y	TPS2064C	–	VRCQ	–	–
1.5	High	N	TPS2064C-2	–	PYTI	–	–
2	Low	Y	TPS2002C	–	–	VREQ	–
2	High	Y	TPS2003C	–	–	VRFQ	–

- (1) For the most current packaging and ordering information, see the Package Option Addendum at the end of this document, or see the TI website at [www.ti.com](http://www.ti.com).
- (2) Package code for MSOP-8 is “DGN” and for SON is “DRC”.
- (3) “–” indicates the device is not available in this package.

### ABSOLUTE MAXIMUM RATINGS<sup>(1)(2)</sup>

		VALUE		UNIT
		MIN	MAX	
Voltage range on IN, OUTx, ENx or $\overline{ENx}$ , $\overline{FLT_x}$ <sup>(3)</sup>		–0.3	6	V
Voltage range from IN to OUT		–6	6	V
Maximum junction temperature, T <sub>J</sub>		Internally Limited		°C
ESD	Human Body Model		2	kV
	Charged Device Model		500	V
	IEC 61000-4-2, Contact / Air <sup>(4)</sup>		8 / 15	kV

- (1) Absolute maximum ratings apply over recommended junction temperature range.
- (2) All voltages are with respect to GND unless otherwise noted.
- (3) See [INPUT AND OUTPUT CAPACITANCE](#) section.
- (4) V<sub>OUT</sub> was surged on a PCB with input and output bypassing per [Figure 1](#) (except input capacitor was 22 μF) with no device failure.

### THERMAL INFORMATION

THERMAL METRIC <sup>(1)(2)</sup>		D	DGN	DRC	DRB	UNITS
		8 PINS	8 PINS	10 PINS	8-PINS	
θ <sub>JA</sub>	Junction-to-ambient thermal resistance	129.9	57.2	45.4	50.8	°C/W
θ <sub>JCtop</sub>	Junction-to-case (top) thermal resistance	83.5	110.5	58	60.3	
θ <sub>JB</sub>	Junction-to-board thermal resistance	70.4	60.7	21.1	26.3	
ψ <sub>JT</sub>	Junction-to-top characterization parameter	36.6	7.8	1.9	2.1	
ψ <sub>JB</sub>	Junction-to-board characterization parameter	66.9	24	21.3	26.5	
θ <sub>JCbot</sub>	Junction-to-case (bottom) thermal resistance	n/a	14.3	9.1	9.8	

- (1) 有关传统和新的热 度量的更多信息，请参阅 [IC 封装热量应用报告](#)，[SPRA953](#)。
- (2) 有关该器件的基于印刷电路板 (PCB) 覆铜区的热评估信息，请参阅 [TI PCB 热应力 计算](#)。

**RECOMMENDED OPERATING CONDITIONS**

		MIN	NOM	MAX	UNIT
$V_{IN}$	Input voltage, IN	4.5		5.5	V
$V_{Enable}$	Input voltage, ENx or $\overline{ENx}$	0		5.5	
$I_{OUTx}$	Continuous output current, OUTx	TPS2052C		0.5	A
		TPS2062C, 62C-2, 66C, and 66C-2		1	
		TPS2060C, 64C and 64C-2		1.5	
		TPS2002C and 03C		2	
$T_J$	Operating junction temperature	-40		125	°C
$I_{FLTx}$	Sink current into $\overline{FLTx}$	0		5	mA

**ELECTRICAL CHARACTERISTICS<sup>(1)</sup>**
 $T_J = T_A = 25^\circ\text{C}$ ,  $V_{IN} = 5\text{ V}$ ,  $V_{ENx} = V_{IN}$  or  $V_{\overline{ENx}} = 0\text{ V}$  (unless otherwise noted)

PARAMETER		TEST CONDITIONS		MIN	TYP	MAX	UNIT	
<b>POWER SWITCH</b>								
$r_{DS(on)}$	On-resistance	TPS2052C (0.5 A)		DGN	70	84	mΩ	
		TPS2052C (0.5 A)		DGN	70	95		
		-40°C ≤ (T <sub>J</sub> , T <sub>A</sub> ) ≤ 85°C						
		TPS2062C, 66C, and 66C-2 (1 A)		DGN	70	84		
		TPS2062C, 66C, and 66C-2 (1 A),		DGN	70	95		
		-40°C ≤ (T <sub>J</sub> , T <sub>A</sub> ) ≤ 85°C						
		TPS2062C and 66C (1 A)		D	90	108		
		TPS2062C and 66C (1 A),		D	90	122		
		-40°C ≤ (T <sub>J</sub> , T <sub>A</sub> ) ≤ 85°C						
		TPS2062C-2 (1 A)		DRB	73	87		
		TPS2062C-2 (1 A)		DRB	73	101		
-40°C ≤ (T <sub>J</sub> , T <sub>A</sub> ) ≤ 85°C								
TPS2060C, 64C, and 64C-2 (1.5 A)			70	84				
TPS2060C, 64C, and 64C-2 (1.5 A),			70	95				
-40°C ≤ (T <sub>J</sub> , T <sub>A</sub> ) ≤ 85°C								
TPS2002C and 03C (2 A)			70	84				
TPS2002C and 03C (2 A),			70	95				
-40°C ≤ (T <sub>J</sub> , T <sub>A</sub> ) ≤ 85°C								
<b>CURRENT LIMIT</b>								
$I_{OS}$	Current limit, See <a href="#">Figure 7</a>	TPS2052C (0.5 A)		0.75	1	1.25	A	
		TPS2062C, 62C-2, 66C, and 66C-2 (1 A)		1.28	1.61	1.94		
		TPS2060C, 64C, and 64C-2 (1.5 A)		1.83	2.29	2.75		
		TPS2002C and 03C (2 A)		2.55	3.15	3.77		
$t_{IOS}$	Short-circuit response time	$V_{IN} = 5\text{ V}$ (see <a href="#">Figure 6</a> ), One-half full load → $R_{(SHORT)} = 50\text{ m}\Omega$ , Measure from application to when current falls below 120% of final value			2		μs	
<b>SUPPLY CURRENT</b>								
$I_{SD}$	Supply current, device disabled	$I_{(OUTx)} = 0\text{ mA}$			0.01	1	μA	
$I_{S1E}$	Supply current, single switch enabled	$I_{(OUTx)} = 0\text{ mA}$			60	75		
$I_{S2E}$	Supply current, both switches enabled	$I_{(OUTx)} = 0\text{ mA}$			100	120		
$I_{LKG}$	Leakage current	$V_{OUT} = 0\text{ V}$ , $V_{IN} = 5.5\text{ V}$ , disabled, measured $I_{VIN}$		TPS20xxC-2	0.05	1		
	Reverse leakage current	$V_{OUT} = 5.5\text{ V}$ , $V_{IN} = 0\text{ V}$ , measured $I_{OUTx}$			0.15	1		
<b>OUTPUT DISCHARGE</b>								
$R_{PD}$	Output pull-down resistance <sup>(2)</sup>	$V_{IN} = V_{(OUTx)} = 5\text{ V}$ , disabled		TPS20xxC	400	470	600	Ω

(1) Pulsed testing techniques maintain junction temperature approximately equal to ambient temperature

(2) These parameters are provided for reference only, and do not constitute part of TI's published device specifications for purposes of TI's product warranty.

## ELECTRICAL CHARACTERISTICS

–40°C ≤ (T<sub>J</sub> = T<sub>A</sub>) ≤ 125°C, 4.5 V ≤ V<sub>IN</sub> ≤ 5.5 V, V<sub>ENx</sub> = V<sub>IN</sub> or V<sub>ENx</sub> = 0 V, I<sub>OUTx</sub> = 0 A, typical values are at 5 V and 25°C (unless otherwise noted)

PARAMETER		TEST CONDITIONS <sup>(1)</sup>		MIN	TYP	MAX	UNIT	
<b>POWER SWITCH</b>								
r <sub>DS(on)</sub>	On-resistance	TPS2052C (0.5 A)	DGN		70	112	mΩ	
		TPS2062C, 66C, and 66C-2 (1 A)	DGN		70	112		
		TPS2062C and 66C (1 A)	D		90	135		
		TPS2062C-2 (1 A)	DRB		73	115		
		TPS2060C, 64C, and 64C-2 (1.5 A)	DGN		70	112		
		TPS2002C and 03C (2 A)	DRC		70	112		
<b>ENABLE INPUT (ENx or ENx̄)</b>								
V <sub>IH</sub>	ENx (ENx̄), High-level input voltage	4.5 V ≤ V <sub>IN</sub> ≤ 5.5 V		2			V	
V <sub>IL</sub>	ENx (ENx̄), Low-level input Voltage					0.8		
	Hysteresis	V <sub>IN</sub> = 5 V		0.14				
	Leakage current	V <sub>ENx</sub> = 5.5 V or 0 V, V <sub>ENx</sub> = 0 V or 5.5 V		-1	0	1	μA	
t <sub>on</sub>	Turn-on time <sup>(2)</sup>	V <sub>IN</sub> = 5 V, C <sub>L</sub> = 1 μF, R <sub>L</sub> = 100 Ω, ENx ↑ or ENx ↓, See <a href="#">Figure 4</a> , <a href="#">Figure 5</a> , and <a href="#">Figure 2</a>					ms	
		1 A, 1.5 A, 2 A Rated		1.4	1.9	2.4		
t <sub>off</sub>	Turn-off time <sup>(2)</sup>	V <sub>IN</sub> = 5 V, C <sub>L</sub> = 1 μF, R <sub>L</sub> = 100 Ω, ENx ↑ or ENx ↓, See <a href="#">Figure 4</a> , <a href="#">Figure 5</a> , and <a href="#">Figure 2</a>					ms	
		1 A, 1.5 A, 2 A Rated		1.95	2.60	3.25		
t <sub>r</sub>	Rise time, output <sup>(2)</sup>	C <sub>L</sub> = 1 μF, R <sub>L</sub> = 100 Ω, see <a href="#">Figure 3</a>					ms	
		1 A, 1.5 A, 2 A Rated		0.58	0.82	1.15		
t <sub>f</sub>	Fall time, output <sup>(2)</sup>	C <sub>L</sub> = 1 μF, R <sub>L</sub> = 100 Ω, see <a href="#">Figure 3</a>					ms	
		1 A, 1.5 A, 2 A Rated		0.33	0.47	0.66		
<b>CURRENT LIMIT</b>								
I <sub>OS</sub>	Current-limit, See <a href="#">Figure 7</a>	TPS2052C (0.5A)		0.7	1	1.3	A	
		TPS2062C, 62C-2, 66C, and 66C-2 (1 A)		1.12	1.61	2.10		
		TPS2060C, 64C, and 64C-2 (1.5 A)		1.72	2.29	2.86		
		TPS2002C and 03C (2 A)		2.35	3.15	3.95		
t <sub>IOS</sub>	Short-circuit response time	V <sub>IN</sub> = 5 V (see <a href="#">Figure 6</a> ), One-half full load → R <sub>(SHORT)</sub> = 50 mΩ, measure from application to when current falls below 120% of final value		2			μs	
<b>SUPPLY CURRENT</b>								
I <sub>SD</sub>	Supply current, switch disabled	Standard conditions, I <sub>(OUTx)</sub> = 0 mA		0.01		10	μA	
I <sub>S1E</sub>	Supply current, single switch enabled	Standard conditions, I <sub>(OUTx)</sub> = 0 mA				90		
I <sub>S2E</sub>	Supply current, both switches enabled	Standard conditions, I <sub>(OUTx)</sub> = 0 mA				150		
I <sub>LKG</sub>	Leakage current	V <sub>OUT</sub> = 0 V, V <sub>IN</sub> = 5.5 V, disabled, measured I <sub>VIN</sub>	TPS20xxC-2	0.05				
	Reverse leakage current	V <sub>OUT</sub> = 5.5 V, V <sub>IN</sub> = 0 V, measured I <sub>(OUTx)</sub>		0.20				
<b>UNDERVOLTAGE LOCKOUT</b>								
UVLO	Low-level input voltage, IN	VIN rising		3.4		4.0	V	
	Hysteresis, IN			0.14			V	
<b>FLTx</b>								
	Output low voltage, FLTx	I <sub>(FLTx)</sub> = 1 mA				0.2	V	
	Off-state leakage	V <sub>(FLTx)</sub> = 5.5 V				1	μA	
	FLTx deglitch <sup>(2)</sup>	FLTx overcurrent assertion and deassertion		7		10	13	ms

(1) Pulsed testing techniques maintain junction temperature approximately equal to ambient temperature

(2) These parameters are provided for reference only, and do not constitute part of TI's published device specifications for purposes of TI's product warranty.

**ELECTRICAL CHARACTERISTICS (continued)**

$-40^{\circ}\text{C} \leq (T_J = T_A) \leq 125^{\circ}\text{C}$ ,  $4.5\text{ V} \leq V_{IN} \leq 5.5\text{ V}$ ,  $V_{ENx} = V_{IN}$  or  $V_{ENx} = 0\text{ V}$ ,  $I_{OUTx} = 0\text{ A}$ , typical values are at  $5\text{ V}$  and  $25^{\circ}\text{C}$  (unless otherwise noted)

PARAMETER	TEST CONDITIONS <sup>(1)</sup>		MIN	TYP	MAX	UNIT
<b>OUTPUT DISCHARGE</b>						
Output pull-down resistance <sup>(3)</sup>	$V_{IN} = 5\text{ V}$ , $V_{OUT} = 5\text{ V}$ , disabled	TPS20xxC	300	470	800	$\Omega$
	$V_{IN} = 4\text{ V}$ , $V_{OUT} = 5\text{ V}$ , disabled	TPS20xxC	350	560	1200	
<b>THERMAL SHUTDOWN</b>						
Junction thermal shutdown threshold	In current limit		135			$^{\circ}\text{C}$
	Not in current limit		155			
Hysteresis			20			$^{\circ}\text{C}$

(3) These parameters are provided for reference only, and do not constitute part of TI's published device specifications for purposes of TI's product warranty.

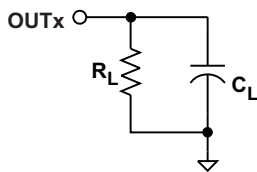

Figure 2. Output Rise / Fall Test Load

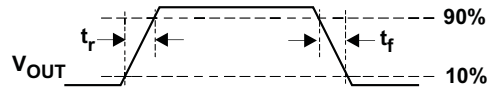

Figure 3. Power-On and Off Timing

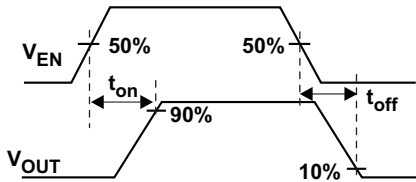

Figure 4. Enable Timing, Active High Enable

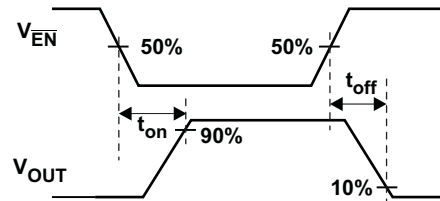

Figure 5. Enable Timing, Active Low Enable

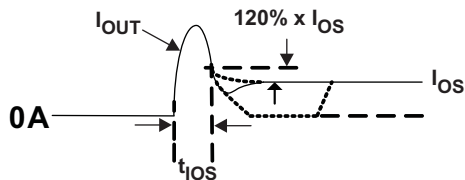

Figure 6. Output Short Circuit Parameters

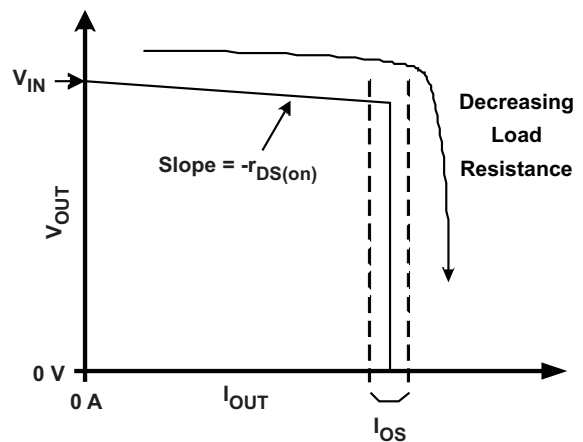
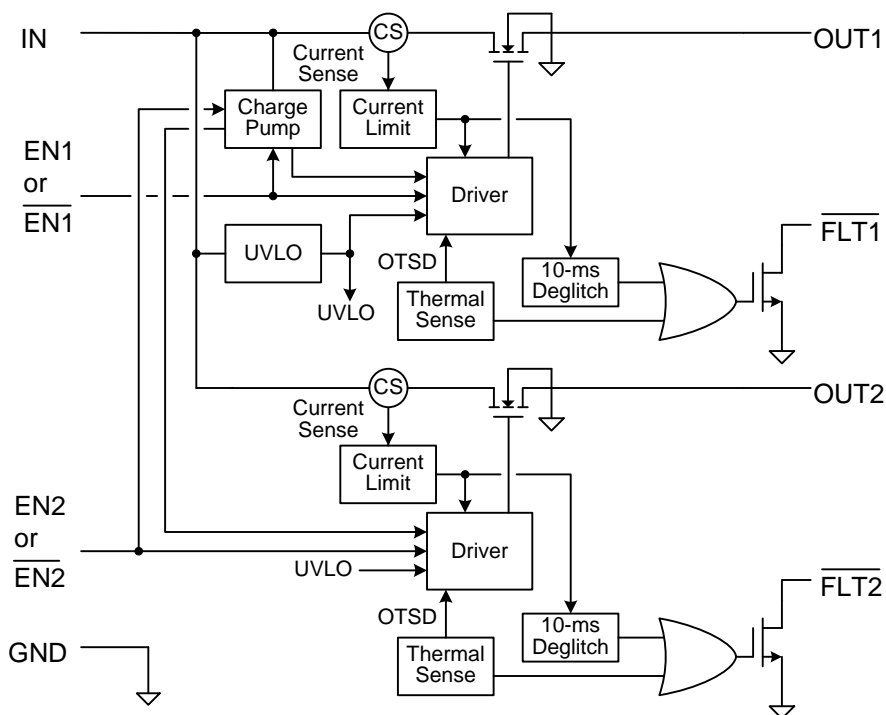

Figure 7. Output Characteristic Showing Current Limit

**FUNCTIONAL BLOCK DIAGRAM**



**Figure 8. TPS20xxC FUNCTIONAL BLOCK DIAGRAM**



**Figure 9. TPS20xxC-2 FUNCTIONAL BLOCK DIAGRAM**

**DEVICE INFORMATION**
**PIN FUNCTIONS – MSOP-8 PACKAGES**

NAME	TPS2052C TPS2066C TPS2066C-2 TPS2064C TPS2064C-2	TPS2062C TPS2060C	I/O	DESCRIPTION
GND	1	1	Pwr	Ground connection
IN	2	2	I	Input voltage and power-switch drain; connect a 0.1 $\mu$ F or greater ceramic capacitor from IN to GND close to the IC
EN1	3	-	I	Enable input channel 1, logic high turns on power switch
$\overline{\text{EN1}}$	-	3	I	Enable input channel 1, logic low turns on power switch
EN2	4	-	I	Enable input channel 2, logic high turns on power switch
$\overline{\text{EN2}}$	-	4	I	Enable input channel 2, logic low turns on power switch
$\overline{\text{FLT2}}$	5	5	O	Active-low open-drain output, asserted during overcurrent, or overtemperature conditions on channel 2
OUT2	6	6	O	Power-switch output channel 2, connected to load
OUT1	7	7	O	Power-switch output channel 1, connected to load
$\overline{\text{FLT1}}$	8	8	O	Active-low open-drain output, asserted during over-current, or overtemperature conditions on channel 1
PowerPAD™	PAD	PAD	Pwr	Internally connected to GND; used to heat-sink the part to the circuit board traces. Connect PAD to GND plane as a heatsink.

**PIN FUNCTIONS – SOIC-8 PACKAGES**

NAME	TPS2066C	TPS2062C	I/O	DESCRIPTION
GND	1	1	Pwr	Ground connection
IN	2	2	I	Input voltage and power-switch drain; connect a 0.1 $\mu$ F or greater ceramic capacitor from IN to GND close to the IC
EN1	3	-	I	Enable input channel 1, logic high turns on power switch
$\overline{\text{EN1}}$	-	3	I	Enable input channel 1, logic low turns on power switch
EN2	4	-	I	Enable input channel 2, logic high turns on power switch
$\overline{\text{EN2}}$	-	4	I	Enable input channel 2, logic low turns on power switch
$\overline{\text{FLT2}}$	5	5	O	Active-low open-drain output, asserted during overcurrent, or overtemperature conditions on channel 2
OUT2	6	6	O	Power-switch output channel 2, connected to load
OUT1	7	7	O	Power-switch output channel 1, connected to load
$\overline{\text{FLT1}}$	8	8	O	Active-low open-drain output, asserted during overcurrent, or overtemperature conditions on channel 1

**PIN FUNCTIONS – SON-10 PACKAGES**

NAME	TPS2003C	TPS2002C	I/O	DESCRIPTION
GND	1	1	Pwr	Ground connection
IN	2, 3	2, 3	I	Input voltage and power-switch drain; connect a 0.1 $\mu$ F or greater ceramic capacitor from IN to GND close to the IC
EN1	4	-	I	Enable input channel 1, logic high turns on power switch
$\overline{\text{EN1}}$	-	4	I	Enable input channel 1, logic low turns on power switch
EN2	5	-	I	Enable input channel 2, logic high turns on power switch
$\overline{\text{EN2}}$	-	5	I	Enable input channel 2, logic low turns on power switch
$\overline{\text{FLT2}}$	6	6	O	Active-low open-drain output, asserted during overcurrent, or overtemperature conditions on channel 2
NC	7	7		No connect – leave floating.
OUT2	8	8	O	Power-switch output channel 2, connect to load
OUT1	9	9	O	Power-switch output channel 1, connect to load
$\overline{\text{FLT1}}$	10	10	O	Active-low open-drain output, asserted during overcurrent, or overtemperature conditions on channel 1
PowerPAD™	PAD	PAD	Pwr	Internally connected to GND; used to heat-sink the part to the circuit board traces. Connect PAD to GND plane as a heatsink.

**PIN FUNCTIONS – SON-8 PACKAGES**

NAME	TPS2062C-2	I/O	DESCRIPTION
GND	1	Pwr	Ground connection
IN	2	I	Input voltage and power-switch drain; connect a 0.1 $\mu\text{F}$ or greater ceramic capacitor from IN to GND close to the IC
$\overline{\text{EN}}1$	3	I	Enable input channel 1, logic low turns on power switch
$\overline{\text{EN}}2$	4	I	Enable input channel 2, logic low turns on power switch
$\overline{\text{FLT}}2$	5	O	Active-low open-drain output, asserted during over-current, or over-temperature conditions on channel 2
OUT2	6	O	Power-switch output channel 2, connect to load
OUT1	7	O	Power-switch output channel 1, connect to load
$\overline{\text{FLT}}1$	8	O	Active-low open-drain output, asserted during over-current, or over-temperature conditions on channel 1
PowerPAD™	PAD	Pwr	Internally connected to GND; used to heat-sink the part to the circuit board traces. Connect PAD to GND plane as a heatsink.

**TYPICAL CHARACTERISTICS**



**Figure 10. Test Circuit for System Operation in Typical Characteristics Section**



**Figure 11. TPS2062C Turn on Delay and Rise Time With 1- $\mu\text{F}$  Load**



**Figure 12. TPS2062C Turn off Delay and Fall Time With 1- $\mu\text{F}$  Load**

TYPICAL CHARACTERISTICS (continued)

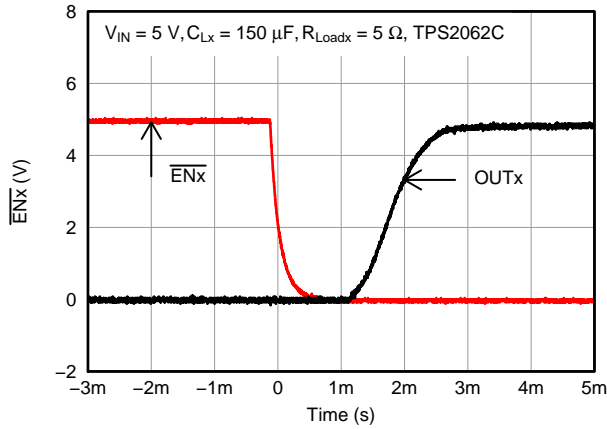

Figure 13. TPS2062C Turn on Delay and Rise Time With 150-µF Load

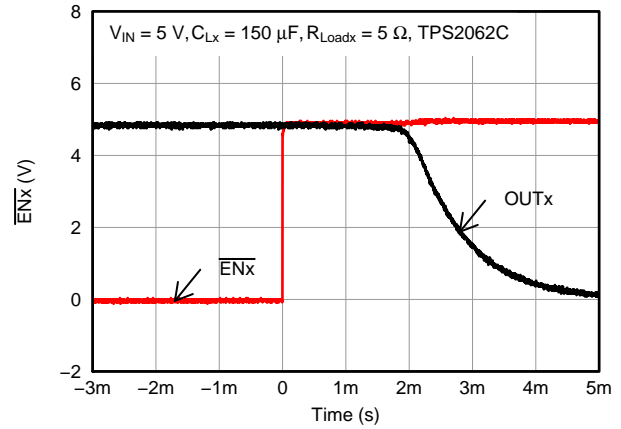

Figure 14. TPS2062C Turn off Delay and Fall Time With 150-µF Load

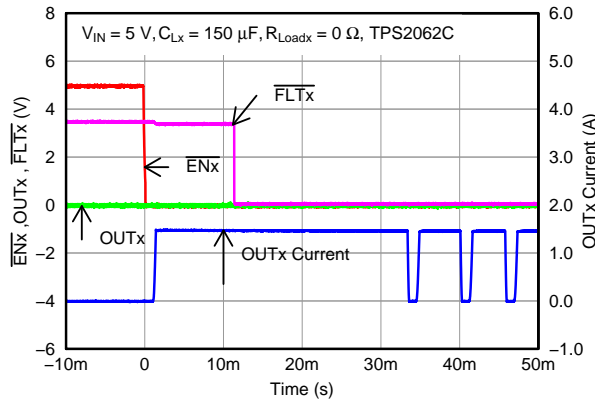

Figure 15. TPS2062C Enable Into Short



Figure 16. TPS2062C Inrush Current With Different Load Capacitance

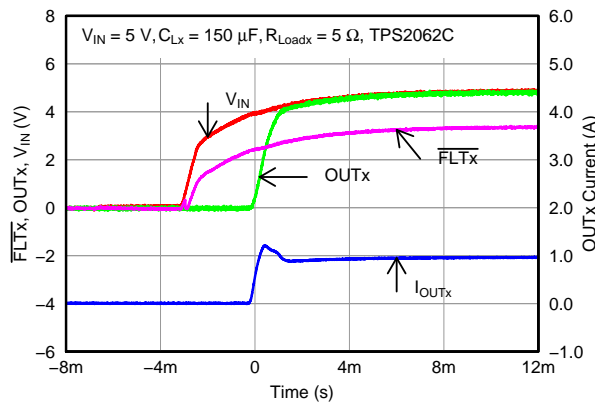

Figure 17. TPS2062C Power Up – Enabled



Figure 18. TPS2062C Power Down – Enabled

TYPICAL CHARACTERISTICS (continued)

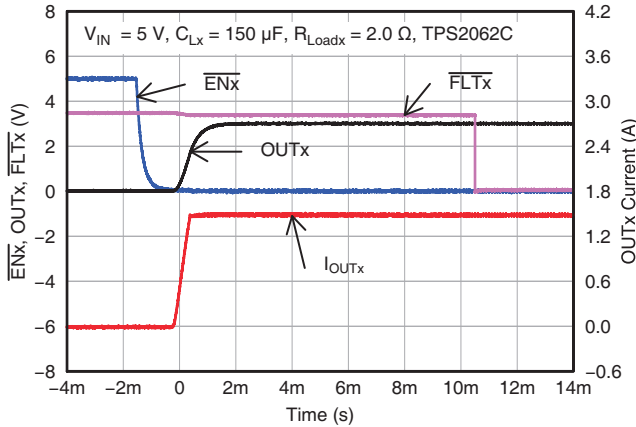

Figure 19. TPS2062C Enable With 2-Ω Load

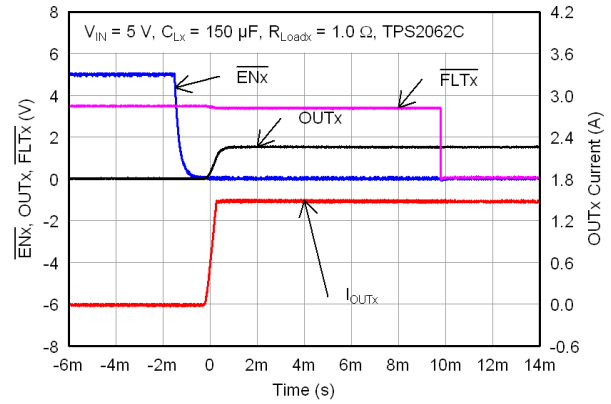

Figure 20. TPS2062C Enable With 1-Ω Load

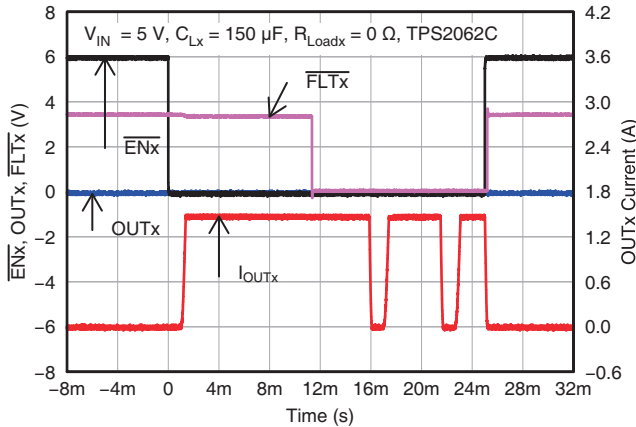

Figure 21. TPS2062C Enable/Disable into Output Short

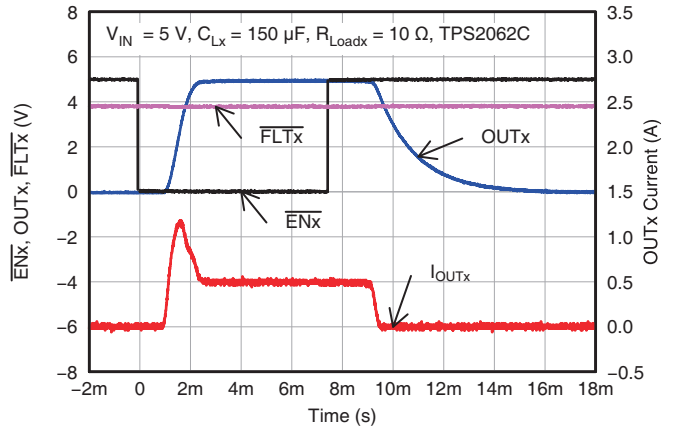

Figure 22. TPS2062C Enable/Disable into 10-Ω Load

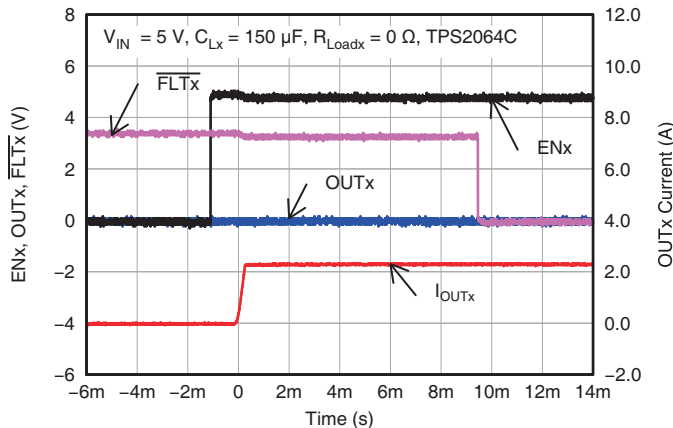

Figure 23. TPS2064C Enable into Short

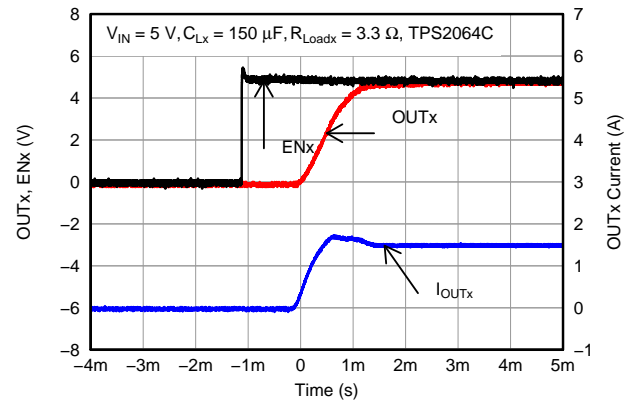

Figure 24. TPS2064C Enable into 3.3 Ω and 150-μF Load

TYPICAL CHARACTERISTICS (continued)



Figure 25. TPS2064C Short Applied



Figure 26. TPS2003C Enable into Short



Figure 27. TPS2003C Enable into 2.5 Ω and 150-μF Load

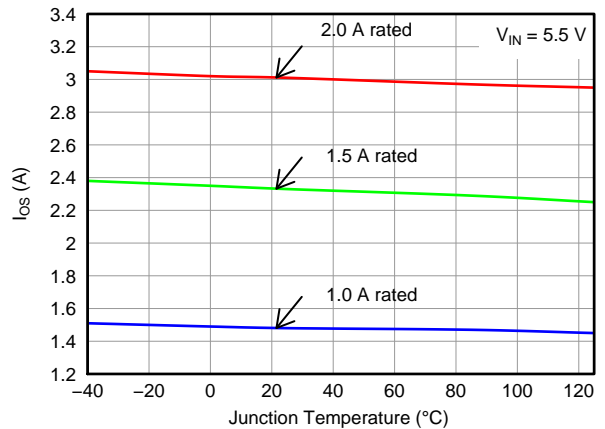

Figure 28. Current Limit ( $I_{OS}$ ) vs Temperature

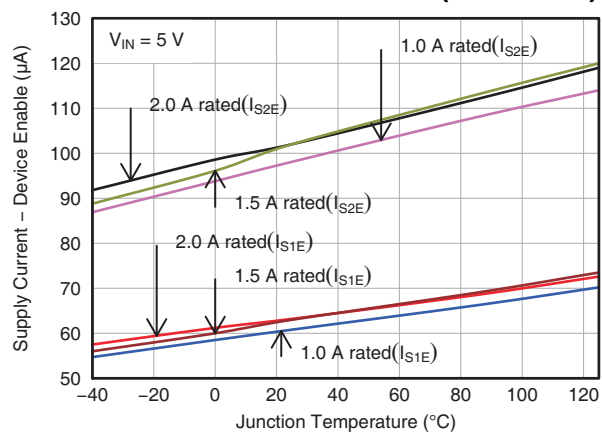

Figure 29. Input - output Resistance ( $R_{DS(ON)}$ ) vs Temperature



Figure 30. Supply Current (Device Disable) -  $I_{SD}$  vs Temperature

**TYPICAL CHARACTERISTICS (continued)**



**Figure 31. Supply Current (Enable) -  $I_{SE}$  vs Temperature**

## DETAILED DESCRIPTION

### OVERVIEW

The TPS20xxC and TPS20xxC-2 dual are current-limited, power-distribution switches providing between 0.5 A and 2 A of continuous load current in 5-V circuits. These parts use N-channel MOSFETs for low resistance, maintaining output voltage load regulation. They are designed for applications where short circuits or heavy capacitive loads are encountered. Device features include UVLO, ON/OFF control (Enable), reverse blocking when disabled, output discharge when TPS20xxC disabled, overcurrent protection, overtemperature protection, and deglitched fault reporting. They are pin for pin with existing [TI Switch Portfolio](#).

### UNDERVOLTAGE LOCKOUT (UVLO)

The undervoltage lockout (UVLO) circuit disables the power switch when the input voltage is below the UVLO threshold. Built-in hysteresis prevents unwanted on/off cycling due to input voltage drop from large current surges.  $\overline{\text{FLT}}_{\text{x}}$  is high impedance when the TPS20xxC and TPS20xxC-2 dual are in UVLO.

### ENABLE (ENx or $\overline{\text{EN}}_{\text{x}}$ )

The logic input of ENx or  $\overline{\text{EN}}_{\text{x}}$  disables all of the internal circuitry while maintaining the power switch OFF. The supply current of the device can be reduced to less than 1  $\mu\text{A}$  when both switches are disabled. A logic low input on  $\overline{\text{EN}}_{\text{x}}$  or a logic high input on ENx enables the driver, control circuits, and power switch of corresponding channel.

The ENx or  $\overline{\text{EN}}_{\text{x}}$  input voltage is compatible with both TTL and CMOS logic levels. The  $\overline{\text{FLT}}_{\text{x}}$  is immediately cleared and the output discharge circuit is enabled when the device is disabled.

### DEGLITCHED FAULT REPORTING

$\overline{\text{FLT}}_{\text{x}}$  is an open-drain output that asserts (active low) during an overcurrent or overtemperature condition on each corresponding channel. The  $\overline{\text{FLT}}_{\text{x}}$  output remains asserted until the fault condition is removed or the channel is disabled. The TPS20xxC and TPS20xxC-2 dual eliminates false  $\overline{\text{FLT}}_{\text{x}}$  reporting by using internal delay circuitry after entering or leaving an overcurrent condition. The “deglitch” time is typically 10 ms. This ensures that  $\overline{\text{FLT}}_{\text{x}}$  is not accidentally asserted under overcurrent conditions with a short time, such as starting into a heavy capacitive load. Over temperature conditions are not deglitched. The  $\overline{\text{FLT}}_{\text{x}}$  pin is high impedance when the device is disabled and in undervoltage lockout (UVLO). The fault circuits are independent so that another channel continues to operate when one channel is in a fault condition.

### OVERCURRENT PROTECTION

The TPS20xxC and TPS20xxC-2 dual responds to overloads by limiting each channel output current to the static  $I_{\text{OS}}$  levels shown in the *Electrical Characteristics* table. When an overload condition is present, the device maintains a constant current ( $I_{\text{OS}}$ ) and reduces the output voltage accordingly, with the output voltage falling to ( $I_{\text{OS}} \times R_{\text{SHORT}}$ ). Three possible overload conditions can occur. In the first condition, the output has been shorted before the device is enabled or before voltage is applied to IN. The device senses over-current and immediately switches into a constant-current output. In the second condition, a short or an overload occurs while the device is enabled. At the instant a short-circuit occurs, high currents may flow for several microseconds ( $t_{\text{IOS}}$ ) before the current-limit circuit reacts. The device operates in constant-current mode after the current-limit circuit has responded. In the third condition, the load is increased gradually beyond the recommended operating current. The current is permitted to rise until the current-limit threshold is reached. The devices are capable of delivering current up to the current-limit threshold without damage. Once the threshold is reached, the device switches into constant-current mode. For all of the above three conditions, the device may begin thermal cycling if the overcurrent condition persists.

## OVERTEMPERATURE PROTECTION

The TPS20xxC and TPS20xxC-2 dual includes per channel overtemperature protection circuitry, which activates at 135°C (min) junction temperature while in current limit. There is an overall thermal shutdown of 155°C (min) junction temperature when the TPS20xxC and TPS20xxC-2 dual are not in current limit. The device remains off until the junction temperature cools 20°C and then restarts. Thermal shutdown may occur during an overload due to the relatively large power dissipation  $[(V_{IN} - V_{OUT}) \times I_{OS}]$  driving the junction temperature up. The power switch cycles on and off until the fault is removed. This topology allows one channel to continue normal operation even if the other channel is in an over-temperature condition.

## SOFTSTART, REVERSE BLOCKING AND DISCHARGE OUTPUT

The power MOSFET driver incorporates circuitry that controls the rise and fall times of the output voltage to limit large current and voltage surges on the input supply, and provides built-in soft-start functionality.

The TPS20xxC and TPS20xxC-2 dual power switch will block current from OUT to IN when turned off by the UVLO or disabled.

The TPS20xxC dual includes an output discharge function on each channel. A 470Ω (typ.) discharge resistor will dissipate stored charge and leakage current on OUTx when the device is in UVLO or disabled. However as this circuit is biased from IN, the output discharge will not be active when IN voltage is close to 0 V.

The TPS20xxC-2 does not have this function. The output is be controlled by an external loadings when the device is in ULVO or disabled.

## APPLICATION INFORMATION

### INPUT AND OUTPUT CAPACITANCE

Input and output capacitance improves the performance of the device. For all applications, a 0.1  $\mu\text{F}$  or greater ceramic bypass capacitor between IN and GND is recommended as close to the device as possible for local noise de-coupling. The actual capacitance should be optimized for the particular application. This precaution reduces ringing on the input due to power-supply transients. Additional input capacitance may be needed on the input to reduce the overshoot voltage from exceeding the absolute maximum voltage of the device during heavy transients.

A 120  $\mu\text{F}$  minimum output capacitance is required when implementing USB standard applications. Typically this uses a 150  $\mu\text{F}$  electrolytic capacitor. If the application does not require 120  $\mu\text{F}$  of output capacitance, a minimum of 10  $\mu\text{F}$  ceramic capacitor on the output is recommended in order to reduce the transient negative voltage on OUTx pin caused by load inductance during a short circuit. The transient negative voltage should be less than 1.5 V for 10  $\mu\text{s}$ .

### POWER DISSIPATION AND JUNCTION TEMPERATURE

It is good design practice to estimate power dissipation and maximum expected junction temperature of the TPS20xxC and TPS20xxC-2 dual. The system designer can control choices of package, proximity to other power dissipating devices, and printed circuit board (PCB) design based on these calculations. These have a direct influence on maximum junction temperature. Other factors such as airflow and maximum ambient temperature are often determined by system considerations.

Addition of extra PCB copper area around these devices is recommended to reduce the thermal impedance and maintain the junction temperature as low as practical.

The following procedure requires iteration because power loss is due to the two internal MOSFETs  $2 \times I^2 \times r_{\text{DS(on)}}$ , and  $r_{\text{DS(on)}}$  is a function of the junction temperature. As an initial estimate, use the  $r_{\text{DS(on)}}$  at 125°C from the typical characteristics, and the preferred package thermal resistance for the preferred board construction from the thermal parameters section.

$$T_J = T_A + [(2 \times I_{\text{OUT}}^2 \times r_{\text{DS(on)}}) \times \theta_{\text{JA}}]$$

Where:

$I_{\text{OUT}}$  = rated OUT pin current (A)

$r_{\text{DS(on)}}$  = Power switch on-resistance at an assumed  $T_J$  ( $\Omega$ )

$T_A$  = Maximum ambient temperature ( $^{\circ}\text{C}$ )

$T_J$  = Maximum junction temperature ( $^{\circ}\text{C}$ )

$\theta_{\text{JA}}$  = Thermal resistance ( $^{\circ}\text{C}/\text{W}$ )

If the calculated  $T_J$  is substantially different from the original assumption, look up a new value of  $r_{\text{DS(on)}}$  and recalculate.

If the resulting  $T_J$  is not less than 125°C, try a PCB construction and/or package with lower  $\theta_{\text{JA}}$ .

## REVISION HISTORY

Changes from Original (October 2011) to Revision A	Page
• Changed devices TPS2062C and TPS2066C MSOP-8 package From: Preview to Active .....	1
• Changed the I <sub>OS</sub> current limit values for TPS2062C and 66C (1 A). .....	3
• Changed the I <sub>OS</sub> current limit values for TPS2062C/66C (1 A). .....	4
Changes from Revision A (March 2012) to Revision B	Page
• Changed device TPS2060C MSOP-8 package From: Preview To: Active .....	1
Changes from Revision B (March 2012) to Revision C	Page
• Changed devices TPS2062C and TPS2066C SOIC-8 package From: Preview To: Active .....	1
• Changed the TPS2062C and 66C r <sub>DS(on)</sub> D package TYP value From: 84 to 90 mΩ and added the MAX value .....	3
• Changed the TPS2062C and 66C r <sub>DS(on)</sub> D package TYP value From: 84 to 90 mΩ .....	4
Changes from Revision C (June 2012) to Revision D	Page
• Changed the Device Information table, Package Devices and Marking columns .....	2
Changes from Revision D (July 2012) to Revision E	Page
• Changed devices TPS2002C and TPS2003C SON-10 package From: Preview To: Active .....	1
• Changed the I <sub>OS</sub> current limit values for TPS2002C and 03C (2 A). .....	3
• Corrected Note 2 references in the ELECTRICAL CHARACTERISTICS table .....	4
• Changed the I <sub>OS</sub> current limit values for TPS2002C and 03C (2 A). .....	4
Changes from Revision E (August 2012) to Revision F	Page
• 将特性从 1A , 1.5A , 2A 的额定电流改为 : 0.5A , 1A , 1.5A , 2A 的额定电流 .....	1
• 将特性从 : 禁用时输出放电改为 : 所选的具有 (TPS20xxC) 和不具有 (TPS20xxC-2)输出放电的部件 .....	1
• Added DRB pin option .....	1
• Added TPS2052C, TPS2062C-2, TPS2064C-2, and TPS2066C-2 devices to <a href="#">Table 1</a> .....	1
• Added TPS2052C, TPS2062C-2, TPS2064C-2, and TPS2066C-2 devices to .....	2
• Added TPS2052C, TPS2062C-2, TPS2064C-2, and TPS2066C-2 devices to RECOMMENDED OPERATING CONDITIONS table .....	3
• Added TPS2052C and TPS2066C-2 devices to r <sub>DS(on)</sub> .....	3
• Added the TPS2052C and TPS2064C-2 devices to I <sub>OS</sub> .....	3
• Added Leakage Current .....	3
• Added TPS2052C and TPS2066C-2 devices to r <sub>DS(on)</sub> .....	4
• Added the TPS2052C and TPS2064C-2 devices to I <sub>OS</sub> .....	4
• Added Leakage Current .....	4
• Added text to the SOFTSTART, REVERSE BLOCKING AND DISCHARGE OUTPUT section .....	14
• Added last paragraph in the DISCHARGE OUTPUT section .....	14

---

**Changes from Revision F (November 2012) to Revision G****Page**

- Changed device TPS2062C-2 SON-8 packages From: Preview To: Active ..... 1
  - Changed devices TPS2066C-2, and TPS2064C-2 MSOP-8 package From: Preview To: Active ..... 1
-

**PACKAGING INFORMATION**

Orderable part number	Status (1)	Material type (2)	Package   Pins	Package qty   Carrier	RoHS (3)	Lead finish/ Ball material (4)	MSL rating/ Peak reflow (5)	Op temp (°C)	Part marking (6)
<a href="#">TPS2002CDRCR</a>	Active	Production	VSON (DRC)   10	3000   LARGE T&R	Yes	NIPDAU	Level-2-260C-1 YEAR	-40 to 125	VFEQ
TPS2002CDRCR.A	Active	Production	VSON (DRC)   10	3000   LARGE T&R	Yes	NIPDAU	Level-2-260C-1 YEAR	-40 to 125	VFEQ
TPS2002CDRCR.B	Active	Production	VSON (DRC)   10	3000   LARGE T&R	Yes	NIPDAU	Level-2-260C-1 YEAR	-40 to 125	VFEQ
<a href="#">TPS2002CDRCT</a>	Active	Production	VSON (DRC)   10	250   SMALL T&R	Yes	NIPDAU	Level-2-260C-1 YEAR	-40 to 125	VFEQ
TPS2002CDRCT.A	Active	Production	VSON (DRC)   10	250   SMALL T&R	Yes	NIPDAU	Level-2-260C-1 YEAR	-40 to 125	VFEQ
TPS2002CDRCT.B	Active	Production	VSON (DRC)   10	250   SMALL T&R	Yes	NIPDAU	Level-2-260C-1 YEAR	-40 to 125	VFEQ
TPS2002CDRCTG4	Active	Production	VSON (DRC)   10	250   SMALL T&R	Yes	NIPDAU	Level-2-260C-1 YEAR	-40 to 125	VFEQ
TPS2002CDRCTG4.A	Active	Production	VSON (DRC)   10	250   SMALL T&R	Yes	NIPDAU	Level-2-260C-1 YEAR	-40 to 125	VFEQ
TPS2002CDRCTG4.B	Active	Production	VSON (DRC)   10	250   SMALL T&R	Yes	NIPDAU	Level-2-260C-1 YEAR	-40 to 125	VFEQ
<a href="#">TPS2003CDRCR</a>	Active	Production	VSON (DRC)   10	3000   LARGE T&R	Yes	NIPDAU	Level-1-260C-UNLIM	-40 to 125	VRFQ
TPS2003CDRCR.A	Active	Production	VSON (DRC)   10	3000   LARGE T&R	Yes	NIPDAU	Level-1-260C-UNLIM	-40 to 125	VRFQ
TPS2003CDRCR.B	Active	Production	VSON (DRC)   10	3000   LARGE T&R	Yes	NIPDAU	Level-1-260C-UNLIM	-40 to 125	VRFQ
TPS2003CDRCRG4	Active	Production	VSON (DRC)   10	3000   LARGE T&R	Yes	NIPDAU	Level-1-260C-UNLIM	-40 to 125	VRFQ
TPS2003CDRCRG4.A	Active	Production	VSON (DRC)   10	3000   LARGE T&R	Yes	NIPDAU	Level-1-260C-UNLIM	-40 to 125	VRFQ
TPS2003CDRCRG4.B	Active	Production	VSON (DRC)   10	3000   LARGE T&R	Yes	NIPDAU	Level-1-260C-UNLIM	-40 to 125	VRFQ
<a href="#">TPS2003CDRCT</a>	Active	Production	VSON (DRC)   10	250   SMALL T&R	Yes	NIPDAU	Level-1-260C-UNLIM	-40 to 125	VRFQ
TPS2003CDRCT.A	Active	Production	VSON (DRC)   10	250   SMALL T&R	Yes	NIPDAU	Level-1-260C-UNLIM	-40 to 125	VRFQ
TPS2003CDRCT.B	Active	Production	VSON (DRC)   10	250   SMALL T&R	Yes	NIPDAU	Level-1-260C-UNLIM	-40 to 125	VRFQ
<a href="#">TPS2052CDGN</a>	Active	Production	HVSSOP (DGN)   8	80   TUBE	Yes	NIPDAUAG	Level-2-260C-1 YEAR	-40 to 125	PYNI
TPS2052CDGN.A	Active	Production	HVSSOP (DGN)   8	80   TUBE	Yes	NIPDAUAG	Level-2-260C-1 YEAR	-40 to 125	PYNI
TPS2052CDGN.B	Active	Production	HVSSOP (DGN)   8	80   TUBE	Yes	NIPDAUAG	Level-2-260C-1 YEAR	-40 to 125	PYNI
<a href="#">TPS2052CDGNR</a>	Active	Production	HVSSOP (DGN)   8	2500   LARGE T&R	Yes	NIPDAUAG	Level-2-260C-1 YEAR	-40 to 125	PYNI
TPS2052CDGNR.A	Active	Production	HVSSOP (DGN)   8	2500   LARGE T&R	Yes	NIPDAUAG	Level-2-260C-1 YEAR	-40 to 125	PYNI
TPS2052CDGNR.B	Active	Production	HVSSOP (DGN)   8	2500   LARGE T&R	Yes	NIPDAUAG	Level-2-260C-1 YEAR	-40 to 125	PYNI
<a href="#">TPS2060CDGN</a>	Active	Production	HVSSOP (DGN)   8	80   TUBE	Yes	NIPDAUAG	Level-1-260C-UNLIM	-40 to 125	VRAQ
TPS2060CDGN.A	Active	Production	HVSSOP (DGN)   8	80   TUBE	Yes	NIPDAUAG	Level-1-260C-UNLIM	-40 to 125	VRAQ
TPS2060CDGN.B	Active	Production	HVSSOP (DGN)   8	80   TUBE	Yes	NIPDAUAG	Level-1-260C-UNLIM	-40 to 125	VRAQ
<a href="#">TPS2060CDGNR</a>	Active	Production	HVSSOP (DGN)   8	2500   LARGE T&R	Yes	NIPDAUAG	Level-1-260C-UNLIM	-40 to 125	VRAQ
TPS2060CDGNR.A	Active	Production	HVSSOP (DGN)   8	2500   LARGE T&R	Yes	NIPDAUAG	Level-1-260C-UNLIM	-40 to 125	VRAQ

Orderable part number	Status (1)	Material type (2)	Package   Pins	Package qty   Carrier	RoHS (3)	Lead finish/ Ball material (4)	MSL rating/ Peak reflow (5)	Op temp (°C)	Part marking (6)
TPS2060CDGNR.B	Active	Production	HVSSOP (DGN)   8	2500   LARGE T&R	Yes	NIPDAUAG	Level-1-260C-UNLIM	-40 to 125	VRAQ
<a href="#">TPS2062CD</a>	Active	Production	SOIC (D)   8	75   TUBE	Yes	NIPDAU	Level-1-260C-UNLIM	-40 to 125	2062C
TPS2062CD.B	Active	Production	SOIC (D)   8	75   TUBE	Yes	NIPDAU	Level-1-260C-UNLIM	-40 to 125	2062C
<a href="#">TPS2062CDGN</a>	Active	Production	HVSSOP (DGN)   8	80   TUBE	Yes	NIPDAUAG	Level-1-260C-UNLIM	-40 to 125	VRBQ
TPS2062CDGN.A	Active	Production	HVSSOP (DGN)   8	80   TUBE	Yes	NIPDAUAG	Level-1-260C-UNLIM	-40 to 125	VRBQ
<a href="#">TPS2062CDGNR</a>	Active	Production	HVSSOP (DGN)   8	2500   LARGE T&R	Yes	NIPDAUAG	Level-1-260C-UNLIM	-40 to 125	VRBQ
TPS2062CDGNR.A	Active	Production	HVSSOP (DGN)   8	2500   LARGE T&R	Yes	NIPDAUAG	Level-1-260C-UNLIM	-40 to 125	VRBQ
<a href="#">TPS2062CDR</a>	Active	Production	SOIC (D)   8	2500   LARGE T&R	Yes	NIPDAU	Level-1-260C-UNLIM	-40 to 125	2062C
TPS2062CDR.B	Active	Production	SOIC (D)   8	2500   LARGE T&R	Yes	NIPDAU	Level-1-260C-UNLIM	-40 to 125	2062C
<a href="#">TPS2062CDRBR-2</a>	Active	Production	SON (DRB)   8	3000   LARGE T&R	Yes	NIPDAU	Level-1-260C-UNLIM	-40 to 125	PYVI
TPS2062CDRBR-2.A	Active	Production	SON (DRB)   8	3000   LARGE T&R	Yes	NIPDAU	Level-1-260C-UNLIM	-40 to 125	PYVI
<a href="#">TPS2062CDRBT-2</a>	Active	Production	SON (DRB)   8	250   SMALL T&R	Yes	NIPDAU	Level-1-260C-UNLIM	-40 to 125	PYVI
TPS2062CDRBT-2.A	Active	Production	SON (DRB)   8	250   SMALL T&R	Yes	NIPDAU	Level-1-260C-UNLIM	-40 to 125	PYVI
<a href="#">TPS2064CDGN</a>	Active	Production	HVSSOP (DGN)   8	80   TUBE	Yes	NIPDAUAG	Level-1-260C-UNLIM	-40 to 125	VRCQ
<a href="#">TPS2064CDGN-2</a>	Active	Production	HVSSOP (DGN)   8	80   TUBE	Yes	NIPDAUAG	Level-2-260C-1 YEAR	-40 to 125	PYTI
TPS2064CDGN-2.A	Active	Production	HVSSOP (DGN)   8	80   TUBE	Yes	NIPDAUAG	Level-2-260C-1 YEAR	-40 to 125	PYTI
TPS2064CDGN.A	Active	Production	HVSSOP (DGN)   8	80   TUBE	Yes	NIPDAUAG	Level-1-260C-UNLIM	-40 to 125	VRCQ
TPS2064CDGN.B	Active	Production	HVSSOP (DGN)   8	80   TUBE	Yes	NIPDAUAG	Level-1-260C-UNLIM	-40 to 125	VRCQ
<a href="#">TPS2064CDGNR</a>	Active	Production	HVSSOP (DGN)   8	2500   LARGE T&R	Yes	NIPDAUAG	Level-1-260C-UNLIM	-40 to 125	VRCQ
<a href="#">TPS2064CDGNR-2</a>	Active	Production	HVSSOP (DGN)   8	2500   LARGE T&R	Yes	NIPDAUAG	Level-2-260C-1 YEAR	-40 to 125	PYTI
TPS2064CDGNR-2.A	Active	Production	HVSSOP (DGN)   8	2500   LARGE T&R	Yes	NIPDAUAG	Level-2-260C-1 YEAR	-40 to 125	PYTI
TPS2064CDGNR.A	Active	Production	HVSSOP (DGN)   8	2500   LARGE T&R	Yes	NIPDAUAG	Level-1-260C-UNLIM	-40 to 125	VRCQ
TPS2064CDGNR.B	Active	Production	HVSSOP (DGN)   8	2500   LARGE T&R	Yes	NIPDAUAG	Level-1-260C-UNLIM	-40 to 125	VRCQ
<a href="#">TPS2065CDBVR-2</a>	Active	Production	SOT-23 (DBV)   5	3000   LARGE T&R	Yes	NIPDAU   SN	Level-2-260C-1 YEAR	-40 to 125	PYQI
TPS2065CDBVR-2.A	Active	Production	SOT-23 (DBV)   5	3000   LARGE T&R	Yes	SN	Level-2-260C-1 YEAR	-40 to 125	PYQI
<a href="#">TPS2065CDBVT-2</a>	Active	Production	SOT-23 (DBV)   5	250   SMALL T&R	Yes	NIPDAU   SN	Level-2-260C-1 YEAR	-40 to 125	PYQI
TPS2065CDBVT-2.A	Active	Production	SOT-23 (DBV)   5	250   SMALL T&R	Yes	NIPDAU	Level-2-260C-1 YEAR	-40 to 125	PYQI
<a href="#">TPS2065CDGN-2</a>	Active	Production	HVSSOP (DGN)   8	80   TUBE	Yes	NIPDAUAG	Level-2-260C-1 YEAR	-40 to 125	PYRI
TPS2065CDGN-2.A	Active	Production	HVSSOP (DGN)   8	80   TUBE	Yes	NIPDAUAG	Level-2-260C-1 YEAR	-40 to 125	PYRI
<a href="#">TPS2065CDGNR-2</a>	Active	Production	HVSSOP (DGN)   8	2500   LARGE T&R	Yes	NIPDAUAG	Level-2-260C-1 YEAR	-40 to 125	PYRI
TPS2065CDGNR-2.A	Active	Production	HVSSOP (DGN)   8	2500   LARGE T&R	Yes	NIPDAUAG	Level-2-260C-1 YEAR	-40 to 125	PYRI

Orderable part number	Status (1)	Material type (2)	Package   Pins	Package qty   Carrier	RoHS (3)	Lead finish/ Ball material (4)	MSL rating/ Peak reflow (5)	Op temp (°C)	Part marking (6)
<a href="#">TPS2066CD</a>	Active	Production	SOIC (D)   8	75   TUBE	Yes	NIPDAU	Level-1-260C-UNLIM	-40 to 125	2066C
TPS2066CD.B	Active	Production	SOIC (D)   8	75   TUBE	Yes	NIPDAU	Level-1-260C-UNLIM	-40 to 125	2066C
TPS2066CDG4	Active	Production	SOIC (D)   8	75   TUBE	Yes	NIPDAU	Level-1-260C-UNLIM	-40 to 125	2066C
TPS2066CDG4.B	Active	Production	SOIC (D)   8	75   TUBE	Yes	NIPDAU	Level-1-260C-UNLIM	-40 to 125	2066C
<a href="#">TPS2066CDGN</a>	Active	Production	HVSSOP (DGN)   8	80   TUBE	Yes	NIPDAUAG	Level-1-260C-UNLIM	-40 to 85	VRDQ
<a href="#">TPS2066CDGN-2</a>	Active	Production	HVSSOP (DGN)   8	80   TUBE	Yes	NIPDAUAG	Level-2-260C-1 YEAR	-40 to 125	PYUI
TPS2066CDGN-2.A	Active	Production	HVSSOP (DGN)   8	80   TUBE	Yes	NIPDAUAG	Level-2-260C-1 YEAR	-40 to 125	PYUI
TPS2066CDGN.A	Active	Production	HVSSOP (DGN)   8	80   TUBE	Yes	NIPDAUAG	Level-1-260C-UNLIM	-40 to 85	VRDQ
TPS2066CDGN.B	Active	Production	HVSSOP (DGN)   8	80   TUBE	Yes	NIPDAUAG	Level-1-260C-UNLIM	-40 to 85	VRDQ
<a href="#">TPS2066CDGNR</a>	Active	Production	HVSSOP (DGN)   8	2500   LARGE T&R	Yes	NIPDAUAG	Level-1-260C-UNLIM	-40 to 125	VRDQ
<a href="#">TPS2066CDGNR-2</a>	Active	Production	HVSSOP (DGN)   8	2500   LARGE T&R	Yes	NIPDAUAG	Level-2-260C-1 YEAR	-40 to 125	PYUI
TPS2066CDGNR-2.A	Active	Production	HVSSOP (DGN)   8	2500   LARGE T&R	Yes	NIPDAUAG	Level-2-260C-1 YEAR	-40 to 125	PYUI
TPS2066CDGNR.A	Active	Production	HVSSOP (DGN)   8	2500   LARGE T&R	Yes	NIPDAUAG	Level-1-260C-UNLIM	-40 to 125	VRDQ
TPS2066CDGNR.B	Active	Production	HVSSOP (DGN)   8	2500   LARGE T&R	Yes	NIPDAUAG	Level-1-260C-UNLIM	-40 to 125	VRDQ
<a href="#">TPS2066CDR</a>	Active	Production	SOIC (D)   8	2500   LARGE T&R	Yes	NIPDAU	Level-1-260C-UNLIM	-40 to 125	2066C
TPS2066CDR.B	Active	Production	SOIC (D)   8	2500   LARGE T&R	Yes	NIPDAU	Level-1-260C-UNLIM	-40 to 125	2066C

(1) **Status:** For more details on status, see our [product life cycle](#).

(2) **Material type:** When designated, preproduction parts are prototypes/experimental devices, and are not yet approved or released for full production. Testing and final process, including without limitation quality assurance, reliability performance testing, and/or process qualification, may not yet be complete, and this item is subject to further changes or possible discontinuation. If available for ordering, purchases will be subject to an additional waiver at checkout, and are intended for early internal evaluation purposes only. These items are sold without warranties of any kind.

(3) **RoHS values:** Yes, No, RoHS Exempt. See the [TI RoHS Statement](#) for additional information and value definition.

(4) **Lead finish/Ball material:** Parts may have multiple material finish options. Finish options are separated by a vertical ruled line. Lead finish/Ball material values may wrap to two lines if the finish value exceeds the maximum column width.

(5) **MSL rating/Peak reflow:** The moisture sensitivity level ratings and peak solder (reflow) temperatures. In the event that a part has multiple moisture sensitivity ratings, only the lowest level per JEDEC standards is shown. Refer to the shipping label for the actual reflow temperature that will be used to mount the part to the printed circuit board.

(6) **Part marking:** There may be an additional marking, which relates to the logo, the lot trace code information, or the environmental category of the part.

Multiple part markings will be inside parentheses. Only one part marking contained in parentheses and separated by a "-" will appear on a part. If a line is indented then it is a continuation of the previous line and the two combined represent the entire part marking for that device.

**Important Information and Disclaimer:** The information provided on this page represents TI's knowledge and belief as of the date that it is provided. TI bases its knowledge and belief on information provided by third parties, and makes no representation or warranty as to the accuracy of such information. Efforts are underway to better integrate information from third parties. TI has taken and continues to take reasonable steps to provide representative and accurate information but may not have conducted destructive testing or chemical analysis on incoming materials and chemicals. TI and TI suppliers consider certain information to be proprietary, and thus CAS numbers and other limited information may not be available for release.

In no event shall TI's liability arising out of such information exceed the total purchase price of the TI part(s) at issue in this document sold by TI to Customer on an annual basis.

**TAPE AND REEL INFORMATION**

**QUADRANT ASSIGNMENTS FOR PIN 1 ORIENTATION IN TAPE**

\*All dimensions are nominal

Device	Package Type	Package Drawing	Pins	SPQ	Reel Diameter (mm)	Reel Width W1 (mm)	A0 (mm)	B0 (mm)	K0 (mm)	P1 (mm)	W (mm)	Pin1 Quadrant
TPS2002CDRCR	VSON	DRC	10	3000	330.0	12.4	3.3	3.3	1.1	8.0	12.0	Q2
TPS2002CDRCT	VSON	DRC	10	250	180.0	12.4	3.3	3.3	1.1	8.0	12.0	Q2
TPS2002CDRCTG4	VSON	DRC	10	250	180.0	12.4	3.3	3.3	1.1	8.0	12.0	Q2
TPS2003CDRCR	VSON	DRC	10	3000	330.0	12.4	3.3	3.3	1.1	8.0	12.0	Q2
TPS2003CDRCRG4	VSON	DRC	10	3000	330.0	12.4	3.3	3.3	1.1	8.0	12.0	Q2
TPS2003CDRCT	VSON	DRC	10	250	180.0	12.4	3.3	3.3	1.1	8.0	12.0	Q2
TPS2052CDGNR	HVSSOP	DGN	8	2500	330.0	12.4	5.3	3.4	1.4	8.0	12.0	Q1
TPS2060CDGNR	HVSSOP	DGN	8	2500	330.0	12.4	5.3	3.4	1.4	8.0	12.0	Q1
TPS2062CDGNR	HVSSOP	DGN	8	2500	330.0	12.4	5.3	3.4	1.4	8.0	12.0	Q1
TPS2062CDR	SOIC	D	8	2500	330.0	12.4	6.4	5.2	2.1	8.0	12.0	Q1
TPS2062CDRBR-2	SON	DRB	8	3000	330.0	12.4	3.3	3.3	1.1	8.0	12.0	Q2
TPS2062CDRBT-2	SON	DRB	8	250	180.0	12.4	3.3	3.3	1.1	8.0	12.0	Q2
TPS2064CDGNR	HVSSOP	DGN	8	2500	330.0	12.4	5.3	3.4	1.4	8.0	12.0	Q1
TPS2064CDGNR-2	HVSSOP	DGN	8	2500	330.0	12.4	5.3	3.4	1.4	8.0	12.0	Q1
TPS2065CDBVR-2	SOT-23	DBV	5	3000	180.0	8.4	3.2	3.2	1.4	4.0	8.0	Q3
TPS2065CDBVR-2	SOT-23	DBV	5	3000	180.0	8.4	3.2	3.2	1.4	4.0	8.0	Q3

Device	Package Type	Package Drawing	Pins	SPQ	Reel Diameter (mm)	Reel Width W1 (mm)	A0 (mm)	B0 (mm)	K0 (mm)	P1 (mm)	W (mm)	Pin1 Quadrant
TPS2065CDBVT-2	SOT-23	DBV	5	250	180.0	8.4	3.2	3.2	1.4	4.0	8.0	Q3
TPS2065CDBVT-2	SOT-23	DBV	5	250	178.0	8.4	3.23	3.17	1.37	4.0	8.0	Q3
TPS2065CDGNR-2	HVSSOP	DGN	8	2500	330.0	12.4	5.3	3.4	1.4	8.0	12.0	Q1
TPS2066CDGNR	HVSSOP	DGN	8	2500	330.0	12.4	5.3	3.4	1.4	8.0	12.0	Q1
TPS2066CDGNR-2	HVSSOP	DGN	8	2500	330.0	12.4	5.3	3.4	1.4	8.0	12.0	Q1
TPS2066CDR	SOIC	D	8	2500	330.0	12.4	6.4	5.2	2.1	8.0	12.0	Q1

**TAPE AND REEL BOX DIMENSIONS**

\*All dimensions are nominal

Device	Package Type	Package Drawing	Pins	SPQ	Length (mm)	Width (mm)	Height (mm)
TPS2002CDRCR	VSON	DRC	10	3000	346.0	346.0	33.0
TPS2002CDRCT	VSON	DRC	10	250	210.0	185.0	35.0
TPS2002CDRCTG4	VSON	DRC	10	250	210.0	185.0	35.0
TPS2003CDRCR	VSON	DRC	10	3000	346.0	346.0	33.0
TPS2003CDRCRG4	VSON	DRC	10	3000	346.0	346.0	33.0
TPS2003CDRCT	VSON	DRC	10	250	182.0	182.0	20.0
TPS2052CDGNR	HVSSOP	DGN	8	2500	366.0	364.0	50.0
TPS2060CDGNR	HVSSOP	DGN	8	2500	364.0	364.0	27.0
TPS2062CDGNR	HVSSOP	DGN	8	2500	364.0	364.0	27.0
TPS2062CDR	SOIC	D	8	2500	340.5	338.1	20.6
TPS2062CDRBR-2	SON	DRB	8	3000	335.0	335.0	25.0
TPS2062CDRBT-2	SON	DRB	8	250	182.0	182.0	20.0
TPS2064CDGNR	HVSSOP	DGN	8	2500	364.0	364.0	27.0
TPS2064CDGNR-2	HVSSOP	DGN	8	2500	366.0	364.0	50.0
TPS2065CDBVR-2	SOT-23	DBV	5	3000	210.0	185.0	35.0
TPS2065CDBVR-2	SOT-23	DBV	5	3000	210.0	185.0	35.0
TPS2065CDBVT-2	SOT-23	DBV	5	250	210.0	185.0	35.0
TPS2065CDBVT-2	SOT-23	DBV	5	250	180.0	180.0	18.0

---

Device	Package Type	Package Drawing	Pins	SPQ	Length (mm)	Width (mm)	Height (mm)
TPS2065CDGNR-2	HVSSOP	DGN	8	2500	366.0	364.0	50.0
TPS2066CDGNR	HVSSOP	DGN	8	2500	364.0	364.0	27.0
TPS2066CDGNR-2	HVSSOP	DGN	8	2500	366.0	364.0	50.0
TPS2066CDR	SOIC	D	8	2500	353.0	353.0	32.0

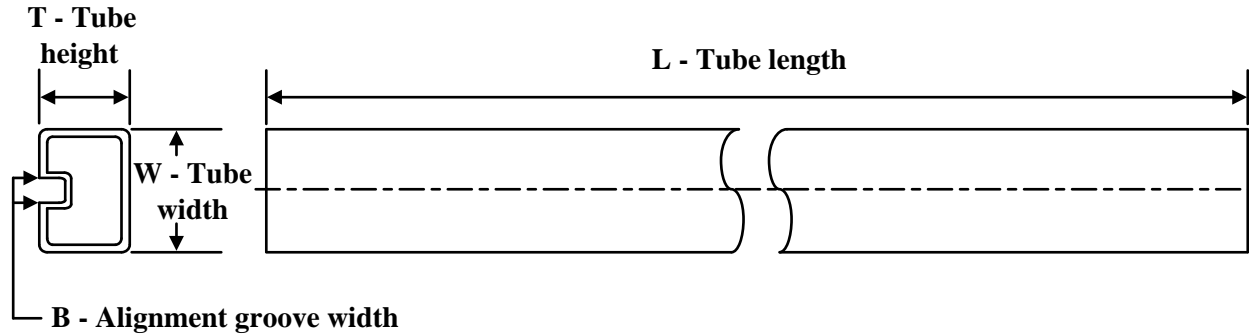
**TUBE**

\*All dimensions are nominal

Device	Package Name	Package Type	Pins	SPQ	L (mm)	W (mm)	T (µm)	B (mm)
TPS2052CDGN	DGN	HVSSOP	8	80	330	6.55	500	2.88
TPS2052CDGN.A	DGN	HVSSOP	8	80	330	6.55	500	2.88
TPS2052CDGN.B	DGN	HVSSOP	8	80	330	6.55	500	2.88
TPS2060CDGN	DGN	HVSSOP	8	80	330	6.55	500	2.88
TPS2060CDGN.A	DGN	HVSSOP	8	80	330	6.55	500	2.88
TPS2060CDGN.B	DGN	HVSSOP	8	80	330	6.55	500	2.88
TPS2062CD	D	SOIC	8	75	507	8	3940	4.32
TPS2062CD.B	D	SOIC	8	75	507	8	3940	4.32
TPS2062CDGN	DGN	HVSSOP	8	80	330	6.55	500	2.88
TPS2062CDGN.A	DGN	HVSSOP	8	80	330	6.55	500	2.88
TPS2064CDGN	DGN	HVSSOP	8	80	330	6.55	500	2.88
TPS2064CDGN-2	DGN	HVSSOP	8	80	330	6.55	500	2.88
TPS2064CDGN-2.A	DGN	HVSSOP	8	80	330	6.55	500	2.88
TPS2064CDGN.A	DGN	HVSSOP	8	80	330	6.55	500	2.88
TPS2064CDGN.B	DGN	HVSSOP	8	80	330	6.55	500	2.88
TPS2065CDGN-2	DGN	HVSSOP	8	80	330	6.55	500	2.88
TPS2065CDGN-2.A	DGN	HVSSOP	8	80	330	6.55	500	2.88
TPS2066CD	D	SOIC	8	75	507	8	3940	4.32
TPS2066CD.B	D	SOIC	8	75	507	8	3940	4.32
TPS2066CDG4	D	SOIC	8	75	507	8	3940	4.32
TPS2066CDG4.B	D	SOIC	8	75	507	8	3940	4.32
TPS2066CDGN	DGN	HVSSOP	8	80	330	6.55	500	2.88
TPS2066CDGN-2	DGN	HVSSOP	8	80	330	6.55	500	2.88
TPS2066CDGN-2.A	DGN	HVSSOP	8	80	330	6.55	500	2.88
TPS2066CDGN.A	DGN	HVSSOP	8	80	330	6.55	500	2.88
TPS2066CDGN.B	DGN	HVSSOP	8	80	330	6.55	500	2.88



# EXAMPLE BOARD LAYOUT

DBV0005A

SOT-23 - 1.45 mm max height

SMALL OUTLINE TRANSISTOR



LAND PATTERN EXAMPLE  
EXPOSED METAL SHOWN  
SCALE:15X



SOLDER MASK DETAILS

4214839/K 08/2024

NOTES: (continued)

- 6. Publication IPC-7351 may have alternate designs.
- 7. Solder mask tolerances between and around signal pads can vary based on board fabrication site.

# EXAMPLE STENCIL DESIGN

DBV0005A

SOT-23 - 1.45 mm max height

SMALL OUTLINE TRANSISTOR



SOLDER PASTE EXAMPLE  
BASED ON 0.125 mm THICK STENCIL  
SCALE:15X

4214839/K 08/2024

NOTES: (continued)

8. Laser cutting apertures with trapezoidal walls and rounded corners may offer better paste release. IPC-7525 may have alternate design recommendations.
9. Board assembly site may have different recommendations for stencil design.

**DRB 8**

**GENERIC PACKAGE VIEW**

**VSON - 1 mm max height**

PLASTIC SMALL OUTLINE - NO LEAD



Images above are just a representation of the package family, actual package may vary.  
Refer to the product data sheet for package details.

4203482/L

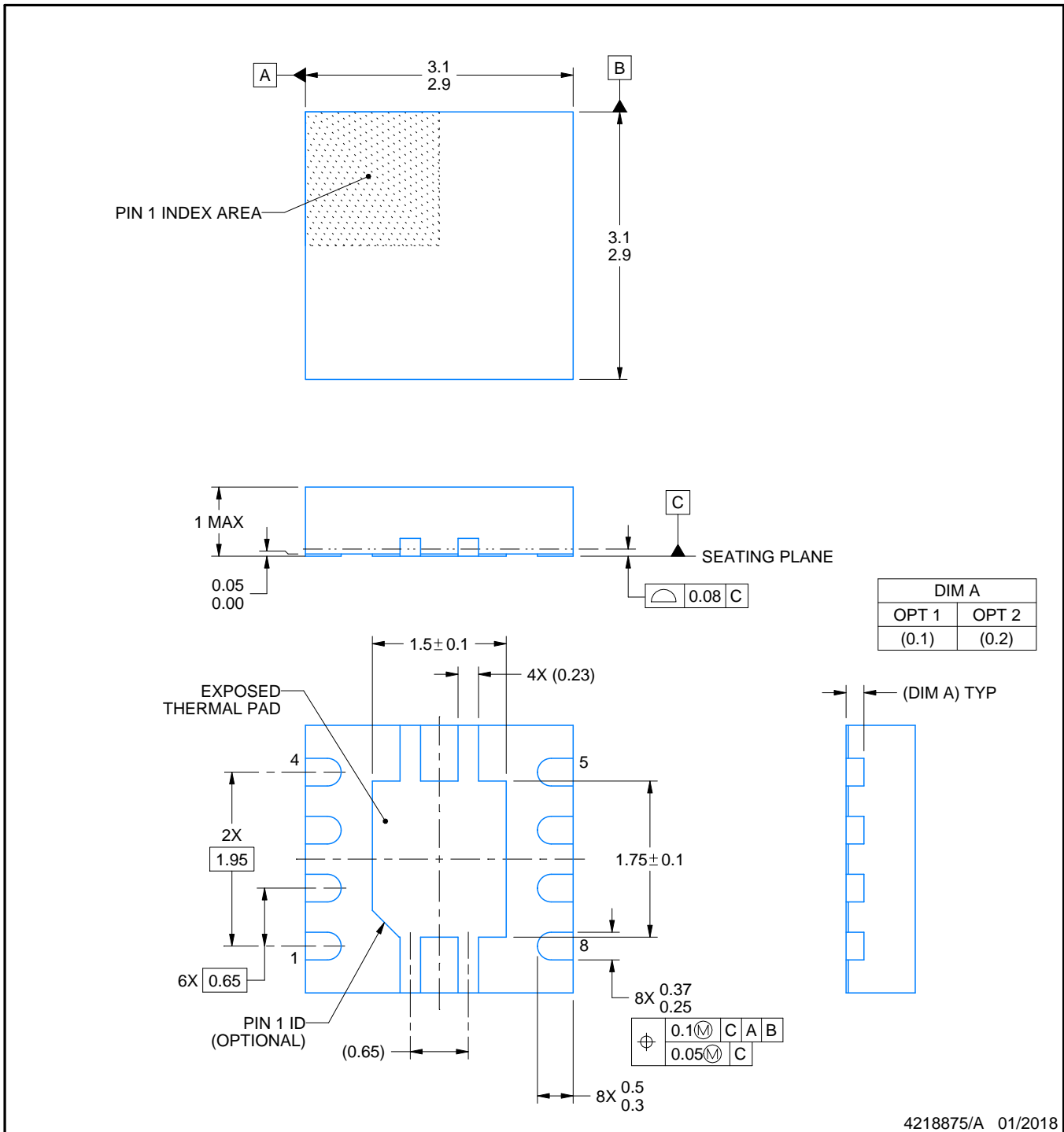

4218875/A 01/2018

NOTES:

1. All linear dimensions are in millimeters. Any dimensions in parenthesis are for reference only. Dimensioning and tolerancing per ASME Y14.5M.
2. This drawing is subject to change without notice.
3. The package thermal pad must be soldered to the printed circuit board for thermal and mechanical performance.

# EXAMPLE BOARD LAYOUT

DRB0008A

VSON - 1 mm max height

PLASTIC SMALL OUTLINE - NO LEAD

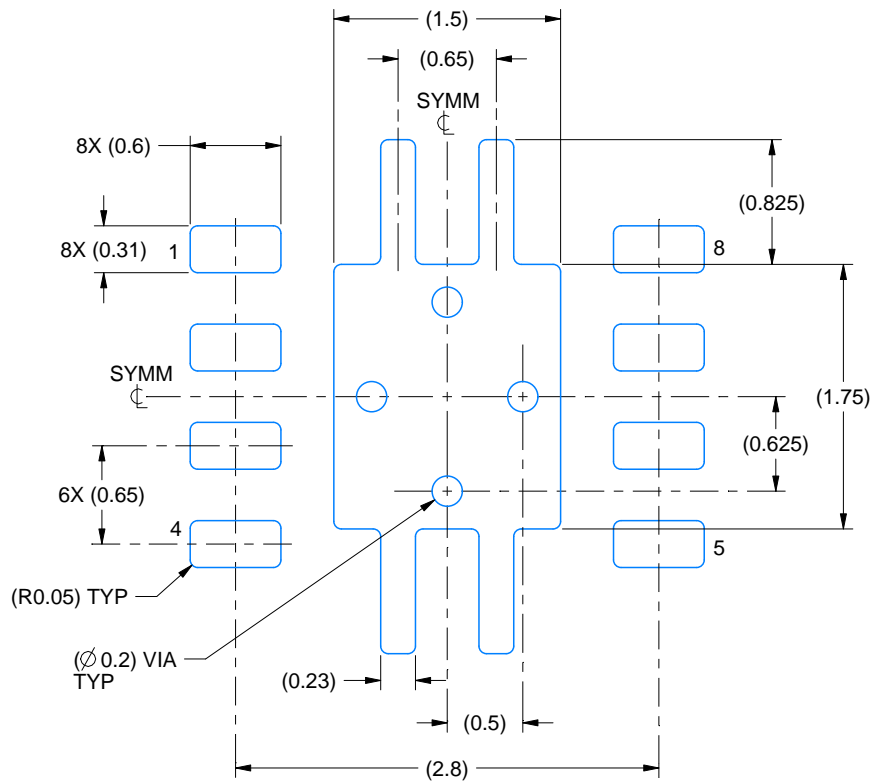

LAND PATTERN EXAMPLE  
EXPOSED METAL SHOWN  
SCALE:20X

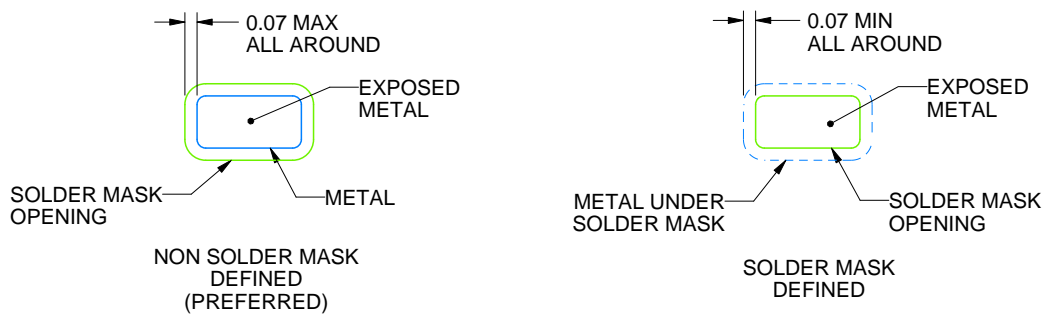

SOLDER MASK DETAILS

4218875/A 01/2018

NOTES: (continued)

4. This package is designed to be soldered to a thermal pad on the board. For more information, see Texas Instruments literature number SLUA271 ([www.ti.com/lit/slua271](http://www.ti.com/lit/slua271)).
5. Vias are optional depending on application, refer to device data sheet. If any vias are implemented, refer to their locations shown on this view. It is recommended that vias under paste be filled, plugged or tented.

# EXAMPLE STENCIL DESIGN

DRB0008A

VSON - 1 mm max height

PLASTIC SMALL OUTLINE - NO LEAD



SOLDER PASTE EXAMPLE  
BASED ON 0.125 mm THICK STENCIL

EXPOSED PAD  
84% PRINTED SOLDER COVERAGE BY AREA  
SCALE:25X

4218875/A 01/2018

NOTES: (continued)

6. Laser cutting apertures with trapezoidal walls and rounded corners may offer better paste release. IPC-7525 may have alternate design recommendations.

## GENERIC PACKAGE VIEW

**DGN 8**

**PowerPAD™ HVSSOP - 1.1 mm max height**

3 x 3, 0.65 mm pitch

SMALL OUTLINE PACKAGE

This image is a representation of the package family, actual package may vary.  
Refer to the product data sheet for package details.

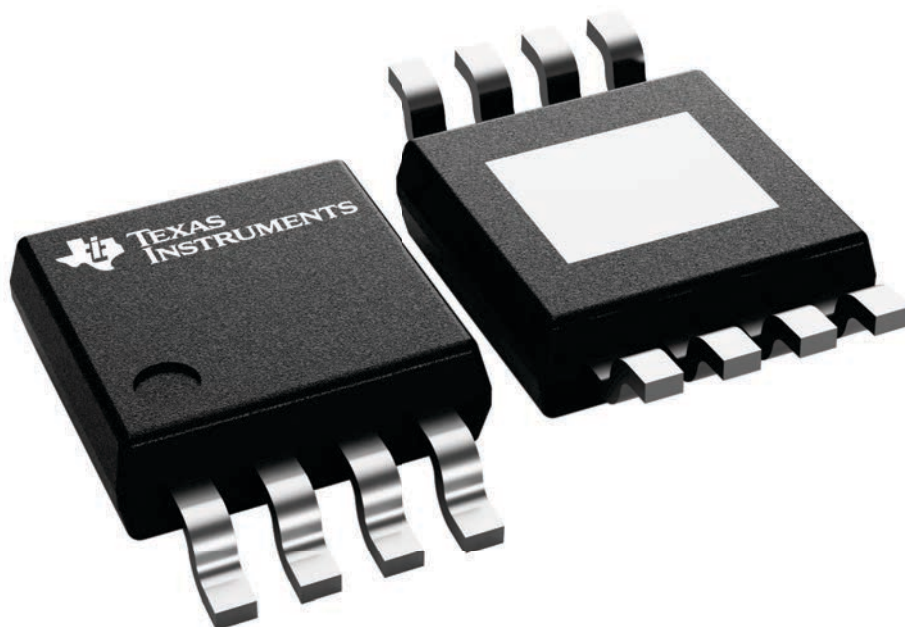

4225482/B

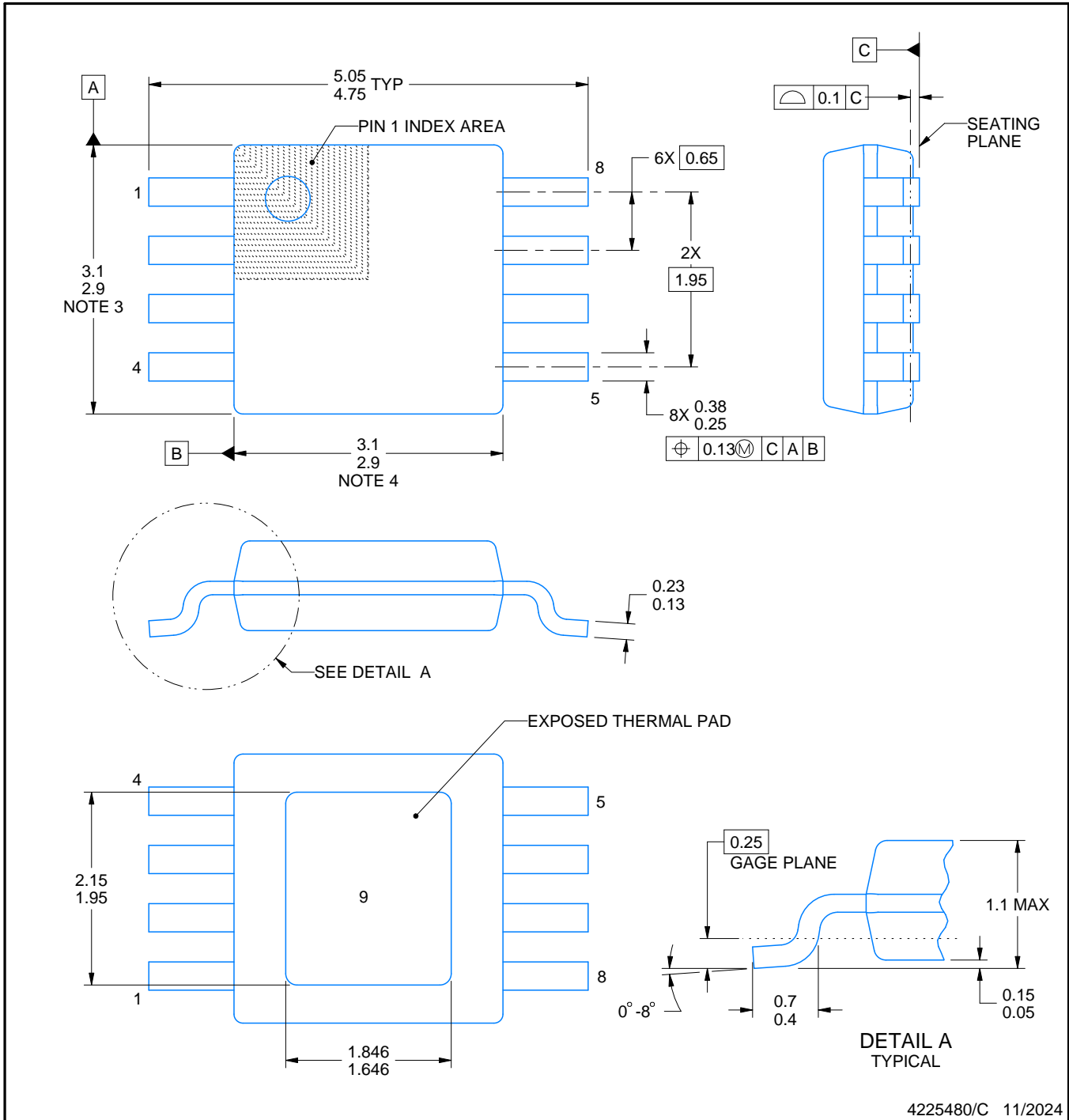
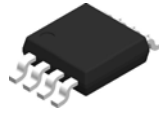

4225480/C 11/2024

PowerPAD is a trademark of Texas Instruments.

NOTES:

1. All linear dimensions are in millimeters. Any dimensions in parenthesis are for reference only. Dimensioning and tolerancing per ASME Y14.5M.
2. This drawing is subject to change without notice.
3. This dimension does not include mold flash, protrusions, or gate burrs. Mold flash, protrusions, or gate burrs shall not exceed 0.15 mm per side.
4. This dimension does not include interlead flash. Interlead flash shall not exceed 0.25 mm per side.
5. Reference JEDEC registration MO-187.

# EXAMPLE BOARD LAYOUT

DGN0008G

PowerPAD™ HVSSOP - 1.1 mm max height

SMALL OUTLINE PACKAGE



LAND PATTERN EXAMPLE  
EXPOSED METAL SHOWN  
SCALE: 15X

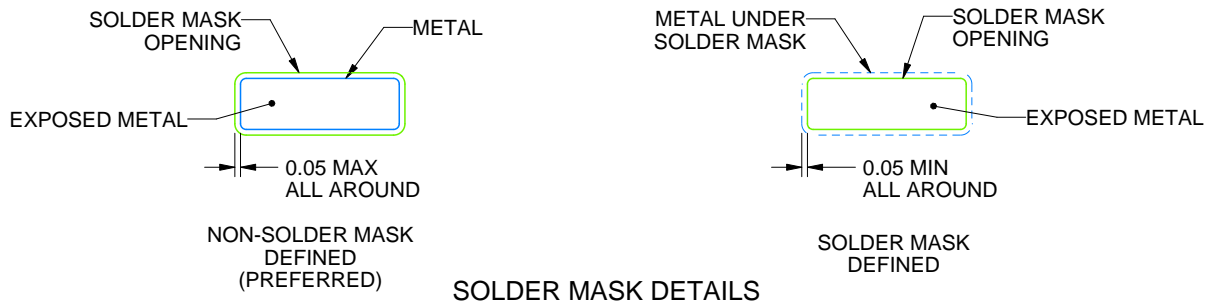

4225480/C 11/2024

NOTES: (continued)

6. Publication IPC-7351 may have alternate designs.
7. Solder mask tolerances between and around signal pads can vary based on board fabrication site.
8. Vias are optional depending on application, refer to device data sheet. If any vias are implemented, refer to their locations shown on this view. It is recommended that vias under paste be filled, plugged or tented.
9. Size of metal pad may vary due to creepage requirement.

# EXAMPLE STENCIL DESIGN

DGN0008G

PowerPAD™ HVSSOP - 1.1 mm max height

SMALL OUTLINE PACKAGE



**SOLDER PASTE EXAMPLE**  
EXPOSED PAD 9:  
100% PRINTED SOLDER COVERAGE BY AREA  
SCALE: 15X

STENCIL THICKNESS	SOLDER STENCIL OPENING
0.1	1.76 X 2.11
0.125	1.57 X 1.89 (SHOWN)
0.15	1.43 X 1.73
0.175	1.33 X 1.60

4225480/C 11/2024

NOTES: (continued)

10. Laser cutting apertures with trapezoidal walls and rounded corners may offer better paste release. IPC-7525 may have alternate design recommendations.
11. Board assembly site may have different recommendations for stencil design.



D0008A

# PACKAGE OUTLINE

SOIC - 1.75 mm max height

SMALL OUTLINE INTEGRATED CIRCUIT



4214825/C 02/2019

## NOTES:

- Linear dimensions are in inches [millimeters]. Dimensions in parenthesis are for reference only. Controlling dimensions are in inches. Dimensioning and tolerancing per ASME Y14.5M.
- This drawing is subject to change without notice.
- This dimension does not include mold flash, protrusions, or gate burrs. Mold flash, protrusions, or gate burrs shall not exceed  $.006$  [0.15] per side.
- This dimension does not include interlead flash.
- Reference JEDEC registration MS-012, variation AA.

# EXAMPLE BOARD LAYOUT

D0008A

SOIC - 1.75 mm max height

SMALL OUTLINE INTEGRATED CIRCUIT



LAND PATTERN EXAMPLE  
 EXPOSED METAL SHOWN  
 SCALE:8X



SOLDER MASK DETAILS

4214825/C 02/2019

NOTES: (continued)

- 6. Publication IPC-7351 may have alternate designs.
- 7. Solder mask tolerances between and around signal pads can vary based on board fabrication site.

# EXAMPLE STENCIL DESIGN

D0008A

SOIC - 1.75 mm max height

SMALL OUTLINE INTEGRATED CIRCUIT



SOLDER PASTE EXAMPLE  
BASED ON .005 INCH [0.125 MM] THICK STENCIL  
SCALE:8X

4214825/C 02/2019

NOTES: (continued)

8. Laser cutting apertures with trapezoidal walls and rounded corners may offer better paste release. IPC-7525 may have alternate design recommendations.
9. Board assembly site may have different recommendations for stencil design.

## GENERIC PACKAGE VIEW

**DRC 10**

**VSON - 1 mm max height**

3 x 3, 0.5 mm pitch

PLASTIC SMALL OUTLINE - NO LEAD

This image is a representation of the package family, actual package may vary.  
Refer to the product data sheet for package details.

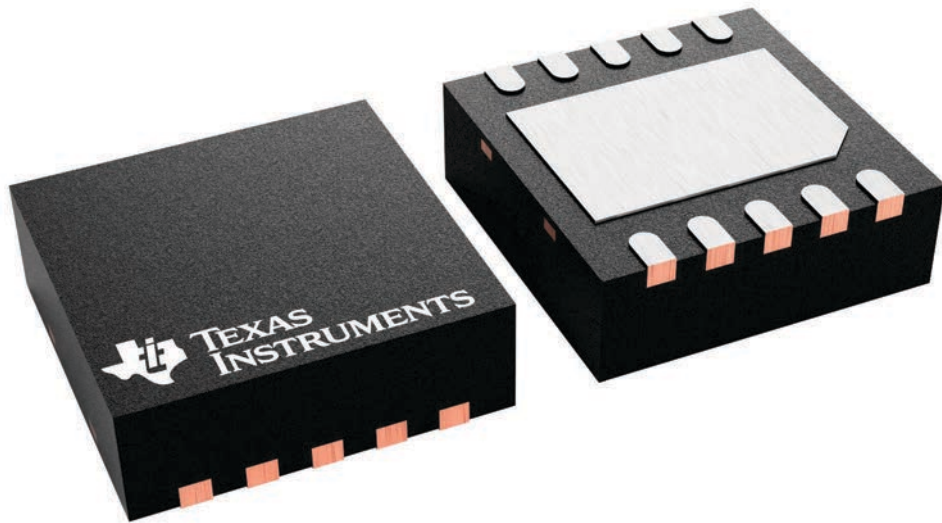

4226193/A



# EXAMPLE BOARD LAYOUT

DRC0010J

VSON - 1 mm max height

PLASTIC SMALL OUTLINE - NO LEAD



LAND PATTERN EXAMPLE  
EXPOSED METAL SHOWN  
SCALE:20X



SOLDER MASK DETAILS

4218878/B 07/2018

NOTES: (continued)

4. This package is designed to be soldered to a thermal pad on the board. For more information, see Texas Instruments literature number SLUA271 ([www.ti.com/lit/sluea271](http://www.ti.com/lit/sluea271)).
5. Vias are optional depending on application, refer to device data sheet. If any vias are implemented, refer to their locations shown on this view. It is recommended that vias under paste be filled, plugged or tented.

# EXAMPLE STENCIL DESIGN

DRC0010J

VSON - 1 mm max height

PLASTIC SMALL OUTLINE - NO LEAD

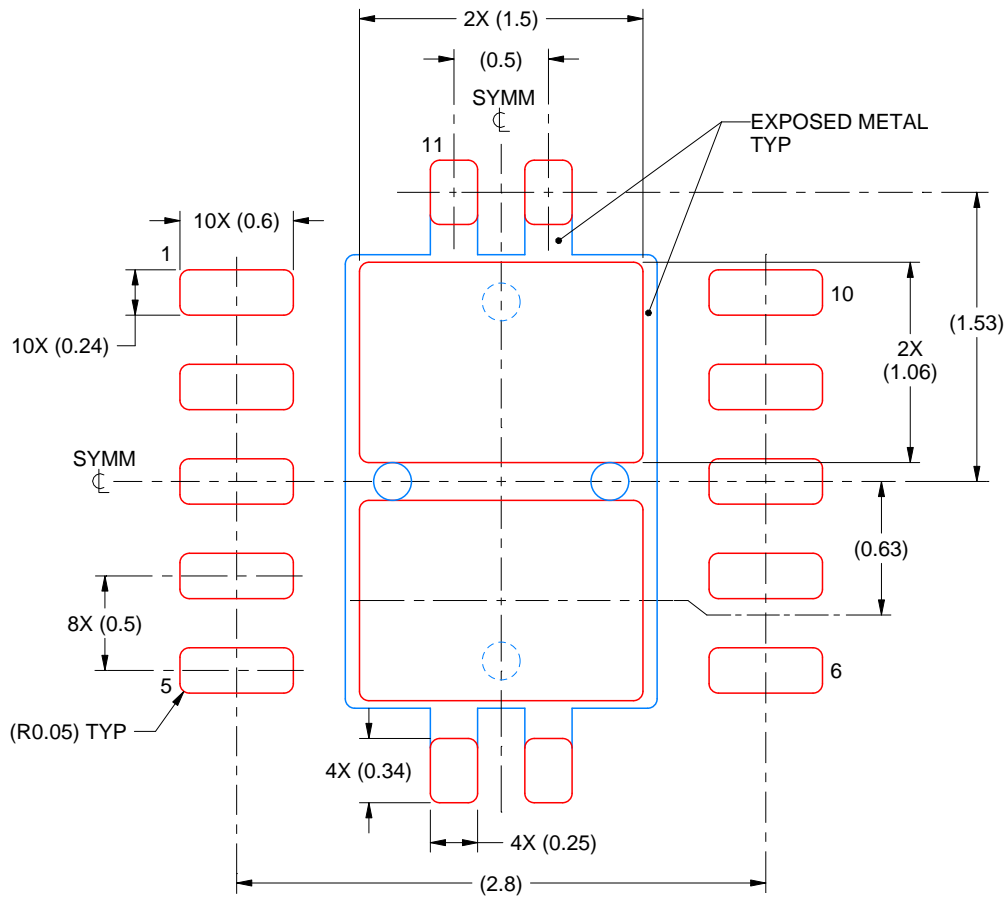

SOLDER PASTE EXAMPLE  
BASED ON 0.125 mm THICK STENCIL

EXPOSED PAD 11:  
80% PRINTED SOLDER COVERAGE BY AREA  
SCALE:25X

4218878/B 07/2018

NOTES: (continued)

6. Laser cutting apertures with trapezoidal walls and rounded corners may offer better paste release. IPC-7525 may have alternate design recommendations.

## 重要通知和免责声明

TI“按原样”提供技术和可靠性数据（包括数据表）、设计资源（包括参考设计）、应用或其他设计建议、网络工具、安全信息和其他资源，不保证没有瑕疵且不做任何明示或暗示的担保，包括但不限于对适销性、与某特定用途的适用性或不侵犯任何第三方知识产权的暗示担保。

这些资源可供使用 TI 产品进行设计的熟练开发人员使用。您将自行承担以下全部责任：(1) 针对您的应用选择合适的 TI 产品，(2) 设计、验证并测试您的应用，(3) 确保您的应用满足相应标准以及任何其他安全、安保法规或其他要求。

这些资源如有变更，恕不另行通知。TI 授权您仅可将这些资源用于研发本资源所述的 TI 产品的相关应用。严禁以其他方式对这些资源进行复制或展示。您无权使用任何其他 TI 知识产权或任何第三方知识产权。对于因您对这些资源的使用而对 TI 及其代表造成的任何索赔、损害、成本、损失和债务，您将全额赔偿，TI 对此概不负责。

TI 提供的产品受 [TI 销售条款](#)、[TI 通用质量指南](#) 或 [ti.com](#) 上其他适用条款或 TI 产品随附的其他适用条款的约束。TI 提供这些资源并不会扩展或以其他方式更改 TI 针对 TI 产品发布的适用的担保或担保免责声明。除非德州仪器 (TI) 明确将某产品指定为定制产品或客户特定产品，否则其产品均为按确定价格收入目录的标准通用器件。

TI 反对并拒绝您可能提出的任何其他或不同的条款。

版权所有 © 2026，德州仪器 (TI) 公司

最后更新日期：2025 年 10 月